



EGO LV1

USER MANUAL

# **WARNING**

## **ADHERE STRICTLY TO THESE AND ALL OTHER SAFETY INSTRUCTIONS AND GUIDELINES!**

01. PLEASE READ AND UNDERSTAND ALL INSTRUCTION MANUALS BEFORE USE.
02. The Eclipse Ego LV1 is not a toy. PAINTBALL SAFETY RULES MUST BE FOLLOWED AT ALL TIMES.
03. Careless or improper use, including failure to follow instructions and warnings within this User Manual and attached to the Ego LV1 could cause death or serious injury.
04. Do not remove or deface any warnings attached to the Ego LV1.
05. Paintball industry standard eye/face/ear and head protection designed specifically to stop paintballs and meeting ASTM standard F1776 (USA) or CE standard (Europe) must be worn by the user and any person within range. Proper protection must be worn during assembly, cleaning and maintenance.
06. Hearing protection should be worn.
07. Never shoot at a person who is not wearing proper protection.
08. Never look directly into the barrel of the marker. Accidental discharge into the eyes may cause permanent injury or death. Never look into the barrel or breech area of the Ego LV1 whilst the marker is switched on and able to fire.
09. Keep the Ego LV1 switched off until ready to shoot.
10. Treat every marker as if it is loaded and ready to fire.
11. The electronic on/off is the markers safety, always switch off the marker when not in use.
12. Always fit a barrel-blocking device to the Ego LV1 when not in use.
13. Always remove all paintballs from the Ego LV1 when not in use on the field of play.
14. Never point the Ego LV1 at anything you do not intend to shoot.
15. Do not shoot at persons within close range.
16. Do not field strip or remove any parts while the marker is pressurised.
17. Do not pressurise the Ego LV1 without all the components of the marker correctly installed, as high-pressure gas may be emitted.
18. Do not fire the Ego LV1 without the bolt correctly installed.
19. Never put your finger or any foreign objects into the paintball feed tube of the Ego LV1.
20. Never allow pressurised gas to come into contact with any part of your body.
21. Always remove the first stage regulator and relieve all residual gas pressure from the Ego LV1 before disassembly.
22. Always remove the first stage regulator and relieve all residual gas pressure from the Ego LV1 for transport and storage.
23. Always follow guidelines given with your first stage regulator for safe transportation and storage.

# **WARNING**

## **ADHERE STRICTLY TO THESE AND ALL OTHER SAFETY INSTRUCTIONS AND GUIDELINES!**

24. Always store the Ego LV1 in a secure place.
25. Persons under 18 years of age must have adult supervision when using or handling the Ego LV1.
26. Observe all local and national laws, regulations and guidelines.
27. Use only professional paintball fields where codes of safety are strictly enforced.
28. Use compressed air/nitrogen only. DO NOT use any other compressed gas or pressurised liquid including CO<sub>2</sub>.
29. Always follow instructions, warnings and guidelines given with any first stage regulator you use with the Ego LV1.
30. Use 0.68 inch calibre paintballs only.
31. Always measure your marker's velocity before playing paintball, using a suitable chronograph.
32. Never shoot at velocities in excess of 300 feet (91.44 meters) per second, or at velocities greater than local or national laws allow.
33. Any installations, modifications or repairs should be carried out by a qualified individual at a licensed and insured paintball facility.



This Users Manual is in English. It contains important safety guidelines and instructions. Should you be unsure at any stage, or unable to understand the contents of this manual you must seek expert advice.



LE MODE D'EMPLOI EST EN ANGLAIS. Il contient des instructions et mesures de sécurité importantes. En cas de doute, ou s'il vous est impossible de comprendre le contenu du mode d'emploi, demandez conseil à un expert.



ESTE MANUAL DE USUARIOS (OPERARIOS) USARIOS ESTÁ EN INGLÉS. Contiene importantes normas de seguridad e instrucciones. Si no está seguro de algún punto o no entiende los contenidos de este manual debe consultar con un experto.



DIESE BEDIENUNGS - UND BENUTZERANLEITUNG IST IN ENGLISCH. Sie enthält wichtige Sicherheitsrichtlinien und -bestimmungen. Sollten Sie sich in irgendeiner Weise unsicher sein, oder den Inhalte dies Hefes nicht verstehen, lassen Sie sich bitte von einen Experten beraten.

**THIS USER MANUAL MUST ACCOMPANY THE PRODUCT IN THE EVENT OF RESALE OR NEW OWNERSHIP. SHOULD YOU BE UNSURE AT ANY STAGE YOU MUST SEEK EXPERT ADVICE (SEE SERVICE CENTRES PAGE 68).**

## 6 USING THE EGO LV1

Details on setting up the Ego LV1 and information on the user interface. This section is essential reading for everyone.

- 6 Factory Set-up Guide
- 7 Installing a 9V Battery
- 8 Switching On the Ego LV1
- Switching Off the Ego LV1
- Firing the Ego LV1
- 9 Using the Break Beam Sensor System
- 10 The Ego LV1 Navigation Console
- 11 Installing a Barrel
- 12 Trigger Adjustment
- 14 Attaching a Loader
- 15 The Gas Through Pipe
- 16 Installing a Preset Air System
- 18 Velocity Adjustment
- Low Pressure Regulator Adjustment
- 19 Solenoid Adjustment
- 20 Unloading the Ego LV1
- 21 Storage and Transportation
- 22 The User Interface
- The Run Screen Layout
- 23 The BBSS Indicator
- The AUX Out Indicator
- 24 The Sound Indicator
- The Trigger Detection Indicator
- 25 The Lock Indicator
- The Battery Level Indicator
- The Game Timer
- The Shot Counter
- 26 The Actual Rate Of Fire
- The Peak Rate Of Fire
- The Menu System

## 27 ADVANCED SET-UP

In depth information on setting up the Ego LV1.

- 27 Accessing the Menu System
- Moving Around the Menus
- Altering Parameters
- 28 The Menu System
- 29 PRESET - The Preset Menu
- LOAD - The Load Preset Parameter
- SAVE - The Save Preset Parameter
- 30 FIRE MODE - The Fire Mode Parameter
- ROF CAP - The Rate of Fire Cap Parameter

- BS ON ROF - The Maximum Rate of Fire Parameter
- BS OFF ROF - Rate of Fire with BBSS Off Parameter
- 31 RAMP SETUP - The Ramp Set-up Menu
- TYPE - The Ramp Type Parameter
- RATE - The Linear Ramp Rate Parameter
- 32 SEMI SHOTS - The Ramp Start Parameter
- KICK IN - The Ramp Kick-In Parameter
- SUSTAIN - The Sustain Rate Parameter
- RESTART - The Ramp Restart Parameter
- 33 TIMING - The Timing Menu
- DWELL - The Dwell Parameter
- FSD COMP - The First Shot Drop-off Compensation Parameter
- FSD DLY - The First Shot Drop-off Delay Parameter
- 34 FILTER - The Filter Menu
- DEBOUNCE - The Debounce Parameter
- EMPTY - The Breech Empty Time Parameter
- FULL - The Breech Full Time Parameter
- 35 PULL TM - The Trigger Pull Time Parameter
- RELEASE TM - The Trigger Release Time Parameter
- PULL PT - The Trigger Pull Point Parameter
- RELEASE PT - The Trigger Release Point Parameter
- 36 Basic Trigger Filter Set-up
- Advanced Trigger Filter Set-up
- HARDWARE - The Hardware Menu
- 37 TRIGGER - The Trigger Parameter
- SOLENOID - The Solenoid Power Parameter
- SOUND - The Sound Parameter
- TONES - The Tones Parameter
- 38 BACKLIGHT - The Backlight Parameter
- RED LEVEL - The Backlight Red Level Parameter
- GRN LEVEL - The Backlight Green Level Parameter
- BLU LEVEL - The Backlight Blue Level Parameter
- 39 CONTRAST - The LCD Contrast Level Parameter
- AUX OUT - The AUX Out Parameter
- DBL CLICK - The Double Clicking Parameter
- AUTO OFF - The Auto Off Parameter
- 40 TRAINING - The Training Parameter
- SHOT COUNT - The Shot Count Menu
- GAUGE - The Gauge Parameter
- GAUGE MAX - The Gauge Max Parameter
- 41 GAME TIMER - The Game Timer Menu
- GAME - The Game Timer Parameter
- ALARM - The Alarm Parameter
- START - The Start Parameter

## **42 MAINTENANCE**

A guide to cleaning and performing routine maintenance on specific areas of the Ego LV1.

- 42 The Break Beam Sensor System
- 44 The SL4 Inline Regulator Assembly
- 46 Advanced Inline Regulator Maintenance
- 47 The Cure5 Bolt Assembly
- 48 The Zick3 Rammer Assembly
- 50 The Low Pressure Regulator Assembly
- 52 Removing the Frame  
Attaching the Frame
- 53 The Cam-Lever Assembly
- 54 The Trigger Assembly
- 55 Replacing a Damaged Valve Assembly
- 59 The Solenoid Manifold
- 61 The Solenoid Valve
- 62 The Push On Purge System

## **64 FAULT FINDING**

Information on how to resolve any problems that might arise with your Ego LV1.

## **68 SERVICE CENTRES**

Information on the location of your nearest Eclipse Service Centre.

## **69 TECHNICAL RESOURCES**

Illustrated diagrams and component lists for key areas of the Ego LV1.

- 69 Operational Overview
- 70 Ego LV1 Parts List
- 72 Eclipse Shaft4 Barrel
- 73 SL4 Inline Regulator Assembly  
Low Pressure Regulator Assembly
- 74 Cure5 Bolt Assembly  
Zick3 Rammer Assembly
- 75 Ego LV1 Solenoid Assembly
- 76 Push On Purge System (POPS) Assembly
- 77 Trigger Assembly  
Clamping Feed Neck Assembly
- 78 Ego LV1 Printed Circuit Board
- 79 Common Screw Size Chart
- 80 Common O-ring Size Chart

## **81 MENU TREE**

A quick reference guide to the user interface.

## **85 ECLIPSE E-PORTAL**

Information on the Eclipse E-Portal upgrade for Ego LV1.

## **86 INDEX**

Ego LV1 Manual Index

## **WARRANTY CARD**

Tear-out product registration card to be completed and returned. Alternatively register online at [www.planeteclipse.com](http://www.planeteclipse.com)

## FACTORY SET-UP GUIDE

### ⚠ WARNING ⚠

DE-GAS YOUR MARKER, DISCHARGING ANY STORED GAS IN A SAFE DIRECTION, AND REMOVE THE BARREL, LOADER, AIR SYSTEM AND ANY PAINTBALLS TO MAKE THE MARKER EASIER AND SAFER TO WORK ON.

Before using the Ego LV1 it is important to make sure the SL4 inline regulator, low pressure regulator, solenoid flow restrictors (SFR) and all electronically controlled parameters are set correctly. All of these can have a negative effect on the performance of the marker if set incorrectly.

The steps below will restore the Ego LV1 settings to the factory settings. These settings will give the Ego LV1 a more balanced performance, ideal for the average user.

#### Inline Regulator Output Pressure

Check the inline regulator adjuster screw is set to 3 turns clockwise from its maximum out position (SEE FIGURE 1A). This will ensure the SL4 inline regulator is set to an output pressure that will not damage the Ego LV1 when supplied with compressed air/nitrogen (see page 18 for more information on SL4 inline regulator adjustment).

#### LPR Output Pressure

Insert a 1/8" hex key into the LPR adjuster screw (SEE FIGURE 1B). Gently screw the adjuster clockwise until a small amount of resistance is met. Now screw the adjuster counter-clockwise 1 turn. This is the factory LPR setting, see page 18 for more information on LPR adjustment.

#### Solenoid Flow Restrictor Settings

Check that the SFRs (SEE FIGURE 1C) are set to the following levels; return restrictor Ⓐ to level 5, forward restrictor Ⓑ to level 7. To access the SFRs, unscrew and peel away the right side of the grips. See page 19 for more information on the solenoid flow restrictors.

#### Electronically Controlled Parameters

Load the FACTORY preset (SEE FIGURE 1D) stored on the Ego LV1 circuit board. This preset will restore all the electronic parameters to their default settings. See page 29 on loading the FACTORY preset.

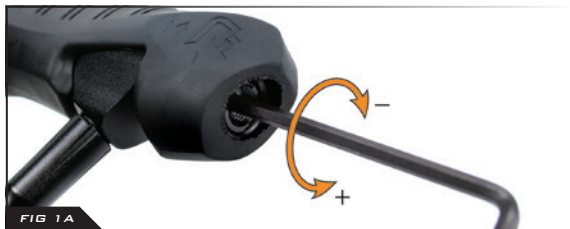

FIG 1A

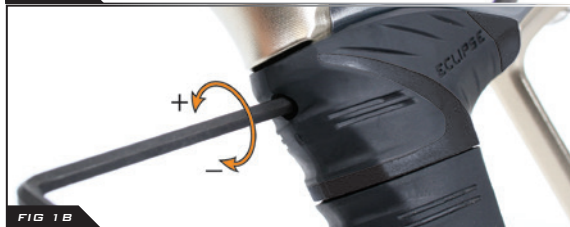

FIG 1B

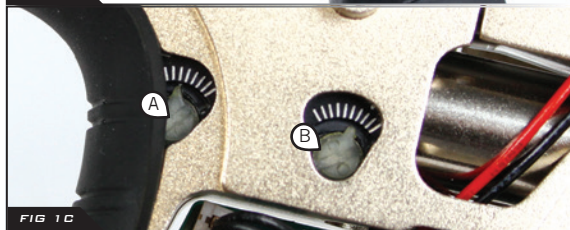

FIG 1C



FIG 1D

## INSTALLING A 9V BATTERY

Ensure that the Ego LV1 is switched off. Lay the marker on a flat surface in front of you with the feed tube furthest away and with the barrel pointing to the right.

Use a 5/64" (2mm) hex key to remove the two countersunk screws that hold the rubber grip onto the frame (SEE FIGURE 2A). Peel the grip to the right to expose the circuit board within the frame.

Remove the fitted battery by sliding your thumb or finger into the recess below the battery and levering the battery out of the frame (SEE FIGURE 2B).

DO NOT pull on the top of the battery to remove it as this can cause the battery terminals to bend and will result in a poor electrical connection.

Fit a 9-volt alkaline battery (type PP3, 6LR61 or MN1604) into the recess with the battery terminals away from you. The positive terminal should be on the right hand side, nearest to the front side of the frame (SEE FIGURE 2C). Planet Eclipse recommends using a branded high quality alkaline 9V battery. Budget and rechargeable batteries may cause performance issues.

Ensure that all of the wires are within the recess of the frame and away from the trigger, micro-switch and OPTO sensors so as not to interfere with their operation. Replace the rubber grip and screw in the two countersunk screws.

DO NOT OVER-TIGHTEN THE SCREWS.



FIG 2A





FIG 2B







FIG 2C

## SWITCHING ON THE EGO LV1

To switch on the Ego LV1 press the  button twice in quick succession, referred to elsewhere in this manual as 'double-clicking'. The Ego LV1 can also be switched on by pushing and holding the  button (SEE FIGURE 3A).<sup>1</sup>

## SWITCHING OFF THE EGO LV1

Press and hold the  button (SEE FIGURE 3A) until the display shows TURN OFF. Release the  button and re-press it to turn off the Ego LV1. Alternatively double click the  button to enter the menu tree then press  to turn off the Ego LV1.<sup>1</sup>

## FIRING THE EGO LV1

Pull the trigger (LABELLED  IN FIGURE 3B) to fire the Ego LV1. The entire firing sequence is controlled electronically by the Ego LV1 circuit board, enabling any user to easily achieve high rates of fire.

<sup>1</sup>The double clicking feature is user selectable, factory default is set to on. It can be turned off using the Double Click parameter in the Hardware menu (see page 39).



FIG 3A







FIG 3B





## USING THE BREAK BEAM SENSOR SYSTEM

The Break Beam Sensor System, referred to elsewhere in this manual as 'BBSS' is used to detect when a paintball is ready to be fired from the Ego LV1. If no paintball is ready then the BBSS will inhibit the Ego LV1 from firing. This prevents the Ego LV1 from "chopping" paintballs that are not fully loaded into the marker.<sup>1</sup>

To switch off the BBSS, press and hold the  button for 0.5 seconds (SEE FIGURE 4A). The BBSS indicator on the top right of the LCD will change from  (enabled) to  (disabled).

To switch the BBSS back on, press and hold the  button for 0.5 second. The indicator will change back to .

When the BBSS is enabled, the indicator will change depending upon whether the system has detected a ball or not. When no ball has been detected the indicator will look like this . When a ball has been detected the icon changes to look like this .

Additional features of the Ego LV1's Break Beam Sensor System are covered in full on page 23 of this operators manual.













FIG 4A

<sup>1</sup>When the Ego LV1 is turned on, the Break Beam Sensor System is automatically enabled.

## THE EGO LV1 NAVIGATION CONSOLE

At the rear of the Ego LV1 grip frame you will find the navigation console (SEE FIGURE 5A) which is used for:

- > Turning the Ego LV1 on and off using the  button.
- > Scrolling through menus with the  and  buttons.
- > Selecting parameters to edit using the  button.
- > Editing parameters using the  and  buttons.
- > Turning the Ego LV1 BBSS on and off using the  button (push and hold).
- > Resetting recorded values using the  button (push and hold).
- > Controlling the game timer with the  button (quick push and release).
- > Scrolling through the various run screens using the  Button (quick push and release).



PREVIOUS /  
RAISE



SELECT



NEXT / LOWER



FIG 5A

### WARNING

THE BACKLIGHT ON THE LCD DISPLAY TURNS OFF AFTER A PERIOD OF TIME. WHEN THIS HAPPENS THE MARKER IS STILL ON AND ABLE TO FIRE.

TO ADJUST THE LCD BACKLIGHT SEE PAGES 38-39

## INSTALLING A BARREL

### ⚠ WARNING ⚠

**MAKE SURE THE MARKER IS TURNED OFF AND THAT NO PAINTBALLS ARE IN THE MARKER OR LOADER BEFORE INSTALLING A BARREL.**

Every Ego LV1 comes complete with an Eclipse Shaft4 barrel (see page 72). The bore size of the Shaft4 barrel back is engraved on the barrel back just in front of the body threads.

To install the Shaft4 barrel, firstly screw the barrel tip and barrel back sections together. The threads on the Shaft4 barrel tip are REVERSE THREADED. To screw the two sections together, with the barrel pointing away from you, turn the barrel tip in a clockwise direction (SEE FIGURE 6A).

While pointing the Ego LV1 marker in a safe direction, insert the assembled Shaft4 barrel into the front of the Ego LV1 body and screw the Shaft4 barrel into the Ego LV1 (in a counter-clockwise direction). Continue to screw the Shaft4 barrel into the Ego LV1 body until the barrel becomes snug in the body (SEE FIGURE 6B). **DO NOT** over tighten the barrel.

Install a barrel blocking device over the barrel such as the Eclipse barrel sock supplied with the Ego LV1<sup>1</sup> (SEE FIGURE 6C). You have now installed the barrel.

<sup>1</sup>Instruction on using the Eclipse Barrel Sock can be found on the Eclipse Barrel Sock warning label.

The Eclipse Barrel Sock that comes with the Ego LV1 may differ from that pictured in this manual.

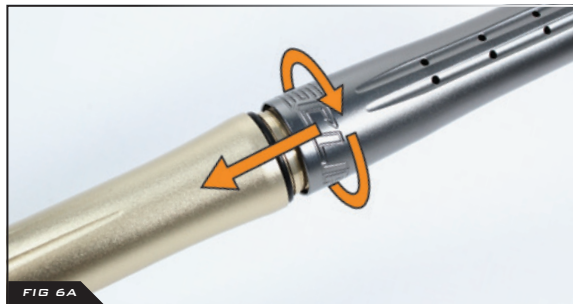

FIG 6A



FIG 6B



FIG 6C

## TRIGGER ADJUSTMENT

The Ego LV1 provides the user with the option to use either a micro-switch or an OPTO sensor (default OPTO) as the means for detecting trigger pulls. Before you begin to adjust and set your trigger, you must first select the method of trigger detection that you wish to use by entering the main menu and making your selection from the hardware menu (see page 37).

There are five adjustment points on the trigger – the front stop screw, the rear stop screw, the magnet return strength screw, the micro-switch activation screw and the spring return strength screw.

Figure 7A Key

- Ⓐ - Trigger leaf spring
- Ⓑ - Spring return strength screw
- Ⓒ - Trigger pin retaining screw
- Ⓓ - Front stop screw
- Ⓔ - Magnet return strength screw
- Ⓕ - Micro-switch activation screw
- Ⓖ - Rear stop screw
- Ⓗ - OPTO sensor activation prong

As standard each Ego LV1 comes with a factory set trigger travel of approximately 2mm in total length; one millimeter of travel before the firing point and one millimeter of travel after the firing point, and the trigger detection method set to OPTO.

The front stop screw is used to set the amount of trigger travel prior to the marker firing. Turn this screw clockwise to reduce the amount of travel. Do not turn the screw too far or the trigger will be pushed past the firing point and the marker will not work. Turn this screw counter-clockwise to increase the amount of trigger travel (SEE FIGURE 7B).

The rear stop screw is used to set the amount of travel after the marker has fired. Turn this screw clockwise to reduce the amount of travel. Do not turn the screw too far or the trigger will be prevented from reaching its firing point and the marker will not work. Turn this screw counter-clockwise to increase the amount of travel (SEE FIGURE 7C).

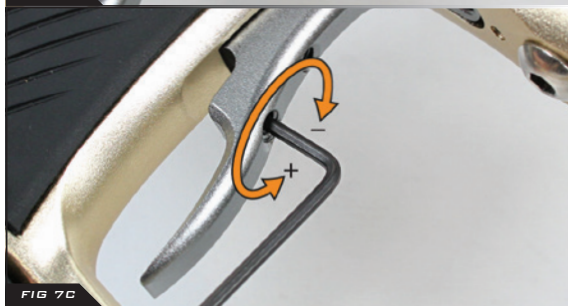
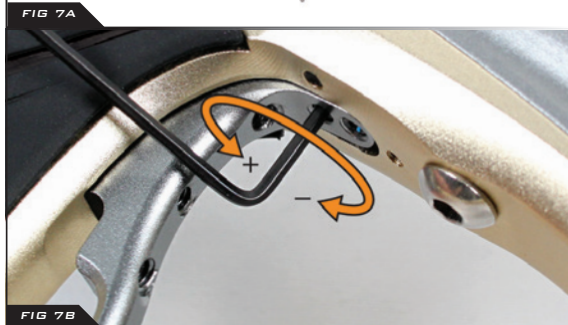
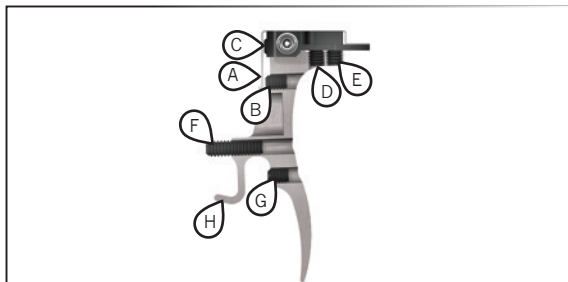







## CONTINUED

The magnet return strength screw is used to adjust the amount of force with which the trigger is returned to its rest position by the magnet. Turn the screw clockwise to increase the amount of force. Do not turn the screw too far or it will negate the position of the front stop screw. Turn the screw counter-clockwise to reduce the amount of force. Do not turn the screw too far or there may not be enough force to return the trigger (SEE FIGURE 7D).

The micro-switch activation screw is used to adjust the point in the trigger pull at which the micro-switch is activated (only if the Trigger parameter on page 37 is set to 'SWITCH'). Turn the screw clockwise to decrease the amount of trigger travel to the activation point. Turn the screw counter-clockwise to increase the amount of trigger travel to the activation point (SEE FIGURE 7E). Do not set the micro-switch activation screw too far out when using the OPTO sensors, as the screw can stop against the micro-switch before the trigger prong enters the OPTO sensors.

The spring return strength screw is used to adjust the spring strength that returns the trigger to its resting position. Turn the screw clockwise to increase the amount of spring return strength in the trigger pull. Turn this screw counter-clockwise to reduce the amount of spring return strength in the trigger pull. Do not turn the screw too far counter-clockwise or there will not be enough force to return the trigger consistently (SEE FIGURE 7F).

When setting the trigger it is important to ensure that the electronic trigger detection is working correctly. When the trigger is fully depressed the Trigger Detection Indicator (TDI) should point upwards   . When the trigger is fully released the TDI should point downwards   . For more information, see understanding the Trigger Detection Indicator (TDI) on page 24 and the Filter menu on pages 34-35.

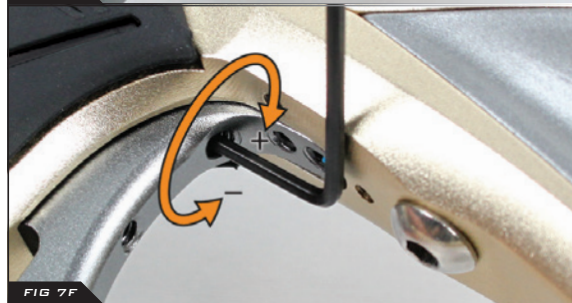
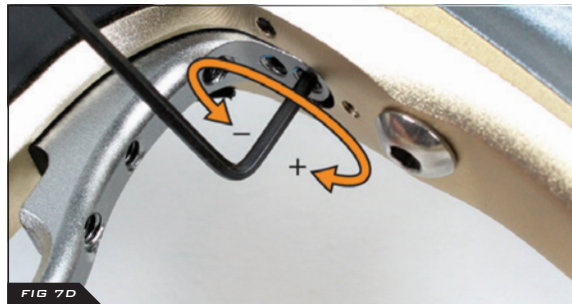

## ATTACHING A LOADER

### ⚠ WARNING ⚠

**DO NOT OVER TIGHTEN THE CLAMPING FEED TUBE AS THIS MAY DAMAGE THE LOADER OR FEED TUBE ITSELF.**

Using a 5/32" hex key or your fingers, turn the sprocket screw of the clamping feed tube counter-clockwise (SEE FIGURE 8A).

Release the clamping lever on the feed tube (SEE FIGURE 8B) and test to see if your loader can easily be pushed into the top of the feed tube. If the loader cannot easily be pushed into the feed tube, loosen the sprocket screw of the clamping feed tube a little more by turning it counter-clockwise using a 5/32" hex key or your fingers (SEE FIGURE 8A).

When you have managed to push your loader into the clamping feed tube, close the clamp to secure it firmly in place (SEE FIGURE 8C). If the loader is loose then you will need to release the clamp, tighten the sprocket screw slightly by turning it clockwise with a 5/32" hex key or your fingers and close the clamp. Repeat this process as necessary to secure your loader in place.

You have now attached a loader to your Ego LV1. Once you have filled your loader and air tank you will then be ready to begin using your Ego LV1.



## THE GAS THROUGH PIPE

### ⚠ WARNING ⚠

**IF THE GAS PIPE ASSEMBLY IS NOT CORRECTLY INSTALLED HIGH PRESSURE GAS WILL BE EMITTED.**

THERE IS NO NEED TO UNSCREW OR REMOVE THE GAS PIPE ASSEMBLY DURING DAY TO DAY USAGE OF THE MARKER.

Compressed gas is transferred from the frame to the inline regulator via gas pipe assembly (SEE FIGURE 9A), comprising of a gas pipe section (A) and pipe nut section (B). It is essential that this gas pipe assembly is correctly installed before the marker is supplied with compressed gas.

IF THE PIPE IS NOT CORRECTLY INSTALLED HIGH PRESSURE GAS WILL BE EMITTED.

Before installing the gas pipe assembly, firstly inspect the o-rings on the pipe for any debris or damage (LABELLED C FIGURE 9A). Cleaning or replacing as necessary.

Also inspect the receiver holes in the frame (SEE FIGURE 9B) and SL4 inline regulator (SEE FIGURE 9C) for any debris or dirt, cleaning as necessary.

Screw the pipe section into the nut section fully before attempting to install the gas pipe assembly in the marker (SEE FIGURE 9D).

Insert the o-ring end of the pipe nut section into the SL4 regulator swivel (SEE FIGURE 9E).

Rotate the swivel and gas pipe assembly to align the gas pipe section with the gas port in the frame.

Holding the pipe nut section in place inside the SL4 regulator swivel, screw the gas pipe section clockwise to extend it into the frame (SEE FIGURE 9F).

If the gas pipe assembly can slide backwards and forwards, then the pipe is not fully installed and needs to be extended further.

THE GAS PIPE ONLY NEEDS TO BE REMOVED FOR MAINTENANCE PROCEDURES THAT REQUIRE REMOVAL OF THE SL4 INLINE REGULATOR OR THE FRAME ASSEMBLY.

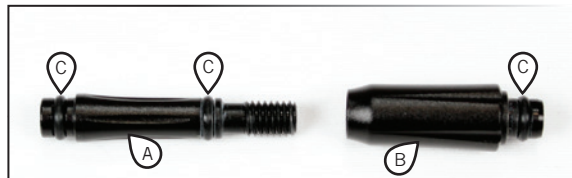

FIG 9A



FIG 9B



FIG 9C



FIG 9D



FIG 9E



FIG 9F

### **WARNING**

**MAKE SURE THE MARKER IS TURNED OFF WITH A BARREL BLOCKING DEVICE INSTALLED AND THAT NO PAINTBALLS ARE IN THE MARKER OR LOADER BEFORE INSTALLING AN AIR SYSTEM.**

**COMPRESSED AIR AND NITROGEN SYSTEMS CAN BE EXTREMELY DANGEROUS IF HANDLED OR USED INCORRECTLY.**

**ONLY USE AN AIR SYSTEM CERTIFIED FOR USE WITHIN THE TERRITORY OF INTENDED USE.**

**THE EGO LV1 CANNOT BE USED WITH CO2. ONLY USE COMPRESSED AIR OR NITROGEN.**

**NEVER ADD ANY LUBRICANTS OR GREASES INTO THE FILL ADAPTER OF THE AIR SYSTEM REGULATOR**

**ENSURE THAT ALL SCREWS ARE TIGHTENED AND NO PARTS ARE LOOSE BEFORE INSTALLING AN AIR SYSTEM.**

**DO NOT PRESSURISE THE EGO LV1 WITHOUT THE BOLT SYSTEM CORRECTLY INSTALLED, AS HIGH PRESSURE GAS WILL BE EMITTED.**

**DO NOT INSTALL A COMPRESSED AIR SYSTEM OR LOAD PAINTBALLS INTO THE EGO LV1 UNTIL YOU FEEL COMPLETELY CONFIDENT WITH YOUR ABILITY TO HANDLE THE MARKER SAFELY AND RESPONSIBLY.**

**ALWAYS RELIEVE ALL RESIDUAL GAS PRESSURE FROM THE EGO LV1 BEFORE UNSCREWING THE PRESET AIR SYSTEM.**



## CONTINUED

CHECK THAT THE GAS PIPE ASSEMBLY IS CORRECTLY INSTALLED. SEE PAGE 15 FOR INSTALLATION INSTRUCTIONS OF THE GAS PIPE.

CHECK THAT THE POPS RETAINING SCREWS ARE TIGHT. IF THE POPS CAN BE MOVED ON THE FRAME THE SCREWS ARE TOO LOOSE. USE A 5/32" HEX KEY TO TIGHTEN THE SCREWS.

Every Ego LV1 comes complete with an Eclipse Push On Purge System (POPS) which provides a direct connection for a preset air system. Before screwing an air system into the POPS ensure that the bonnet is disengaged in its forward position (SEE FIGURE 10A). If the bonnet is engaged, depress the latch button and slide the bonnet forward.

Screw the preset air system into the POPS (SEE FIGURE 10B) so that the bottle screws in all the way and is tight. Pull the bonnet backwards allowing the POPS pin to depress the pin in the preset air system causing the Ego LV1 to become pressurised (providing that there is sufficient air in your tank) (SEE FIGURE 10C). When the bonnet has been pulled back far enough it engages with the POPS body.<sup>1,2</sup>

You have now installed a preset air system onto your Ego LV1.

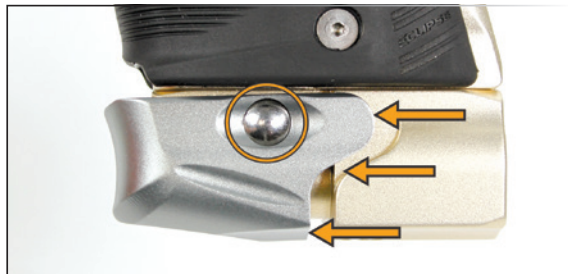

FIG 10A



FIG 10B



FIG 10C

<sup>1</sup>High, mid and low pressure output preset air systems can be used with the Ego LV1, providing the Ego LV1 has the SL4 inline regulator originally supplied with the marker.

<sup>2</sup>The force needed to engage the bonnet may vary depending on the output pressure and internal design of the air system being used.

## VELOCITY ADJUSTMENT

When using your Ego LV1, you may wish to change the velocity at which your Ego LV1 is firing. This is done by inserting a 1/8" hex key into the adjuster screw at the bottom of your Ego LV1 inline regulator and adjusting it accordingly (SEE FIGURE 11A). By turning this adjuster screw clockwise you decrease the output pressure of the inline regulator and consequently the velocity; by turning the adjuster screw counter-clockwise you increase the output pressure of the inline regulator and consequently the velocity. On the bottom of the inline regulator sleeve there are arrows to illustrate which direction to turn the hex key to make the relevant adjustment.<sup>1,2,3</sup>

## LOW PRESSURE REGULATOR ADJUSTMENT

When using the Ego LV1, you may wish to change the output pressure of the LPR. This is easily done by inserting a 1/8" hex key into the adjuster screw at the front and adjusting it accordingly (SEE FIGURE 11B). However we recommend that the LPR adjuster screw be left set 1 turn out (counter-clockwise) from the adjuster screws maximum closed position (clockwise). This is the factory default setting (see page 6).

By turning the adjuster screw clockwise, you decrease the output pressure of the LPR and consequently reduce the pressure driving the rammer back and forth. By turning the adjuster screw counter-clockwise, you increase the output pressure of the LPR and consequently increase the pressure driving the rammer back and forth.

<sup>1</sup>After each adjustment fire two clearing shots to gain an accurate velocity reading. Never exceed 300jps.

<sup>2</sup>High, mid and low pressure output preset air systems can be used with the Ego LV1, providing the Ego LV1 has the SL4 inline regulator originally supplied with the marker.

<sup>3</sup>Turning the SL4 adjuster screw in too far will prevent the Ego LV1 from firing.



FIG 11A

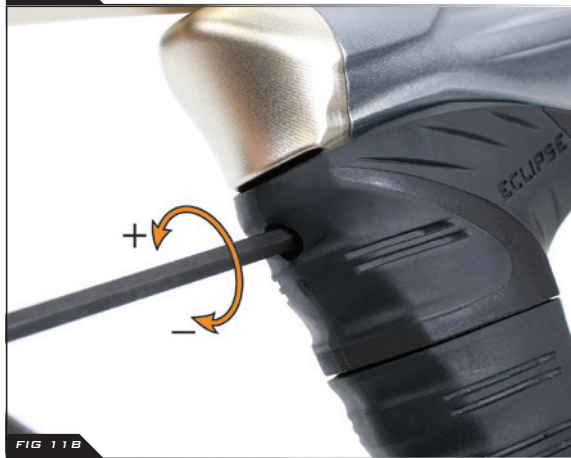

FIG 11B

## SOLENOID ADJUSTMENT

The following section covers direct adjustment of the solenoid valve which should only be undertaken by users with a sound knowledge of the Ego LV1 firing cycle. Setting either restrictor incorrectly may cause performance issues.

Built into the right side of the solenoid valve are two solenoid flow restrictors SFR(s) which control the exhaust flow from the rammer bore on the backward stroke (Restrictor **A**) and forward stroke (Restrictor **B**) (SEE FIGURE 12A). By controlling the exhaust flow from the rammer bore, the speed of the rammer during its forward and backward strokes can be sped up or slowed down. The SFRs can be adjusted using a small flat headed screw driver.

Each restrictor has a range of adjustability from 1(-) to 10 (+). Setting an SFR at 1 will provide the MINIMUM level of exhaust flow from that restrictor. Setting an SFR at 10 will provide the MAXIMUM level of exhaust flow.

By setting these restrictors at different levels of flow the user can control how the marker performs and feels when firing the marker.

Setting the restrictors to a higher level of flow will allow for higher cycles per second (dependent on the ROF Cap, see page 30). However these higher settings will also reduce the smoothness of the firing cycle compared to setting the restrictors at a lower level of flow.<sup>1</sup>

Setting the restrictors to a lower level of flow will increase the smoothness of the firing cycle, however reducing the flow also lowers the cycling rate of the Ego LV1.<sup>1</sup>

RESTRICTOR B CONTROLS THE FORWARD STROKE OF THE RAMMER. AS SUCH IT HAS THE ABILITY TO DIRECTLY CONTROL THE VELOCITY OF THE PAINTBALL. SETTING RESTRICTOR B BELOW LEVELS 6-7 ON THE SCALE WILL START TO REDUCE THE VELOCITY BELOW THE OPTIMAL SETTING. THIS HOWEVER MAY BE IDEAL FOR INDOOR/RE-BALL USE.

### SOLENOID FLOW RESTRICTOR PRESETS

Below are a list of recommended settings and their effects on the Ego LV1. The settings are expressed in the following format 1/6 where the first number is the flow level of Restrictor A and the second is the flow level of Restrictor B.<sup>1</sup>

> EGO LV1 FACTORY SETTING - 5/7 - this setting will provide a smooth shooting marker with a reasonable rate of fire, ideal for most ramping presets (eg PSP10, PSP12 etc).

> HIGH RATE OF FIRE - 10/10 - this setting will provide optimal cycling speeds but will have slightly more kick than the factory setting. Ideal for unlimited rate of fire modes

> SMOOTH SHOT - 1/7- this setting will provide a very smooth shot and a low cycling speed. Ideal for low rate of fire modes.

<sup>1</sup>These results may differ due to the LPR output pressure and Dwell settings on the Ego LV1.

### **⚠ WARNING ⚠**

**EXCESSIVE FORCE OR ADJUSTMENT WITH ANYTHING OTHER THAN THE RECOMMENDED TOOLS AND/OR OUTSIDE OF THE RECOMMENDED RANGES MAY DAMAGE THE SOLENOID VALVE**

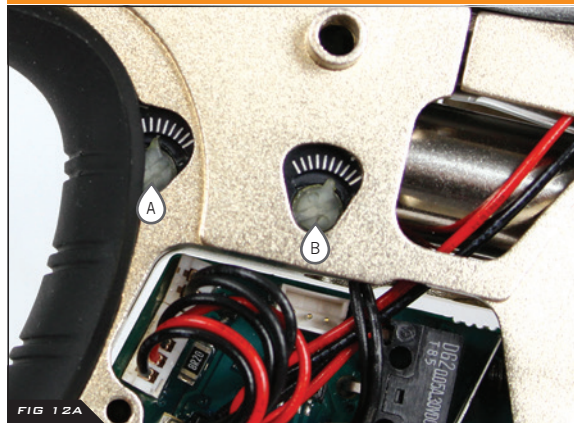



FIG 12A

## UNLOADING THE EGO LV1

### ⚠ WARNING ⚠

**ALWAYS KEEP THE ECLIPSE EGO LV1 POINTED IN A SAFE DIRECTION AND ENSURE ALL PERSONS WITHIN RANGE CONTINUE TO WEAR FACE PROTECTION, UNTIL MARKER IS COMPLETELY UNLOADED AND SAFE.**

Securely attach a barrel blocking device such as the Eclipse Barrel Sock<sup>1</sup> (supplied with the Ego LV1) to the marker as shown in FIGURE 13A.

Turn off the Ego LV1 electronics by holding down the  button on the back of the frame. When the screen turns off and the marker speaker emits the 'off' tone (if the *Sound* parameter is enabled), the marker has been turned off (SEE FIGURE 13B).

With the Ego LV1 pointing away from you. De-gas the marker by depressing the POPS latch button allowing the bonnet to slide forward and vent air. Only when the POPS has fully degassed the Ego LV1 marker, unscrew and remove the air system<sup>2</sup> (SEE FIGURE 13C).

Open the clamping lever on the feed tube and slacken off the sprocket screw if necessary on the feed tube. Carefully pull the loader out of the feed tube (SEE FIGURE 13D).

Looking down the feed tube, check to see if there are any paintballs still in the breech, if there are, turn the marker upside down while still keeping the barrel facing away from any persons within firing range then tip out any paintballs within the breech (SEE FIGURE 13E & 13F).

Next remove the barrel blocking device, and unscrew the barrel (SEE FIGURE 13G). Remove any paintballs within the barrel. The Eclipse Ego LV1 has now been unloaded and is ready for storage.

<sup>1</sup>Instruction on using the Eclipse Barrel Sock can be found on the Eclipse Barrel Sock warning label.

<sup>2</sup>The LPR on the LV1 is not self purging and may store a small amount of air in the LP hose after de-gassing the marker. This stored gas will move the rammer and bolt a small amount if the marker is fired but will not fire a complete shot. To purge the LPR, turn the marker back on after unloading it of any paintballs and fire a shot in a safe direction with the BBSS disabled.



FIG 13A



FIG 13B

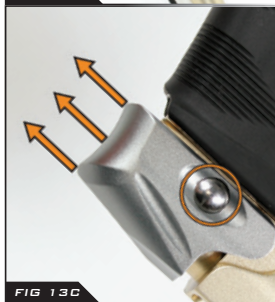

FIG 13C



FIG 13D



FIG 13E



FIG 13F



FIG 13G

## STORAGE AND TRANSPORTATION

**CAUTION: NEVER CARRY YOUR ECLIPSE EGO LV1 UN-CASED WHEN NOT ON A PLAYING FIELD. THE NON-PLAYING PUBLIC AND LAW ENFORCEMENT PERSONNEL MAY NOT BE ABLE TO DISTINGUISH BETWEEN A PAINTBALL MARKER AND A REAL FIREARM. FOR YOUR OWN SAFETY AND TO PROTECT THE IMAGE OF PAINTBALL, ALWAYS CARRY THE ECLIPSE EGO LV1 (OR ANY OTHER PAINTBALL MARKER) IN A SUITABLE MARKER CASE SUCH AS THE ONE IN WHICH IT WAS SUPPLIED.**

- Your Eclipse Ego LV1 must be clear of all paint and propellant during transportation or storage.
- Make sure the Eclipse Ego LV1 marker is off.
- Remove the barrel from the marker.
- Make sure the marker is clean of any paint residue, dirt and moisture.
- Store your Eclipse Ego LV1 in a clean, cool, dry place.
- Keep your Eclipse Ego LV1 away from any unauthorized and unsafe users.
- It may be a good idea to remove the battery when storing your Eclipse Ego LV1 to prevent unauthorized use.
- Protect your Eclipse Ego LV1 from excessive heat during transportation.
- When transporting a paintball marker by air, check with the airline regarding their policies on transporting paintball equipment as hold luggage before arriving at the airport.
- Observe and obey all local and national laws concerning the transportation of paintball markers. For information concerning any of the laws in your area, contact your nearby law enforcement agency.
- When shipping the Eclipse Ego LV1 for any reason, Planet Eclipse recommends using the case in which the marker was originally supplied to protect the marker against rough handling during transport.

## THE USER INTERFACE

The Ego LV1 has a simple user interface through which all aspects of its electronic control system can be monitored and adjusted by means of the three push buttons and graphical LCD which comprise the navigation console.

## THE RUN SCREEN LAYOUT

The root of the user interface is the run screen which is the screen that is displayed most often when the Ego LV1 is on. The run screen has five display functions and the user can scroll through these functions by repeatedly pressing the  button on the navigation console.

- > GAME TIMER
- > SHOT COUNTER
- > PEAK RATE OF FIRE INDICATOR
- > ACTUAL RATE OF FIRE INDICATOR
- > SPLASH (MARKER LOGO<sup>2</sup>)

With the exception of the Splash, the run screen is vertically divided with the screen function displayed on the left and a series of status icons displayed on the right.

The SPLASH run screen will display the marker logo with a flashing / alternating backlight. THE MARKER IS STILL ABLE TO FIRE WHEN THIS SCREEN IS DISPLAYED.

BREAK BEAM SENSOR  
SYSTEM INDICATOR

AUX OUT INDICATOR

TRIGGER DETECTION  
INDICATOR

SOUND INDICATOR

USER SELECTABLE  
DISPLAY OPTION

LOCK INDICATOR

BATTERY LEVEL  
INDICATOR

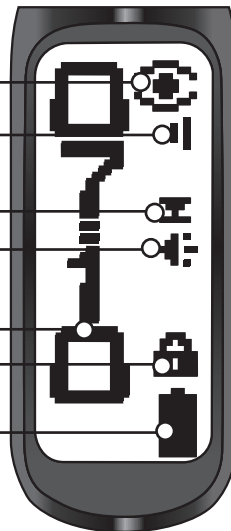

<sup>1</sup>The layout of the run screen is correct at time of printing. However newer versions of the Ego LV1 software may have a different layout of the run screen from what is printed in this manual. You may find some icons have been added or removed entirely. If you are unsure about any icons which do not feature in the manual contact your local dealer/service centre or Planet Eclipse directly.

<sup>2</sup>The splash graphic can be modified to display custom graphics with the Eclipse E-portal software sold separately (see page 85 for more information on Eclipse E-portal).

## THE BBSS INDICATOR

The BBSS is able to switch itself off in the event of a blockage or contamination preventing it from functioning correctly. In this instance, the BBSS will switch itself back on once the blockage is cleared and the correct operation can be resumed.

The BBSS indicator on the main screen is used to indicate the eight possible states of the BBSS as follows:



**BBSS ENABLED AND BALL DETECTED**

The Ego LV1 can be fired at the maximum rate of fire determined by the chosen firing mode.



**BBSS FAULT HAS BEEN CLEARED AND BALL DETECTED**

The system has been re-enabled. A ball is detected and the Ego LV1 can be fired at the maximum rate of fire determined by the chosen firing mode.



**BBSS DISABLED**

The Ego LV1 can be fired at a maximum rate of fire as set by the *BS OFF ROF* parameter (see page 30).



**BBSS ENABLED IN TRAINING MODE**

The BBSS has been over-riden as the user has selected training mode. As the user has chosen to leave the BBSS on, the achievable rate of fire is limited by the firing mode.



**BBSS ENABLED NO BALL DETECTED**

The Ego LV1 cannot be fired.



**BBSS FAULT HAS BEEN CLEARED AND NO BALL DETECTED**

The system has been re-enabled. No ball is detected so the Ego LV1 cannot be fired. To reset the BBSS icon, use the  button to switch off the BBSS and then back on again.



**BBSS FAULT DETECTED**

The system is disabled. The Ego LV1 can only be fired at a maximum rate of 2bps less than the maximum rate of fire, up to a maximum of 10 bps.



**BBSS DISABLED IN TRAINING MODE**

The BBSS has been over-riden as the user has selected training mode. As the user has chosen to turn the BBSS off, the achievable rate of fire is limited by the *BS OFF ROF* parameter (see page 30).

## THE AUX OUT INDICATOR

The auxiliary socket on the Ego LV1 circuit board allows third party products such as loaders or RF transmitters to be interfaced to the Ego LV1.

The AUX out indicator is turned on and off via the *AUX OUT* parameter (see page 39).

There are two possible conditions that can be indicated:



**AUX OUT ENABLED**

The AUX OUT is enabled. Each time the circuit board detects a valid trigger pull a signal will be sent to the AUX connector on the circuit board.



**AUX OUT DISABLED**

The AUX OUT is disabled. No signal will be sent to the AUX connector on the circuit board.

## THE SOUND INDICATOR

The sound indicator on the run screen is used to convey if the Sound parameter in the Hardware menu (page 37) is switched on or off.

There are two possible conditions that can be indicated:



### *SOUND ENABLED*

The *SOUND* parameter is enabled. The Ego LV1 will make sounds when switched on and off and when the game timer alarms or times out.



### *SOUND DISABLED*

The *SOUND* parameter is disabled. The Ego LV1 will not make any sounds.

## THE TRIGGER DETECTION INDICATOR

In order for the trigger to be successfully operated it must first be released and then pulled. The trigger detection indicator (TDI) is used to indicate each of the possible trigger states.



### *OPTO SENSOR SELECTED, READING 0%*

The Ego LV1 is configured to use the OPTO sensor to detect trigger pulls. The OPTO sensor is currently reading 0%, i.e. the trigger is fully released.



### *OPTO SENSOR SELECTED, READING BELOW RELEASE POINT*

The Ego LV1 is configured to use the OPTO sensor to detect trigger pulls. The OPTO sensor is currently reading below the OPTO release point, i.e. the trigger is considered 'released'.



### *OPTO SENSOR SELECTED, READING MID-RANGE*

The Ego LV1 is configured to use the OPTO sensor to detect trigger pulls. The OPTO sensor is currently reading somewhere between the OPTO release point and the OPTO pull point, i.e. the trigger is half depressed.



### *OPTO SENSOR SELECTED, READING ABOVE PULL POINT*

The Ego LV1 is configured to use the OPTO sensor to detect trigger pulls. The OPTO sensor is currently reading above the OPTO pull point, i.e. the trigger is considered 'pulled'.



### *OPTO SENSOR SELECTED, READING 100%*

The Ego LV1 is configured to use the OPTO sensor to detect trigger pulls. The OPTO sensor is currently reading 100%, i.e. the trigger is fully depressed.



### *MICRO-SWITCH SELECTED, NOT ACTUATED*

The Ego LV1 is configured to use the micro-switch to detect trigger pulls. The micro-switch is not currently actuated, i.e. the trigger is released.



### *MICRO-SWITCH SELECTED, ACTUATED*

The Ego LV1 is configured to use the micro-switch to detect trigger pulls. The micro-switch is currently actuated, i.e. the trigger is pulled.

From the factory the Ego LV1 will have the OPTO sensor enabled. The micro-switch can be enabled from the Hardware menu (see page 37).



## THE LOCK INDICATOR

The Ego LV1 has a tournament lock which prevents the user from making changes to any parameter that affects the way in which the Ego LV1 shoots, without the need for tools. This feature is necessary in order to make the Ego LV1 legal for tournament play. To enable or disable the tournament lock see *Accessing the Menu System* on page 27.

When the lock is enabled the lock indicator will show a closed padlock .

When the lock is disabled the lock indicator will show an open padlock .

## THE BATTERY LEVEL INDICATOR

The battery level indicator is used to show the state of the battery within the Ego LV1. When the battery is fresh the indicator will show a 'full' battery  and as the battery is drained, so will the indicator show the battery emptying. When the battery reaches a point at which the Ego LV1 will no longer function reliably, the indicator will start to flash. At this point the battery must be changed immediately.

As well as displaying the voltage level of the battery, the indicator also warns if the battery being used has an incorrect voltage to operate the electronics reliably. The icon for a battery with an incorrect voltage output is . If this icon is shown the battery must be replaced immediately.

## THE GAME TIMER

When the game timer is shown on the run screen then it can be started by pressing the  button and the timer will start to count down. The game timer can also be configured to start on a trigger press with the *START* parameter (see page 41).

When the game timer reaches the *ALARM TIME* the game timer will start to flash and the audible alarm will sound every second, provided that the *SOUND* parameter is on.

When the game timer reaches 00:00, **GAME OVER** will be displayed and the audible alarm will sound continually, provided that the *SOUND* parameter is set to 'ON'.

To stop the game timer at any time press and hold the  button for 0.5 seconds.

To reset the game timer to its preset start time, push and hold the  button for 0.5 second. The game timer will also be reset whenever the Ego LV1 is switched off.

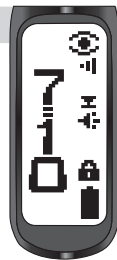

## THE SHOT COUNTER

The shot counter will increment every time that the circuit board registers a trigger pull, regardless of whether the shot counter is displayed or not. When the shot counter is displayed on the run screen it can be reset to 0 by pressing and holding the  button for 0.5 seconds.

There is also an optional shot gauge that can be displayed on this run screen. The gauge counts down from a user adjustable number. To alter the gauge settings see page 40. The gauge is reset whenever the Ego LV1 is switched off or the  button is pressed.

The shot counter does not function when the Ego LV1 is in Training Mode (see page 40).

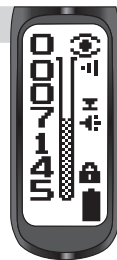

## THE ACTUAL RATE OF FIRE

When the actual ROF is selected for display the run screen will look something like the screen to the right. The value displayed in the top left of the screen represents the number of full cycles completed in a second - the actual rate of fire over that second. The value below it is the maximum actual rate of fire that has been achieved. The graph below this number shows the actual rates of fire achieved over time where each bar represents the amount of pulls in that second. To reset the maximum, press and hold the  button for 0.5 second.



## THE PEAK RATE OF FIRE

When the peak ROF is selected for display the run screen will look something like the screen to the right, which differs from the display of the actual ROF by the inclusion of the indicator 'PK'. The value displayed in the top left of the screen represents the maximum rate of fire that has been recorded over the last second. The value below it is the maximum peak rate of fire that has been achieved. The graph below this number shows the peak rates of fire achieved over time. To reset this maximum, press and hold the  button for 0.5 seconds.

The peak ROF is typically higher than the actual ROF as it is much easier to fire two shots in quick succession than it is to maintain a string over a longer period of time.



## THE MENU SYSTEM



Behind the run screen is a structured menu system comprised of two layers of menus. Each menu contains a number of menu items and each menu item can either be a parameter or a branch to another menu. Branches have an animated graphic on the right of the display, whereas parameters have their current value.

On parameter screens a range bar will be displayed where there is a large scale of adjustability in that parameter. The current parameter value is displayed as a box on the range bar which is used to indicate the range of adjustability in the parameter value.

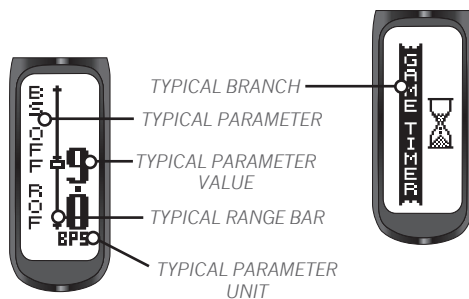
At the bottom of the parameter screen the unit for that parameter will be displayed. Some parameters will not have units, such as on or off parameters.



## ACCESSING THE MENU SYSTEM

To access the Main menu from the run screen double-click the  button and the first item on the Main menu will be displayed. Alternatively, push and hold the  button for 2 seconds.

Some of the parameters in the menu system can have a tournament lock applied to them. This lock can be toggled on and off by pressing the tournament lock button on the circuit board (SEE  IN FIGURE 14A).

When trying to select a parameter that is locked, the a 'LOCKED' message will be briefly displayed.





## MOVING AROUND THE MENUS

### WARNING

**THE MARKER CAN BE FIRED WHILE NAVIGATING ALL MENUS AND PARAMETERS.**





Press and release the  button to display the next item on the menu. When the last menu item is displayed, pressing the  button will display the first item.







Press and release the  button to display the previous item on the menu. When the first menu item is displayed, pressing the  button will display the last item.

When the displayed item is a branch, as indicated by an animation on the right of the screen, press the  button to move to another menu.

## ALTERING PARAMETERS

When the displayed item is a parameter, as indicated by a parameter value on the right of the screen, pressing the  button will activate the EDIT mode which allows the parameter value to be altered. When EDIT mode is active, the black box surrounding the parameter name disappears. There are two types of parameter, numeric parameters and choice parameters.

A numeric parameter has a numeric value whereas a choice parameter is one that has a small number of distinct choices. Altering parameter values is essentially the same for both types of parameter. To alter a numeric parameter, first activate the EDIT mode. Press the  button to increase the parameter value one step at a time. Press and hold the  button to increase the parameter value rapidly. When the value reaches its maximum it will revert to its minimum value. Press the  button to decrease the parameter value one step at a time. Press and hold the  button to decrease the parameter value rapidly. When the value reaches its minimum it will revert to its maximum value. When the required parameter value is displayed press the  button to accept the value and end the EDIT mode.

To alter a choice parameter, first activate the EDIT mode. Press the  button to display the next choice in the list. When the last choice is displayed, pressing  will display the first choice in the list. Press the  button to display the previous choice in the list. When the first choice is displayed, pressing the  button will display the last choice in the list. When the required choice is displayed press the  button to accept the choice and end the EDIT mode. If the displayed choice is CANCEL then pressing the  button will end the EDIT mode and restore the parameter to the value that it was prior to editing.



## THE MENU SYSTEM



The Main menu contains both editable parameters and sub-menus which contain editable parameters. Some of these parameters affect the way the Ego LV1 shoots and are tournament locked as standard from the factory.<sup>1</sup>

The Main menu also contains the TURN OFF option. Selecting this option will immediately turn off the EGO LV1, preventing it from firing.

Parameters followed by a \* are part of the Smart Menu System and will only be displayed depending on your chosen settings. (e.g. The BS ON ROF parameter will only become available if the ROF CAP parameter is set to on).

<sup>1</sup>The layout of the Main menu is correct at time of printing. However newer versions of the Ego LV1 software may have a different layout of the Main menu, sub-menus and parameters from what is printed in this manual. You may find some parameters have been added or removed entirely. If you are unsure about any parameters which do not feature in the manual contact your local dealer/service centre or Planet Eclipse directly.

## PRESET MENU

In order to simplify the set up of the Ego LV1 a number of preset configurations are available for selection. Choosing one of these presets will cause all of the necessary parameters to be set in such a way as to make the Ego LV1 comply with the rules governing a particular paintball league<sup>1</sup>. It is also possible for the user to save up to two preset configurations of their own.

## LOAD PARAMETER

This parameter is used to load the required preset configuration and has the following choices:

- > USER 1: Load a set of custom firing mode parameters that have been previously saved by the user.
- > USER 2: Load a set of custom firing mode parameters that have been previously saved by the user.
- > FACTORY: Reset every parameter to the factory set default. The Ego LV1 leaves the factory set in this way.
- > NPPL: Load a set of parameters that configures the Ego LV1 to comply with the NPPL rules governing firing modes.<sup>1,2</sup>
- > PSP 10: Load a set of parameters that configures the Ego LV1 to comply with the PSP rules governing firing modes in lower divisions (10bps).<sup>1,2</sup>
- > PSP 12: Load a set of parameters that configures the Ego LV1 to comply with the PSP rules governing firing modes in higher divisions (12bps).<sup>1,2</sup>
- > MS10: Load a set of parameters that configures the Ego LV1 to comply with the 2010 Millennium Series rules governing firing modes.<sup>1,2</sup>
- > CANCEL: Editing is cancelled and the parameter remains unchanged.

## SAVE PARAMETER

This parameter is used to save the current set of parameters as a user defined custom preset configuration.

This parameter has the following choices:

- > USER 1: Save the current parameters as the preset 'USER 1'.
- > USER 2: Save the current parameters as the preset 'USER 2'.
- > CANCEL: Editing is cancelled and the parameter remains unchanged.

<sup>1</sup>Some presets and fire modes may only be available in certain countries and on some models of the Ego LV1.

<sup>2</sup>All presets are correct at time of printing. It is the users responsibility to ensure that the loaded preset complies with the event rules the marker is intended to be used in.



## FIRE MODE PARAMETER

This parameter is used to select the firing mode of the Ego LV1 and has the following choices:

- > SEMI: This is the default and in this firing mode the Ego LV1 will fire one shot for every trigger pull.
- > RAMP: In this firing mode, the rate of fire is increased above the rate at which the trigger is pulled once certain criteria have been met. These criteria are set by the parameters on the *RAMP SETUP* menu.<sup>1</sup>
- > CANCEL: Editing is cancelled and the parameter is unchanged.

<sup>1</sup>Some presets and fire modes may only be available in certain countries and on some models of the Ego LV1.

## ROF CAP PARAMETER

The *ROF CAP* parameter is used to specify whether or not the Ego LV1 should have a limited / capped rate of fire. When the *ROF CAP* is enabled (and the BBSS is enabled), the maximum achievable rate of fire is set by the *BS ON ROF* parameter. Choices for the *ROF CAP* parameter are:

- > OFF: Rate of fire only limited by the loader.
- > ON: Rate of fire limited to the *BS ON ROF* parameter value.
- > CANCEL: Cancel editing and leave the parameter unchanged.

## BS ON ROF PARAMETER\*

The *BS ON ROF* parameter is used to set the maximum achievable rate of fire from the Ego LV1. The value of this parameter can be adjusted between 4.0 and 30.0 balls per second in 0.1bps increments.

The *BS ON ROF* parameter will only be displayed if you have set the *ROF CAP* parameter to 'ON'.

## BS OFF ROF PARAMETER

The *BS OFF ROF* parameter is used to control how fast the Ego LV1 cycles when the Break Beam Sensor System is disabled. This parameter can be set between 4.0 and 15.0 balls per second and should always be set to the slowest speed of the loading system in use.

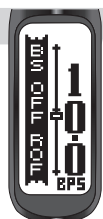
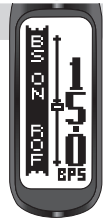
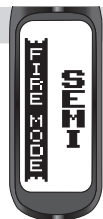

## RAMP SETUP MENU

This menu is only available when ramping has been selected with the *FIRE MODE* parameter and comprises a list of parameters that control the way in which the Ego LV1 ramps, as shown below.

### TYPE PARAMETER

This parameter is used to select the ramping style and has the following choices:

- > **STEP**: Step ramping will cause the Ego LV1 to shoot in semi-automatic until a number of trigger pulls, set by *SEMI SHOTS*, have been made at a minimum pull rate, set by *KICK IN*. At this point the rate of fire will step up to the maximum rate of fire as set by *BS ON ROF* (or the maximum loader speed if the *ROF CAP* parameter is set to off). Ramping is maintained as long as the user continues to pull the trigger at a required rate set by *SUSTAIN*.
- > **LINEAR**: Linear ramping will cause the Ego LV1 to shoot in semi-automatic until a number of trigger pulls, set by *SEMI SHOTS*, have been made at a minimum pull rate, set by *KICK IN*. At this point the rate of fire will equal the rate of trigger pulls increased by the percentage specified by *RATE* up to a maximum rate of fire as set by *BS ON ROF*, if the *ROF CAP* is on. Ramping is maintained as long as the user continues to pull the trigger at a required rate set by *SUSTAIN*.
- > **CANCEL**: Editing is cancelled and no changes are made to the parameter.

### RATE PARAMETER\*

The parameter is only available when *LINEAR* ramping is selected and is used to set the percentage increase in rate of fire over rate of trigger pulls.

For example, if the user is pulling the trigger at a rate of 10 pulls per second and the *RATE* parameter is set to 50% then the rate of fire is 10 plus 50% extra which is 15 balls per second.

This parameter can be set between 0 and 100% in 10% increments.

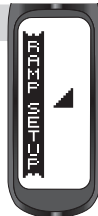

<sup>1</sup>Always calibrate your Ego LV1 ROF CAP parameters to the local field BPS meter as readings may vary from meter to meter.

## SEMI SHOTS PARAMETER

The parameter sets the number of shots in semi-automatic that are required at the *KICK IN* rate before ramping will start. The parameter can be set between 3 and 9 pulls in 1 pull increments.

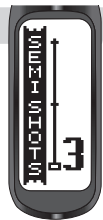

## KICK IN PARAMETER

This parameter sets the minimum rate at which the user has to pull the trigger in order to start ramping. This parameter can be set between 3.3 and 10.0 pulls per second in 0.1 pulls per second increments.



## SUSTAIN PARAMETER

Once the Ego LV1 is ramping the user has to continue to pull the trigger at a minimum rate in order to maintain the ramping. This parameter sets this rate and can be between 3.3 and 10.0 pulls per second in 0.1 pulls per second increments.



## RESTART PARAMETER

The *RESTART* parameter defines the amount of time after the last trigger pull during which the ramp can be restarted with a single trigger pull. If a trigger pull occurs after the *RESTART* time has expired, then the other ramp start conditions have to be met before ramping will restart. This parameter can be set between 0.0 and 1.0 seconds in 0.1 second increments.





## TIMING MENU

These parameters all relate to the control of the solenoid valve.

### DWELL PARAMETER

The *DWELL* parameter sets the amount of time that the solenoid is energized and therefore the amount of gas that is released with each shot of the Ego LV1. Setting this parameter too low will result in low velocity shots and/or excessive shot to shot velocity fluctuations. Setting the parameter too high will simply waste gas and make the Ego LV1 louder. The *DWELL* can be set between 0.0 and 30.0 milliseconds. The factory default setting can normally be reduced after a few thousand shots as the Ego LV1 'beds-in'.

### FSD COMP PARAMETER

"First shot drop off" is a reduction in velocity of the first shot fired after an extended period of not firing and is caused by the stiction between dynamic o-rings and the surfaces that they are in contact with. In order to compensate for first shot drop-off this parameter can be set to add extra time to the *DWELL* parameter for the first shot. This parameter can be set between 0.0 and 5.0 milliseconds.

### FSD DLY PARAMETER

The time that has to elapse before the FSD COMP is applied to a shot following a previous shot. This parameter can be set between 00:00 and 04:00 minutes.



## FILTER MENU

The parameters on the *FILTER* menu are all used to tune the Ego LV1's software filters which prevent the Ego LV1 from firing unless all of the necessary conditions are met. The factory default settings will be suitable for most set-ups, however certain loader and trigger set-ups may require modification of one or more of these parameters.

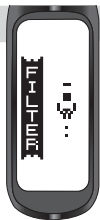

## DEBOUNCE PARAMETER

The *DEBOUNCE* parameter is used to combat any trigger bounce that might occur in the Ego LV1 and can be set between level 1 and level 9 in one level increments.

- > LEVEL 9: Level 9 providing the most filtering (least 'bouncy').
- > LEVEL 1: Level 1 providing the least filtering (most 'bouncy').
- > CANCEL: Cancel editing and leave the parameter unchanged.



## EMPTY PARAMETER

In order for the BBSS to function correctly it must first detect that the bolt is fully retracted and the breech is empty, and then detect that a paintball is loaded into the breech before the Ego LV1 is allowed to fire. The parameter can be set between 1.0 and 20.0ms in 0.1ms increments.

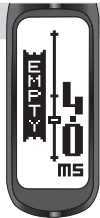

## FULL PARAMETER

Tumbling paintballs can take time to settle in the breech before they can be successfully fired. This parameter is used to set the amount of time that a paintball has to be in the breech before the Ego LV1 is allowed to fire. This parameter can be set between 1.0 and 20 milliseconds in 0.1ms increments.



## PULL TM PARAMETER

The *PULL TM* parameter is used to set the minimum amount of time that the trigger must be pulled before it is recognised as a valid trigger pull. This parameter can be set between 3.0 and 20.0 milliseconds in 0.1ms increments.



## RELEASE TM PARAMETER

The *RELEASE TM* parameter is used to set the minimum amount of time that the trigger must be released before it is recognised as a valid trigger release. This parameter can be set between 3.0 and 25.0 milliseconds in 0.1ms increments.



## PULL PT PARAMETER\*

The *PULL PT* parameter is only available if OPTO has been selected in the *HARDWARE* menu. *PULL PT* defines the point at which the trigger is considered pulled and is adjustable between 51% and 99% in 1% increments.



## RELEASE PT PARAMETER\*

The *RELEASE PT* parameter is only available if OPTO has been selected in the *HARDWARE* menu. *RELEASE PT* defines the point at which the trigger is considered released and is adjustable between 1% and 49% in 1% increments.

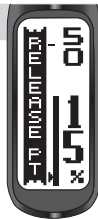

## BASIC TRIGGER FILTER SET-UP

95% of trigger bounce problems can be eliminated by utilizing one of the nine fixed *DEBOUNCE* choices (LEVEL 1-9). In attempting to eliminate trigger bounce it is advisable to try the nine fixed *DEBOUNCE* choices before attempting any advanced set up of the trigger filters.

## ADVANCED TRIGGER FILTER SET-UP

In order to optimize the trigger filters it is necessary to have the *PULL PT* parameter set as high as possible and the *RELEASE PT* parameter set as low as possible:

1. Select the *PULL PT* parameter. Observe that the graphical bar rises and falls as the trigger is pulled and released. The actual value of the graphical bar is displayed in the top right of the display.
2. Set the rear stop screw as required, ensuring that the bar is as close to 100% as possible when the trigger is fully depressed against the set screw. It is advisable to allow for some extra travel in the trigger pull once the bar has reached its maximum value.
3. Adjust the *PULL PT* parameter so that when the trigger is fully depressed the bar settles above the indicator on the left hand side of the screen (see page 35).
4. Select the *RELEASE PT* parameter. Observe that the graphical bar rises and falls as the trigger is pulled and released. The actual value of the graphical bar is displayed in top right of the display.
5. Set the front stop screw as required, ensuring that the bar is as close to 0% as possible when the trigger is fully released against the set screw. It is advisable to allow for some extra travel in the trigger release once the bar has reached its minimum value.
6. Adjust the *RELEASE PT* parameter so that when the trigger is fully released the bar settles beneath the indicator on the left hand side of the screen (see page 35).
7. Set the magnet return strength screw and the spring return strength screw as required, making both the spring tension and the return force as strong as possible without compromising the “feel” of the trigger.

## HARDWARE MENU

This menu comprises parameters that control low level functionality of the Ego LV1 electronic hardware.

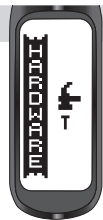

## TRIGGER PARAMETER

The Ego LV1 is fitted with a dual trigger pull detection system. A non-contact OPTO-electronic trigger sensor arrangement is used to detect trigger movement whilst a micro-switch is used to provide a more traditional tactile feedback for the trigger. The *TRIGGER* parameter is used to select which system is used. The choices available are as follows:

- > OPTO: Select the OPTO sensor for trigger pull detection.
- > SWITCH: Select the micro-switch for trigger pull detection.
- > CANCEL: Cancel editing and leave the parameter unchanged.

## SOLENOID PARAMETER

This parameter controls the amount of power used by the solenoid valve and should normally be left at it's default 'LO PWR' setting. Cold weather (sub 0<sup>o</sup>/32<sup>o</sup>) will cause lubricants to thicken and increase stiction in the marker system which may cause velocity drop-off and/or shot to shot inconsistency. Increasing the solenoid power will often help to eliminate these problems, but will cause more drain on the battery. The choices available for the parameter are:-

- > LO PWR: Low power solenoid drive
- > HI PWR: High power solenoid drive
- > CANCEL: Cancel editing and leave the parameter unchanged

## SOUND PARAMETER

The Ego LV1 board is capable of emitting a variety of sounds to audibly signal when certain functions have been performed including, but not limited to, powering up, powering off, changing the BBSS mode and resetting various counters and timers. This parameter determines if this feature is switched on or off. Switching it on will cause increased drain on the battery. The choices available for this parameter are:

- >OFF: Sounds switched off.
- >ON: Sounds switched on.
- >CANCEL: Cancel editing and leave the parameter unchanged.

## TONES PARAMETER\*

This parameter determines if the Ego LV1 emits a tone each time any of the pushbuttons on the navigation console are activated. As part of the smart menu system the *TONES* parameter will only be shown in the *HARDWARE* menu if the *SOUND* parameter is switched 'ON'. The choices available for this parameter are:

- >OFF: Tones switched off.
- >ON: Tones switched on.
- >CANCEL: Cancel editing and leave the parameter unchanged.

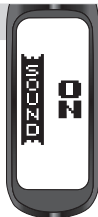

## BACKLIGHT PARAMETER

This parameter sets the time that the LCD backlight is illuminated after a pushbutton is pressed. The parameter can be set between 00:00 and 00:20 (20 seconds). If set to 00:00 then the backlight will not be illuminated.



## RED LEVEL PARAMETER\*

This parameter sets the percentage of red light in the LCD backlight and can be set between 0% and 100% in 10% increments.



## GRN LEVEL PARAMETER\*

This parameter sets the percentage of green light in the LCD backlight and can be set between 0% and 100% in 10% increments.



## BLU LEVEL PARAMETER\*

This parameter sets the percentage of blue light in the LCD backlight and can be set between 0% and 100% in 10% increments.



## CONTRAST PARAMETER

The parameter sets the contrast level of the LCD. This parameter is adjustable between 0 and 30 in increments of 1.



## AUX OUT PARAMETER



This parameter turns on and off the AUX socket on the PCB. The choices available for this parameter are:

- >OFF: AUX socket switched off.
- >ON: AUX socket switched on.
- >CANCEL: Cancel editing and leave the parameter unchanged.



## DBL CLICK PARAMETER

This parameter is used to select where double-clicking the  button can be used. The choices available for this parameter are:

- >NONE: Double clicking is disabled entirely. To power up the Ego LV1 and enter the Main Menu the user needs to push and hold the  button.
- >POWER UP: Double clicking only works when powering up the Ego LV1. To enter the Main Menu the user still needs to push and hold the  button.
- >ALL: Double clicking works when powering up the Ego LV1 and entering the Main Menu. Push and hold still works for these procedures as well.
- >CANCEL: Cancel editing and leave the parameter unchanged.



## AUTO OFF PARAMETER

This parameter sets the time that has to elapse before the Ego LV1 switches itself off if not used. The parameter can be set between 05:00 and 20:00 minutes.



## TRAINING PARAMETER

In training mode the LV1 simulates the firing cycle so that the user may practice pulling the trigger without wasting air and making lots of noise. The BBSS is overridden in order to simulate paintballs entering the breech and the beeper indicates when a shot is fired. Training mode is indicated with a 'T' in the BBSS indicator.

- > OFF: Training mode is disabled and the Ego LV1 functions normally.
- > ON: Training mode is enabled.
- > CANCEL: Cancel editing and leave the parameter unchanged.



## SHOT COUNT MENU

This menu is comprised of parameters that control the shot counter.

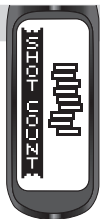

## GAUGE PARAMETER

This parameter allows the user to toggle the gauge graphic on and off in the shot counter Run Screen. The choices for the *GAUGE* parameter are:

- > OFF: Gauge graphic on the shot counter run screen is disabled.
- > ON: Gauge graphic on the shot counter run screen is enabled.
- > CANCEL: Cancel editing and leave the parameter unchanged.



## GAUGE MAX PARAMETER\*

The *GAUGE MAX* parameter allows the user to set the number the gauge counts down from every time the Ego LV1 is fired. The user can set the gauge from 100 to 2000 in increments of 10.





## GAME TIMER MENU

This menu is comprised of parameters that control the operation of the Game Timer.



### GAME PARAMETER

This parameter is used to set the Game Time, the time from which the game timer counts down to zero. This parameter can be set between 00:00 and 60:00 minutes in 10 second increments. The factory default is 07:10 (7 minutes 10 seconds).

When the game timer reaches 00:00, GAME OVER will be displayed and the audible alarm will sound continually, provided that the *SOUND* parameter is set to 'ON'.



### ALARM PARAMETER

An alarm condition is generated whenever the Game Timer counts down to the time set by the *ALARM* parameter. This parameter can be set between 00:00 and 10:00 minutes in 10 second increments.

When the alarm condition is generated the Game Timer will start to flash and the audible alarm will sound every second, provided that the *SOUND* parameter is set to 'ON'.



### START PARAMETER

This parameter is used to select the event which will cause the Game Timer to begin counting down. This parameter has the following choices:

- > **BUTTON**: Pressing the  button will start the Game Timer.
- > **TRIGGER**: Pulling the trigger will start the Game Timer.
- > **CANCEL**: Cancel editing and leave the parameter unchanged.



## THE BREAK BEAM SENSOR SYSTEM

### ⚠️ WARNING ⚠️

DE-GAS YOUR MARKER, DISCHARGING ANY STORED GAS IN A SAFE DIRECTION, AND REMOVE THE BARREL, LOADER, AIR SYSTEM AND ANY PAINTBALLS TO MAKE THE MARKER EASIER AND SAFER TO WORK ON.

Undo the retaining screw for the BBSS eye cover on the right hand side of the Ego LV1 using a 5/64" (2mm) hex key (SEE FIGURE 15A).

Remove the eye cover to expose the back of the BBSS unit (SEE FIGURE 15B). Using a dry cotton bud, carefully remove any debris, paint or moisture from the back of the sensor unit and from inside the eye cover.

Lift the BBSS unit free from the Ego LV1 body and using another dry cotton bud, remove any grease or debris build-up from the front of the sensor unit (SEE FIGURE 15C).

Clean the hole under the BBSS unit on the body that allows the BBSS unit to 'see' into the breech. Clean the pocket the BBSS unit sits in.



FIG 15A



FIG 15B



FIG 15C

## (CONTINUED)

Remove the rubber Detent and using a dry cotton bud clean the Detent and its location point in the Ego LV1 body, replacing the Detent if it is damaged (SEE FIGURE 15D).

Reinsert the Detent back into the Ego LV1 body and place the BBSS back into the designated slot in the body to re-assemble FIGURE 15B. Ensure that the sensor is face down in the body i.e. looking into the breach.<sup>1</sup>

Check that the cam carrier screws are still tight in the body. DO NOT over tighten the screws on the body or cam carrier may be damaged (LABELLED A FIGURE 15E).

Before replacing the eye cover ensure the wire is flat in the pocket in the LV1 body and does not lie over the cam carrier or retaining screws. This will prevent the wires being crushed by the eye cover (LABELLED B FIGURE 15E).

Replace the eye cover and using a 5/64" hex key, replace the eye cover retaining screw to hold the eye cover in place (SEE FIGURE 15F).

Repeat the procedure for the opposite side of the Ego LV1.

You have now cleaned the BBSS.

<sup>1</sup>Ensure that the receiver device (indicated by a red mark & red heat shrink) is located on the right-hand side of the marker body.



**IF YOU ARE UNSURE ABOUT PERFORMING A MAINTENANCE PROCEDURE PLEASE CONTACT YOUR NEAREST SERVICE CENTRE.**



FIG 15D

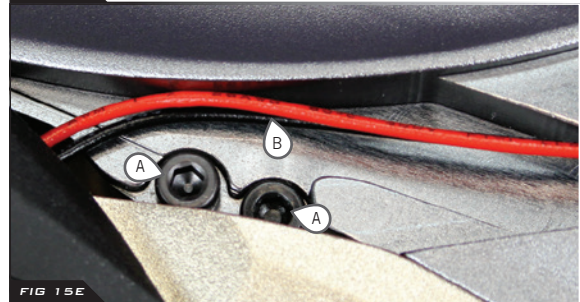

FIG 15E



FIG 15F

## THE SL4 INLINE REGULATOR ASSEMBLY

### ⚠ WARNING ⚠

DE-GAS YOUR MARKER, DISCHARGING ANY STORED GAS IN A SAFE DIRECTION, AND REMOVE THE BARREL, LOADER, AIR SYSTEM AND ANY PAINTBALLS TO MAKE THE MARKER EASIER AND SAFER TO WORK ON.

Unscrew and remove the gas pipe assembly from the SL4 inline regulator (SEE FIGURE 16A). See page 15 for more information on removing the gas pipe assembly.

Grip the SL4 inline regulator tightly through the rubber sleeve and unscrew the SL4 inline regulator from the LV1 body (SEE FIGURE 16B).

Pull the foregrip crown down to free it from the LV1 body (SEE FIGURE 16C).

Inspect the o-ring at the top of the threads on the FRM for damage (LABELLED A) FIGURE 16D). Replace and re-lubricate as necessary.<sup>1</sup>

Tip both the piston and spring out of the top of the inline regulator (SEE FIGURE 16E).

Insert a 1/8" hex key into the adjuster screw assembly in the bottom of the inline regulator, turn the adjuster screw clockwise through the inline regulator body (SEE FIGURE 16F & 16G), and push the adjuster assembly out of the top of the inline regulator body.<sup>2</sup>

Thoroughly clean the 011 NBR70 o-rings that sits on the outside of the adjuster assembly, then re-lubricate with Eclipse Grease (SEE FIGURE 16H).<sup>1</sup>

Using a dry cotton bud, clean the internal 008 NBR70 o-ring that sits inside the top section of the adjuster top. Then using a small hex key gently apply Eclipse Grease to the o-ring (SEE FIGURE 16I).<sup>1</sup>

<sup>1</sup>If any o-rings are damaged then replace them. Extra o-rings are available in parts kits available at [www.planetclipse.com](http://www.planetclipse.com)

<sup>2</sup>The adjuster screw can only be removed by turning it upwards through the bottom section of the inline regulator. The regulator will be damaged if the adjuster screw is removed incorrectly.



FIG 16A



FIG 16B



FIG 16C



FIG 16D



FIG 16E



FIG 16F



FIG 16G



FIG 16H

## (CONTINUED)

At this point if you are maintaining the inline regulator to fix a supercharging issue, turn to page 46 to the 'ADVANCED SL4 INLINE REGULATOR MAINTENANCE' section. If you are not fixing a supercharging issue then there is no need to perform this advanced maintenance procedure.

Inspect the internal sealing surfaces of the regulator body, removing any dirt or debris with a cotton bud (SEE FIGURE 16J).

Re-install the adjuster assembly into the inline regulator body threaded end first. Apply light pressure to the top of the adjuster, while using a 1/8" hex turn the adjuster screw counter-clockwise until it stops at the base of the inline regulator body (SEE FIGURE 16K).

Take the piston, inspect for damage and clean the 14x2 NBR70 o-ring at the top. Re-lubricate it with a light application of Eclipse Grease (SEE FIGURE 16L). Place the inline regulator spring over the piston, then insert the piston and spring into the top of the inline regulator body (SEE FIGURE 16M).<sup>1</sup>

Ensure that the tuning fork is pushed up into the LV1 body. The base of the fork should be slightly recessed inside the FRM (SEE FIGURE 16N).

To replace the foregrip crown, insert the locating tab into the frame (SEE FIGURE 16O), then push the front of the crown up and over the LPR cap.

Re-attach the inline regulator to the Ego LV1 FRM (SEE FIGURE 16P), then re-connect the gas pipe fitting (see page 15). Basic cleaning of the SL4 inline regulator is complete.

Reset the input pressure to the factory default. Set the adjuster screw to 3 turns in from flush with the bottom of the inline regulator. Then adjust to achieve the desired firing velocity from this setting.

<sup>1</sup>If any o-rings are damaged then replace them. Extra o-rings are available in parts kits available at [www.planeteclipse.com](http://www.planeteclipse.com)



**WARNING**

**IF YOU ARE UNSURE ABOUT PERFORMING A MAINTENANCE PROCEDURE PLEASE CONTACT YOUR NEAREST SERVICE CENTRE.**



FIG 16I



FIG 16J



FIG 16K



FIG 16L



FIG 16M



FIG 16N



FIG 16O



FIG 16P

## ADVANCED INLINE REGULATOR MAINTENANCE

### ⚠ WARNING ⚠

DE-GAS YOUR MARKER, DISCHARGING ANY STORED GAS IN A SAFE DIRECTION, AND REMOVE THE BARREL, LOADER, AIR SYSTEM AND ANY PAINTBALLS TO MAKE THE MARKER EASIER AND SAFER TO WORK ON.

This procedure is only required if you are fixing a supercharging SL4 inline regulator (common symptoms of supercharging are a very high velocity first shot and/or large variances in shot to shot consistency).

Place a 3/32" hex key through the adjuster top (SEE FIGURE 17A), then insert a 1/8" hex key into the bottom of the adjuster screw and carefully turn it counter-clockwise until the two parts begin to unscrew freely (SEE FIGURE 17B). With your fingers fully unscrew the two parts taking care not to lose any of the internal components (SEE FIGURE 17C).

Inside the adjuster screw you will find a regulator seal, purge poppet and spring (purge poppet assembly) (SEE FIGURE 17D). Inspect and clean the regulator seal, turning it over if one side appears excessively worn or damaged or replace if necessary. Inspect and clean the purge poppet or replace if necessary.

Place the purge poppet and attached spring in the central hole in the regulator seal, then insert these parts into the adjuster screw (SEE FIGURE 17E). Ensure it is re-installed correctly, failure to do so may seriously damage the Ego LV1 solenoid.

With the regulator seal, purge valve and spring installed back into the adjuster screw, replace the adjuster top (SEE FIGURE 17F). Screw the two parts tightly together using 1/8" and 3/32" hex keys. Refer to the 'CLEANING THE SL4 INLINE REGULATOR' section on pages 44-45 to re-assemble the SL4 inline regulator.

### ⚠ WARNING ⚠

IF YOU ARE UNSURE ABOUT PERFORMING A MAINTENANCE PROCEDURE PLEASE CONTACT YOUR NEAREST SERVICE CENTRE.



FIG 17A

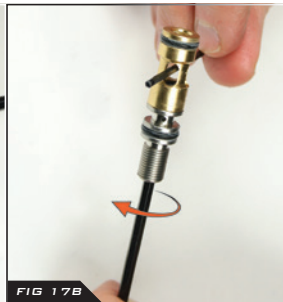

FIG 17B



FIG 17C

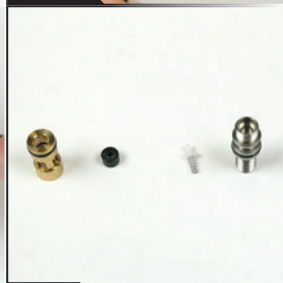

FIG 17D



FIG 17E

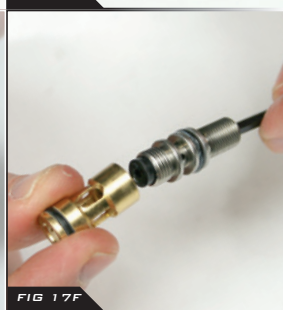

FIG 17F

## THE CURE 5 BOLT ASSEMBLY

### ⚠ WARNING ⚠

DE-GAS YOUR MARKER, DISCHARGING ANY STORED GAS IN A SAFE DIRECTION, AND REMOVE THE BARREL, LOADER, AIR SYSTEM AND ANY PAINTBALLS TO MAKE THE MARKER EASIER AND SAFER TO WORK ON.

Raise the bolt pin and remove the bolt assembly from the Ego LV1 marker body (FIGURE 18A).

Using a dry cotton bud remove any paint or grease from the surface of the bolt.

Lubricate the two bolt o-rings (LABELLED A FIGURE 18B) with a small drop of oil (SEE FIGURE 18C)<sup>1</sup>. Remove any excess oil from the surface of the bolt before re-installing the bolt assembly. Over-lubrication of the bolt may have adverse effects on performance.

Clean and inspect the rubber bolt tip (A) and Detent slots (B) on the bolt. If the bolt tip is heavily worn or damaged then remove and replace (FIGURE 18C). Lubricate the bolt tip with a few small drops of oil around the circumference of the bolt tip.

Replace the bolt assembly checking that the bolt is free to move and moves smoothly back and forth in the LV1 body. If there is any resistance or friction in the bolt movement then replace the two 14x2 o-rings and the rubber bolt tip.

Lock the bolt pin into the designated slot in the rammer using the front o-ring on the bolt as a position reference guide (LABELLED A FIGURE 18D).

INCORRECT LOCATION OF THE BOLT CAN SERIOUSLY DAMAGE THE BODY OF YOUR EGO LV1.

<sup>1</sup>We recommend the use of Eclipse Oil on the Ego LV1 rammer and bolt.

### ⚠ WARNING ⚠

IF YOU ARE UNSURE ABOUT PERFORMING A MAINTENANCE PROCEDURE PLEASE CONTACT YOUR NEAREST SERVICE CENTRE.



FIG 18A

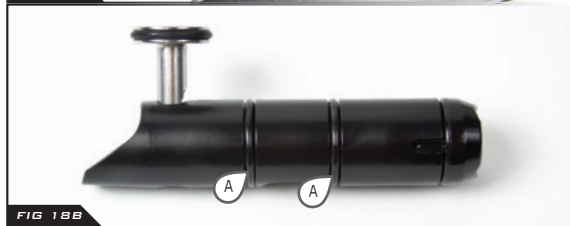

FIG 18B

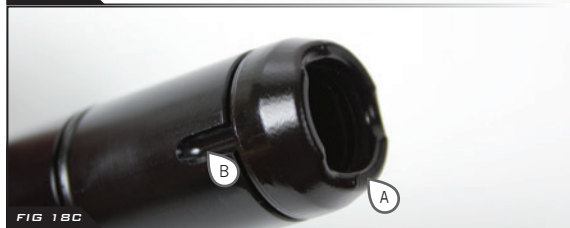

FIG 18C



FIG 18D

## THE ZICK3 RAMMER ASSEMBLY

### ⚠️ WARNING ⚠️

DE-GAS YOUR MARKER, DISCHARGING ANY STORED GAS IN A SAFE DIRECTION, AND REMOVE THE BARREL, LOADER, AIR SYSTEM AND ANY PAINTBALLS TO MAKE THE MARKER EASIER AND SAFER TO WORK ON.

Included with the Ego LV1 is a lightweight Zick3 rammer (LABELLED **A** FIGURE 19A), in addition to the standard Zick3 rammer installed in the marker (LABELLED **B** FIGURE 19A). The lightweight Zick3 rammer will provide an increase in shot efficiency at the cost of requiring a slightly higher valve operating pressure.

To install the lightweight Zick3 rammer follow the maintenance procedure below, swapping over to the lightweight rammer.

After installation, re-chronograph the Ego LV1 and adjust the SL4 inline regulator accordingly.

**ALWAYS CHECK THE SHOOTING VELOCITY OF THE EGO LV1 WITH A CHRONOGRAPH BEFORE USING THE MARKER.**

Pull the bolt pin upwards so that it disengages the rammer assembly, allowing the bolt to be removed via the rear of the Ego LV1 (SEE FIGURE 19B).

Using a 3/16" hex key, unscrew and remove the rammer cap at the rear of the Ego LV1 (SEE FIGURE 19C).

Raise the front of the Ego LV1 and tap the Ego LV1 onto your hand until the rammer falls into the palm of your hand (SEE FIGURE 19D).

Thoroughly clean the rammer shaft and all of its o-rings, replacing any o-rings which appear damaged or worn (LABELLED **A** FIGURE 19E). Lubricate all of the seals on the rammer shaft using Eclipse gun oil, do not use grease on the rammer as this may cause adverse performance effects.

*Replace any worn seals/bumpers using authentic Eclipse Ego LV1 spare parts. DO NOT use Eclipse Grease on the rammer. Only use light paintgun oil, we recommend Eclipse Oil.  
The number of o-rings on the rammer may vary according to the model of Ego LV1 that you have.*



FIG 19A



FIG 19B

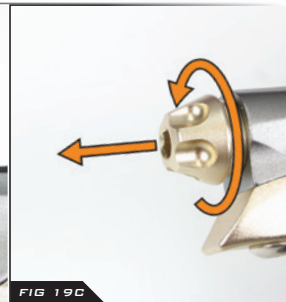

FIG 19C



FIG 19D



FIG 19E



## (CONTINUED)

Clean and inspect the rammer bumper inside the rammer cap (LABELLED **A** FIGURE 19F). If the face of the bumper is damaged or worn then the bumper can be flipped over to the reverse side and re-inserted. Using a pick or small hex key, carefully remove the rammer bumper from inside the rammer cap. If both sides are damaged or worn then replace with a new bumper. The bumper does not require lubrication.

Clean and inspect the o-ring on the outside of the rammer cap (LABELLED **B** FIGURE 19F), replacing if the o-ring is damaged. Inspect the internal surfaces of the rammer cap for debris or dirt, cleaning with a cotton bud if required.

Apply a small amount of grease to the external o-ring on the rammer cap.

Insert the rammer shaft into the LV1 body (SEE FIGURE 19G)

Screw the rammer cap back into the body by hand until it is finger tight (SEE FIGURE 19H).<sup>1</sup>

Using a hex key push the rammer shaft back into its rearward position (LABELLED **A** FIGURE 19I), replace the bolt and locate the bolt pin into the designated slot in the rammer shaft using the front o-ring on the bolt as a position reference guide (LABELLED **A** FIGURE 19J).

INCORRECT LOCATION OF THE BOLT CAN SERIOUSLY DAMAGE THE BODY OF YOUR EGO LV1.

<sup>1</sup>DO NOT over tighten the rammer cap.

### **⚠ WARNING ⚠**

**IF YOU ARE UNSURE ABOUT PERFORMING A MAINTENANCE PROCEDURE PLEASE CONTACT YOUR NEAREST SERVICE CENTRE.**

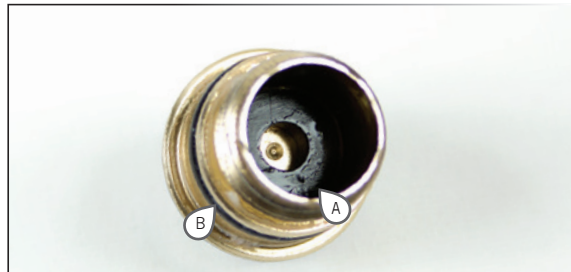

FIG 19F



FIG 19G

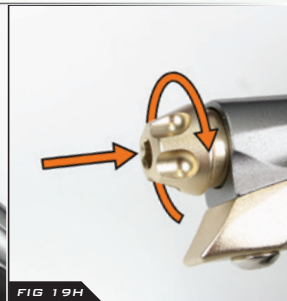

FIG 19H



FIG 19I



FIG 19J

## THE LOW PRESSURE REGULATOR ASSEMBLY

### ⚠ WARNING ⚠

DE-GAS YOUR MARKER, DISCHARGING ANY STORED GAS IN A SAFE DIRECTION, AND REMOVE THE BARREL, LOADER, AIR SYSTEM AND ANY PAINTBALLS TO MAKE THE MARKER EASIER AND SAFER TO WORK ON.

Remove the SL4 inline regulator and foregrip crown as detailed on page 44.

Push and hold the front of the LPR assembly and the valve plug back into the LV1 body (SEE FIGURE 20A). While continuing to do this, pull the tuning fork out of the LV1 body (SEE FIGURE 20B).

Pull the valve plug with attached valve stem out of the LV1 body (SEE FIGURE 20C) then remove the LPR body assembly (SEE FIGURE 20D).

Tip the spring and piston out of the LPR bore (SEE FIGURE 20E) if the LPR piston is held in place by grease stiction, use some needle-nose pliers to grip the piston and pull it out of the body. Be careful not to damage the piston tip when doing this).

Clean and inspect the O13 NBR70 o-ring on the LPR piston, re-lubricating with a thin layer of grease or replacing if damaged (LABELLED **A** FIGURE 20F). Next clean and inspect the piston tip (LABELLED **B** FIGURE 20F), if the tip is damaged replace the piston. Remove any excess grease on the piston, over lubrication of the LPR assembly can cause adverse effects on performance of the LPR.

Unscrew the LPR cap from the LPR body (SEE FIGURE 20G). Clean and inspect the internal (LABELLED **A** FIGURE 20H) and external o-rings (LABELLED **B** FIGURE 20H) on the LPR body, replacing if necessary. Lubricate both with a small amount of grease, using a small hex key to gently apply grease to the internal o-ring.



FIG 20A



FIG 20B



FIG 20C

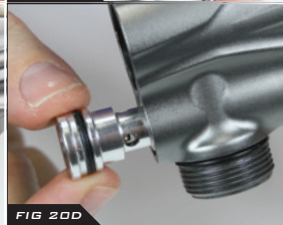

FIG 20D



FIG 20E

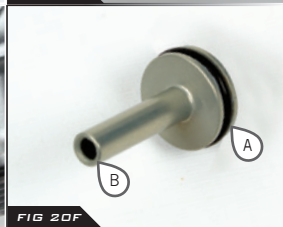

FIG 20F



FIG 20G



FIG 20H

## (CONTINUED)

Screw the LPR adjuster out from the LPR cap using a 1/8" hex key (SEE FIGURE 20I). Clean and inspect the adjuster o-ring (LABELLED A FIGURE 20J), replacing if necessary. Lubricate the o-ring with a small amount of grease.

Clean and inspect the LPR seal in the tip of the adjuster (LABELLED B FIGURE 20J). If the seal is damaged or heavily worn, pull the tip off the adjuster and replace.

Lastly clean and inspect the o-rings on the LPR cap (SEE FIGURE 20K). If the large outside o-ring (A) is damaged replace, otherwise apply a small amount of grease.

Insert the LPR adjuster into the LPR cap. Using a 1/8" hex key screw the adjuster all the way out until the adjuster stops turning (SEE FIGURE 20L).

Screw the LPR cap with LPR adjuster onto the LPR body. Place the spring over the LPR piston and push the piston into the LPR body (SEE FIGURE 20M).

Take the complete LPR assembly and push the assembly into the LPR bore of the LV1 body (SEE FIGURE 20N).

Re-insert the valve plug with attached valve stem (LABELLED A FIGURE 20O) ensuring the valve stem captures the valve spring (LABELLED B FIGURE 20O) inside the Ego LV1 body.

Push and hold the valve plug firmly up to the LV1 body, take the tuning fork and insert it into the FRM positioning the forks either side of the LPR body. Push the fork up into the body until the tips of the fork stop against the inside of the body (SEE FIGURE 20P). Replace the foregrip crown and regulator as detained on page 45.

Finally reset the LPR to the factory setting by firstly using a 1/8" hex key to screw the adjuster clockwise until a small amount of resistance is met and then by screw the adjuster counter-clockwise 1 full turn.

<sup>1</sup>The internals of your LPR may vary according to the model of Ego LV1 you have.

<sup>2</sup>The adjuster screw does not need to be removed from the LPR Cap for regular maintenance.



### WARNING

IF YOU ARE UNSURE ABOUT PERFORMING A MAINTENANCE PROCEDURE PLEASE CONTACT YOUR NEAREST SERVICE CENTRE.



FIG 20I



FIG 20J



FIG 20K

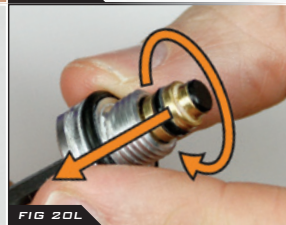

FIG 20L



FIG 20M



FIG 20N

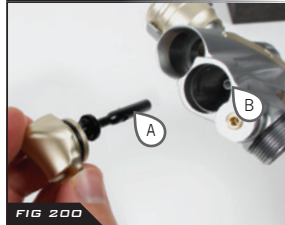

FIG 20O



FIG 20P

## REMOVING THE FRAME

### ⚠ WARNING ⚠

DE-GAS YOUR MARKER, DISCHARGING ANY STORED GAS IN A SAFE DIRECTION, AND REMOVE THE BARREL, LOADER, AIR SYSTEM AND ANY PAINTBALLS TO MAKE THE MARKER EASIER AND SAFER TO WORK ON.

Disconnect the gas pipe from the frame (page 15). Using a 5/64" hex key remove the four screws that attach the Ego LV1 rubber grips to the Ego LV1 frame (SEE FIGURE 21A). Unplug the solenoid and BBSS wires from their sockets on the Ego LV1 circuit board (SEE FIGURE 21B).

Using a 1/8" hex key undo the two frame screws (SEE FIGURE 21C) and remove the frame from the Ego LV1 body, taking care not to damage any wires or the solenoid assembly (SEE FIGURE 21D).

You have now removed the frame.

## ATTACHING THE FRAME

Carefully thread the solenoid and BBSS wires through the access holes in the top of the Ego LV1 frame (SEE FIGURE 22A). Making sure that the BBSS and solenoid wires are not trapped between the frame and body, re-attach the frame to the Ego LV1 body by tightening the two frame screws using a 1/8" hex key (SEE FIGURE 22B).

Ensure that the BBSS cables lie neatly in the slots provided for them in the frame and re-connect the solenoid and the BBSS using relevant sockets on the Ego LV1 circuit board (SEE FIGURE 22C).

Adjust both the solenoid and BBSS wires so that they sit neatly within the frame, making sure the wires do not interfere with the OPTO sensors or micro-switch (SEE FIGURE 22D).

Re-attach the Ego LV1 rubber grips to the frame by using a 5/64" hex key to replace the four grip screws.

Reinstall the gas pipe assembly. See page 15.

### ⚠ WARNING ⚠

IF YOU ARE UNSURE ABOUT PERFORMING A MAINTENANCE PROCEDURE PLEASE CONTACT YOUR NEAREST SERVICE CENTRE.



FIG 21A

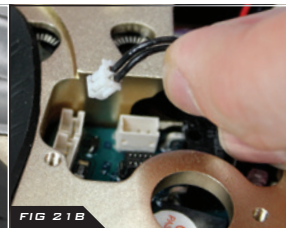

FIG 21B



FIG 21C



FIG 21D



FIG 22A



FIG 22B



FIG 22C



FIG 22D

## THE CAM-LEVER ASSEMBLY

### ⚠ WARNING ⚠

DE-GAS YOUR MARKER, DISCHARGING ANY STORED GAS IN A SAFE DIRECTION, AND REMOVE THE BARREL, LOADER, AIR SYSTEM AND ANY PAINTBALLS TO MAKE THE MARKER EASIER AND SAFER TO WORK ON.

With the frame removed, remove both the eye covers (see page 42) to expose the cam carrier retaining screws.

Using a 5/64" hex key remove the four retaining screws to release the cam lever assembly from the body (SEE FIGURE 23A).

Remove the cam-lever assembly from the Ego LV1 body (SEE FIGURE 23B). Slide the cam axle out of the carrier, allowing the lever to be removed.

Clean any dirt or paint off the lever, axle and carrier (SEE FIGURE 23C). Inspect the lever for any excessive wear on the contact surfaces.

Align the holes in the cam lever with those on the cam carrier (SEE FIGURE 24D). Slide the cam axle into the cam carrier. The lever must be installed the correct way facing the rammer in order to function. The diagram in figure 23E illustrates the orientation in which to install the lever in relation to the rammer and exhaust valve.

With the lever pointing into the LV1 body, insert the cam assembly vertically. Then flip the screw end down into the body (SEE FIGURE 23F).

Check that the holes in the cam carrier and body are all aligned before reinserting the retaining screws. Use a 5/64" hex key to tighten the four retaining screws (SEE FIGURE 23G).

DO NOT over tighten the retaining screws.

### ⚠ WARNING ⚠

IF YOU ARE UNSURE ABOUT PERFORMING A MAINTENANCE PROCEDURE PLEASE CONTACT YOUR NEAREST SERVICE CENTRE.



FIG 23A



FIG 23B



FIG 23C



FIG 23D

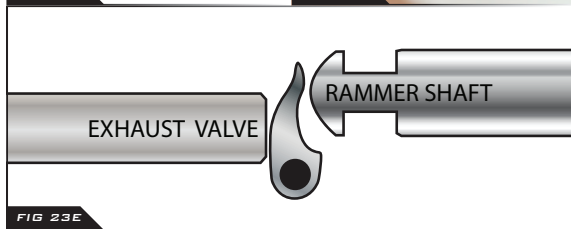

FIG 23E

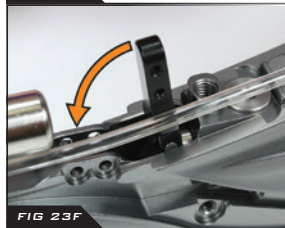

FIG 23F



FIG 23G

## THE TRIGGER ASSEMBLY

### ⚠ WARNING ⚠

DE-GAS YOUR MARKER, DISCHARGING ANY STORED GAS IN A SAFE DIRECTION, AND REMOVE THE BARREL, LOADER, AIR SYSTEM AND ANY PAINTBALLS TO MAKE THE MARKER EASIER AND SAFER TO WORK ON.

Having removed the frame completely from the Ego LV1 body (see page 52). Unscrew the two M2.5x5 retaining screws which hold the bearing carrier in the frame (SEE FIGURE 24A).

Gently lift the bearing carrier and trigger assembly free from the frame taking care not to damage the micro-switch or the OPTO sensors (SEE FIGURE 24B).

Remove the trigger spring from the bearing carrier, removing any paint or moisture (SEE FIGURE 24C).

Using a 1/16" hex key, loosen the trigger pin retaining set screw from the back of the trigger (SEE FIGURE 24D).

Use a small hex key to push the trigger pin out of the bearing carrier from one side (SEE FIGURE 24E), then remove the bearing carrier from the trigger (SEE FIGURE 24F).

Clean the trigger and bearing carrier thoroughly and also clean the space within the frame that the trigger sits in.



FIG 24A

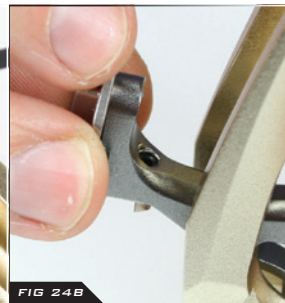

FIG 24B



FIG 24C

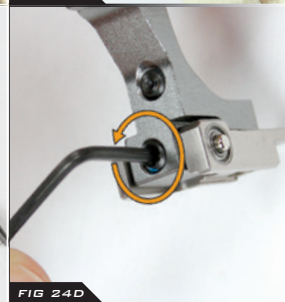

FIG 24D



FIG 24E



FIG 24F

## (CONTINUED)

Position the trigger so that the hole through the trigger lines up with the holes in the bearing carrier, slide the trigger pin into place (SEE FIGURE 24G).

Gently lower the trigger assembly and bearing carrier into the frame, taking care not to damage the micro-switch or the OPTO sensor, and ensuring that the trigger is positioned correctly (SEE FIGURE 24H).

Using a 5/64" hex key screw the right side M2.5x5 retaining screw into place but do not fully tighten it into place (SEE FIGURE 24I).

Ensure the trigger moves freely within the frame, then using a 1/16" hex key tighten down the trigger pin retaining set screw.

Place the trigger spring over the bearing carrier in its designated groove, align the hole in the trigger spring with the front/left hole in the bearing carrier, then screw the retaining screw into the frame. Tighten both screws with a 5/64" hex key (SEE FIGURE 24J).

**DO NOT OVERTIGHTEN THE RETAINING SCREWS. DOING SO MAY DAMAGE THE TRIGGER SPRING AND THREADS IN THE FRAME.**

You have now stripped and cleaned your Ego LV1 trigger assembly.



FIG 24G

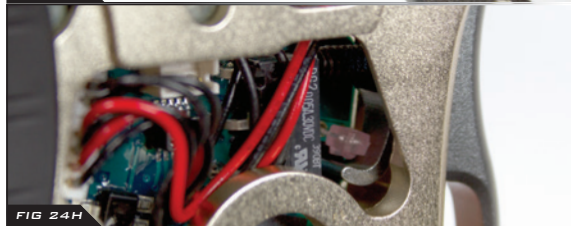

FIG 24H



FIG 24I

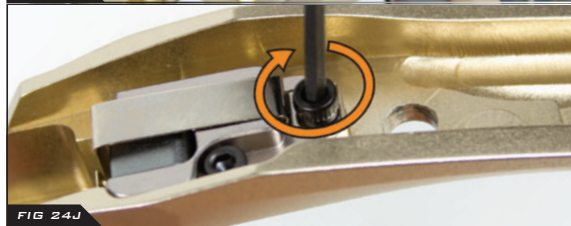

FIG 24J

### ⚠ WARNING ⚠

**IF YOU ARE UNSURE ABOUT PERFORMING A MAINTENANCE PROCEDURE PLEASE CONTACT YOUR NEAREST SERVICE CENTRE.**

## REPLACING A DAMAGED VALVE ASSEMBLY

### ⚠ WARNING ⚠

DE-GAS YOUR MARKER, DISCHARGING ANY STORED GAS IN A SAFE DIRECTION, AND REMOVE THE BARREL, LOADER, AIR SYSTEM AND ANY PAINTBALLS TO MAKE THE MARKER EASIER AND SAFER TO WORK ON.

THE VALVE GUIDE SHOULD ONLY BE REMOVED IF THE VALVE GUIDE IS DAMAGE, CAUSING A LEAK DOWN THE BARREL, FEED TUBE OR RAMMER SLOT. THE VALVE GUIDE DOES NOT NEED TO BE REMOVED FOR GENERAL MAINTENANCE.

Lift the bolt pin and slide the bolt assembly out of the rear of the marker (SEE FIGURE 25A). Disconnect the gas pipe and unscrew the inline regulator from the FRM as detailed in the SL4 inline regulator section of this maintenance guide (page 44). Pull the foregrip crown off the LV1 body (SEE FIGURE 25B).

Push and hold the front of the LPR assembly and the valve plug back into the LV1 body (SEE FIGURE 25C). While continuing to do this, pull the tuning fork out of the LV1 body (SEE FIGURE 25D).

Remove the valve plug with attached valve stem from the LV1 body (SEE FIGURE 25E). Then carefully tip the exhaust valve and spring out (SEE FIGURE 25F).



FIG 25A



FIG 25B



FIG 25C



FIG 25D



FIG 25E



FIG 25F



## (CONTINUED)

Ensure that the rammer is in its rear position and taking an L-shaped hex key, place it down through the bolt pin slot in the top of the body so that you can apply light pressure to the cam lever to pop the valve guide out of its place in the Ego LV1 body (SEE FIGURE 25G).

Inspect the sealing face of both the exhaust valve (LABELLED **A** FIGURE 25H) and valve guide (LABELLED **A** FIGURE 25I) for any excessive wear or damage. If either the exhaust valve or the valve guide are damaged/scratched then replace with authentic Ego LV1 parts.

Lubricate the o-ring on the valve guide (LABELLED **B** FIGURE 25I).

Lubricate the o-ring on the valve plug (LABELLED **A** FIGURE 25J).

Place the exhaust valve in the valve guide, making sure that the sealing faces are next to each other (SEE FIGURE 25K), and place the valve spring over the end of the exhaust valve and then place this sub-assembly into the valve stem (SEE FIGURE 25L).

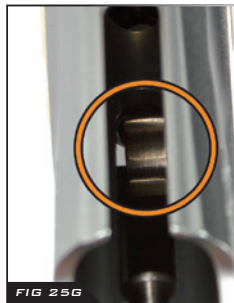

FIG 25G



FIG 25H

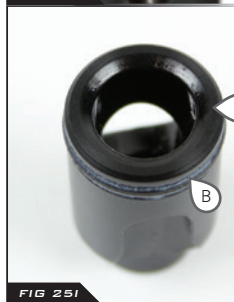

FIG 25I

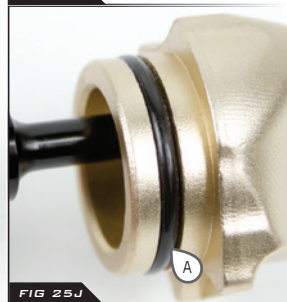

FIG 25J



FIG 25K

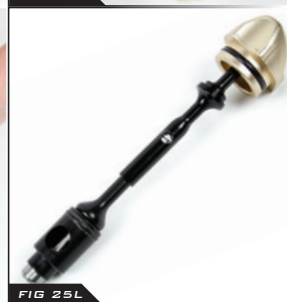

FIG 25L

## (CONTINUED)

Ensure the LPR assembly is still correctly in place in the body (SEE FIGURE 25M).

Make sure the exhaust hole in the valve guide is pointed directly upwards and the lip on the valve plug is pointed downwards (SEE FIGURE 25N). Then slide the entire valve guide, exhaust valve, valve stem and valve plug into the body.

Ensure the valve guide is fully inserted into the LV1 body.

Push and hold the valve plug firmly up to the LV1 body (SEE FIGURE 25O), take the tuning fork and insert it into the FRM positioning the forks either side the LPR body. Push the fork up into the body until the tips of the fork stop against the inside of the body and the base of the tuning fork is flush with the threads on the FRM (SEE FIGURE 25P).

You have now successfully stripped and cleaned your Ego LV1 valve assembly. See page 45 on how to attach the SL4 inline regulator.



FIG 25M

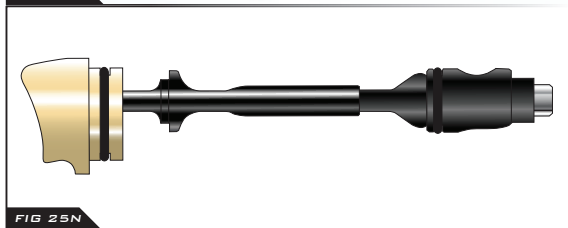

FIG 25N

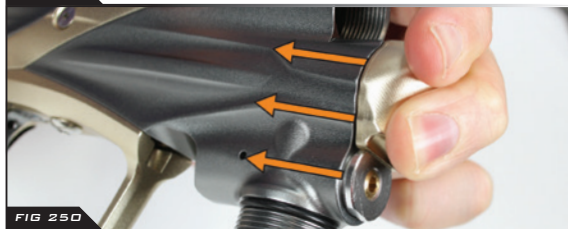

FIG 25O



FIG 25P

### ⚠ WARNING ⚠

IF YOU ARE UNSURE ABOUT PERFORMING A MAINTENANCE PROCEDURE PLEASE CONTACT YOUR NEAREST SERVICE CENTRE.

## THE SOLENOID MANIFOLD

### ⚠ WARNING ⚠

DE-GAS YOUR MARKER, DISCHARGING ANY STORED GAS IN A SAFE DIRECTION, AND REMOVE THE BARREL, LOADER, AIR SYSTEM AND ANY PAINTBALLS TO MAKE THE MARKER EASIER AND SAFER TO WORK ON.

THERE IS **NO** NEED TO REMOVE THE SOLENOID VALVE OR MANIFOLD FOR ANY KIND OF REGULAR MAINTENANCE. THERE ARE **NO** SERVICEABLE PARTS WITHIN THE SOLENOID VALVE OR MANIFOLD THAT REQUIRE MAINTENANCE.

With the frame separated from the Ego LV1 body and the solenoid and BBSS wires unplugged from the circuit board (see page 52) use a small flat headed screw driver to undo and remove the two screws that hold the solenoid valve onto the solenoid manifold (SEE FIGURE 26A).

After removing the solenoid valve, the three retaining screws which hold the solenoid manifold onto the Ego LV1 body will be accessible. Remove these using a 5/64" hex key (SEE FIGURE 26B).

With the solenoid manifold completely removed from the Ego LV1 body the bottom of the Ego LV1 body should now resemble FIGURE 26C. Ensure that the air transfer holes in the bottom of the body are free from contamination from any dirt, debris, paint or moisture and clear away any excess grease if it appears to be blocking any of the air transfer holes.

Check the top face of the solenoid manifold to ensure that it is free from damage or debris (SEE FIGURE 26D). Remove, clean and inspect the manifold rubber gasket as shown in FIGURE 26E. Replace the gasket ensuring that it lies flat in its designated groove in the solenoid manifold body (SEE FIGURE 26D).<sup>1</sup>

<sup>1</sup>Replace any worn/damaged seals using authentic Eclipse Ego LV1 spare parts.



FIG 26A



FIG 26B



FIG 26C



FIG 26D

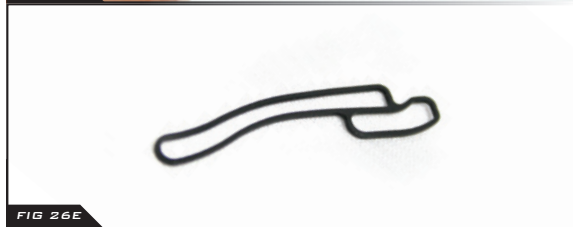

FIG 26E

## (CONTINUED)

Check the bottom face of the solenoid manifold to ensure that it is also free from damage or debris (SEE FIGURE 26F). Remove, clean and inspect the solenoid rubber gasket as shown in FIGURE 26G. Replace the gasket ensuring that it lies flat in its designated groove in the solenoid manifold body (SEE FIGURE 26F).<sup>1</sup>

Inspect and clean the solenoid valve, removing any moisture, dirt and debris, paying particular attention to the top sealing surface and exhaust ports (SEE FIGURE 26H).

**DO NOT ATTEMPT TO DISASSEMBLE THE SOLENOID VALVE UNIT OR THE USER WARRANTY WILL BE VOID.**

Hold the solenoid manifold onto the bottom of the Ego LV1 body taking care to line it up correctly with the screw holes in the body and to avoid pinching the BBSS wires underneath it. Use a 5/64" hex key to tighten the three screws that hold the solenoid manifold onto the Ego LV1 body (SEE FIGURE 26I).<sup>1</sup>

**DO NOT** over tighten the retaining screws for the manifold or solenoid. Doing so can crack the manifold.

Hold the solenoid valve onto the bottom face of the solenoid manifold ensuring the small solenoid rubber gasket is still in place, line up the two screw holes. Screw the solenoid retaining screws into the solenoid manifold (SEE FIGURE 26J).<sup>2</sup>

You have now successfully stripped and cleaned your Ego LV1 solenoid assembly.

<sup>1</sup>Replace any worn/damaged seals using authentic Eclipse Ego LV1 spare parts.

<sup>2</sup>DO NOT over tighten retaining screws, doing so may strip the threads or damage the part being retained.



**IF YOU ARE UNSURE ABOUT PERFORMING A MAINTENANCE PROCEDURE PLEASE CONTACT YOUR NEAREST SERVICE CENTRE.**



FIG 26F



FIG 26G

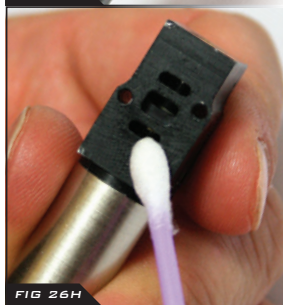

FIG 26H



FIG 26I

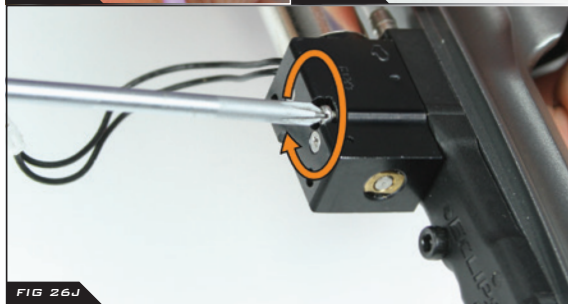

FIG 26J

## THE SOLENOID VALVE

The Ego LV1 solenoid valve (SEE FIGURE 27a) is **Non-Serviceable** unlike some previous Planet Eclipse marker solenoid valves. Any attempt to strip, service or modify the Ego LV1 solenoid valve will immediately void your warranty.

If you experience any issue with your Ego LV1 solenoid valve then please contact your nearest Eclipse Service Centre for details on replacement solenoid valves.

See page 68 for Eclipse Service Centre details.



FIG 27A

## THE PUSH ON PURGE SYSTEM

### ⚠ WARNING ⚠

DE-GAS YOUR MARKER, DISCHARGING ANY STORED GAS IN A SAFE DIRECTION, AND REMOVE THE BARREL, LOADER, AIR SYSTEM AND ANY PAINTBALLS TO MAKE THE MARKER EASIER AND SAFER TO WORK ON.

THERE IS NO NEED TO REMOVE THE POPS FROM THE EGO LV1 FRAME FOR GENERAL MAINTENANCE. IF THE POPS IS REMOVED, ENSURE THE O-RING IS CORRECTLY SEATED BEFORE POPS RE-ATTACHMENT.

Fully depress the latch button then slide the bonnet forward while continuing to depress latch button (SEE FIGURE 28A).

When the bonnet is in the forward position (SEE FIGURE 28B) remove the latch button and spring from the bonnet (SEE FIGURE 28C) then slide the bonnet off the POPS body (SEE FIGURE 28D). Be careful not to lose the spring.

Carefully slide the push rod out from either side of the POPS body, taking care not to lose the two o-rings on the push rod (SEE FIGURE 28E).

Clean off any dirt, debris or moisture from the bonnet, the POPS body and the latch button (SEE FIGURE 28F).

Remove the POPS insert assembly using a 5/32" hex key (SEE FIGURE 28G). Remove the POPS pin from the POPS Insert.

Clean and check the condition of the 007 NBR70 o-ring on the outside of the POPS insert, replacing as necessary (SEE FIGURE 28H).



FIG 28A



FIG 28B



FIG 28C



FIG 28D



FIG 28E



FIG 28F



FIG 28G



FIG 28H

## (CONTINUED)

Clean and check the condition of the single internal 005 NBR90 o-ring in the front of the POPS insert, replace if necessary (SEE FIGURE 28I). Lubricate this o-ring liberally using Eclipse grease.

Lubricate the narrow end of the POPS pin with a smear of Eclipse grease and push the pin, narrow end first, into the POPS insert so that it sits in the POPS insert and pokes through to the front (SEE FIGURES 28J & 28K).

Screw the POPS insert back into the POPS body ensuring that the o-ring end goes in first (SEE FIGURE 28G).

Replace the push rod into its designated slot (SEE FIGURE 28L), then slide a 004 NBR70 o-rings on both ends of the push rod. Make sure the push rod is centred in the POPS body (SEE FIGURE 28M).

Slide the bonnet over the POPS body and align the hole on the bonnet with the front hole on the POPS body (SEE FIGURE 28N).

Ensure the spring is on the latch button then slide them both into the POPS body through the hole in the bonnet, spring end first, making sure the latch button pokes out the right side of the bonnet (SEE FIGURE 28O).

Push the button down as far as it will go, then (while still holding down the button) slide the bonnet back until the button engages with the POPS body and cannot slide into the forward position (SEE FIGURE 28P).

You have now successfully cleaned and maintained the Push On Purge System.



FIG 28I



FIG 28J



FIG 28K



FIG 28L



FIG 28M



FIG 28N



FIG 28O



FIG 28P

### ⚠ WARNING ⚠

IF YOU ARE UNSURE ABOUT PERFORMING A MAINTENANCE PROCEDURE PLEASE CONTACT YOUR NEAREST SERVICE CENTRE.

The Fault Finding guide covers common symptoms, causes and solutions that are likely to be encountered by the average user. If a issue with the Ego LV1 cannot be solved using the Fault Finding guide, contact your nearest Eclipse Service Centre for assistance.

SYMPTOM	POSSIBLE CAUSE	SOLUTION
Although a new battery has been fitted, the Ego LV1 will not switch on.	The battery has been fitted incorrectly.	Fit the battery correctly with the positive terminal nearest to the side of the frame.
	The battery has drained on the shelf.	Replace with another battery.
	The battery terminals are not making proper contact with the battery.	Remove the battery, gently bend the terminals towards where the battery will sit and then replace the battery.
The battery does not seem to last very long.	The battery type is of a low quality.	Use an fresh alkaline or lithium battery. Do not use a low quality or rechargeable battery.
The Ego LV1 leaks from the solenoid and/or manifold.	Either of the two gaskets are damaged and/or not seated correctly in its designated pocket in the manifold body.	Ensure the gasket is seated correctly. Replace the gasket if damaged using Ego LV1 parts kit.
	Solenoid valve and/or manifold is over-pressurising.	Check the LPR output pressure. Adjust accordingly. Clean and inspect the LPR assembly paying particular attention to the piston o-ring, piston tip and rubber seal. Replace damaged components as necessary.
	Damaged or incorrect seals on rammer.	Replace seals.
	Damaged manifold inlet barb or low pressure hose	Check Low Pressure Hose for cuts or replace barb.
	Damaged Ego LV1 solenoid valve.	Replace Ego LV1 solenoid valve.
The Ego LV1 leaks down the barrel.	Damaged exhaust valve.	Replace exhaust valve.
	Damaged valve guide.	Replace valve guide and o-rings.
	Incorrect o-ring on the valve guide.	Replace front o-ring on valve guide with a new 013 NBR70 o-ring
Gas vents quickly down barrel as soon as the Ego LV1 is gassed up.	The exhaust valve has become jammed in the valve guide.	Replace exhaust valve and valve guide as necessary (see Maintenance section).
The Ego LV1 fires but the bolt doesn't move.	The bolt pin is not located in rammer correctly.	Lift bolt pin and line up with position of rammer correctly (See Maintenance section).



SYMPTOM	POSSIBLE CAUSE	SOLUTION
Low rate of fire / rate of fire not reaching the ROF cap.	The rear solenoid flow restrictor (SFR) is set too low.	Set the rear SFR to it factory level. (See page 6)
	The force setting of the loader is too low.	Adjust the loader force feed setting.
The marker is chopping or trapping paint.	The paint is of a poor quality.	Try a higher quality of paint.
	The BBSS is switched off.	Switch on the BBSS.
	The bolt is dirty, causing the BBSS to incorrectly detect a paintball.	Clean the bolt and breach.
	The BBSS is dirty causing the incorrect detection of paintballs.	Clean the BBSS.
	Incorrectly seated rubber bolt tip.	Re-seat the rubber bolt tip.
	Damaged rubber bolt tip	Replace the rubber bolt tip.
The Ego LV1 does not fire.	The POPS is not fully engaged.	Push the POPS bonnet back until the unit engages.
	The solenoid flow restrictors (SFRs) are set too low.	Set the SFRs to their factory levels. (See page 6)
	The battery quality or charge level is very low.	Install new high quality alkaline battery.
	The battery is flat.	Replace the battery.
	The training mode is enabled.	Disable training mode.
	The dwell parameter is set too low.	Increase the dwell parameter.
	The trigger is set up incorrectly.	Set trigger up correctly. (See Advanced Set-Up Section)
	The solenoid is not plugged into the Ego LV1 PCB.	Plug solenoid wire into port on the Ego LV1 PCB.
	The BBSS is enabled but there is no paint in the breach.	Fill loader with paint.
	The OPTO sensor/micro-switch is not being activated.	Adjust trigger screws accordingly.
	The PCB is damaged.	Replace PCB.
The solenoid valve is damaged.	Replace solenoid valve.	
Low constant velocity.	The SL4 regulator output pressure set too low.	Increase the output pressure of the SL4 regulator.

SYMPTOM	POSSIBLE CAUSE	SOLUTION
Low constant velocity.	The LPR is set too low.	Increase the output pressure of the LPR (see page 18).
	The solenoid flow restrictor (SFR) B is set too low.	Set SFR B to level 6-7.
	The cam-lever has been re-installed incorrectly.	Strip down and re-install the cam-lever assembly correctly.
Low velocity first shot.	The FSD comp parameter is too low to overcome stiction on solenoid and / or rammer o-rings.	Increase FSD comp parameter.
High velocity first shot.	The FSD comp parameter is set too high.	Reduce FSD comp parameter.
	The inline regulator pressure is creeping.	Strip and clean the inline regulator replacing the piston seal if necessary.
	The LPR pressure is creeping.	Strip and clean the LPR replacing the piston seal if necessary.
Velocity drop-off during rapid fire.	The battery quality or charge level is low.	Install a new high quality alkaline battery.
	The solenoid flow restrictor set too low.	Increase the SFR settings to factory default.
	The air system regulator does not have a high enough flow to keep up.	Try another air system.
	Dirty/partially blocked SL4 regulator.	Strip, clean, lubricate and rebuild the SL4 regulator. (see page 44-45)
The trigger is very "bouncy".	Incorrect filter settings.	Check that your trigger filter and debounce settings suit your trigger set-up.
	The trigger pull is too short and the return strength is too low.	Refer to Advanced Set-Up section for guidelines of how to adjust your Ego LV1 trigger accordingly.
The BBSS does not appear to be reading correctly.	The break beam sensor system is dirty.	Keep the break beam sensors clean to ensure correct readings (See Maintenance Section).
The BBSS is not reading at all.	The break beam sensors are the wrong way around.	Check that the red receiver is on the right-hand side of the breech.
	There is a broken wire or contact, or a short circuit on either of the breech sensor cables.	Check the plug of the cables.
		Check for cuts or pinches in the sensor cables.
Either sensor is back to front.	Check that the sensors face each other when installed.	

SYMPTOM	POSSIBLE CAUSE	SOLUTION
BBSS turns itself off after firing and the display shows the BBSS fault icon in the top right.	The sensor is dirty.	Clean the BBSS.
	The sensor is faulty.	Replace the BBSS.
	The sensor is out of place.	Re-Install BBSS. Check alignment.
Two or more balls are being fed into the breech.	Worn/damaged Detents.	Change the rubber Detent.
	The feed force too high from loader.	Adjust loader settings/use lower force loader.
Ego LV1 is inconsistent.	The inline regulator is supercharging.	Strip and clean inline regulator, replacing SL4 regulator seal.
	The dwell is too low.	Increase the dwell parameter.
	The front SFR is set too low.	Increase the front SFR setting.
	Poor quality paintballs.	Use better quality paintballs.
	Poor paintball size to barrel bore match.	Use a closer paintball to barrel bore size.
	Inconsistent air supply from air system.	Use a good quality air system.
Ego LV1 is inefficient	The dwell is excessively high	Reduce the dwell.
	LPR is set too high.	Reduce LPR output pressure.
	Poor paintball size to barrel bore match	Use a closer paintball to barrel bore size.
Low rate of fire	The rear SFR is set too low	Increase the rear SFR setting.
Leaking rammer assembly (Leak gets louder when bolt is removed).	The front rammer shaft o-ring deteriorated.	Replace the front rammer shaft o-ring.
When the Ego LV1 powers up, no game timer / shot counter / ROF indicator is displayed and the gun will not fire.	The trigger is permanently depressed.	Turn the front stop set screw in the top of the trigger counter-clockwise until the display reads correctly. If there is sufficient trigger adjustment then turn the return force set screw counter-clockwise also.
The Ego LV1 leaks out of the LPR body vent hole (small hole behind the fore grip crown on the LV1 body).	The LPR piston o-ring or either of the two LPR body o-rings are damaged or dirty.	Clean and inspect the o-rings. Replace if damaged.

**The Fault Finding guide covers common symptoms, causes and solutions that are likely to be encountered by the average user. If a issue with the Ego LV1 cannot be solved using the Fault Finding guide, contact your nearest Eclipse Service Centre for assistance.**

## ECLIPSE SERVICE CENTRES

Are you unsure of where to send your Ego LV1 to be repaired or serviced? If your local Eclipse dealer can't assist you, why not contact your nearest certified Eclipse Service Centre and arrange for them to undertake any work that you require.

A map listing all of our Service Centres and their contact details can be found in the SUPPORT section of the Planet Eclipse web site at

[WWW.PLANETECLIPSE.COM/SITE/SERVICE-CENTRES](http://WWW.PLANETECLIPSE.COM/SITE/SERVICE-CENTRES)

For any Technical Support or Customer Service enquiries please ensure that you have registered your product (where applicable) using the Warranty Card in this manual or online prior to contacting the appropriate representative in your region.

## EGO LV1 OPERATIONAL OVERVIEW

Below is a brief overview of what happens during the Ego LV1 firing cycle. The location of parts discussed in the text below can be found on pages 70-71.

Assuming the Ego LV1 is gassed up and turned on, *FIGURE 29A* shows the marker in its idle position. The rammer is held in its rear position with pressurised gas from the LPR directed through the solenoid to the front of the rammer. The valve chamber is full of pressurised gas from the inline regulator.

Providing a ball is in the breach, when the trigger is pulled, a signal is sent to the solenoid which redirects the supply of gas from the front of the rammer to the rear, which pushes the rammer and bolt forward toward the valve lever (*FIGURE 29B*). As this happens the gas in front of the rammer is vented out through an exhaust port in the solenoid valve.

The rammer makes contact with the valve lever and continues to be pushed forward, now pushing the exhaust valve forward with it. This opens the exhaust valve allowing pressurised gas to flow up through the valve guide and into the bolt and vent down the barrel, propelling the ball (*SEE FIGURE 29C*).

The time that the rammer is held in this forward position is dependant on the dwell parameter. The longer this dwell time the longer the Ego LV1 vents gas down the barrel. When this dwell time has elapsed, the solenoid redirects the supply of gas from the back of the rammer to the front, pushing the rammer and bolt back to the rear position. This loss of forward force allows the exhaust valve to re-seal and the valve chamber is re-pressurised. The valve lever is pushed back into position by the exhaust valve closing. As the rammer moves back, the gas behind it is vented through an exhaust port in the solenoid valve (*SEE FIGURE 29D*).

The Ego LV1 has now completed a full cycle.

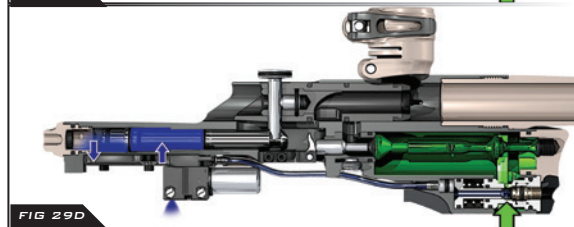
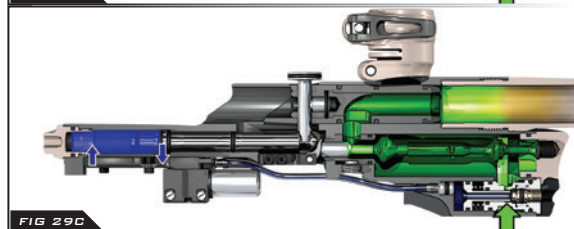
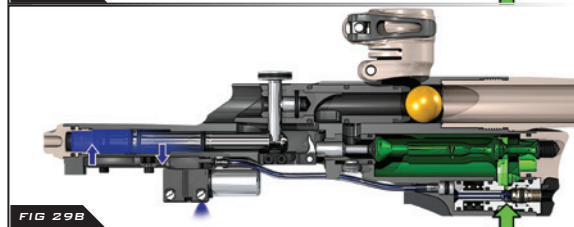
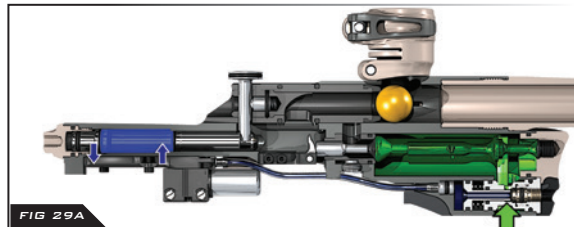

# PARTS LIST

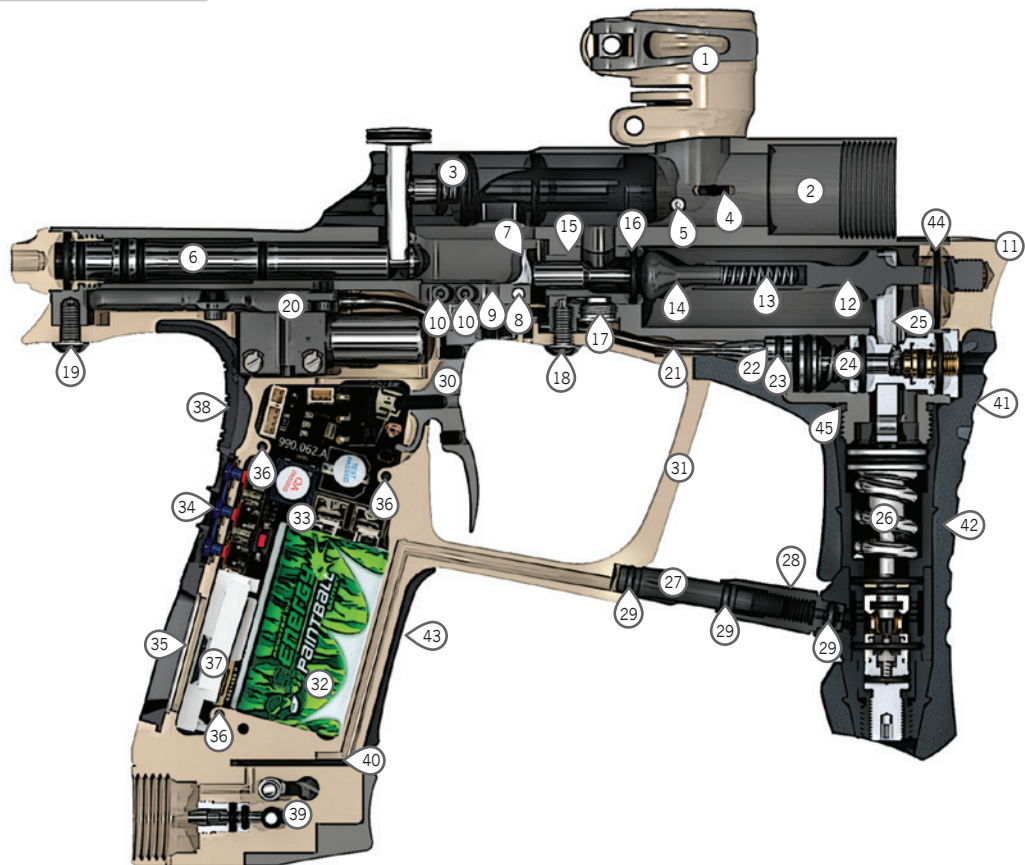

## PARTS LIST

- ① Clamping feed tube assembly
- ② Body
- ③ Bolt assembly
- ④ Rubber Detent
- ⑤ BBSS unit
- ⑥ Rammer assembly
- ⑦ Cam-lever
- ⑧ Cam axle
- ⑨ Cam carrier
- ⑩ Cam carrier retaining screw
- ⑪ Valve plug
- ⑫ Valve stem
- ⑬ Valve spring
- ⑭ Exhaust valve
- ⑮ Valve guide
- ⑯ Valve guide o-ring
- ⑰ Valve screw
- ⑱ Front frame screw
- ⑲ Rear frame screw
- ⑳ Solenoid assembly
- ㉑ Low pressure hose
- ㉒ Low pressure barb
- ㉓ Low pressure barb o-ring
- ㉔ LPR assembly
- ㉕ Tuning fork
- ㉖ SL4 inline regulator assembly
- ㉗ Gas pipe
- ㉘ Pipe nut
- ㉙ Gas pipe assembly o-ring
- ㉚ Trigger assembly
- ㉛ Frame
- ㉜ 9V battery
- ㉝ Printed circuit board
- ㉞ Push button strip
- ㉟ Display window
- ㊱ PCB screw
- ㊲ LCD module
- ㊳ Navigation console
- ㊴ POPS assembly
- ㊵ POPS seal
- ㊶ Foregrip crown
- ㊷ Foregrip sleeve
- ㊸ Rubber grip
- ㊹ Valve plug o-ring
- ㊺ Body FRM o-ring

## SHAFT 4 BARREL

The Eclipse Ego LV1 comes as standard with an Eclipse Shaft4 barrel.<sup>1,4</sup>

The barrel screws into the body of the Ego LV1 using a right hand thread meaning that if you hold the Ego LV1 pointing away from you the barrel screws into the body in a counter-clockwise direction.<sup>2</sup>

The barrel comprises of two parts, a barrel back (A) and a barrel front (B). The two parts are joined together with a left hand thread meaning that if you hold the barrel, with the back nearest you, the front unscrews in a counter-clockwise direction. The bore size of the barrel back is engraved at the end of the barrel back (C).<sup>3</sup>

On the barrel back there is a O16 NBR 70 o-ring (D) which prevents the barrel from vibrating loose from the Ego LV1 body when the marker is fired. There is also a O16 NBR 70 o-ring on the tip of the barrel back (E) helps with alignment when the two sections are screwed together.

Replace and lubricate these o-rings with Eclipse Grease as necessary.

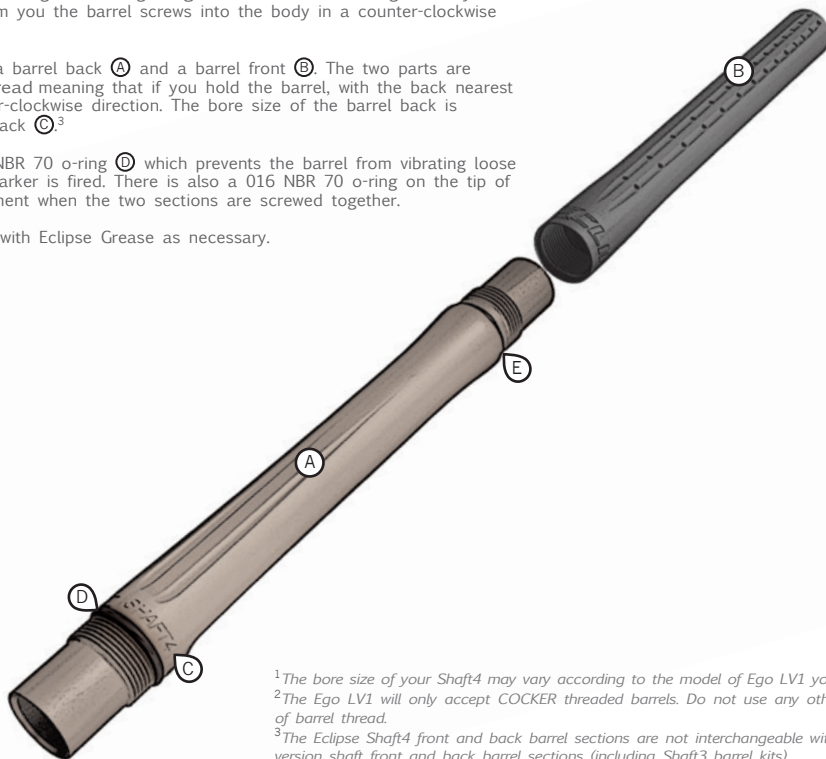

<sup>1</sup>The bore size of your Shaft4 may vary according to the model of Ego LV1 you have.

<sup>2</sup>The Ego LV1 will only accept COCKER threaded barrels. Do not use any other type of barrel thread.

<sup>3</sup>The Eclipse Shaft4 front and back barrel sections are not interchangeable with older version shaft front and back barrel sections (including Shaft3 barrel kits).

<sup>4</sup>The model of barrel accompanying your Ego LV1 may differ from described.



# SL4 INLINE REGULATOR<sup>1,2</sup>

<sup>1</sup>The SL4 inline regulator should be reset to factory after re-assembly.

<sup>2</sup>Only use the SL4 inline regulator with the Ego LV1.

<sup>3</sup>Only use the SL4 Ego spring with the Ego LV1 SL4 inline regulator.

<sup>4</sup>If the Purge Poppet assembly is removed for maintenance ensure it is re-installed correctly, failure to do so may seriously damage the Ego LV1 solenoid valve.

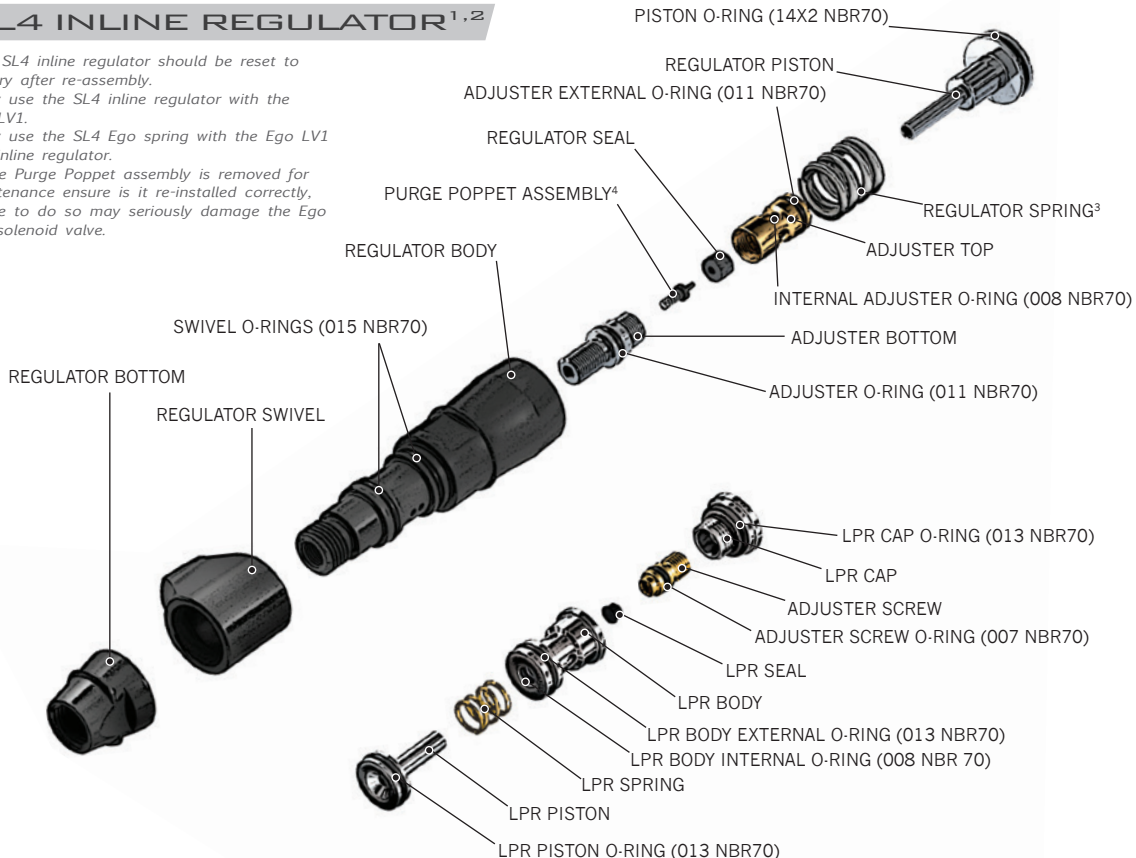

<sup>5</sup>The low pressure regulator should be reset to factory after re-assembly.

## CURE5 BOLT



<sup>1</sup>The Ego LV1 comes with two rammer assemblies, a standard rammer (installed in the marker from factory) and a lightweight rammer. See page 48 for more information on the Ego LV1 rammers.

ZICK3 RAMMER<sup>1</sup>

## EGO LV1 SOLENOID ASSEMBLY



<sup>1</sup>The Ego LV1 solenoid valve is **NON-SERVICEABLE**. Any attempt to strip, dismantle or service the solenoid valve will immediately void your Warranty. For more information on the Ego LV1 solenoid valve please see page 61.

# EGO LV1 PUSH ON PURGE SYSTEM (POPS)

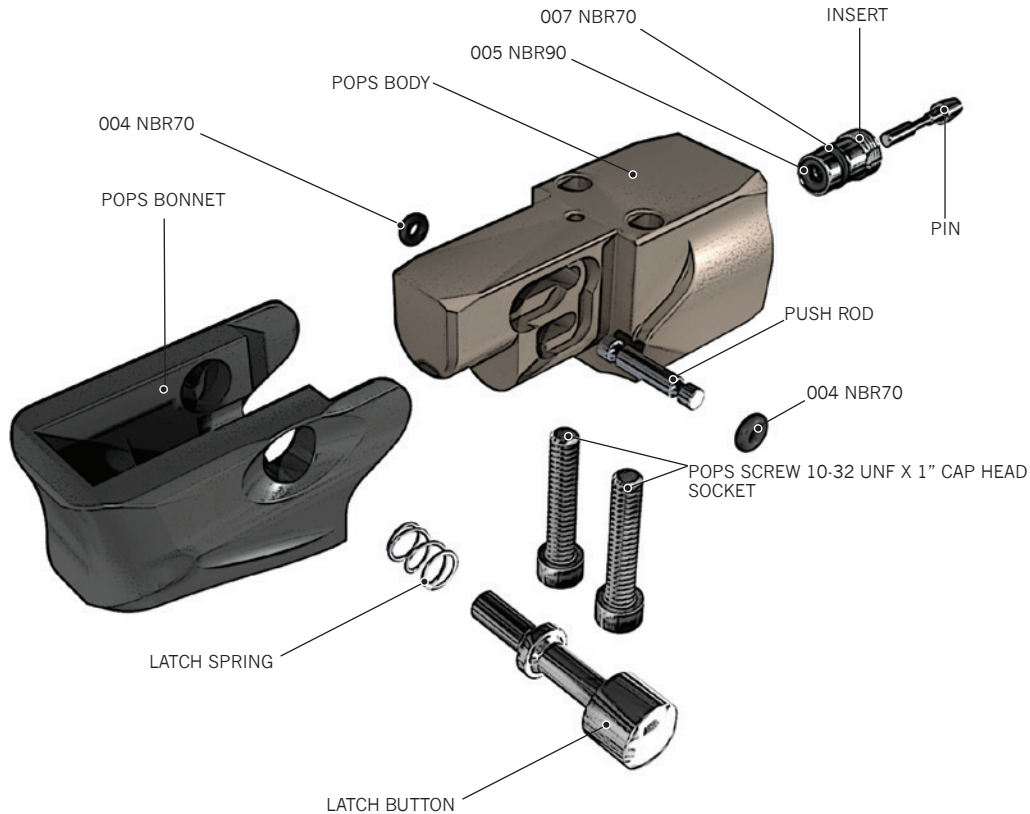



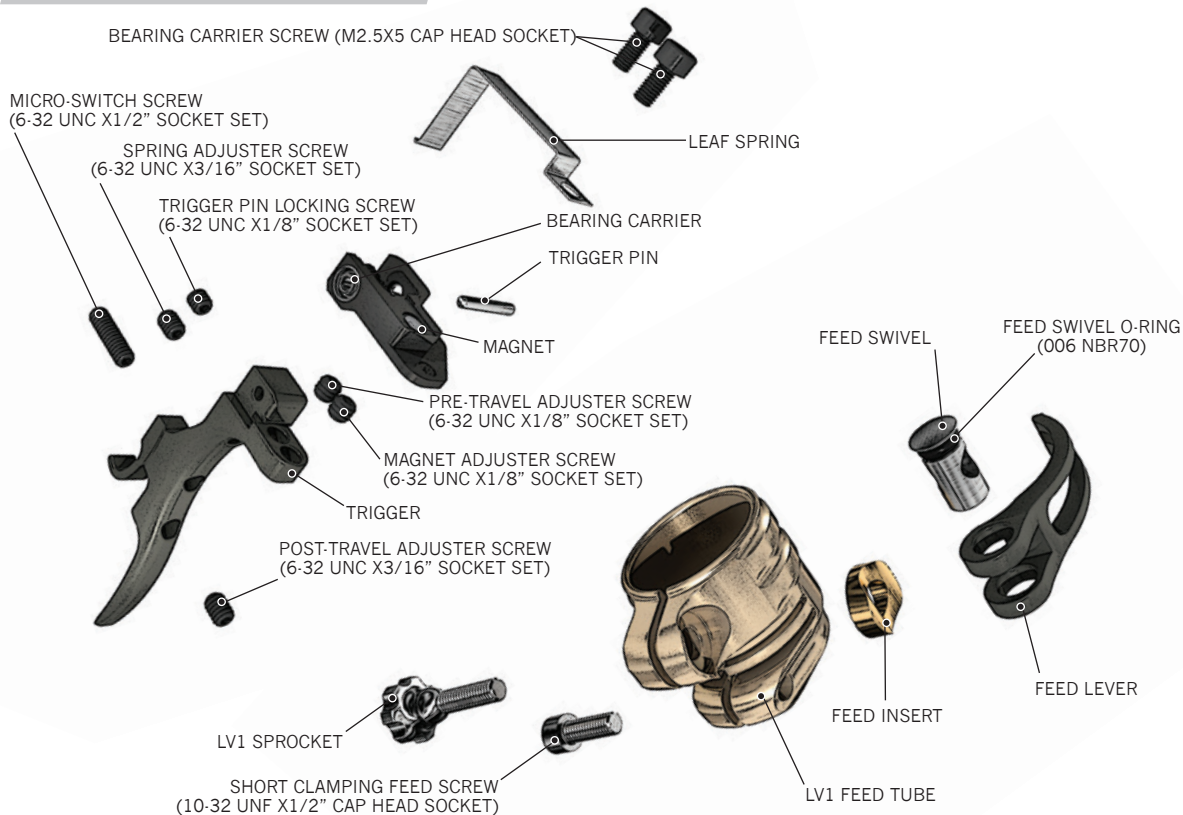





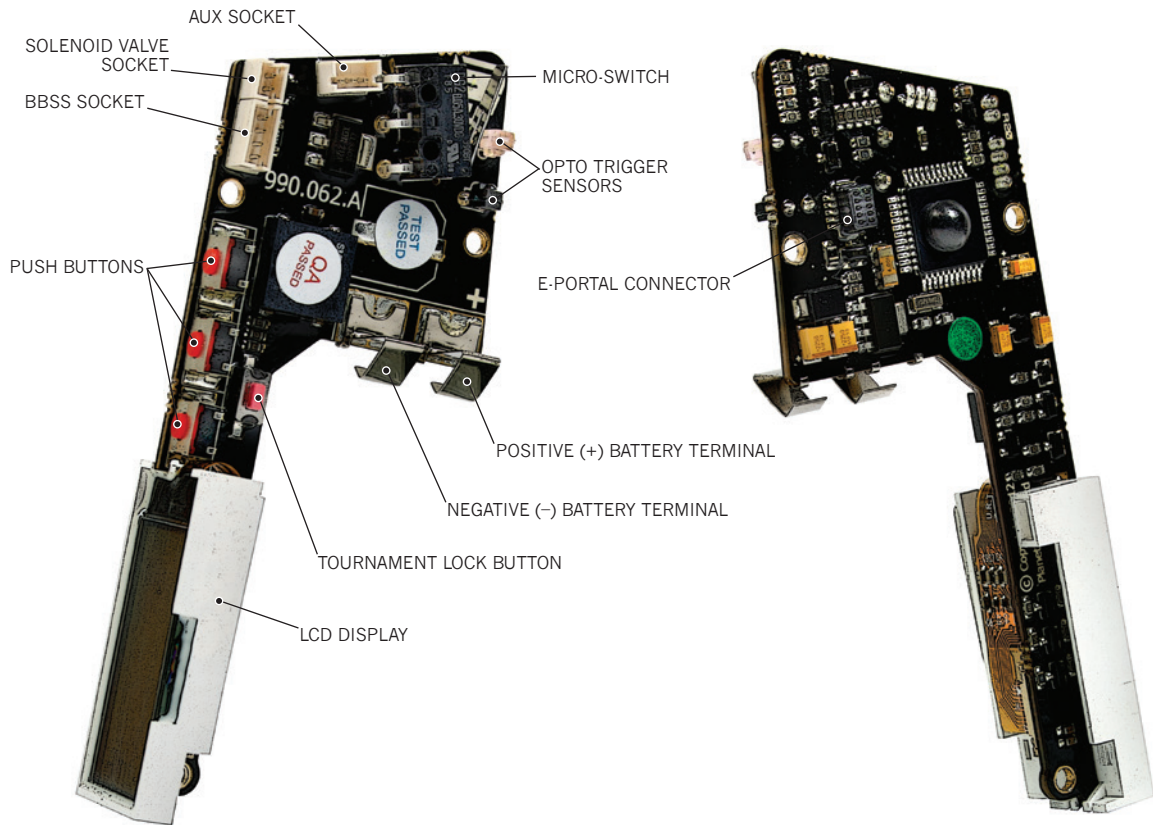

## TRIGGER ASSEMBLY

















## CLAMPING FEED TUBE ASSEMBLY

# EGO LV1 CIRCUIT BOARD



SCREW	QTY	DESCRIPTION
	13	PCB SCREW (3), BEARING CARRIER SCREW (2),MANIFOLD SCREW(3), CAM CARRIER(4), NAVIGATION CONSOLE (1) <i>(M2.5 x 5 CAP HEAD SOCKET)</i>
	2	SOLENOID SCREW (2) <i>(M1.7 x 16 CAP HEAD SOCKET)</i>
	6	RUBBER GRIP SCREW (4), BBSS COVERS SCREW (2) <i>(6-32UNC x 5/16" COUNTERSUNK SOCKET)</i>
	1	SHORT FEED NECK SCREW <i>(10-32UNF x 1/2" CAP HEAD SOCKET)</i>
	2	POPS SCREW <i>(10-32UNF x 1" CAP HEAD SOCKET)</i>
	1	MICRO-SWITCH SCREW <i>(6-32 UNC x 1/2" SOCKET SET SCREW)</i>
	2	TRIGGER ADJUSTMENT SCREW <i>(6-32 UNC x 3/16" SOCKET SET SCREW)</i>
	3	TRIGGER PIN RETAINING SCREW <i>(6-32 UNC x 1/8" SOCKET SET SCREW)</i>
	2	FRONT & REAR FRAME SCREW <i>(10-32 UNF x 3/8 SOCKET BUTTON HEAD)</i>

18x2		POPS Seal	013		Valve Guide LPR Piston LPR Body Outside LPR Cap Rammer Cap Outside
017		Valve Plug Front Regulator Mount (Body)	012		Bolt Insert
016		Shaft4 Barrel Back (body end) Shaft4 Barrel Back (tip end)	011		Rammer Middle SL4 Inline Regulator Adjuster Outside
015		SL4 Swivel	010		Rammer Back Rammer Bumper Rammer Front
14x2		Bolt Body x2 SL4 Inline Regulator Piston	008		SL4 Inline Regulator Adjuster Inside LPR Body Inside
014		Bolt Pin	007		Gas Pipe Pipe Nut LPR Adjuster Screw POPS Insert External
			006		LP Hose Barb
			005		POPS Insert Internal (NBR 90)
			004		POPS Push Rod

**ALL O-RINGS ARE NBR 70 DUROMETER UNLESS OTHERWISE STATED.**









## THE MENU TREE

The  symbol indicates parameters that are locked when the Tournament Lock is on. See Accessing the Menu System on page 27 for instruction on releasing the Tournament Lock.

Parameters followed by a \* are part of the Smart Menu System and will only be displayed depending on your chosen settings. (e.g. The BS ON ROF parameter will only become available if the ROF CAP parameter is set to on).

### MAIN MENU

TURN OFF		Turn off the Ego LV1.
PRESET		
 LOAD	USER 1 USER 2 FACTORY (Default) NPPL PSP 10 PSP 12 MS 10 CANCEL	Load the USER 1 settings. Load the USER 2 settings. Load the default factory settings (semi-automatic). Load NPPL compliant settings. Load the PSP 10 balls per second (BPS) compliant settings. Load the PSP 12 balls per second (BPS) compliant settings. Load Millennium Series 2010 compliant settings. Cancel the load operation.
 SAVE	USER 1 USER 2 CANCEL	Save the current settings as the USER 1 settings. Save the current settings as the USER 2 settings. Cancel the save operation.
BACK		Return to Main Menu.
 FIRE MODE	SEMI (Default) RAMP CANCEL	Select semi-automatic mode of fire. Select ramping mode of fire. Cancel the mode selection.
 ROF CAP	ON OFF (Default) CANCEL	Rate of fire cap on. Rate of fire cap off. Cancel selection.
 BS ON ROF*	4.0 - 30.0 bps	Maximum rate of fire with breach sensor on (ROF CAP dependant). (Default 15.0bps)
 BS OFF ROF	4.0 - 15.0 bps	Maximum rate of fire with breach sensor off. (Default 10.0bps)

## RAMP SETUP\* (FIRE MODE DEPENDANT)

TYPE	STEP (Default) LINEAR CANCEL	Step ramping. Linear ramping. Cancel selection.
RATE*	0 - 100%	Percentage linear ramp rate (TYPE dependant). (Default 50%)
SEMI SHOTS	3 - 9	Number of shots before ramping can start. (Default 3)
KICK IN	3.3 - 10.0 pps	Rate at which the trigger has to be pulled in pulls per second (pps) before ramping can start. (Default 5pps)
SUSTAIN	3.3 - 10.0 pps	Rate at which the trigger has to be pulled in pulls per second (pps) in order to maintain ramping. (Default 5pps)
RESTART	0.0 - 1.0 s	Time in seconds (s) after the last trigger pull during which ramp can be restarted. (Default 0.0s)
BACK		Return to Main Menu.

## TIMING

DWELL	10.0 - 30.0 ms	Solenoid energise time in milliseconds (ms) for each shot. (Default 16.8ms)
FSD COMP	0.0 - 5.0 ms	First shot drop-off compensation time in milliseconds (ms). (Default 2.0ms)
FSD DELAY	00:00 - 04:00	First shot drop-off delay. (Default 04:00)
BACK		Return to Main Menu.

## FILTER

DEBOUNCE	LEVEL 9 LEVEL 8 - 2 LEVEL 1 CANCEL	Use trigger Debounce level 9 (highest level of trigger bounce filtering). Use trigger Debounce level 8 - 2. (Default LEVEL 5) Use trigger Debounce level 1 (lowest level of trigger bounce filtering). Cancel Debounce selection.
EMPTY	1.0 - 20.0 ms	Time in milliseconds (ms) that the breech must remain empty before the BBSS looks for a paintball. (Default 4.0ms)
FULL	1.0 - 20.0 ms	Time in milliseconds (ms) that a paintball must be in the breech for the Ego LV1 to be ready to fire. (Default 4.0ms)
PULL TM	3.0 - 25.0 ms	Time in milliseconds (ms) that the trigger must be pulled for a shot to be fired. (Default 6.0ms)
RELEASE TM	3.0 - 25.0 ms	Time in milliseconds (ms) that the trigger must be released before a pull can be recorded. (Default 6.0ms)
PULL PT*	51 - 99%	Percentage at which the trigger OPTO sensor pull point is set (TRIGGER dependant). (Default 85%)
RELEASE PT*	1 - 49%	Percentage at which the trigger OPTO sensor release point is set (TRIGGER dependant). (Default 15%)
BACK		Return to Main Menu.

## (CONTINUED)

### HARDWARE

#### TRIGGER

OPTO (Default)	Use OPTO sensor to detect trigger operation.
SWITCH	Use micro-switch to detect trigger operation.
CANCEL	Cancel trigger detection method selection.

#### SOLENOID

LO PWR (Default)	Select standard solenoid power level.
HI PWR	Select high power level for solenoid.
CANCEL	Cancel solenoid power level selection.

#### SOUND

OFF	Turn off audible indicator.
ON (Default)	Turn on audible indicator.
CANCEL	Cancel audible indicator selection.

#### TONES\*

OFF	Turn off audible tone when any button is pressed (SOUND dependant).
ON (Default)	Turn on audible tone when any button is pressed (SOUND dependant).
CANCEL	Cancel audible tone selection.

#### BACKLIGHT

00:00 - 00:20	Time in seconds that the backlight comes on for (00:00 = no backlight). (Default 00:06)
---------------	---

#### RED LEVEL\*

0 - 100%	Percentage of red light in backlight (BACKLIGHT dependant).
----------	---

#### GRN LEVEL\*

0 - 100%	Percentage of green light in backlight (BACKLIGHT dependant).
----------	---

#### BLU LEVEL\*

0 - 100%	Percentage of blue light in backlight (BACKLIGHT dependant).
----------	--

#### CONTRAST

0 - 30	LCD contrast level. (Default 14)
--------	----------------------------------

#### AUX OUT

OFF	AUX socket output off.
ON (Default)	AUX socket output on.
CANCEL	Cancel AUX socket selection.

#### AUTO OFF

05:00 - 60:00	Time in minutes after which the Ego LV1 automatically powers off. (Default 20:00)
---------------	---

#### DBL CLICK

NONE	Double click is disabled entirely.
POWER UP	Double click for power up only.
ALL (Default)	Double click is fully enabled.
CANCEL	Cancel the double click selection.

#### BACK

Return to Main Menu.

### TRAINING

OFF (Default)	Training mode disabled.
ON	Training mode enabled.
CANCEL	Cancel training mode selection.

SHOTCOUNT	
GAUGE	OFF Shot gauge off. ON (Default) Shot gauge on. CANCEL Cancel selection.
GAUGE MAX*	100-2000 SHOTS Shot gauge maximum (reset value) (GAUGE dependant). (Default 140 shots)
BACK	Return to Main Menu.
GAMETIMER	
GAME	00:00 - 60:00 Countdown game timer start time in minutes. (Default 07:10)
ALARM	00:00 - 60:00 Alarm activation time in minutes. (Default 01:00)
START	BUTTON (Default) Pressing the  button starts the Game Timer. TRIGGER A trigger pull starts the Game Timer. CANCEL Cancel Game Timer start selection.
BACK	Return to Main Menu.
EXIT	

From time to time the software of the Ego LV1 may be updated, resulting in changes to the default values for some parameters. For the most up to date default values please consult the online version of this manual at [www.planeteclipse.com](http://www.planeteclipse.com)

The arrangement of menus and sub menus displayed in the above menu tree may not be replicated in your marker due to any software updates that may have taken place since printing.

## ECLIPSE E-PORTAL

### ⚠ WARNING ⚠

**DE-GAS YOUR MARKER, DISCHARGING ANY STORED GAS IN A SAFE DIRECTION, AND REMOVE THE BARREL, LOADER, AIR SYSTEM AND ANY PAINTBALLS TO MAKE THE MARKER EASIER AND SAFER TO WORK ON.**

The Ego LV1 is compatible with Eclipse E-Portal Software. This software is an upgrade to the Ego LV1 platform. The Eclipse E-Portal Software, USB cable and USB daughter board are sold as a kit, separate from the Ego LV1.<sup>1</sup>

E-Portal allows you to connect the Eclipse Ego LV1 to a PC, where a number of operations can be performed:<sup>2</sup>

**UPDATE THE MARKER FIRMWARE** · from time to time new firmware may be released by Planet Eclipse. You can now install the latest firmware using the Eclipse E-Portal.

**ALTER THE ELECTRONIC PARAMETERS** · the Eclipse E-Portal will give you full access to all of the parameters on the Ego LV1 circuit board.

**CUSTOMISE SCREEN GRAPHICS** · customise the boot up screen graphic.

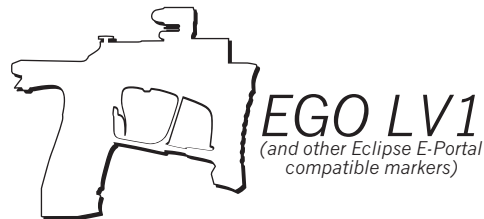
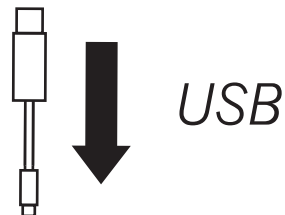

<sup>1</sup>If you already own an Eclipse E-portal kit (such as the kit included with the Eclipse SLS or CSL Ego), this kit will be compatible with the Ego LV1.

<sup>2</sup>Minimum system requirements :

Monitor Resolution - 1024x768 or higher, CD-ROM drive, Keyboard, Mouse, USB socket, 5MB of hard disk space, 1GHz Processor, 384Mb RAM, Microsoft® Windows® XP / Windows Vista / Windows 7 / Windows 8, internet connection (required for software and firmware updates).

Actual Rate of Fire.....22, 26  
 Advanced Trigger Filter Setup.....36  
 ALARM.....25, 41, 84  
 AUTO OFF.....39, 83  
 AUX OUT.....22, 23, 39, 83  
 BACKLIGHT.....10, 38, 83  
 Basic Trigger Filter Set-up.....36  
 Battery.....7, 21, 22, 37,64, 65, 66, 71  
 Battery Level Indicator.....25  
 Bearing Carrier Assembly.....54, 55, 77  
 Bearing Carrier Screw..... 54, 55, 77, 79  
 BLU LEVEL.....38, 83  
 Bolt.....47, 64, 65, 67, 69, 71, 74, 80  
 Bolt Insert.....74, 80  
 Bolt Pin.....64, 74, 80  
 Bolt Plunger.....74  
 Bolt Spring.....74  
 Bolt Tip.....47, 65, 74  
 Break Beam Sensor System (BBSS).....9, 10, 23, 65, 66, 67  
 Break Beam Sensor System Indicator.....23  
 BBSS Socket.....78  
 BS OFF ROF.....23, 30, 81  
 BS ON ROF.....23, 30, 81  
 Cam-lever assembly.....53, 66, 71  
 CANCEL.....27  
 Clamping Feed Sprocket Screw.....14, 20, 77  
 Clamping Feed Swivel.....77  
 Clamping Feed Tube.....20,77  
 Clamping Feed Tube Screw.....77, 79  
 Clamping Lever.....14, 77  
 Clamping Feed Tube Insert.....77  
 Circuit Board (PCB).....65, 78  
 Contrast.....39, 83  
 DBL CLICK.....39, 83  
 DEBOUNCE.....34, 36, 66, 82  
 DWELL.....33, 65, 67, 69, 82  
 E-Portal.....85  
 EMPTY.....34, 82  
 Exhaust Valve.....56, 57, 58, 64, 71  
 EXIT.....84  
 Eye Cover.....42, 43  
 Eye Cover Screw.....42, 43, 79  
 FACTORY.....6, 29, 81  
 FILTER.....34, 82  
 FIRE MODE.....30, 81  
 Foregrip Crown.....40,45,50,51,56,67,71  
 Foregrip Sleeve.....18,44,71  
 Frame.....52, 71  
 Frame Screw.....52, 71, 79  
 Front Stop Trigger Screw.....12, 13, 67  
 FSD COMP.....33, 66, 82  
 FSD DELAY.....33, 82  
 FULL.....34, 82  
 GAME.....41, 84  
 GAME TIMER.....22, 25, 41, 67, 84  
 Gas Pipe.....15, 71, 80  
 GAUGE.....25, 40, 84  
 GAUGE MAX.....40, 84  
 GRN LEVEL.....38, 83  
 HARDWARE.....36, 83  
 Inline Regulator Adjuster Screw.....18, 73, 80  
 Inline Regulator Assembly.....71, 73  
 Inline Regulator Body.....73  
 Inline Regulator Bottom.....73  
 Inline Regulator Piston.....73, 80  
 Inline Regulator Spring.....73  
 Inline Regulator Swivel.....15, 73, 80  
 KICK IN.....32, 82  
 Latch Button.....76  
 LINEAR.....31, 82  
 LOAD.....29, 81  
 Lock Indicator.....22, 25, 27, 78, 81  
 Low Pressure Hose.....64, 71  
 Low Pressure Hose barb.....71  
 LPR.....6, 18, 50, 51, 64, 65, 66, 67, 71, 73, 80  
 LPR Adjuster Screw.....18, 51, 73, 80  
 LPR Seal.....73  
 LPR Body.....73, 80  
 LPR Cap.....73, 80  
 LPR Piston.....73, 80  
 LPR Piston Spring.....73  
 Magnet Return Strength Screw.....13, 77, 79  
 Manifold..... 59, 64, 75, 79  
 Manifold Barb.....75  
 Manifold Barb Clip.....75  
 Manifold Filter.....75  
 Manifold Gasket.....75  
 Manifold Retaining Screw.....75, 79  
 Main Menu.....27, 28, 81  
 Menu System.....26, 28, 81-84  
 Menu Tree.....81-84  
 Micro-switch Activation Screw.....13, 77, 79  
 MS 10.....29, 81  
 Navigation Console.....10, 22, 71

NPPL.....29, 81  
Parameters.....10, 26, 27, 28  
PCB Retaining Screw.....79  
Peak Rate of Fire.....22, 26  
Pipe Nut.....15, 71, 80  
Plastic Push Button Strip.....71  
POPS Body.....76  
POP Bonnet.....76  
POPS Insert.....76  
POPS Pin.....76  
POP Retaining Screws.....76, 79  
PRESET.....29, 81  
PSP 10.....29, 81  
PSP 12.....29, 81  
PULL PT.....35, 82  
PULL TM.....35, 82  
Purge Poppet Assembly.....71  
Push Operated Purge System (POPS).....71  
Rammer Bumper.....74  
Rammer Cap.....74  
Rammer Shaft.....74  
RAMP.....30, 81  
RAMP SET UP.....31, 82  
RATE.....31, 82  
Rear Stop Trigger Screw.....12, 77, 79  
RED LEVEL.....38, 83  
Regulator Seal.....73  
RELEASE PT.....35, 82  
RELEASE TM.....35, 82  
RESTART.....32, 82  
ROF CAP.....30, 81  
Rubber Detent.....43, 71  
Rubber Grip Screw.....79  
Run Screen Layout.....22  
SL4 Inline Regulator.....71  
SAVE.....29, 81  
SEMI.....30, 81  
SEMI SHOTS.....32, 32  
Shaft4 Barrel.....11, 72  
SHOT COUNT.....22, 25, 40, 84  
SOLENOID.....37, 83  
Solenoid Assembly.....75  
Solenoid Flow Restrictors (SFRs).....6, 19, 73  
Solenoid Gasket.....73  
Solenoid Manifold.....73  
Solenoid Retaining Screw.....73  
Solenoid Valve.....61, 73

SOUND.....37, 83  
Sound Indicator.....22, 24  
Spring Return Strength Screw.....13, 77, 79  
START.....41, 84  
STEP.....31, 82  
SUSTAIN.....32, 82  
TIMING.....33, 82  
TONES.....37, 83  
TRAINING.....23, 40, 83  
Trigger.....8, 12, 13, 54, 55, 77  
TRIGGER.....83  
Trigger Assembly.....71, 77  
Trigger Detection Indicator (TDI).....13, 24  
Trigger Pin.....12, 77  
Trigger Pin Locking Set Screw.....12, 77  
Trigger Leaf Spring.....12, 77  
Tuning Fork.....71  
TURN OFF.....8, 10, 28, 81  
TYPE.....31, 82  
USB Cable.....85  
USER1.....29, 81  
USER2.....29, 81  
User Interface.....22,  
Valve Guide.....56, 57, 58, 71  
Valve Plug.....71  
Valve Screw.....71  
Valve Spring.....71  
Valve Stem.....71  
Velocity.....18  
Zick3 Rammer.....74  
Zick3 Rammer Cap.....74



This product is covered by and / or Licensed under one or more of the following patents;

G.B. Patents; 2,342,710; 2,345,953; 2,352,022; 2,391,292; 2,391,063;  
U.S. Patents; 7,836,873; 7,603,995; 7,073,284; 8,104,463; 7,509,953; 7,921,839; 7,089,697; 7,866,307;  
8,082,912; 7,076,906; 7,607,424; 7,980,238; 6,311,682; 6,748,938; 6,860,259; 6,941,693; 6,973,748;  
5,881,707; 5,967,133; 6,035,843; 6,474,326; 6,637,421; 6,644,295; 6,810,871; 6,901,923; 7,121,272;  
7,100,593; 7,610,908; 7,603,997; 7,946,285; 6,349,711; 7,044,119; 7,185,646; 7,461,646; 7,556,032;  
7,591,262; 7,617,819; 7,617,820; 7,624,723; 7,640,925; 7,640,926; 7,866,308;

Application Numbers.

12/256,832; 12/613,958; 12/493,777; 11/654,721; 11/747,107; 12/503,504; 11/781,821; 60/832,548;  
11/965,886; 10/280,115; 12/511619; 13/182135; 13/334575; 13/165234

Additional U.S. and International Patents may be pending.

© 2013-2016 Copyright Planet Eclipse Ltd. Eclipse, Planet Eclipse, the Estar Logo Device, Ego, Geo, Etek, Etha and EMC are all either design trademarks, registered trademarks or trademarks of Planet Eclipse Ltd. All other trademarks are property of their respective owners.

#### **USA**

130 Franklin Street  
Building L4 & L5  
Warren, RI, 02885, USA  
Call: +1 401 247 9061  
[info.usa@planetecclipse.com](mailto:info.usa@planetecclipse.com)

#### **UK**

Unit 14 Premier Park, Acheson Way  
Trafford Park Road, Trafford Park  
Manchester, M17 1GA, England  
Call: +44(0) 161 872 5572  
[info.europe@planetecclipse.com](mailto:info.europe@planetecclipse.com)