

PST14C

DC-DC | 150W | 1 output

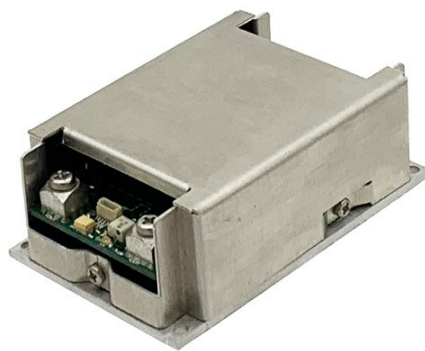

PRODUCTCARD

Electronic | Mechatronic | Optics | Special App

IHR VORTEIL - UNSERE STÄRKEN



- Europäische Entwicklung
- Europäische Herstellung unter Berücksichtigung von ISO 9001, EN 9100, ISO 14001, ISO 45001
- Kurze Lieferkette
- Kurze Produktionszeiten, da die meisten Bauteile bevorratet werden können.
- Individualisierung nach Kundenwunsch bzw. Anpassung von Formfaktor, Konnektivität und Leistung möglich.
- Standard und ruggedized Varianten
- Modulare Bauweise (mehrere Stromquellen sind System technisch zusammengefasst), Vereinfachung von Konstruktion, Assembling und Service.
- Europäische Normen z.B. EN61000-3-2, EN55022B oder MIL-STD461E CE102, MIL-STD810E
- Alles aus einer Hand:
Design-In, Vertrieb und Abnahme durch das Ingenieurbüro **GLASER Engineering**

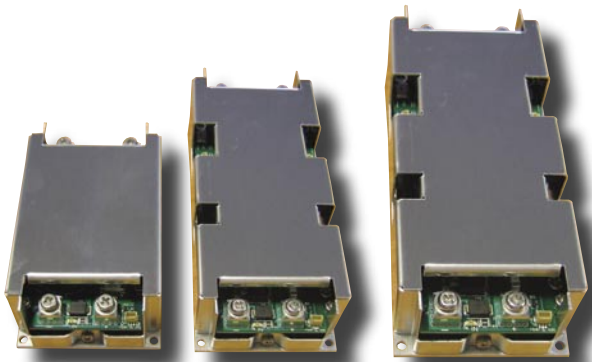

Micro PST14C 150W 100 x 61 x 35mm	Mini PST14B 250W 140 x 61 x 35mm	Maxi PST14A 500W 225 x 61 x 35mm
--	---	---

PST14 Standard product

DC-DC conduction cooled from 50W to several kW

Features

- ▶ 12, 24, 48, 72, 110Vdc IN
- ▶ 3 packages up to 150W, 300W, 500W
- ▶ Output from 3V3 to 48Vdc
- ▶ Input filtering EN55022 & transient protection
- ▶ Reverse polarity protection
- ▶ Several outputs, parallel or series operations up to several kW
- ▶ MIL COTS options MIL STD1275, 461, 810, 704

Safety IEC/EN 60950-1, RoHS lead-free-solder compliant



Description

The PST14, very compact DC-DC converter in chassis mount format, incorporates input filtering, input and output protections, very robust mechanical mounting and connection, optional conformal coating, required in most of the severe environment for industrial, railways, defense type of applications. The converter provides high reliability thanks to the integration of Vicor Corp. modules, high efficiency, input-to-output isolation, soft start, overtemperature protection, input over/undervoltage lockout. The converters wide range of inputs are protected against surges and transients and EMI filtered. The outputs are continuously short-circuit proof. The 100°C baseplate operation allows operation in high temperature environment.

The output can be configured in many different output voltages from 3V3 to 48Vdc, can be put in series and parallel, others possibilities are even possible as semi-standard versions.

Wide range of accessories (see page 16) like input & output Bus bars, N+1 oring diodes, parallel cables are available to simplify multi units assemblies. Military options (M) make it suitable for MIL STD compliance.

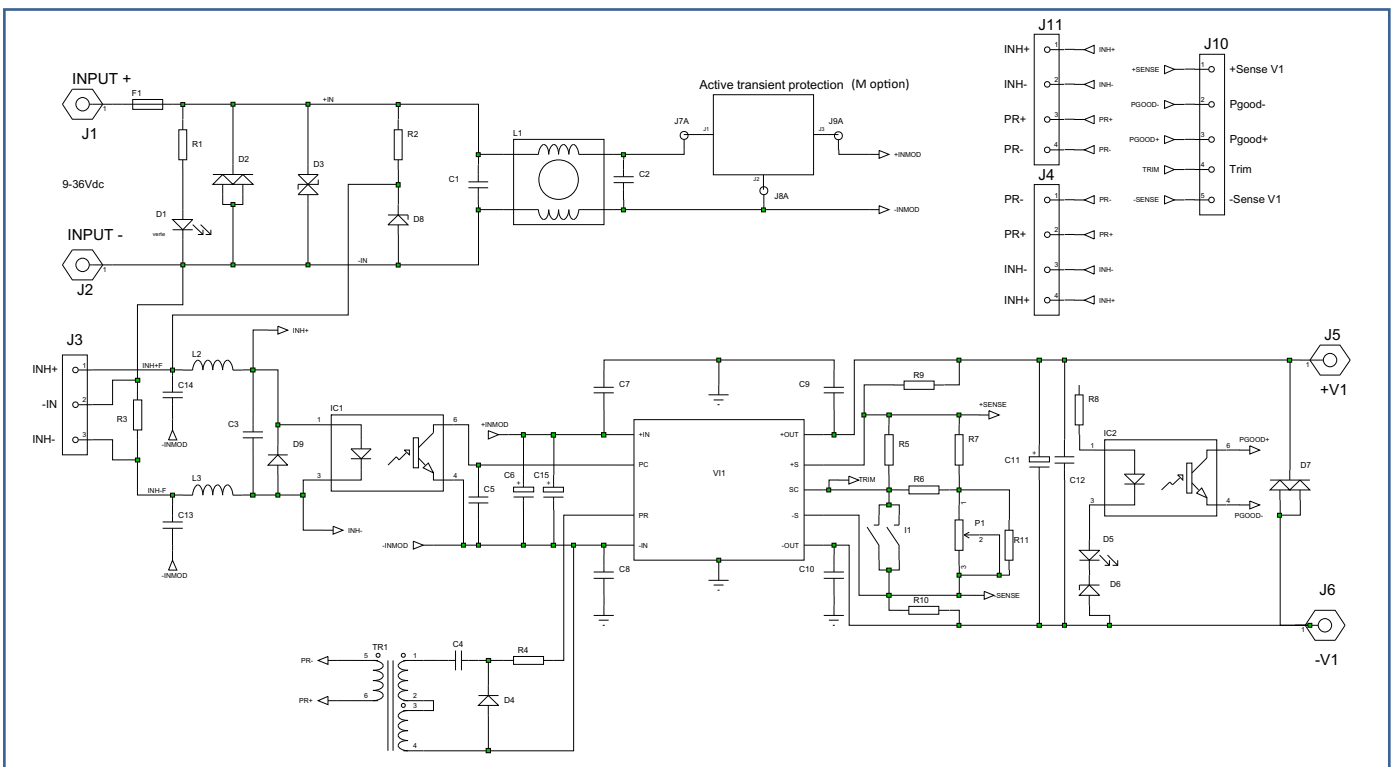

Options Description

Heatsink (H)

The PST14 is built as standard with an aluminum baseplate as described in the mechanical data. The converter can be delivered with a 15mm height heatsink with longitudinal fins (-H) or transversal fins (-H1). See page 15 for mechanical drawings. 3D models available on the web site. In case of using H or H1 option, the thermal impedance (Rth) of the heatsink mentioned below must be considered for the airflow or maximum power calculation. Conditions : 55°C ambient, convection (0m/s vertical mounting) and 2m/s airflow:

PST14A -H or H1: Rth@0m/s: 1,8°C/W, Rth@2m/s: 0,8°C/W

PST14B -H or H1: Rth@0m/s: 2,8°C/W, Rth@2m/s: 1,2°C/W

PST14C -H or H1: Rth@0m/s: 3,9°C/W, Rth@2m/s: 1,7°C/W

Ruggedized (M)

The PST14 can be ruggedized to meet MIL-STD810E, MIL-STD461E CE102.

M option with 12&24Vin will comply with MIL STD 1275A on PST14A & PST14B only.

-40°C operation (T)

The thermal grade of the Vicor the DC/DC converters used and other components are changed to comply with low ambient temperature.

Conformal coating (V)

During manufacturing process, when V option is specified, components and pcb are covered with an acrylic coating to address high level of ambient humidity application.

Accessories

See page 16 for details.

Accessories are compatible with PST14A, B, C format

Input parallel bus bar with capacitor footprints

The input bus bar simplifies the assembly of 2 or 3 PST14. It includes input extra capacitor footprints for application with long length from the source to the PST14.

Output parallel bus bar

Available for 2up & 3up versions, it connects together the different positive outputs as well as negative output.

Output serial bus bar

It connects the negative of the first unit with the positive of the second to create high voltage configuration.

Output N+1 bus bar including diode

From 1up to 4up, this accessory puts in parallel the outputs with the addition of an oring diode mounted on an aluminium bar.

Inhibition and parallel cable

These 50mm cables allow unit to current share in parallel and allow the user to inhibit all units at the same time.

Input

Electrical Input Data

Input Characteristics	Conditions	Model	12V			24V			48V			72V			110V			Units		
			min	typ.	max	min	typ.	max	min	typ.	max	min	typ.	max	min	typ.	max			
Operating input voltage			9		36	18		36	36		75	43		110	66		154	V		
Input surge	< 100ms				50			50			100			150			250	V		
Undervoltage turn-on					8,9			17,5	17,9		35			42			64	V		
Undervoltage turn-off					8,5			14,8	15,3		30			36,5			56	V		
Overvoltage turn-off					36,2			40	36,3		39,7	75,7		82,5	111		121	155	170	V
Input current	Vin min	PST14A			30			33			16,2			11			7,2		A	
		PST14B			21			16,5			8,2			7			3,6		A	
		PST14C			15			10			3,7			4,2			1,8		A	
No load input power		PST14A		8	17		8	14		8	16		11	17		11	15		W	
		PST14B		6	11		6	7,8		6	11		8	11		7	9		W	
		PST14C		3	10		3	7		3	5		5	7		3	5		W	
Input capacitance	No inrush limiting circuit	PST14A		440			440			44			20			20			uF	
		PST14B		270			270			44			10			10			uF	
		PST14C		220			220			44			10			10			uF	
Start-up time		PST14A		50			50			50			50			50			ms	
		PST14B		50			50			50			50			50			ms	
		PST14C		50			50			50			50			50			ms	

Input Fuse

A fuse mounted inside the converter protects against damages in case of a failure. The fuse is not user-accessible.

Input Reverse Polarity

A diode placed internally across the input will cause the fuse to blow in case of a reverse polarity of input voltage.

Input Transient Protection

A VDR (Voltage Dependent Resistor) and a common mode input filter form an effective protection against input transients in severe environments like railways.

When M option is defined for PST14A&B, the unit is incorporating an active protection against high energy transient MIL STD 1275, DO160.

Output

Electrical Output Data PST14A

General conditions : 25°C ambient.

1) Adjustment below -10% possible as semi-standard versions , consult factory -2) Recycle input voltage or inhibit to restart (>100ms off) - 3) Output voltage 95 % of nominal - 4) Output voltage < 250mV - 5) Nominal input, full load, 20MHz bandwidth - 6) No load to full load, nominal input

Part Number	Output Voltage		Output Power			Voltage Adjustment (1)			Overvoltage Protection (2)			Output Current			Output Current Limit (3)			Short Circuit Current (4)			Output Noise (5)			Efficiency			Load regulation (6)		
	V	W	W	Min.	Typ.	Max.	V	Min.	Typ.	Max.	A	Min.	Typ.	Max.	A	Min.	Typ.	Max.	mVpp	Min.	Typ.	Max.	%	Min.	Typ.	Max.	%		
	Nom.	Nom.	Min.	Typ.	Max.	Min.	Typ.	Max.	Min.	Typ.	Max.	Min.	Typ.	Max.	Min.	Typ.	Max.	Min.	Typ.	Max.	Min.	Typ.	Max.	Min.	Typ.	Max.	Min.	Typ.	Max.
12Vin																													
PST14A12-3V3150-x	3.3	150	3.0	3.63	4.1	4.3	4.5	0	45	46.4	52	61.5	31.8	52	61.5	75	100	78	0.2										
PST14A12-5175-x	5	175	4.5	5.5	6	6.25	6.5	0	35	35.7	40	49	24	40	49	170	350	76	0.2										
PST14A12-6V5200-x	6.5	200	5.9	7.15	7.7	8	8.3	0	30.5	31.4	35	41.6	21	35	41.6	170	350	78	0.2										
PST14A12-8200-x	8	200	7.2	8.8	9.3	9.7	10.2	0	25	25.5	29	33.8	17.5	29	33.8	180	400	80	0.2										
PST14A12-12200-x	12	200	10.8	13.2	13.7	14.3	14.9	0	16.6	17	19.2	22.6	11.6	19.2	22.6	150	350	80	0.2										
PST14A12-15200-x	15	200	13.5	16.5	17	17.8	18.6	0	13.3	13.5	15.3	20.6	9.3	15.3	20.6	150	275	84	0.2										
PST14A12-24200-x	24	200	21.6	26.4	27	28	29.2	0	8.33	8.4	9.6	11.3	5.8	9.6	11.3	220	400	85	0.2										
PST14A12-28200-x	28	200	25.2	30.8	31	32.7	34	0	7.1	7.3	8.2	10	5	8.2	10	150	250	84	0.2										
PST14A12-36200-x	36	200	32.4	39.6	40	42	43.5	0	5.5	5.7	7.7	8.1	3.4	7	8	150	280	82	0.2										
PST14A12-48200-x	48	200	43.2	52.8	53.5	56	58	0	4.1	4.25	4.4	5.8	2.9	4.8	5.8	180	400	82	0.2										
24Vin																													
PST14A24-3V3200-x	3.3	200	3.0	3.63	4.1	4.3	4.5	0	60	61.8	69	82	42	69	82	75	100	79	0.2										
PST14A24-3V3264-x	3.3	264	3.0	3.63	4.1	4.3	4.5	0	80	81.6	92	108	56	92	108	75	100	78	0.2										
PST14A24-5300-x	5	300	4.5	5.5	6	6.25	6.5	0	60	61.2	69	81	42	69	81	100	150	84	0.2										
PST14A24-5400-x	5	400	4.5	5.5	6	6.25	6.5	0	80	81.6	92	104	56	92	104	100	190	84	0.2										
PST14A24-6V5400-x	6.5	400	5.9	7.15	7.7	8	8.3	0	61	62.7	71	83	43	71	83	75	125	85	0.2										
PST14A24-8300-x	8	300	7.2	8.8	9.3	9.7	10.2	0	37.5	38.2	43	51	26	43	51	150	250	86	0.2										
PST14A24-12300-x	12	300	10.8	13.2	13.7	14.3	14.9	0	25	25.5	29	34	17.5	29	34	150	150	86	0.2										
PST14A24-12400-x	12	400	10.8	13.2	13.7	14.3	14.9	0	33.3	34	38	44	23	38	44	180	320	86	0.2										
PST14A24-12500-x	12	500	10.8	13.2	13.7	14.3	14.9	0	41.6	42.5	48	56	29	48	56	150	340	86	0.2										
PST14A24-15300-x	15	300	13.5	16.5	17	17.8	18.6	0	20	20.5	23	27	14	23	27	120	200	86	0.2										
PST14A24-15400-x	15	400	13.5	16.5	17	17.8	18.6	0	26.6	27	31	35	18	31	35	100	150	87	0.2										
PST14A24-24300-x	24	300	21.6	26.4	27	28	29.2	0	12.5	12.7	14.4	17	8.8	14.4	17	75	100	87.5	0.2										
PST14A24-24400-x	24	400	21.6	26.4	27	28	29.2	0	16.6	17	19	21.7	2.2	19	21.7	80	100	87.5	0.2										
PST14A24-24500-x	24	500	21.6	26.4	27	28	29.2	0	20.8	21.3	24	28	14	24	28	150	250	87.5	0.2										
PST14A24-28300-x	28	300	25.2	30.8	31	32.7	34	0	10.7	10.9	12.3	14.5	3	12.3	14.5	75	125	87	0.2										
PST14A24-28400-x	28	400	25.2	30.8	31	32.7	34	0	14.2	14.5	16	19.4	10	16.4	19.4	120	200	87	0.2										
PST14A24-28500-x	28	500	25.2	30.8	31	32.7	34	0	17.9	18.3	20.6	24.2	12.5	20.6	24.2	125	215	87	0.2										
PST14A24-36300-x	36	300	32.4	39.6	40	42	43.5	0	8.33	8.5	9.6	11.3	5.8	9.6	11.3	75	100	87.5	0.2										
PST14A24-36400-x	36	400	32.4	39.6	40	42	43.5	0	11.1	11.3	12.8	15	7.8	12.8	15	75	150	87.5	0.2										
PST14A24-48300-x	48	300	43.2	52.8	53.5	56	58	0	6.25	6.4	7.2	8.5	4.3	7.2	8.5	100	225	86.5	0.2										
PST14A24-48400-x	48	400	43.2	52.8	53.5	56	58	0	8.33	8.5	9.6	11.3	4.8	9.6	11.3	100	200	86	0.2										
48Vin																													
PST14A48-3V3264-x	3.3	264	3.0	3.63	4.1	4.3	4.5	0	80	81.6	94	108	56	92	112	75	100	80	0.2										
PST14A48-5400-x	5	400	4.5	5.5	6	6.25	6.5	0	80	81.6	92	104	8	92	104	75	100	84	0.2										
PST14A48-8400-x	8	400	7.2	8.8	9.3	9.7	10.2	0	50	51	57	67	35	57	67	150	310	84	0.2										
PST14A48-12500-x	12	500	10.8	13.2	13.7	14.3	14.9	0	41.6	42.5	48	54	29	48	54	150	250	87	0.2										
PST14A48-15500-x	15	500	13.5	16.5	17	17.8	18.6	0	33.3	34	38	45	3.8	38	45	75	100	88.5	0.2										
PST14A48-24500-x	24	500	21.6	26.4	27	28	29.2	0	20.8	21.3	23.4	25.5	14.6	23.4	25.1	75	100	87	0.2										
PST14A48-28500-x	28	500	25.2	30.8	31	32.7	34	0	17.8	18.2	20.6	23.3	12.5	20.6	23.3	75	100	88.5	0.2										
PST14A48-36500-x	36	500	32.4	39.6	40	42	43.5	0	13.9	14.1	16	19	9.7	16	19	100	150	86	0.2										
PST14A48-48500-x	48	500	43.2	52.8	53.5	56	58	0	10.4	10.6	12	13.6	6.2	12	14.8	150	175	89	0.2										
72Vin																													
PST14A72-3V3264-x	3.3	264	3.0	3.63	4.1	4.3	4.5	0	80	81.6	92	108	56	92	108	75	120	80	0.2										
PST14A72-5300-x	5	300	4.5	5.5	6	6.25	6.5	0	60	61.2	69	81	22	69	81	75	120	84	0.2										
PST14A72-8300-x	8	300	7.2	8.8	9.3	9.7	10.2	0	37.5	38.2	43	51	26	43	51	150	150	84	0.2										
PST14A72-12400-x	12	400	10.8	13.2	13.7	14.3	14.9	0	33.3	33.9	38	45	23	38	45	180	400	86	0.2										
PST14A72-15400-x	15	400	13.5	16.5	17	17.8	18.6	0	26.7	27.2	30.7	36.2	18	30.7	36.2	200	375	86	0.2										
PST14A72-24400-x	24	400	21.6	26.4	27	28	29.2	0	16.6	17	19	23.5	11.5	19	22.6	150	200	87	0.2										
PST14A72-28400-x	28	400	25.2	30.8	31	32.7	34	0	14.2	14.5	16.4	19.5	10	16.4	19.4	150	380	88	0.2										
PST14A72-36400-x	36	400	32.4	39.6	40	42	43.5	0	11.1	11.3	12.8	15	7.7	12.8	15	120	250	87	0.2										
PST14A72-48400-x	48	400	43.2	52.8	53.5	56	58	0	8.33	8.4	9.5	11.3	5.8	9.5	11.3	150	300	87	0.2										
110Vin																													
PST14A110-3V3150-x	3.3	150	3.0	3.63	4.1	4.3	4.5	0	45	46.4	52	61.5	31.8	52	61.5	75	100	81	0.2										
PST14A110-3V3200-x	3.3	200	3.0	3.63	4.1	4.3	4.5	0	60	61.8	69	82	42	69	82	75	110	80	0.2										
PST14A110-5200-x	5	200	4.5	5.5	6	6.25	6.5	0	40	40.8	46	54	28	46	54	120	200	85	0.2										
PST14A110-5300-x	5	300	4.5	5.5	6	6.25	6.5	0	60	61.2	69	81	42	69	81	75	120	84	0.2										
PST14A110-8200-x	8	200	7.2	8.8	9.3	9.7	10.2	0	25	25.5	29	34	6	29	34	150	275	87	0.2										
PST14A110-8300-x	8	300	7.2	8.8	9.3	9.7	10.2	0	37.5	38.2	43	51	26	43	51	150	250	86	0.2										
PST14A110-12300-x	12	300	10.8	13.2	13.7	14.3	14.9	0	25	25.5	28.8	33.8	17.5	28.8	33.8	150	300	86	0.2										
PST14A110-12400-x	12	400	10.8	13.2	13.7	14.3	14.9	0	33.3	34	38.3	45	23	38	45	150	300	85	0.2										
PST14A110-15300-x	15	300	13.5	16.5	17	17.8	18.6	0	20	20.4	23	27	14	23	27	150	315	87	0.2										
PST14A110-15400-x	15	400	13.5	16.5	17	17.8	18.6	0	26.6	27.2	30.7																		

Output

Electrical Output Data PST14B

General conditions : 25°C ambient.

1) Adjustment below -10% possible as semi-standard versions , consult factory -2) Recycle input voltage or inhibit to restart (>100ms off) - 3) Output voltage 95 % of nominal - 4) Output voltage < 250mV - 5) Nominal input, full load, 20MHz bandwidth - 6) No load to full load, nominal input

Part Number	Output Voltage		Voltage Adjustment (1)			Overvoltage Protection (2)			Output Current			Output Current Limit (3)			Short Circuit Current (4)			Output Noise (5)			Efficiency			Load regulation (6)
	V	W	V	Typ.	Max.	V	Typ.	Max.	A	Typ.	Max.	A	Typ.	Max.	A	Typ.	Max.	mVpp	Typ.	Max.	%	Typ.	Max.	%
	Nom.	Nom.	Min.	Typ.	Max.	Min.	Typ.	Max.	Min.	Typ.	Max.	Min.	Typ.	Max.	Min.	Typ.	Max.	Min.	Typ.	Max.	Min.	Typ.	Max.	Typ.
12Vin																								
PST14B12-3V375-x	3.3	75.0	3.0	3.63	4.1	4.3	4.5	0	22.7	23.1	26	31	15.5	26	31	60	100	77						0.2
PST14B12-575-x	5.0	75.0	4.5	5.5	6	6.25	6.5	0	15	15.3	17.5	20.5	10.5	17.5	20.5	150	300	73						0.2
PST14B12-12125-x	12.0	125.0	10.8	13.2	13.7	14.3	14.9	0	10.4	10.6	12	14.1	7.3	12	14.1	150	350	80						0.2
PST14B12-15150-x	15.0	150.0	13.5	16.5	17	17.8	18.6	0	10	10.2	11.5	13.5	7	11.5	13.5	200	350	80						0.2
PST14B12-24150-x	24.0	150.0	21.6	26.4	27	28	29.2	0	6.25	6.4	7.2	9.3	4.4	7.2	9.3	250	400	80						0.2
PST14B12-28150-x	28.0	150.0	25.2	30.8	31	32.7	34	0	5.3	5.4	6.1	7.3	3.7	6.2	7.3	200	400	80						0.2
PST14B12-36150-x	36.0	150.0	32.4	39.6	40	42	43.5	0	4.1	4.2	4.8	5.7	2.9	4.8	5.7	200	400	79						0.2
PST14B12-48150-x	48.0	150.0	43.2	52.8	53.5	56	58	0	3.1	3.2	3.6	4.3	2.2	3.6	4.3	200	400	81						0.2
24Vin																								
PST14B24-3V3100-x	3.3	100	3.0	3.63	4.1	4.3	4.5	0	30	30.9	35	41	21	35	41	75	100	80						0.2
PST14B24-3V3150-x	3.3	150	3.0	3.63	4.1	4.3	4.5	0	45	46.4	52	61	32	52	61	100	200	80						0.2
PST14B24-5150-x	5	150	4.5	5.5	6	6.25	6.5	0	30	30.6	34	40	5.8	34	40	50	75	84						0.2
PST14B24-5200-x	5	200	4.5	5.5	6	6.25	6.5	0	40	40.8	52	55	28	52	62	80	125	83						0.2
PST14B24-6V5200-x	6.5	200	5.9	7.15	7.7	8	8.3	0	30.5	31.4	35	41	21	35	41	150	230	84						0.2
PST14B24-8200-x	8	200	7.2	8.8	9.3	9.7	10.2	0	25	25.5	29	34	17	29	34	150	250	86						0.2
PST14B24-12150-x	12	150	10.8	13.2	13.7	14.3	14.9	0	12.5	12.8	14.4	17	8.5	14.4	17	100	200	87						0.2
PST14B24-12200-x	12	200	10.8	13.2	13.7	14.3	14.9	0	16.6	17	19	23	11.5	19	23	250	400	85						0.2
PST14B24-12250-x	12	250	10.8	13.2	13.7	14.3	14.9	0	20.8	21.3	24	29	14.5	24	29	150	250	86						0.2
PST14B24-15150-x	15	150	13.5	16.5	17	17.8	18.6	0	10	10.2	11.5	13.5	7	11.5	13.5	150	250	87						0.2
PST14B24-15200-x	15	200	13.5	16.5	17	17.8	18.6	0	13.3	13.5	16	17.3	13.5	16	17.3	150	300	86						0.2
PST14B24-24150-x	24	150	21.6	26.4	27	28	29.2	0	6.25	6.4	7.2	8.4	3.7	7.2	8.4	120	250	87						0.2
PST14B24-24200-x	24	200	21.6	26.4	27	28	29.2	0	8.33	8.5	9.8	11.5	5.9	9.8	11.5	150	250	87						0.2
PST14B24-24250-x	24	250	21.6	26.4	27	28	29.2	0	10.4	10.6	12	14.1	7	12	14.1	150	300	86						0.2
PST14B24-28150-x	28	150	25.2	30.8	31	32.7	34	0	5.3	5.5	6.1	7.2	3.7	6.1	7.2	150	250	87						0.2
PST14B24-28200-x	28	200	25.2	30.8	31	32.7	34	0	7.1	7.3	8.2	9.6	5	8.2	9.6	150	225	86						0.2
PST14B24-28250-x	28	250	25.2	30.8	31	32.7	34	0	8.9	9.1	10.3	12.1	6.3	10.3	12.1	100	175	88						0.2
PST14B24-36150-x	36	150	32.4	39.6	40	42	43.5	0	4.17	4.25	4.8	5.7	2.9	4.8	5.7	120	250	87						0.2
PST14B24-36200-x	36	200	32.4	39.6	40	42	43.5	0	5.5	5.67	6.4	7.5	4	6.4	7.5	120	250	87						0.2
PST14B24-48150-x	48	150	43.2	52.8	53.5	56	58	0	3.1	3.2	3.6	4.2	2.2	3.6	4.2	100	150	87						0.2
PST14B24-48200-x	48	200	43.2	52.8	53.5	56	58	0	4.1	4.25	4.8	5.7	2.9	4.8	5.7	150	250	87						0.2
PST14B24-48250-x	48	250	43.2	52.8	53.5	56	58	0	5.2	5.3	6	7	3.6	6	7	150	250	88						0.2
48Vin																								
PST14B48-3V3150-x	3.3	150	3.0	3.63	4.1	4.3	4.5	0	45	46.4	52	61	32	52	61	75	100	81						0.2
PST14B48-5200-x	5	200	4.5	5.5	6	6.25	6.5	0	40	41	46	52	28	46	56	75	120	84						0.2
PST14B48-12250-x	12	250	10.8	13.2	13.7	14.3	14.9	0	20.8	21.3	24	27.3	14.6	24	26.2	200	400	86						0.2
PST14B48-15250-x	15	250	13.5	16.5	17	17.8	18.6	0	16.6	17	19	22	11.5	19	22	120	200	88						0.2
PST14B48-24250-x	24	250	21.6	26.4	27	28	29.2	0	10.4	10.7	12	13.7	7.3	12	13.7	150	275	88						0.2
PST14B48-28250-x	28	250	25.2	30.8	31	32.7	34	0	9	9.1	10.3	12.1	5	10.3	12.1	120	220	88.5						0.2
PST14B48-36250-x	36	250	32.4	39.6	40	42	43.5	0	6.9	7.1	7.9	9.4	4.8	8	9.4	150	315	88.5						0.2
PST14B48-48250-x	48	250	43.2	52.8	53.5	56	58	0	5.2	5.3	6	7.3	2.1	6	7.3	100	180	89						0.2
PST14B48-48300-x	48	300	43.2	52.8	53.5	56	58	0	6.25	6.4	7.2	8.4	4.5	7.2	8.4	80	150	89						0.2
72Vin																								
PST14B72-3V3100-x	3.3	100	3.0	3.63	4.1	4.3	4.5		30.3	30.9	35	41	21	35	41	120	150	81						0.2
PST14B72-5150-x	5	150	4.5	5.5	6	6.25	6.5		30	30.9	35	41	21	35	41	100	230	84						0.2
PST14B72-8150-x	8	150	7.2	8.8	9.3	9.7	10.2		18.7	19.1	21.6	25.5	5	21	25.5	150	220	84.5						0.2
PST14B72-12250-x	12	250	10.8	13.2	13.7	14.3	14.9		20.8	21.3	24	28	14.5	24	28	150	350	86						0.2
PST14B72-15250-x	15	250	13.5	16.5	17	17.8	18.6		16.6	17	19	22.6	11.5	19	22.6	250	400	86						0.2
PST14B72-24250-x	24	250	21.6	26.4	27	28	29.2		10.4	10.6	12	14.1	7	12	14.1	150	270	86						0.2
PST14B72-28250-x	28	250	25.2	30.8	31	32.7	34		8.9	9.1	10.3	12.1	6.3	10.3	12.1	150	330	88						0.2
PST14B72-36250-x	36	250	32.4	39.6	40	42	43.5		6.9	7.1	8.2	9.4	5	8.2	9.4	150	250	87						0.2
PST14B72-48250-x	48	250	43.2	52.8	53.5	56	58		5.2	5.3	6	7.1	3.6	6	7.1	150	250	86						0.2
110Vin																								
PST14B110-3V375-x	3.3	75	3.0	3.63	4.1	4.3	4.5		22.7	23.1	26	30.7	16	26	30.7	75	100	81						0.2
PST14B110-3V3100-x	3.3	100	3.0	3.63	4.1	4.3	4.5		30.3	30.9	35	41	21	35	41	75	100	81						0.2
PST14B110-5100-x	5	100	4.5	5.5	6	6.25	6.5		20	20.4	23	27.3	14	23	27	150	300	80						0.2
PST14B110-5150-x	5	150	4.5	5.5	6	6.25	6.5		30	30.6	34	41	21	35	41	75	120	84						0.2
PST14B110-8150-x	8	150	7.2	8.8	9.3	9.7																		

Output

Electrical Output Data PST14C

General conditions : 25°C ambient.

1) Adjustment below -10% possible as semi-standard versions , consult factory -2) Recycle input voltage or inhibit to restart (>100ms off) - 3) Output voltage 95 % of nominal - 4) Output voltage < 250mV - 5) Nominal input, full load, 20MHz bandwidth - 6) No load to full load, nominal input

Part Number	Output Voltage		Voltage Adjustment (1)			Overvoltage Protection (2)			Output Current			Output Current Limit (3)			Short Circuit Current (4)			Output Noise (5)			Efficiency			Load regulation (6)			
	V	W	V	Min.	Typ.	Max.	V	Min.	Typ.	Max.	A	Min.	Typ.	Max.	A	Min.	Typ.	Max.	mVpp	Min.	Typ.	Max.	%	Min.	Typ.	Max.	%
	Nom.	Nom.	Min.	Typ.	Max.	Min.	Typ.	Max.	Min.	Typ.	Max.	Min.	Typ.	Max.	Min.	Typ.	Max.	Min.	Typ.	Max.	Min.	Typ.	Max.	Min.	Typ.	Max.	Typ.
12Vin																											
PST14C12-3V350-x	3.3	50.0	3.0	3.63	4.1	4.3	4.5	0	15.1	15.5	17.5	23.4	10.6	17.5	20.6				100	225			70.5				0.2
PST14C12-550-x	5	50.0	4.5	5.5	6	6.25	6.5	0	10	10	11.5	13.5	7	11.5	13.5				100	160			76				0.2
PST14C12-12100-x	12	100.0	10.8	13.2	13.7	14.3	14.9	0	8.3	8.4	9.5	11.3	5.8	9.6	11.3				125	250			79				0.2
PST14C12-15100-x	15	100.0	13.5	16.5	17	17.8	18.6	0	6.7	6.8	7.8	9.1	4.6	7.8	9.1				125	250			79.5				0.2
PST14C12-24100-x	24	100.0	21.6	26.4	27	28	29.2	0	4.1	4.2	4.8	5.7	2.9	4.8	5.63				110	225			81.5				0.2
PST14C12-28100-x	28	100.0	25.2	30.8	31	32.7	34	0	3.6	3.6	4.15	5.4	2.5	4.15	5.4				100	200			79.5				0.2
PST14C12-36100-x	36	100.0	32.4	39.6	40	42	43.5	0	2.8	2.85	3.2	3.8	1.9	3.2	3.8				100	225			80				0.2
PST14C12-48100-x	48	100.0	43.2	52.8	53.5	56	58	0	2.1	2.12	2.4	3.4	1.45	2.4	3.4				90	157			79				0.2
24Vin																											
PST14C24-3V350-x	3.3	50.0	3.0	3.63	4.1	4.3	4.5	0	15.1	15.5	17.5	21	10.5	17.5	20.6				120	300			78				0.2
PST14C24-3V375-x	3.3	75.0	3.0	3.63	4.1	4.3	4.5	0	22.7	23	26	31	15.9	26	31				100	175			78				0.2
PST14C24-550-x	5	50.0	4.5	5.5	6	6.25	6.5	0	10	10.2	11.5	13.5	8	11.5	13.5				90	100			83				0.2
PST14C24-5100-x	5	100.0	4.5	5.5	6	6.25	6.5	0	20	20.3	23	27	2.5	23	27				90	125			83				0.2
PST14C24-5125-x	5	125.0	4.5	5.5	6	6.25	6.5	0	25	25.5	29	34	17	29	34				100	190			83				0.2
PST14C24-8100-x	8	100.0	7.2	8.8	9.3	9.7	10.2	0	12.5	12.7	14.5	17	8.5	14.5	17				100	185			85				0.2
PST14C24-1250-x	12	50.0	10.8	13.2	13.7	14.3	14.9	0	4.1	4.2	4.8	5.7	2.9	4.8	5.7				80	100			87				0.2
PST14C24-12100-x	12	100.0	10.8	13.2	13.7	14.3	14.9	0	8.3	8.5	9.5	11	1.1	9.5	11				150	260			85				0.2
PST14C24-12150-x	12	150.0	10.8	13.2	13.7	14.3	14.9	0	12.5	12.8	14.4	17	8.5	14.4	17				120	215			87				0.2
PST14C24-1550-x	15	50.0	13.5	16.5	17	17.8	18.6	0	3.3	3.4	3.8	4.5	2.33	3.8	4.5				90	200			87				0.2
PST14C24-15100-x	15	100.0	13.5	16.5	17	17.8	18.6	0	6.7	6.8	7.7	8.7	4.7	7.7	8.7				75	125			88				0.2
PST14C24-15150-x	15	150.0	13.5	16.5	17	17.8	18.6	0	10	10.2	11.5	13.5	7	11.5	13.5				100	190			88				0.2
PST14C24-2450-x	24	50.0	21.6	26.4	27	28	29.2	0	2.1	2.12	2.4	2.8	1.45	2.4	2.8				75	100			88				0.2
PST14C24-24100-x	24	100.0	21.6	26.4	27	28	29.2	0	4.1	4.25	4.8	5.7	2.9	4.8	5.7				75	100			87				0.2
PST14C24-24150-x	24	150.0	21.6	26.4	27	28	29.2	0	6.3	6.4	7.2	8.4	4.4	7.2	8.4				75	100			87				0.2
PST14C24-2850-x	28	50.0	25.2	30.8	31	32.7	34	0	1.78	1.8	2.1	2.4	1.25	2.1	2.4				75	100			88				0.2
PST14C24-28100-x	28	100.0	25.2	30.8	31	32.7	34	0	3.5	3.6	4.15	5	0.5	4.1	5				75	100			88				0.2
PST14C24-28150-x	28	150.0	25.2	30.8	31	32.7	34	0	5.4	5.5	6.2	7.2	3.8	6.2	7.2				75	150			88				0.2
PST14C24-3650-x	36	50.0	32.4	39.6	40	42	43.5	0	1.39	1.42	1.6	1.9	0.9	1.6	1.9				50	75			84				0.2
PST14C24-36100-x	36	100.0	32.4	39.6	40	42	43.5	0	2.8	2.85	3.2	3.8	1.9	3.2	3.8				50	75			86				0.2
PST14C24-4850-x	48	50.0	43.2	52.8	53.5	56	58	0	1.05	1.06	1.2	1.5	0.7	1.2	1.5				80	150			86				0.2
PST14C24-48100-x	48	100.0	43.2	52.8	53.5	56	58	0	2.1	2.15	2.4	2.9	1.45	2.4	2.9				80	150			86				0.2
PST14C24-48150-x	48	150.0	43.2	52.8	53.5	56	58	0	3.1	3.2	3.8	4.2	2.2	3.8	4.2				75	150			88				0.2
48Vin																											
PST14C48-3V350-x	3.3	50.0	3.0	3.63	4.1	4.3	4.5	0	15.1	15.5	17.5	21	10.5	17.5	21				75	100			79				0.2
PST14C48-3V375-x	3.3	75.0	3.0	3.63	4.1	4.3	4.5	0	22.7	22.9	26	32	15.9	26	32				75	100			80				0.2
PST14C48-550-x	5	50.0	4.5	5.5	6	6.25	6.5	0	10	10.2	11.5	13.5	7	11.5	13.5				75	120			84				0.2
PST14C48-575-x	5	75.0	4.5	5.5	6	6.25	6.5	0	15	15.3	17.5	20	10.5	17.5	20.6				75	100			82				0.2
PST14C48-5100-x	5	100.0	4.5	5.5	6	6.25	6.5	0	20	20.5	23	26	14	23	26				70	100			84				0.2
PST14C48-8100-x	8	100.0	7.2	8.8	9.3	9.7	10.2	0	12.5	12.7	14.4	17	9.7	14.4	17				100	150			87				0.2
PST14C48-8150-x	8	150.0	7.2	8.8	9.3	9.7	10.2	0	18.7	19.1	21.5	26	13	21	26				100	175			86				0.2
PST14C48-1275-x	12	75.0	10.8	13.2	13.7	14.3	14.9	0	6.25	6.35	7.2	8.4	4.4	7.2	8.4				100	200			85				0.2
PST14C48-12150-x	12	150.0	10.8	13.2	13.7	14.3	14.9	0	12.5	12.7	14.4	17	9.7	14.4	17				100	225			87				0.2
PST14C48-1575-x	15	75.0	13.5	16.5	17	17.8	18.6	0	5	5.1	5.7	6.8	3.5	5.7	6.8				70	100			88				0.2
PST14C48-15150-x	15	150.0	13.5	16.5	17	17.8	18.6	0	10	10.2	11.5	13.5	7	11.5	13.5				75	150			87				0.2
PST14C48-2475-x	24	75.0	21.6	26.4	27	28	29.2	0	3.1	3.2	3.6	4.3	0.5	3.6	4.3				50	75			87				0.2
PST14C48-24150-x	24	150.0	21.6	26.4	27	28	29.2	0	6.25	6.37	7.2	9.1	4.4	7.2	9.1				120	200			88				0.2
PST14C48-2875-x	28	75.0	25.2	30.8	31	32.7	34	0	2.6	2.7	3.1	3.6	1.9	3.1	3.6				120	200			88				0.2
PST14C48-28150-x	28	150.0	25.2	30.8	31	32.7	34	0	5.3	5.4	6.1	7	3.7	6.2	7				75	140			88				0.2
PST14C48-36150-x	36	150.0	32.4	39.6	40	42	43.5	0	4.1	4.2	4.8	5.7	2.9	4.8	5.7				80	120			87				0.2
PST14C48-4875-x	48	75.0	43.2	52.8	53.5	56	58	0	1.55	1.6	1.8	2.1	1.1	1.8	2.1				100	175			87				0.2
PST14C48-48150-x	48	150.0	43.2	52.8	53.5	56	58	0	3.1	3.2	3.6																

Parallel and Series Connection

A converter output can be connected in series with an output from a separate converter, an internal diode across each output is implemented internally. The maximum output current of a serial-connected outputs is limited by the output with the lowest current limit. Output voltages above 48V (SELV - Safety Extra Low Voltage) require additional safety measures in order to comply with international safety requirements.

Parallel operation is possible with PST14 Mini & Maxi to increase output power (see below parallelling signal).

Redundant Systems Operation

When systems require a very high level of reliability and should work normally in the event of a failure, N+1 redundancy is implemented where N is the number of converter to support power requirement. If one converter fail, the remaining ones still delivers the power to the loads.

Oring diodes are required to ensure proper N+1 operation (included with optional N+1 bus bar).

Hold-up time

The converter provides limited hold-up time. If a hold-up time is required (some railways applications for example), use external input capacitors of adequate size.

Formula for additional external input capacitor : $C = 2 * P_{out} * t_h * 100 / (V^2 - V_i^2) / n$

whereas :

- C = external input capacitance [mF]
- P_{out} = output power [W]
- n = efficiency [%]
- t_h = hold-up time [ms]
- V_i = minimum input voltage
- V = Input voltage level before interruption

Output Current Limitation

See Electrical output data for value.

The converter output is continuously protected against short-circuit by a constant current limitation. The short circuit protection is unlimited, the operating area between nominal power and active protection area working in a constant current mode may lead to power above nominal, then over stress of the internal components.

Thermal Considerations

The converter is designed to be mounted on a dissipative area, in conduction cooling mode. The max. operating temperature is the temperature of the baseplate which should not exceed 100°C.

Addition of grease or thermal pad between the converter baseplate and the chassis is mandatory .

Thermal protection

A temperature protection is integrated in each Vicor module, disabling output when heatsink temperature exceeds 105°C. The converter automatically restarts, when the temperature drops below this limit. Nevertheless, exceeding the max operating temperature may cause failures of the converter.

Waveforms

Inrush : PST14B48-48250

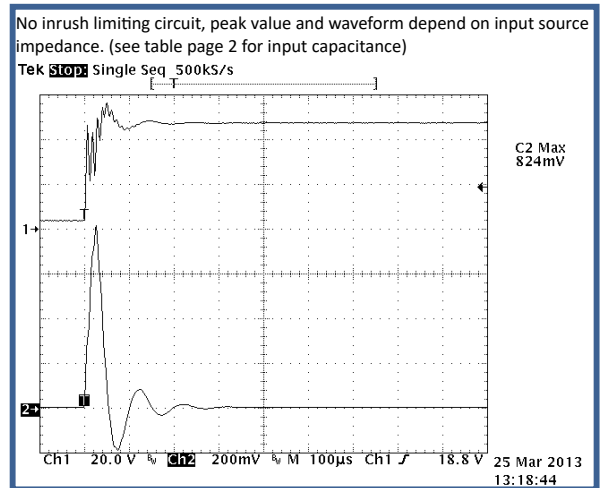

Start-up time : PST14B48-48250

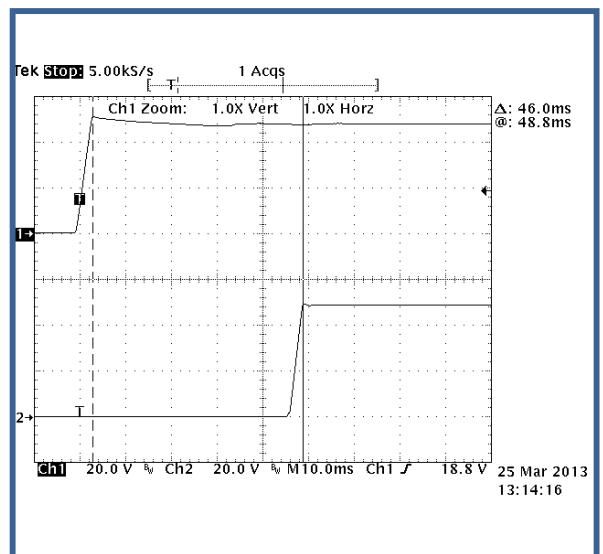

100V 50ms Transient protection (M option) : PST14A24-28400-M

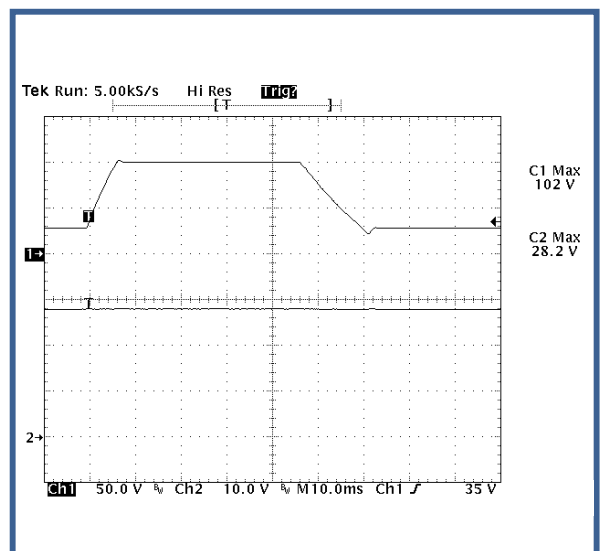

Auxiliary Functions

Primary Inhibit (Remote On/Off)

The inhibit input disables (logic low, pull down or short circuit between INH- and -IN) or enables (logic high TTL, pull up or open-circuit) the converter. This signal is referenced to the input voltage and will disable/enable all outputs at the same time when inhibition & parallel cable is used. In systems consisting of several converters, this feature may be used to sequence the activation of the different converters if inhibition is used separately.

Output Voltage Adjustment

The converter output is adjustable by potentiometer or by an external voltage between trim and -sense (1,23V for nominal). The range of adjustment is +10% around nominal output voltage per default, semi-standard versions can be made with adjustment down to -50% with 10% minimum load. Please consult factory for more details.

Sense Lines

This feature enable compensation of voltage drop across the connector contacts and the load lines. The voltage between any sense line and its respective power output pin (as measured on the connector) should not exceed the following values at nominal output voltage.

Output type	Total drop	Negative line drop
V1	< 0.5V	< 0.25V

Powergood

Two green leds at input & output indicate the presence of output voltages . An open collector PGood signal (J10) is open when output failed or closed when unit operates properly.

Paralleling signal

When several units of the same type are used in parallel or in redundant system, the PR+ PR- of each unit need to be connected together through J4, J11 for accurate current sharing. Accessories cable can be used.

Waveforms

Output Noise (PST14B48-48250)

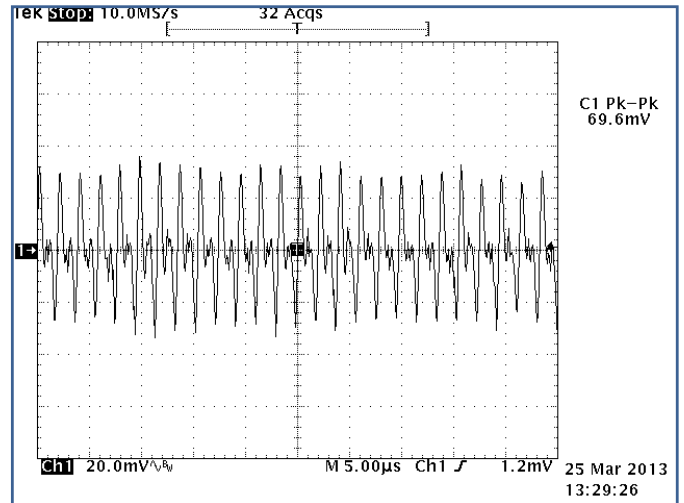

Current Limitation (PST14B48-48250)

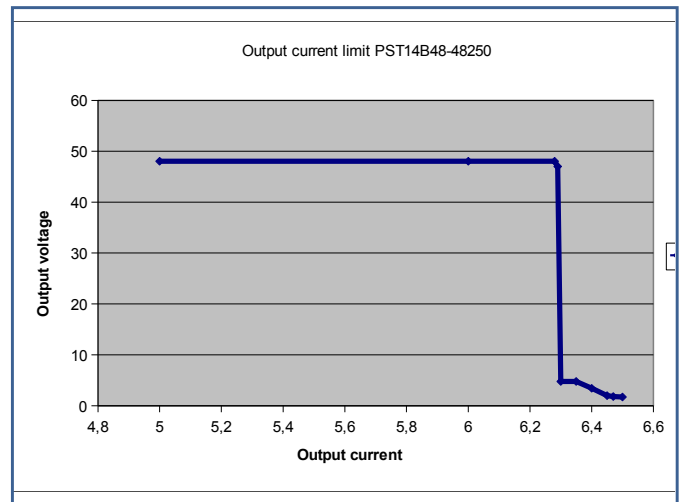

Efficiency vs input & load

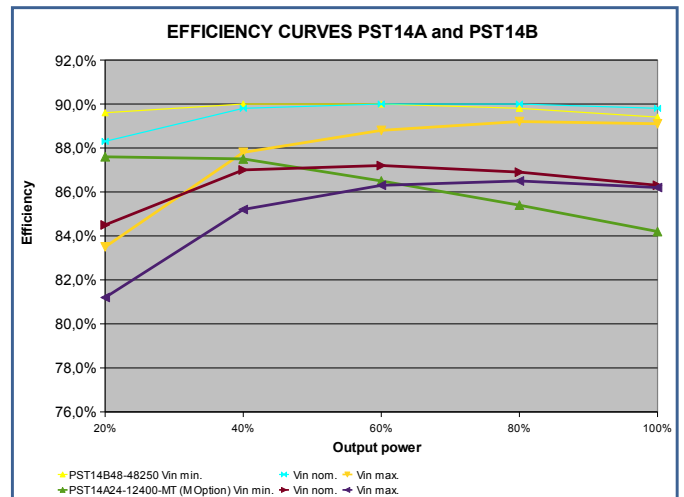

▼ Environmental

Functionalities and compliance table

Functionalities	Conditions	Input 12V			Input 24V			Input 48V			Input 72V			Input 110V		
		PST14A	PST14B	PST14C	PST14A	PST14B	PST14C	PST14A	PST14B	PST14C	PST14A	PST14B	PST14C	PST14A	PST14B	PST14C
Parallel operation	current share with PR connected	√	√		√	√		√	√		√	√		√	√	
Redundant operation	R option or external diode	√	√		√	√		√	√		√	√		√	√	
Series operation		√	√	√	√	√	√	√	√	√	√	√	√	√	√	√
Remote senses		√	√		√	√		√	√		√	√		√	√	
MIL COTS version	M option	√	√	√	√	√	√	√	√	√	√	√	√	√	√	√
Conformal coating	V option	√	√	√	√	√	√	√	√	√	√	√	√	√	√	√
-40°C Operation	T option	√	√	√	√	√	√	√	√	√	√	√	√	√	√	√
MIL-STD-704 A,C,D,E,F, 28V Steady State	M option, built to meet	√	√	√	√	√	√									
MIL-STD-704 A,C,D,E,F 28V Surges High Transients	M option, built to meet	√	√	√	√	√	√									
MIL-STD-704 A,C,D,E,F 28V Surges Low Transients	M option, built to meet	√	√	√	√	√	√									
MIL-STD-704 C,D,E,F 28V Surges Low Transients	M option, built to meet	√	√	√	√	√	√									
MIL-STD-704 A,C,D,E,F 28V Spikes	M option, built to meet	√	√	√	√	√	√									
MIL-STD-810E (Shocks, Vibrations, Accelerations, Humidity)	M,V option built to meet	√	√	√	√	√	√	√	√	√	√	√	√	√	√	√
MIL-STD-461 Conducted Emission CE101, CE102	M option built to meet	√	√	√	√	√	√									
MIL-STD-461 Conducted Susceptibility CS101, 114, 116	M option built to meet	√	√	√	√	√	√									
MIL-STD-1275 A,B,C,D Steady State, Surges and Spikes	100V/50ms, 250V/70uS, M option	√	√		√	√										
RTCA-DO-160E sect.16 cat.Z, Surges	80V/100ms, 48V/1s not meet , M option	√	√	√	√	√	√									
DEF STAN 61-5, Part 6 28V	100V/50ms, M option	√	√	√	√	√	√									
ABD100.1.8 Surge and Normal Transients	M option	√	√	√	√	√	√									
EN50155 Environmental	V option	√	√	√	√	√	√	√	√	√	√	√	√	√	√	√
EN50155, EN55022A, EN55011A, EN50121-3-2	Conduction Emission, built to meet	√	√	√	√	√	√	√	√	√	√	√	√	√	√	√
EN 50155 Input Range and Transient	built to meet	√	√	√	√	√	√	√	√	√	√	√	√	√	√	√

Electromagnetic Immunity

	Standard	Level	Value	Waveform	Source imped.	Test procedure	Mode
Supply surge	EN50155	B	1,4 * VIN	0,1 / 1 / 0,1 s	1 Ohm	1 positive surge	OP
Direct transients	EN50155	D	1800V	5 / 50 μs	5 Ohms	5 pos., 5 neg.	OP
Surges	EN 61000-4-5	3	2000V	1,2 / 50 μs	12 ohms		OP
Electrostatic discharge (to case)	EN 6100-4-2	4	8000V	1 / 50μs	330 Ohms	10 pos., 10neg.	OP
Electrical fast transients/burst	EN 61000-4-4	4	4000V	5 / 50μs	50 ohms		OP

Immunity to Environmental Conditions

Test method	Standard	Test conditions	Status
Damp Heat	MIL STD 810E Proc. 507-2	Humidity 93 %, 40°C, 56 days	Conformal coating option only, built to meet
Shock	MIL STD 810E Proc.516.3 EN 50155	20g / 11ms 5g / 30ms	Built to meet M option M option
Vibrations	MIL STD 810E Proc. 514-3		Built to meet M option

Electromagnetic

Electromagnetic Emissions PST14A

Level according to EN55022A, peak detector, average limit, PST14A24-24400, 400W

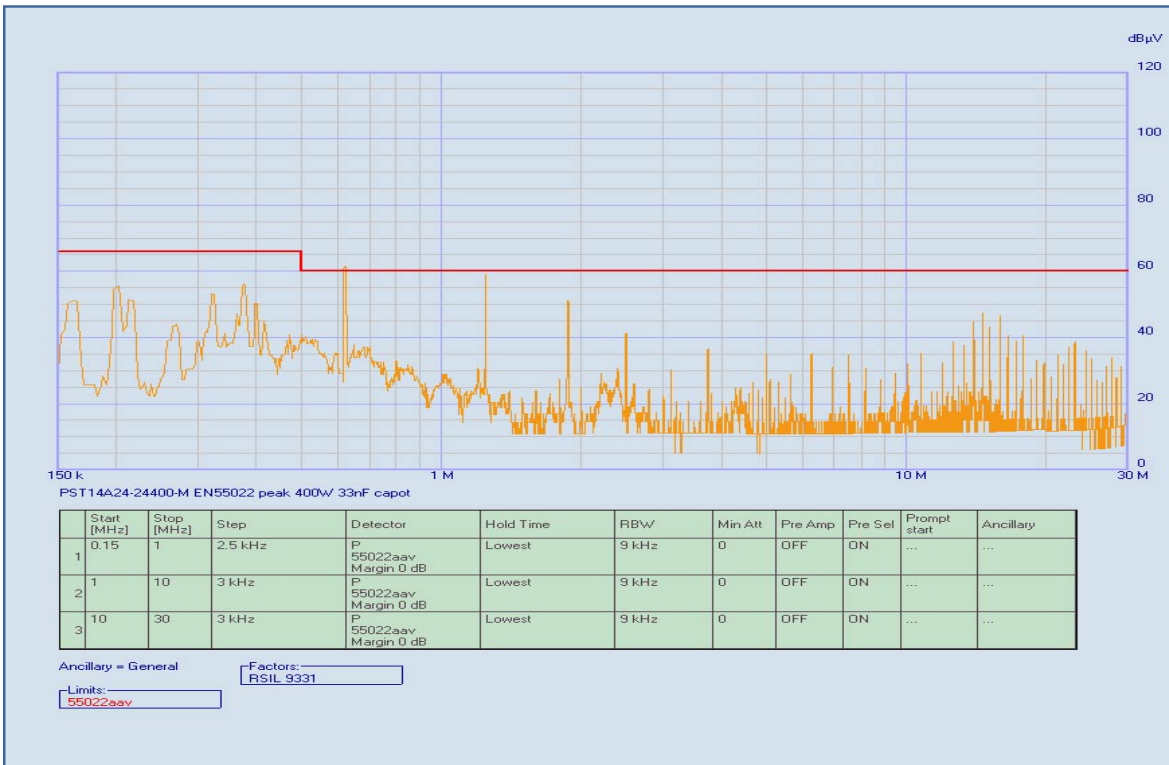

MIL STD461 CE102, peak detector, 28V limit, PST14A24-24400-M, 400W

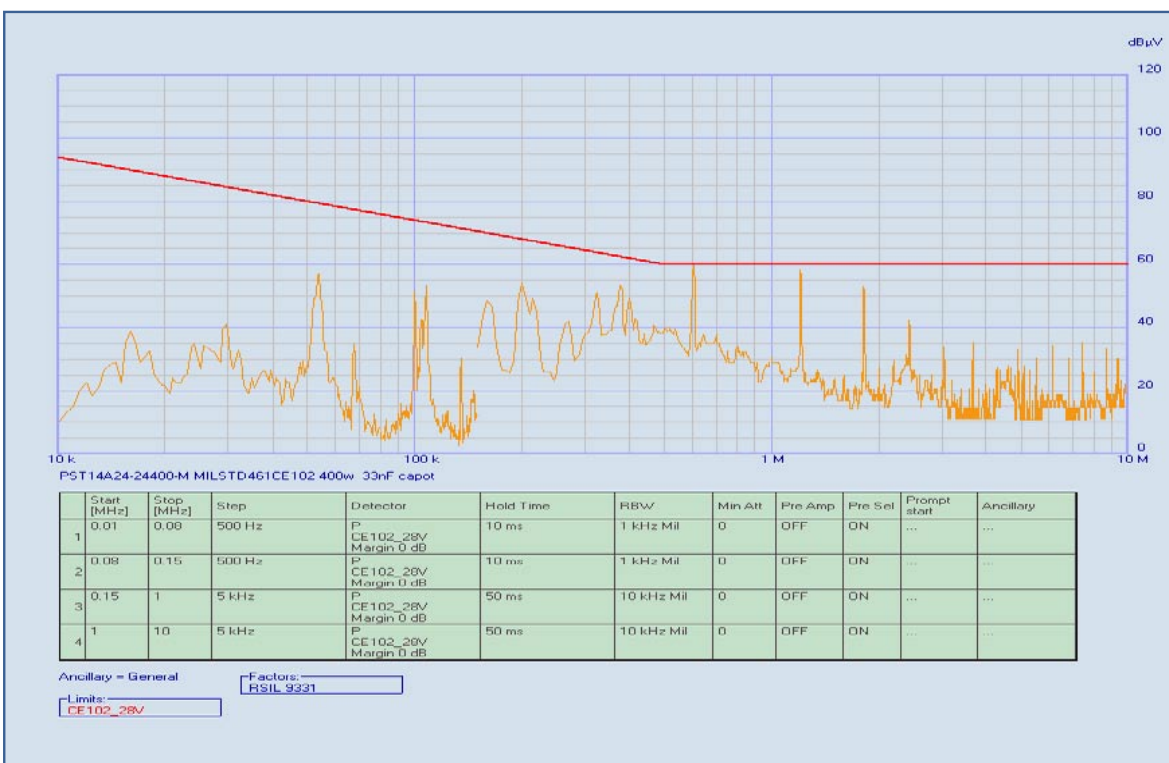

Electromagnetic

Electromagnetic Emissions PST14B

Level according to EN55022A, peak detector, average limit, PST14B28-12200, 200W

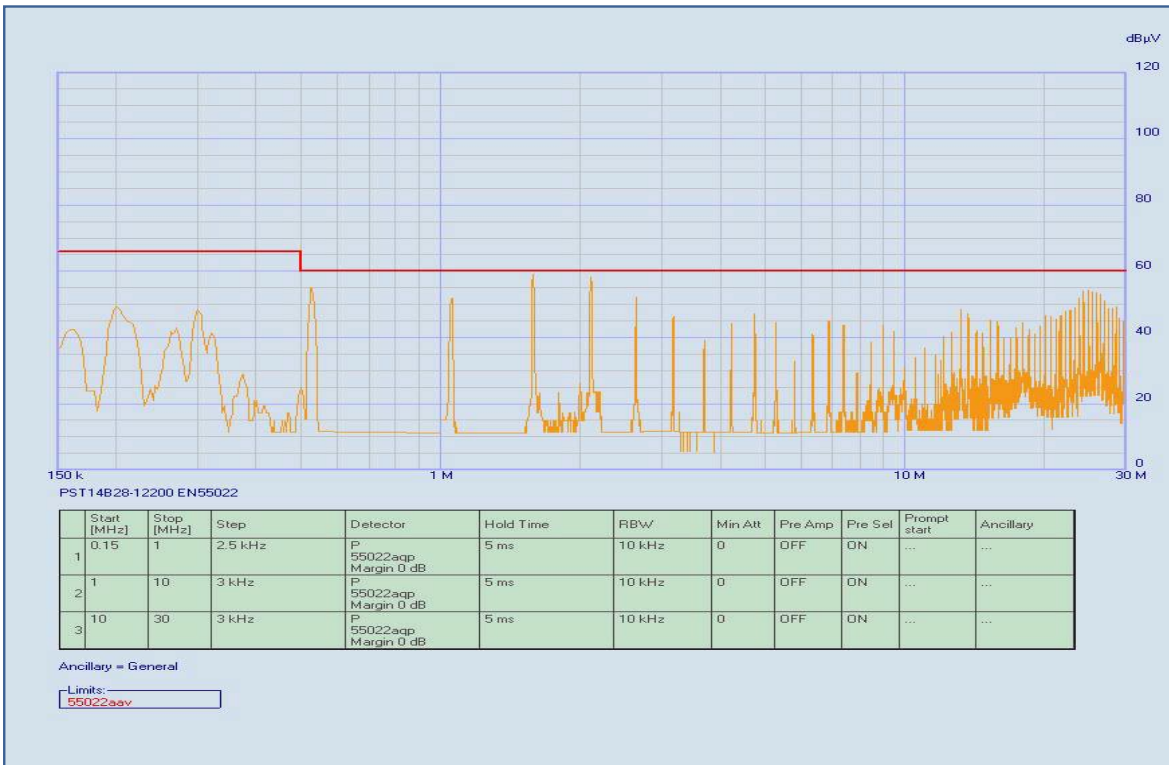

MIL STD461 CE102, peak detector, 28V limit, PST14B28-12200-M, 200W

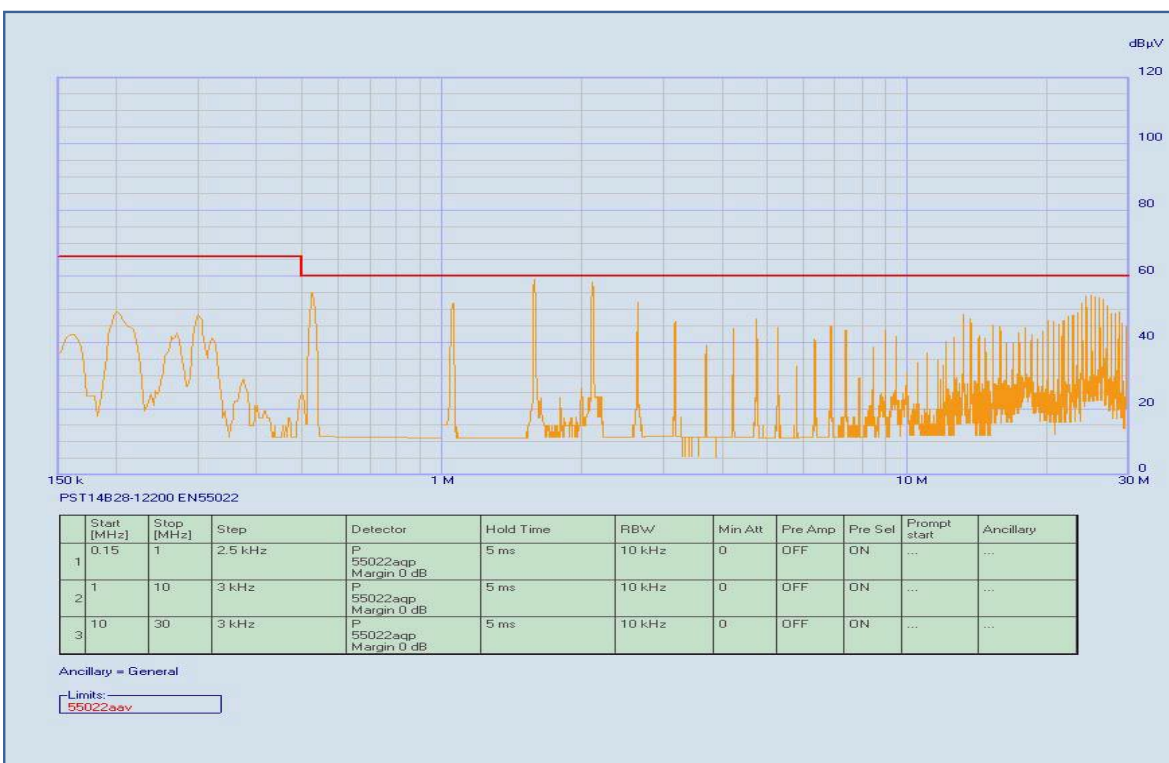

▼ Electromagnetic

Electromagnetic Emissions PST14C

Level according to EN55022A, peak detector, average limit, PST14C24-12100, 100W

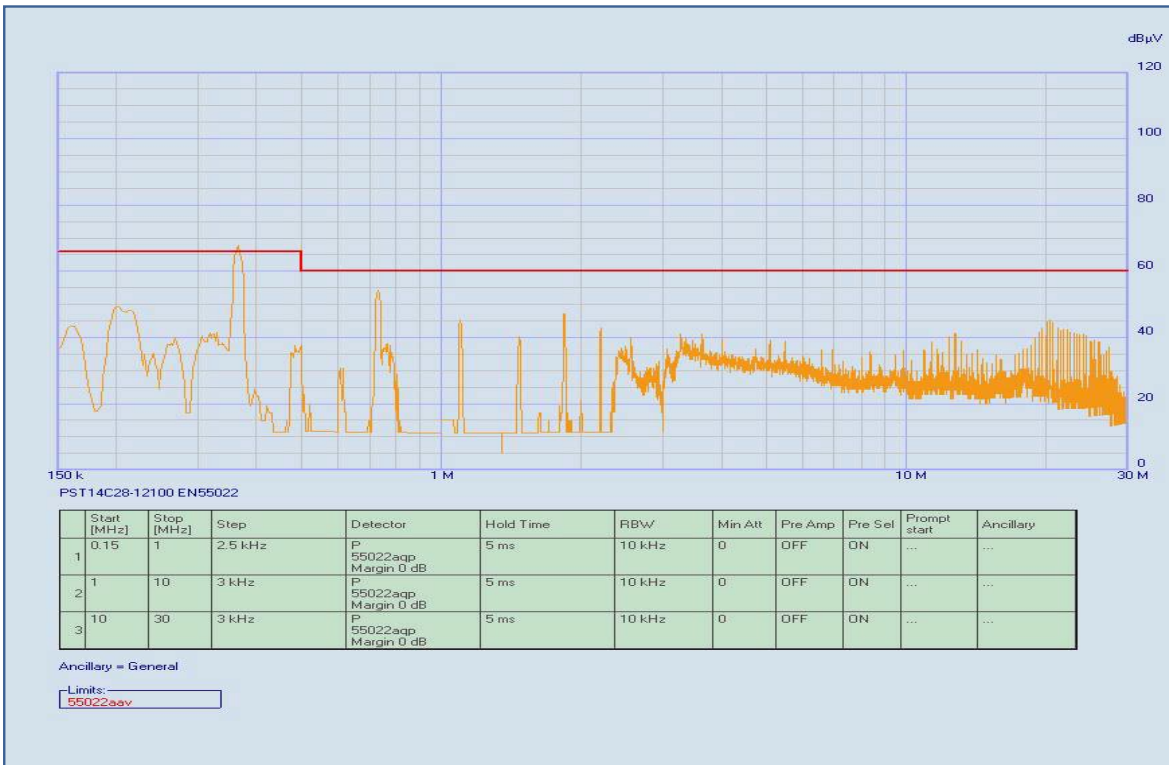

▼ Safety and Installations Instructions

Connector Pin Allocation

PIN	Description	
Press Fit M4 : Wurth ref. 7461095		
J1	INPUT +	
J2	INPUT -	
J5	+V1	Positive output voltage
J6	-V1	Negative output voltage

J3 : JST 3pts CMS ref. BM03B-SRSS-TB (LFSN)		
J3-1	INH +	See inhibition signal for description
J3-2	INPUT -	
J3-3	INH -	

J4 : JST 4pts CMS ref. BM04B-SRSS-TB (LFSN)		
J4-1	PR-	Parallel signal for multi unit connection
J4-2	PR+	Parallel signal for multi unit connection
J4-3	INH -	Inhibition signal for multi unit connection
J4-4	INH +	Inhibition signal for multi unit connection

J10 : JST 5pts CMS ref. BM05B-SRSS-TB (LFSN)		
J10-1	+ Sense V1	Positive remote sense
J10-2	Pgood -	Power Good emittor
J10-3	Pgood +	Power Good collector
J10-4	Trim	Voltage adjustment
J10-5	-Sense V1	Negative remote sense

J11 : JST 4pts CMS ref. BM04B-SRSS-TB (LFSN)		
J11-1	INH +	Inhibition signal for multi unit connection
J11-2	INH -	Inhibition signal for multi unit connection
J11-3	PR+	Parallel signal for multi unit connection
J11-4	PR-	Parallel signal for multi unit connection

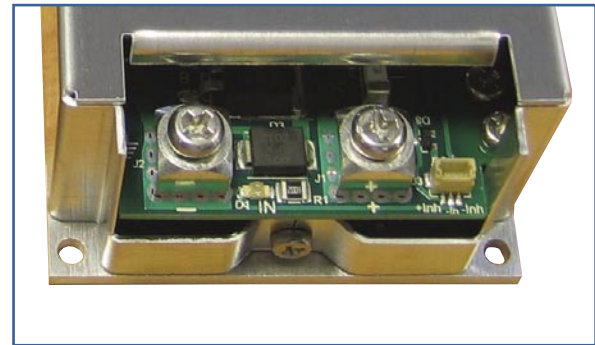

Installations Instructions

These converters are components, intended exclusively for integration into other equipment by an industrial assembly process or by a professionally competent person. Installation must strictly follow the safety regulations in respect of the enclosure, mounting, creepage and clearance distances, markings of the end-use application.

Connection to the system shall be made via appropriate connection. The +Vin is internally fused. This fuse is designed to protect the converter against overcurrent caused by a failure, but may not be able to satisfy all requirements. External fuses in the wiring circuit to one or both input pins may be necessary to ensure compliance with local requirements.

Do not open the converters, or the warranty will be invalidated. Make sure that there is sufficient heat dissipation available for conduction cooling. This should be verified by measuring the case of temperature at the specified measuring point, when the converter is operated in the end-use application.

Standards and Approvals

The converters are built to meet the safety standards IEC 60950-1, EN 60950-1.

'Built to meet' mentioned in the different paragraphs of the datasheet means that Power System Technology has designed the product to meet the standard but not certified it in a laboratory.

Electric Strength

Characteristic		Input to Earth	Input to Output	Output to Earth	Output to Output	Unit
Electric strength	Design strength	1500	3000	500		Vrms
	Factory test for production units (>10s)	2000	2000	500		Vdc
Insulation resistance				> 100	>100	Mohms

Temperatures

Conditions		Standard			T option			Unit
		Min.	Typ.	Max.	Min.	Typ.	Max.	
Baseplate or Heatsink	Operating	-20		+100	-40		+100	°C
Storage	Not operating	-40		+125	-40		+125	

Reliability

MIL-HDBK-217F, notice 2	Model	Heatsink Temp.	GB	GF
MTBF (Hours)	PST14A24-24400	40°C	1554000	777000
		70°C	914800	457400
		100°C	574810	287400

Cleaning Agents and Process

The converters are not hermetically sealed. In order to avoid possible damage, any penetration of liquids shall be avoided.

Railway Application

The converters have been designed observing the railway standards EN 50155 and EN 50121. All boards can be protected by a conformal coating as an option (-V).

Isolation

The electric strength test is performed in the factory in accordance with IEC/EN 60950.

Mechanical data

PST14A
Weight : 0.585 Kg

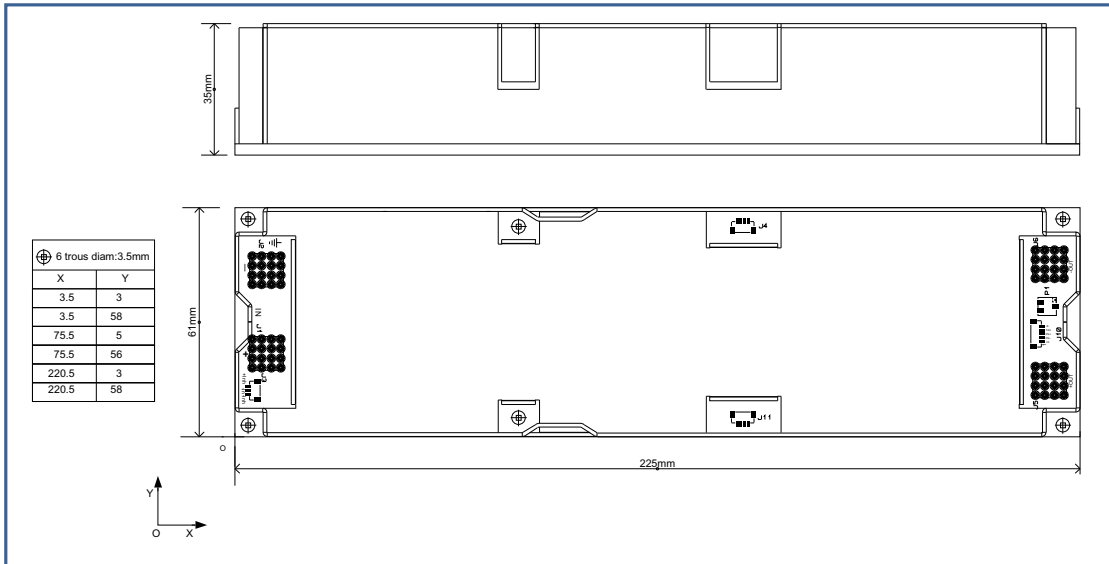

PST14B
Weight : 0.320 Kg

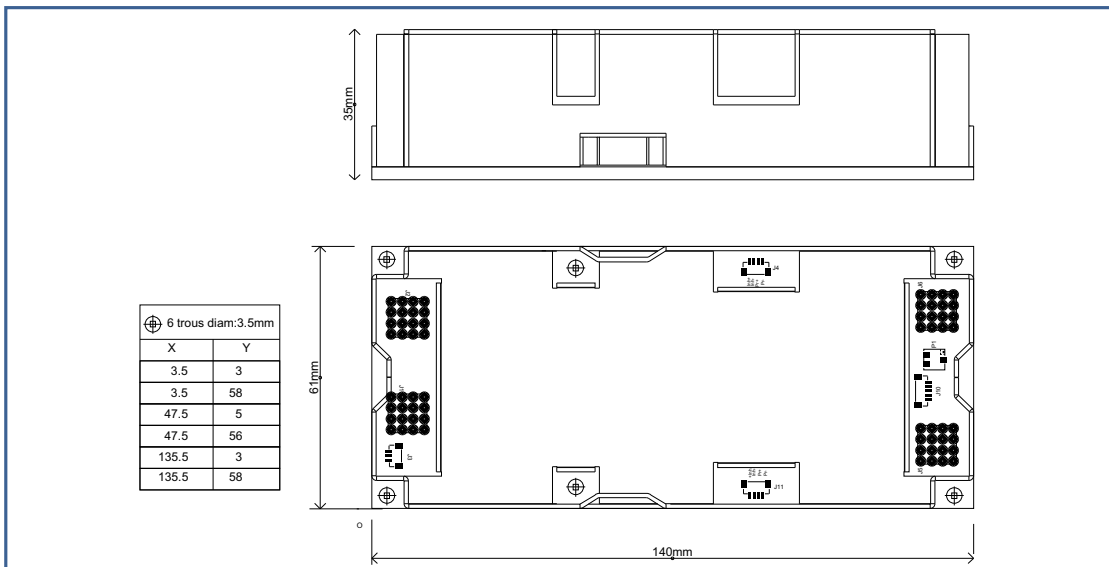

PST14C
Weight : 0.240 Kg

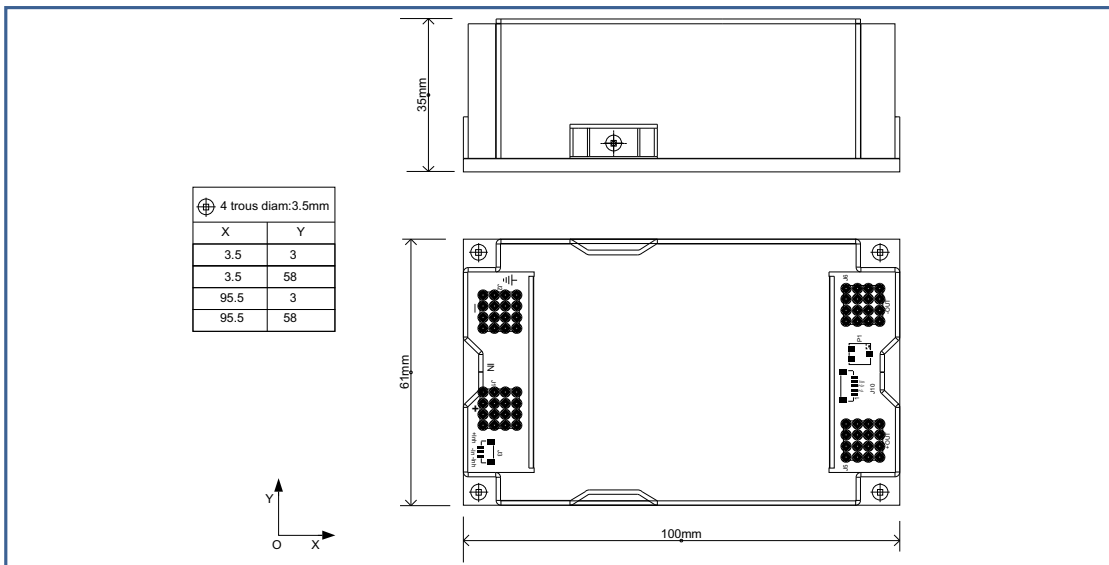

PST14A H1 option + assembly example

PST14A with H1 option

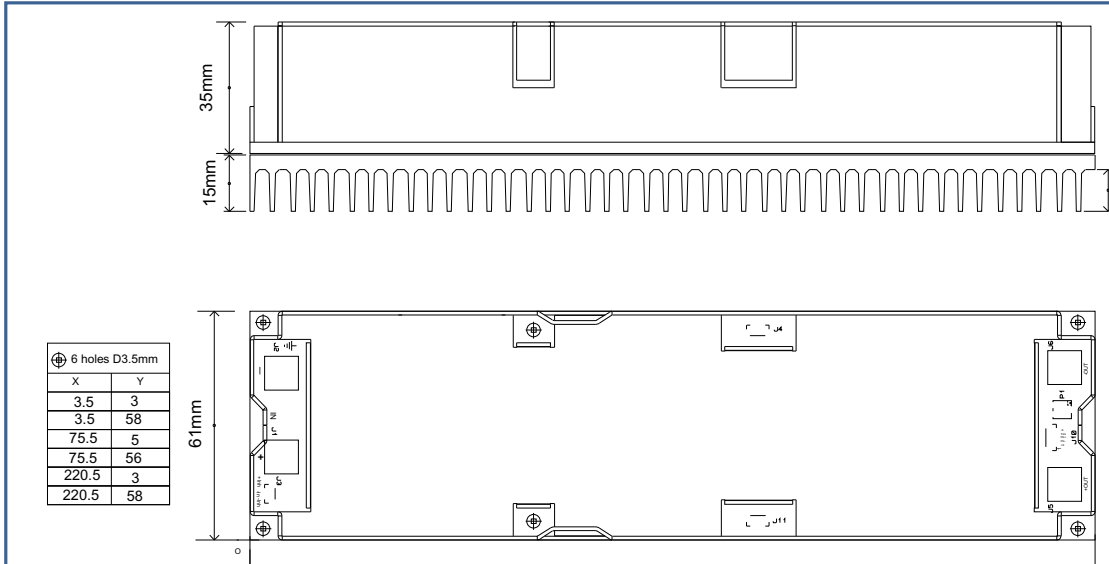

Example of PST14 assembly, 1500W, redundancy 3+1 mounted on heatsink for cabinet integration

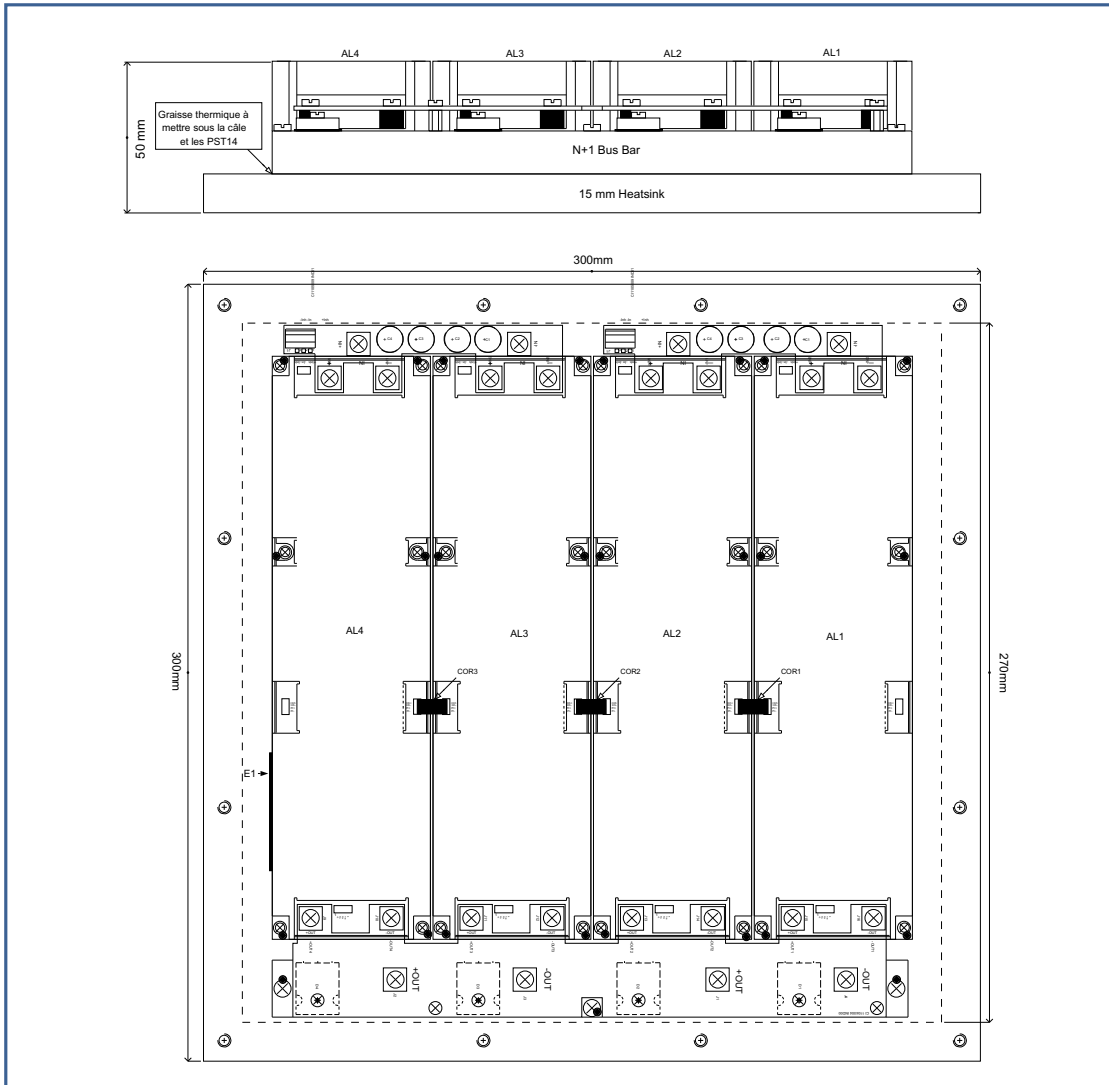

Accessories data

Input bus bar 2up & 3up (footprint only for capacitors & screw connector)

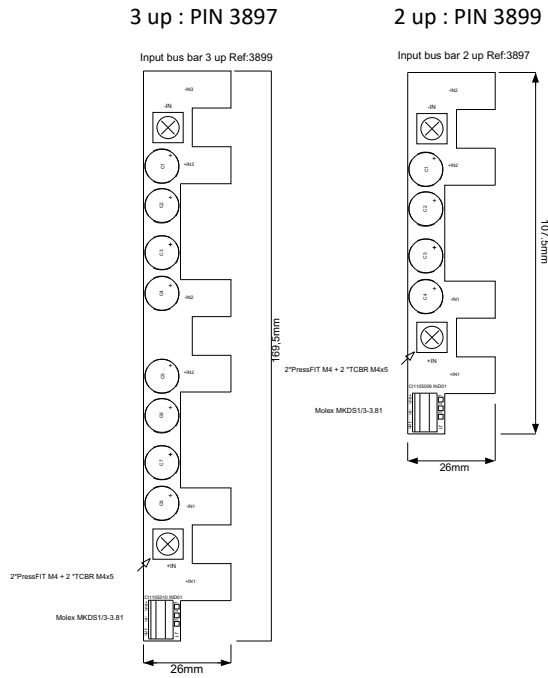

Output parallel bus bar

Output serial bus bar

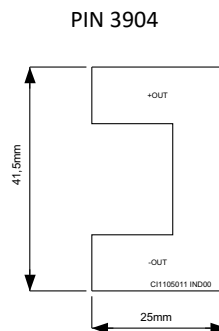
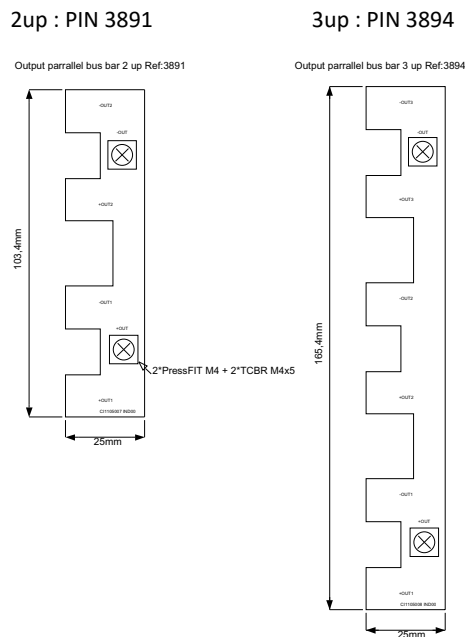

Accessories data

Output N+1 bus bar

1up : PIN 3943 : from 3V3 to 12V/80A
 1 up : PIN 3939 from 15V to 48V/40A

2up : PIN 3938

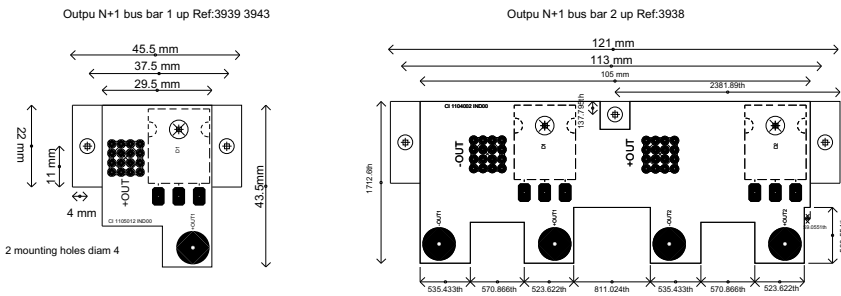

Output N+1 bus bar

3up : PIN 3812

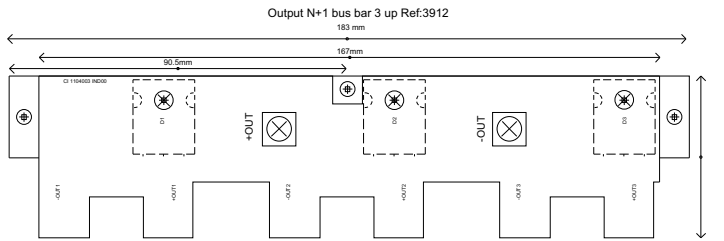

4up : PIN 3855

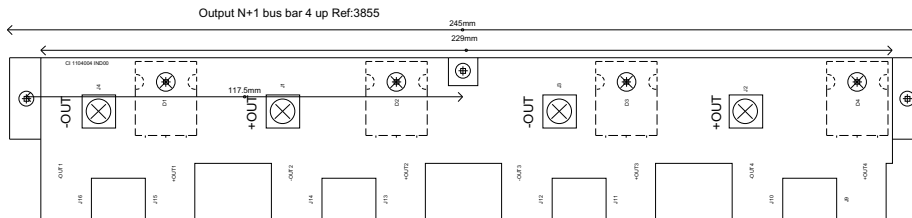

Cables

Inhibition & parallel connexion cable for multi unit integration

4 Fils or multibrun Ga je 28AWG longueur:50mm

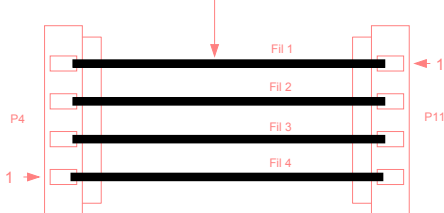

2 x Fiche JST réf: SHR-04V-S-B avec 8 contacts femelles réf:SSH-003T-P0.2

PIN 3704

Inhibition connection cable for multi unit integration

2 Fils noir multibrun Ga je 28AWG longueur:50mm

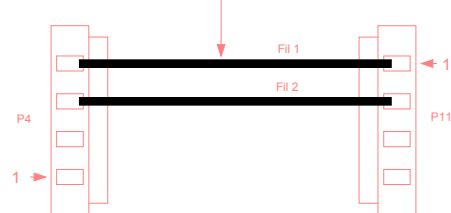

2 x Fiche JST réf: SHR-04V-S-B avec 4 contacts femelles réf:SSH-003T-P0.2

PIN 3879

Options and configurations

PST14A : MAXI

For single configurations see page 3.

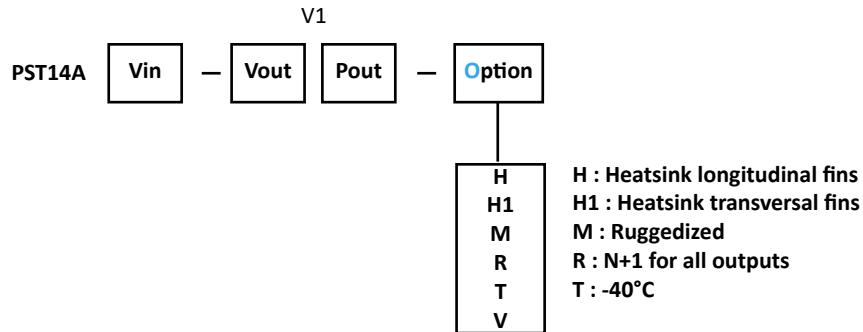

For multiple combination of the **same package**, use P/N as follows.
 Units will be delivered with accessories mounted (Bus bar for parallel & serial , N+1).

Example :

2up 2 outputs (see page 3 for V1P1 & V2P2)

PST14A [Vin]-V1P1-V2P2-O

2up 1 output

PST14A [Vin]-V1P-O

1 output of P1+P2 where P1=P2
 (do not put in parallel 2 different power)

3up 3 outputs

PST14A Vin -V1P1-V2P2-V3P3-O

3up 2 outputs

PST14A Vin -V1P-V2P2-O
 PST14A Vin -V1P1-V2P2-O

(P = 2 x P1)

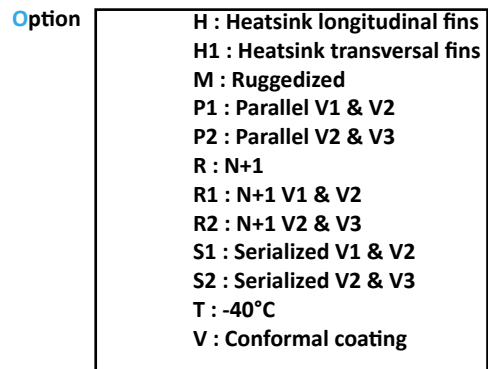
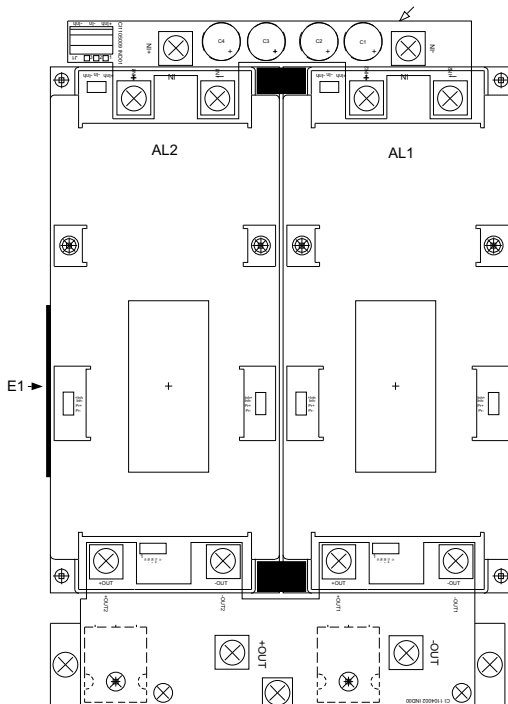

PST14B : MINI

For single configurations see page 4.

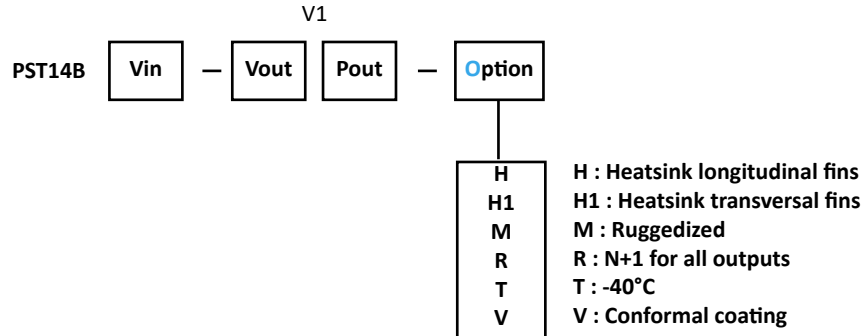

For multiple combination of the **same package**, use P/N as follows.
Units will be delivered with accessories mounted (Bus bar for parallel & serial , N+1).

Example :

- 2up 2 outputs (see page 3 for V1P1 & V2P2) **PST14B [Vin]-V1P1-V2P2-O**
- 2up 1 output **PST14B [Vin]-V1P-O** 1 output of P1+P2 where P1=P2
(do not put in parallel 2 different power)
- 3up 3 outputs **PST14B Vin -V1P1-V2P2-V3P3-O**
- 3up 2 outputs **PST14B Vin -V1P-V2P2-O** (P = 2 x P1)
 PST14B Vin -V1P1-V2P2-O

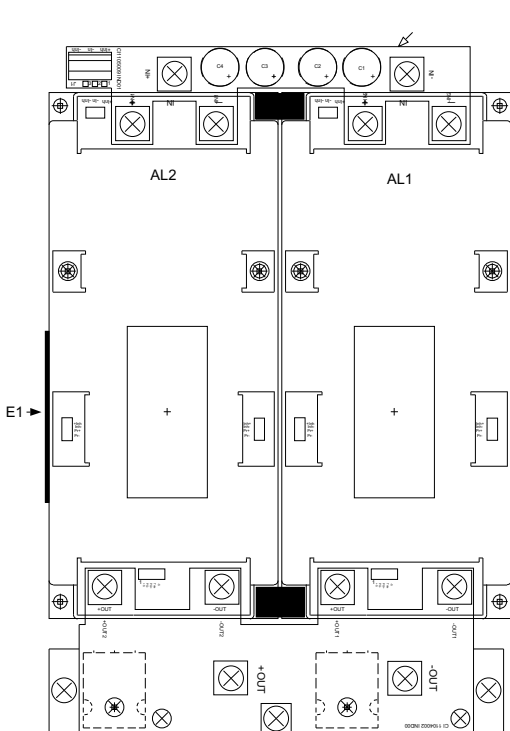

Option

H	H : Heatsink longitudinal fins
H1	H1 : Heatsink transversal fins
M	M : Ruggedized
P1	P1 : Parallel V1 & V2
P2	P2 : Parallel V2 & V3
R	R : N+1
R1	R1 : N+1 V1 & V2
R2	R2 : N+1 V2 & V3
S1	S1 : Serialized V1 & V2
S2	S2 : Serialized V2 & V3
T	T : -40°C
V	V : Conformal coating

PST14C : MICRO

For single configurations see page 5.

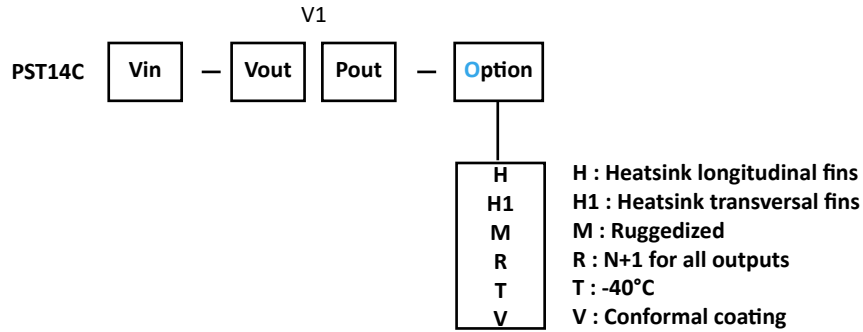

For multiple combination of the **same package**, use P/N as follows.
Units will be delivered with accessories mounted (Bus bar for parallel & serial , N+1).

Example :

- 2up 2 outputs (see page 3 for V1P1 & V2P2) **PST14C [Vin]-V1P1-V2P2-O**
- 2up 1 output **PST14C [Vin]-V1P-O** 1 output of P1+P2 where P1=P2
(do not put in parallel 2 different power)
- 3up 3 outputs **PST14C Vin -V1P1-V2P2-V3P3-O**
- 3up 2 outputs **PST14C Vin -V1P-V2P2-O** (P = 2 x P1)
 PST14C Vin -V1P1-V2P2-O

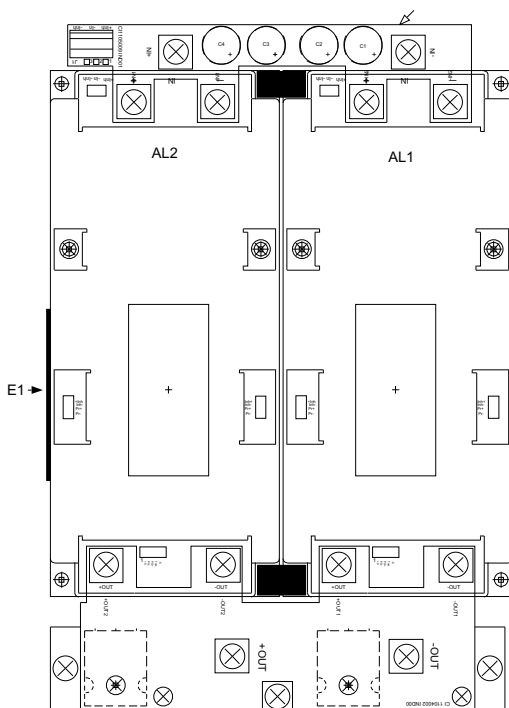

Option

H	H : Heatsink longitudinal fins
H1	H1 : Heatsink transversal fins
M	M : Ruggedized
P1	P1 : Parallel V1 & V2
P2	P2 : Parallel V2 & V3
R	R : N+1
R1	R1 : N+1 V1 & V2
R2	R2 : N+1 V2 & V3
S1	S1 : Serialized V1 & V2
S2	S2 : Serialized V2 & V3
T	T : -40°C
V	V : Conformal coating

ANSPRECHPARTNER



Für Fragen stehe ich Ihnen gerne persönlich zur Verfügung,

+43 (676) 466 466 0

od. per E-Mail

robert.glaser@glaser-eng.com .

Anfragen nehmen wir gerne unter der E-Mail-Adresse

info@glaser-eng.com

entgegen.



Y o u r t h o u g h t i s o u r p a s s i o n !

info@glaser-eng.com

www.glaser-eng.com