

PST26

AC-DC | 300W | 1-2 outputs | Eurocard

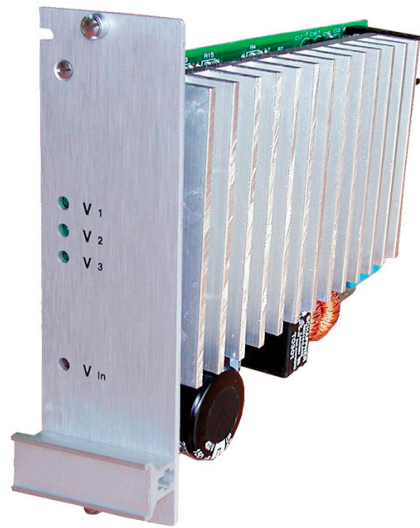

PRODUCTCARD

IHR VORTEIL - UNSERE STÄRKEN

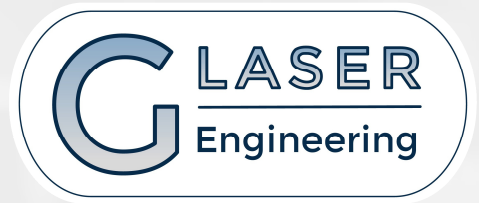

- Europäische Entwicklung
- Europäische Herstellung unter Berücksichtigung von ISO 9001, EN 9100, ISO 14001, ISO 45001
- Kurze Lieferkette
- Kurze Produktionszeiten, da die meisten Bauteile bevorratet werden können.
- Individualisierung nach Kundenwunsch bzw. Anpassung von Formfaktor, Konnektivität und Leistung möglich.
- Standard und ruggedized Varianten
- Modulare Bauweise (mehrere Stromquellen sind System technisch zusammengefasst), Vereinfachung von Konstruktion, Assembling und Service.
- Europäische Normen z.B. EN61000-3-2, EN55022B oder MIL-STD461E CE102, MIL-STD810E
- Alles aus einer Hand:
Design-In, Vertrieb und Abnahme durch das Ingenieurbüro **GLASER Engineering**

PST26

AC-DC converter in eurocard format

Standard product



Features

- ▶ 85-264Vac or 120-350Vdc input voltage ranges
- ▶ 1 to 2 isolated outputs
- ▶ Output power up to 300W
- ▶ Power Factor Correction EN61000-3-2
- ▶ Surge and transient protection
- ▶ Many output configurations available
- ▶ 3U x 8TE x 160mm

Safety IEC/EN 60950-1, RoHS lead-free-solder compliant



Description

The PST26, AC-DC converter in an eurocard format, incorporates input and output protections and filtering, signalling features, required in most of the severe environments for industrial applications. The PSU provides significant advantages such as flexibility of output configuration, high reliability thanks to the integration of Vicor Corp. modules, high efficiency, low ripple and noise levels, input-to-output isolation, soft start, over-temperature protection, input over/undervoltage lockout. The input is protected against surges and transients and EMI filtered. The outputs are continuously short-circuit proof. LEDs in front panel indicates the status of the outputs.

Bloc diagram

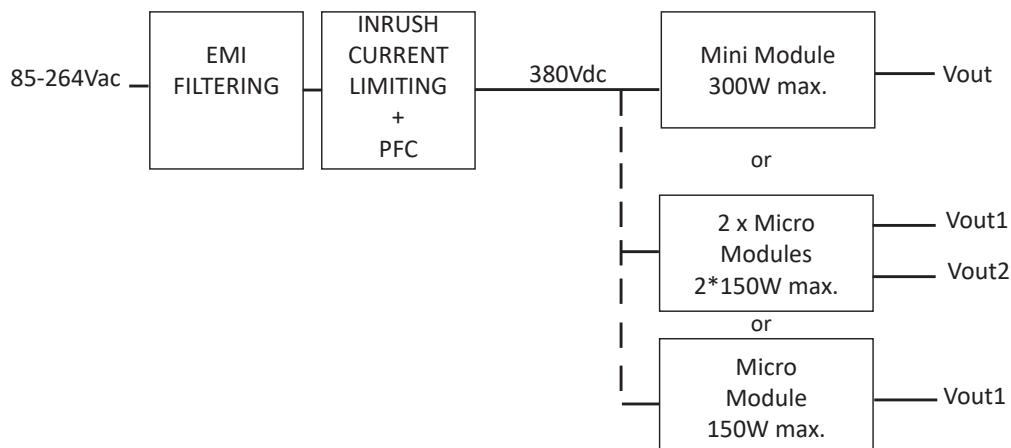

Options Description

No Front panel (F)

The PST26 is built as standard with a aluminum front panel as described in the mechanical data. In applications where the complete rack is covered by a single panel, the converter can be delivered without front panel.

-40°C operation (T)

The thermal grade of the Vicor the DC/DC converters used and other components are changed to comply with low ambient temperature.

Conformal coating (V)

During manufacturing process , when V option is specified, components and pcb are covered with an acrylic coating to address high level of ambient humidity application.

Input

Electrical Input Data

Input					Unit
Characteristics	Conditions	min	typ	max	
Operating input voltage		85		264	Vac
Operating input voltage		120		350	Vdc
Frequency		47	50	440	Hz
Power Factor	230Vac, 50Hz, Pnom.		0,96	0,98	
Input current	At Vin min			4	A
No-load input power	At Vin typ			9	W
Peak inrush current	Vin max			37	A
Start-up time				1,5	s

Input Fuse

A fuse mounted inside the converter protects against damages in case of a failure. The fuse is not user-accessible. In DC mode, reverse polarity at the input is protected and will not cause the fuse to blow .

Model	Fuse type	Rating	Reference
PST26	Schurter	5A	3403.0173

Input Transient Protection

A VDR (Voltage Dependent Resistor) and a common mode input filter form an effective protection against input transients in severe environments.

Output

Electrical Output Data

General conditions :
25°C ambient.

Output data for V1 PST26300

Output		3V3			5V			12V			15V			24V			28V			48V			Unit
Characteristics	Conditions	min	typ	max	min	typ	max	min	typ	max	min	typ	max	min	typ	max	min	typ	max	min	typ	max	
Output voltage			3V3		5			12			15			24			28			48			V
Trim range	Factory set	3		3,6	4,5		5,5	10,8		13,2	13,5		16,5	21,6		26,2	25,2		30,8	43,2		51,8	V
Overvoltage protection				4,5			6,5			14,9			18,5			29,1			34			58	V
Nominal output current		0		45	0		40	0		25	0		20	0		12,5	0		10,6	0		6,25	A
Output current limit			35	41		34	40		29	35		23	26		14,5	17		12,5	14,5		7,2	8,2	A
Output noise	20MHz		75			75			100			100			100				100			150	mVpp
Efficiency			75			83			85			84						83			84		%
Load Regulation	Vin nom.			1			1			0,5			0,5			0,4			0,4			0,4	%

Output data for V1,V2 PST26300

Output		Power and electrical Characteristics are defined for V1&V2 2*150W or V1 150W only.																					Unit
Characteristics	Conditions	3V3			5V			12V			15V			24V			28V			48V			
		min	typ	max	min	typ	max	min	typ	max	min	typ	max	min	typ	max	min	typ	max	min	typ	max	
Output voltage			3V3		5			12			15			24			28			48			V
Trim range	Factory set	3		3,6	4,5		5,5	10,8		13,2	13,5		16,5	21,6		26,2	25,2		30,8	43,2		51,8	V
Overvoltage protection				4,5			6,5			14,9			18,5			29,1			34			58	V
Nominal output current		0		22	0		20	0		12,5	0		10	0		6,25	0		5,3	0		3,1	A
Output current limit			26	31		25	27		14,4	17,5		11,5	13,5		7,1	9		6,1	7,2		3,6	4,2	A
Output noise	20MHz		75			75			100			100			100				100			150	mVpp
Efficiency			75			83			85			84						83			84		%
Load Regulation	Vin nom.			2			2			0,5			0,5			0,4			0,4			0,4	%

Parallel and Series Connection

A converter output can be connected in series with an output from a separate converter, an external diode across each output is required. The maximum output current of a serial-connected outputs is limited by the output with the lowest current limit. Output voltages above 48V (SELV - Safety Extra Low Voltage) require additional safety measures in order to comply with international safety requirements.

Parallel operation is possible with the addition of external diodes in series with each output.

With the PST26300 one output 300W, it is possible to have several units in parallel in order to increase the output power by connecting the PR+/PR- from one unit to another through a backplane. PR+ have to be connected together / PR- have to be connected together.

Redundant Systems Operation

When systems require a very high level of reliability and should work normally in the event of a failure, N+1 redundancy is implemented where N is the number of converter to support power requirement. If one converter fail, the remaining ones still delivers the power to the loads.

External diodes are required with the PST26 to ensure proper N+1 operation .

Hold-up time

The converters provide limited internal hold-up time .

Hot Swap

The hot swap is not recommended because of the inrush current. Nevertheless with some external cautions it may be possible. We recommend to consult our technical support before operating in this mode.

Output Current Limitation

All outputs are continuously protected against short-circuit by a constant current limitation.(no foldback)

Thermal Considerations

When a converter is mounted in free air, in convection cooling, and is operating at its nominal output power at the max. ambient temperature, the temperature measured on the heatsink should not exceed 95°C. The derating curves show the max power available from the converter versus ambient temperature.

Thermal protection

A temperature protection is integrated in each Vicor module, disabling output when heatsink temperature exceeds 100°C the converter automatically restarts, when the temperature drops below this limit. Nevertheless, exceeding the max operating temperature may cause failures of the converter.

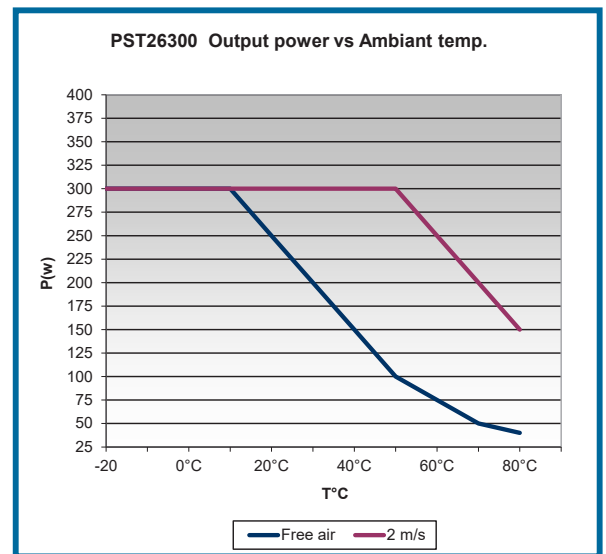

PST26 output noise V1 24V

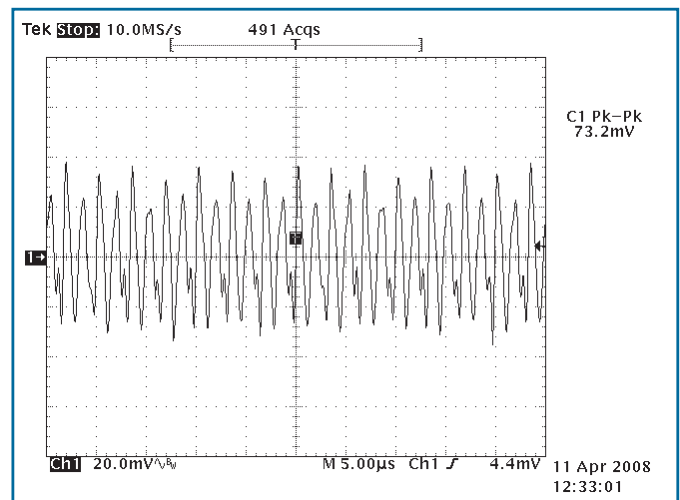

Auxiliary Functions

Primary Inhibit (Remote On/Off)

The inhibit input disables (logic low, pull down or short circuit between INHG pin 26 and HT- pin 24) or enables (logic high TTL, pull up or open-circuit between INHG and HT-) the converter. **Be careful , this signal is referenced to the input voltage** and will disable/enable all outputs at the same time (Use external opto isolated or relay). In systems consisting of several converters, this feature may be used to sequence the activation of the different converters.

Output Voltage Adjustment

The converter outputs can be factory adjustable to different values than standard ones. Consult factory.

Sense Lines

This feature enable compensation of voltage drop across the connector contacts and the load lines. This fonctionnality is implemented on V1 only .

The voltage between any sense line and its respective power output pin (as measured on the connector) should not exceed the following values at nominal output voltage.

Output type	Total drop	Negative line drop
V1	< 0.5V	< 0.25V

Powergood

Two green leds on the front panel indicate the presence of output voltages .

Efficiency

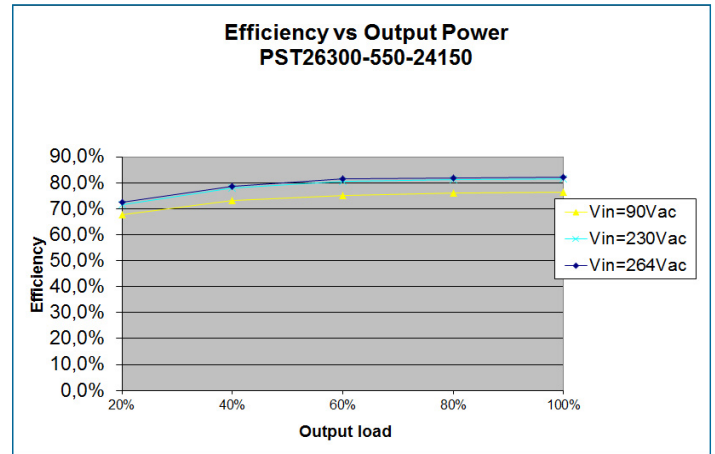

Electromagnetic

Electromagnetic Immunity

		Standard	Level	Value	Waveform	Source imped.	Test procedure	Mode	Criteria
Surges	Built to meet	EN 61000-4-5	3	2000V	1,2 / 50 μ s	12 ohms		OP	B
Electrostatic discharge (to case)	Built to meet	EN 6100-4-2	4	8000V	1 / 50 μ s	330 Ohms	10 pos., 10neg.	OP	B
Electrical fast transients/burst	Built to meet	EN 61000-4-4	4	4000V	5 / 50 μ s	50 ohms		OP	B

Electromagnetic Emissions

Level according to EN55022A - PST26300-48300

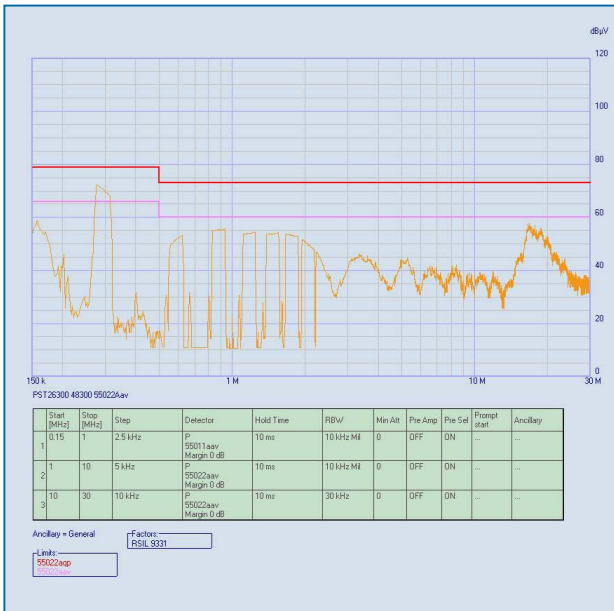

Level according to MIL STD461E CE102 without load - PST26300-48300

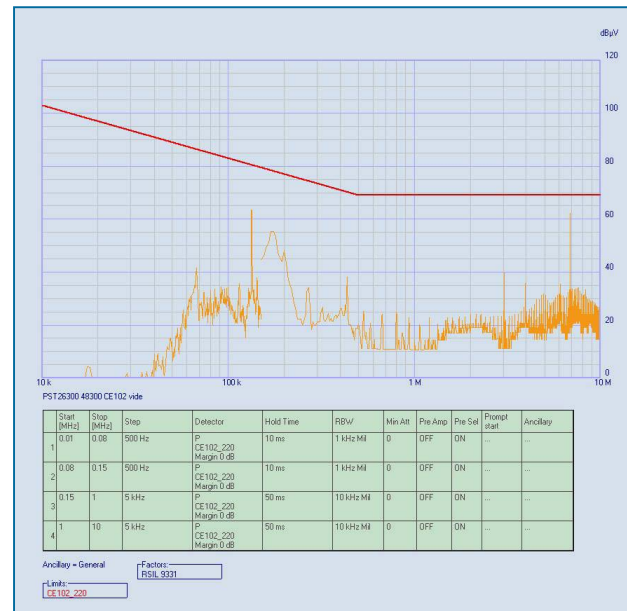

Level according to MIL STD461E CE102 300W - PST26300-48300

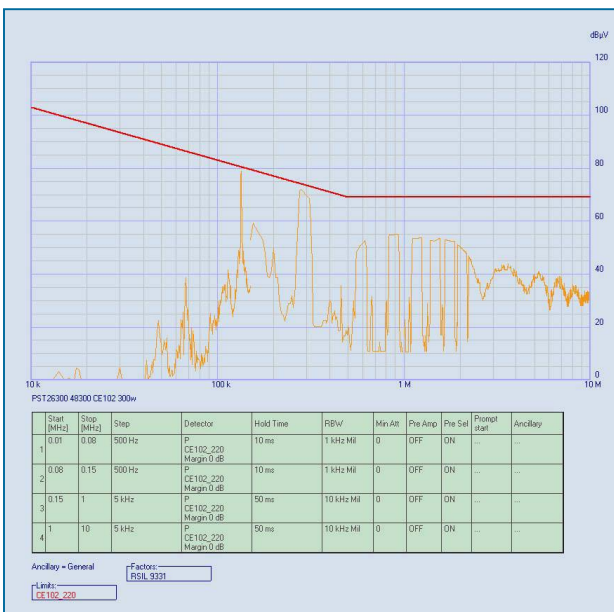

Immunity to Environmental Conditions

Test method	Standard	Test conditions	Status
Damp Heat	MIL STD 810D Proc. 507-2	Humidity 93 %, 40°C, 56 days	Conformal coating option only (V), built to meet
Shock	MIL STD 810D Proc.516.3	20g / 11ms 5g / 30ms	Built to meet
Vibrations	MIL STD 810D Proc. 514-3		Built to meet

Mechanical data

Solder side of the PCB protected by PBT sheet.

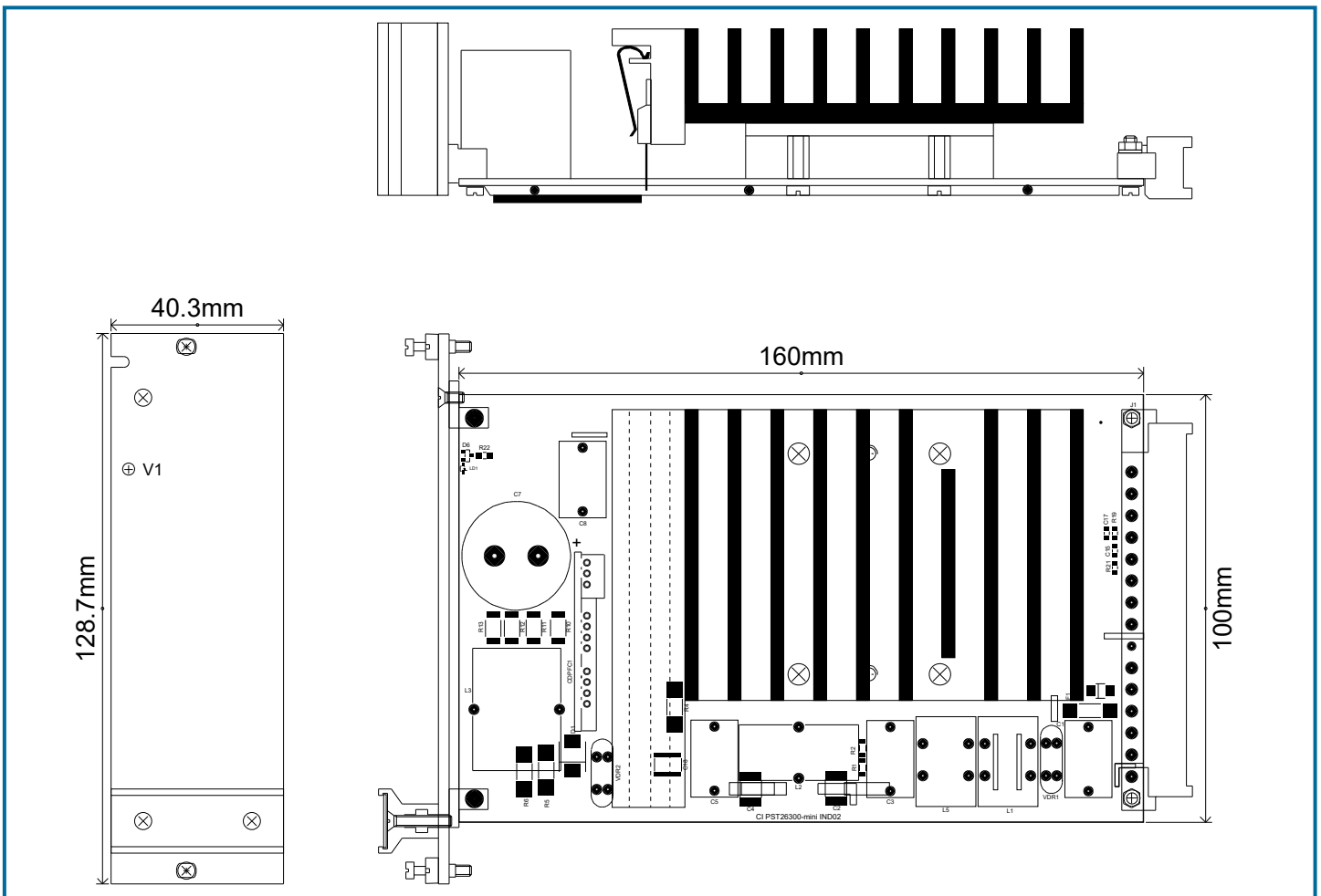

Safety and Installations Instructions

Connector Pin Allocation

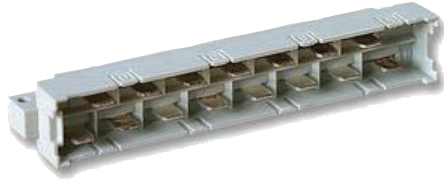

Ref : 05H15MGWVZ32/K1 - 2E ROLF HILLER

DIN 41612 Male H15 - Short version

PINOUT PST26300 (2 x 150W)		
PIN	Description	
4	V1+	Output 1+
6	V1+	Output 1+
8	S1+	Output 1 Senses +
10	S1-	Output 1 Senses -
12	V1-	Output 1-
14	V1-	Output 1-
16	V2+	Output 2+
18	V2+	Output 2+
20	V2-	Output 2-
22	V2-	Output 2-
24	ON/OFF	-HT (primary referenced)
26	ON/OFF	INHG
28	AC/L	Input Ac Line
30	AC/N	Input Ac Neutral
32		Earth

PINOUT PST26300		
PIN	Description	
4	V1+	Output 1+
6	V1+	Output 1+
8	V1+	Output 1+
10	S1+	Output 1 Senses +
12	S1-	Output 1 Senses -
14	V1-	Output 1-
16	V1-	Output 1-
18	V1-	Output 1-
20	PR+	PR+
22	PR-	PR-
24	ON/OFF	-HT (primary referenced)
26	ON/OFF	INHG
28	AC/L	Input Ac Line
30	AC/N	Input Ac Neutral
32		Earth

Installations Instructions

These converters are components, intended exclusively for integration into other equipment by an industrial assembly process or by a professionally competent person. Installation must strictly follow the safety regulations in respect of the enclosure, mounting, creepage and clearance distances, markings of the end-use application.

Connection to the system shall be made via the female connector H15. Pin 32 (Earth) is a leading pin and is connected to the case. For safety reasons it is essential to connect this pin to the protective earth of the supply system.

The AC/L is internally fused. This fuse is designed to protect the converter against overcurrent caused by a failure, but may not be able to satisfy all requirements. External fuses in the wiring circuit to one or both input pins (28 or 24) may be necessary to ensure compliance with local requirements.

Do not open the converters, or the warranty will be invalidated. Make sure that there is sufficient airflow available for convection cooling. This should be verified by measuring the case of temperature at the specified measuring point, when the converter is operated in the end-use application.

Standards and Approvals

The converters are built to meet the safety standards IEC 60950-1, EN 60950-1.

'Built to meet' mentioned in the different paragraphs of the datasheet means that Power System Technology has designed the product to meet the standard but not certified it in a laboratory.

Electric Strength

Characteristic		Input to Earth	Input to Output	Output to Earth	Output to Output	Unit
Electric strength	Design strength	1500	3000	500		Vrms
	Factory test for production units (>10s)	2000	2000	500		Vdc
Insulation resistance				> 100	>100	Mohms

Temperatures

Conditions		Standard			T option			Unit
		Min.	Typ.	Max.	Min.	Typ.	Max.	
Ambiant	Operating (see derating)	-20		+71	-40		+71	°C
Heatsink		-20		+100	-40		+100	
Storage	Not operating	-40		+125	-40		+125	

Reliability

MIL-HDBK-217F, notice 2	Model	Heatsink Temp.	GB	GF
MTBF (Hours) As example	PST26300 2 outputs	40°C	285000	165000
		70°C	139500	82300
		100°C	86600	51000

MTBF calculation for a specific part number has to be ordered.

Cleaning Agents and Process

The converters are not hermetically sealed. In order to avoid possible damage, any penetration of liquids shall be avoided.

Isolation

The electric strength test is performed in the factory in accordance with IEC/EN 60950.

Options and configurations

Max. power available : 300W

IN max : see table page 2

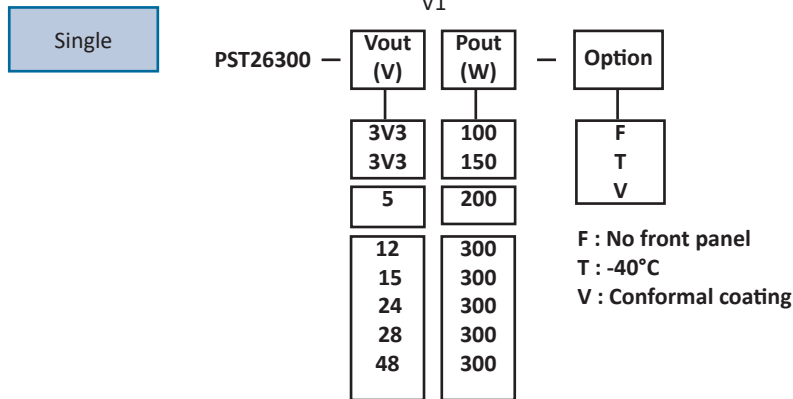

Max. power available : 300W

IN max : see table page 2

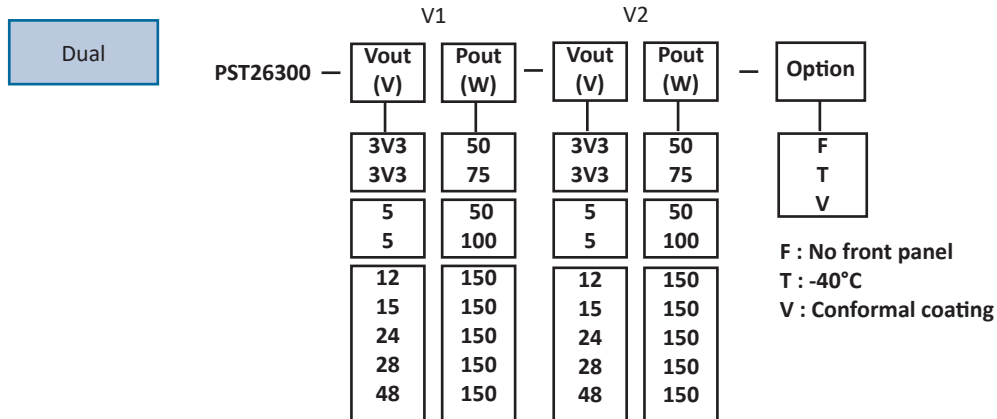

If V2 Not used , replace it by NN

ANSPRECHPARTNER



Für Fragen stehe ich Ihnen gerne persönlich zur Verfügung,

+43 (676) 466 466 0

od. per E-Mail

robert.glaser@glaser-eng.com .

Anfragen nehmen wir gerne unter der E-Mail-Adresse

info@glaser-eng.com

entgegen.



Y o u r t h o u g h t i s o u r p a s s i o n !

info@glaser-eng.com

www.glaser-eng.com