

# YB-TG19201080S05B-C-A0

15,6" | 1920\*1080 | 900cd/m<sup>2</sup> | CTP



**PRODUCTCARD**

Electronic | Mechatronic | Optics | Special App

## IHR VORTEIL - UNSERE STÄRKEN



- Asiatischer Premium Hersteller (seit 1988) unter Berücksichtigung von ISO 9001, ISO 14001, IATF16949 und AEO Certificate.
- Qualitätssystem IECQ QC 080000 und ANSI/ESD S20.0.-2021
- **Individualisierung** nach Kundenwunsch (Custom Size, Custom Print, Curved, Edge-Less, Edge-Round, etc.), bzw. Anpassung von Formfaktor, Konnektivität und Leistung möglich.
- **TFT** (Thin-Film Transistor-Display) und **CTP** (Capacitive Touch Panel)  
**LCM** (Liquid Crystal Modul)  
**LCD** (Liquid Crystal Display)
- Industrie und Automotiv - Varianten
- Lange Produktverfügbarkeit
- **Standard** TFT + CTP Displays in den Größen von 1,33“ bis 15,6“.
- Kundenspezifisch ab 1,33“ bis 15,6“
- Kurze Lieferkette für Standard Displays - prompt verfügbar mittels Lager innerhalb Europas.
- Kundenreferenzen: ABB, Bayer & Bayer, brother, DeLonghi, Fisher&Paykei, Honeywell, HP, Philips, LG, Siemens, T-Mobile, etc..
- Design-In, Vertrieb und Abnahme durch das Ingenieurbüro **GLASER Engineering**



**YEEBO GROUP**

LCM & CTP Specialist

# SPECIFICATION FOR LCD MODULE

**MODULE NO: YB-TG19201080S05B-C-A0**

**Doc.Version:00**

Customer Approval:

Accept

Reject

YEEBO	NAME	SIGNATURE	DATE
Prepare	Electronic Engineer		2020/2/28
Check	Mechanical Engineer		2020/2/28
Verify			
Approval			2020/2/28

APPROVAL FOR SPECIFICATIONS ONLY

APPROVAL FOR SPECIFICATIONS AND SAMPLE

WIMRD005-02-C

Add: 7/F., On Dak Industrial Building, 2-6 Wah Sing Street, Kwai Chung, H.K.

Tel: +852-2945-6800 ; +852-2945-6885

Fax: +852-2481-0019



# 1. Revision History

Sample Version	DOC. Version	DATE	DESCRIPTION		CHANGED BY
A0	00	2020-2-28	SPEC Only	FIRST ISSUE	KAI



## **2. Table of Contents:**

<b>NO</b>	<b>CONTENTS</b>	<b>PAGE</b>
1	Revision History	1
2	Table of Contents	2
3	Module Numbering System	3
4	General Specification	4
5	LCM drawing	5
6	Interface Pin Assignment	6
7	Electrical Characteristics	8
8	Optical Characteristics	12
9	Backlight	16
10	Reliability Test Items	19
11	Specification of Quality Assurance	21
12	Handling Precaution	26
13	Guarantee	26



### 3. Module Numbering System:

(Example)

**YB- TG 19201080 S 04 A -C - A0**

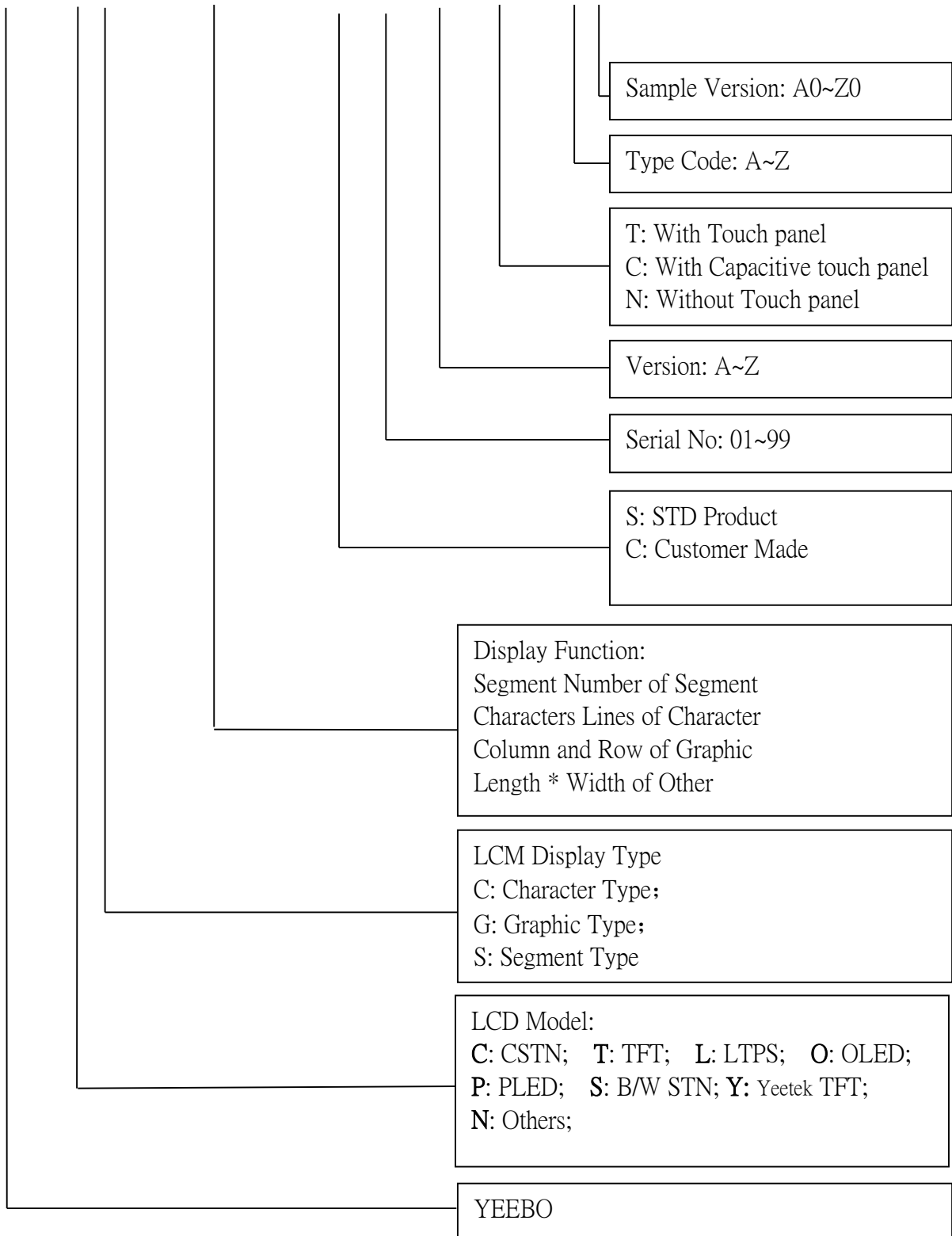



#### **4. General Specification:**

ITEM	CONTENTS
Assembly Module Size	383.70(W) * 248.00(H) * 7.35(T) mm
Display Size(Diagonal)	15.6 inch
Display Format	1920(RGB)*1080 Pixels
Active Area	344.16(W) * 193.59(H) mm
Pixel Pitch	0.17925(w)x 0.17925(H)
LCD Type	Normally black, Transmissive
TFT Driver element	a-Si TFT active matrix
TFT Surface treatment	Anti-Glare
Color arrangement	RGB-stripe
TFT interface	EDP
LCM power consumption	12.5W
View Direction	ALL
CTP IC	ILI2510
CTP Interface	I <sup>2</sup> C
Weight(g)	TBD
Firmware	TBD
Test Configuration	TBD



### 5. CTP+LCM drawing:

Count drawing & Spec revision record during discussion with customer		
Rec	Revision content description	Date
#1	FIRST ISSUE	2020-02-28

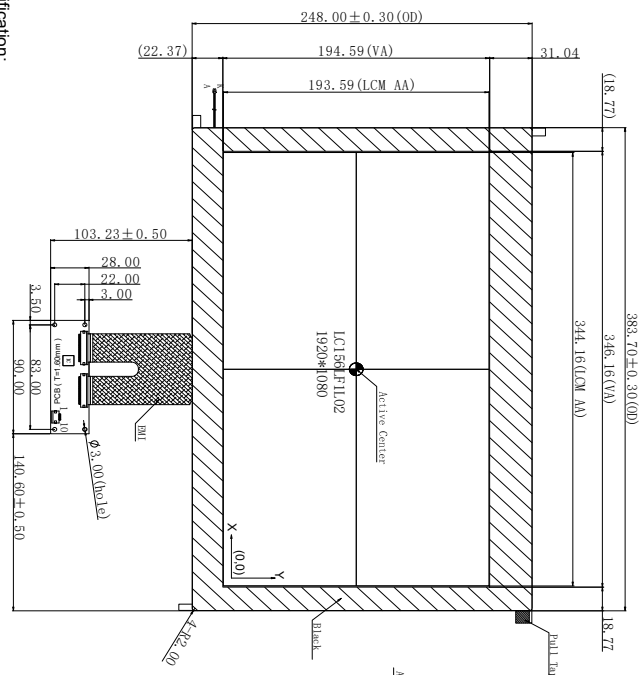

- Specification:
- 1. Display mode: TFT-LCD, TRANSMISSIVE, NORMAL BLACK
  - 2. Viewing Direction: ALL
  - 3. Display Format: 1920\*1080
  - 4. Backlight life: 50,000 hours (25 C, 25% 亮度)
  - 5. BACK LIGHT Uniformity: If=270m(A)(MIN)360m(A)(MAX), Vf=28-33V(MAX)
  - 6. Luminous intensity: Module: 800cd/m<sup>2</sup>(MIN), 900cd/m<sup>2</sup>(TYP).
  - Color chromaticity: X=0.27-0.35, Y=0.27-0.35
  - 7. CTP Interface: USB
  - 8. CTP Controller IC: ILI2510
  - 9. Type: OGS+FT
  - OGS 1.1mm Chemically Strengthened Glass
  - 10. Channel: 50\*28
  - 11. Operating temperature: -20°C~70°C
  - Storage temperature: -30°C~80°C
  - 12. Unspecified tolerance: ±0.30mm.
  - 13. ROHS compliant

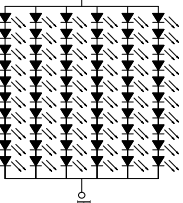

JETINK CODE NOTES:  
YB-TG19201080S05B-C-A Yeebo P/N  
XXXXXXXXXXXXXXXXX  
LOT NO.  
Production Year and week

TFT PIN OUT:

PIN	1	2	3	4	5	6	7	8	9	10
SYMBOL	NC	H_GND	Lanel N	Lanel N	H_GND	Lanel N	Lanel P	H_GND	ALIX_CH P	ALIX_CH N
PIN	11	12	13	14	15	16	17	18	19	20
SYMBOL	H_GND	LCD_VCC	LCD_VCC	LCD_GND	LCD_GND	HPD	NC	NC	NC	NC
PIN	21	22	23	24	25	26	27	28	29	30
SYMBOL	NC	NC	NC	NC	NC	NC	NC	NC	NC	NC

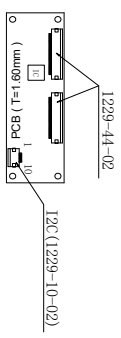

ICG PIN OUT:

1	GND	6	SCL(3.3V)
2	GND	7	SDA(3.3V)
3	RST(N/3.3V)	8	VDD(3.3V)
4	INT(3.3V)	9	GND
5	GND	10	GND

**YEEBO**

UNIT	SIZE	SCALE
mm	A4	N:1-S

DESIGNED	CHECKED	VERIFIED	APPROVED
----------	---------	----------	----------

MOD. NO.

**YB-TG19201080S05B-C-A**

Sheet	Of	FILE NAME
1	1	Count drawing



## 6.interface Pin Assignment

6-1. TFT FPC Connector is used for the module electronics interface. The recommended model is 20455-030E-76 (I-PEX) manufactured by Hirose.

Pin No.	Symbol	I/O	Function	Remark
1	NC	-	No connect	
2	H_GND	P	High Speed Ground	
3	Lane1_N	I	Complement Signal Link Lane 1	
4	Lane1_P	I	True Signal Link Lane 1	
5	H_GND	P	High Speed Ground	
6	Lane0_N	I	Complement Signal Link Lane 0	
7	Lane0_P	I	True Signal Link Lane 0	
8	H_GND	P	High Speed Ground	
9	AUX_CH_P	I	True Signal Auxiliary Channel	
10	AUX_CH_N	I	Complement Signal Auxiliary Channel	
11	H_GND	P	High Speed Ground	
12-13	LCD_VCC	P	LCD logic and driver power(3.3V)	
14	NC	-	No connect	
15-16	LCD_GND	P	LCD logic and driver ground	
17	HPD	I	HPD Signal	
18-30	NC	-	No connect	

I: input; O: output; P: Power or Ground(0V).

Note:

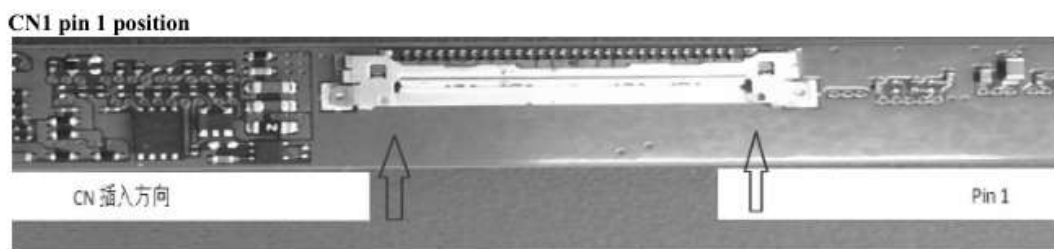



## 6-2 . CTP Pin Assignment

Pin No.	Symbol	I/O	Function
1	GND	P	Ground
2	GND	P	Ground
3	RSTN(3.3V)	I/O	Active low external reset
4	INT(3.3V)	I/O	Interrupt signal/Supports output open drain type//Digital I/O w/5v-tolerant
5	GND	P	Ground
6	SCL(3.3V)	I/O	I <sup>2</sup> C Serial Clock
7	SDA(3.3V)	I/O	I <sup>2</sup> C Serial Data
8	VDD(3.3V)	P	Power Voltage for digital circuit
9	GND	P	Ground
10	GND	P	Ground

## 7. Electrical Characteristics

### 7.1 Absolute Maximum Ratings

Stresses beyond those listed under “Absolute Maximum Ratings” may cause permanent damage to the device. These are for stress ratings. Functional operation of the device at these or any other conditions beyond those indicated in the operational sections of the specifications is not implied. Exposure to absolute maximum rating conditions for extended periods may remain possibility to affect device reliability.

Table 7-1: Absolute Maximum Ratings

Parameter	Symbol	Min	Max	Unit
Chip power input	$V_{DD}$	-0.3	3.6	V
$V_{DD3A}$ to GND	$V_{DD3A}$	-0.3	3.6	V
$V_{DD3D}$ to GND	$V_{DD3D}$	-0.3	3.6	V
$V_{DDIO}$ to GND	$V_{DDIO}$	-0.3	3.6	V
$V_{DD16}$ to GND	$V_{DD16}$	-0.3	1.65	V
$V_{GH}$ to GND	$V_{GH}$	-0.3	32	V
$V_{TX}$ to GND	$V_{TX}$	-0.3	32	V
ESD Susceptibility HBM (Human Body Mode)(Note 1)	HBM		4000	V
ESD Susceptibility MM (Machine Mode)	MM		400	V

**Note 1:** Devices are ESD sensitive. Handling precaution is recommended.

### 7.2 Recommended Operating Conditions

Parameter	Symbol	Min	Max	Unit
$V_{DD}$ to GND input power supply voltage	$V_{DD}$	3.14	3.46	V
$V_{DD3A}$ to GND	$V_{DD3A}$	3.14	3.46	V
$V_{DD3D}$ to GND	$V_{DD3D}$	3.14	3.46	V
$V_{DDIO}$ to GND	$V_{DDIO}$	1.8	3.46	V
$V_{GH}$ to GND	$V_{GH}$	-0.3	32	V
$V_{TX}$ to GND	$V_{TX}$	-0.3	32	V
Operating Ambient Temperature Range	TA	-20	85	°C
Operating Junction Temperature Range	TJ	-40	125	°C
Storage Ambient Temperature Range	T <sub>ST</sub>	-40	150	°C

**Note:** The device is not guaranteed to function outside its operating conditions.

## 7.3 DC Characteristics

Table 7-3: Input Power Supply

(VDD3A = VDD3D = 3.3V, Room Temperature)

Item	Symbol	Min	Typ.	Max	Unit	Condition
USB 3.3V input power supply voltage	V <sub>DD</sub>	3.14	3.3	3.46	V	@ USB
Digital input power supply voltage*	V <sub>DD3D</sub>	3.14	3.3	3.46	V	
Analog input power supply voltage	V <sub>DD3A</sub>	3.14	3.3	3.46	V	
I/O input power supply voltage*	V <sub>DDIO</sub>	1.8	3.3	3.46	V	

\*If VDDIO & VDD3D is not supplied power, there is risk of I/O pin with current leakage

Table 7-4: DC Characteristics

(VDD3A = VDD3D = 3.3V, Room Temperature)

Item	Symbol	Min	Typ.	Max	Unit	Condition
Operation current	I <sub>op</sub>		100		mA	Active Mode / 21.5"
Input Low Voltage	V <sub>IL1</sub>	0		0.3V <sub>DDIO</sub>	V	
Input High Voltage	V <sub>IH1</sub>	0.6V <sub>DDIO</sub>		V <sub>DDIO</sub> +0.5	V	
Hysteresis voltage	V <sub>HY</sub>		0.2V <sub>DDIO</sub>		V	
Input Low Voltage, XT_In	V <sub>IL2</sub>	0		0.6	V	V <sub>DDIO</sub> =3.3V
Input High Voltage, XT_In	V <sub>IH2</sub>	2.6		V <sub>DDIO</sub> +0.2	V	V <sub>DDIO</sub> =3.3V
Negative going threshold, /Reset	V <sub>ILS</sub>	0		0.2V <sub>DDIO</sub>	V	
Positive going threshold, /Reset	V <sub>IHS</sub>	0.6V <sub>DDIO</sub>		V <sub>DDIO</sub> +0.5	V	
Output High Voltage	V <sub>OH</sub>	0.7V <sub>DDIO</sub>			V	V <sub>DDIO</sub> =3.3V, I <sub>OH</sub> =8mA
Output Low Voltage	V <sub>OL</sub>			0.3V <sub>DDIO</sub>	V	V <sub>DDIO</sub> =3.3V, I <sub>OL</sub> =10mA

Table 7-5:USB DC Characteristics

Item	Symbol	Min	Typ.	Max	Unit	Condition
Input Low	$V_{IL}$			0.8	V	
Input High (driven)	$V_{IH}$	2.0			V	
Differential input sensitivity	$V_{DI}$	0.2			V	(D+) – (D-)
Differential common-mode range	$V_{CM}$	0.8		2.5	V	Includes $V_{DI}$ range
Single-ended receiver threshold	$V_{SE}$	0.8		2.0	V	
Receiver hysteresis	$V_{RH}$		200		mV	
Output low (driven)	$V_{OL}$	0		0.3	V	
Output high (driven)	$V_{OH}$	2.8		3.6	V	
Output signal cross voltage	$V_{CRS}$	1.3		2.0	V	
Pull-up resistor	$R_{PU}$	1.425		1.575	$k\Omega$	
Pull-down resistor	$R_{PD}$	14.25		15.75	$k\Omega$	
Termination Voltage for upstream port pull up (RPU)	$V_{TRM}$	3.0		3.6	V	

Table 7-6:Crystal Characteristics

Item	Symbol	Min	Typ.	Max	Unit	Condition
Input clock frequency	$f_{XIN}$		12		MHz	External crystal

### 7.4 I2C AC Characteristics

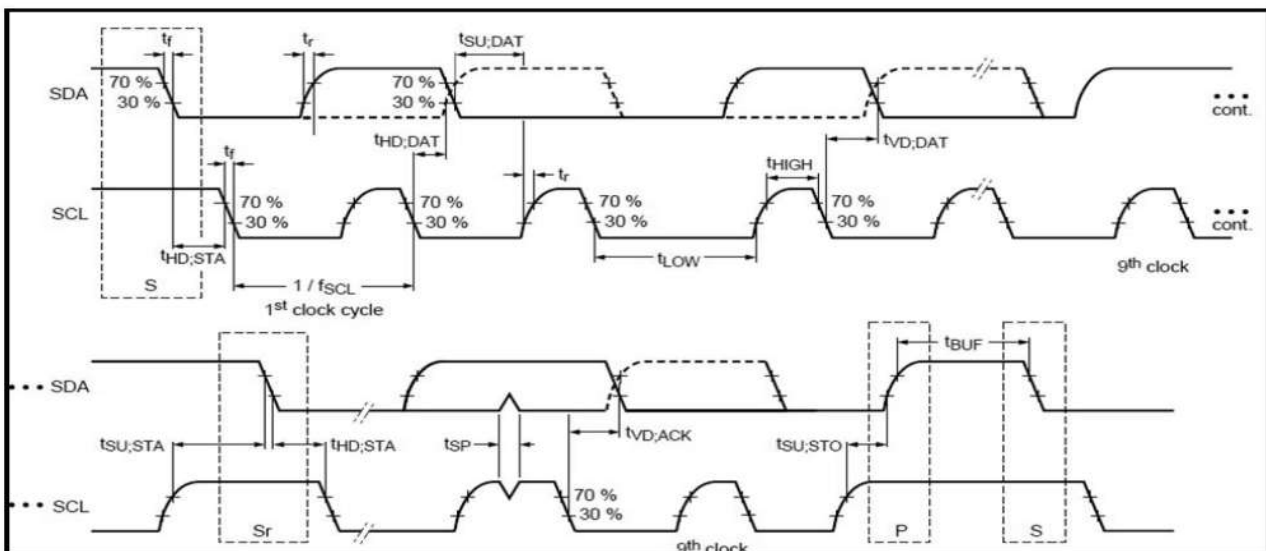

Table 7-7:I2C DC Characteristics

Parameter	Symbol	Standard-mode		Fast-mode		Unit
		Min	Max	Min	Max	
SCL clock frequency	$f_{SCL}$	0	100	0	400	kHz
Hold time START condition	$t_{HD;STA}$	4.0	-	0.6	-	us
LOW period of the SCL clock	$t_{Low}$	4.7	-	1.3	-	us
HIGH period of the SCL clock	$t_{high}$	4.0	-	0.6	-	us
Set-up time for a repeated START condition	$t_{SU;STA}$	4.7	-	0.6	-	us
Data hold time	$t_{HD;DAT}$	300	-	300	-	ns
Data set-up time	$t_{SU;DAT}$	250	-	100	-	ns
Rise time of both SDA and SCL signals (30% to 70%)	$t_r$	-	1000	20	300	ns
Fall time of both SDA and SCL signals (70% to 30%)	$t_f$	-	300	20	300	ns
Set-up time for STOP condition	$t_{SU;STO}$	4.0	-	0.6	-	us
Bus free time between a STOP and START condition	$t_{BUF}$	4.7	-	1.3	-	us
Capacitive load for each bus line	$C_b$	-	400	-	400	pF
Noise margin at the LOW level for each connected device	$V_{nL}$	$0.1V_{DD}$	-	$0.1V_{DD}$	-	V
Noise margin at the HIGH level for each connected device	$V_{nH}$	$0.2V_{DD}$	-	$0.2V_{DD}$	-	V

\*SCL = I2C Host must to support clock stretching mode for using 400 kHz.

## 8. Typical Operation Conditions

Test condition: GND=0V, T<sub>A</sub>=25 °C

Item	Symbol	Values			Unit	Remark
		Min.	Typ.	Max.		
Power voltage	LCD_VCC	3.0	3.3	3.6	V	
Current for Driver	LCD_VCC	-	280	-	MA	
Voltage for LED Backlight	V <sub>L</sub>	28	33	33	V	Note 1
Current for LED Backlight	I <sub>L</sub>	270	360	360	mA	
LED life time	-	50,000	-	-	Hr	Note 2

Note1: V<sub>L</sub>=33V, I<sub>L</sub>=360mA (Backlight circuit: 10series connection, 6 parallel connection), the ambient temperature is 25°C.

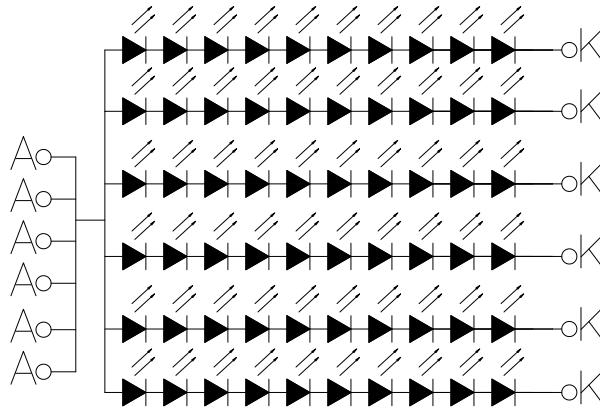

Fig. 3-1 LED test circuit diagram

Note 2: The “LED life time” is defined as the module brightness decrease to 25% original brightness at T<sub>a</sub>=25°C and I<sub>L</sub> =270mA . The LED lifetime could be decreased if operating I<sub>L</sub> is larger than 270 mA.

## 8.1 Power Sequence

Ta=+25°C

DC Electrical Characteristics						
Parameter	Symbol	Min.	Typ.	Max.	Unit	Remark
+3.3V supply voltage	VDD	+3.0	+3.3	+3.6	V	[Note 5-2-1]
Current dissipation	IDD	-	-	-	mA	[Note 5-2-2]
Permissible input ripple voltage	V <sub>RP</sub>	-	-	100	mVp-p	VDD=+3.3V
eDP AUX Channel Characteristics						
Parameter	Symbol	Min.	Typ.	Max.	Unit	Remark
Unit Interval for AUX channel	UI <sub>AUX</sub>	0.4	0.5	0.6	μS	
Peak-to-peak voltage at TP1	V <sub>AUX-DIFF-PP</sub>	0.32	-	1.36	V	
AUX DC Common mode Voltage	V <sub>AUX-DC-CM</sub>	0	-	2.0	V	
AUX Short current limit	I <sub>AUX-SHORT</sub>	-	-	90	mA	
AUX CH terminationDCresistor	R <sub>AUX-TERM</sub>	-	100	-	Ω	Differential input
AUX AC coupling capacitor	C <sub>AUX</sub>	75	-	200	nF	
Number of pre-charge pulses	Pre-charge pulses	10	-	16		
eDP Main Link Receiver Characteristics						
Parameter	Symbol	Min.	Typ.	Max.	Unit	Remark
Link clock down spreading	Down_Spread_Amplitude	0		0.5	%	
Differential Peak-to-peak Input Voltage at Rx package pins	V <sub>RX-DIFF-P</sub>	90	-	1200	mV	
Differential Return Loss at 1.35GHz at Rx package pins	RL <sub>RX-DIFF</sub>	9	-	-	dB	
Differential termination resistance	R <sub>RX-TERM</sub>	-	100	-	Ω	
RX short circuit Current Limit	I <sub>RX-SHORT</sub>	-	-	50	mA	
Lane Intra-pair Skew at RX package pins	T <sub>RX-SKEW-INTRAPAIR-High-Di-Rate</sub>	-	-	50	ps	

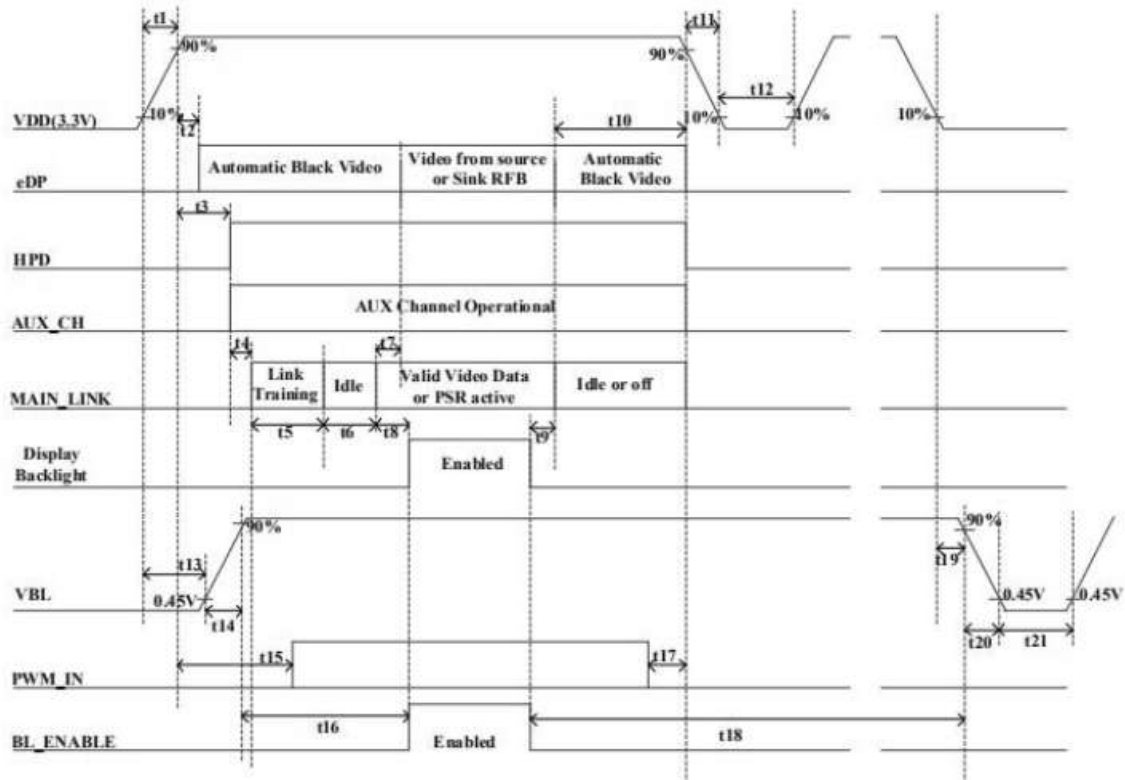



Symbol	Min	Max	Unit	Note
t1	0.5	10	ms	
t2	0	200	ms	
t3	0	100	ms	
t4	-	-	ms	
t5	-	-	ms	
t6	-	-	ms	
t7	0	50	ms	
t8	-	-	ms	
t9	-	-	ms	

t10	0	500	ms	
t11	1	50	ms	[Note 5-2-3]
t12	500	-	ms	
t13	-	-	ms	
t14	0.5	10	ms	
t15	100	-	ms	
t16	0	-	ms	
t17	0	-	ms	
t18	-	-	ms	
t19	-	-	ms	
t20	0.1	-	ms	
t21	100	-	ms	

## 8.2 Signal Timing Characteristics

Parameter		Symbol	Min.	Typ.	Max.	Unit	Remark
Clock	Frequency	1/T <sub>C</sub>	132.0	138.5	140.0	MHz	[Note 6-1-1]
Data enable signal	Horizontal period	TH	2020	2080	2400	clock	
				15.02		μs	
	Horizontal period (High)	THd	-	1920	-	clock	
	Vertical period	TV	1090	1111	1200	line	
			-	16.685	-	ms	
Vertical period (High)	TVd	-	1080	-	line		

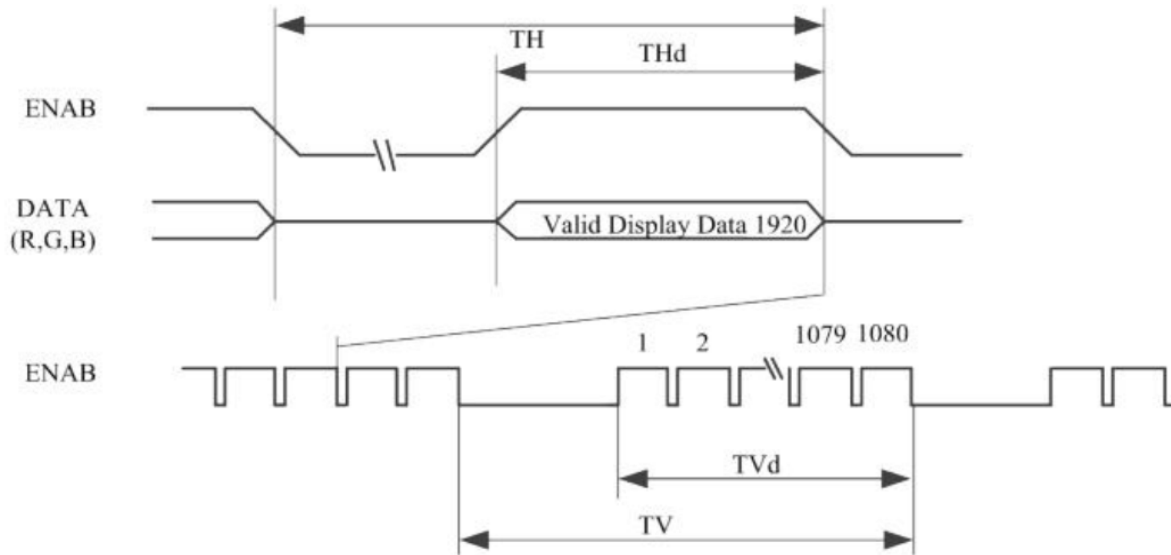

## 9. Optical Specifications

Item	Symbol	Condition	Values			Unit	Remark
			Min.	Typ.	Max.		
Viewing angle (CR≥ 10)	$\theta_L$	$\Phi=180^\circ$ (9 o'clock)	-	89	-	degree	Note 1
	$\theta_R$	$\Phi=0^\circ$ (3 o'clock)	-	89	-		
	$\theta_T$	$\Phi=90^\circ$ (12 o'clock)	-	89	-		
	$\theta_B$	$\Phi=270^\circ$ (6 o'clock)	-	89	-		
Response time	TON+ TOFF	Normal $\theta = \Phi = 0^\circ$	-	25	35	msec	Note 2
Contrast ratio	CR		700	1000	-	-	Note 3
Color chromaticity	WX		0.27	0.31	0.35	-	Note 4
	WY		0.27	0.31	0.35	-	Note 5 Note 6
Luminance	L		800	900	-	cd/m <sup>2</sup>	Note 6
Luminance uniformity	YU		70	75	-	%	Note 7

The test systems refer to Note 2.

Note 1: Definition of viewing angle range

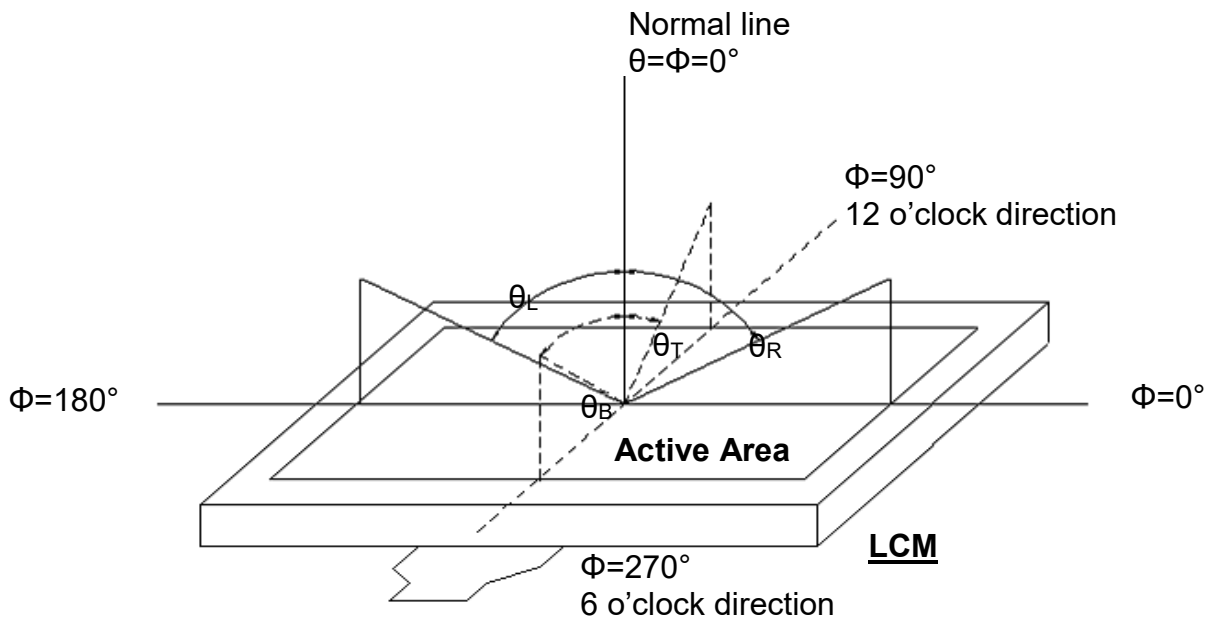

Fig. 4-2 Definition of viewing angle

Note 2: Definition of Response time

The response time is defined as the LCD optical switching time interval between "White" state and "Black" state. Rise time ( $T_{ON}$ ) is the time between

photo detector output intensity changed from 90% to 10%. And fall time ( $T_{OFF}$ ) is the time between photo detector output intensity changed from 10% to 90%.

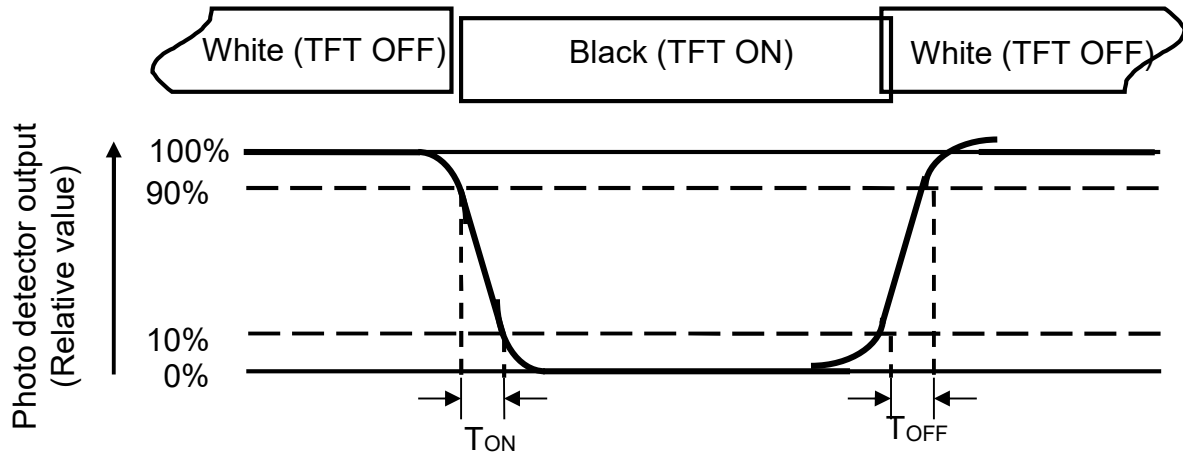
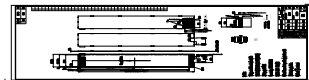

Fig. 4-3 Definition of response time

Note 3: Definition of contrast ratio



Note 4: Definition of optical measurement system.

The optical characteristics should be measured in dark room. After 30 minutes operation, the optical properties are measured at the center point of the LCD screen. (Viewing angle is measured by ELDIM-EZ contrast/Height : 1.2mm, Response time is measured by Photo detector TOPCON BM-7, other items are measured by BM-5A/ Field of view: 1° /Height: 500mm.) or CA-210.

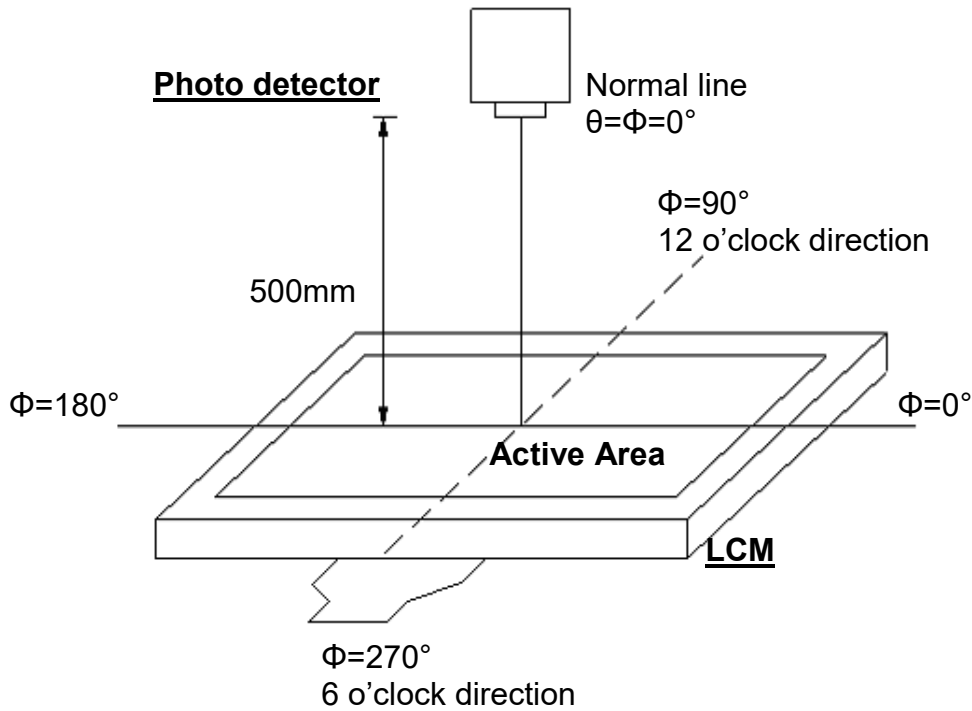

Fig. 4-4 Optical measurement system setup

Note 5: Definition of color chromaticity (CIE1931)

Color coordinates measured at center point of LCD.

Note 6: All input terminals LCD panel must be ground while measuring the center area of the panel. The LED driving condition is  $I_L=200mA$ .

Note 7: Definition of Luminance Uniformity

Active area is divided into 9 measuring areas(Refer to Fig. 4-5).

Every measuring point is placed at the center of each measuring area.

$$\text{Luminance Uniformity (Yu)} = \frac{B_{min}}{B_{max}}$$

L-----Active area length      W----- Active area width

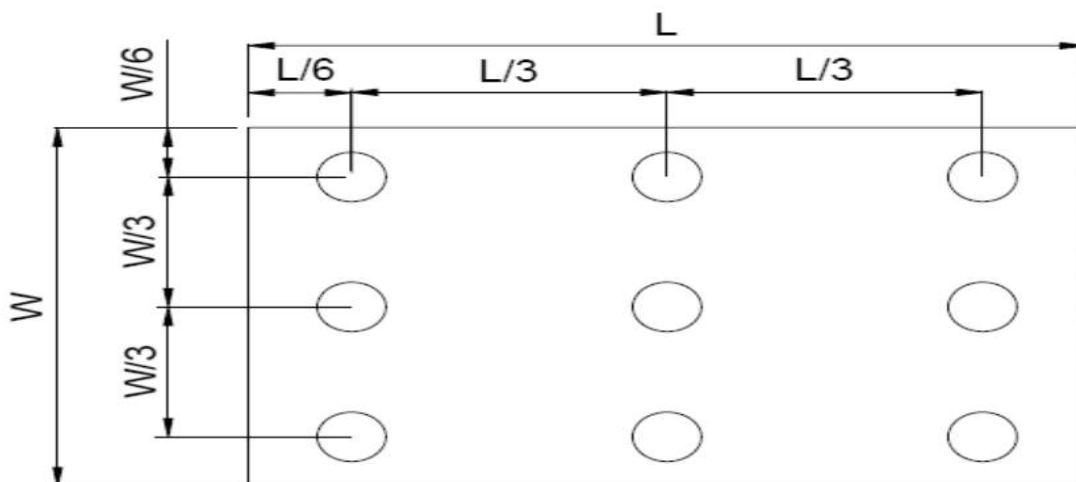

$B_{MAX}$ : The measured maximum luminance of all measurement position.

$B_{MIN}$ : The measured minimum luminance of all measurement position.

## 10. Reliability Test Items

### 10-1. Standard Specifications for Reliability of LCD Module

No	Item	Description
01	High temperature operation	The sample should be allowed to stand at 70°C for 240 hours under driving condition and then returning it to normal temperature condition, and allowing it stand for 2 hours.
02	Low temperature operation	The sample should be allowed to stand at -20°C for 240 hours under driving condition and then returning it to normal temperature condition, and allowing it stand for 2 hours.
03	High temperature storage	The sample should be allowed to stand at 80°C for 240 hours under no-load condition, and then returning it to normal temperature condition and allowing it stand for 2 hours.
04	Low temperature storage	The sample should be allowed to stand at -30°C for 240 hours under no-load condition, then returning it to normal temperature condition, and allowing it stand for 2 hours.
05	Moisture storage	The sample should be allowed to stand at 60°C, 90%RH MAX for 240 hours under no-load condition, then taking it out and drying it at normal temperature for 2 hours.
06	Thermal shock storage	The sample should be allowed to stand the following 10 cycles : 0°C for 30 minutes → normal temperature for 5 minutes → +60°C for 30 minutes → normal temperature for 5 minutes, as one cycle.
07	Packing vibration	Frequency range : 10Hz ~ 55Hz Amplitude of vibration : 1.5mm      Sweep time: 12 min X, Y, Z 2 hours for each direction.

\*Sample size for each test item is 3~5pcs



## 10 - 2. Testing Conditions and Inspection Criteria

For the final test the testing sample must be stored at room temperature for 24 hours, after the tests listed in Table 10-1, Standard specifications for Reliability have been executed in order to ensure stability.

No	Item	Test Model	In section Criteria
01	Current Consumption	Refer To Specification	The current consumption should conform to the product specification.
02	Contrast	Refer To Specification	After the tests have been executed, the contrast must be larger than half of its initial value prior to the tests.
03	Appearance	Visual inspection	Defect free.

## 10- 3. MTBF

MTBF	Functions, performance, appearance, etc. shall be free from remarkable deterioration within 50,000 hours under ordinary operating and storage conditions room temperature (25±5°C), normal humidity (50±10% RH), and in area not exposed to direct sun light.
------	---------------------------------------------------------------------------------------------------------------------------------------------------------------------------------------------------------------------------------------------------------------



## **11. Specification of Quality Assurance:**

### 11-1. Purpose

This standard for Quality Assurance should affirm the quality of LCD module products to supply to purchaser by YEEBO CORPORATION (Supplier).

### 11-2. Standard for Quality Test

#### a. Inspection:

Before delivering, the supplier should take the following tests, and affirm the quality of product.

#### b. Electro-Optical Characteristics:

According to the individual specification to test the product.

#### c. Test of Appearance Characteristics:

According to the individual specification to test the product.

#### d. Test of Reliability Characteristics:

According to the definition of reliability on the specification for testing products.

#### e. Delivery Test:

Before delivering, the supplier should take the delivery test.

(i) Test method: According to ISO2859-1. General Inspection Level II take a single time.

(ii) The defects classify of AQL as following:

Major defect: AQL = 0.65%

Minor defect: AQL = 2.5%

Total defects: AQL = 2.5%

### 11-3. Non- conforming Analysis & Deal With Manners

#### a. Non- conforming Analysis:

(i) Purchaser should supply the detail data of non- conforming sample and the non-conforming.

(ii) After accepting the detail data from purchaser, the analysis of non- conforming should be finished in two weeks.

(iii) If supplier can not finish analysis on time, must announce purchaser before 3 days.

#### b. Disposition of non- conforming:

(i) If find any product defect of supplier during assembly time, supplier must change the good product for every defect after recognition.

(ii) Both supplier and customer should analyze the reason and discuss the disposition of non- conforming when the reason of nonconforming is not sure.

### 11-4. Agreement items

Both sides should discuss together when the following problems happen.

a. There is any problem of standard of quality assurance, and both sides should think that must be modified.

b. There is any argument item which does not record in the standard of quality assurance.

c. Any other special problem.



11-5. Standard of The Product Appearance Test

a. Manner of appearance test:

(i) The test must be under 20W × 2 or 40W fluorescent light, and the distance of view must be at 30±5cm.

(ii) When test the model of transmissive product must add the reflective plate.

(iii) The test direction is base on around 10° of vertical line.

(iii) Temperature: 25±5°C Humidity: 60±10%RH

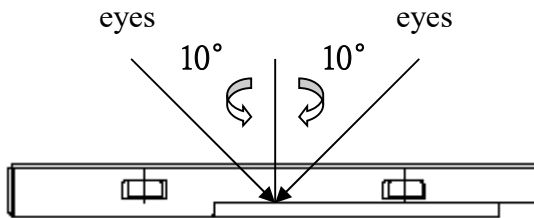

(iv) Definition of area:

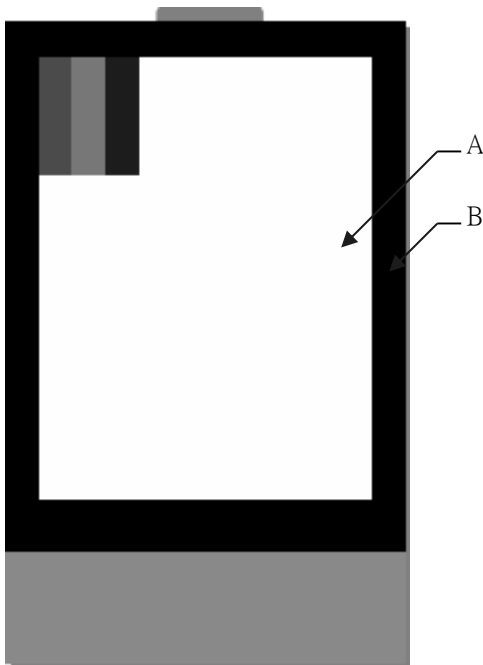

A. Area: Viewing area.

B. Area: Out of viewing area.  
(Outside viewing area)

b. Basic principle:

(i) It will accord to the AQL when the standard can not be described.

(ii) The sample of the lowest acceptable quality level must be discussed by both supplier and customer when any dispute happened.

(iii) Must add new item on time when it is necessary.

c. Standard of inspection: (Unit: mm)

11-6. Inspection specification

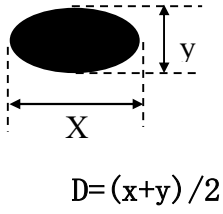
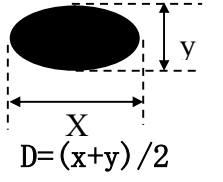
Item	Specification	Unit : mm	AQL														
Electrical Testing	1.1 Open 1.2 Short 1.3 T/P failure 1.4 Missing vertical, horizontal segment, segment contrast defect. 1.5 Missing character, dot or icon. 1.6 Display malfunction. 1.7 No function or no display. 1.8 Current consumption exceeds product specifications. 1.9 LCD viewing angle defect. 1.10 Mixed product types. 1.11 Flicker		0.65														
explosion-proof film bubble/Concave and convex point/indentation / Contamination	<table border="1"> <thead> <tr> <th>Product type</th> <th>D</th> <th>Acceptable numbers</th> </tr> </thead> <tbody> <tr> <td rowspan="5">LAD</td> <td><math>\leq 0.3</math></td> <td>ignored (No more than five spots within 5mm G)</td> </tr> <tr> <td><math>0.3 &lt; D \leq 0.5</math></td> <td>4</td> </tr> <tr> <td><math>0.5 &lt; D \leq 1.0</math></td> <td>2</td> </tr> <tr> <td><math>1.0 &lt; D \leq 1.5</math></td> <td>2</td> </tr> <tr> <td><math>D &gt; 1.5</math></td> <td>NG</td> </tr> </tbody> </table>  <p>                     1、 Product's front side checked according to this specification, back side ignored, but light leakage is not allowed.                      2、 Printing ink peel off is not allowed.                      3、 The particle will be ignored when it is removable by cleaning                      * Densely spaced: No more than two spots within 10mm                 </p>	Product type	D	Acceptable numbers	LAD	$\leq 0.3$	ignored (No more than five spots within 5mm G)	$0.3 < D \leq 0.5$	4	$0.5 < D \leq 1.0$	2	$1.0 < D \leq 1.5$	2	$D > 1.5$	NG		2.5
Product type	D	Acceptable numbers															
LAD	$\leq 0.3$	ignored (No more than five spots within 5mm G)															
	$0.3 < D \leq 0.5$	4															
	$0.5 < D \leq 1.0$	2															
	$1.0 < D \leq 1.5$	2															
	$D > 1.5$	NG															
Black spots / White spots /Bright spots/ Color spots /polluted inside/ punctured	<table border="1"> <thead> <tr> <th>Product type</th> <th>D</th> <th>Acceptable numbers</th> </tr> </thead> <tbody> <tr> <td rowspan="4">LAD</td> <td><math>\leq 0.2</math></td> <td>ignored (No more than five spots within 5mm)</td> </tr> <tr> <td><math>0.2 &lt; D \leq 0.4</math></td> <td>3</td> </tr> <tr> <td><math>0.4 &lt; D \leq 0.8</math></td> <td>2</td> </tr> <tr> <td><math>D &gt; 0.8</math></td> <td>NG</td> </tr> </tbody> </table>  <p>                     1.Product's front side checked according to this specification, back side ignored, but light leakage is not allowed.                      2.Printing ink peel off is not allowed.                      3、 The particle will be ignored when it is removable by cleaning                      * Densely spaced: No more than two spots within 10mm                 </p>	Product type	D	Acceptable numbers	LAD	$\leq 0.2$	ignored (No more than five spots within 5mm)	$0.2 < D \leq 0.4$	3	$0.4 < D \leq 0.8$	2	$D > 0.8$	NG		2.5		
Product type	D	Acceptable numbers															
LAD	$\leq 0.2$	ignored (No more than five spots within 5mm)															
	$0.2 < D \leq 0.4$	3															
	$0.4 < D \leq 0.8$	2															
	$D > 0.8$	NG															

Linear Object: Fiber, scurf, scratches and other linear defects (not affecting function)	Product type	W	L	Acceptable numbers		2.5
	LAD	$\leq 0.05$	$\leq 8$	ignored No more than five lines within 5mm)		
		$0.1 < W \leq 0.3$	$\leq 8$	2		
		$W > 0.3$		NG		
<p>The reverse side scratches, not affect to the electronic circuit, cannot find the scratches from the front side is acceptable</p> <p>* Densely spaced: No more than two lines within 10mm</p>						
Glass edge chipping、edge breakage	Edge breakage can't affect visual effect (edge breakage can't cause damage to circuit); over lens have no visual damage				2.5	
	Product type	conditions				Acceptable numbers
	LAD	$X \leq 3.0mm, Y \leq 2.0mm, Z \leq T$				5
Glass broken	Visual broken is NG, and there is no potential fault.					0.65
1. V/A printed edges sawtooth inspected according to this standard 2. LOGO's sawtooth	Some contentious defect judged according to samples				2.5	
	Product type	Conditions				
	Same size	1、 width below 0.2 inch (included) ignored, above 0.2 NG 2、 Length not accounted				
Specific dimension	In accordance with product outline drawing or specification (key dimension) or engineering sample.					2.5
Glue overflow/Frame	1. Glue overflow exceed 0.2mm to the black frame is not allowed.					2.5
FPC	Bonding bubble/	FPC golden finger hot pressure's bubble or impurity diameter shall be below 1/2 of the pressed area, pressed deviation shall not exceed 1/2 of the silver line				0.65



Misalignm ent	width, and 40X microscope cannot have obvious cracks.	
Folded mark (minor fault)	Linearity irreversibility folded mark and acute angle folded mark is NG.	2.5
EMI FILM (minor fault)	Surface broken, scratched $\leq 0.3\text{mm}$ Surface broken below 5mm can be modified by print ink, after modified, the result shall be achieved to EMI	2.5



## **12. Handling Precaution:**

### **12.1 Warranty**

This product has been manufactured to specifications as a part for use in your company's general electronic products. It is guaranteed to perform according to delivery specifications. For any other use apart from general electronic equipment, we will not take responsibility if the product is used in medical devices, nuclear power control equipment, aerospace equipment, fire and security systems, or any other applications in which there is a direct risk to human life and where extremely high levels of reliability are required. If the product is to be used in any of the above applications, we will need to enter into a separate product liability agreement.

1. We cannot accept responsibility for any defect arise after additional process of the product (including disassembly and reassembly), after product delivery.
2. We cannot accept responsibility for any defect, which may arise after the application of strong external force to the product.
3. We cannot accept responsibility for any defect, which may arise due to the application of static electricity after the product has passed your company's acceptance inspection procedures.
4. We cannot accept responsibility for industrial property, which may arise through the use of your product, with exception to those issues relating directly to the structure or method of manufacturing of our product 3months from YEEBO production.
5. The liability of YB is limited to repair or replacement on the terms set forth below. YB will not be responsible for any subsequent or consequential events or injury or damage to any personnel or user including third party personnel and/or user. Unless otherwise agreed in writing between YB and the customer, YB will only replace or repair any of its CTP which is found defective electrically or visually when inspected in accordance with YB GENERAL CTP INSPECTION STANDARD.

### **12.2. Precautions in Use of CTP Module**

#### **12.2-1. Handling of CTP Module**

12.2-1-1 Please operate the capacitive touch panel by touch the panel surface with finger or electric pen

12.2-1-2 Store the products at the temperature and humidity mentioned in the specification in a good package do not expose the products under direct sunlight.

12.2-1-3 Do not hit the capacitive touch panel in strong force , or drop it down, it is made of glass and friable.

12.2-1-4 Put on finger coats ,glovers or mask to protect the products from fingerprint of stain. Do not upload/unload the touch panel by holding the FPC cable. Do not bend the FPC cableoften or pull it hard when installing, as FPC cable is soft and connected to touch panel body.

12.2-1-5 Pay attention to the prevention from high voltage and static electricity.

#### **12.2-2 Storage**

12.2-2-1 Store in ambient temperature of  $25\pm 5^{\circ}\text{C}$  , and relative humidity of  $50\pm 10\%\text{RH}$ . Do not expose to sunlight or fluorescent light.

12.2-2-2 Storage in a clean environment, free from dust, active gas, and solvent.

12.2-2-3 Store in anti-static electricity container.

12.2-2-4 Store without any physical load.

12.2-2-5 Appearance,3months;Function,1year;within the validity, failed CTP can be replaced 1 to 1

## **13 Guarantee**

Our products meet requirements of the environment.YEEBO ROHS requirement is based on European Union Directive 2011/65/EU (ROHS) Requirements and Update.

## ANSPRECHPARTNER



Für Fragen stehe ich Ihnen gerne persönlich zur Verfügung,

+43 (676) 466 466 0

od. per E-Mail

[robert.glaser@glaser-eng.com](mailto:robert.glaser@glaser-eng.com) .

Anfragen nehmen wir gerne unter der E-Mail-Adresse

[info@glaser-eng.com](mailto:info@glaser-eng.com)

entgegen.



Y o u r t h o u g h t i s o u r p a s s i o n !

[info@glaser-eng.com](mailto:info@glaser-eng.com)

[www.glaser-eng.com](http://www.glaser-eng.com)