

# YB-TG800480S34A-N-A0

5,0" | 800\*480 pixels | 470cd/m<sup>2</sup> | CTP



## PRODUCTCARD

Electronic | Mechatronic | Optics | Special App

## IHR VORTEIL - UNSERE STÄRKEN



- Asiatischer Premium Hersteller (seit 1988) unter Berücksichtigung von ISO 9001, ISO 14001, IATF16949 und AEO Certificate.
- Qualitätssystem IECQ QC 080000 und ANSI/ESD S20.0.-2021
- **Individualisierung** nach Kundenwunsch (Custom Size, Custom Print, Curved, Edge-Less, Edge-Round, etc.), bzw. Anpassung von Formfaktor, Konnektivität und Leistung möglich.
- **TFT** (Thin-Film Transistor-Display) und **CTP** (Capacitive Touch Panel)  
**LCM** (Liquid Crystal Modul)  
**LCD** (Liquid Crystal Display)
- Industrie und Automotiv - Varianten
- Lange Produktverfügbarkeit
- **Standard** TFT + CTP Displays in den Größen von 1,33“ bis 15,6“.
- Kundenspezifisch ab 1,33“ bis 15,6“
- Kurze Lieferkette für Standard Displays - prompt verfügbar mittels Lager innerhalb Europas.
- Kundenreferenzen: ABB, Bayer & Bayer, brother, DeLonghi, Fisher&Paykei, Honeywell, HP, Philips, LG, Siemens, T-Mobile, etc..
- Design-In, Vertrieb und Abnahme durch das Ingenieurbüro **GLASER Engineering**

# SPECIFICATION FOR LCD MODULE

**MODULE NO: YB-TG800480S34A-N-A0**

**Doc.Version:01**

Customer Approval:

<input type="checkbox"/> Accept	<input type="checkbox"/> Reject
---------------------------------	---------------------------------

YEEBO	NAME	SIGNATURE	DATE
Prepare	Electronic Engineer	方家斌	2022-07-08
Check	Mechanical Engineer	马超铭	2022-07-11
Verify		邓嘉刚	2022-07-11
Approval		田静	2022-07-12

■ APPROVAL FOR SPECIFICATIONS ONLY

APPROVAL FOR SPECIFICATIONS AND SAMPLE

WIMRD005-02-D

**1. Revision History**

<b>Sample Version</b>	<b>DOC. Version</b>	<b>DATE</b>	<b>DESCRIPTION</b>		<b>CHANGED BY</b>
A0	00	2022-06-17	Spec Only	First issue	Run Lin/HHK
A0	01	2022-07-08	Spec Only	Modify IC and LCD	Jia Cheng /M.C.M

## **2. Table of Contents:**

<b>NO</b>	<b>CONTENTS</b>	<b>PAGE</b>
1	Revision History	1
2	Table of Contents	2
3	Module Numbering System	3
4	General Specification	4
5	LCM drawing	5
6	Electrical Characteristics	6
7	Optical Characteristics	10
8	Interface Pin Assignment	12
9	Block Diagram	13
10	Backlight	14
11	Standard Specification for Reliability	15
12	Specification of Quality Assurance	17
13	Handling Precaution	25
14	Warranty	26
15	Guarantee	26

### 3. Module Numbering System:

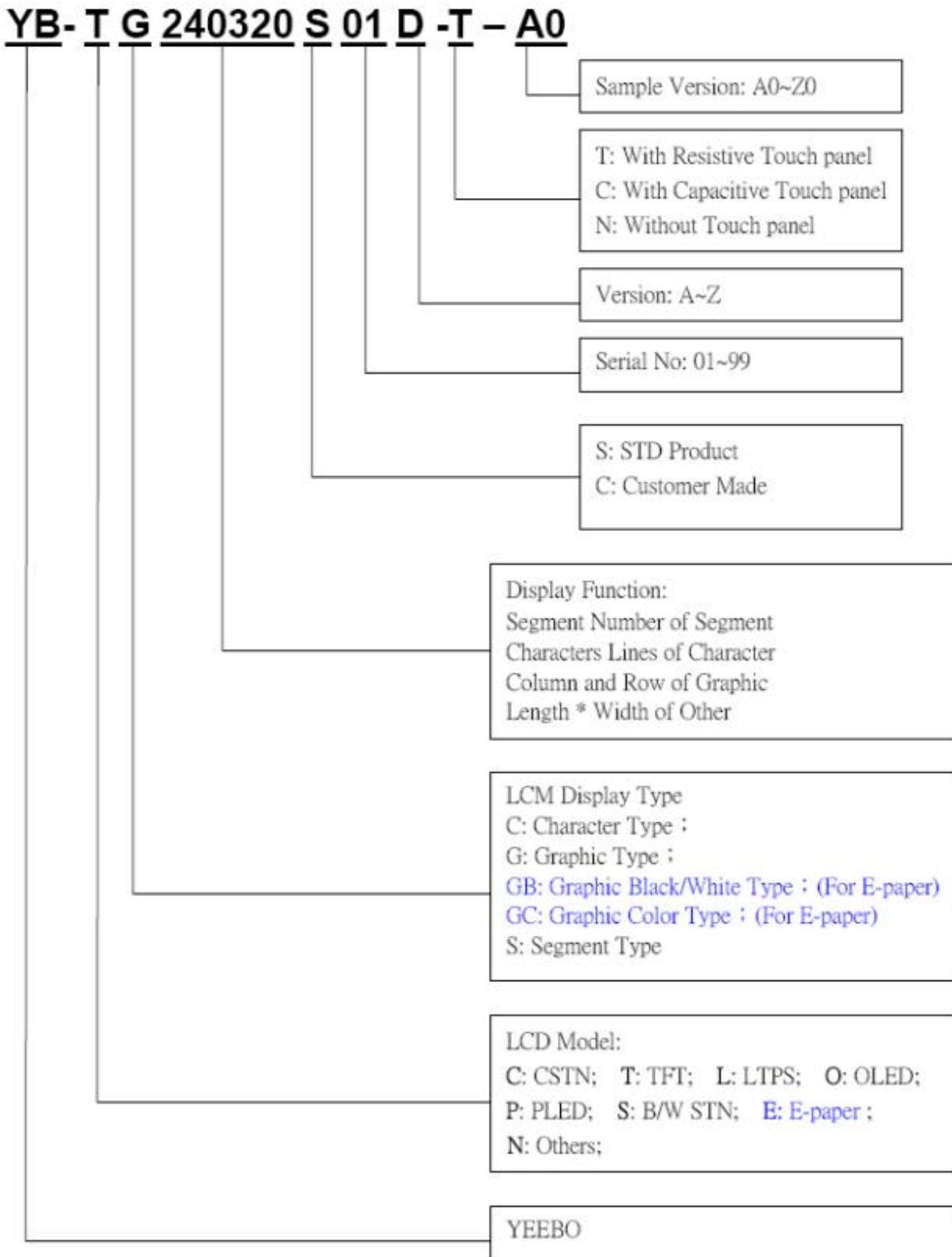

#### **4. General Specification:**

ITEM	CONTENTS
Module Size	120.7 (W) * 75.8 (H) * 2.8(T) mm
Module Size(With FPC)	120.7 (W) * 124.79(H) * 2.8(T) mm
Display Size	5.0 inch
Display Format	800(RGB)* 480 Pixel
Active Area	108.0(W) *64.8(H) mm
Dots Pitch	0.045 * 0.135mm
LCD Type	Active matrix TFT/ Transmissive
Input Data	24 bit RGB interface
Viewing Direction (Gray inversion)	6 O'clock
The Best Viewing Direction	12 O'clock
Source Drive IC	HX8264-E00DPD400
Gate Drive IC	HX8664-B00BPD400
Weight	TBD

## 5. LCM drawing:

Count drawing & Spec.revision record during discussion with customer		Date
Rec.	Revision content description	2022-06-14
#1	FIRST ISSUE	
#2	Modified LCD & IC	2022-07-07

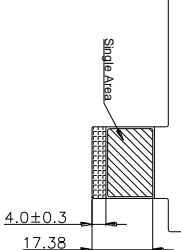
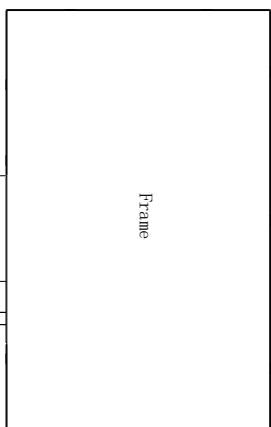
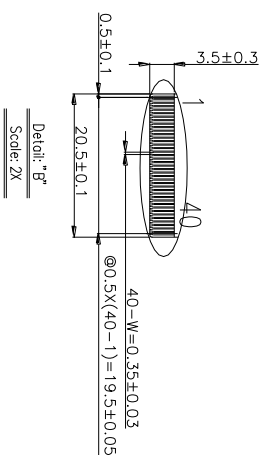
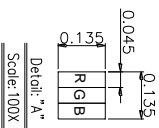
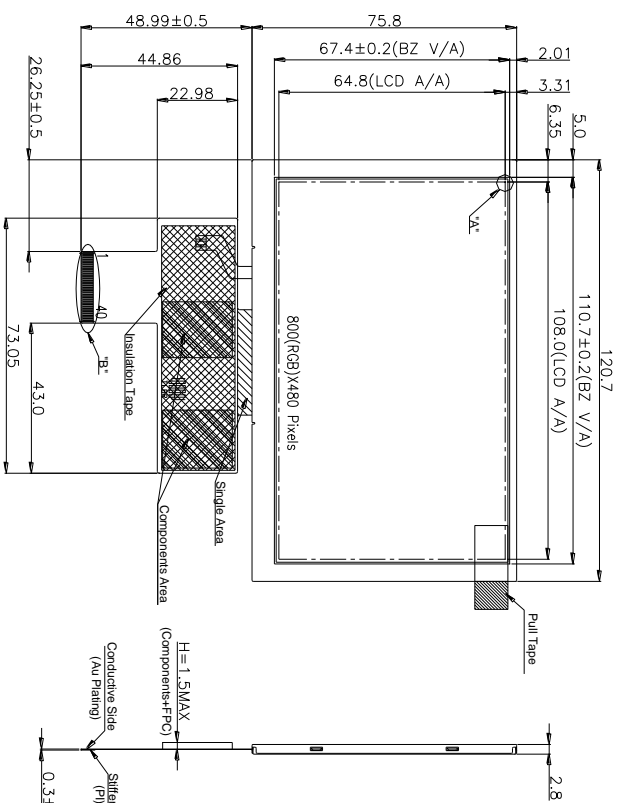

LCD MODULE FPC PIN OUT NO.	SYMBOL
1	K
2	A
3	GND
4	VDD
5	R0
6	R1
7	R2
8	R3
9	R4
10	R5
11	R6
12	R7
13	R0
14	G1
15	G2
16	G3
17	G4
18	G5
19	G6
20	G7
21	B0
22	B1
23	B2
24	B3
25	B4
26	B5
27	B6
28	B7
29	GND
30	DCLK
31	DISP
32	HSYNC
33	VSYNC
34	DE
35	NC
36	GND
37	NC
38	NC
39	NC
40	NC

		MOD. Name	YB-TG800480S34A-N-A	DESIGNED	CHECKED	VERIFIED	APPROVED	FILE NAME	Count Dwg.
UNIT	SIZE	SCALE							
mm	A4	N-T-S							
									
Sheet	Of								
1	1								



## 6. Electrical Characteristics

### 6-1 Absolute Maximum Ratings

(Ta=25°C VSS=0V)

Item	Symbol	Min.	Type	Max.	Unit	Remark
Digital Supply Voltage	VDD	-0.5		5.0	V	
Analog Supply Voltage	AVDD	-0.5	-	15	V	
Operating Temperature	Topr	-20	-	+70	°C	
Storage Temperature	Tstg	-30	-	+80	°C	

### 6-2 Operating Conditions

(Ta=25°C VSS=0V)

Item	Symbol	Condition	Min.	Typ.	Max.	Unit
Power Supply Voltage	VDD	-	2.7	3.3	3.6	V
	AVDD	-	6.5	-	13.5	V
	VGH	-	14.5	15	15.5	V
	VGL	-	-8.5	-18	-7.5	V
Common Electrode Voltage	VCOM	-	3.74	4.24	4.74	V
Current for Driver	I <sub>VDD</sub>	DVDD=3.3V	-	TBD	-	mA
	I <sub>AVDD</sub>	AVDD=10V	-	TBD	-	mA

### 6-3 Data Input Timing

#### 6-3-1 Input clock and data timing waveform

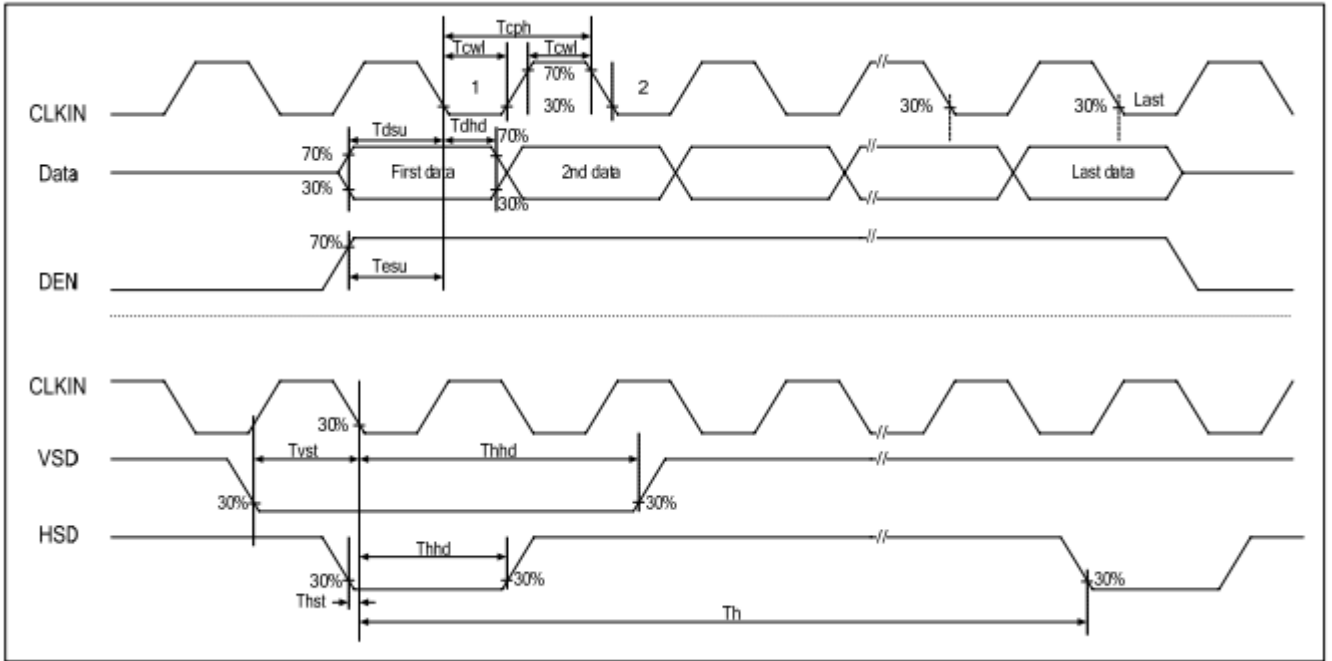

#### 6-3-2 Source output timing waveform

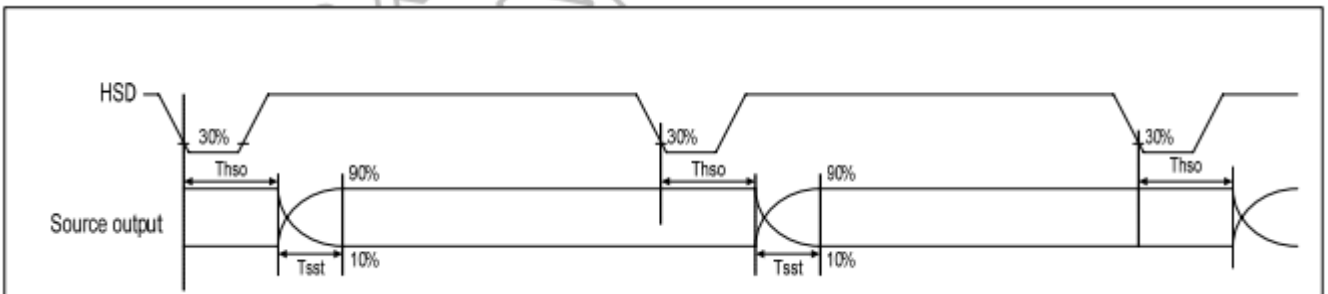

### 6-3-3 Data input format (800×480)

- **Horizontal timing**

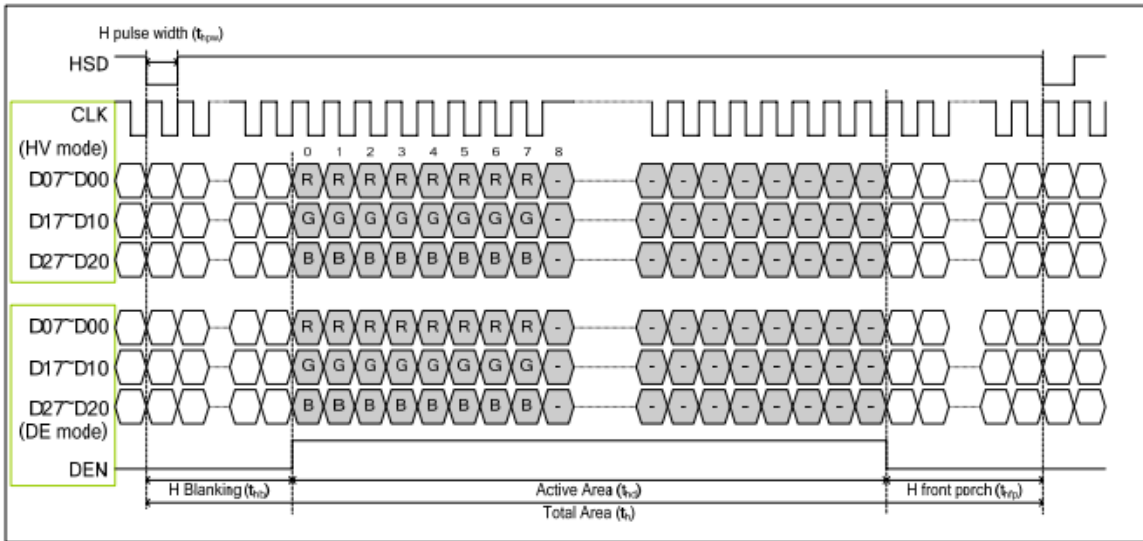

- **Vertical Timing**

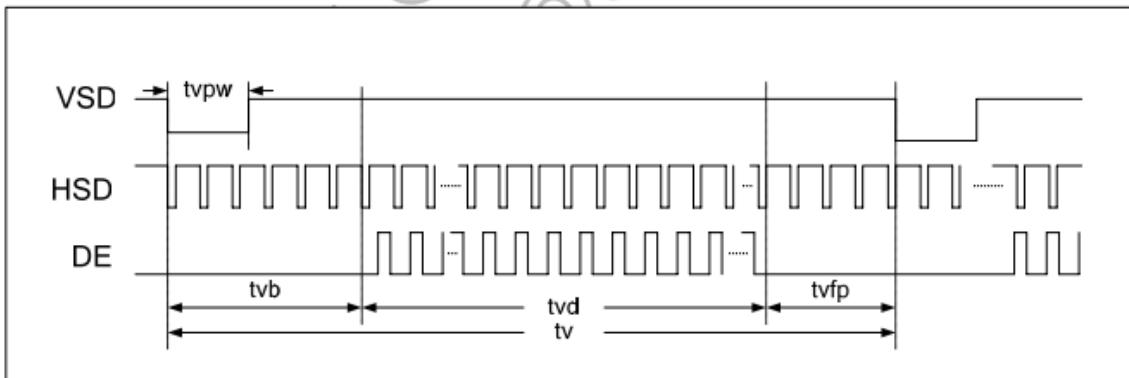

- **Horizontal Timing**

Parameter	Symbol	Spec.			Unit
		Min.	Typ.	Max.	
Horizontal Display Area	thd	-	800		DCLK
DCLK frequency	fclk	-	33.3	50	MHz
One Horizontal Line	th	862	1056	1200	DCLK
HS pulse width (Min.)	thpw		1		DCLK
HS pulse width (Typical.)	thpw		-		DCLK
HS pulse width (Max.)	thpw		40		DCLK
HS Back Porch (Blanking)	thb	46	46	46	DCLK
HS Front Porch	thfp	16	210	354	DCLK
DE mode Blanking	th-thd	45	256	400	DCLK

- **Vertical Timing**

Parameter	Symbol	Spec.			Unit
		Min.	Typ.	Max.	
Vertical Display Area	tvd		480		TH
VS period time	tv	510	525	650	TH
VS pulse width	tvpw	1	-	20	TH
VS Back Porch (Blanking)	tvb	23	23	23	TH
VS Front Porch	tvfp	7	22	147	TH
DE mode Blanking	tv-tvd	4	45	170	TH

### 6-3-4 Power on/off sequence

To prevent the device damage from latch up, the power on/off sequence shown below must be followed.

Power ON: VDD, GND → AVDD, AVSS → V1 to V14  
Power OFF: V1 to V14 → AVDD, AVSS → VDD, GND

HX8264-E has a power ON/OFF sequence control function. In order to prevent IC from power on reset fail, the rising time( $T_{POR}$ ) of the digital power supply VDD should be maintained within the given specifications. Please refer to "AC characteristics" for more detail on timing.

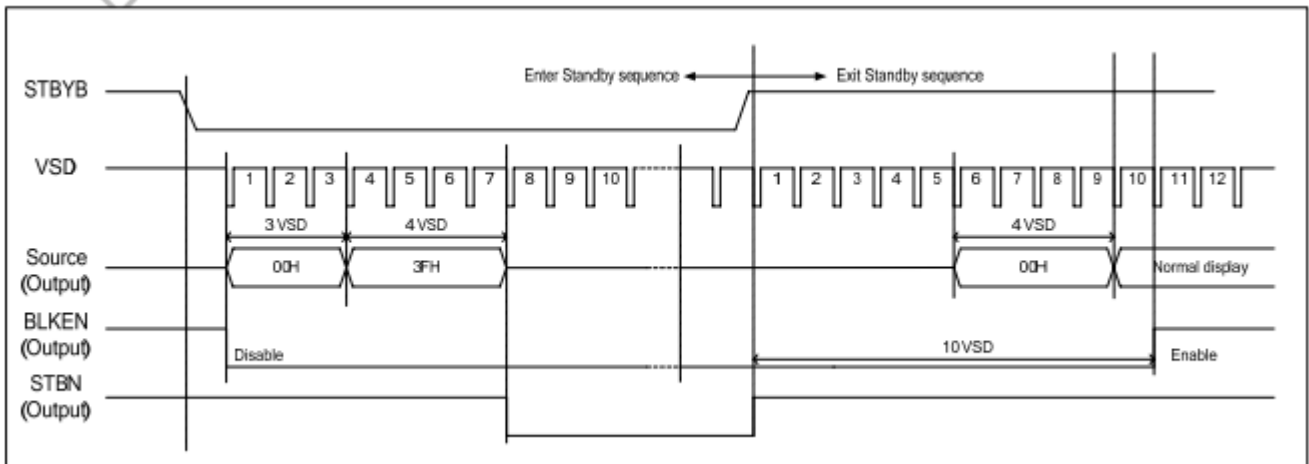
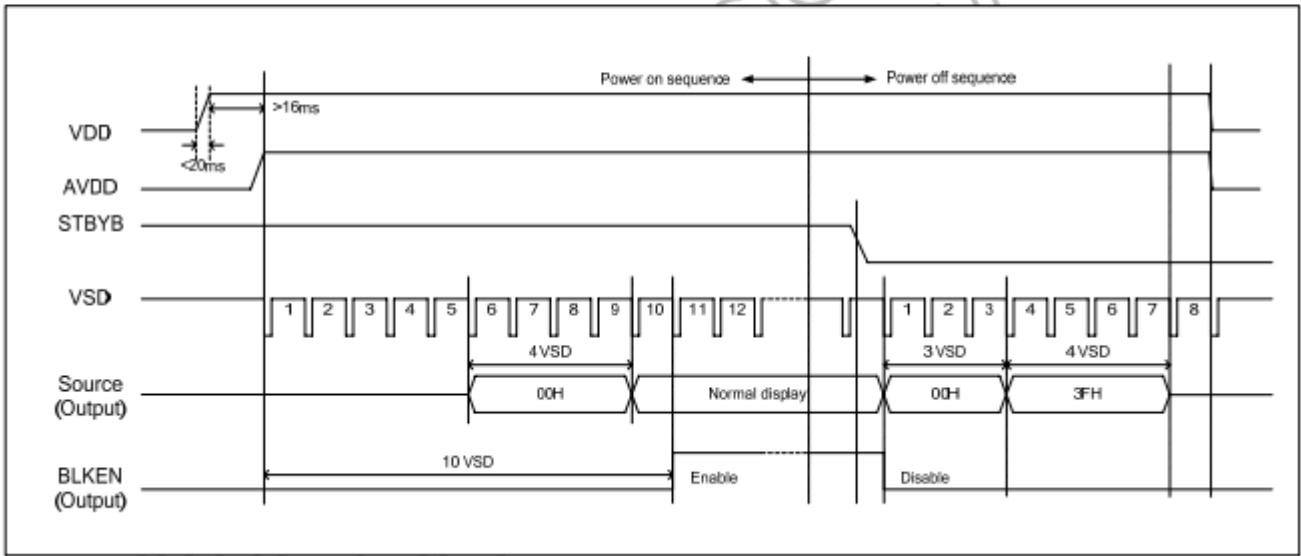

## 7. Optical Characteristics:

Item	Symbol	Conditions	Specifications			Unit	Note	
			Min	Typ	Max			
Transmittance	T(%)	-	3.55	4.48	-	%	-	
Contrast Ratio	CR	$\Theta=0$ Normal Viewing angle	400	500	-		(1) (2)	
Response time	TR+TF	-	-	25	50	ms	(1) (3)	
Viewing angle	Hor.	$\Theta_{x+}$	CR $\geq 10$	60	70	-	deg.	(1)
		$\Theta_{x-}$		60	70	-		
	Ver.	$\Theta_{y+}$		40	50	-		
		$\Theta_{y-}$		60	70	-		

### Measuring Condition

1. Measuring surrounding: dark room
2. Ambient temperature:  $25 \pm 2^\circ\text{C}$
3. 30 min. Warm-up time.

### Color of CIE Coordinate:

Item	Symbol	Condition	Min.	Typ.	Max.	
Chromaticity Coordinates (Transmissive)	Red	x	TBD	0.579	TBD	
		y	TBD	0.308	TBD	
	Green	x	$\theta = \phi = 0^\circ$ LED Backlight	TBD	0.316	TBD
		y		TBD	0.553	TBD
	Blue	x		TBD	0.138	TBD
		y		TBD	0.129	TBD
	White	x		TBD	0.312	TBD
		y		TBD	0.330	TBD

Note (1) Definition of Viewing Angle :

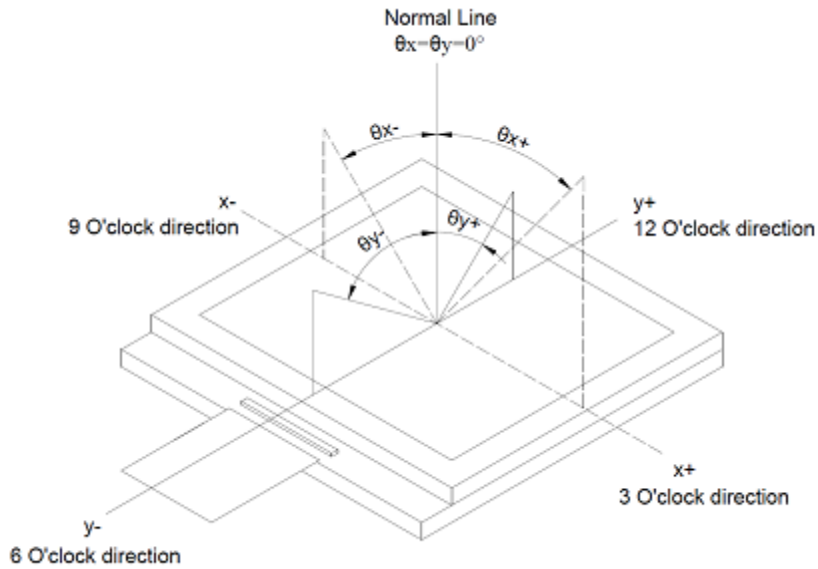

Note (2) Definition of Contrast Ratio(CR) :  
measured at the center point of panel

$$\text{Contrast ratio (CR)} = \frac{\text{Photo detector output when LCD is at "White" state}}{\text{Photo detector output when LCD is at "Black" state}}$$

Note (3) Definition of Response Time : Sum of TR and TF

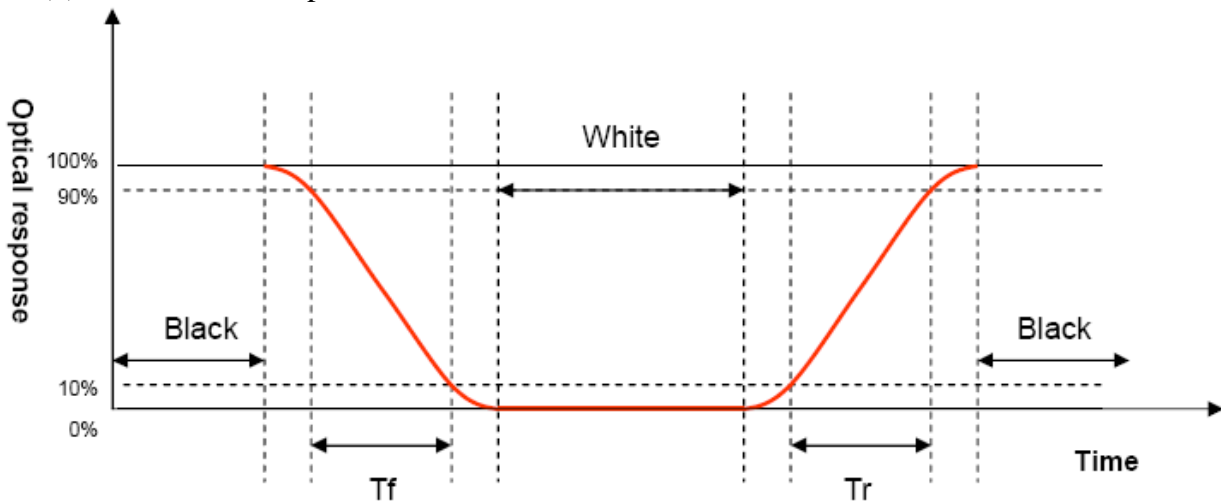

## 8. Interface Pin Assignment:

PIN NO.	Symbol	I/O	Description
1	K	P	Power for LED backlight cathode
2	A	P	Power for LED backlight anode
3	GND	P	Power ground
4	VDD	P	Power voltage
5~12	R0~R7	I	Red data
13~20	G0~G7	I	Green data
21~28	B0~B7	I	Blue data
29	GND	P	Power ground
30	DCLK ( CLK )	I	Pixel clock
31	DISP	I	Display on/off , normally pulled high
32	HSYNC ( HSD )	I	Horizontal sync signal If not used, fix this pin at VDD
33	VSYSN ( VSD )	I	Vertical sync signal If not used, fix this pin at VDD
34	DEN ( DE )	I	Data enable (active High)
35	NC	-	No connection
36	GND	P	Power ground
37	NC	-	No connection
38	NC	-	No connection
39	NC	-	No connection
40	NC	-	No connection

**9. Back Diagram :**

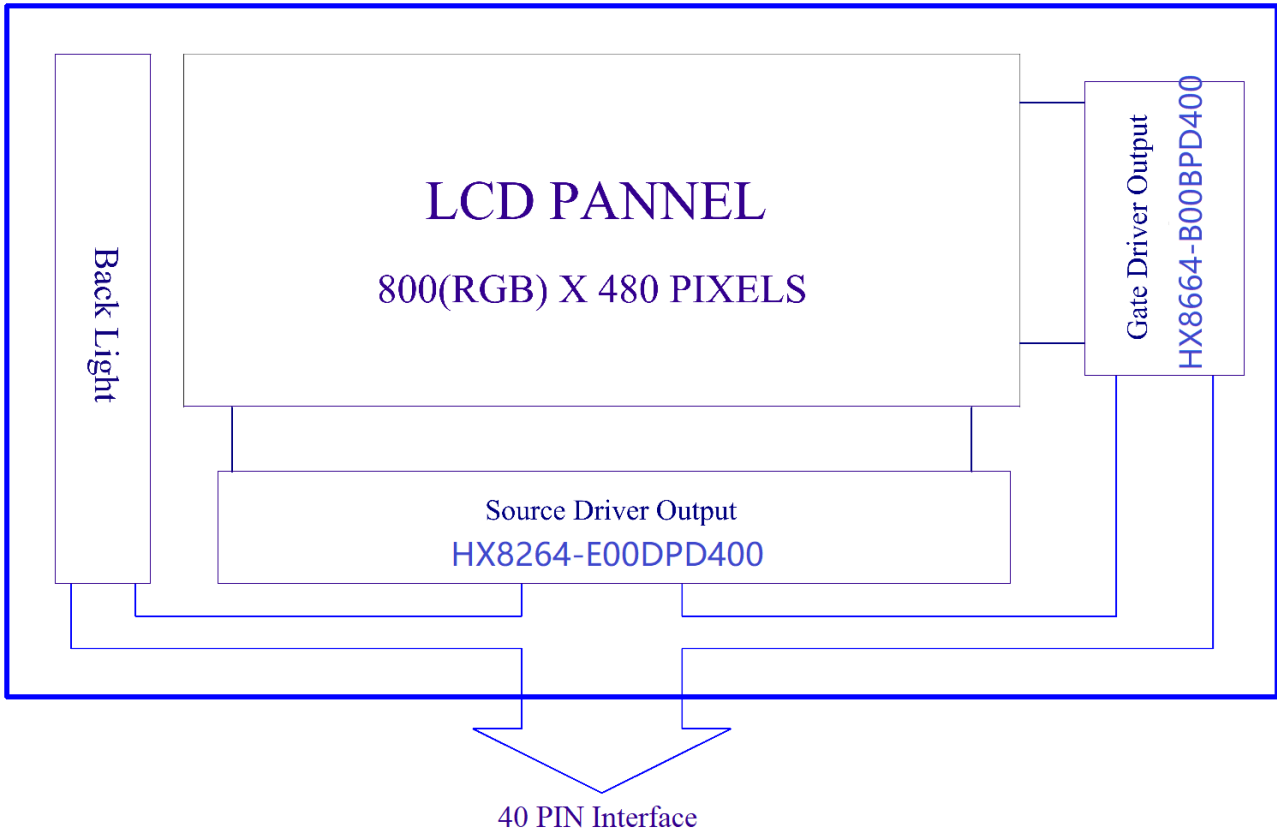



## 10. Backlight:

1. Standard Lamp Styles (Edge Lighting Type):  
The LED chips are distributed over the edge light area of the illumination unit, which gives the less power consumption:
2. The Main Advantages of the LED Backlight are as following:
  - 2.1 The brightness of the backlight can simply be adjusted.  
By a resistor or a potentiometer.

### 3. Data About LED Backlight:

( $T_a=25^{\circ}\text{C}$ )

PARAMETER	Sym.	Min.	Typ.	Max.	Unit	Test Condition	Note
Supply Voltage	V	16.8	18.6	20.4	V	If=40mA	
Luminous Intensity for LCM	IV	380	470	-	Cd/m <sup>2</sup>	If=40mA	2
Uniformity for LCM	-	70	-	-	%		3
Life Time	-	20000	-	-	Hr.		4
Color	White						

#### NOTE:

1. Backlight Only
2. Average Luminous Intensity of P1-P9
3. Uniformity = Min/Max \* 100%
4. LED life time defined as follows: The final brightness is at 50% of original brightness

Internal Circuit Diagram

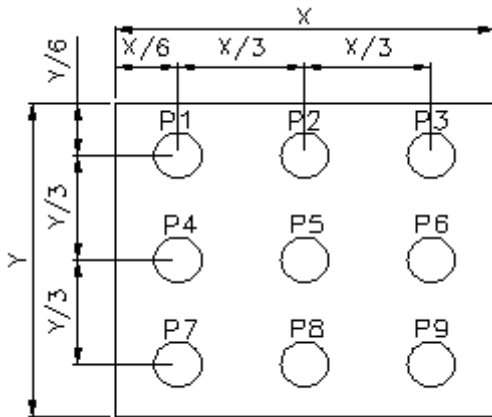

CIRCUIT DIAGRAM  
B/L Electrical Circuit

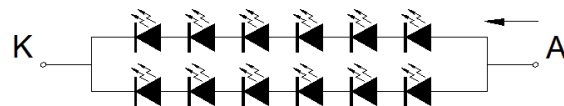

(Effective spatial Distribution)

Using aperture of  $1^{\circ}$ , distance 50cm.

## 11. Standard Specification for Reliability .:

### 11-1. Standard Specifications for Reliability of LCD Module

No	Item	Description
01	High temperature operation	The sample should be allowed to stand at 70°C for 120 hours under driving condition and then returning it to normal temperature condition, and allowing it stand for 2 hours.
02	Low temperature operation	The sample should be allowed to stand at -20°C for 120 hours under driving condition and then returning it to normal temperature condition, and allowing it stand for 2 hours.
03	High temperature storage	The sample should be allowed to stand at 80°C for 240 hours under no-load condition, and then returning it to normal temperature condition, and allowing it stand for 2 hours.
04	Low temperature storage	The sample should be allowed to stand at -30°C for 240 hours under no-load condition, then returning it to normal temperature condition, and allowing it stand for 2 hours.
05	Moisture storage	The sample should be allowed to stand at 60°C,90%RH MAX for 240 hours under no-load condition, then taking it out and drying it at normal temperature for 2 hours.
06	Thermal shock storage	The sample should be allowed to stand the following 10 cycles : -30°C for 30 minutes → normal temperature for 5 minutes → +80°C for 30 minutes → normal temperature for 5 minutes, as one cycle.
07	Packing vibration	Frequency range : 10Hz ~ 55Hz Amplitude of vibration : 1.5mm      Sweep time: 12 min X,Y,Z 2 hours for each direction.
08	Packing drop test	According to ISTA 1A 2001.
09	Electrical Static Discharge	Air: ±6KV 150pF/330Ω 5 times
		Contact: ±4KV 150pF/330Ω 5 time

\*Sample size for each test item is 3~5pcs

## 11 - 2. Testing Conditions and Inspection Criteria

For the final test the testing sample must be stored at room temperature for 24 hours, after the tests listed in Table 12.2, Standard specifications for Reliability have been executed in order to ensure stability.

No	Item	Test Model	In section Criteria
01	Current Consumption	Refer To Specification	The current consumption should conform to the product specification.
02	Contrast	Refer To Specification	After the tests have been executed, the contrast must be larger than half of its initial value prior to the tests.
03	Appearance	Visual inspection	Defect free.

## 11- 3. MTBF

MTBF	Functions, performance, appearance, etc. shall be free from remarkable deterioration within 50,000 hours under ordinary operating and storage conditions room temperature ( $25\pm 5^{\circ}\text{C}$ ), normal humidity ( $50\pm 10\%$ RH), and in area not exposed to direct sun light.
------	---

## 12. Specification of Quality Assurance:

### 12-1. Purpose

This standard for Quality Assurance should affirm the quality of LCD module products to supply to purchaser by YEEBO CORPORATION (Supplier).

### 12-2. Standard for Quality Test

#### a. Inspection:

Before delivering, the supplier should take the following tests, and affirm the quality of product.

#### b. Electro-Optical Characteristics:

According to the individual specification to test the product.

#### c. Test of Appearance Characteristics:

According to the individual specification to test the product.

#### d. Test of Reliability Characteristics:

According to the definition of reliability on the specification for testing products.

#### e. Delivery Test:

Before delivering, the supplier should take the delivery test.

(i) Test method: According to **ISO2859-1**. General Inspection Level **II** take a single time.

(ii) The defects classify of AQL as following:

Major defect: AQL = 0.65

Minor defect: AQL = 2.5

Total defects: AQL = 2.5

### 12-3. Non- conforming Analysis & Deal With Manners

#### a. Non- conforming Analysis:

(i) Purchaser should supply the detail data of non- conforming sample and the non- conforming.

(ii) After accepting the detail data from purchaser, the analysis of non- conforming should be finished in two weeks.

(iii) If supplier can not finish analysis on time, must announce purchaser before 3 days.

#### b. Disposition of non- conforming:

(i) If find any product defect of supplier during assembly time, supplier must change the good product for every defect after recognition.

(ii) Both supplier and customer should analyze the reason and discuss the disposition of non- conforming when the reason of nonconforming is not sure.

### 12-4. Agreement items

Both sides should discuss together when the following problems happen.

a. There is any problem of standard of quality assurance, and both sides should think that must be modified.

b. There is any argument item which does not record in the standard of quality assurance.

c. Any other special problem.

12-5. Standard of The Product Appearance Test

a. Manner of appearance test:

(i) The test must be under 20W × 2 or 40W fluorescent light, and the distance of view must be at 30±5cm.

(ii) When test the model of transmissive product must add the reflective plate.

(iii) The test direction is base on around 10° of vertical line.

(iii) Temperature: 25±5°C Humidity: 60±10%RH

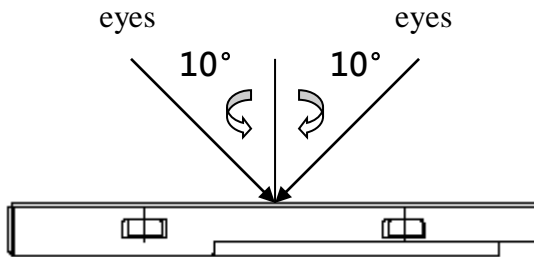

(iv) Definition of area:

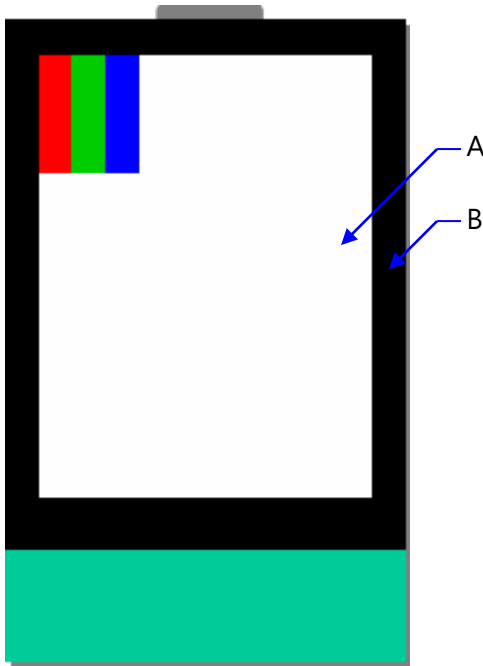

A. Area: Viewing area.

B. Area: Out of viewing area.

(Outside viewing area)

b. Basic principle:

(i) It will accord to the AQL when the standard can not be described.

(ii) The sample of the lowest acceptable quality level must be discussed by both supplier and customer when any dispute happened.

(iii) Must add new item on time when it is necessary.

c. Standard of inspection: (Unit: mm)

12-6. Inspection specification  
Defect out of viewing area can be neglected.

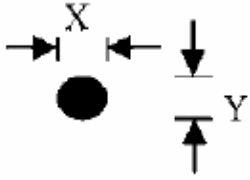
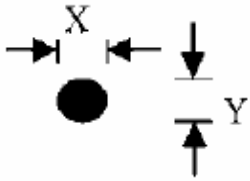
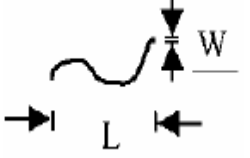
NO	Item	Criterion	AQL																							
01	Electrical Testing	1.1 Missing vertical, horizontal segment, segment contrast defect. 1.2 Missing character, dot or icon. 1.3 Display malfunction. 1.4 No function or no display. 1.5 Current consumption exceeds product specifications. 1.6 LCD viewing angle defect. 1.7 Mixed product types. 1.8 Flicker	<b>0.65</b>																							
02	Black or White spots or Bright spots or Color spots on LCD (Display only)	2.1 Dot dimension as below drawing: $\Phi = (X+Y) / 2$  <table border="1" data-bbox="762 772 1292 963"> <thead> <tr> <th>Size(mm)</th> <th>Acceptable Q'ty</th> </tr> </thead> <tbody> <tr> <td><math>\Phi \leq 0.20</math></td> <td>Accept no dense</td> </tr> <tr> <td><math>0.20 &lt; \Phi \leq 0.40</math></td> <td>5</td> </tr> <tr> <td><math>0.40 &lt; \Phi</math></td> <td>0</td> </tr> </tbody> </table> 2.2 Not visible through 5% ND filter * Densely spaced: No more than two spots within 3mm.	Size(mm)	Acceptable Q'ty	$\Phi \leq 0.20$	Accept no dense	$0.20 < \Phi \leq 0.40$	5	$0.40 < \Phi$	0	<b>2.5</b>															
Size(mm)	Acceptable Q'ty																									
$\Phi \leq 0.20$	Accept no dense																									
$0.20 < \Phi \leq 0.40$	5																									
$0.40 < \Phi$	0																									
03	LCD and Touch Panel black spots, white spots, contamination (non – display)	3.1 Round type: As following drawing $\Phi = (X+Y) / 2$  <table border="1" data-bbox="762 1198 1292 1388"> <thead> <tr> <th>Size(mm)</th> <th>Acceptable Q'ty</th> </tr> </thead> <tbody> <tr> <td><math>\Phi \leq 0.20</math></td> <td>Accept no dense</td> </tr> <tr> <td><math>0.20 &lt; \Phi \leq 0.40</math></td> <td>5</td> </tr> <tr> <td><math>0.40 &lt; \Phi</math></td> <td>0</td> </tr> </tbody> </table> * Densely spaced: No more than two spots within 3mm. 3.2 Line type: (As following drawing)  <table border="1" data-bbox="667 1568 1292 1915"> <thead> <tr> <th>Length(mm)</th> <th>Width(mm)</th> <th>Acceptable Q'ty</th> </tr> </thead> <tbody> <tr> <td><math>L \leq 10</math></td> <td><math>W \leq 0.1</math></td> <td>Accept no dense</td> </tr> <tr> <td><math>L \leq 10.0</math></td> <td><math>0.1 &lt; W \leq 0.25</math></td> <td>4</td> </tr> <tr> <td><math>L &gt; 10</math></td> <td>----</td> <td>Rejection</td> </tr> <tr> <td>----</td> <td><math>0.25 &lt; W</math></td> <td>Rejection</td> </tr> </tbody> </table> * Densely spaced: No more than two lines within 3mm.	Size(mm)	Acceptable Q'ty	$\Phi \leq 0.20$	Accept no dense	$0.20 < \Phi \leq 0.40$	5	$0.40 < \Phi$	0	Length(mm)	Width(mm)	Acceptable Q'ty	$L \leq 10$	$W \leq 0.1$	Accept no dense	$L \leq 10.0$	$0.1 < W \leq 0.25$	4	$L > 10$	----	Rejection	----	$0.25 < W$	Rejection	<b>2.5</b>
Size(mm)	Acceptable Q'ty																									
$\Phi \leq 0.20$	Accept no dense																									
$0.20 < \Phi \leq 0.40$	5																									
$0.40 < \Phi$	0																									
Length(mm)	Width(mm)	Acceptable Q'ty																								
$L \leq 10$	$W \leq 0.1$	Accept no dense																								
$L \leq 10.0$	$0.1 < W \leq 0.25$	4																								
$L > 10$	----	Rejection																								
----	$0.25 < W$	Rejection																								

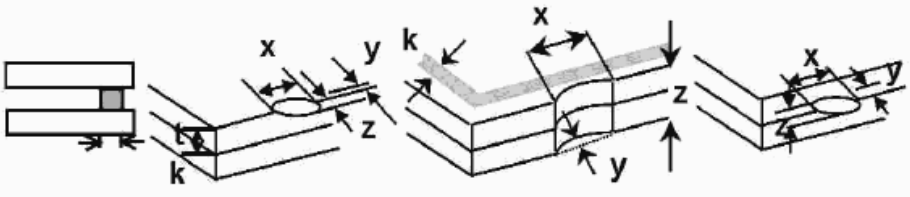
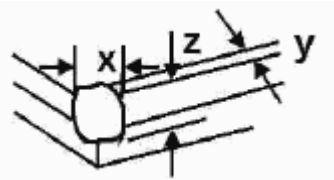
NO	Item	Criterion	AQL																		
04	Polarizer bubbles	<p>If bubbles are visible, judge using black spot specifications, not easy to find, must check in specify direction</p> <table border="1"> <thead> <tr> <th>Size <math>\Phi</math>(mm)</th> <th>Acceptable Q'ty</th> </tr> </thead> <tbody> <tr> <td><math>\Phi \leq 0.20</math></td> <td>Accept no dense</td> </tr> <tr> <td><math>0.20 &lt; \Phi \leq 0.50</math></td> <td>4</td> </tr> <tr> <td><math>0.50 &lt; \Phi \leq 1.00</math></td> <td>3</td> </tr> <tr> <td><math>1.00 &lt; \Phi</math></td> <td>0</td> </tr> <tr> <td>Total Q'ty</td> <td>4</td> </tr> </tbody> </table>	Size $\Phi$ (mm)	Acceptable Q'ty	$\Phi \leq 0.20$	Accept no dense	$0.20 < \Phi \leq 0.50$	4	$0.50 < \Phi \leq 1.00$	3	$1.00 < \Phi$	0	Total Q'ty	4	2.5						
Size $\Phi$ (mm)	Acceptable Q'ty																				
$\Phi \leq 0.20$	Accept no dense																				
$0.20 < \Phi \leq 0.50$	4																				
$0.50 < \Phi \leq 1.00$	3																				
$1.00 < \Phi$	0																				
Total Q'ty	4																				
05	Scratches	Follow NO.3 -2 Line Type.																			
06	Mura	Not visible through 5% ND filter in 50% gray.	2.5																		
07	Chipped glass	<p>Symbols:  x: Chip length            y: Chip width            z: Chip thickness  k: Seal width            t: Glass thickness    a: LCD side length  L: Electrode pad length</p> <p>7.1 General glass chip:  7.1.1 Chip on panel surface and crack between panels:</p>  <table border="1"> <thead> <tr> <th>z: Chip thickness</th> <th>y: Chip width</th> <th>x: Chip length</th> </tr> </thead> <tbody> <tr> <td><math>Z \leq 1/2t</math></td> <td>Not over viewing area</td> <td><math>x \leq 1/8a</math></td> </tr> <tr> <td><math>1/2t &lt; z \leq 2t</math></td> <td>Not exceed 1/3k</td> <td><math>x \leq 1/8a</math></td> </tr> </tbody> </table> <p>Unit: mm  ⊙ If there are 2 or more chips, x is the total length of each chip</p> <p>7.1.2 Corner crack:</p>  <table border="1"> <thead> <tr> <th>z: Chip thickness</th> <th>y: Chip width</th> <th>x: Chip length</th> </tr> </thead> <tbody> <tr> <td><math>Z \leq 1/2t</math></td> <td>Not over viewing area</td> <td><math>x \leq 1/8a</math></td> </tr> <tr> <td><math>1/2t &lt; z \leq 2t</math></td> <td>Not exceed 1/3k</td> <td><math>x \leq 1/8a</math></td> </tr> </tbody> </table> <p>Unit: mm  ⊙ If there are 2 or more chips, x is the total length of each chip</p>	z: Chip thickness	y: Chip width	x: Chip length	$Z \leq 1/2t$	Not over viewing area	$x \leq 1/8a$	$1/2t < z \leq 2t$	Not exceed 1/3k	$x \leq 1/8a$	z: Chip thickness	y: Chip width	x: Chip length	$Z \leq 1/2t$	Not over viewing area	$x \leq 1/8a$	$1/2t < z \leq 2t$	Not exceed 1/3k	$x \leq 1/8a$	2.5
z: Chip thickness	y: Chip width	x: Chip length																			
$Z \leq 1/2t$	Not over viewing area	$x \leq 1/8a$																			
$1/2t < z \leq 2t$	Not exceed 1/3k	$x \leq 1/8a$																			
z: Chip thickness	y: Chip width	x: Chip length																			
$Z \leq 1/2t$	Not over viewing area	$x \leq 1/8a$																			
$1/2t < z \leq 2t$	Not exceed 1/3k	$x \leq 1/8a$																			

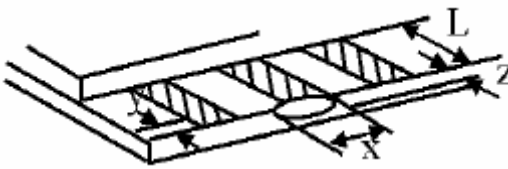
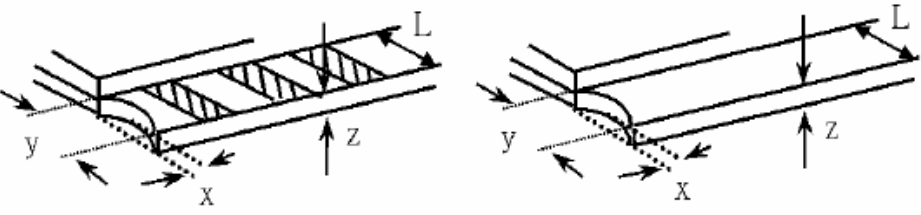
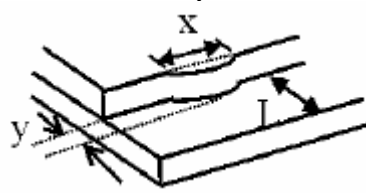
NO	Item	Criterion	AQL																
08	Glass crack	<p>Symbols:  x: Chip length                      y: Chip width                      z: Chip thickness  k: Seal width                      t: Glass thickness                      a: LCD side length  L: Electrode pad length</p> <p>8.1 Protrusion over terminal:  8.1.1 Chip on electrode pad:</p>  <table border="1" data-bbox="486 694 1173 862"> <tr> <td>y: Chip width</td> <td>x: Chip length</td> <td>z: Chip thickness</td> </tr> <tr> <td><math>y \leq 0.5\text{mm}</math></td> <td><math>x \leq 1/8a</math></td> <td><math>0 &lt; z \leq t</math></td> </tr> </table> <p>8.1.2 Non-conductive portion:</p>  <table border="1" data-bbox="486 1209 1173 1377"> <tr> <td>y: Chip width</td> <td>x: Chip length</td> <td>z: Chip thickness</td> </tr> <tr> <td><math>y \leq L</math></td> <td><math>x \leq 1/8a</math></td> <td><math>0 &lt; z \leq t</math></td> </tr> </table> <p>⊙ If there chipped area touches the ITO terminal, over 2/3 of the ITO must remain and be inspected according to electrode terminal specifications.</p> <p>⊙ If the product will be heat sealed by the customer, the alignment mark must not be damaged.</p> <p>8.1.3 Substrate protuberance and internal crack</p>  <table border="1" data-bbox="805 1713 1244 1870"> <tr> <td>y: width</td> <td>x: length</td> </tr> <tr> <td><math>y \leq 1/3L</math></td> <td><math>X \leq a</math></td> </tr> </table>	y: Chip width	x: Chip length	z: Chip thickness	$y \leq 0.5\text{mm}$	$x \leq 1/8a$	$0 < z \leq t$	y: Chip width	x: Chip length	z: Chip thickness	$y \leq L$	$x \leq 1/8a$	$0 < z \leq t$	y: width	x: length	$y \leq 1/3L$	$X \leq a$	2.5
y: Chip width	x: Chip length	z: Chip thickness																	
$y \leq 0.5\text{mm}$	$x \leq 1/8a$	$0 < z \leq t$																	
y: Chip width	x: Chip length	z: Chip thickness																	
$y \leq L$	$x \leq 1/8a$	$0 < z \leq t$																	
y: width	x: length																		
$y \leq 1/3L$	$X \leq a$																		



NO	Item	Criterion	AQL
09	Cracked glass	The LCD with extensive crack is not acceptable.	2.5
10	Backlight elements	10.1 Illumination source flickers when lit. 10.2 Spots or scratches that appear when lit must be judged. Using LCD spot, lines and contamination standards. 10.3 Backlight doesn't light or color is wrong.	2.5 2.5 0.65
11	Bezel	Bezel must comply with product specifications.	2.5
12	PCB、COB	12.1 COB seal may not have pinholes larger than 0.2mm or contamination. 12.2 COB seal surface may not have pinholes through to the IC. 12.3 The height of the COB should not exceed the height indicated in the assembly diagram. 12.4 There may not be more than 2mm of sealant outside the seal area on PCB. And there should be no more than three places. 12.5 Parts on PCB must be the same as on the production characteristic chart, There should be no wrong parts, missing parts or excess parts. 12.6 The jumper on the PCB should conform to the product characteristic chart. 12.7 PCBA cosmetic control base on latest IPC standard,IPC-A-610,acceptalbe limit of grade 2.	2.5 2.5 2.5 2.5 0.65 0.65 2.5
13	FPC	13.1 FPC terminal damage $\leq 1/2$ FPC terminal width and can not affect the function , we judge accept. 13.2 FPC alignment hole damage $\leq 1/2$ alignment area and can not affect the function , we judge accept.	2.5 2.5
14	Soldering	14.1 No cold solder joints, missing solder connections, oxidation or icicle. 14.2 No short circuits in components on PCB or FPC.	2.5 0.65

NO	Item	Criterion	AQL												
15	Touch Panel Chipped glass	<p>Symbols:  x: Chip length                      y: Chip width                      z: Chip thickness  k: Seal width                      t: Touch Panel Total thickness    a: LCD side length  L: Electrode pad length</p> <p>15.1 General glass chip:  15.1.1 Chip on panel surface and crack between panels:</p> <table border="1" data-bbox="341 817 1161 1032"> <tr> <td data-bbox="341 817 606 913">z: Chip thickness</td> <td data-bbox="606 817 919 913">y: Chip width</td> <td data-bbox="919 817 1161 913">x: Chip length</td> </tr> <tr> <td data-bbox="341 913 606 1032"><math>z \leq t</math></td> <td data-bbox="606 913 919 1032"><math>\leq 1/2 k</math> and not over viewing area</td> <td data-bbox="919 913 1161 1032"><math>x \leq 1/8a</math></td> </tr> </table> <p>⊙ Unit: mm  ⊙ If there are 2 or more chips, x is the total length of each chip</p> <p>15.1.2 Corner crack:</p> <table border="1" data-bbox="341 1440 1161 1655"> <tr> <td data-bbox="341 1440 606 1536">z: Chip thickness</td> <td data-bbox="606 1440 919 1536">y: Chip width</td> <td data-bbox="919 1440 1161 1536">x: Chip length</td> </tr> <tr> <td data-bbox="341 1536 606 1655"><math>z \leq t</math></td> <td data-bbox="606 1536 919 1655"><math>\leq 1/2 k</math> and not over viewing area</td> <td data-bbox="919 1536 1161 1655"><math>x \leq 1/8a</math></td> </tr> </table> <p>⊙ Unit: mm  ⊙ If there are 2 or more chips, x is the total length of each chip</p>	z: Chip thickness	y: Chip width	x: Chip length	$z \leq t$	$\leq 1/2 k$ and not over viewing area	$x \leq 1/8a$	z: Chip thickness	y: Chip width	x: Chip length	$z \leq t$	$\leq 1/2 k$ and not over viewing area	$x \leq 1/8a$	2.5
z: Chip thickness	y: Chip width	x: Chip length													
$z \leq t$	$\leq 1/2 k$ and not over viewing area	$x \leq 1/8a$													
z: Chip thickness	y: Chip width	x: Chip length													
$z \leq t$	$\leq 1/2 k$ and not over viewing area	$x \leq 1/8a$													

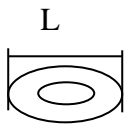
NO	Item	Criterion		AQL
16	Touch Panel(Fish eye)	SIZE(mm)	Acceptable Q'ty	2.5
		$L \leq 0.7$	Accept no dense	
		$L > 0.7\text{mm}$	0	
				
17	Touch Panel Newton ring	Newton ring dimension $\leq 1/2$ touch panel area and not affect font and line distortion( $\leq 2.5\%$ ) , it is acceptable.		2.5
18	Touch Panel Linearity	Less than 2.5% is acceptable.		2.5
19	LCD Ripple	Touch the touch panel , can not see the LCD ripple. Pen: R 1.0mm silicon rubber. Operation Force: 80g		2.5
20	General appearance	20.1 Pin type must match type in specification sheet.		0.65
		20.2 LCD pin loose or missing pins.		0.65
		20.3 Product packaging must the same as specified on packaging specification sheet.		0.65
		20.4 Product dimension and structure must conform to product specification sheet.		0.65

## 13. Handling Precaution:

### 13-1 Handling of LCM

- Don't give external shock.
- Don't apply excessive force on the surface.
- Liquid in LCD is hazardous substance. Must not lick and swallow. when the liquid is attach to your hand, skin, cloth etc. Wash it out thoroughly and immediately.
- Don't operate it above the absolute maximum rating.
- Don't disassemble the LCM.
- The operators should be grounded whenever he/she comes into contact with the module. Never touch any of the conductive parts such as the LSI pads, the copper leads on the PCB and the interface terminals with any parts of the human body.
- The modules should be kept in antistatic bags or other containers resistant to static for storage.
- The module is coated with a film to protect the display surface. Be care when peeling off this protective film since static electricity may be generated.

### 13-2 Storage

- Store in an ambient temperature of  $25\pm 10^{\circ}\text{C}$ , and in a relative humidity of  $50\pm 10\% \text{RH}$ . Don't expose to sunlight or fluorescent light.
- Storage in a clean environment, free from dust, active gas, and solvent.
- Store in anti-static electricity container.
- Store without any physical load.

### 13-3 Soldering

- Use only soldering irons with proper grounding and no leakage.
- Iron: No higher than  $310\pm 10^{\circ}\text{C}$  and less than 3 sec during Hand soldering.
- Rewiring: no more than 2 times.

## **14. Warranty**

This product has been manufactured to specifications as a part for use in your company's general electronic products. It is guaranteed to perform according to delivery specifications. For any other use apart from general electronic equipment, we will not take responsibility if the product is used in medical devices, nuclear power control equipment, aerospace equipment, fire and security systems, or any other applications in which there is a direct risk to human life and where extremely high levels of reliability are required. If the product is to be used in any of the above applications, we will need to enter into a separate product liability agreement.

1. We cannot accept responsibility for any defect arise after additional process of the product (including disassembly and reassembly), after product delivery.
2. We cannot accept responsibility for any defect, which may arise after the application of strong external force to the product.
3. We cannot accept responsibility for any defect, which may arise due to the application of static electricity after the product has passed your company's acceptance inspection procedures.
4. We can not accept responsibility for industrial property, which may arise through the use of your product , with exception to those issues relating directly to the structure or method of manufacturing of our product within one year from YEEBO shipment.
5. For Heatseal Product which required to heatseal by customer side, parts must be used within three months after delivery from factory.
6. For TAB Product which required to solder by customer side, parts must be used within three months after delivery from factory.
7. The liability of YB is limited to repair or replacement on the terms set forth below. YB will not be responsible for any subsequent or consequential events or injury or damage to any personnel or user including third party personnel and/or user. Unless otherwise agreed in writing between YB and the customer, YB will only replace or repair any of its LCD which is found defective electrically or visually when inspected in accordance with YB GENERAL LCD INSPECTION STANDARD.

## **15. Guarantee:**

Our products meet requirements of the environment.

YEEBO ROHS requirement is based on European Union Directive 2011/65/EU (ROHS) Requirements and Update.

## ANSPRECHPARTNER



Für Fragen stehe ich Ihnen gerne persönlich zur Verfügung,

+43 (676) 466 466 0

od. per E-Mail

[robert.glaser@glaser-eng.com](mailto:robert.glaser@glaser-eng.com) .

Anfragen nehmen wir gerne unter der E-Mail-Adresse

[info@glaser-eng.com](mailto:info@glaser-eng.com)

entgegen.





Y o u r t h o u g h t i s o u r p a s s i o n !

[info@glaser-eng.com](mailto:info@glaser-eng.com)

[www.glaser-eng.com](http://www.glaser-eng.com)