

# Bend Aid

Accurate Conduit Bending

User Guide 3.2

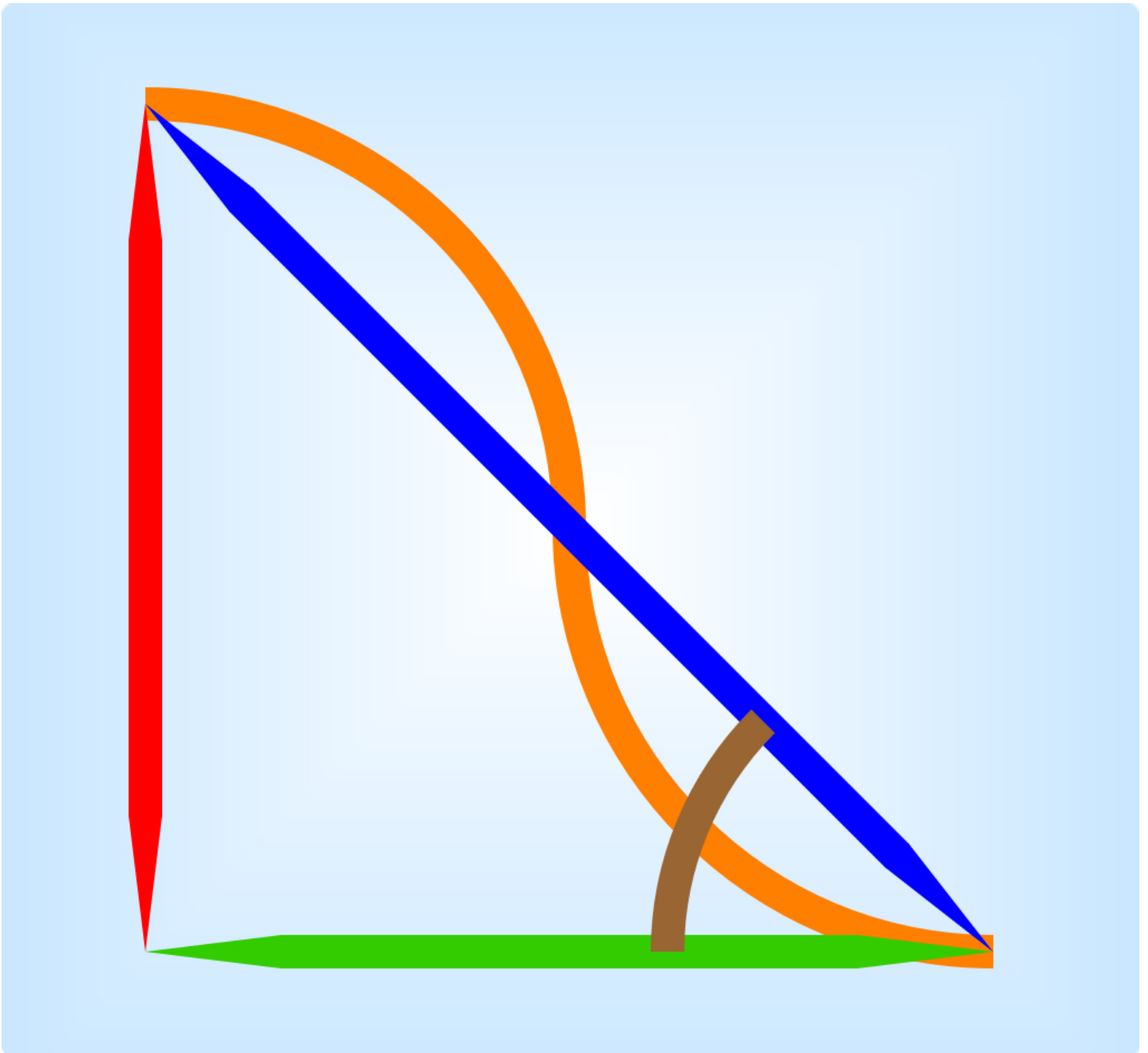

P. D. Stroney

Bend Aid Menu	6
Bend Aid Menu Help	7
Bend Aid Menu General Help	10
Enter Right Triangle	15
Enter Right Triangle Help	16
Answer Right Triangle	18
Answer Right Triangle Help	19
Offsets Menu	21
Offsets Menu Help	22
Enter Offset	24
Enter Offset Help	25
Answer Offset	28
Answer Offset Help	29
Enter Offset Rack	33
Enter Offset Rack Help	34
Answer Offset Rack	37
Answer Offset Rack Help	38
Enter Offset Concentric	43
Enter Offset Concentric Help	44
Answer Offset Concentric	48
Answer Offset Concentric Help	49
Enter Simple Offset	54
Enter Simple Offset Help	55
Answer Simple Offset	58
Answer Simple Offset Help	59
Rolling Offset	63
Measure Offset	64
Saddles Menu	65
3 Point Saddle	66
4 Point Saddle	67
Kicks Menu	68
Kicks Menu Help	69

Enter Kick	70
Enter Kick Help	71
Answer Kick	74
Answer Kick Help	75
Enter Kick Rack	79
Enter Kick Rack Help	80
Answer Kick Rack	83
Answer Kick Rack Help	84
Enter Kick Concentric	88
Enter Kick Concentric Help	89
Answer Kick Concentric	92
Answer Kick Concentric Help	93
Enter Simple Kick	97
Enter Simple Kick Help	98
Answer Simple Kick	100
Answer Simple Kick Help	101
Enter Kick Rack To Horizontal	105
Enter Kick Rack To Horizontal Help	106
Answer Kick Rack To Horizontal	109
Answer Kick Rack To Horizontal Help	110
Enter Kick Concentric To Horizontal	114
Enter Kick Concentric To Horizontal Help	115
Answer Kick Concentric To Horizontal	118
Answer Kick Concentric To Horizontal Help	119
Enter Kick Rack To Vertical	123
Enter Kick Rack To Vertical Help	124
Answer Kick Rack To Vertical	127
Answer Kick Rack To Vertical Help	128
Enter Kick Concentric To Vertical	132
Enter Kick Concentric To Vertical Help	133
Answer Kick Concentric To Vertical	136
Answer Kick Concentric To Vertical Help	137

Nineties Menu	141
Nineties Menu Help	142
Enter Ninety	143
Enter Ninety Help	144
Answer Ninety	147
Answer Ninety Help	148
Enter Ninety Rack	151
Enter Ninety Rack Help	152
Answer Ninety Rack	156
Answer Ninety Rack Help	156
Enter Ninety Concentric	160
Enter Ninety Concentric Help	161
Answer Ninety Concentric	164
Answer Ninety Concentric Help	165
Enter Ninety Back To Back	169
Enter Ninety Back To Back Help	170
Answer Ninety Back To Back	173
Answer Ninety Back To Back Help	174
Enter Ninety Back To Back Rack	178
Enter Ninety Back To Back Rack Help	179
Answer Ninety Back To Back Rack	182
Answer Ninety Back To Back Rack Help	183
Enter Ninety Back To Back Concentric	187
Enter Ninety Back To Back Concentric Help	188
Answer Ninety Back To Back Concentric	191
Answer Ninety Back To Back Concentric Help	192
Enter Find Bend Radius	196
Enter Find Bend Radius Help	197
Answer Find Bend Radius	199
Answer Find Bend Radius Help	200
Chart Benders	202
Enter Segments	205



Enter Segments Help	206
Answer Segments	208
Answer Segments Help	209

# Bend Aid Menu

[General Help](#)

**Bend Aid**

[Help](#)



Right Triangles



Offsets



Kicks



Nineties



Find Bend Radius



Chart Benders

**PLEASE READ THE HELP FILE AT THE TOP RIGHT OF EACH SCENE.**

THIS IS AN OFFSET  
Start of first bend to  
finish of second bend

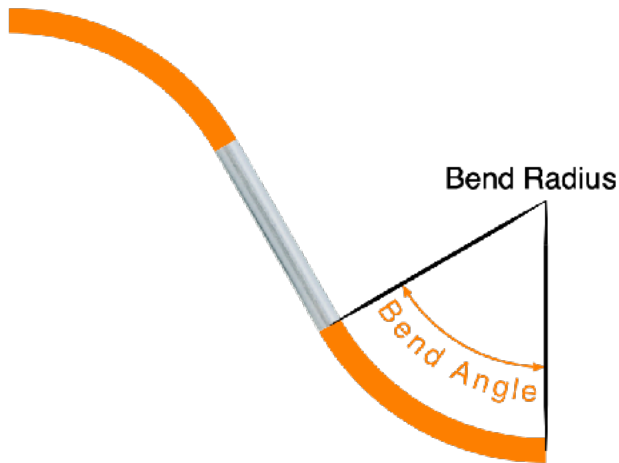

THIS IS NOT AN OFFSET  
This is a right triangle

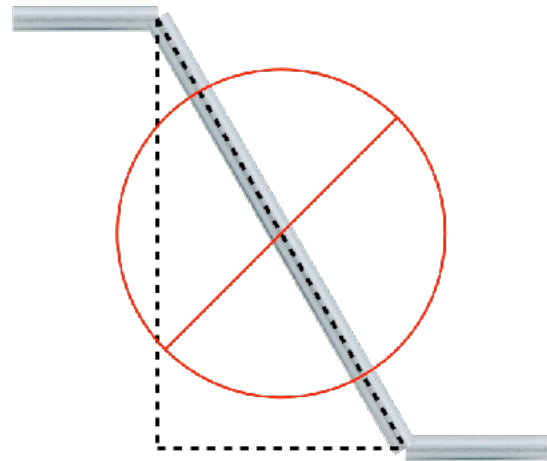

## Bend Aid Menu Help

An offset is not a right triangle.

A right triangle has three straight lines.

Using the formulas for the cosecant solves a right triangle's hypotenuse.

An offset has two bends and one straight section of conduit.

Gain happens in offsets and kicks just like in nineties.

Conduit bends take completely different formulas to solve, but the correct math is too complicated to solve by hand.

Bend Aid was developed to make conduit bending faster, easier, and more accurate by using the correct mathematical formulas for the shapes that conduit is bent into.

The previous methods of bending conduit used "tricks of the trade" and mathematical formulas that are only "close enough most of the time".

The old methods of bending conduit do not provide you with all of the answers needed to see where the bends are going to be, what the shrink is going to be, what the total finished length is going to be, if you will be able to get the conduit into the bender to make the second bend for offsets, and many other details.

The old methods of bending conduit involve much guesswork, practice bending, aggravation, and unnecessary waste of time and material.

When you use Bend Aid as a tool to assist in bending conduit, you measure where you need to install the conduit, enter your dimensions into the program, and use the answers to lay out the conduit for bending.

Bend Aid will find the smallest bend angle that will fit between obstructions or supports, making wire pulling easier, reducing pull strain on conductors, and saving unnecessary fittings and the conduit nipples needed to install fittings.

Bend Aid allows you to measure and enter the finished length you need and then it finds the smallest bend angle that will fit in that length.

Bend Aid is a tool to save time and material by eliminating the guesswork that has been used to bend conduit in the past.

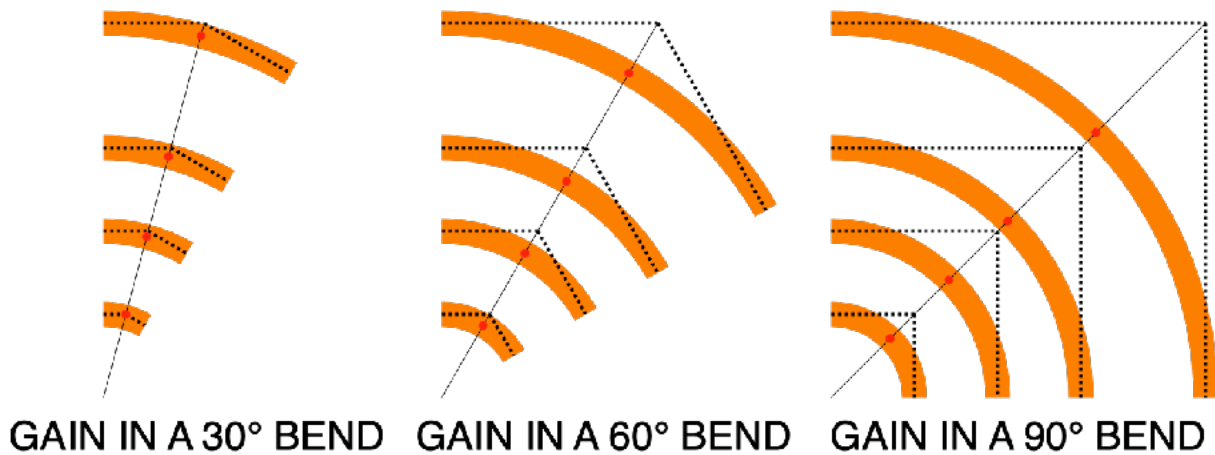

## Bend Aid Menu General Help

Bend Aid uses the correct math formulas to solve the shapes that conduit is bent into. It does not use the cosecant formulas, or any charts, tables, or correction factors.

Gain is the difference between the straight lines and the bend.

The bigger the bend radius the more the gain.

The bigger the bend angle the more the gain.

Only a small bend angle and bend radius are close to the actual center of the bends.

Bend Aid solves Offsets from the start of the first bend to the finish of the second bend, it solves the whole problem.

Finds the smallest bend angle for the variables entered.

Solves the centerline of bends so it works with any type of conduit or any size of conduit.

Gives all the answers needed to layout the conduit, and cut and thread it to length if needed.

Solves bends that were not possible before because the correct math formulas were not available.

Bend Aid uses tableviews so you tap on a row to go to the type of bend to solve or to enter the variables.

## Top Corners Of Scenes

Back

Top left corner

Tap to go back to previous scene.

Help

Top right corner

Tap to go to the help scene.

## Select Number Format

Tap a segment to select the number format.

Decimals - 0.0

If the decimal number format was selected a number pad will be displayed to enter the dimension, and then tap the Save button.

1/16 - Feet, Inches, Sixteenths

1/32 - Feet, Inches, Thirty-seconds

Metric - Meters, Centimeters, Millimeters

If a fraction or metric number format was selected a picker-view will be displayed to enter the dimension, and then tap the Save button.

Scroll each column of the picker view up or down to select, and then tap the Save button.

Angle always uses the decimal pad and the answers are always shown as decimals, but when fractions or metric is selected then the angle answer is shown to 2 decimal places.

In answer scenes selecting a different number format will convert the answer to that format.

If feet were entered in any of the variables then the answers will be displayed in feet.

Enter All

Required variables that must be entered.

Enter Any Two

Enter any two of the four variables of a right triangle.

Altitude, Offset, Kick

Length

Hypotenuse

Angle (Measured Angle, NOT Bend Angle)

Alerts



Alert boxes are displayed when any variable has not been entered or if the problem cannot be solved.

## Bottom Of Scenes

### Answers

Bottom row of enter scenes, tap to display the answers.

### Bend Aid Menu

Bottom row of answer scenes, tap to display the main menu.

## Enter Decimals

### Title Row

The name of the variable being entered.

### Number Row

The decimal number that will be entered.

### Keypad

The number keys are tapped one at a time to enter the desired number, or the decimal point.

Clear key is to reset the number back to 0.0.

Angle always uses the decimal keypad.

## Bottom Of Number Pads and PickerViews

### Save

The Save button saves the variable and returns you to the previous Enter scene.

## Enter Fractions Or Metric Picker

### Title Row

The name of the variable that will be entered.

### Number Row

The Feet, Inches, and Fraction, or Meters, Centimeters, and Millimeters that will be entered.

### PickerView

The columns are scrolled up or down one at a time to enter the desired feet, inches, and fraction, or meter, centimeter, and millimeter.

Up to 50 feet may be entered,  
44 Feet, 71 Inches, 15/16" or 31/32".

Up to 15 meters may be entered,  
14 Meters, 99 Centimeters, 9 Millimeters.

## Enter Number Of Conduit

### Number Row

The number of conduit in a rack to be solved.

### Keypad

The number keys are tapped one at a time to enter the desired number.

Clear key is to reset the number back to 0.

## Bottom Row

### Save

The Save button saves the variable and returns you to the previous Enter scene.

# Enter Right Triangle



Enter

Help

Right Triangle

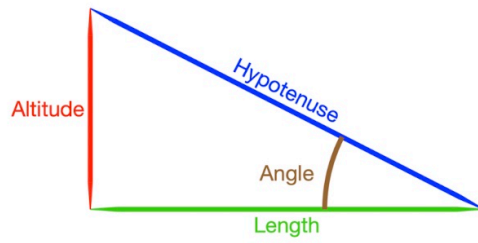

Select Number Format

Decimal

1/16

1/32

Metric

Enter Any Two

Altitude	12
Length	0.0
Hypotenuse	0.0
Angle	30

Answers

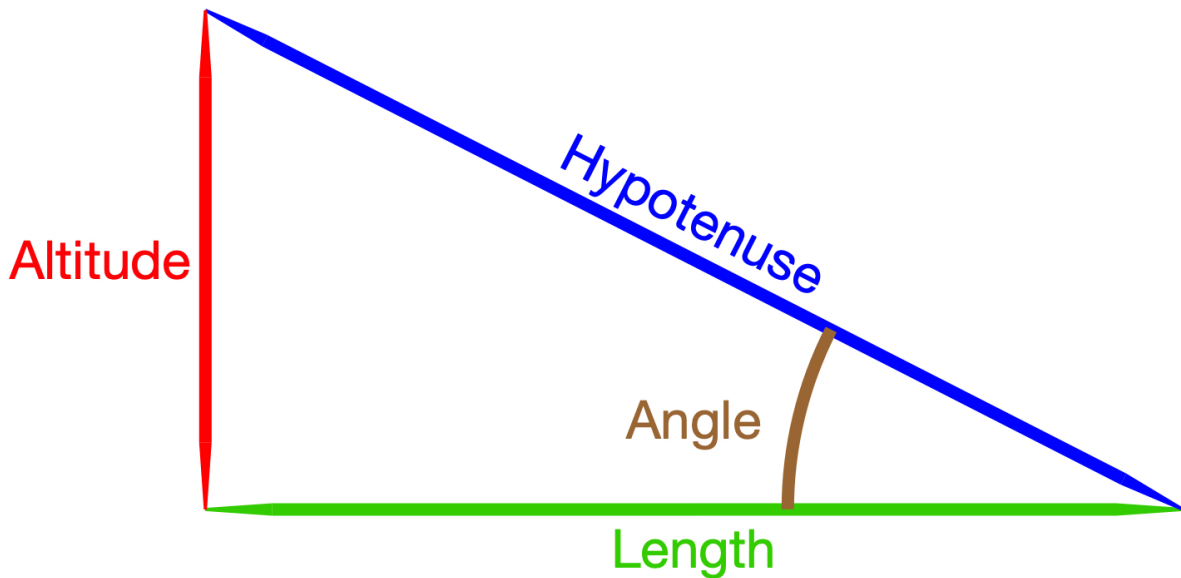

Enter Right Triangle Help

Bend Aid solves a right triangle by entering any two of the four variables and then displaying the answers.

Select Number Format

Tap a segment to select the number format.

Enter Any Two

Enter two variables and then tap Answers.

Offset

Length

Hypotenuse

Angle

Alerts

Alerts are shown after the Answers button is tapped if there is a problem with the entered variables or if the answers will not work.

Hypotenuse

Must be greater than either side.

Angle

Must be less than  $90^\circ$ .

Tap OK to dismiss an alert.

Bottom Row

Answers

Tap to show the answers view.

# Answer Right Triangle

[Back](#)

Answers

[Help](#)

## Right Triangle

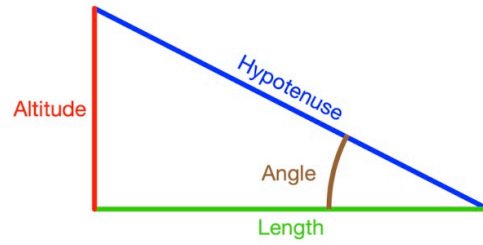

## Select Number Format

Decimal

1/16

1/32

Metric

## Answers

Altitude	12
Length	20.784609690827
Hypotenuse	24
Angle	30 °

[Bend Aid Menu](#)

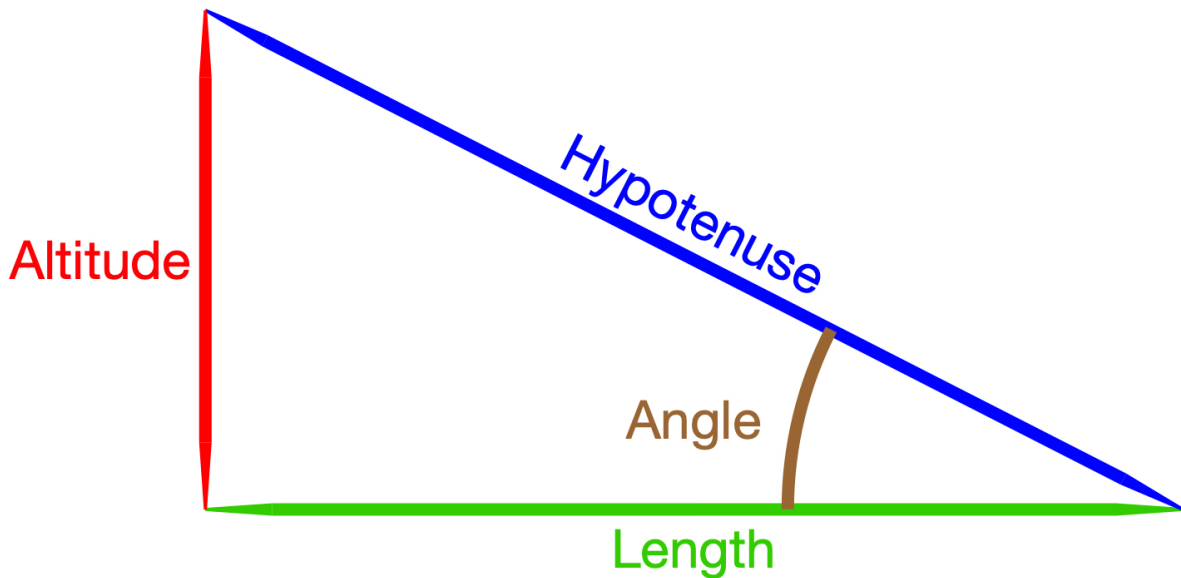

## Answer Right Triangle Help

The answers are displayed in the number format that the variables were entered in.

If feet were entered in any of the variables then the answers will be displayed with feet.

## Select Number Format

Tap a segment to change the format of the answers.

The number format may be changed at any time which allows the different formats to be converted.

## Answers

Altitude

Length

Hypotenuse

Angle







Bottom Row

Bend Aid Menu

Tap to go to the Bend Aid main menu.



# Offsets Menu

<	Offsets	Help
	Offset	
	Offset Rack	
	Offset Concentric	
	Simple Offset	
	Rolling Offset	
	Measure Offset	
	Saddles	

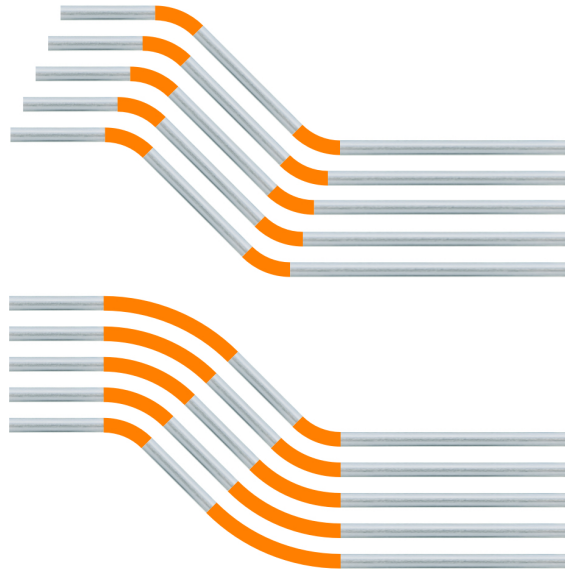

## Offsets Menu Help

Bend-Aid solves the center line of the conduit and bends.

An offset has two bends and one straight section of conduit.

There is straight conduit in front of and behind the offset.

The conduit may be leaving a box or conduit body and will be supported.

If you plan on starting the offset at the far edge of the support you can measure the distance where the offset needs to start which be entered as Start Bend.

There will be another support or obstruction where the offset needs to be finished and the measurement will be entered as the Length.

After the offset there will be a length of conduit that will either be the end of a full length or the conduit will be cut to fit and maybe threaded, which will be given as an answer called Tail.

The bends of each conduit in a rack may be bent on the same bend radius or they may be bent concentrically.

# Enter Offset

< Enter Help

Offset

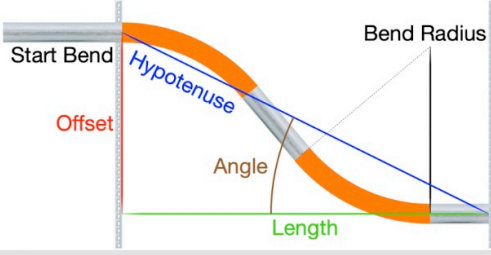

The diagram illustrates a pipe bend with an offset. A horizontal pipe on the left transitions into a curved bend, which then continues horizontally on the right. The vertical distance between the original horizontal line and the new horizontal line is labeled 'Offset' in red. The horizontal distance between the two vertical lines is labeled 'Length' in green. A blue line representing the hypotenuse connects the start and end points of the bend. The angle between the horizontal line and the hypotenuse is labeled 'Angle' in brown. The radius of the bend is labeled 'Bend Radius' in black. The 'Start Bend' is indicated at the beginning of the curve.

Select Number Format

Decimal 1/16 1/32 Metric

Enter All

Bend Radius	9
Start Bend	18

Enter Any Two

Offset	12
Length	36
Hypotenuse	0.0
Angle	0.0

Answers

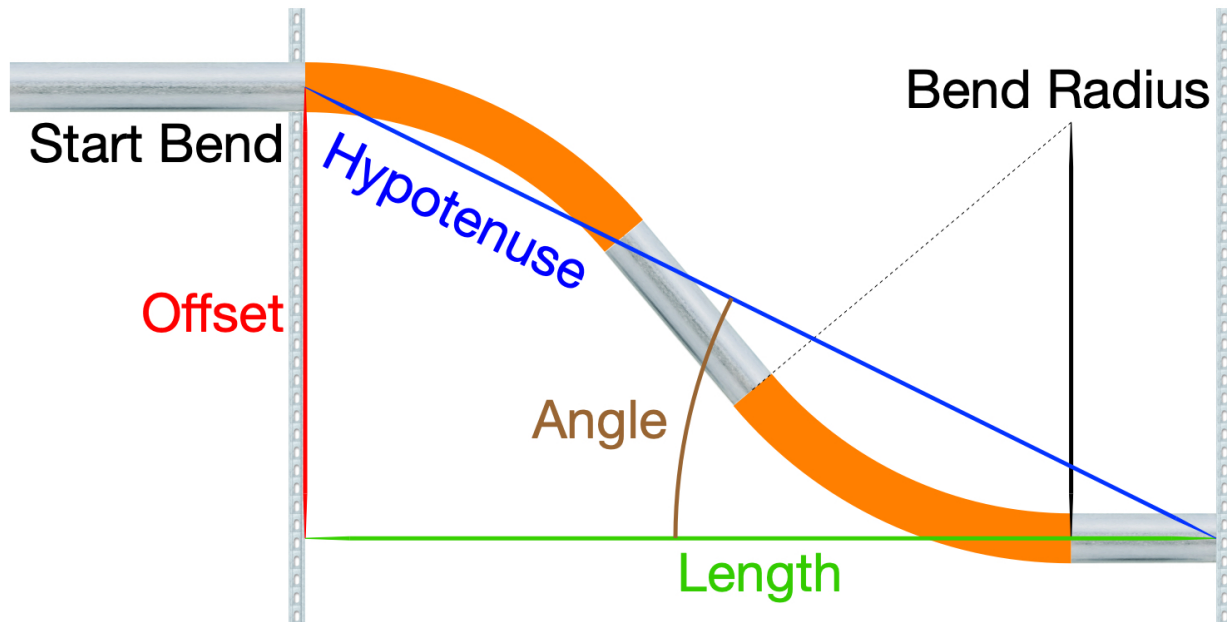

## Enter Offset Help

Bend Aid solves an offset by entering the required variables and any two of the four right triangle variables.

Measure where the offset needs to fit.

Usually you measure the offset and the length between the supports or obstructions, but any two of the four variables of the right triangle may be entered.

Bend Aid finds the smallest bend angle that will fit.

## Select Number Format

Tap a segment to select the number format.

## Enter All

### Bend Radius

The center line radius of the bends.

## Start Bend

Is where the first bend should start.

If Start Bend is not entered then that dimension will not be included in the answers.

## Enter Any Two

Offset

Length

Hypotenuse

Angle (Measured Angle, NOT Bend Angle)

## Alerts

Alerts are shown after the Answers button is tapped if there is a problem with the entered variables or if the answers will not work.

## Enter

Bend Radius

Must be entered.

## Enter Any Two

Enter two variables and then tap Answers.

Hypotenuse

Must be greater than either side.

Angle

Must be less than  $90^\circ$ .

## Answers

Bend Angle over 90°

Length may be too short for the Angle or Radius.

No Conduit Between Bends

Length may be too short for the Angle or Radius.

Tap OK to dismiss an alert.

## Bottom Row

### Answers

Tap to show the answers view.

# Answer Offset

[Back](#)
**Answers**
[Help](#)

---

**Offset**

Add Tail to Start Bend to finish offset at second support

**Select Number Format**

Decimal
  1/16
  1/32
  Metric

**Entered**

Bend Radius	9 "
Start Bend	18 "
<b>Offset</b>	<b>12 "</b>
<b>Length</b>	<b>36 "</b>
<b>Hypotenuse</b>	<b>37 <sup>15</sup>/<sub>16</sub> "</b>
<b>Angle</b>	<b>18.43 °</b>

**Answers**

Conduit Length	56 <sup>1</sup> / <sub>8</sub> "
Offset Length	34 <sup>5</sup> / <sub>8</sub> "
Tail	1 <sup>3</sup> / <sub>8</sub> "
Start To Start	33 <sup>7</sup> / <sub>16</sub> "
<b>Bend Angle</b>	<b>21 °</b>
Travel	3 <sup>5</sup> / <sub>16</sub> "

[Segments](#)  
[Bend Aid Menu](#)



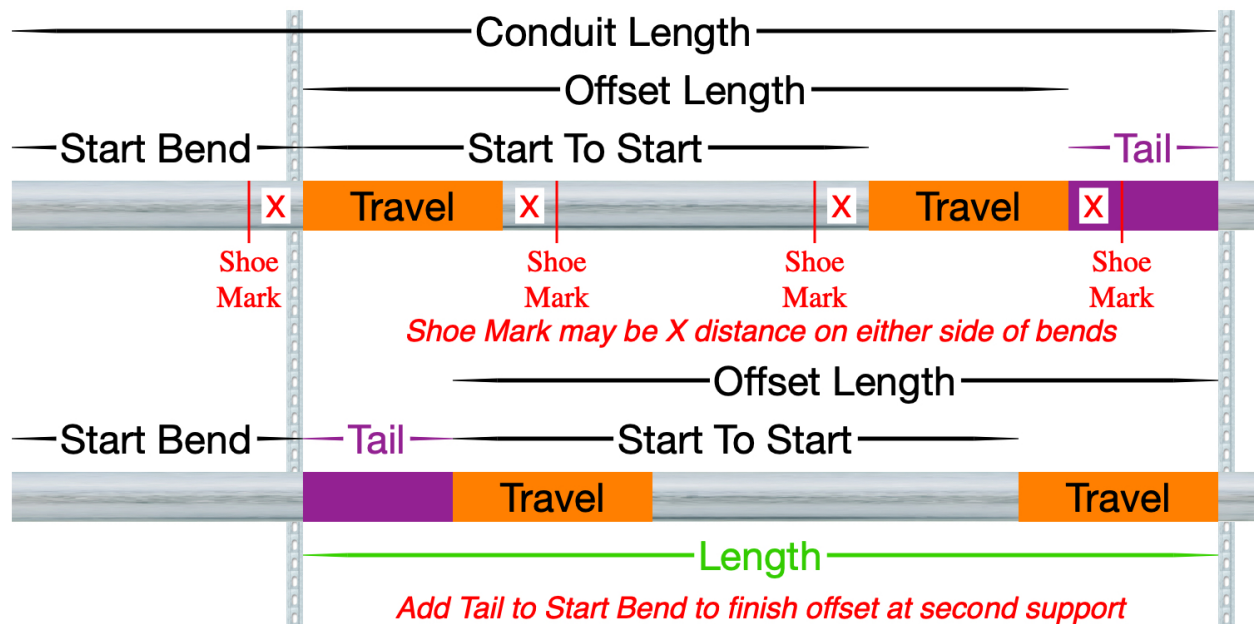

## Answer Offset Help

The answers given for an Offset allow the bends to be laid out and the conduit cut and threaded before the conduit is bent.

Mark the beginning and end of both bends so you can see exactly where they will be.

Find the center of the bend if needed for benders that bend from the middle of the bend.

## Select Number Format

Tap a segment to select the format to display the answers.

The number format may be changed at any time which allows the different formats to be converted.

Entered

The variables entered are displayed so they can be verified.

The variables of the right triangle are displayed and whichever answers were solved.

## Answers

### Conduit Length

The total length of conduit needed to make the offset including the start bend and tail.

### Offset Length

The length of the offset from the start of the first bend to the finish of the last bend.

### Tail

The length of conduit from the finish of the offset's second bend to the length that was entered.

### Start To Start

The length from the start of the first bend to the start of the second bend.

Start to start is given because the centers of concentric bends change

### Bend Angle

The angle that the bend will be.

Bend Aid finds the smallest whole bend angle that will allow the offset to fit between the supports or obstructions.

## Travel

The center line length of the arc of the bend.

## Bending An Offset

Lay out the answers dimensions on the straight conduit.

The answers are given to the second support, if you know how much farther the conduit goes then add that dimension, and cut and thread the conduit.

If you did not enter a Start Bend length then the Conduit Length is from the start of the first bend.

Shoe Marks may be put on either side of any bend and the bend may be bent from either direction, once you have charted the bender being used and know how far from the bend the Shoe Mark should be.

If a pull through bender is being used then the Travel answer may be used to measure the Bend Angle by putting the conduit in the bender and marking the Travel from the back of the roller support.

If an old "Chicago" bender is being used then the weight of the handle will allow you to check the spring-back of the bend, pull the bend up to the Travel mark, let go of the handle and see if the conduit springs back, add more bend as needed.

If an electric chain driven bender is being used the spring-back must be guessed at.

If a push through bender is being used then layout the bends and find the centers of the bends.

If the offset needs to end at the second support then add the Tail length to the Start Bend length.

## Segments

Tap to go to the enter segment bend angle view.

## Top Left of Scene

### Back

Tap to go back to the enter scene to change variables.

## Bottom Row

### Bend Aid Menu

Tap to go to the Bend Aid main menu.

# Enter Offset Rack

<
Enter
Help

---

**Offset Rack**

The diagram illustrates three conduits (labeled 1, 2, 3) that are parallel and then bend at an angle. The 'Start Bend' is marked at the beginning of the bend. The 'Offset' is the vertical distance from the original path to the new path. The 'Hypotenuse' is the length of the bend. The 'Angle' is the angle of the bend. The 'Length' is the horizontal distance of the bend. The 'Bend Radius' is the radius of the curve.

---

**Select Number Format**

Decimal
  1/16
  1/32
  Metric

---

**Enter All**

Number Of Conduit	3
Bend Radius	9
Start Bend	18
Center Spacing	4

---

**Enter Any Two**

Offset	12
Length	36
Hypotenuse	0.0
Angle	0.0

---

[Answers](#)

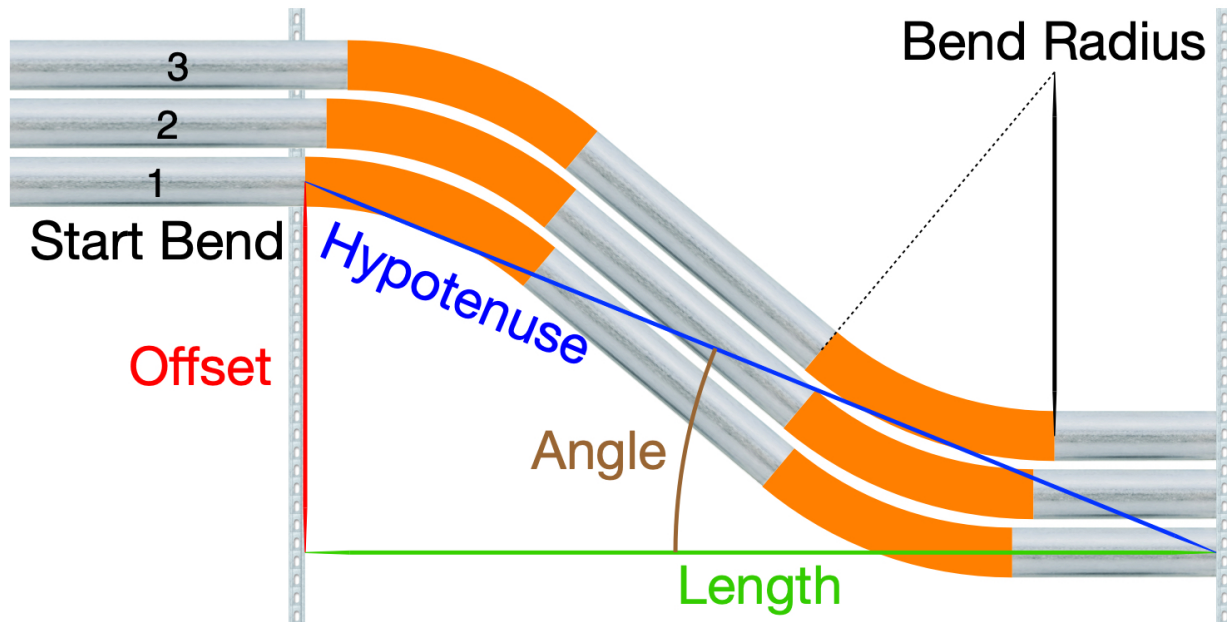

## Enter Offset Rack Help

Bend Aid solves a rack of offsets by entering the required variables and any two of the four right triangle variables.

Measure where the offset needs to fit.

Measure the right triangle for the first offset and the rest of the start bends will be solved.

Usually you measure the offset and the length between the supports or obstructions, but any two of the four variables of the right triangle may be entered.

Bend Aid finds the smallest bend angle that will fit.

## Select Number Format

Tap a segment to select the number format.

## Enter All

### Number Of Conduit

The number of conduit in the rack.

### Bend Radius

The center line radius of the bends.

### Start Bend

Is where the first bend should start.

If Start Bend is not entered then that dimension will not be included in the answers.

### Center Spacing

The center to center spacing of the conduit in the rack.

## Enter Any Two

Offset

Length

Hypotenuse

Angle (Measured Angle, NOT Bend Angle)

## Alerts

Alerts are shown after the Answers button is tapped if there is a problem with the entered variables or if the answers will not work.

Enter

Number Of Conduit

Must be entered.

Bend Radius

Must be entered.

Center Spacing

Must be entered.

Enter Any Two

Enter two variables and then tap Answers.

Hypotenuse

Must be greater than either side.

Angle

Must be less than  $90^\circ$ .

Answers

Bend Angle over  $90^\circ$

Length may be too short for the Angle or Radius.

No Conduit Between Bends

Length may be too short for the Angle or Radius.

Tap OK to dismiss an alert.

Bottom Row

Answers

Tap to show the answers view.



# Answer Offset Rack

[Back](#)

Answers

[Help](#)

## Offset Rack

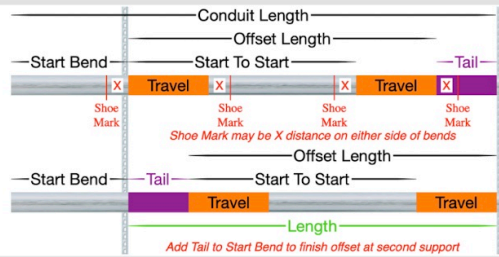

## Select Number Format

Decimal

1/16

1/32

Metric

## Entered

Number Of Conduit	3
Bend Radius	9 "
Start Bend	18 "
Center Spacing	4 "
Offset	12 "
Length	36 "
Hypotenuse	37 <sup>15</sup> / <sub>16</sub> "
Angle	18.43 °

## Answers

Conduit Number	1
Conduit Length	56 <sup>1</sup> / <sub>4</sub> "
Offset Length	33 <sup>3</sup> / <sub>16</sub> "
Tail	2 <sup>13</sup> / <sub>16</sub> "
Start Bend	18 "
Start To Start	32 "
Bend Angle	22 °
Travel	3 <sup>7</sup> / <sub>16</sub> "

[Previous](#)

[Next](#)

[Segments](#)

[Bend Aid Menu](#)

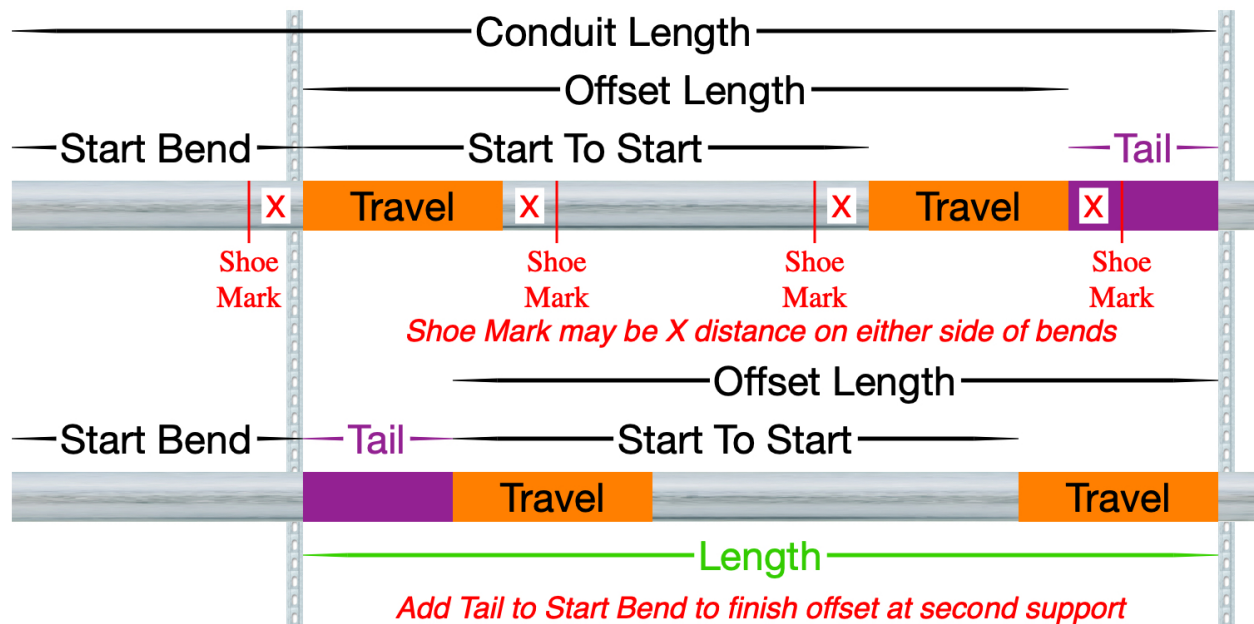

## Answer Offset Rack Help

The answers given for an Offset Rack allow the bends to be laid out and the conduit cut and threaded before the conduit is bent.

Mark the beginning and end of both bends so you can see exactly where they will be.

Find the center of the bend if needed for benders that bend from the middle of the bend.

As you go through the rack each conduit number may have different answers like the Start Bend will increase so the center to center spacing will stay the same.

## Select Number Format

Tap a segment to select the format to display the answers.

The number format may be changed at any time which allows the different formats to be converted.

## Enter

The variables entered are displayed so they can be verified.

The variables of the right triangle are displayed and whichever answers were solved.

## Answers

### Conduit Number

The number of the conduit in the rack that the answers are being displayed for.

The Next and Previous buttons will step you through each set of answers.

### Conduit Length

The total length of conduit needed to make the offset including the start bend and tail.

### Offset Length

The length of the offset from the start of the first bend to the finish of the last bend.

### Tail

The length of conduit from the finish of the offset's second bend to the length that was entered.

### Start Bend

Where the first bend will start for each of the conduit in the rack.

### Start To Start

The length from the start of the first bend to the start of the second bend.

Start to start is given because the centers of concentric bends change

### Bend Angle

The angle that the bend will be.

Bend Aid finds the smallest whole bend angle that will allow the offset to fit between the supports or obstructions.

### Travel

The center line length of the arc of the bend.

## Bending A Rack Of Offsets

Lay out the answers dimensions on the straight conduit for each conduit.

The answers are given to the second support, if you know how much farther the conduit goes then add that dimension, and cut and thread the conduit.

If you did not enter a Start Bend length then the Conduit Length is from the start of the first bend.

Shoe Marks may be put on either side of any bend and the bend may be bent from either direction, once you have charted the bender being used and know how far from the bend the Shoe Mark should be.

If a pull through bender is being used then the Travel answer may be used to measure the Bend Angle by putting the conduit in the bender and marking the Travel from the back of the roller support.

If an old “Chicago” bender is being used then the weight of the handle will allow you to check the spring-back of the bend, pull the bend up to the Travel mark, let go of the handle and see if the conduit springs back, add more bend as needed.

If an electric chain driven bender is being used the spring-back must be a guess.

If a push through bender is being used layout the bends and find the centers of the bends.

If the offset needs to end at the second support then add the Tail length to the Start Bend length.

## Segments

Tap to go to the enter segment bend angle view.

Top Left of Scene

Back

Tap to go back to the enter scene to change variables.

Bottom Row

Bend Aid Menu

Tap to go to the Bend Aid main menu..

# Enter Offset Concentric

<
Enter
Help

---

**Offset Concentric**

---

**Select Number Format**

---

**Enter All**

Number Of Conduit	3
Bend Radius	9
Start Bend	18
Center Spacing	4

---

**Enter Any Two**

Offset	12
Length	36
Hypotenuse	0.0
Angle	0.0

---

[Answers](#)

---

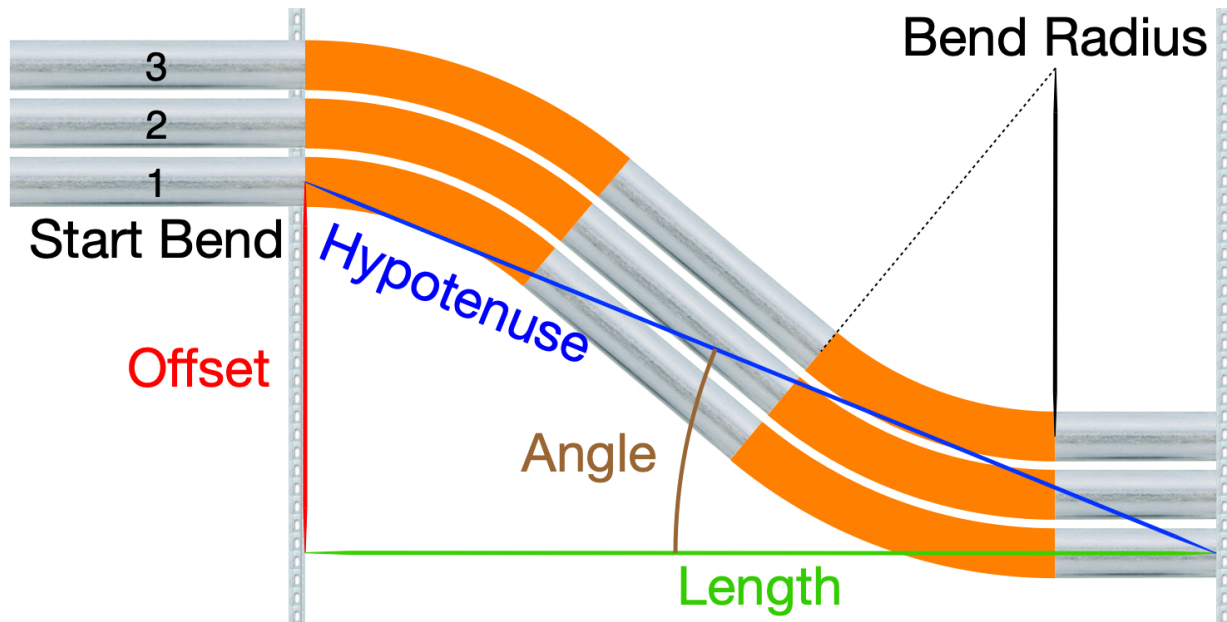

## Enter Offset Concentric Help

Bend Aid solves a rack of concentric offsets by entering the required variables and any two of the four right triangle variables.

Measure where the offset needs to fit.

Measure the right triangle for the first offset and the rest of the bend radii will be solved.

Usually you measure the offset and the length between the supports or obstructions, but any two of the four variables of the right triangle may be entered.

Bend Aid finds the smallest bend angle that will fit.

## Select Number Format

Tap a segment to select the number format.



## Enter All

### Number Of Conduit

The number of conduit in the rack.

### Bend Radius

The smallest center line radius of the bends.

Each bend radius will be solved and all bends will be bent using segments unless the smallest bend radius is a standard bending shoe radius.

### Start Bend

Is where the bends should start.

If Start Bend is not entered then that dimension will not be included in the answers.

### Center Spacing

The center to center spacing of the conduit in the rack.

## Enter Any Two

Offset

Length

Hypotenuse

Angle (Measured Angle, NOT Bend Angle)

## Alerts

Alerts are shown after the Answers button is tapped if there is a problem with the entered variables or if the answers will not work.

Enter

Number Of Conduit  
Must be entered.

Bend Radius  
Must be entered.

Center Spacing  
Must be entered.

Enter Any Two  
Enter two variables and then tap Answers.

Hypotenuse  
Must be greater than either side.

Angle  
Must be less than  $90^\circ$ .

Answers

Bend Angle over  $90^\circ$   
Length may be too short for the Angle or Radius.

No Conduit Between Bends  
Length may be too short for the Angle or Radius.

Tap OK to dismiss an alert.

Bottom Row

Answers

Tap to show the answers view.

# Answer Offset Concentric

[Back](#)
**Answers**
[Help](#)

---

**Offset Concentric**

**Select Number Format**

Decimal
  1/16
  1/32
  Metric

**Entered**

Number Of Conduit	3
Bend Radius	9 "
Start Bend	18 "
Center Spacing	4 "
<b>Offset</b>	<b>12 "</b>
<b>Length</b>	<b>36 "</b>
<b>Hypotenuse</b>	<b>37 <sup>15</sup>/<sub>16</sub> "</b>
<b>Angle</b>	<b>18.43 °</b>

**Answers**

<b>Conduit Number</b>	<b>1</b>
Conduit Length	56 <sup>3</sup> / <sub>16</sub> "
Offset Length	34 <sup>3</sup> / <sub>4</sub> "
Tail	1 <sup>1</sup> / <sub>4</sub> "
<b>Bend Angle</b>	<b>22 °</b>
<b>Bend Radius One</b>	<b>9 "</b>
<b>Travel One</b>	<b>3 <sup>7</sup>/<sub>16</sub> "</b>
<b>Start To Start</b>	<b>30 <sup>7</sup>/<sub>16</sub> "</b>
<b>Bend Radius Two</b>	<b>17 "</b>
<b>Travel Two</b>	<b>6 <sup>1</sup>/<sub>2</sub> "</b>

[Previous](#)
[Next](#)

[Segments Travel One](#)  
[Segments Travel Two](#)  
[Bend Aid Menu](#)

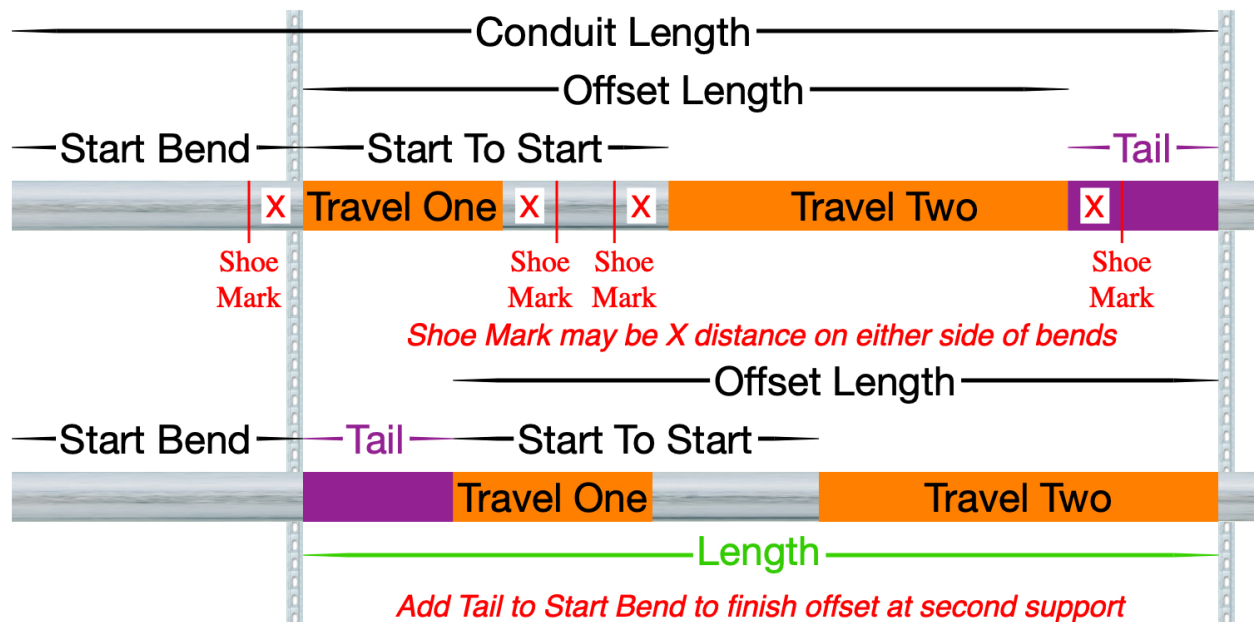

## Answer Offset Concentric Help

The answers given for an Offset Concentric Rack allow the bends to be laid out and the conduit cut and threaded before the conduit is bent.

Mark the beginning and end of both bends so you can see exactly where they will be.

Find the center of the bend if needed for benders that bend from the middle of the bend.

As you go through the rack each conduit number may have different answers like the Bend Radius and the Travel will increase.

## Select Number Format

Tap a segment to select the format to display the answers.

The number format may be changed at any time which allows the different formats to be converted.

## Entered

The variables entered are displayed so they can be verified.

The variables of the right triangle are displayed and whichever answers were solved.

## Answers

### Conduit Number

The number of the conduit in the rack that the answers are being displayed for.

The Next and Previous buttons will step you through each set of answers.

The Segments Travel One and Segments Travel Two buttons will take you to the enter segments view.

### Conduit Length

The total length of conduit needed to make the offset including the start bend and tail.

### Offset Length

The length of the offset from the start of the first bend to the finish of the last bend

### Tail

The length of conduit from the finish of the offset's second bend to the length that was entered.

### Start Bend

Where the first bend will start for each of the conduit in the rack.

### Start To Start

The length from the start of the first bend to the start of the second bend.

Start to start is given because the centers of concentric bends change

### Bend Angle

The angle that the bend will be.

Bend Aid finds the smallest whole bend angle that will allow the offset to fit between the supports or obstructions.

### Travel

The center line length of the arc of the bend.

### Bending A Rack Of Offsets

Lay out the dimensions on the straight conduit for each conduit.

The answers are given to the second support, if you know how much farther the conduit goes then add that dimension, and cut and thread the conduit.

If you did not enter a Start Bend length then the Conduit Length is from the start of the first bend.

Shoe Marks may be put on either side of any bend and the bend may be bent from either direction, once you have charted the bender being used and know how far from the bend the Shoe Mark should be.

If a pull through bender is being used then the Travel answer may be used to measure the Bend Angle by putting the conduit in the bender and marking the Travel from the back of the roller support.

If an old “Chicago” bender is being used then the weight of the handle will allow you to check the spring-back of the bend, pull the bend up to the Travel mark, let go of the handle and see if the conduit springs back, add more bend as needed.

If an electric chain driven bender is being used the spring-back must be a guess.

If a push through bender is being used then lay out the bends and find the centers of the bends.

If the offset needs to end at the second support, then add the Tail length to the Start Bend length.

## Segments

Tap to go to the enter segment bend angle view.



Top Left of Scene

Back

Tap to go back to the enter scene to change variables.

Bottom Row

Bend Aid Menu

Tap to go to the Bend Aid main menu.

# Enter Simple Offset

< Enter Help

Simple Offset

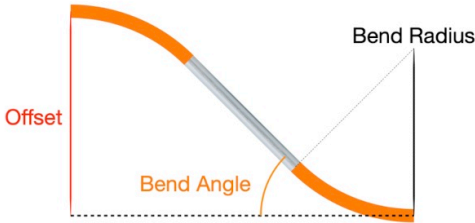

Select Number Format

Decimal 1/16 1/32 Metric

Enter All

Bend Radius	9
Bend Angle	30
Offset	12

[Answers](#)

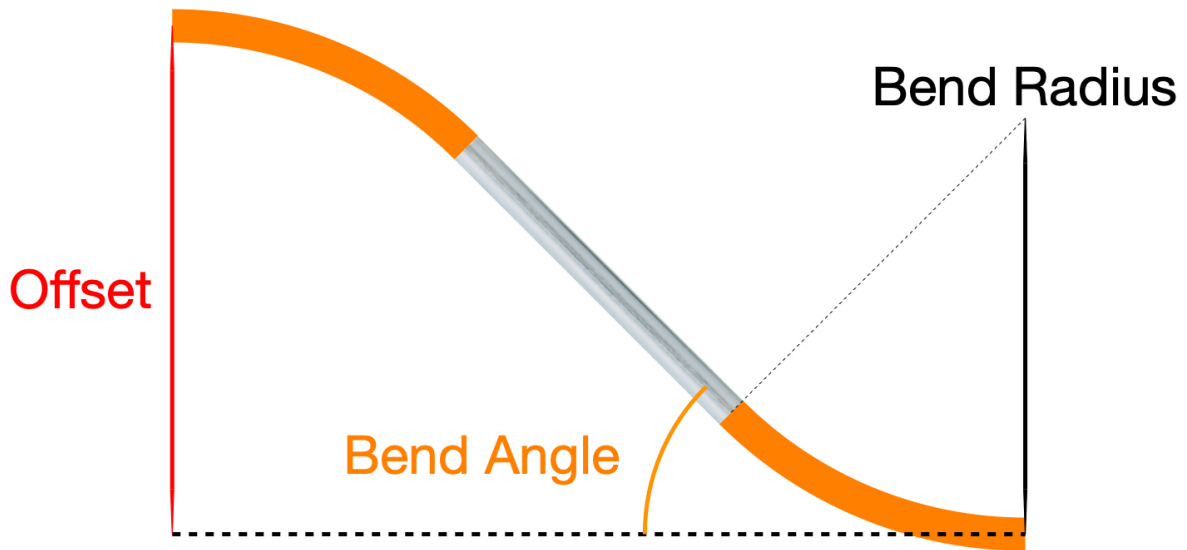

## Enter Simple Offset Help

Bend Aid solves for a simple offset by entering the required variables.

### Select Number Format

Tap a segment to select the number format.

### Enter All

#### Bend Radius

The center line radius of the bends.

#### Bend Angle

The bend angle to be used.

#### Offset

The offset.

### Alerts

Alerts are shown after the Answers button is tapped if there is a problem with the entered variables or if the answers will not work.

Enter

Bend Radius

Must be entered.

Bend Angle

Must be less than 90°.

Offset

Must be entered.

Answers

Bend Angle over 90°

Length may be too short for the Angle or Radius.

No Conduit Between Bends

Length may be too short for the Angle or Radius.

Tap OK to dismiss an alert.

Bottom Row

Answers

Tap to show the answers view.

Segments

Tap to go to the enter segment bend angle view.

Top Left of Scene

Back

Tap to go back to the enter scene to change variables.

Bottom Row

Bend Aid Menu

Tap to go to the Bend Aid main menu.

# Answer Simple Offset

Back
Answers
Help

---

**Simple Offset**

**Select Number Format**

Decimal
1/16
1/32
Metric

**Entered**

Bend Radius	9 "
Bend Angle	30 °
Offset	12 "

**Answers**

Conduit Length	28 <sup>5</sup> / <sub>8</sub> "
Offset Length	25 <sup>5</sup> / <sub>8</sub> "
Shrink	3 "
Start To Start	23 <sup>7</sup> / <sub>8</sub> "
Travel	4 <sup>11</sup> / <sub>16</sub> "

[Segments](#)

[Bend Aid Menu](#)

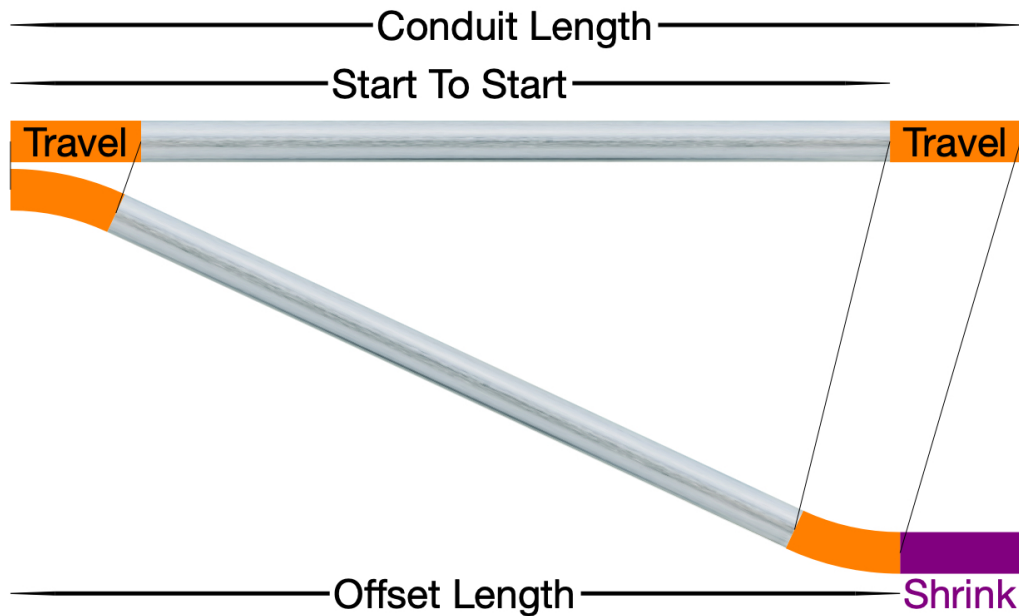

## Answer Simple Offset Help

The answers given for a Simple Offset allow the bends to be laid out before the conduit is bent.

Mark the beginning and end of both bends so you can see exactly where they will be.

Find the center of the bend if needed for benders that bend from the middle of the bend.

## Select Number Format

Tap a segment to select the format to display the answers.

The number format may be changed at any time which allows the different formats to be converted.

## Entered

The variables entered are displayed so they can be verified.

## Answers

### Conduit Length

The length of conduit needed to make the offset.

### Offset Length

The length of the offset from the start of the first bend to the finish of the last bend

### Shrink

The difference between the conduit length and the offset length after the offset is bent.

### Start To Start

The length from the start of the first bend to the start of the second bend.

Start to start is given because the centers of concentric bends change

### Bend Angle

The angle that the bend will be.

Bend Aid finds the smallest whole bend angle that will allow the offset to fit between the supports or obstructions.

### Travel

The center line length of the arc of the bend.

## Bending An Offset



Lay out the dimensions on the straight conduit.

Shoe Marks may be put on either side of any bend and the bend may be bent from either direction, once you have charted the bender being used and know how far from the bend the Shoe Mark should be.

If a pull through bender is being used then the Travel answer may be used to measure the Bend Angle by putting the conduit in the bender and marking the Travel from the back of the roller support.

If an old “Chicago” bender is being used then the weight of the handle will allow you to check the spring-back of the bend, pull the bend up to the Travel mark, let go of the handle and see if the conduit springs back, add more bend as needed.

If an electric chain driven bender is being used the spring-back must be guessed a guess.

If a push through bender is being used layout the bends and find the centers of the bends.

If the offset needs to end at the second support, then add the Tail length to the Start Bend length.

## Segments

Tap to go to the enter segment bend angle view.

## Top Left of Scene

Back

Tap to go back to the enter scene to change variables.

Bottom Row

Bend Aid Menu

Tap to go to the Bend Aid main menu.

## Rolling Offset

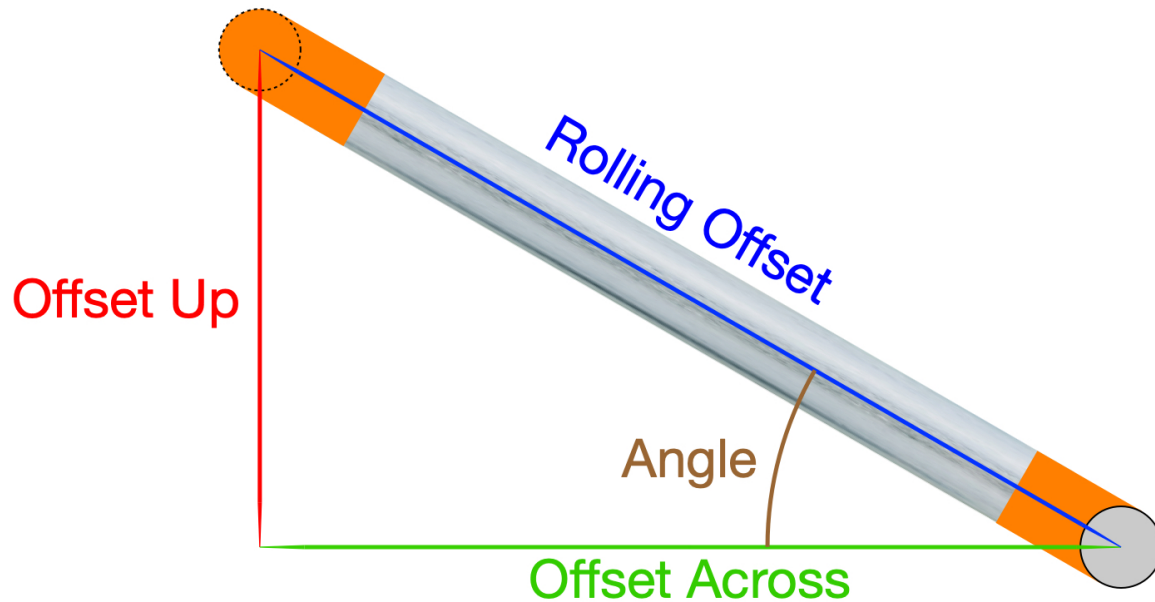

Use Right Triangle to solve a rolling offset.

Hypotenuse is the rolling offset.

Altitude is how far up the offset is.

Length is how far over the offset is.

Angle is the angle that the offset will roll over.

Use Offset or Simple Offset to solve the rolling offset.

## Measure Offset

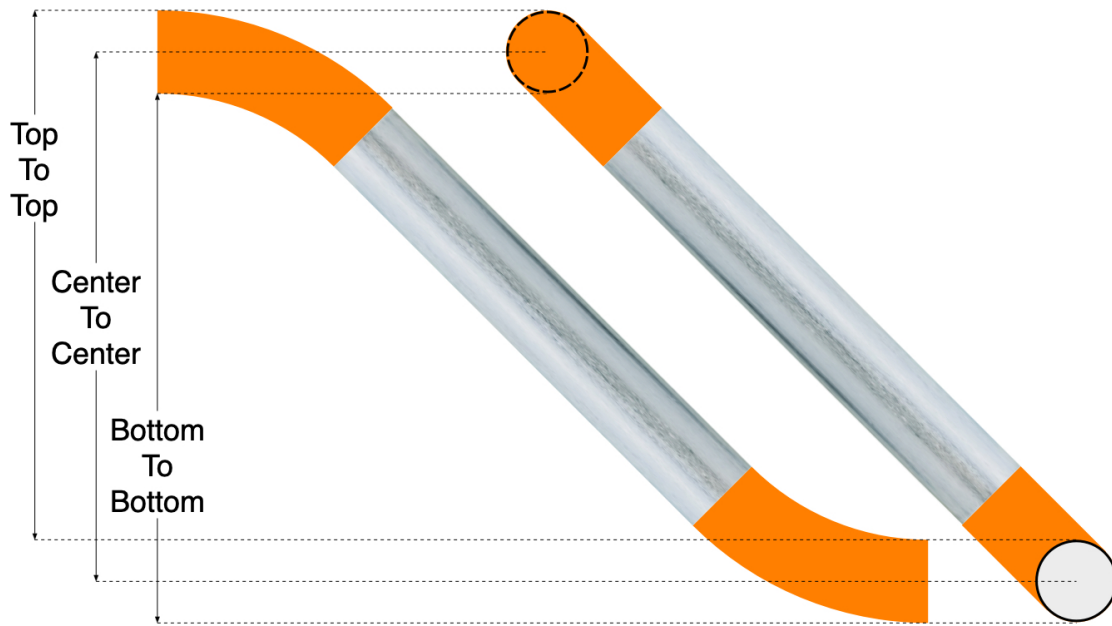

Bend Aid always solves the center line of the conduit.

An offset can be measured

Top To Top







Center to Center

Bottom To Bottom

These measurements are all the same.

It is possible to measure Top To Bottom if you allow for the outside diameter ( OD ) of the conduit.

# Saddles Menu

<	Saddles
	3 Point
	3 Point Rack
	3 Point Concentric
	4 Point
	4 Point Rack
	4 Point Concentric

## 3 Point Saddle

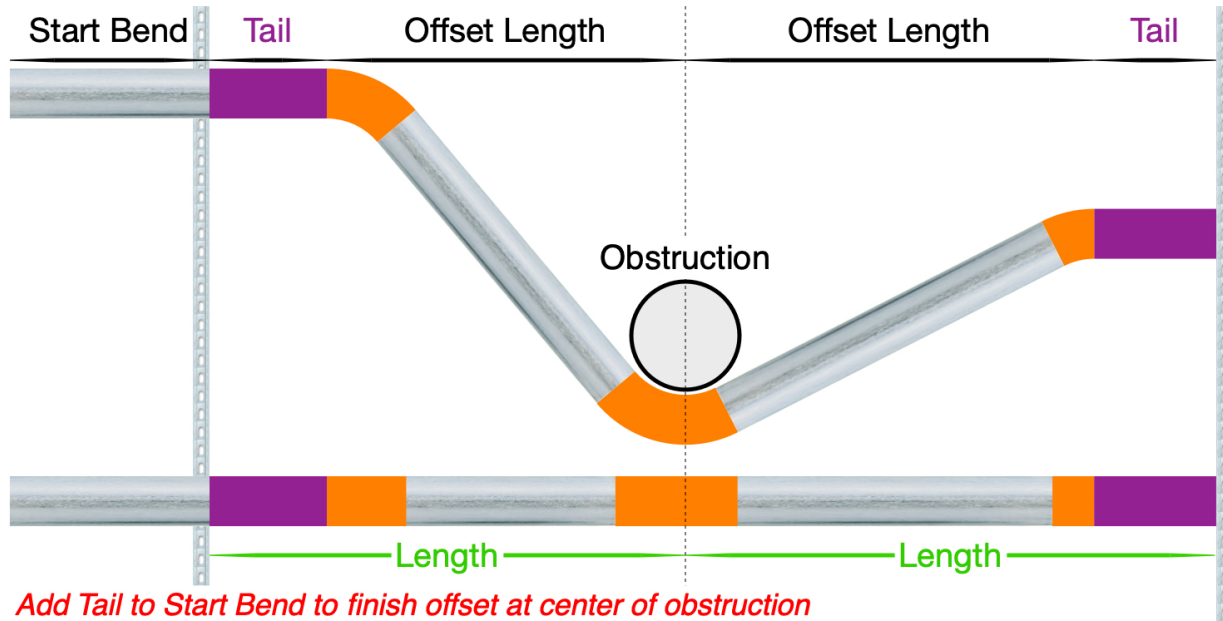

Bend Aid does not solve saddles directly, use the other solutions and lay out two offsets on one section of conduit.

A saddle is two offsets, ie. four bends.

A 3 point saddle has no straight conduit between the second and third bends.

The offsets may be different offsets, radii, or angles.

Lay out the first offset to finish at the obstruction by adding the tail of the first offset to the start of the first bend.

Add the second bend to the third bend to bend them as one bend.

## 4 Point Saddle

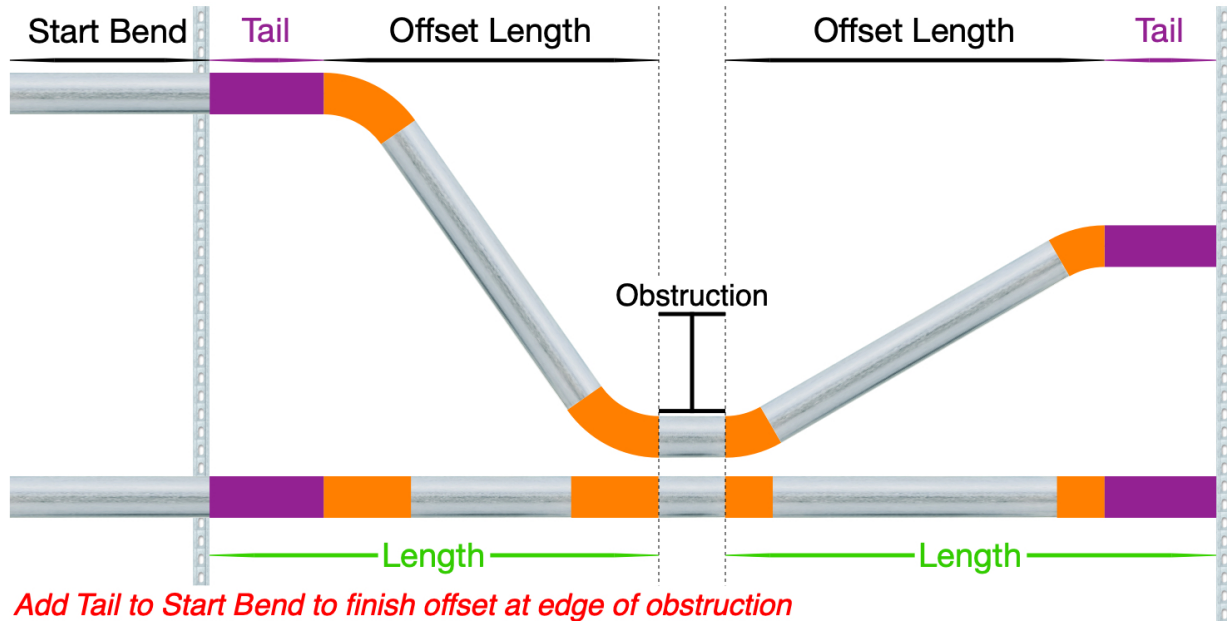

Bend Aid does not solve saddles directly, use the other solutions and layout two offsets on one section of conduit.



A 4 point saddle is two offsets with some straight conduit between the second and third bends.

The offsets may be different offsets, radius, or angles.

Lay out the first offset to finish at the obstruction by adding the tail to the start of the first bend.

Add the width of the obstruction so that it is between the two offsets, and then lay out the second offset.

# Kicks Menu

4:08 ...  

[← Bend Aid](#) **Kicks** [Help](#)

---

 Kick

---

 Kick Rack

---

 Kick Concentric

---

 Simple Kick

---

 Rack To Horizontal

---

 Concentric To Horizontal

---

 Rack To Vertical

---

 Concentric To Vertical

---



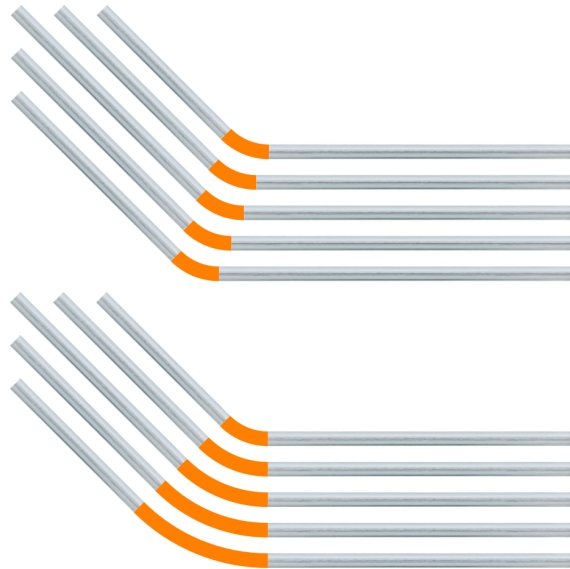

## Kicks Menu Help

Bend-Aid solves the center line of the conduit and bends.

A kick has one bend that changes the direction of the conduit.

There is straight conduit in front of and behind the kick.

After the kick there will be a length of conduit that will either be the end of a full length or the conduit will be cut to fit and maybe threaded, which will be given as an answer called Tail.

The bends of each conduit in a rack may be bent on the same bend radius or they may be bent concentrically.

# Enter Kick

< Enter Help

Kick

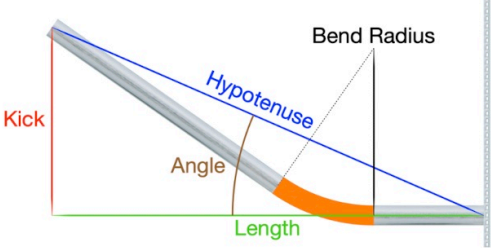

Select Number Format

Decimal 1/16 1/32 Metric

Enter All

Bend Radius 9

Enter Any Two

Kick 12

Length 36

Hypotenuse 0.0

Angle 0.0

Answers

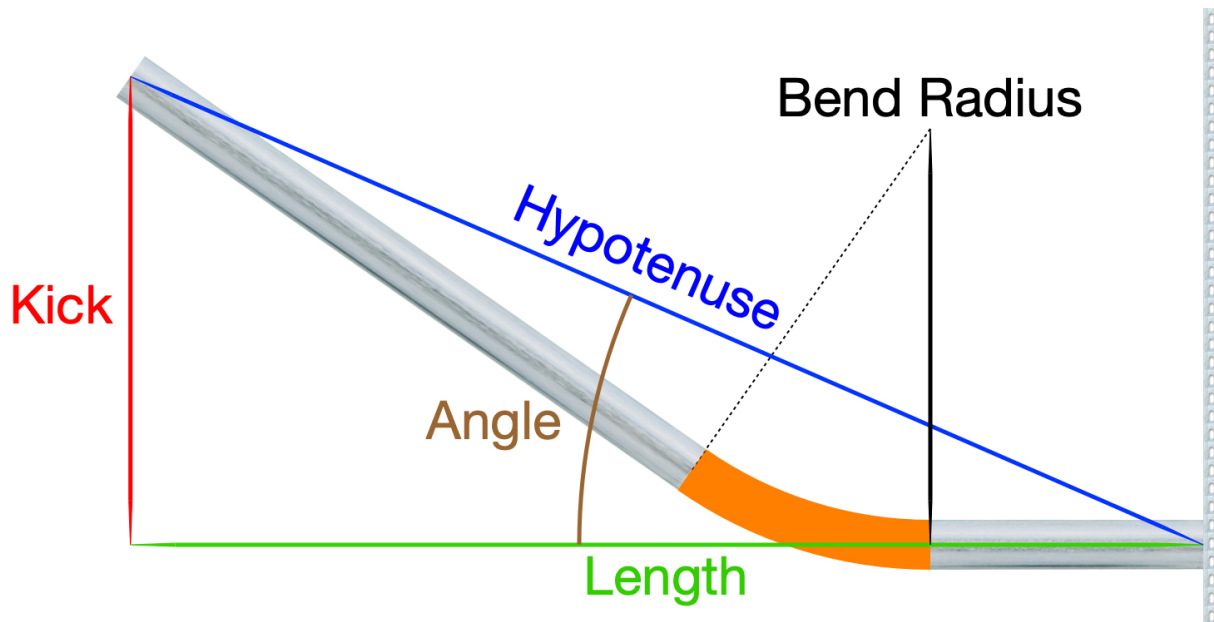

## Enter Kick Help

Bend Aid solves a kick by entering the required variables and any two of the four right triangle variables.

Measure where the kick needs to fit.

Usually you measure the kick and the length between the supports or obstructions, but any two of the four variables of the right triangle may be entered.

Bend Aid finds the smallest bend angle that will fit.

## Select Number Format

Tap a segment to select the number format.

## Enter All

### Bend Radius

The center line radius of the bends.

Enter Any Two

Kick

Length

Hypotenuse

Angle (Measured Angle, NOT Bend Angle)

Alerts

Alerts are shown after the Answers button is tapped if there is a problem with the entered variables or if the answers will not work.

Enter

Bend Radius

Must be entered.

Enter Any Two

Enter two variables and then tap Answers.

Hypotenuse

Must be greater than either side.

Angle

Must be less than  $90^\circ$ .

Answers

Bend Angle over  $90^\circ$

Length may be too short for the Angle or Radius.

Tap OK to dismiss an alert.

Bottom Row

Answers

Tap to show the answers view.

# Answer Kick

Back
Answers
Help

---

Kick

Shoe Mark may be X distance on either side of bends

Select Number Format

Decimal
1/16
1/32
Metric

Entered

Bend Radius	9"
Kick	12"
Length	36"
Hypotenuse	37 <sup>15</sup> / <sub>16</sub> "
Angle	18.43°

Answers

Conduit Length	38 <sup>1</sup> / <sub>16</sub> "
Kick Length	34 <sup>9</sup> / <sub>16</sub> "
Tail	1 <sup>7</sup> / <sub>16</sub> "
Start Bend	33 <sup>1</sup> / <sub>2</sub> "
Bend Angle	20°
Travel	3 <sup>1</sup> / <sub>8</sub> "

[Segments](#)

[Bend Aid Menu](#)

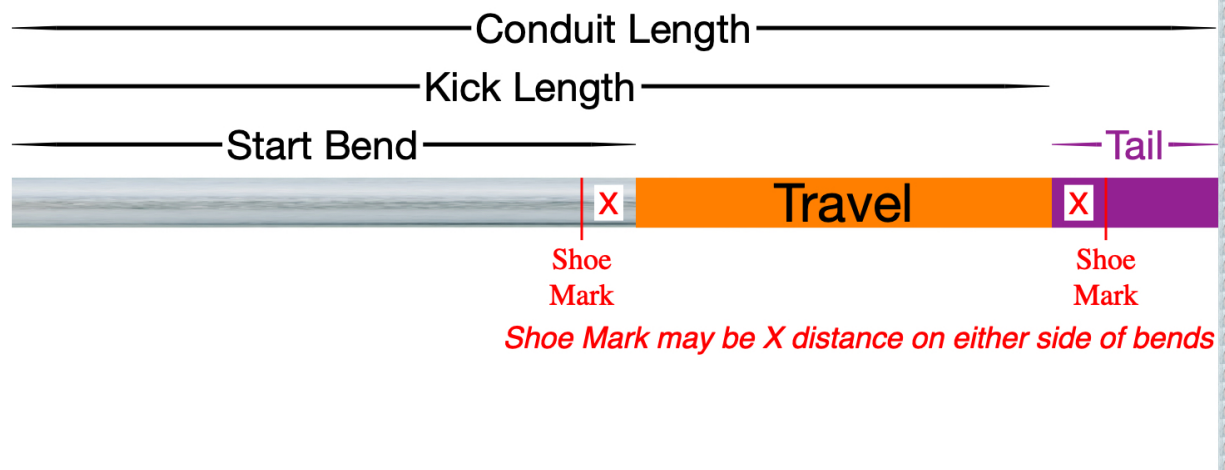

## Answer Kick Help

The answers given for a kick allow the bend to be laid out and the conduit cut and threaded before the conduit is bent.

Mark the beginning and end of the bend so you can see exactly where the bend will be.

Find the center of the bend if needed for benders that bend from the middle of the bend.

## Select Number Format

Tap a segment to select the format to display the answers.

The number format may be changed at any time which allows the different formats to be converted.

## Entered

The variables entered are displayed so they can be verified.

The variables of the right triangle are displayed and whichever answers were solved.

## Answers

### Conduit Length

The total length of conduit needed to make the kick including the start bend and tail.

### Kick Length

The length of the kick to the finish of the bend.

### Tail

The length of conduit from the finish of the kick's bend to the length that was entered.

### Start Bend

The length from the end of the conduit to the start of the bend.

### Bend Angle

The angle of the bend.

Bend Aid finds the smallest whole bend angle that will allow the kick to fit between the supports or obstructions.

### Travel

The center line length of the arc of the bend.

## Bending A Kick



Lay out the dimensions on the straight conduit.

Shoe Marks may be put on either side of any bend and the bend may be bent from either direction, once you have charted the bender being used and know how far from the bend the Shoe Mark should be.

If a pull through bender is being used then the Travel answer may be used to measure the Bend Angle by putting the conduit in the bender and marking the Travel from the back of the roller support.

If an old “Chicago” bender is being used then the weight of the handle will allow you to check the spring-back of the bend, pull the bend up to the Travel mark, let go of the handle and see if the conduit springs back, add more bend as needed.

If an electric chain driven bender is being used the spring-back must be a guess.

If a push through bender is being used then lay out the bends and find the centers of the bends.

Segments

Tap to go to the enter segment bend angle view.

Top Left of Scene

Back

Tap to go back to the enter scene to change variables.

Bottom Row

Bend Aid Menu

Tap to go to the Bend Aid main menu.

# Enter Kick Rack

< Enter Help

Kick Rack

Select Number Format

Decimal 1/16 1/32 Metric

Enter All

Number Of Conduit	3
Bend Radius	9
Center Spacing	4

Enter Any Two

Kick	12
Length	36
Hypotenuse	0.0
Angle	0.0

Answers

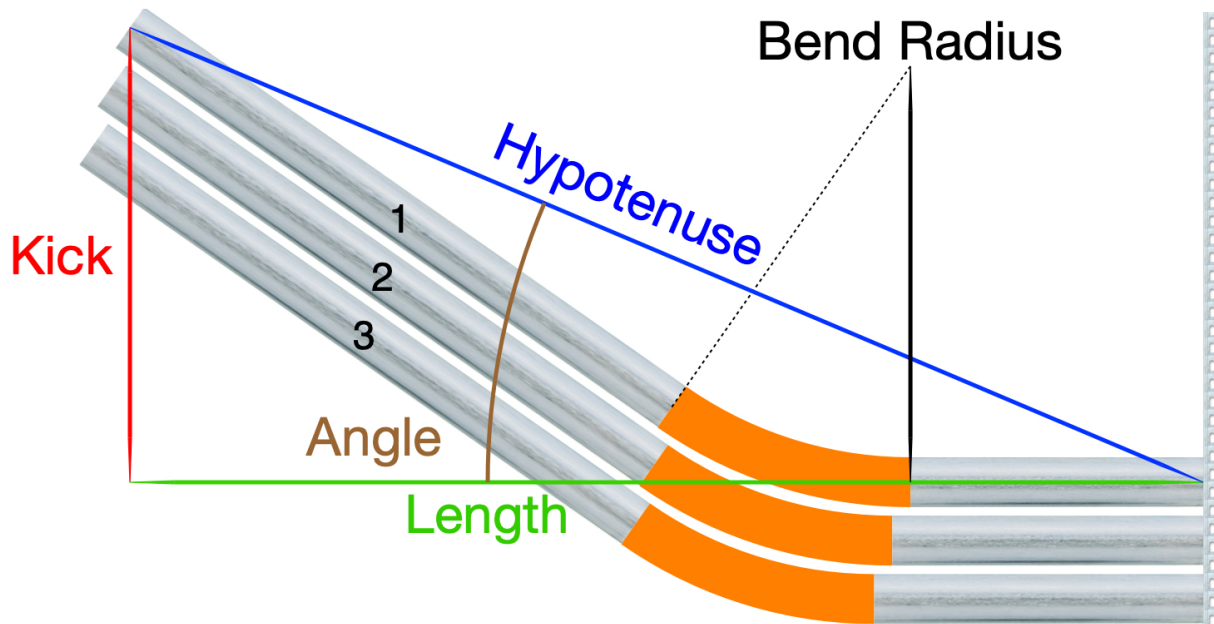

## Enter Kick Rack Help

Bend Aid solves a rack of kicks by entering the required variables and any two of the four right triangle variables.

Measure where the kick needs to fit.

Measure the right triangle for the first kick and the rest of the start bends will be solved.

Usually you measure the kick and the length between the supports or obstructions, but any two of the four variables of the right triangle may be entered.

Bend Aid finds the smallest bend angle that will fit.

## Select Number Format

Tap a segment to select the number format.

Enter All

Bend Radius

The center line radius of the bends.

Enter Any Two

Kick

Length

Hypotenuse

Angle (Measured Angle, NOT Bend Angle)

Alerts

Alerts are shown after the Answers button is tapped if there is a problem with the entered variables or if the answers will not work.

Enter

Number Of Conduit

Must be entered.

Bend Radius

Must be entered.

Center Spacing

Must be entered.

Enter Any Two

Enter two variables and then tap Answers.

Hypotenuse

Must be greater than either side.

Angle

Must be less than  $90^\circ$ .

Answers

Bend Angle over  $90^\circ$

Length may be too short for the Angle or Radius.

Tap OK to dismiss an alert.

Bottom Row

Answers

Tap to show the answers view.

# Answer Kick Rack

[Back](#)
**Answers**
[Help](#)

---

**Kick Rack**

Shoe Mark may be X distance on either side of bends

**Select Number Format**

Decimal
  1/16
  1/32
  Metric

**Entered**

Number Of Conduit	3
Bend Radius	9 "
Center Spacing	4 "
<b>Kick</b>	<b>12 "</b>
<b>Length</b>	<b>36 "</b>
<b>Hypotenuse</b>	<b>37 <sup>15</sup>/<sub>16</sub> "</b>
<b>Angle</b>	<b>18.43 °</b>

**Answers**

<b>Conduit Number</b>	<b>1</b>
<b>Conduit Length</b>	<b>38 <sup>1</sup>/<sub>16</sub> "</b>
<b>Kick Length</b>	<b>34 <sup>9</sup>/<sub>16</sub> "</b>
<b>Tail</b>	<b>1 <sup>7</sup>/<sub>16</sub> "</b>
<b>Start Bend</b>	<b>33 <sup>1</sup>/<sub>2</sub> "</b>
<b>Bend Angle</b>	<b>20 °</b>
<b>Travel</b>	<b>3 <sup>1</sup>/<sub>8</sub> "</b>

[Previous](#)
[Next](#)

[Segments](#)

[Bend Aid Menu](#)

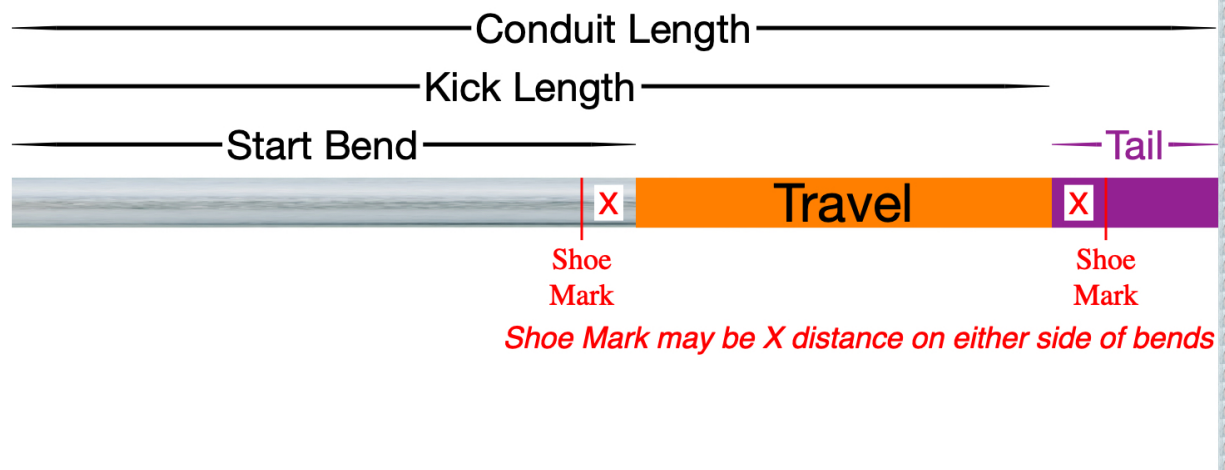

## Answer Kick Rack Help

The answers given for a rack of kicks allow the bend to be laid out and the conduit cut and threaded before the conduit is bent.

Mark the beginning and end of the bend so you can see exactly where the bend will be.

Find the center of the bend if needed for benders that bend from the middle of the bend.

## Select Number Format

Tap a segment to select the format to display the answers.

The number format may be changed at any time which allows the different formats to be converted.

Entered



The variables entered are displayed so they can be verified.

The variables of the right triangle are displayed and whichever answers were solved.

## Answers

### Conduit Number

The number of the conduit in the rack that the answers are being shown for.

### Conduit Length

The total length of conduit needed to make the kick including the start bend and tail.

### Kick

The new kick from the rack to the row.

### Kick Length

The length of the kick to the finish of the bend.

### Tail

The length of conduit from the finish of the kick's bend to the length that was entered.

### Start Bend

The length from the end of the conduit to the start of the bend.

### Bend Angle

The angle of the bend.

Bend Aid finds the smallest whole bend angle that will allow the kick to fit between the supports or obstructions.

### Travel

The center line length of the arc of the bend.

### Bending A Rack Of Kicks

Lay out the dimensions on the straight conduit.

Shoe Marks may be put on either side of any bend and the bend may be bent from either direction, once you have charted the bender being used and know how far from the bend the Shoe Mark should be.

If a pull through bender is being used then the Travel answer may be used to measure the Bend Angle by putting the conduit in the bender and marking the Travel from the back of the roller support.

If an old "Chicago" bender is being used then the weight of the handle will allow you to check the spring-back of the bend, pull the bend up to the Travel mark, let go of the handle and see if the conduit springs back, add more bend as needed.

If an electric chain driven bender is being used the spring-back must be a guess.

If a push through bender is being used then lay out the bends and find the centers of the bends.

## Segments

Tap to go to the enter segment bend angle scene.

## Top Left of Scene

### Back

Tap to go back to the enter scene to change variables.

## Bottom Row

### Bend Aid Menu

Tap to go to the Bend Aid main menu.

# Enter Kick Concentric

<
Enter
Help

---

Kick Concentric

---

Select Number Format

Decimal    
  1/16    
  1/32    
  Metric

---

Enter All

Number Of Conduit	3
Bend Radius	9
Center Spacing	4

---

Enter Any Two

Kick	12
Length	36
Hypotenuse	0.0
Angle	0.0

---

Answers

---

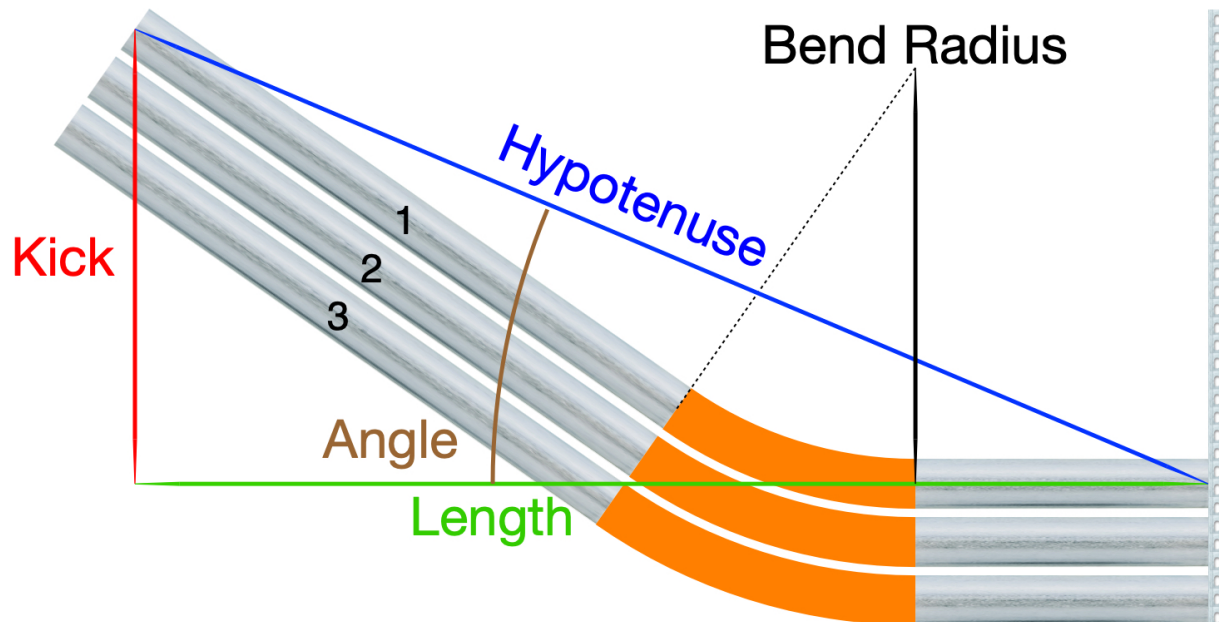

## Enter Kick Concentric Help

Bend Aid solves a rack of concentric kicks by entering the required variables and any two of the four right triangle variables.

Measure where the kick needs to fit.

Measure the right triangle for the first kick and the rest of the start bends and bend radii will be solved.

Usually you measure the kick and the length between the supports or obstructions, but any two of the four variables of the right triangle may be entered.

Bend Aid finds the smallest bend angle that will fit.

## Select Number Format

Tap a segment to select the number format.

Enter All

Bend Radius

The center line radius of the bends.

Enter Any Two

Kick

Length

Hypotenuse

Angle (Measured Angle, NOT Bend Angle)

Alerts

Alerts are shown after the Answers button is tapped if there is a problem with the entered variables or if the answers will not work.

Enter

Number Of Conduit

Must be entered.

Bend Radius

Must be entered.

Center Spacing

Must be entered.

Enter Any Two

Enter two variables and then tap Answers.

Hypotenuse

Must be greater than either side.

Angle

Must be less than  $90^\circ$ .

Answers

Bend Angle over  $90^\circ$

Length may be too short for the Angle or Radius.

Tap OK to dismiss an alert.

Bottom Row

Answers

Tap to show the answers view.

# Answer Kick Concentric

[Back](#)

Answers

[Help](#)

## Kick Concentric

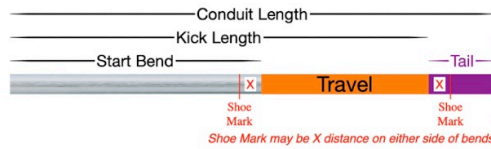

## Select Number Format

Decimal

1/16

1/32

Metric

## Entered

Number Of Conduit	3
Bend Radius	9 "
Center Spacing	4 "
Kick	12 "
Length	36 "
Hypotenuse	37 <sup>15</sup> / <sub>16</sub> "
Angle	18.43 °

## Answers

Conduit Number	1
Conduit Length	38 <sup>1</sup> / <sub>16</sub> "
Tail	1 <sup>7</sup> / <sub>16</sub> "
Kick Length	34 <sup>9</sup> / <sub>16</sub> "
Start Bend	33 <sup>1</sup> / <sub>2</sub> "
Bend Angle	20 °
Bend Radius	9 "
Travel	3 <sup>1</sup> / <sub>8</sub> "

[Previous](#)

[Next](#)

[Segments](#)

[Bend Aid Menu](#)



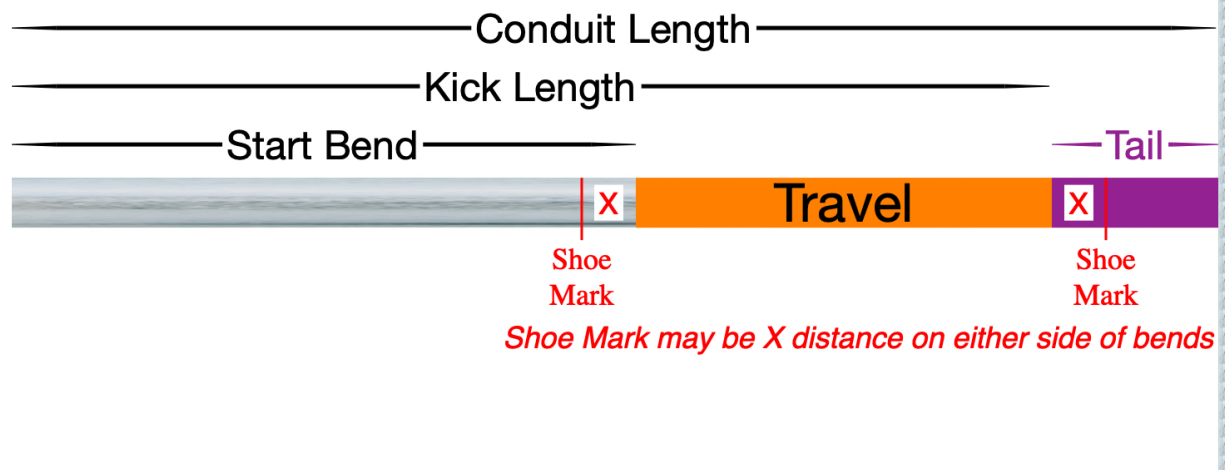

## Answer Kick Concentric Help

The answers given for a rack of concentric kicks allow the bend to be laid out and the conduit cut and threaded before the conduit is bent.

Mark the beginning and end of the bend so you can see exactly where the bend will be.

Find the center of the bend if needed for benders that bend from the middle of the bend.

## Select Number Format

Tap a segment to select the format to display the answers.

The number format may be changed at any time which allows the different formats to be converted.

Entered

The variables entered are displayed so they can be verified.

The variables of the right triangle are displayed and whichever answers were solved.

## Answers

### Conduit Number

The number of the conduit in the rack that the answers are being shown for.

### Conduit Length

The total length of conduit needed to make the kick including the start bend and tail.

### Kick

The new kick from the rack to the row.

### Kick Length

The length of the kick to the finish of the bend.

### Tail

The length of conduit from the finish of the kick's bend to the length that was entered.

### Start Bend

The length from the end of the conduit to the start of the bend.

### Bend Angle

The angle of the bend.

Bend Aid finds the smallest whole bend angle that will allow the kick to fit between the supports or obstructions.

### Travel

The center line length of the arc of the bend.

### Bending A Rack Of Concentric Kicks

Lay out the dimensions on the straight conduit.

Shoe Marks may be put on either side of any bend and the bend may be bent from either direction, once you have charted the bender being used and know how far from the bend the Shoe Mark should be.

If a pull through bender is being used then the Travel answer may be used to measure the Bend Angle by putting the conduit in the bender and marking the Travel from the back of the roller support.

If an old "Chicago" bender is being used then the weight of the handle will allow you to check the spring-back of the bend, pull the bend up to the Travel mark, let go of the handle and see if the conduit springs back, add more bend as needed.

If an electric chain driven bender is being used the spring-back must be a guess.

If a push through bender is being used then lay out the bends and find the centers of the bends.

## Segments

Tap to go to the enter segment bend angle scene.

## Top Left of Scene

### Back

Tap to go back to the enter scene to change variables.

## Bottom Row

### Bend Aid Menu

Tap to go to the Bend Aid main menu.

# Enter Simple Kick



Enter

Help

Simple Kick

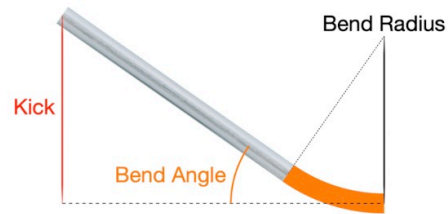

Select Number Format

Decimal

1/16

1/32

Metric

Enter All

Bend Radius

9

Bend Angle

30

Kick

12

[Answers](#)

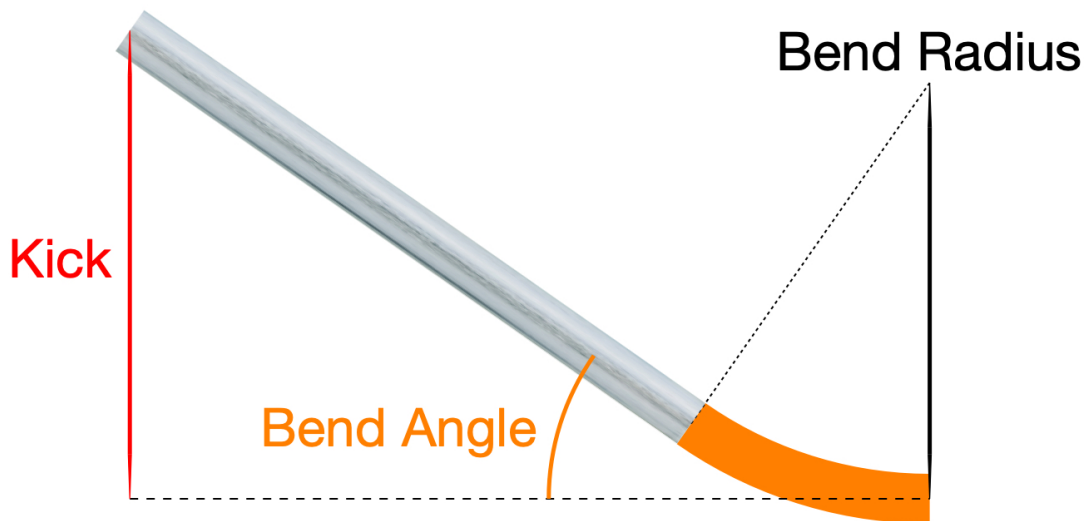

## Enter Simple Kick Help

Bend Aid solves a simple kick by entering the required variables.

### Select Number Format

Tap a segment to select the number format.

### Enter All

#### Bend Radius

The center line radius of the bends.

#### Bend Angle

The bend angle to be used.

#### Kick

The kick.

## Alerts

Alerts are shown after the Answers button is tapped if there is a problem with the entered variables or if the answers will not work.

Enter

Bend Radius

Must be entered.

Bend Angle

Must be entered.

Entered Bend Angle

Must be less than  $90^\circ$ .

Kick

Must be entered.

Answers

Bend Angle over  $90^\circ$

Length may be too short for the Angle or Radius.

Tap OK to dismiss an alert.

Bottom Row

Answers

Tap to show the answers scene.

# Answer Simple Kick

[Back](#)

Answers

[Help](#)

## Simple Kick

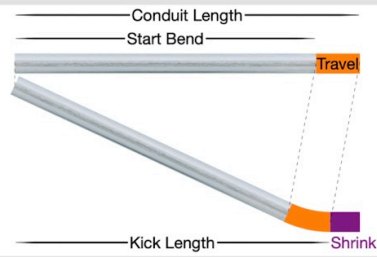

## Select Number Format

Decimal

1/16

1/32

Metric

## Entered

Bend Radius	9 "
Bend Angle	30 °
Kick	12 "

## Answers

Conduit Length	26 <sup>5</sup> / <sub>16</sub> "
Kick Length	23 <sup>3</sup> / <sub>16</sub> "
Shrink	3 <sup>1</sup> / <sub>8</sub> "
Start Bend	21 <sup>9</sup> / <sub>16</sub> "
Travel	4 <sup>11</sup> / <sub>16</sub> "

[Segments](#)

[Bend Aid Menu](#)



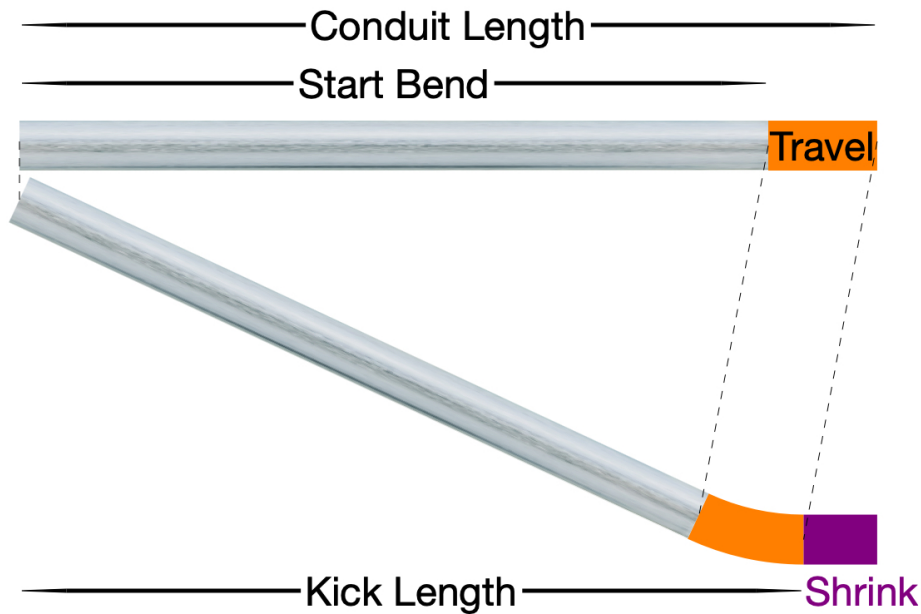

## Answer Simple Kick Help

The answers given for a simple kick allow the bend to be laid out and the conduit cut and threaded before the conduit is bent.

Mark the beginning and end of the bend so you can see exactly where the bend will be.

Find the center of the bend if needed for benders that bend from the middle of the bend.

## Select Number Format

Tap a segment to select the format to display the answers.

The number format may be changed at any time which allows the different formats to be converted.

Entered

The variables entered are displayed so they can be verified.

## Answers

### Conduit Length

The total length of conduit needed to make the offset including the start bend and tail.

### Kick Length

The length of the offset from the start of the first bend to the finish of the last bend

### Shrink

The difference between the conduit length and the kick length after the kick is bent.

### Start Bend

The length from the end of the conduit to the start of the bend.

### Bend Angle

The angle of the bend.

Bend Aid finds the smallest whole bend angle that will allow the kick to fit between the supports or obstructions.

### Travel

The center line length of the arc of the bend.

## Bending A Kick

Lay out the dimensions on the straight conduit.

Shoe Marks may be put on either side of any bend and the bend may be bent from either direction, once you have charted the bender being used and know how far from the bend the Shoe Mark should be.

If a pull through bender is being used then the Travel answer may be used to measure the Bend Angle by putting the conduit in the bender and marking the Travel from the back of the roller support.

If an old “Chicago” bender is being used then the weight of the handle will allow you to check the spring-back of the bend, pull the bend up to the Travel mark, let go of the handle and see if the conduit springs back, add more bend as needed.

If an electric chain driven bender is being used the spring-back must be guessed at.

If a push through bender is being used then layout the bends and find the centers of the bends.

If the offset needs to end at the second support then add the Tail length to the Start Bend length.

## Segments

Tap to go to the enter segment bend angle scene.

Top Left of Scene

Back

Tap to go back to the enter scene to change variables.

Bottom Row

Bend Aid Menu

Tap to go to the Bend Aid main menu.

# Enter Kick Rack To Horizontal

< Enter Help

Kick Rack To Horizontal

Select Number Format

Decimal 1/16 1/32 Metric

Enter All

Number Of Conduit	3
Bend Radius	9
Center Spacing	4

Enter Any Two

Kick	12
Length	36
Hypotenuse	0.0
Angle	0.0

Answers

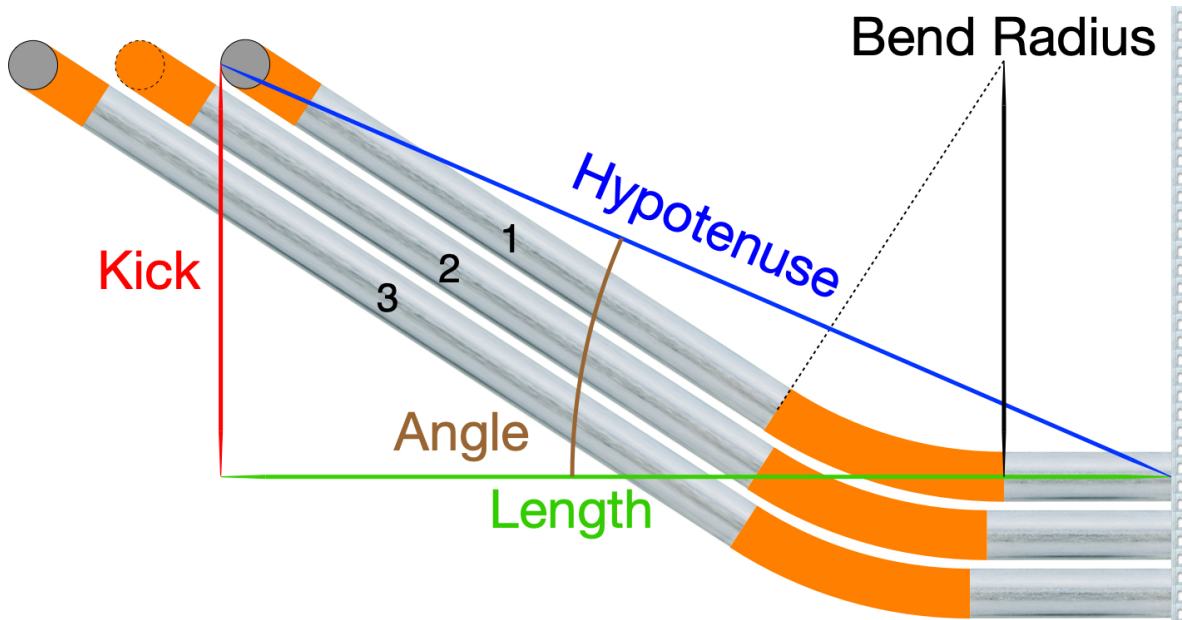

## Enter Kick Rack To Horizontal Help

Bend Aid solves a rack of kicks to a horizontal row by entering the required variables and any two of the four right triangle variables.

Measure where the kick needs to fit.

Measure the right triangle for the first kick and the rest of the start bends and bend radii will be solved.

Usually you measure the kick and the length between the supports or obstructions, but any two of the four variables of the right triangle may be entered.

Bend Aid finds the smallest bend angle that will fit.

## Select Number Format

Tap a segment to select the number format.

## Enter All

### Number Of Conduit

The number of conduit in the rack.

### Bend Radius

The center line radius of the bends.

### Center Spacing

The center to center spacing of the conduit in the rack.

## Enter Any Two

### Kick

### Length

### Hypotenuse

Angle (Measured Angle, NOT Bend Angle)

## Alerts

Alerts are shown after the Answers button is tapped if there is a problem with the entered variables or if the answers will not work.

## Enter

### Number Of Conduit

Must be entered.

### Bend Radius

Must be entered.

### Center Spacing

Must be entered.

Enter Any Two

Enter two variables and then tap Answers.

Hypotenuse

Must be greater than either side.

Angle

Must be less than  $90^\circ$ .

Answers

Bend Angle over  $90^\circ$

Length may be too short for the Angle or Radius.

Tap OK to dismiss an alert.

Bottom Row

Answers

Tap to show the answers scene.



# Answer Kick Rack To Horizontal

[Back](#)

Answers

[Help](#)

## Kick Rack To Horizontal

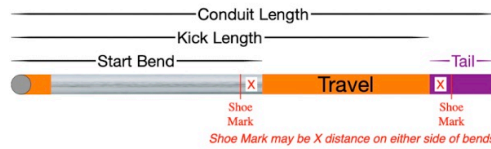

### Select Number Format

Decimal

1/16

1/32

Metric

### Entered

Number Of Conduit	3
Bend Radius	9 "
Center Spacing	6 "
Kick	12 "
Length	36 "
Hypotenuse	37 <sup>15</sup> / <sub>16</sub> "
Angle	18.43 °

### Answers

Hole Spacing	6 <sup>1</sup> / <sub>16</sub> "
Conduit Number	1
Conduit Length	38 <sup>1</sup> / <sub>16</sub> "
Kick	12 "
Kick Length	34 <sup>9</sup> / <sub>16</sub> "
Tail	1 <sup>7</sup> / <sub>16</sub> "
Start Bend	33 <sup>1</sup> / <sub>2</sub> "
Bend Angle	20 °
Travel	3 <sup>1</sup> / <sub>8</sub> "

[Previous](#)

[Next](#)

[Segments](#)

[Bend Aid Menu](#)

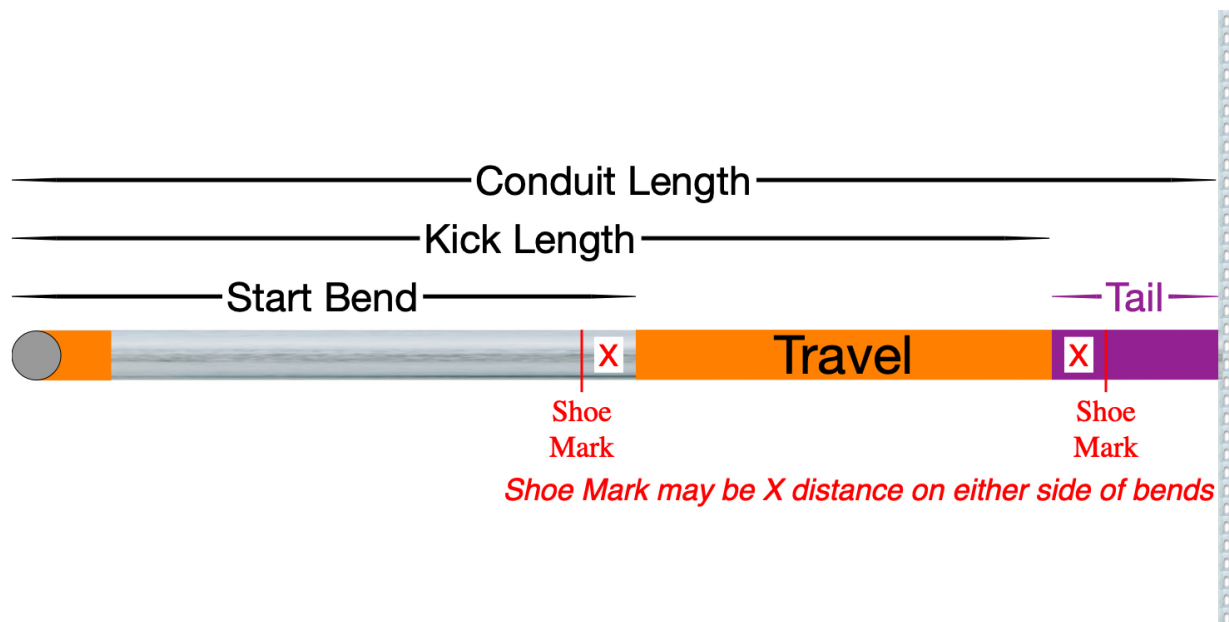

## Answer Kick Rack To Horizontal Help

The answers given for a rack of kicks to a horizontal row allows the bend to be laid out and the conduit cut and threaded before the conduit is bent.

Mark the beginning and end of the bend so you can see exactly where the bend will be.

Find the center of the bend if needed for benders that bend from the middle of the bend.

## Select Number Format

Tap a segment to select the format to display the answers.

The number format may be changed at any time which allows the different formats to be converted.

Entered

The variables entered are displayed so they can be verified.

The variables of the right triangle are displayed and whichever answers were solved.

#### Answers

##### Conduit Number

The number of the conduit in the rack that the answers are being shown for.

##### Conduit Length

The total length of conduit needed to make the kick including the start bend and tail.

##### Kick

The new kick from the rack to the row.

##### Kick Length

The length of the kick to the finish of the bend

##### Tail

The length of conduit from the finish of the kick's bend to the length that was entered.

##### Start Bend

The length from the end of the conduit to the start of the bend.

##### Bend Angle

The angle of the bend.

Bend Aid finds the smallest whole bend angle that will allow the kick to fit between the supports or obstructions.

### Travel

The center line length of the arc of the bend.

### Bending A Rack Of Kicks To A Horizontal Row

Lay out the dimensions on the straight conduit.

Shoe Marks may be put on either side of any bend and the bend may be bent from either direction, once you have charted the bender being used and know how far from the bend the Shoe Mark should be.

If a pull through bender is being used then the Travel answer may be used to measure the Bend Angle by putting the conduit in the bender and marking the Travel from the back of the roller support.

If an old "Chicago" bender is being used then the weight of the handle will allow you to check the spring-back of the bend, pull the bend up to the Travel mark, let go of the handle and see if the conduit springs back, add more bend as needed.

If an electric chain driven bender is being used the spring-back must be a guess.

If a push through bender is being used then lay out the bends and find the centers of the bends.

## Segments

Tap to go to the enter segment bend angle view.

## Top Left of Scene

### Back

Tap to go back to the enter scene to change variables.

## Bottom Row

### Bend Aid Menu

Tap to go to the Bend Aid main menu.

# Enter Kick Concentric To Horizontal

< Enter Help

Kick Concentric To Horizontal

Select Number Format

Decimal 1/16 1/32 Metric

Enter All

Number Of Conduit	3
Bend Radius	9
Center Spacing	4

Enter Any Two

Kick	12
Length	36
Hypotenuse	0.0
Angle	0.0

Answers

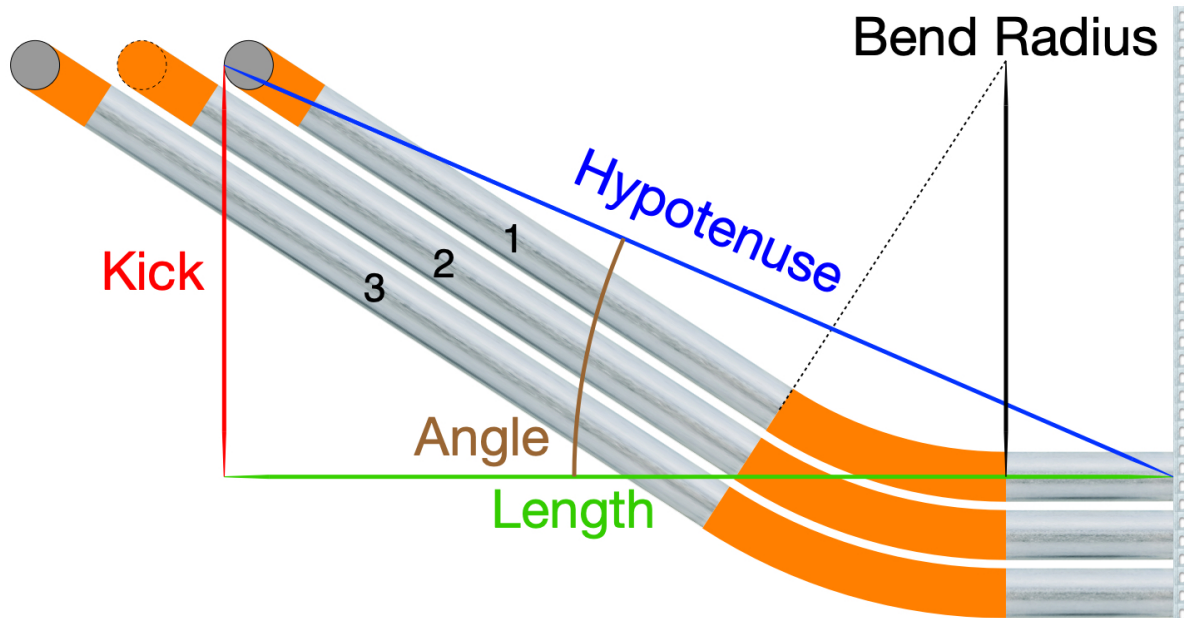

## Enter Kick Concentric To Horizontal Help

Bend Aid solves a rack of concentric kicks to a horizontal row by entering the required variables and any two of the four right triangle variables.

Measure where the kick needs to fit.

Measure the right triangle for the first kick and the rest of the start bends and bend radii will be solved.

Usually you measure the kick and the length between the supports or obstructions, but any two of the four variables of the right triangle may be entered.

Bend Aid finds the smallest bend angle that will fit.

## Select Number Format

Tap a segment to select the number format.

## Enter All

### Number Of Conduit

The number of conduit in the rack.

### Bend Radius

The smallest center line radius of the bends.

Each bend radius will be solved and all bends will be bent using segments unless the smallest bend radius is a standard bending shoe radius.

### Start Bend

Is where the bends should start.

If Start Bend is not entered then that dimension will not be included in the answers.

### Center Spacing

The center to center spacing of the conduits in the rack.

## Enter Any Two

Kick

Length

Hypotenuse

Angle (Measured Angle, NOT Bend Angle)

## Alerts

Alerts are shown after the Answers button is tapped if there is a problem with the entered variables or if the answers will not work.



Enter

Number Of Conduit  
Must be entered.

Bend Radius  
Must be entered.

Center Spacing  
Must be entered.

Enter Any Two  
Enter two variables and then tap Answers.

Hypotenuse  
Must be greater than either side.

Angle  
Must be less than  $90^\circ$ .

Answers

Bend Angle over  $90^\circ$   
Length may be too short for the Angle or Radius.

Tap OK to dismiss an alert.

Bottom Row

Answers

Tap to show the answers scene.

# Answer Kick Concentric To Horizontal

[Back](#)

Answers

[Help](#)

## Kick Concentric To Horizontal

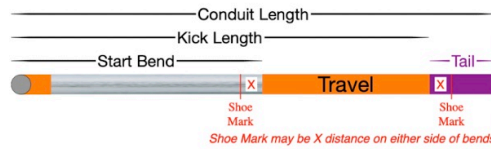

### Select Number Format

Decimal

1/16

1/32

Metric

### Entered

Number Of Conduit	3
Bend Radius	9 "
Center Spacing	4 "
Kick	12 "
Length	36 "
Hypotenuse	37 <sup>15</sup> / <sub>16</sub> "
Angle	18.43 °

### Answers

Hole Spacing	4 <sup>1</sup> / <sub>4</sub> "
Conduit Number	1
Conduit Length	38 <sup>1</sup> / <sub>16</sub> "
Kick	12 "
Kick Length	34 <sup>9</sup> / <sub>16</sub> "
Tail	1 <sup>7</sup> / <sub>16</sub> "
Start Bend	33 <sup>1</sup> / <sub>2</sub> "
Bend Angle	20 °
Bend Radius	9 "
Travel	3 <sup>1</sup> / <sub>8</sub> "

[Previous](#)

[Next](#)

[Segments](#)

[Bend Aid Menu](#)

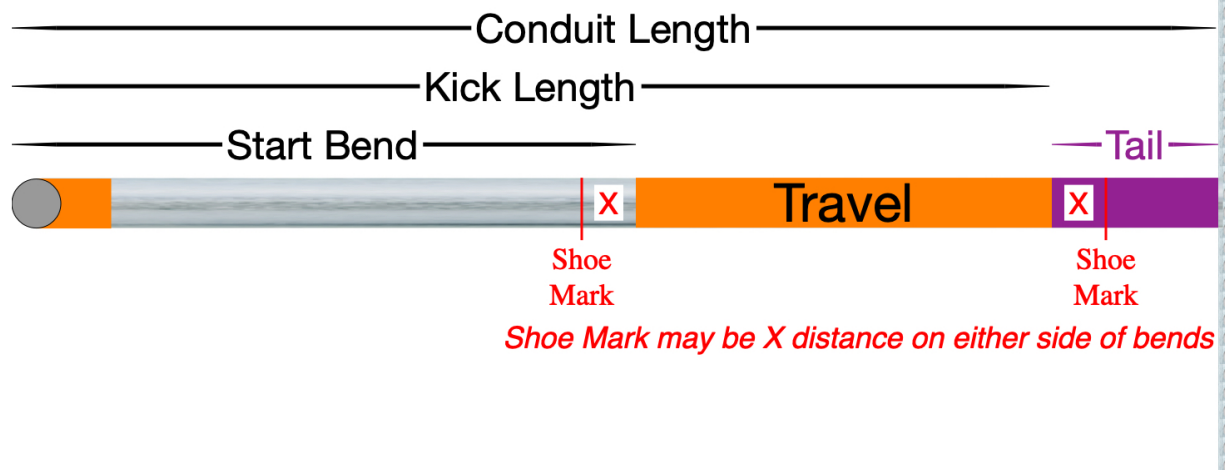

## Answer Kick Concentric To Horizontal Help

The answers given for a rack of concentric kicks to a horizontal row allows the bend to be laid out and the conduit cut and threaded before the conduit is bent.

Mark the beginning and end of the bend so you can see exactly where the bend will be.

Find the center of the bend if needed for benders that bend from the middle of the bend.

## Select Number Format

Tap a segment to select the format to display the answers.

The number format may be changed at any time which allows the different formats to be converted.

Entered

The variables entered are displayed so they can be verified.

The variables of the right triangle are displayed and whichever answers were solved.

## Answers

### Conduit Number

The number of the conduit in the rack that the answers are being shown for.

### Conduit Length

The total length of conduit needed to make the kick including the start bend and tail.

### Kick

The new kick from the rack to the row.

### Kick Length

The length of the kick to the finish of the bend.

### Tail

The length of conduit from the finish of the kick's bend to the length that was entered.

### Start Bend

The length from the end of the conduit to the start of the bend.

### Bend Angle

The angle of the bend.

Bend Aid finds the smallest whole bend angle that will allow the kick to fit between the supports or obstructions.

### Travel

The center line length of the arc of the bend.

### Bending Concentric Kicks To A Horizontal Row

Lay out the dimensions on the straight conduit.

Shoe Marks may be put on either side of any bend and the bend may be bent from either direction, once you have charted the bender being used and know how far from the bend the Shoe Mark should be.

If a pull through bender is being used then the Travel answer may be used to measure the Bend Angle by putting the conduit in the bender and marking the Travel from the back of the roller support.

If an old "Chicago" bender is being used then the weight of the handle will allow you to check the spring-back of the bend, pull the bend up to the Travel mark, let go of the handle and see if the conduit springs back, add more bend as needed.

If an electric chain driven bender is being used the spring-back must be a guess.

If a push through bender is being used then lay out the bends and find the centers of the bends.

## Segments

Tap to go to the enter segment bend angle scene.

## Top Left of Scene

### Back

Tap to go back to the enter scene to change variables.

## Bottom Row

### Bend Aid Menu

Tap to go to the Bend Aid main menu.

# Enter Kick Rack To Vertical

< Enter Help

Kick Rack To Vertical

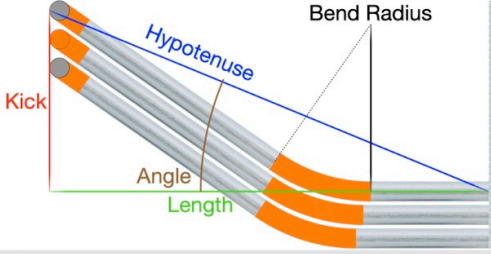

The diagram illustrates a kick rack bend. It shows three parallel conduits (orange) that are initially horizontal and then bend upwards at an angle. A red vertical line labeled 'Kick' represents the vertical distance from the original horizontal line to the top of the bend. A green horizontal line labeled 'Length' represents the horizontal distance from the start of the bend to the vertical line. A blue line labeled 'Hypotenuse' connects the top of the kick to the end of the length. A brown line labeled 'Angle' is the angle between the length and the hypotenuse. A vertical line labeled 'Bend Radius' indicates the radius of the bend.

Select Number Format

Decimal 1/16 1/32 Metric

Enter All

Number Of Conduit	3
Bend Radius	9
Center Spacing	4

Enter Any Two

Kick	12
Length	36
Hypotenuse	0.0
Angle	0.0

Answers

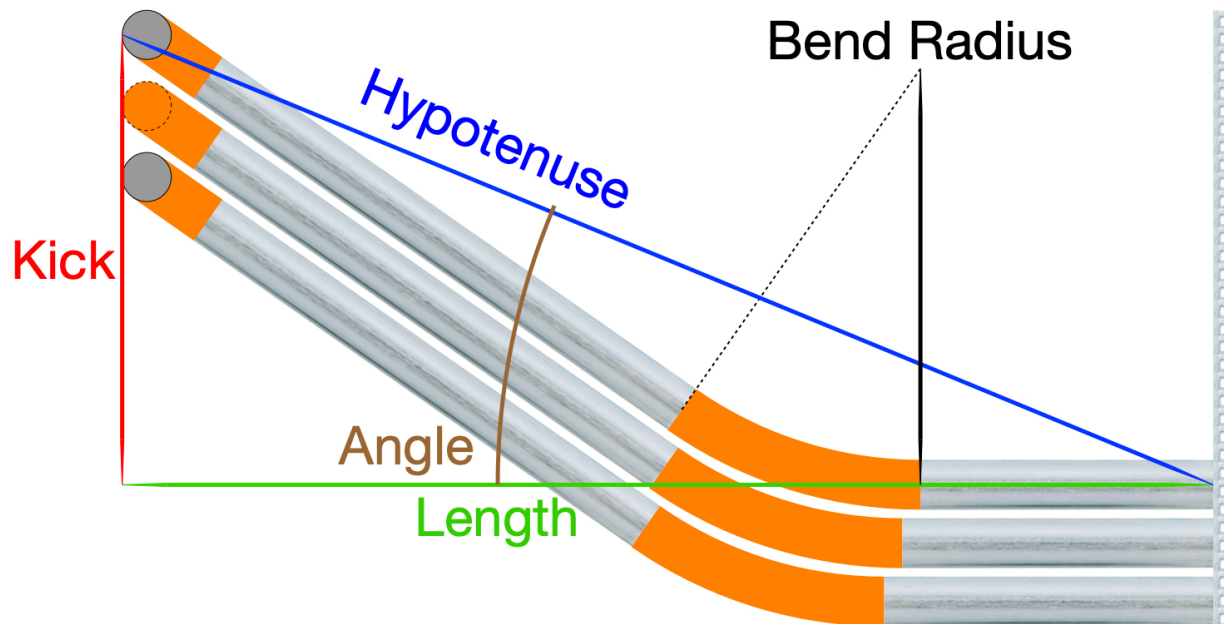

## Enter Kick Rack To Vertical Help

Bend Aid solves a rack of kicks to a vertical row by entering the required variables and any two of the four right triangle variables.

Measure where the kick needs to fit.

Measure the right triangle for the first kick and the rest of the start bends and bend radii will be solved.

Usually you measure the kick and the length between the supports or obstructions, but any two of the four variables of the right triangle may be entered.

Bend Aid finds the smallest bend angle that will fit.

## Select Number Format

Tap a segment to select the number format.



## Enter All

### Number Of Conduit

The number of conduit in the rack.

### Bend Radius

The smallest center line radius of the bends.

Each bend radius will be solved and all bends will be bent using segments unless the smallest bend radius is a standard bending shoe radius.

### Center Spacing

The center to center spacing of the conduits in the rack.

## Enter Any Two

Kick

Length

Hypotenuse

Angle (Measured Angle, NOT Bend Angle)

## Alerts

Alerts are shown after the Answers button is tapped if there is a problem with the entered variables or if the answers will not work.

## Enter

Number Of Conduit

Must be entered.

Bend Radius

Must be entered.

Center Spacing

Must be entered.

Enter Any Two

Enter two variables and then tap Answers.

Hypotenuse

Must be greater than either side.

Angle

Must be less than  $90^\circ$ .

Answers

Bend Angle over  $90^\circ$

Length may be too short for the Angle or Radius.

Tap OK to dismiss an alert.

Bottom Row

Answers

Tap to show the answers scene.

# Answer Kick Rack To Vertical

[Back](#)

Answers

[Help](#)

## Kick Rack To Vertical

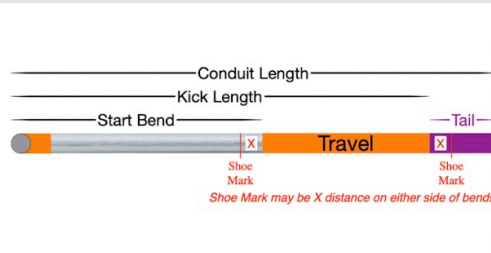

### Select Number Format

Decimal

1/16

1/32

Metric

### Entered

Number Of Conduit	3
Bend Radius	9 "
Center Spacing	4 "
<b>Kick</b>	<b>12 "</b>
<b>Length</b>	<b>36 "</b>
<b>Hypotenuse</b>	<b>37 <sup>15</sup>/<sub>16</sub> "</b>
<b>Angle</b>	<b>18.43 °</b>

### Answers

Hole Spacing	4 <sup>1</sup> / <sub>4</sub> "
<b>Conduit Number</b>	<b>1</b>
<b>Conduit Length</b>	<b>38 <sup>1</sup>/<sub>16</sub> "</b>
<b>Kick</b>	<b>12 "</b>
<b>Kick Length</b>	<b>34 <sup>9</sup>/<sub>16</sub> "</b>
<b>Tail</b>	<b>1 <sup>7</sup>/<sub>16</sub> "</b>
<b>Start Bend</b>	<b>33 <sup>1</sup>/<sub>2</sub> "</b>
<b>Bend Angle</b>	<b>20 °</b>
<b>Travel</b>	<b>3 <sup>1</sup>/<sub>8</sub> "</b>

[Previous](#)

[Next](#)

[Segments](#)

[Bend Aid Menu](#)

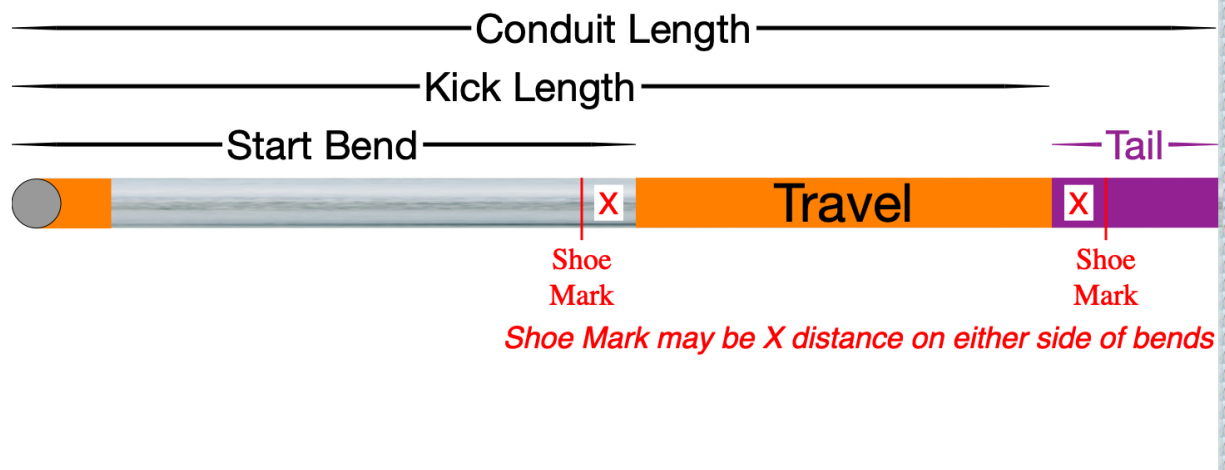

## Answer Kick Rack To Vertical Help

The answers given for a rack to vertical row of kicks allow the bend to be laid out and the conduit cut and threaded before the conduit is bent.

Mark the beginning and end of the bend so you can see exactly where the bend will be.

Find the center of the bend if needed for benders that bend from the middle of the bend.

## Select Number Format

Tap a segment to select the format to display the answers.

The number format may be changed at any time which allows the different formats to be converted.

Entered

The variables entered are displayed so they can be verified.

The variables of the right triangle are displayed and whichever answers were solved.

## Answers

### Conduit Number

The number of the conduit in the rack that the answers are being shown for.

### Conduit Length

The total length of conduit needed to make the kick including the start bend and tail.

### Kick

The new kick from the rack to the row.

### Kick Length

The length of the kick to the finish of the bend.

### Tail

The length of conduit from the finish of the kick's bend to the length that was entered.

### Start Bend

The length from the end of the conduit to the start of the bend.

### Bend Angle

The angle of the bend.

Bend Aid finds the smallest whole bend angle that will allow the kick to fit between the supports or obstructions.

### Travel

The center line length of the arc of the bend.

### Bending A Rack Of Kicks To A Vertical Row

Lay out the dimensions on the straight conduit.

Shoe Marks may be put on either side of any bend and the bend may be bent from either direction, once you have charted the bender being used and know how far from the bend the Shoe Mark should be.

If a pull through bender is being used then the Travel answer may be used to measure the Bend Angle by putting the conduit in the bender and marking the Travel from the back of the roller support.

If an old "Chicago" bender is being used then the weight of the handle will allow you to check the spring-back of the bend, pull the bend up to the Travel mark, let go of the handle and see if the conduit springs back, add more bend as needed.

If an electric chain driven bender is being used the spring-back must be a guess.

If a push through bender is being used then lay out the bends and find the centers of the bends.

## Segments

Tap to go to the enter segment bend angle scene.

## Top Left of Scene

### Back

Tap to go back to the enter scene to change variables.

## Bottom Row

### Bend Aid Menu

Tap to go to the Bend Aid main menu.

# Enter Kick Concentric To Vertical

< Enter Help

Kick Concentric To Vertical

Select Number Format

Decimal 1/16 1/32 Metric

Enter All

Number Of Conduit	3
Bend Radius	9
Center Spacing	4

Enter Any Two

Kick	12
Length	36
Hypotenuse	0.0
Angle	0.0

Answers



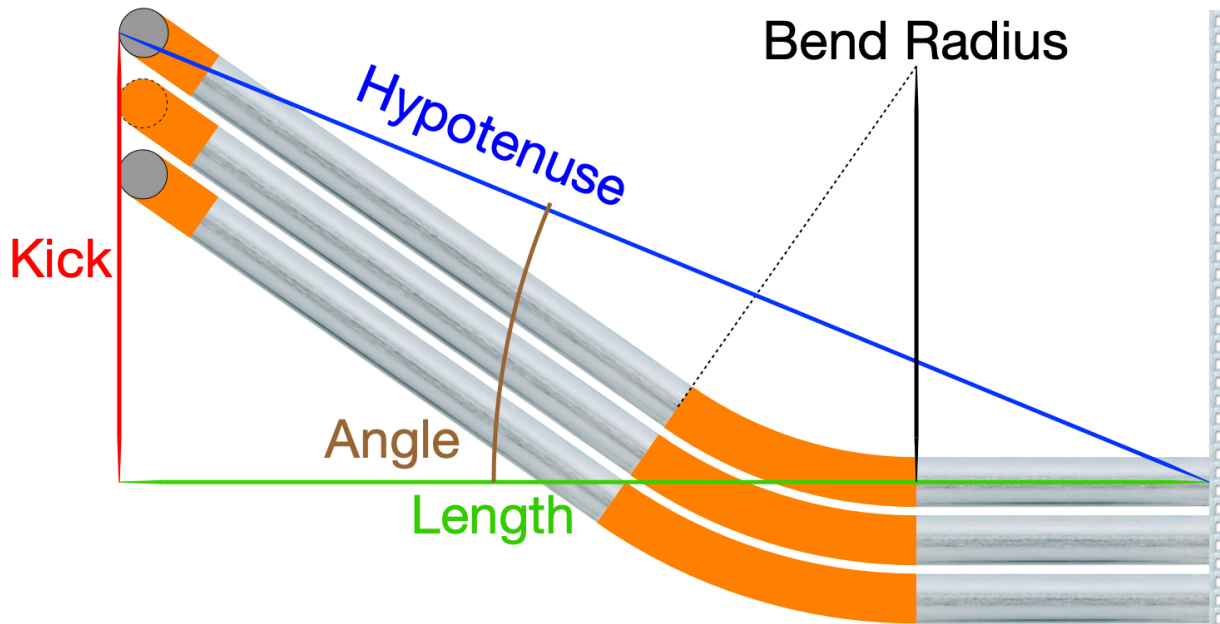

## Enter Kick Concentric To Vertical Help

Bend Aid solves a rack of concentric kicks to a vertical row by entering the required variables and any two of the four right triangle variables.

Measure where the kick needs to fit.

Measure the right triangle for the first kick and the rest of the start bends and bend radii will be solved.

Usually you measure the kick and the length between the supports or obstructions, but any two of the four variables of the right triangle may be entered.

Bend Aid finds the smallest bend angle that will fit.

## Select Number Format

Tap a segment to select the number format.

## Enter All

### Number Of Conduit

The number of conduit in the rack.

### Bend Radius

The smallest center line radius of the bends.

Each bend radius will be solved and all bends will be bent using segments unless the smallest bend radius is a standard bending shoe radius.

### Center Spacing

The center to center spacing of the conduits in the rack.

## Enter Any Two

Kick

Length

Hypotenuse

Angle (Measured Angle, NOT Bend Angle)

## Alerts

Alerts are shown after the Answers button is tapped if there is a problem with the entered variables or if the answers will not work.

## Enter

Number Of Conduit

Must be entered.

Bend Radius

Must be entered.

Center Spacing

Must be entered.

Enter Any Two

Enter two variables and then tap Answers.

Hypotenuse

Must be greater than either side.

Angle

Must be less than  $90^\circ$ .

Answers

Bend Angle over  $90^\circ$

Length may be too short for the Angle or Radius.

Tap OK to dismiss an alert.

Bottom Row

Answers

Tap to show the answers scene.

# Answer Kick Concentric To Vertical

[Back](#)

Answers

[Help](#)

## Kick Concentric To Vertical

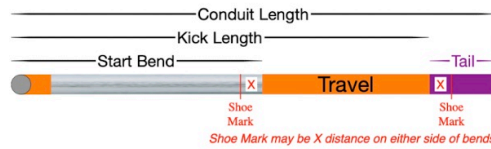

### Select Number Format

Decimal

1/16

1/32

Metric

### Entered

Number Of Conduit	3
Bend Radius	9 "
Center Spacing	4 "
Kick	12 "
Length	36 "
Hypotenuse	37 <sup>15</sup> / <sub>16</sub> "
Angle	18.43 °

### Answers

Hole Spacing	4 <sup>1</sup> / <sub>4</sub> "
Conduit Number	1
Conduit Length	38 <sup>1</sup> / <sub>16</sub> "
Kick	12 "
Kick Length	34 <sup>9</sup> / <sub>16</sub> "
Tail	1 <sup>7</sup> / <sub>16</sub> "
Start Bend	33 <sup>1</sup> / <sub>2</sub> "
Bend Angle	20 °
Bend Radius	9 "
Travel	3 <sup>1</sup> / <sub>8</sub> "

[Previous](#)

[Next](#)

[Segments](#)

[Bend Aid Menu](#)

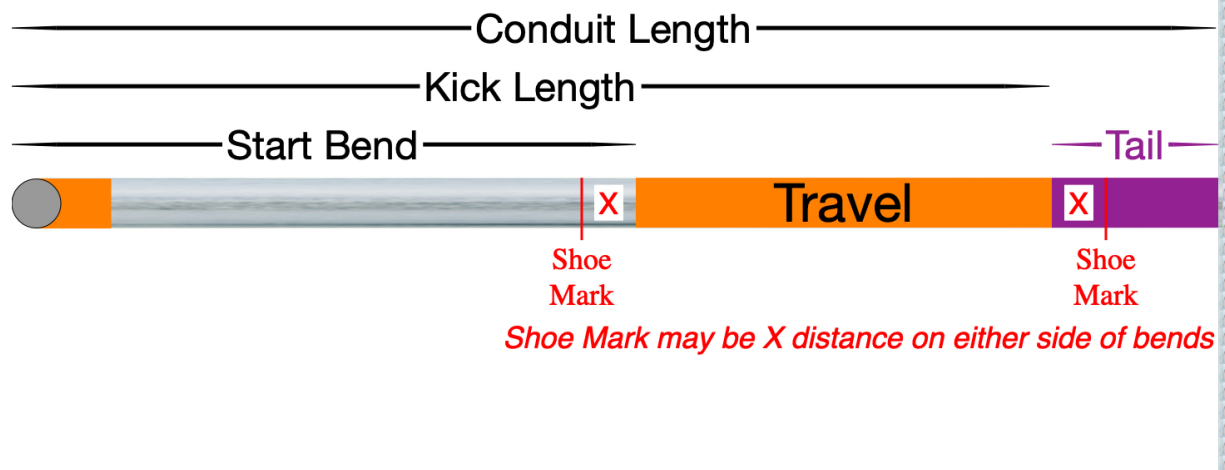

## Answer Kick Concentric To Vertical Help

The answers given for a rack of concentric kicks to a vertical row allow the bend to be laid out and the conduit cut and threaded before the conduit is bent.

Mark the beginning and end of the bend so you can see exactly where the bend will be.

Find the center of the bend if needed for benders that bend from the middle of the bend.

## Select Number Format

Tap a segment to select the format to display the answers.

The number format may be changed at any time which allows the different formats to be converted.

Entered

The variables entered are displayed so they can be verified.

The variables of the right triangle are displayed and whichever answers were solved.

## Answers

### Conduit Number

The number of the conduit in the rack that the answers are being shown for.

### Conduit Length

The total length of conduit needed to make the kick including the start bend and tail.

### Kick

The new kick from the rack to the row.

### Kick Length

The length of the kick to the finish of the bend.

### Tail

The length of conduit from the finish of the kick's bend to the length that was entered.

### Start Bend

The length from the end of the conduit to the start of the bend.

### Bend Angle

The angle of the bend.

Bend Aid finds the smallest whole bend angle that will allow the kick to fit between the supports or obstructions.

### Travel

The center line length of the arc of the bend.

### Bending Concentric Kicks To A Vertical Row

Lay out the dimensions on the straight conduit.

Shoe Marks may be put on either side of any bend and the bend may be bent from either direction, once you have charted the bender being used and know how far from the bend the Shoe Mark should be.

If a pull through bender is being used then the Travel answer may be used to measure the Bend Angle by putting the conduit in the bender and marking the Travel from the back of the roller support.

If an old "Chicago" bender is being used then the weight of the handle will allow you to check the spring-back of the bend, pull the bend up to the Travel mark, let go of the handle and see if the conduit springs back, add more bend as needed.

If an electric chain driven bender is being used the spring-back must be a guess.

If a push through bender is being used then lay out the bends and find the centers of the bends.

## Segments

Tap to go to the enter segment bend angle scene.

## Top Left of Scene

### Back

Tap to go back to the enter scene to change variables.







## Bottom Row

### Bend Aid Menu

Tap to go to the Bend Aid main menu.



# Nineties Menu

<	Nineties	Help
	Ninety	
	Ninety Rack	
	Ninety Concentric	
	Back To Back	
	Back To Back Rack	
	Back To Back Concentric	

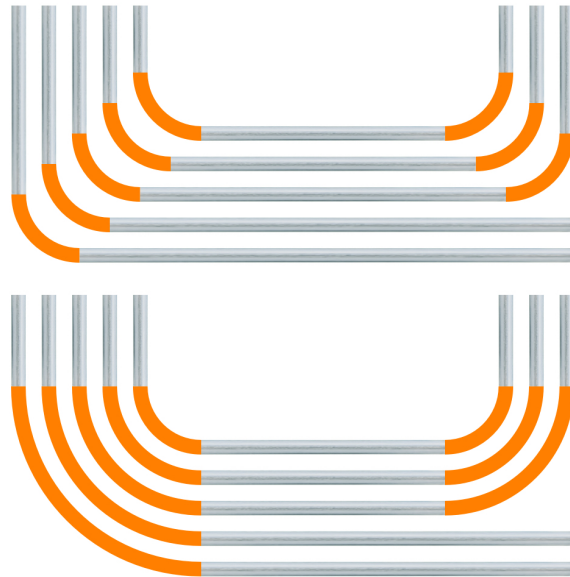

## Nineties Menu Help

Bend-Aid solves the center line of the conduit and bends.

Nineties are bends that change the direction of the conduit.

There is straight conduit in front of and behind the ninety, the riser and the length.

After the ninety there will be a length of conduit that will either be the end of a full length or the conduit will be cut to fit and maybe threaded, which will be given as an answer called Tail.

The bends of each conduit in a rack may be bent on the same bend radius or they may be bent concentrically.

# Enter Ninety

< Enter Help

Ninety

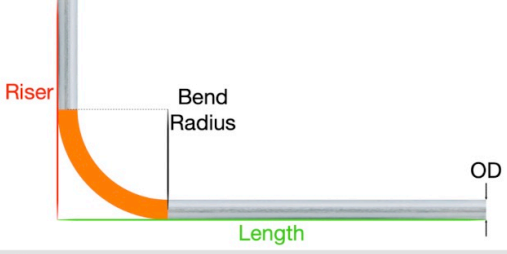

Select Number Format

Decimal 1/16 1/32 Metric

Enter All

Bend Radius	9
Conduit OD	2.25
Riser	12
Length	36

Answers

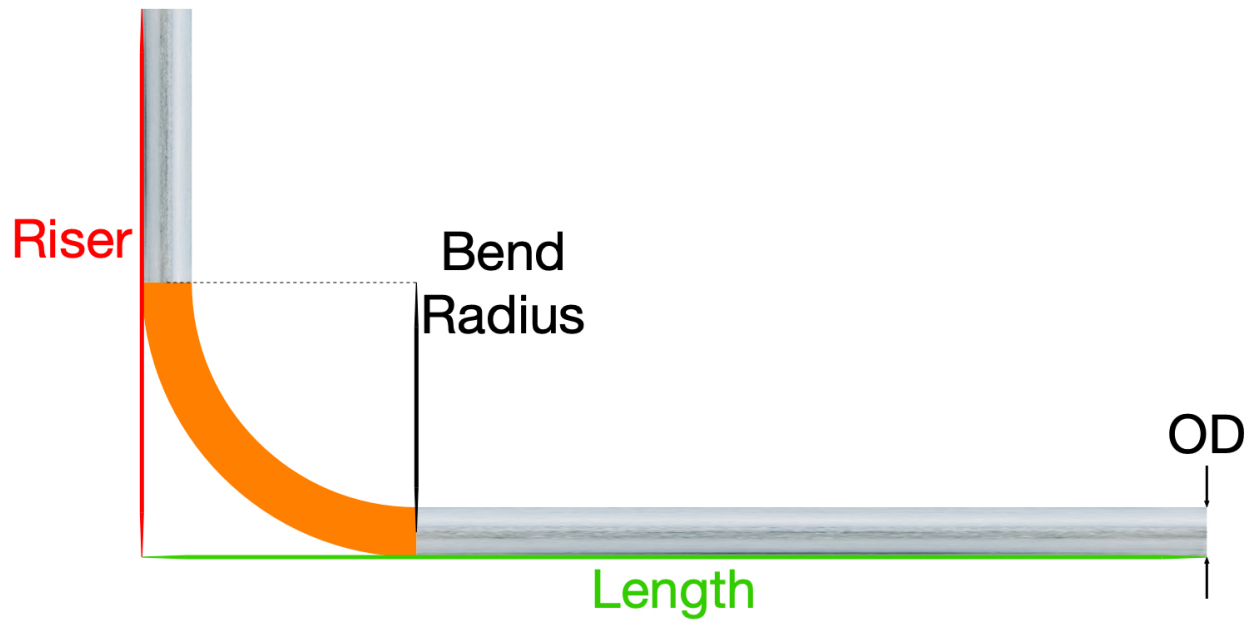

Enter Ninety Help

Bend Aid solves a ninety by entering the required variables.

Select Number Format

Tap a segment to select the number format.

Enter All

Bend Radius

The center line radius of the bends.

Conduit OD

The outside diameter of the conduit.

Riser

The height of the ninety from the back of the bend.

Length

The length of the ninety from the back of the bend.

If length is not entered the answers will be to the finish of the bend.

## Alerts

Alerts are shown after the Answers button is tapped if there is a problem with the entered variables or if the answers will not work.

### Enter

Bend Radius

Must be entered.

Conduit OD

Must be entered.

Riser

Must be entered.

Entered Riser

Must be greater than the Bend Radius plus  $1/2$  Conduit OD.

Entered Length

Must be greater than the Bend Radius plus  $1/2$  Conduit OD.

Tap OK to dismiss an alert.

## Bottom Row

Answers

Tap to show the answers scene.

# Answer Ninety

[Back](#) **Answers** [Help](#)

**Ninety**

Conduit Length

Start Bend

Travel

Tail

Shoe Mark

Shoe Mark

Shoe Mark may be X distance on either side of bends

Conduit Length

Travel

If Length is not entered then Conduit Length is to the end of the Travel

**Select Number Format**

Decimal |  1/16 |  1/32 | Metric

**Entered**

Bend Radius	9 "
Conduit OD	2 1/4 "
Riser	12 "
Length	36 "

**Answers**

Conduit Length	41 7/8 "
Tail	25 7/8 "
Start Bend	1 7/8 "
Travel	14 1/8 "

[Segments](#)

[Bend Aid Menu](#)

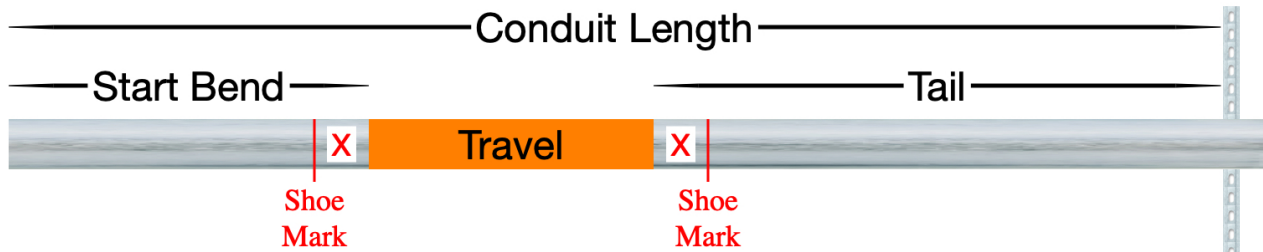

*Shoe Mark may be X distance on either side of bends*



*If Length is not entered then Conduit Length is to the end of the Travel*

## Answer Ninety Help

The answers given for a ninety allow the bend to be laid out and the conduit cut and threaded before the conduit is bent.

Mark the beginning and end of the bend so you can see exactly where they will be.

Find the center of the bend if needed for benders that bend from the middle of the bend.

## Select Number Format

Tap a segment to select the format to display the answers.

The number format may be changed at any time which allows the different formats to be converted.

Entered



The variables entered are displayed so they can be verified.

## Answers

### Conduit Length

The total length of conduit needed to make the ninety.

### Tail

The length of conduit from the finish of the bend to the length that was entered.

### Start Bend

The length from the end of the conduit to the start of the bend.

### Travel

The center line length of the arc of the bend.

## Bending A Ninety

Layout the dimensions on the straight conduit.

Shoe Marks may be put on either side of any bend and the bend may be bent from either direction, once you have charted the bender being used and know how far from the bend the Shoe Mark should be.

If a pull through bender is being used then the Travel answer may be used to measure the Bend Angle by putting the conduit in the bender and marking the Travel from the back of the roller support.

If an old “Chicago” bender is being used then the weight of the handle will allow you to check the spring-back of the bend, pull the bend up to the Travel mark, let go of the handle and see if the conduit springs back, add more bend as needed.

If an electric chain driven bender is being used the spring-back must be guessed at.

If a push through bender is being used, layout the bends and find the centers of the bends.

If the offset needs to end at the second support, add the Tail length to the Start Bend length.

## Segments

Tap to go to the enter segment bend angle view.

## Top Left of View

### Back

Tap to go back to the enter scene to change variables.

## Bottom Row

### Bend Aid Menu

Tap to go to the Bend Aid main menu.

# Enter Ninety Rack

< Enter Help

Ninety Rack

Center Spacing

Riser

Bend Radius

Length

OD

1

2

3

Select Number Format

Decimal 1/16 1/32 Metric

Enter All

Number Of Conduit	3
Bend Radius	9
Conduit OD	2.25
Center Spacing	4
Riser	12
Length	36

Answers

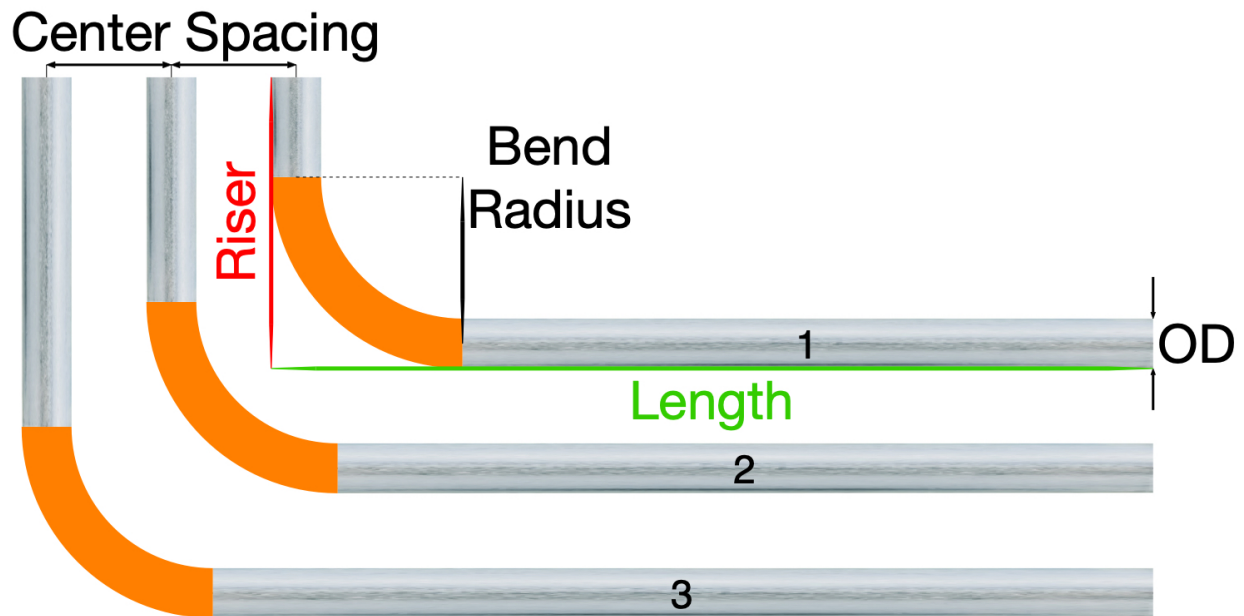

## Enter Ninety Rack Help

Bend Aid solves a rack of nineties by entering the required variables.

### Select Number Format

Tap a segment to select the number format.

### Enter All

#### Number Of Conduit

The number of conduit in the rack.

#### Bend Radius

The center line radius of the bends.

#### Conduit OD

The outside diameter of the conduit.

#### Center Spacing

The center to center spacing of the conduit in the rack.

### Riser

The height of the ninety from the back of the bend.

### Length

The length of the ninety from the back of the bend.

If length is not entered the answers will be to the finish of the bend.

### Alerts

Alerts are shown after the Answers button is tapped if there is a problem with the entered variables or if the answers will not work.

### Enter

Number Of Conduit  
Must be entered.

Bend Radius  
Must be entered.

Conduit OD  
Must be entered.

Center Spacing  
The center to center spacing of the conduit in the rack.

# Entered Center Spacing

[Back](#)
**Answers**
[Help](#)

---

**Ninety Rack**

Start Bend ————— Conduit Length ————— Tail  
 | X | Travel | X |  
 Shoe Mark      Shoe Mark  
*Shoe Mark may be X distance on either side of bends*

Conduit Length —————  
 Travel  
*If Length is not entered then Conduit Length is to the end of the Travel*

---

**Select Number Format**

Decimal     1/16     1/32     Metric

---

**Entered**

Number Of Conduit	3
Bend Radius	9 "
Conduit OD	2 1/4"
Center Spacing	4 "
<b>Riser</b>	<b>12 "</b>
<b>Length</b>	<b>36 "</b>

---

**Answers**

<b>Conduit Number</b>	<b>1</b>
<b>Riser</b>	<b>12 "</b>
<b>Length</b>	<b>36 "</b>
<b>Conduit Length</b>	<b>41 7/8"</b>
<b>Tail</b>	<b>25 7/8"</b>
<b>Start Bend</b>	<b>1 7/8"</b>
<b>Travel</b>	<b>14 1/8"</b>

[Previous](#)
[Next](#)

[Segments](#)

[Bend Aid Menu](#)

The center to center spacing must be greater than the Conduit OD.

Riser

Must be entered.

Entered Riser

Must be greater than the Bend Radius plus 1/2 Conduit OD.

Entered Length

Must be greater than the Bend Radius plus 1/2 Conduit OD.

Tap OK to dismiss an alert.

Bottom Row

Answers

Tap to show the answers scene.

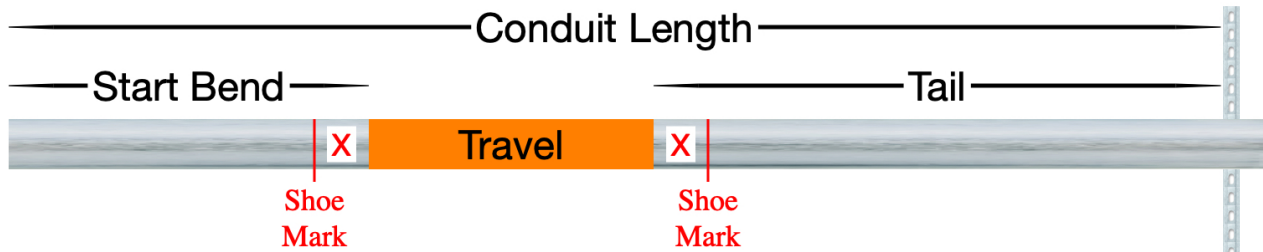

*Shoe Mark may be X distance on either side of bends*



*If Length is not entered then Conduit Length is to the end of the Travel*

Answer Ninety Rack

Answer Ninety Rack Help

The answers given for a rack of nineties allow the bend to be laid out and the conduit cut and threaded before the conduit is bent.

Mark the beginning and end of the bend so you can see exactly where they will be.

Find the center of the bend if needed for benders that bend from the middle of the bend.

Select Number Format

Tap a segment to select the format to display the answers.

The number format may be changed at any time which allows the different formats to be converted.



## Entered

The variables entered are displayed so they can be verified.

## Answers

### Conduit Number

The number of the conduit in the rack that the answers are being shown for.

### Riser

The new riser in the rack.

### Length

The new length in the rack.

### Conduit Length

The total length of conduit needed to make the ninety.

### Tail

The length of conduit from the finish of the bend to the length that was entered.

### Start Bend

The length from the end of the conduit to the start of the bend.

### Travel

The center line length of the arc of the bend.

## Bending A Rack Of Nineties

Layout the dimensions on the straight conduit.

Shoe Marks may be put on either side of any bend and the bend may be bent from either direction, once you have charted the bender being used and know how far from the bend the Shoe Mark should be.

If a pull through bender is being used then the Travel answer may be used to measure the Bend Angle by putting the conduit in the bender and marking the Travel from the back of the roller support.

If an old “Chicago” bender is being used then the weight of the handle will allow you to check the spring-back of the bend, pull the bend up to the Travel mark, let go of the handle and see if the conduit springs back, add more bend as needed.

If an electric chain driven bender is being used the spring-back must be guessed at.

If a push through bender is being used then layout the bends and find the centers of the bends.

If the offset needs to end at the second support then add the Tail length to the Start Bend length.

## Segments

Tap to go to the enter segment bend angle scene.

Top Left of Scene

Back

Tap to go back to the enter scene to change variables.

Bottom Row

Bend Aid Menu

Tap to go to the Bend Aid main menu.

# Enter Ninety Concentric

< Enter Help

**Ninety Concentric**

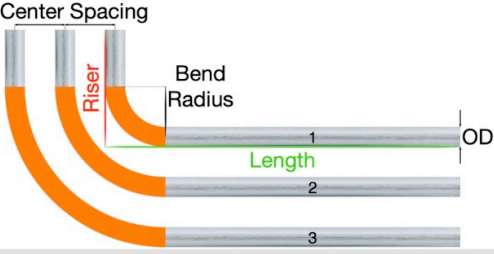

**Select Number Format**

Decimal 1/16 1/32 Metric

**Enter All**

Number Of Conduit	3
Bend Radius	2.25
Conduit OD	2.25
Center Spacing	4
Riser	12
Length	36

[Answers](#)

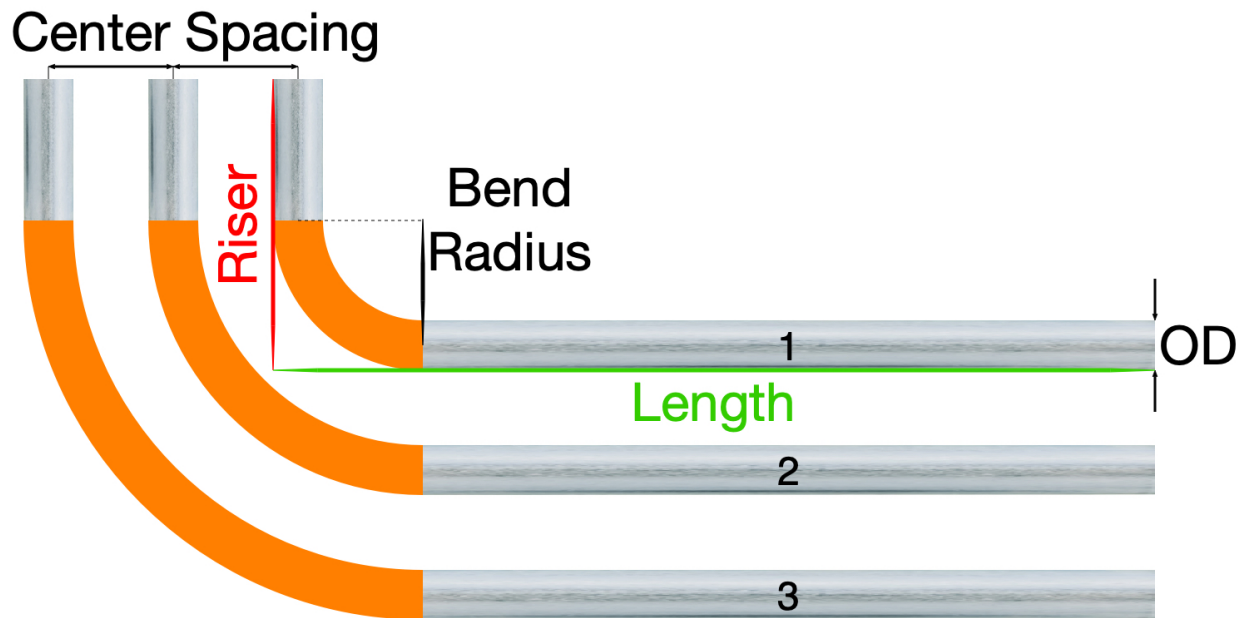

## Enter Ninety Concentric Help

Bend Aid solves a rack of concentric ninetyies by entering the required variables.

### Select Number Format

Tap a segment to select the number format.

### Enter All

#### Number Of Conduit

The number of conduit in the rack.

#### Bend Radius

The center line radius of the bends.

#### Conduit OD

The outside diameter of the conduit.

#### Center Spacing

The center to center spacing of the conduit in the rack.

Riser

The height of the ninety from the back of the bend.

Length

The length of the ninety from the back of the bend.

If length is not entered the answers will be to the finish of the bend.

Alerts

Alerts are shown after the Answers button is tapped if there is a problem with the entered variables or if the answers will not work.

Enter

Number Of Conduit

Must be entered.

Bend Radius

Must be entered.

Conduit OD

Must be entered.

Center Spacing

The center to center spacing of the conduit in the rack.

Entered Center Spacing

The center to center spacing must be greater than the Conduit OD.

Riser

Must be entered.

Entered Riser

Must be greater than the Bend Radius plus  $1/2$  Conduit OD.

Entered Length

Must be greater than the Bend Radius plus  $1/2$  Conduit OD.

Tap OK to dismiss an alert.

Bottom Row

Answers

Tap to show the answers scene.

# Answer Ninety Concentric

[Back](#)
**Answers**
[Help](#)

---

**Ninety Concentric**

Shoe Mark may be X distance on either side of bends

If Length is not entered then Conduit Length is to the end of the Travel

---

**Select Number Format**

Decimal
  1/16
  1/32
  Metric

---

**Entered**

Number Of Conduit	3
Bend Radius	2 1/4"
Conduit OD	2 1/4"
Center Spacing	4 "
Riser	12 "
Length	36 "

---

**Answers**

Conduit Number	1
Bend Radius	2 1/4"
Riser	12 "
Length	36 "
Conduit Length	44 13/16"
Tail	32 5/8"
Start Bend	8 5/8"
Travel	3 9/16"

---

[Previous](#)
[Next](#)

---

[Segments](#)

---

[Bend Aid Menu](#)

---



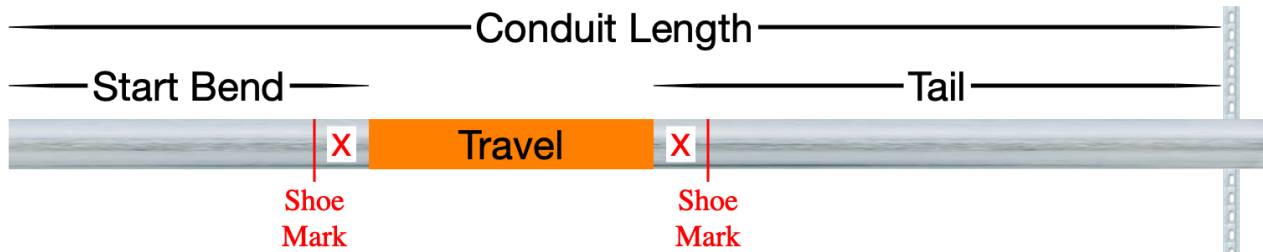

*Shoe Mark may be X distance on either side of bends*



*If Length is not entered then Conduit Length is to the end of the Travel*

## Answer Ninety Concentric Help

The answers given for a ninety allow the bend to be laid out and the conduit cut and threaded before the conduit is bent.

Mark the beginning and end of the bend so you can see exactly where they will be.

Find the center of the bend if needed for benders that bend from the middle of the bend.

## Select Number Format

Tap a segment to select the format to display the answers.

The number format may be changed at any time which allows the different formats to be converted.

## Entered

The variables entered are displayed so they can be verified.

## Answers

### Conduit Number

The number of the conduit in the rack that the answers are being shown for.

### Riser

The new riser in the rack.

### Length

The new length in the rack.

### Conduit Length

The total length of conduit needed to make the ninety.

### Tail

The length of conduit from the finish of the bend to the length that was entered.

### Start Bend

The length from the end of the conduit to the start of the bend.

### Travel

The center line length of the arc of the bend.

## Bending A Ninety

Layout the dimensions on the straight conduit.

Shoe Marks may be put on either side of any bend and the bend may be bent from either direction, once you have charted the bender being used and know how far from the bend the Shoe Mark should be.

If a pull through bender is being used then the Travel answer may be used to measure the Bend Angle by putting the conduit in the bender and marking the Travel from the back of the roller support.

If an old “Chicago” bender is being used then the weight of the handle will allow you to check the spring-back of the bend, pull the bend up to the Travel mark, let go of the handle and see if the conduit springs back, add more bend as needed.

If an electric chain driven bender is being used the spring-back must be guessed at.

If a push through bender is being used then layout the bends and find the centers of the bends.

If the offset needs to end at the second support then add the Tail length to the Start Bend length.

## Segments

Tap to go to the enter segment bend angle scene.

## Top Left of Scene

Back

Tap to go back to the enter scene to change variables.

Bottom Row

Bend Aid Menu

Tap to go to the Bend Aid main menu.

# Enter Ninety Back To Back

< Enter Help

Ninety Back To Back

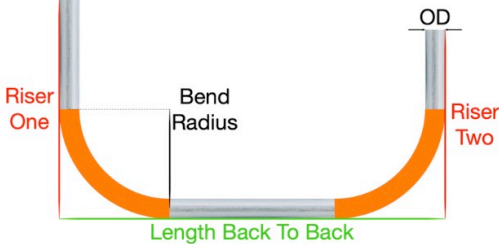

Select Number Format

Decimal 1/16 1/32 Metric

Enter All

Bend Radius	9
Conduit OD	2.25
Riser One	12
Length Back To Back	36
Riser Two	12

Answers

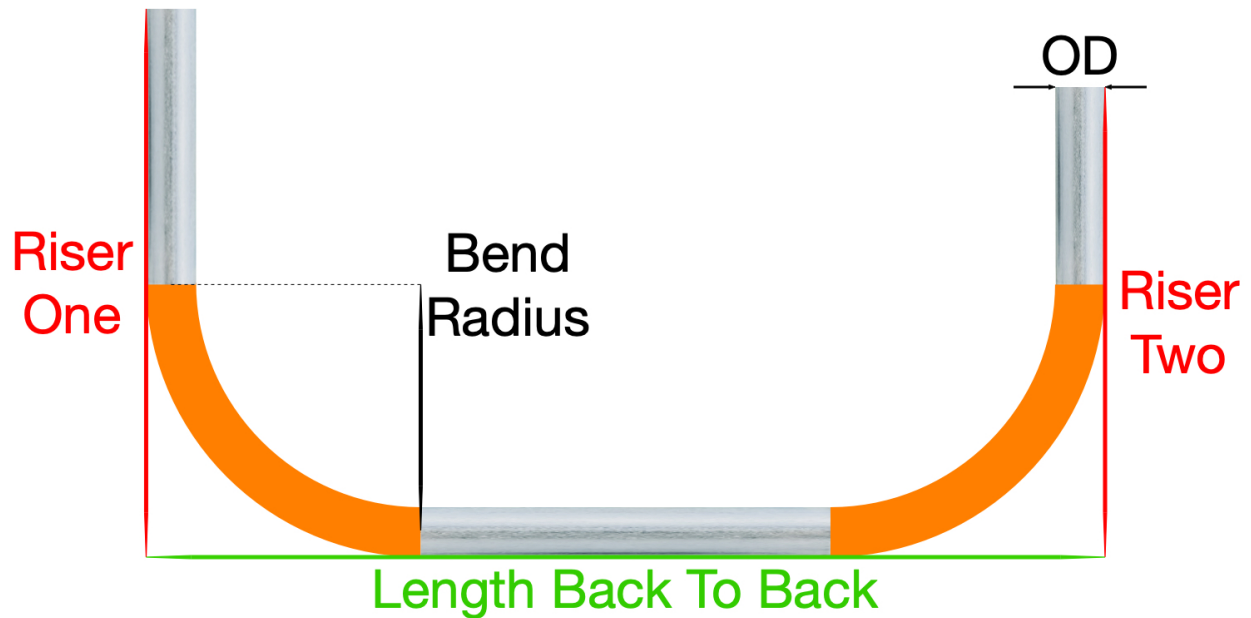

Enter Ninety Back To Back Help

Bend Aid solves back to back nineties by entering the required variables.

Select Number Format

Tap a segment to select the number format.

Enter All

Bend Radius

The center line radius of the bends.

Conduit OD

The outside diameter of the conduit.

Riser One

The height of the first ninety from the back of the bend.

Length Back To Back

The length of the ninety from the back of the first bend to the back of the second bend.

Riser two

The height of the second ninety from the back of the bend.

Alerts

Alerts are shown after the Answers button is tapped if there is a problem with the entered variables or if the answers will not work.

Enter

Bend Radius

Must be entered.

Conduit OD

Must be entered.

Riser One

Must be entered.

Entered Riser One

Must be greater than the Bend Radius plus  $1/2$  Conduit OD.

Length Back To Back

Must be entered

Entered Length Back To Back

Must be greater than two times the Bend Radius plus the Conduit OD.

Riser Two

Must be entered.

Entered Riser Two

Must be greater than the Bend Radius plus 1/2 Conduit OD.

Tap OK to dismiss an alert.

Bottom Row

Answers

Tap to show the answers scene.



# Answer Ninety Back To Back

[Back](#)
**Answers**
[Help](#)

---

**Ninety Back To Back**

Conduit Length  
 — Start Bend One — Start To Start One —  
 Shoe Mark X Travel One X Shoe Shoe X Travel Two X Shoe Mark  
*Shoe Mark may be X distance on either side of bends*  
 — Start To Start Two — Start Bend Two —  
 Shoe Mark X Travel One X Shoe Shoe X Travel Two X Shoe Mark

---

**Select Number Format**

Decimal	1/16	1/32	Metric
---------	------	------	--------

---

**Entered**

Bend Radius	9 "
Conduit OD	2 1/4 "
Riser One	12 "
Length Back To Back	36 "
Riser Two	12 "

---

**Answers**

Conduit Length	47 3/4 "
Start Bend One	1 7/8 "
Start To Start One	31 3/4 "
Start Bend Two	1 7/8 "
Start To Start Two	31 3/4 "
Travel	14 1/8 "

Segments

Bend Aid Menu

---

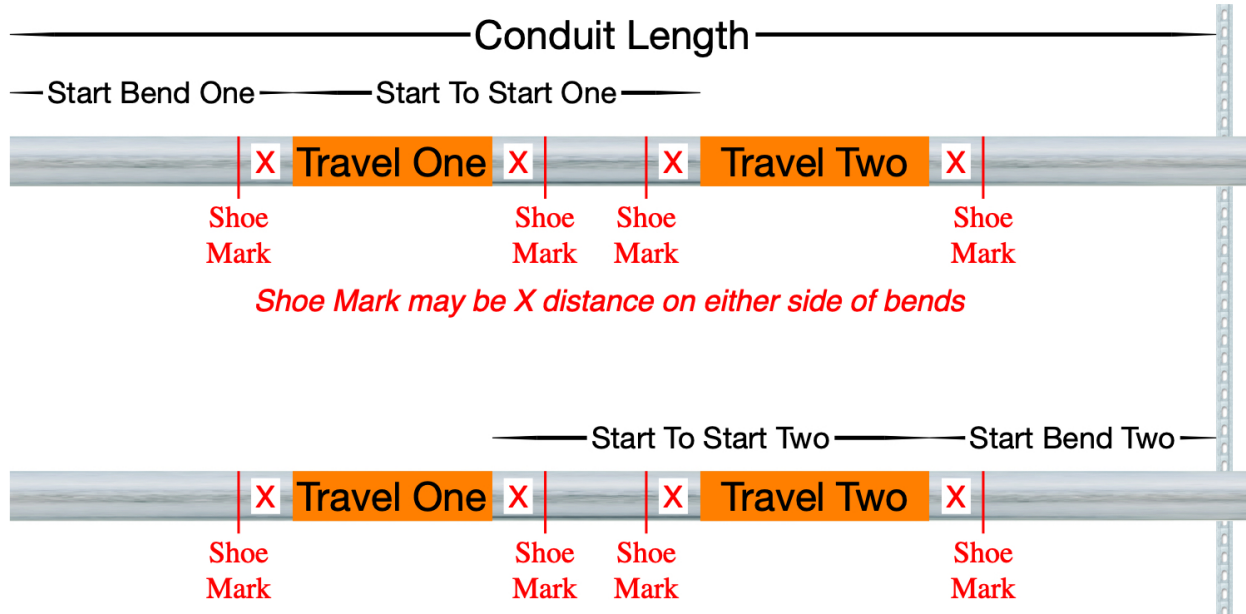

## Answer Ninety Back To Back Help

The answers given for a ninety back to back allow the bends to be laid out and the conduit cut and threaded before the conduit is bent.

Mark the beginning and end of both bends so you can see exactly where they will be.

Find the center of the bend if needed for benders that bend from the middle of the bend.

## Select Number Format

Tap a segment to select the format to display the answers.

The number format may be changed at any time which allows the different formats to be converted.

Entered

The variables entered are displayed so they can be verified.

## Answers

### Conduit Length

The total length of conduit needed to make the nineties.

### Start Bend One

The length from the end of the conduit to the start of the bend.

### Start To Start One

The length from the start bend one to the start bend two.

### Start Bend Two

The length from the other end of the conduit to the start of the bend.

### Start To Start Two

The length from the start bend two to the start bend one.

### Travel

The center line length of the arc of the bend.

## Bending Back To Back Nineties

Layout the dimensions on the straight conduit.

The answers are given to the second support, if you know how much farther the conduit goes then add that dimension, and cut and thread the conduit.

If you did not enter a Start Bend length then the Conduit Length is from the start of the first bend.

Shoe Marks may be put on either side of any bend and the bend may be bent from either direction, once you have charted the bender being used and know how far from the bend the Shoe Mark should be.

If a pull through bender is being used then the Travel answer may be used to measure the Bend Angle by putting the conduit in the bender and marking the Travel from the back of the roller support.

If an old “Chicago” bender is being used then the weight of the handle will allow you to check the spring-back of the bend, pull the bend up to the Travel mark, let go of the handle and see if the conduit springs back, add more bend as needed.

If an electric chain driven bender is being used the spring-back must be guessed at.

If a push through bender is being used then layout the bends and find the centers of the bends.

If the offset needs to end at the second support then add the Tail length to the Start Bend length.

## Segments

Tap to go to the enter segment bend angle scene.

## Top Left of Scene

### Back

Tap to go back to the enter scene to change variables.

## Bottom Row

### Bend Aid Menu

Tap to go to the Bend Aid main menu.

# Enter Ninety Back To Back Rack

< Enter Help

Ninety Back To Back Rack

The diagram illustrates a Ninety Back To Back Rack configuration. It shows three vertical conduits, each with a 90-degree bend at the top. The conduits are labeled 'Riser One' and 'Riser Two'. The distance between the centerlines of the two risers is labeled 'Center Spacing'. The distance from the centerline of a riser to the center of its bend is labeled 'Bend Radius'. The outer diameter of the conduit is labeled 'OD'. The distance between the centers of the two bends is labeled 'Length Back To Back'. The number of conduits is labeled '3'.

Select Number Format

Decimal 1/16 1/32 Metric

Enter All

Number Of Conduit	3
Bend Radius	9
Conduit OD	2.25
Center Spacing	4
Riser One	12
Length Back To Back	36
Riser Two	12

[Answers](#)

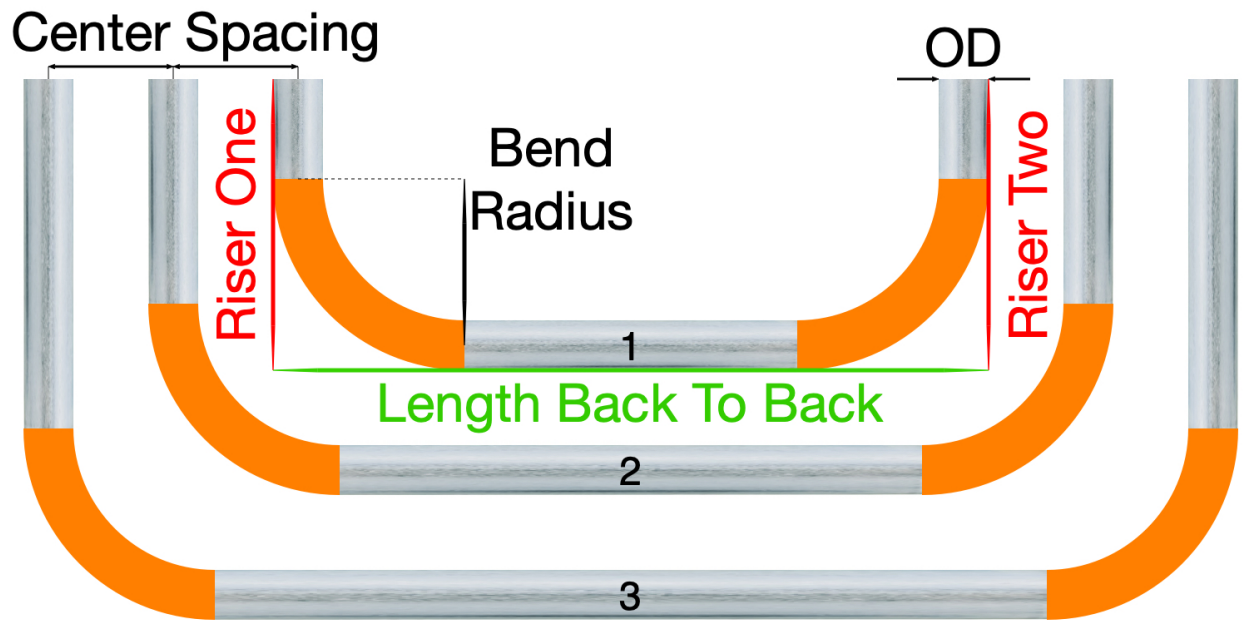

## Enter Ninety Back To Back Rack Help

Bend Aid solves a rack of back to back nineties by entering the required variables.

### Select Number Format

Tap a segment to select the number format.

### Enter All

#### Number Of Conduit

The number of conduit in the rack.

#### Bend Radius

The center line radius of the bends.

#### Conduit OD

The outside diameter of the conduit.

#### Center Spacing

The center to center spacing of the conduit in the rack.

### Riser One

The height of the first ninety from the back of the bend.

### Length Back To Back

The length of the ninety from the back of the first bend to the back of the second bend.

### Riser two

The height of the second ninety from the back of the bend.

### Alerts

Alerts are shown after the Answers button is tapped if there is a problem with the entered variables or if the answers will not work.

### Enter

Number Of Conduit  
Must be entered.

Bend Radius  
Must be entered.

Conduit OD  
Must be entered.

Center Spacing  
Must be entered.



Entered Center Spacing

Must be greater than the Conduit OD.

Riser One

Must be entered.

Entered Riser One

Must be greater than the Bend Radius plus  $1/2$  Conduit OD.

Length Back To Back

Must be entered

Entered Length Back To Back

Must be greater than two times the Bend Radius plus the OD.

Riser Two

Must be entered.

Entered Riser Two

Must be greater than the Bend Radius plus  $1/2$  Conduit OD.

Tap OK to dismiss an alert.

Bottom Row

Answers

Tap to show the answers.

# Answer Ninety Back To Back Rack

[Back](#)
**Answers**
[Help](#)

---

**Ninety Back To Back Rack**

---

**Select Number Format**

Decimal
  1/16
  1/32
  Metric

---

**Entered**

Number Of Conduit	3
Bend Radius	9 "
Conduit OD	2 1/4"
Center Spacing	4 "
Riser One	12 "
Length Back To Back	36 "
Riser Two	12 "

---

**Answers**

Conduit Number	1
Riser One	12 "
Length Back To Back	36 "
Riser Two	12 "
Conduit Length	47 3/4"
Start Bend One	1 7/8"
Start To Start One	31 3/4"
Start Bend Two	1 7/8"
Start To Start Two	31 3/4"
Travel	14 1/8"

---

[Previous](#)
[Next](#)

---

[Segments](#)

---

[Bend Aid Menu](#)

---

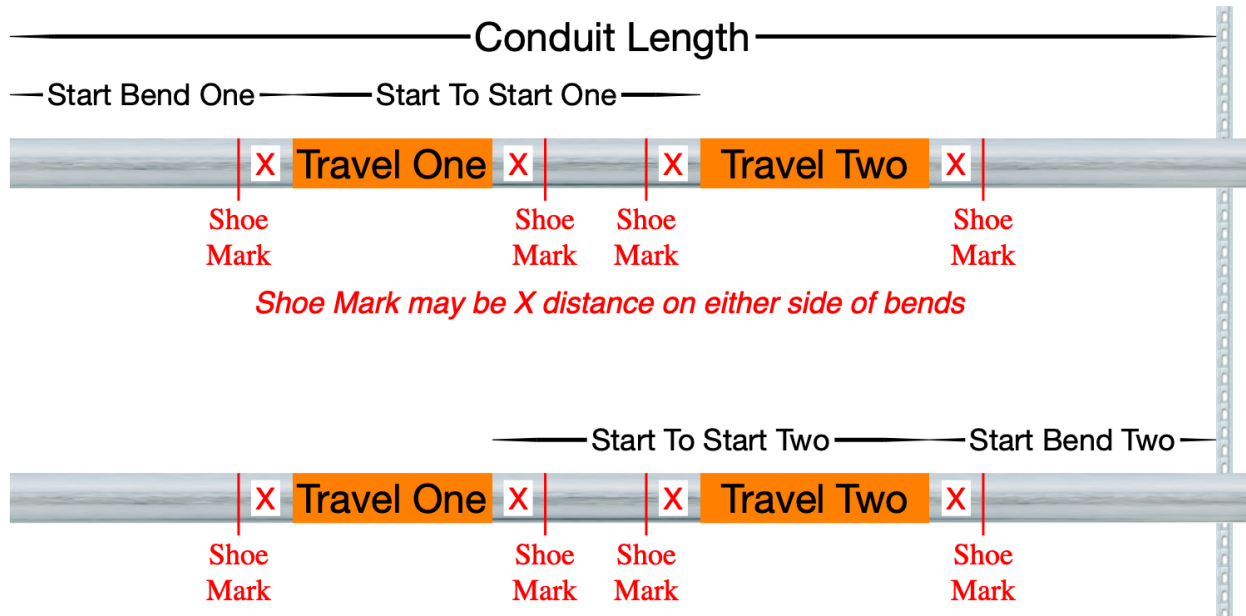

## Answer Ninety Back To Back Rack Help

The answers given for a rack of nineties back to back allow the bends to be laid out and the conduit cut and threaded before the conduit is bent.

Mark the beginning and end of both bends so you can see exactly where they will be.

Find the center of the bend if needed for benders that bend from the middle of the bend.

### Select Number Format

Tap a segment to select the format to display the answers.

The number format may be changed at any time which allows the different formats to be converted.

Entered

The variables entered are displayed so they can be verified.

## Answers

### Conduit Number

The number of the conduit in the rack that the answers are being shown for.

### Riser One

The new riser in the rack.

### Length Back To Back

The new length in the rack.

### Riser Two

The new riser in the rack.

### Conduit Length

The total length of conduit needed to make the nineties.

### Start Bend One

The length from the end of the conduit to the start of the bend.

### Start To Start One

The length from the start bend one to the start bend two.

### Start Bend Two

The length from the other end of the conduit to the start of the bend .

### Start To Start Two

The length from the start bend two to the start bend one.

### Travel

The center line length of the arc of the bend.

## Bending A Rack Of Back To Back Nineties

Layout the dimensions on the straight conduit.

The answers are given to the second support, if you know how much farther the conduit goes then add that dimension, and cut and thread the conduit.

If you did not enter a Start Bend length then the Conduit Length is from the start of the first bend.

Shoe Marks may be put on either side of any bend and the bend may be bent from either direction, once you have charted the bender being used and know how far from the bend the Shoe Mark should be.

If a pull through bender is being used then the Travel answer may be used to measure the Bend Angle by putting the conduit in the bender and marking the Travel from the back of the roller support.

If an old “Chicago” bender is being used then the weight of the handle will allow you to check the spring-back of the bend, pull the bend up to the Travel mark, let go of the handle and see if the conduit springs back, add more bend as needed.

If an electric chain driven bender is being used the spring-back must be guessed at.

If a push through bender is being used layout the bends and find the centers of the bends.

If the offset needs to end at the second support then add the Tail length to the Start Bend length.

## Segments

Tap to go to the enter segment bend angle scene.

## Top Left of Scene

### Back

Tap to go back to the enter scene to change variables.

## Bottom Row

### Bend Aid Menu

Tap to go to the Bend Aid main menu.

# Enter Ninety Back To Back Concentric

< Enter Help

**Ninety Back To Back Concentric**

**Select Number Format**

Decimal  1/16  1/32  Metric

**Enter All**

Number Of Conduit	3
Bend Radius	9
Conduit OD	2.25
Center Spacing	4
Riser One	12
Length Back To Back	36
Riser Two	12

[Answers](#)

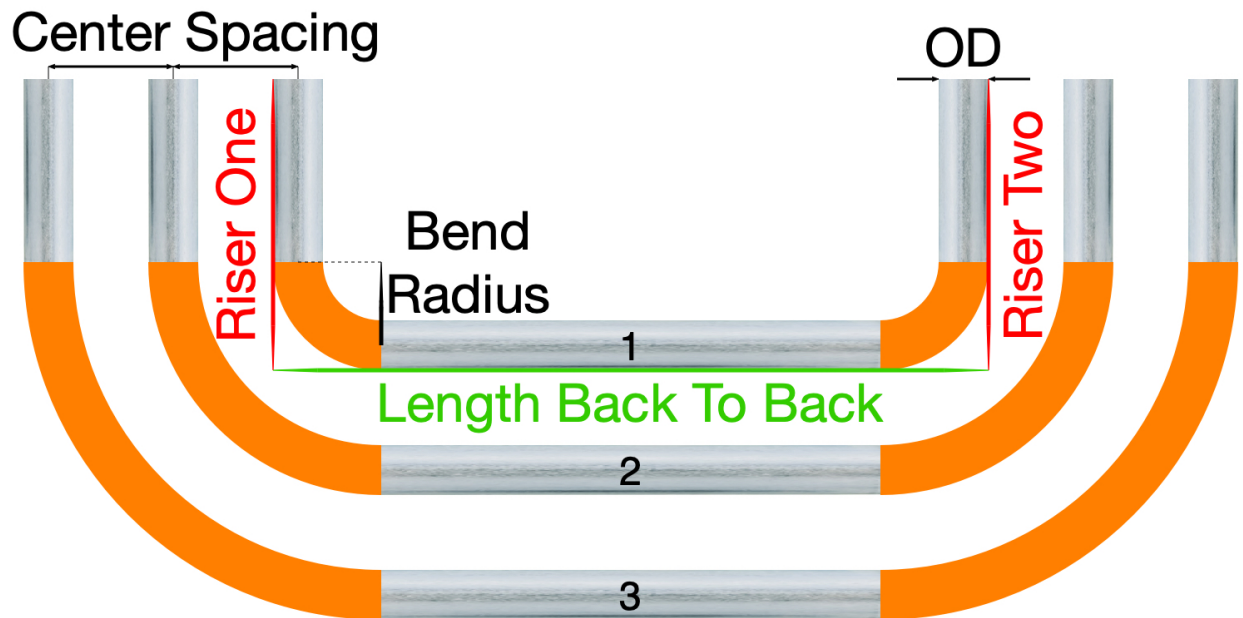

## Enter Ninety Back To Back Concentric Help

Bend Aid solves a rack of concentric back to back nineties by entering the required variables.

Select Number Format

Tap a segment to select the number format.

Enter All

Number Of Conduit

The number of conduit in the rack.

Bend Radius

The center line radius of the bends.

Conduit OD

The outside diameter of the conduit.

Center Spacing

The center to center spacing of the conduit in the rack.

Riser One

The height of the first ninety from the back of the bend.

Length Back To Back



The length of the ninety from the back of the first bend to the back of the second bend.

Riser Two

The height of the second ninety from the back of the bend.

Alerts

Alerts are shown after the Answers button is tapped if there is a problem with the entered variables or if the answers will not work.

Enter

Number Of Conduit

Must be entered.

Bend Radius

Must be entered.

Conduit OD

Must be entered.

Center Spacing

Must be entered.

Entered Center Spacing

Must be greater than the Conduit OD.

Riser One

Must be entered.

Entered Riser One

Must be greater than the Bend Radius plus  $1/2$

Conduit OD.

Length Back To Back

Must be entered.

Entered Length Back To Back

Must be greater than two times the Bend Radius plus the Conduit OD.

Riser Two

Must be entered.

Entered Riser Two

Must be greater than the Bend Radius plus 1/2 Conduit OD.

Tap OK to dismiss an alert.

Bottom Row

Answers

Tap to show the answers.

# Answer Ninety Back To Back Concentric

[Back](#)

Answers

[Help](#)

## Ninety Back To Back Concentric

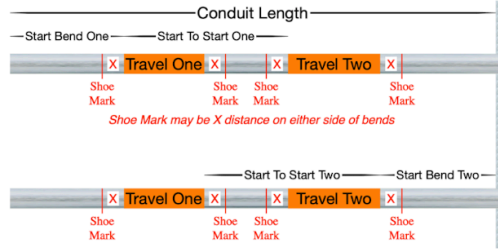

### Select Number Format

Decimal

1/16

1/32

Metric

### Entered

Number Of Conduit	3
Bend Radius	9 "
Conduit OD	2 1/4 "
Center Spacing	4 "
Riser One	12 "
Length Back To Back	36 "
Riser Two	12 "

### Answers

Conduit Number	1
Bend Radius	9 "
Riser One	12 "
Length Back To Back	36 "
Riser Two	12 "
Conduit Length	47 3/4 "
Start Bend One	1 7/8 "
Start To Start One	31 3/4 "
Start Bend Two	1 7/8 "
Start To Start Two	31 3/4 "
Travel	14 1/8 "

[Previous](#)

[Next](#)

[Segments](#)

[Bend Aid Menu](#)

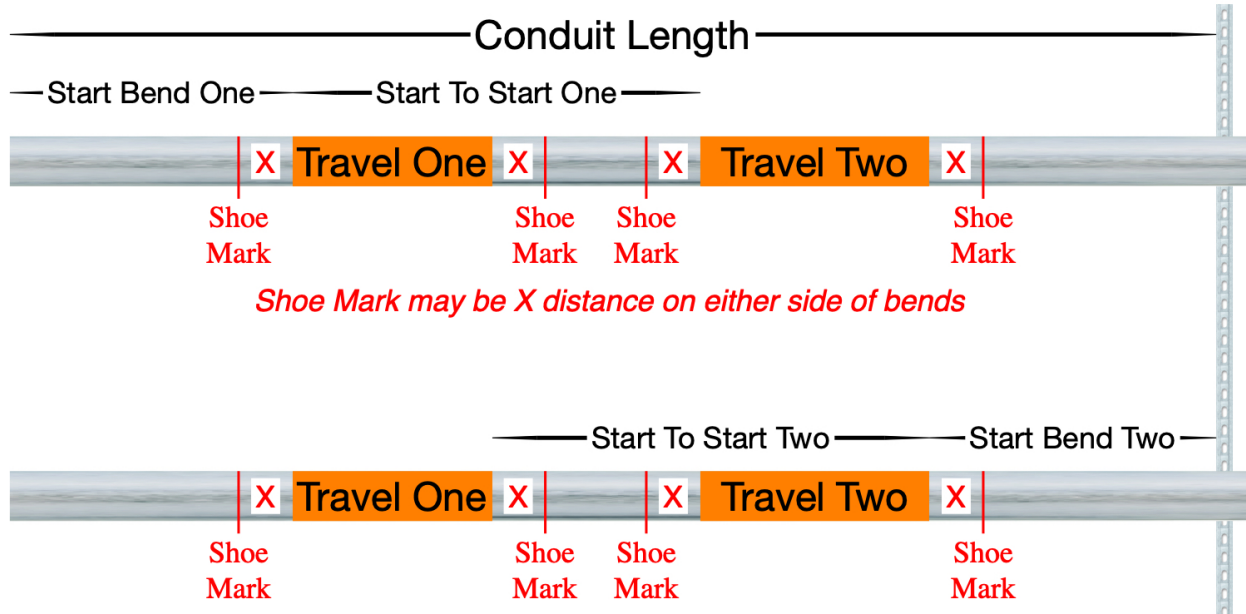

## Answer Ninety Back To Back Concentric Help

The answers given for a ninety allow the bends to be laid out and the conduit cut and threaded before the conduit is bent.

Mark the beginning and end of both bends so you can see exactly where they will be.

Find the center of the bend if needed for benders that bend from the middle of the bend.

### Select Number Format

Tap a segment to select the format to display the answers.

The number format may be changed at any time which allows the different formats to be converted.

Entered

The variables entered are displayed so they can be verified.

## Answers

### Conduit Number

The number of the conduit in the rack that the answers are being shown for.

### Bend Radius

The radius of the conduit in the rack.

### Riser One

The new riser in the rack.

### Length Back To Back

The new length in the rack.

### Riser Two

The new riser in the rack.

### Conduit Length

The total length of conduit needed to make the nineties.

### Start Bend One

The length from the end of the conduit to the start of the bend.

### Start To Start One

The length from the start bend one to the start bend two.

## Start Bend Two

The length from the other end of the conduit to the start of the bend .

## Start To Start Two

The length from the start bend two to the start bend one.

## Travel

The center line length of the arc of the bend.

## Bending Concentric Back To Back Nineties

Layout the dimensions on the straight conduit.

The answers are given to the second support, if you know how much farther the conduit goes then add that dimension, and cut and thread the conduit.

If you did not enter a Start Bend length then the Conduit Length is from the start of the first bend.

Shoe Marks may be put on either side of any bend and the bend may be bent from either direction, once you have charted the bender being used and know how far from the bend the Shoe Mark should be.

If a pull through bender is being used then the Travel answer may be used to measure the Bend Angle by putting the

conduit in the bender and marking the Travel from the back of the roller support.

If an old “Chicago” bender is being used then the weight of the handle will allow you to check the spring-back of the bend, pull the bend up to the Travel mark, let go of the handle and see if the conduit springs back, add more bend as needed.

If an electric chain driven bender is being used the spring-back must be guessed at.

If a push through bender is being used then layout the bends and find the centers of the bends.

If the offset needs to end at the second support then add the Tail length to the Start Bend length.

## Segments

Tap to go to the enter segment bend angle scene.

## Top Left of Scene

### Back

Tap to go back to the enter scene to change variables.

## Bottom Row

### Bend Aid Menu

Tap to go to the Bend Aid main menu.

# Enter Find Bend Radius



Enter

Help

## Find Bend Radius

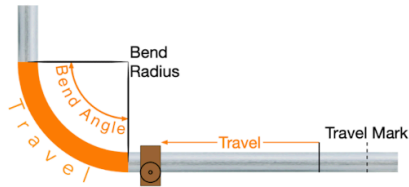

Place a travel mark farther than what the travel might be.  
When ninety is finished find the actual Travel.

## Select Number Format

Decimal

1/32

Metric

## Enter All

Travel

14 <sup>1</sup>/<sub>8</sub>"

Bend Angle

90

[Answers](#)



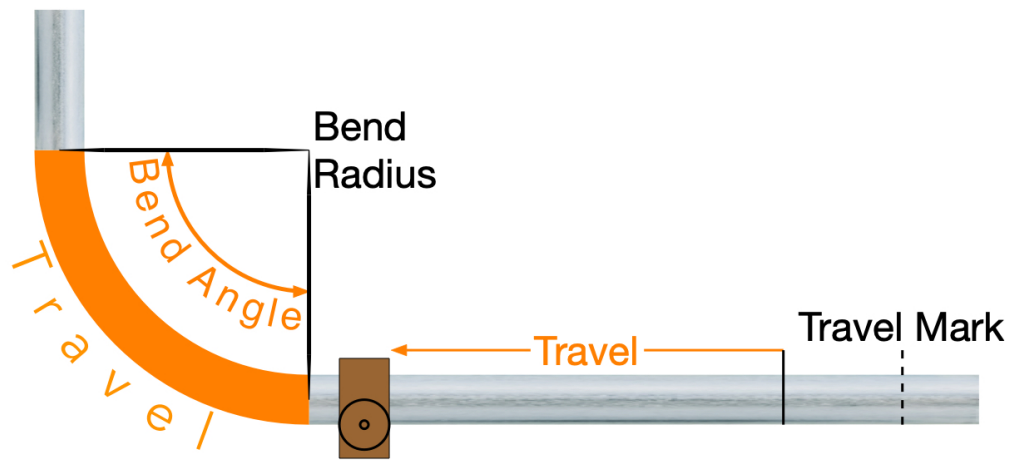

Place a travel mark farther than what the travel might be.  
When ninety is finished find the actual Travel.

## Enter Find Bend Radius Help

Bend Aid will find an unknown Bend Radius by bending a 90° bend and measuring the travel it took to bend.

Any angle may be bent but a ninety is more accurate and a short ninety should be useable some where.

## Select Number Format

Tap a segment to select the number format.

## Enter All

### Travel

Travel is the length of the bend arc, some people call it developed length.

### Bend Angle

Is the degrees of bend for the travel entered.

## Alerts

Alerts are shown after the Answers button is tapped if there is a problem with the entered variables or if the answers will not work.

### Enter

Travel

Must be entered.

Bend Angle

Must be entered.

Entered Bend Angle

Must be less than  $90^\circ$ .

Tap OK to dismiss an alert.

## Bottom Row

Answers

Tap to show the answers scene.

# Answer Find Bend Radius

[Back](#)

Answers

[Help](#)

## Answers Find Bend Radius

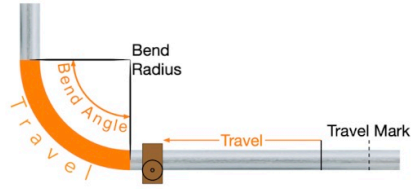

Place a travel mark farther than what the travel might be.  
When ninety is finished find the actual Travel.

## Select Number Format

Decimal

1/16

1/32

Metric

## Entered

Travel 14 <sup>1</sup>/<sub>8</sub>"

Bend Angle 90 °

## Answers

Bend Radius 9 "

[Bend Aid Menu](#)

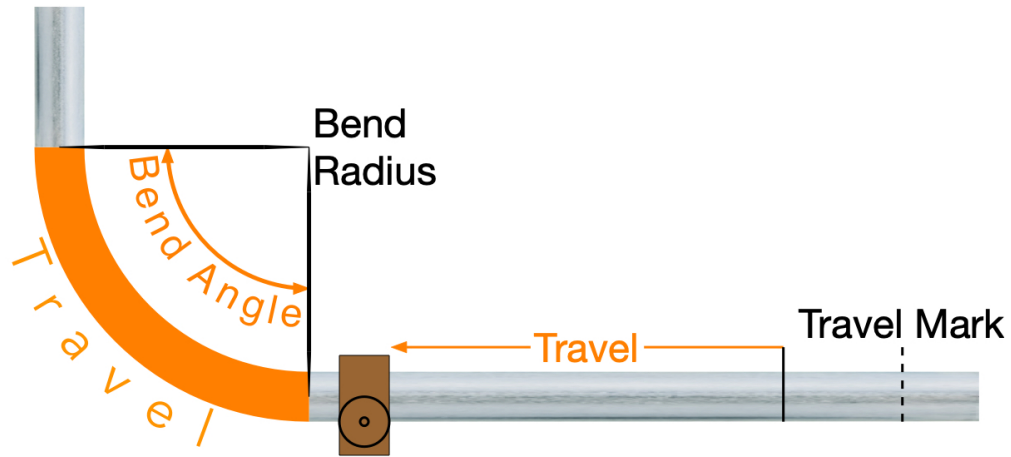

Place a travel mark farther than what the travel might be.  
When ninety is finished find the actual Travel.

## Answer Find Bend Radius Help

The answer given is the center line radius of the bender shoe.

## Select Number Format

Tap a segment to select the desired number format.

## Entered

Travel

Travel is the length of the bend arc, some people call it developed length.

## Bend Angle

Is the degrees of bend for the travel entered.

## Answer

Bend Radius

The center line radius of the bender shoe.

Bottom Row

Bend Aid Menu

Tap to go to the Bend Aid main menu.

## Chart Benders

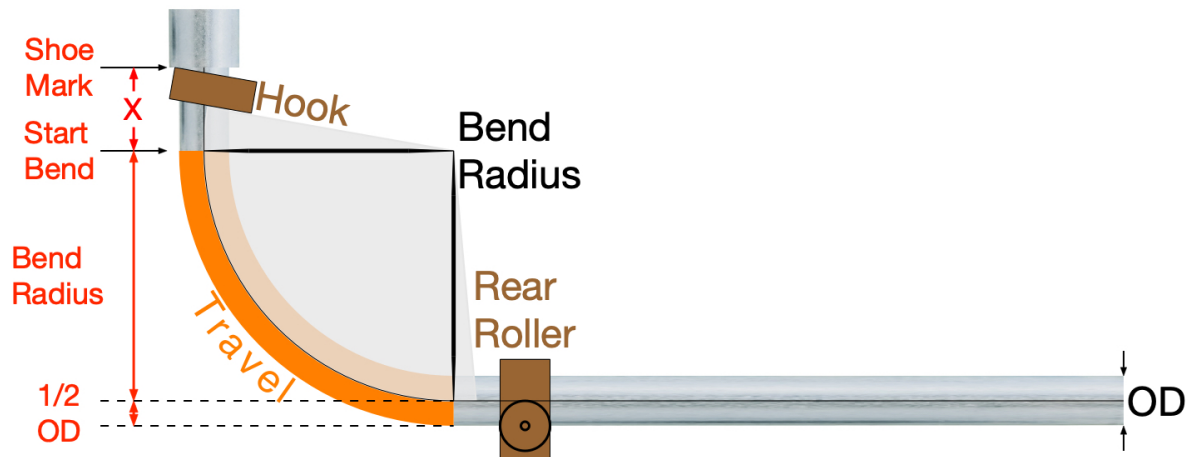

$X = \text{Distance between Shoe Mark and Start Bend}$   
 $\text{Start Bend} = \text{Bend Radius} + \frac{1}{2} OD$

Charting a bender means to find the dimensions that the bender uses.

Bend a 90° bend and measure the results.

Any angle may be bent but a short ninety should be useable some where.

### Shortest Ninety

Measure the minimum ninety that can be bent to the Shoe Mark from the back of the ninety.

X Is the Shoe Mark to Start Bend distance

When the conduit is in the bender but before bending, mark the conduit where the shoe mark is, it could be an arrow, or the end of the hook , or a roller.

Once X is known any bend can be started at the Start Bend.

If a push through bender is being used then layout where the bends will be on the straight conduit and find the center of any bend.

### Start Bend

Is from the back of the ninety to where the ninety actually starts to bend.

$$\text{Start Bend} = \text{radius} + 1/2 \text{ the conduit OD}$$

### Bend Radius

Most bender shoes will have their centerline bend radius marked somewhere, maybe on the back side of the shoe, or on a chart on the bender, or in the storage box.

### Travel

On a pull through bender measure how far the conduit is pulled through, or travels, when bending a 90°, or estimate what the travel will be and place a mark so the travel can be found.

Use the Rear Roller on the bender, or some other stationary place, as a standard point when using the Travel answers to make bends.

Since the Start Bend to Shoe Mark is a constant on a pull through bender the Travel for any Bend Angle can be used to make the bend.

Use the Travel answer, for whatever Bend Angle, and put a Travel Mark on the conduit.

Make the bend until the Travel Mark reaches the roller or stationary point.

Check for spring-back.

On a “Chicago” type bender when the pressure on the handle is released the conduit might spring-back, add more bend until the Travel Mark is at the Rear Roller. On a “Chicago” type bender when the pressure on the handle is released the conduit might spring-back, add more bend until the Travel Mark is at the Rear Roller.



# Enter Segments



## Segments

[Help](#)

Segments are equal sections of the Travel bent on small angles plus a smaller segment to complete the total bend angle

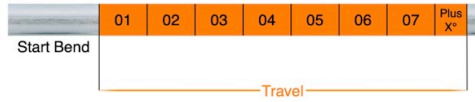

### Select Segment Bend Angle

1 2 3 4 5 6 7 8 9

5

Answers

Segments are equal sections of the Travel bent on small angles plus a smaller segment to complete the total bend angle



## Enter Segments Help

When the Bend Radius is larger than the bend radius of a standard bending shoe then the bend can be made by putting an equal number of smaller bends, or segments, until the whole bend angle is completed.

The travel is divided into a number of segments with any left over degrees added to the end of the bend.

For example a twenty-five degree bend angle could be made with seven three degree bends plus a four degree bend or three six degree bends plus a one degree bend.

$$7 \times 3^\circ = 21^\circ + 4^\circ = 25^\circ$$

or

$$3 \times 6^\circ = 24^\circ + 1^\circ = 25^\circ$$

## Select Segment Bend Angle

The segment bend angle is the small angle that each segment will be bent on.

The smaller the segment bend angle the smoother the bend will look.

The selected segment bend angle will depend on how big the bend radius is and how close the segments will be.

Bottom Row

Answers

Tap to show the answers scene.

After the Answers button is tapped and the answers view is displayed the length of each segment can be checked to see if it will work.

Go back to the enter segment bend angle scene to change the segment bend angle until an acceptable segment bend angle is found.

# Answer Segments

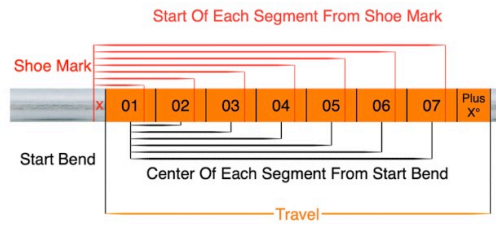

Start Bend	18 "
Segment 01	$1\frac{3}{16}$ "
Segment 02	$1\frac{9}{16}$ "
Segment 03	$2\frac{3}{8}$ "
Segment 04	$3\frac{1}{8}$ "
Plus 1°	$\frac{3}{16}$ "

[Bend Aid Menu](#)

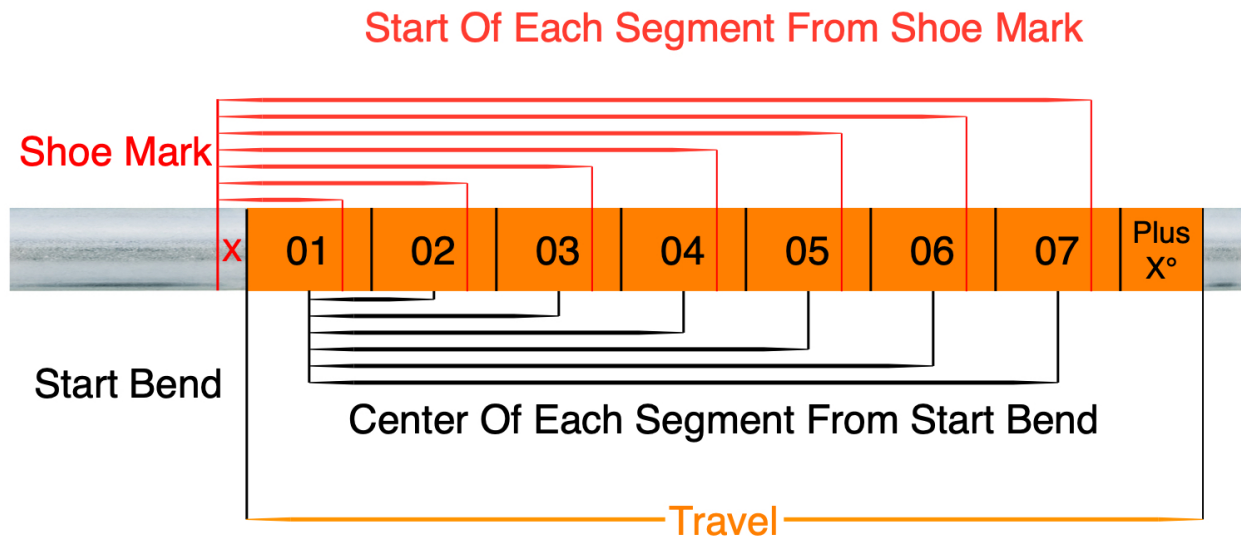

## Answer Segments Help

The answers given for segments allow the bend to be laid out and bent, or checked to make sure the bends will fit in the bender or the segment bends will not run into each other.

The answer for each segment is measured from the start bend.

Laying out the first shoe mark may make it easier to measure to each segments shoe mark.

If the bender bends from the middle of the bend then lay out the center of the first segment and then use the answer segments to measure to each segment center.

As you layout each conduit in a rack each of the conduit numbers may have different answers, the Bend Radius and the Travel may increase or decrease.

The answers are given in the number format that was selected in the answer view.

## Answers

### Start Bend

The start bend that was entered or solved.

### Each Segment Length

The length of each segment, or the travel of each segment if the travel method is used to make the bends.

The segment lengths are from the start bend, or the first shoe mark, or the center of the first bend.

Measuring from one point allows accurate measurements to all the segments.

The Plus answer is the extra degrees needed to complete the total bend angle.

## Top Left of Scene

### Segments

Tap to go back to the enter scene to change the segment bend angle.

## Bottom Row

### Bend Aid Menu

Tap to go to the Bend Aid main menu.