

since 1999

Flight
Cases
&

IN factory and Warehousing

Power
supply

Favored by more than 600 customers

exported to many countries
with an area of 800 square meters

system
& Stage Effects

Extensive experience in stage equipment



IN STGAE

Since 1999

www.instage.cc

Hangzhou IN stage equipment Co.,Ltd

Guangzhou IN stage equipment Co.,Ltd

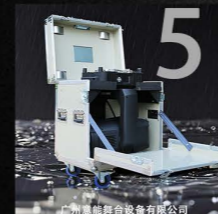

waterproof



Customized



Build your system



power boxes



Stage effects

IN 意能舞台

Guangzhou IN stage equipment Co.,Ltd

Gmail: instagechina@gmail.com

WhatsApp: +86 173-0099-7560

WeChat: +86 138-5713-7888

Website: www.instage.cc



WhatsApp
+86 17300997560

About us

Yineng(IN) Stage Equipment Co., Ltd.

flight cases



power boxes



power system



In the production system of Yineng stage equipment, the three major production lines specially customized by **Guangzhou factory(IN FACTOEY)** for you are well received by our customers, namely the flight box production line, the power box production line and the power system production line.

Hangzhou Base provides you with professional lamp sales, rental and maintenance services, as a stage lighting manufacturer, accurate lamp recommendation and perfect after-sales service, radiating customers in Jiangsu, Zhejiang and Shanghai, China.



27 years

The company was founded in 1998.

600+

The number of cooperative customers exceeds 600.

800 m²

The usable area of the factory is 800 square meters.

Why choose us?

Catalogue 意能舞台

IN Factory & lamp agent

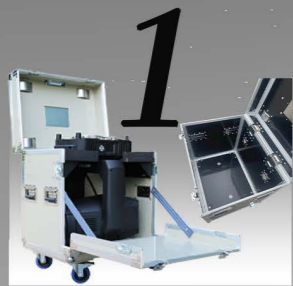

01| Waterproof series

Aviation box (flight case) made of plastic sheets and waterproof fabrics are currently being widely used in the stage performance industry.

page 5-6



02| Build your flight cases

The flight case made of richly colored wooden boards, aluminum strips, and accessories is quite recognizable and adds color to work and life.

page 17-18



03| Customized series

Showcasing some customer-made flight boxes, such as putting a refrigerator, microwave, coffee machine into a box, these products are more practical and lifey.

page 7-10

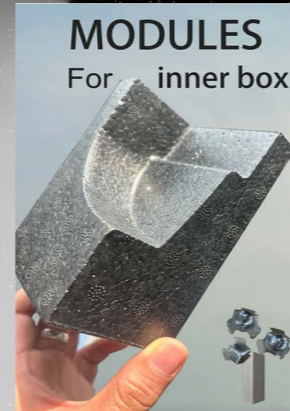

04| professional series

From the perspective of the factory, we will take you to observe the high-precision manufacturing process and the ingenious combination of machinery and manual work from the inside out of the box.

page 11-16



01| Waterproof series

Name: MC-FS06
Parameter: 6*16A
waterproof rating: IP40

page28



02| MC-NQK0620

Name: MC-NQK0620
Parameter: 6*20A
waterproof rating: IP20

page27



03| MC-JMS0610

Name: MC-JMS0610
Parameter: 6*10A
waterproof rating: IP20

page27



04| Application

This page will display the connection diagram of the Waterproof Mini Six-circuit (Device), which is connected to a four-circuit power distribution box. Welcome to check it out.

page29-30



01| Power controller

This detailed presentation showcases our factory's four models of electric hoist controllers, available in 4-channel, 8-channel, 12-channel, and 24-channel configurations. Ranging from hand-held to hand-pushed carrying modes, there is always one model that suits your needs.

page19-22



02| Signal amplifier

DMX(RDM) 512-8-channel signal amplifiers produced by our factory are packaged in combinations of 2 units and 4 units, and the flight cases used for packaging are also custom-made by our factory.

page23-24



03| Build your system

Your stage equipment system consists of 4 components: the power supply system responsible for providing power, the custom flight cases for storage and transportation, the lighting equipment for creating stage effects, and the indispensable accessory tools.

page25-34



04| Digital conditioner

Showing the bakelite digital pass-through units and the three latest models of panels produced by our factory. You can scan the QR code with your mobile phone to check the product manual.

page35-36



01| HIVE-8ways

8CH+32A power box,
Size (L*W*H):
525 * 535 * 380 mm
Weight 27KG

page29



02| HIVE-12ways

IP44 waterproof
10U 12CH+4*32A
Size (L*W*H):
600 * 700 * 670 mm
Weight 40KG

page31-32



03| 13U 24CH+2*32A

IP44 waterproof
13U 24CH+2*32A
leakage-protected
Size (L*W*H):
600 * 700 * 759 mm
Weight 61.5KG

page31



04| customized series

In this chapter, we will showcase some products specially customized for customers. Welcome to check them out.

page33-34

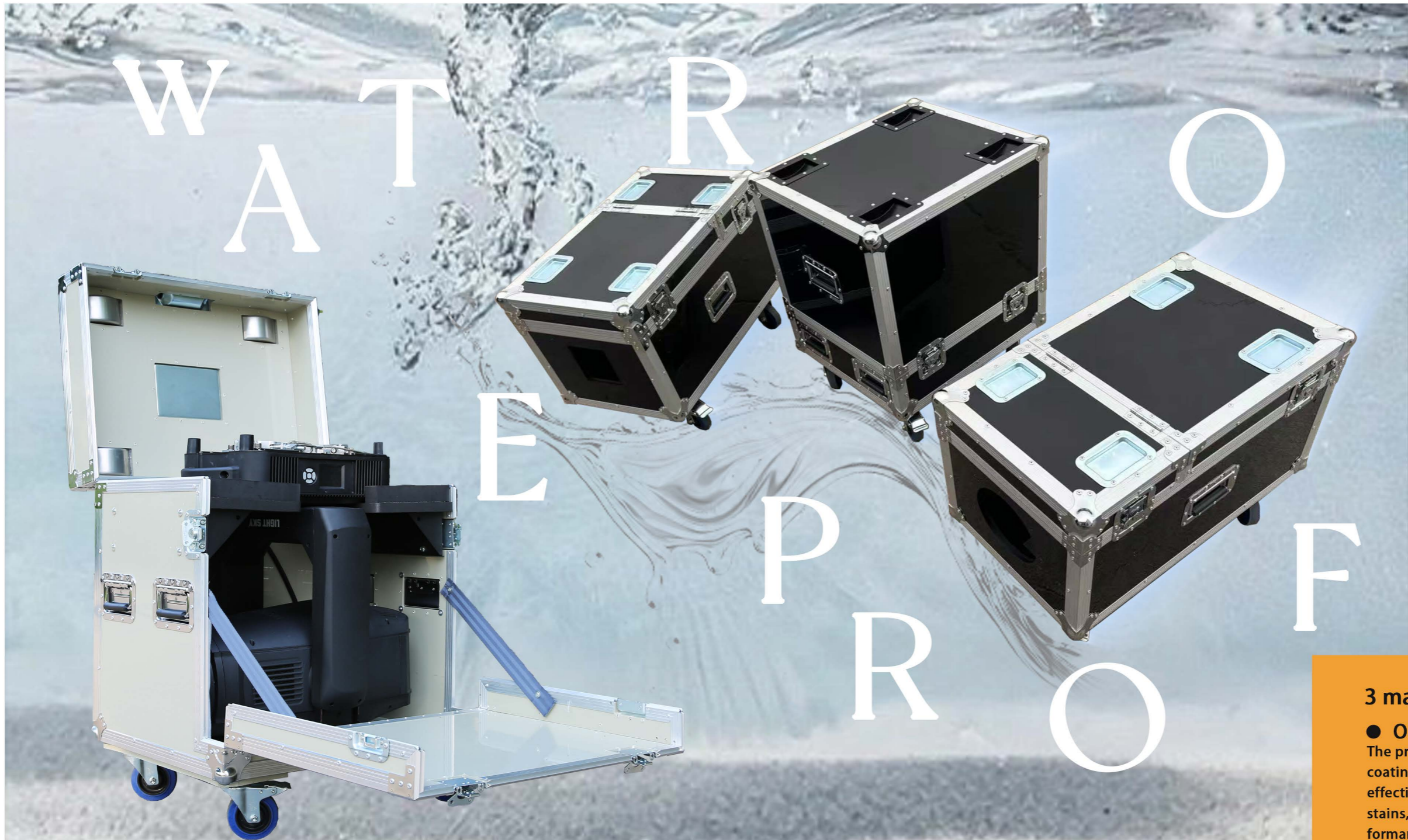

IP68
waterproof rating

4
special processes

3
product performance

3 major product performance

● **Oil-proof**

The product is made of plastic plate and metal coating, and the special coating on the surface can effectively invade the inside of the box with oil stains, achieving a clean effect and making the performance cleaner and easier.

● **Anti-fouling**

The product adopts the method of looking at the machine opening, and cuts out round or square hollows (heat dissipation holes and drainage holes) on the facade and bottom of the box respectively, so that the lamps can be installed and used without waiting.

● **Be waterproof**

The waterproof rating of the whole case is IP68, which means that it can also be well protected for equipment and transportation in the rainy season.

4 special processes

The outer cabinet adopts a mold structure.

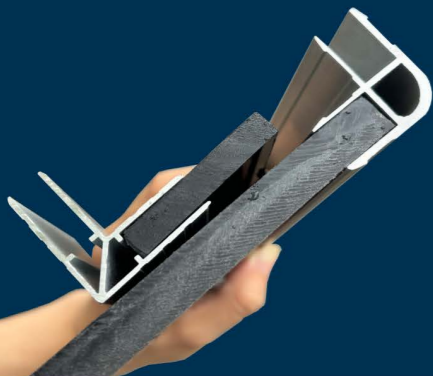

The interior is fixed with plastic wool.

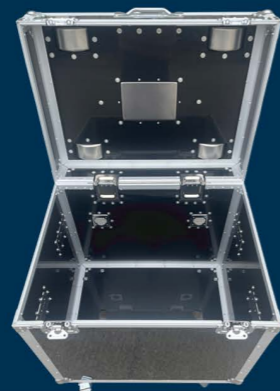

The facade of the box has heat dissipation holes.



Drainage holes are made on the bottom of the box.

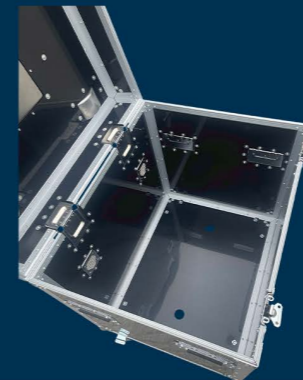

COLOURS

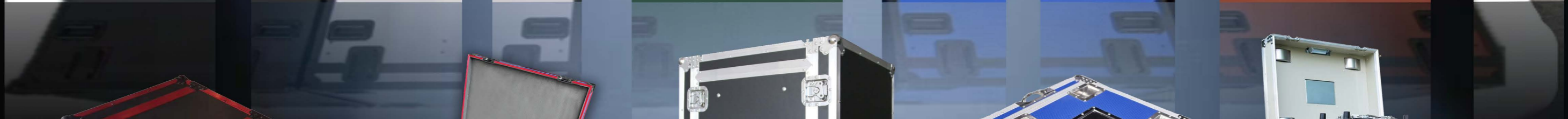

7 **Red & Black** **Red & Black & Blue** classic **Blue & White** **Grey & White** 8

01

Name: Mobile storage bins
Size: Half a person tall
Weight: 35KG



02

Name: Mobile wardrobe
Size: Just the height of a person
Weight: 60KG



Mobile wardrobe
IN factory

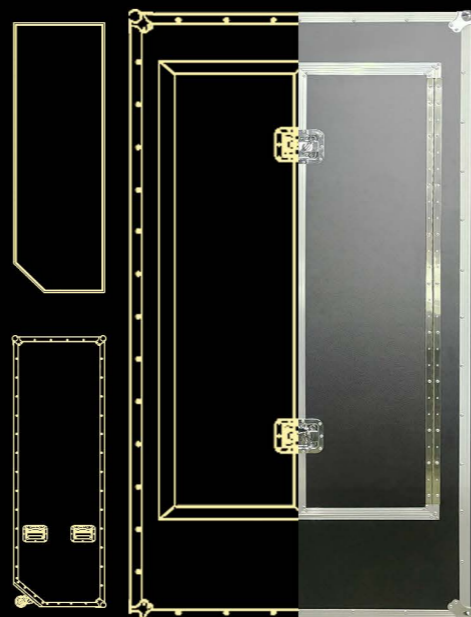

Customized.

The lid can be turned
into a table !!

03

Name:
Mobile energy station

This design allows us to
carry energy replenish-
ment tools such as refrig-
erators, coffee machines,
microwave ovens, etc.



Application of inner box cotton

EPP and EVA

In order to better store and protect the stored items in storage and transportation, the various shapes of cotton and foam products used in our factory play a big role.

First, we will start with a small piece of foam cotton and compress the foam to the hardness and shape we need through the mold, which allows for great flexibility in the design, as shown in the figure.



EVA

①

The second is the production method of EVA cotton utensils, which is commonly cut by machines, and



②

protects objects from collision damage when used in large areas, and can play a role in limiting the

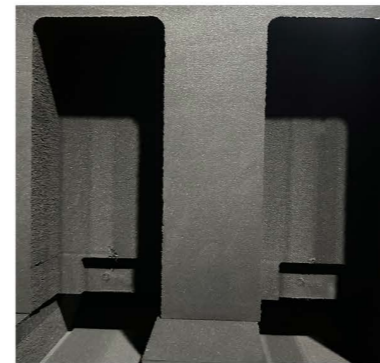

③

position of objects when using special-shaped molds in small areas.

——IN factory



EPP

Fixed splitting

Application of inner box plate

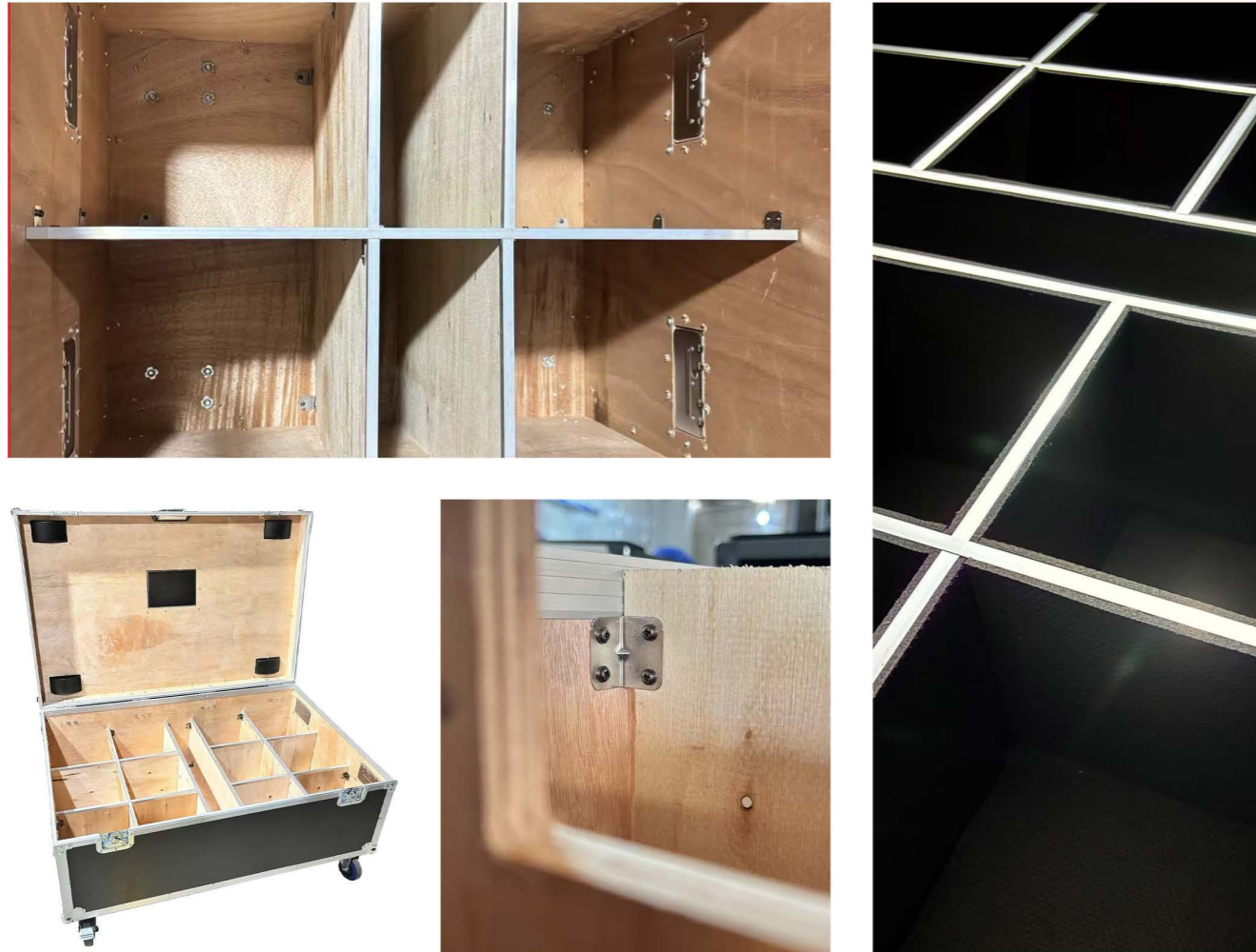

There are two ways to fix the partition plate inside the airbox, namely mechanical connection and bonding

Mechanical connection fixing is the basic solution, connecting the divider to the frame inside the box by means of screws, rivets or buckles.

Bonding is suitable for lightweight scenarios, using high-strength industrial adhesive to bond the board to the box wall, suitable for the box without internal frame, which can reduce the weight increase caused by metal connectors, but it is more difficult to adjust or replace the plate later.

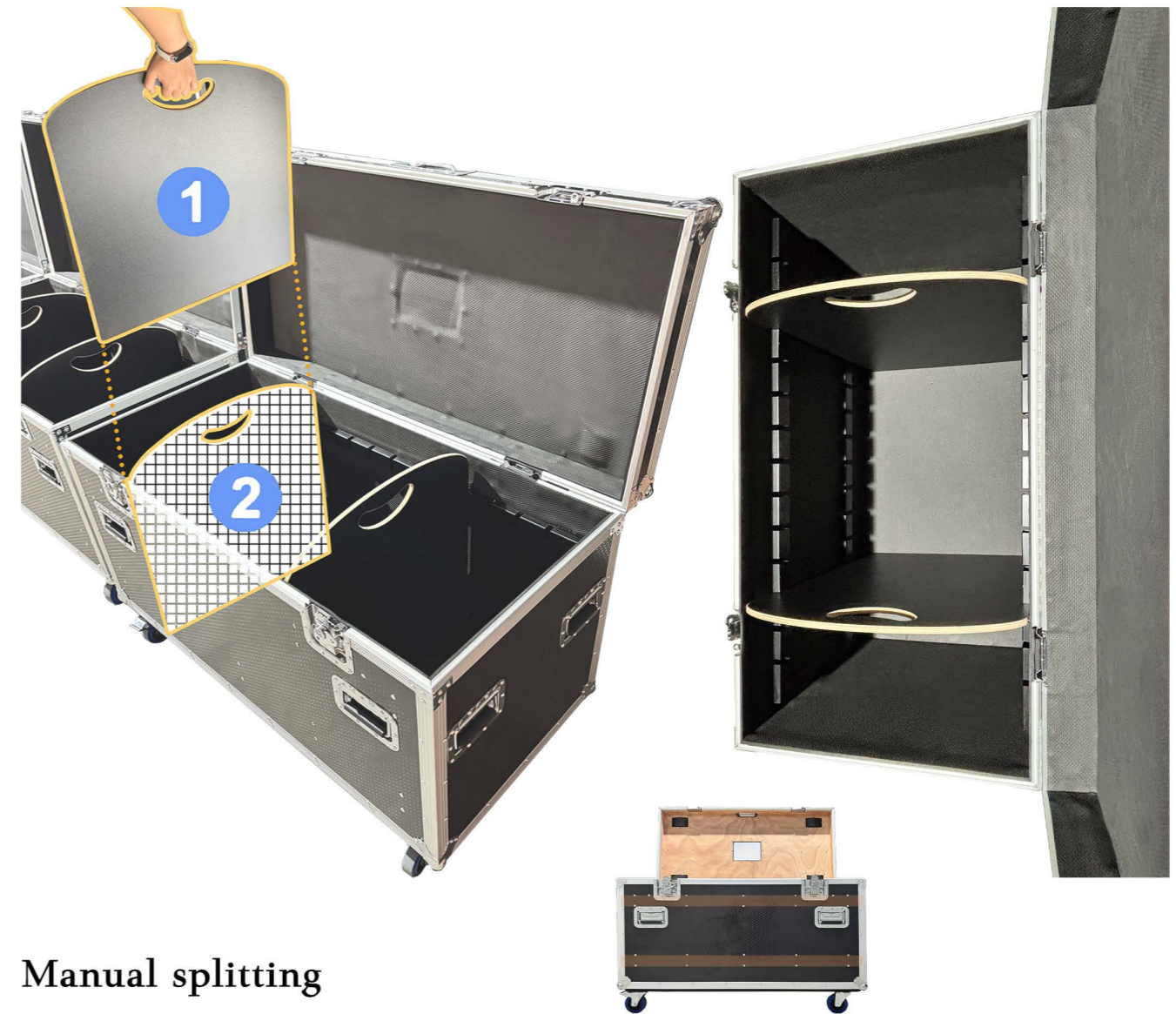

Manual splitting

Application of inner box plate

In the figure above, we use the active card slot plate and the fixed card slot strip to achieve the effect of manually dividing the storage space.

Some boxes are designed with preset card slots, and the divider is locked with locating pins after inserting into the card slot, which is quick to install and not easy to shift. In practical applications, two methods are often combined, such as reinforcing key parts with screws and secondary areas supplemented by bonding, which can not only ensure the overall stability, but also take into account the convenience of operation, and meet the core requirements of impact resistance and anti-shaking in stage equipment transportation.

Combination of accessories



Ball bag
wheel socket
Wheel nest pad

The image above shows two shapes of ball bags, namely rounded and right-angled ball bags. Both bags have good wrapping and impact resistance to the corners of the case.

Please carefully observe the arrangement and combination of accessories in the picture, and you will find that this arrangement and combination make the box more stable and firm, and it is not easy to tip over, because it expands the placement area of the wheels and maximizes the load-bearing.

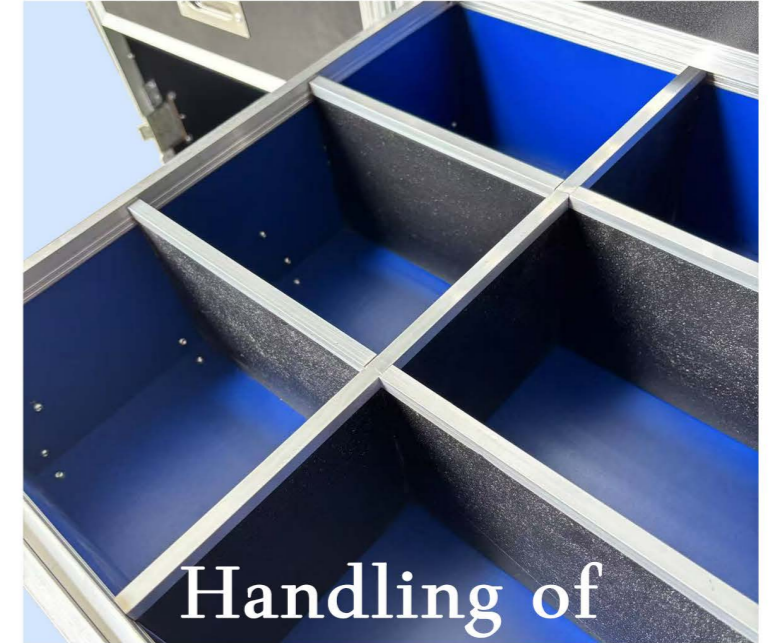

Handling of complex details Machine made & handmade

Machine made

Adjust its parameters according to the design requirements to make the cutting of materials and the division of space more accurate.

Handmade

Under the premise of machine production, accurate materials (boards, cotton, aluminum) are obtained, plus some connectors and accessories, which are assembled in the form of manual to meet the needs and aesthetics.



The beauty of cutting

Handmade cotton paste. Machine cutting results display.



Customize your own flight case

There are 5 main focuses and 9 details.

In fact, the most important of them are the 5 major items. The process of customizing the airbox with the luminaire as a storage object will be shown on the right side.

- 1. Demand communication:** The customer clarifies the usage scenario, size requirements, load-bearing range, internal structure and special needs and the manufacturer initially evaluates the feasibility accordingly.
- 2. Scheme design:** The manufacturer issues a design plan according to the needs, including the box material, structural drawings, accessory selection, and provides a quotation to adjust the details after confirming with the customer.
- 3. Sample production:** After the plan is determined, make samples for customer inspection, focusing on checking dimensional accuracy, structural stability, accessory adaptability, etc., and improve the sample after customer feedback and modification.
- 4. Mass production:** After the sample is confirmed to be correct, it enters mass production, processes the box and assembled accessories according to the design standards, and conducts quality sampling inspections during the process to ensure that it
- 5. Delivery and acceptance:** After the production is completed, the customer will check the quantity, check whether the product is consistent with the sample, and complete the transaction after confirming that it is correct, and some manufacturers will also provide after-sales maintenance support.



01
The object being stored
The stored objects can be single or multiple, such as lamps, stereos, etc.

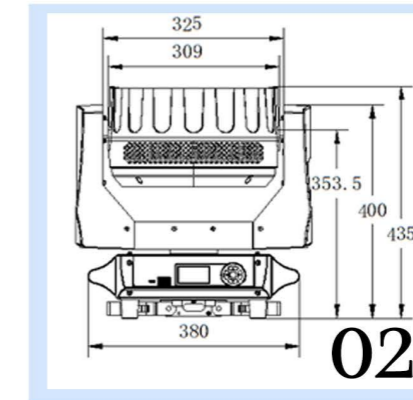

02
Properties of the object
Accurate measurement of the object's apparent dimensions and weight.



03
Confirm the placement
The fixed position in the box should be conducive to long-term storage.

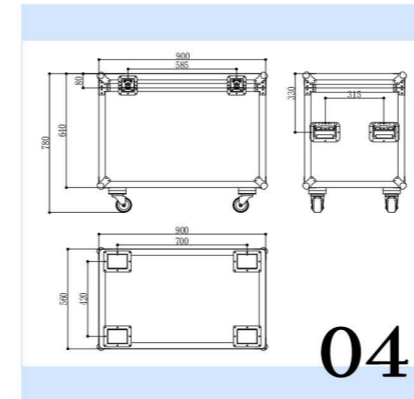

04
Models and drawings
Generate computer models and construction drawings.



05
Materials used
Specific materials are used according to needs and actual situations.

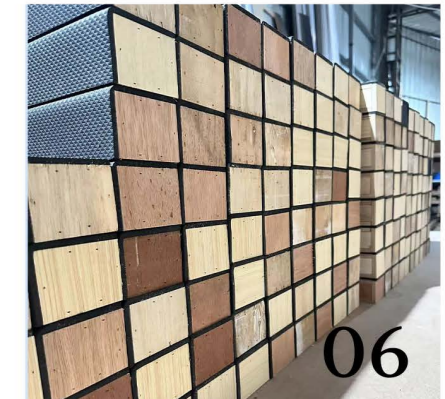

06
Factory process
IN factory makes the main frame of the entire box.

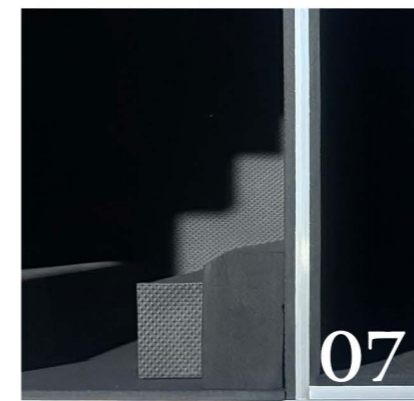

07
Installation of accessories
Necessary accessories and special accessories for installation.



08
Printing of logos
Freight shipping logos and brand logos are printed on the box.



09
Delivery and after-sales
Confirm the box and deliver it, and experience perfect after-sales service.

Electric hoist controller

in factory-customized electric hoist controller is divided into 4 channels, 8 channels and 12 channels, of which the 12-channel electric hoist controller has two styles, namely HL-12DZ and HL-12JC.



4 *16A Ways Electric hoist controller

It can be connected to an 8-channel console and expanded to 4-channel connection.

Input:

1 way WEIPU 32A 3P+N+⊕

Outputs:

4 ways WEIPU 16A 3P+⊕

Knob the sub switch to control the lift.



8 *16A Ways

The total power input and output, the console can be expanded to four channels.

General control part:

1. WEIPU 32A 3P+N+⊕

2. The total input is indicated separately by a three-phase signal.

3. The total empty opening is 3P32A, and the sub-switch controls the lifting

Outputs:

1. 8 ways WEIPU 16A 3P+⊕

2. The single way can be controlled by a button switch.

24 *16A Ways



STAGE EQUIPMENT factory
www.instage.cc

12 ways Electric hoist controller

01



HL-12JC



The contactor control method is adopted, equipped with emergency brake button and lifting control knob, and a single forward rotation, reversal and stop are realized during use. 380V input. 3P2A's total empty open.

During use, if the motor is found to be abnormal, you can directly press the emergency stop button to cut off the contactor output.

02



HL-12DZ



It adopts the large rotor centralized control method and is equipped with a lifting control knob. 380V input 380V output. 3P2A's total empty open

During use, a single forward rotation, reversal and stop are realized. 12 independent outputs, which can be grouped into multiple channels to control the lifting and lowering at the same time.

16.9KG
680*390*210mm(L*W*H)



IP44

HL-12JC



HL-12DZ



Scan the code to view
the user manuals
of the 2 models

Schematic diagram of the use of DMX512(RDM) 8-way

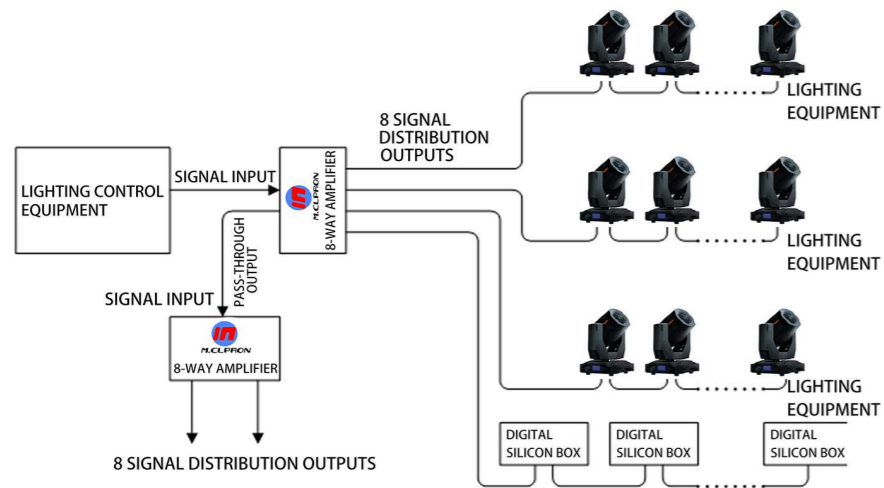

The height of the lid of the 2-pack device



This signal amplifier is made by the IN STAGE factory. You can scan the QR code on the left to view more product information and user guides.

2 Sets RDM512-8QM



530*365*145mm(L*W*H)



560*475*275mm(L*W*H)

4 Sets DMX512-8HM

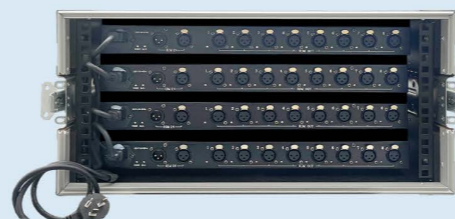

RDM512-8QM



3 panel displays

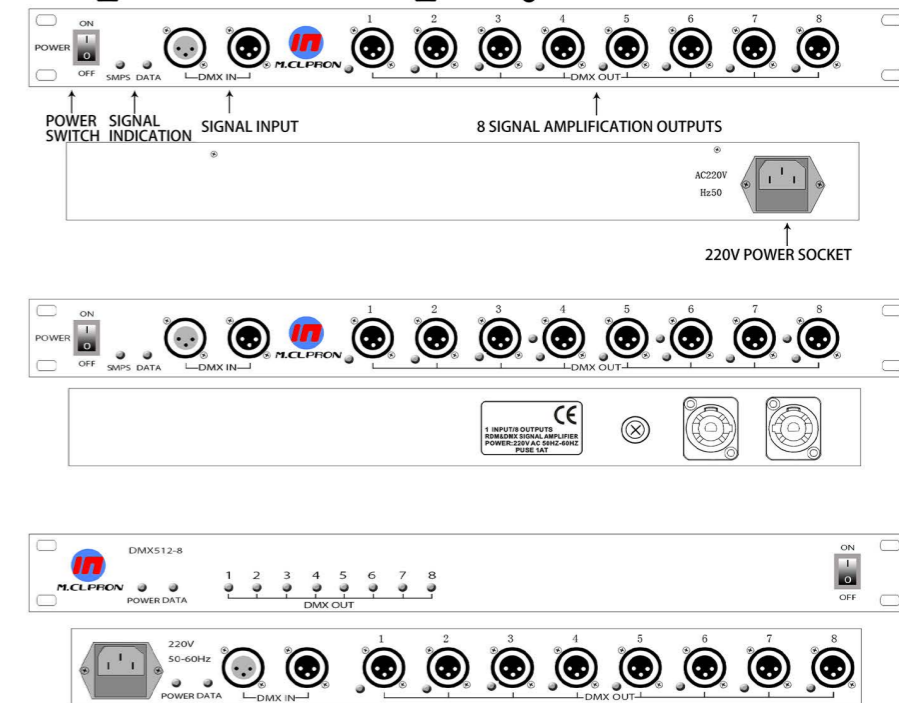

Physical display of cabinet amplifier

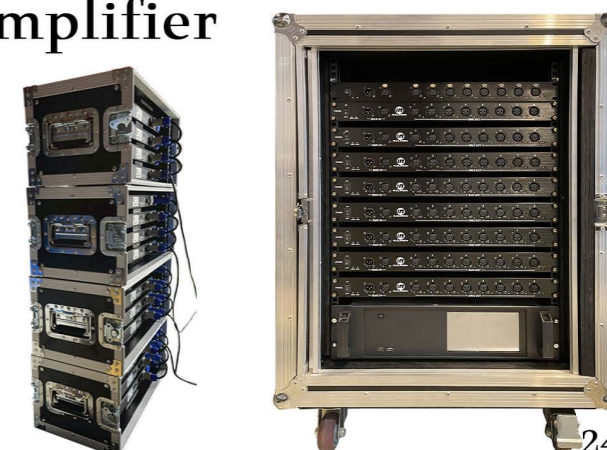



Lighting and special effects

The **in** factory has the following:

1. Ordinary hood machine power 200w-3000w,
2. Mist hood power 1000w to 3000w,
3. Water mist machine, 4. Dry ice machine,
5. Air column machine, 6. Fireworks machine,
7. Smoke bubble machine.
8. Theater lightings, LED wash lighting, Outdoor moving lighting.

Flight cases

The **in** factory can customize various types of airboxes for you to ensure that your stage equipment is well stored and transported during the performance. For example, a compact and portable model with a lid, a multi-purpose model with an open lid on both sides, and a value-for-money model with four wheels that can be stacked.



Power boxes

The **in** factory can customize the power supply box for stage equipment according to your needs, customize and build power supply modules and shunt modules for your stage equipment, and contract the power supply system for your mobile performance. For example, the portable and IP44 waterproof 6-channel 16A power box in the figure can be matched with accessories such as light hooks and plugs, as shown in the figure on the right, connected to the power supply shunt module.

Attachments

Some of the accessories you specify, such as light hooks, plugs and sockets, cables and wires, etc., can be customized and installed by the **in** factory.



For more detailed parameters, see the corresponding number of pages.

Page 26:
10U cabinet
12ways 4*32A



Page 28:
4ways 32A power box



Page 21-22:
6ways 16A power box.
Waterproof / Newtork / Bakelite.



Build your system

IP44

It adopts 2.5 square connection cable, three-phase power supply. Five wires: three live wires, one neutral wire, and one bottom wire, with a maximum power of 21KW.

6ways portable power box



MC-JMS0610 6*10A IP20

Controls

DELIXI or CHNT
IP 25A empty control

Input

1 way WEIPU socket
32A 3P+N+⊕

Outputs

1. A,B,C three-phase voltage display.
2. 6 ways WEIPU socket
10A 2P+⊕

The maximum output of each channel is 4KW.

Size: 180*145*490mm (L*W*H)

Weight: 4.9KG

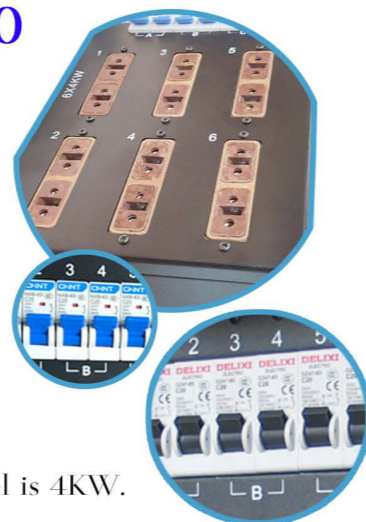

MC-NQK0620 6*20A IP20

Controls

DELIXI or CHNT
IP 25A empty control

Input

1 way WEIPU socket
32A 3P+N+⊕

Outputs

1. A,B and C three-phase voltage display.
2. 6 ways WEIPU socket
20A 2P+⊕

The maximum output of each channel is 4KW.

Size: 180*145*490mm (L*W*H)

Weight: 4.6KG



MC-FS06 6*16A IP40

Waterproof & Portable

It adopts Weipu 32A input, with a total power of 20KW waterproof, etc. Rated IP44;

Six channels of 16A waterproof plug output, each channel is 3.5KW.

DELIXI OR CHINT 25A air opening control overcurrent protection, AA BB CC mode: easy to plug and unplug.

There is a handle on the front and an external hanging quick lock device on the side, which can be put on the rack for convenience Zoning control of large-scale performances.

There is a three-phase sign on the outside, which is distinguished by color (A yellow, B green, C red), and the voltage value is displayed. The total weight is 4.3KG, can be lifted with one hand.



Compact size for mobile performances

The **handle design** and the **attached light hook** make it easy to use.



Controls

DELIXI or CHNT
IP 25A empty control

Input

1 way WEIPU socket
32A 3P+N+⊕

Outputs

1. A, B, and C three-phase voltage display.
 2. 6 ways WEIPU socket
16A 2P+⊕
- The maximum output of each channel is 3.5KW.



Attachments

- +1* WEIPU TYP285 P5 32A
- +6* WEIPU TYP2319 P3 16A
- +1* LAMP HOOK TYP60

Size: 180*140*400mm (L*W*H)

Weight: 4.3KG





4

- Hive-0432**
 +  400A
 Terminal Male
 +  *4 5P32A

4ways each circuit output: 32A 21kw,
 input: 380V
 waterproof rating: IP44
 Controlled by a 3P32A air switch, with
 overcurrent protection.
 size: 525*535*270mm

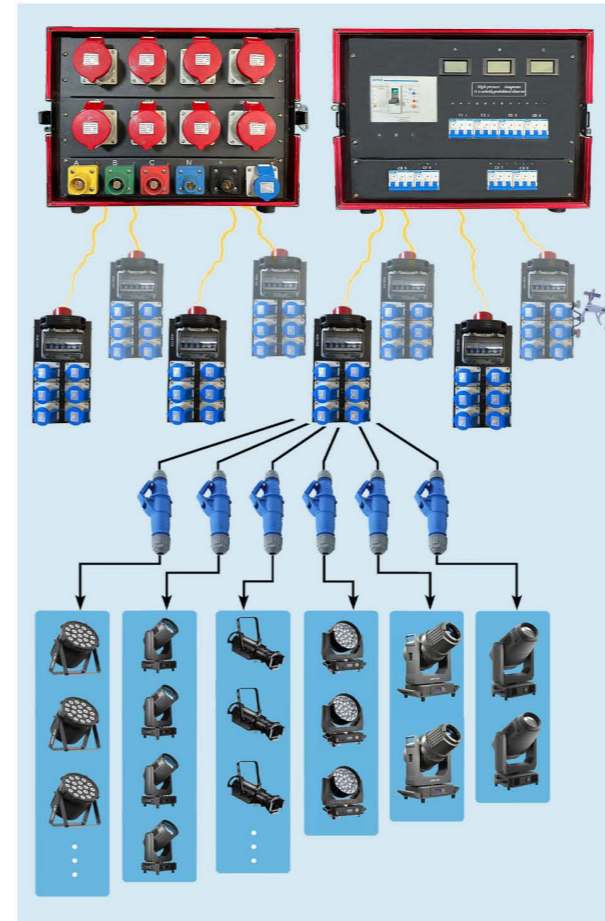

Hive-series

input 380V 400A
 each circuit output
 380V 32A 21kw

Characteristics and Advantages of the Hive System

It can adopt three-phase five-wire input with 400A or 200A;
 Each output is three-phase five-wire with 32A;
 The waterproof rating is IP44;

The internal connection uses national standard Zhongce BVR 6-square wire;
 It is controlled by Delixi or Chint 32A air switches, with overcurrent protection;
 There are external A, B, C three-phase identification displays for voltage separately, with color indicator lights (A: yellow, B: green, C: red);

The exterior is designed as an aviation case, featuring a small volume, easy storage and transportation. It can be used as a multi-level distribution box, which is convenient for mobile performances;

Accurate external dimensions and weight are marked. Multiple sizes are available for selection.

- Hive-0832**
 +  200A/400A
 Terminal Male
 +  *8 5P32A



8ways each circuit output 32A, input: 380V
 waterproof rating: IP44
 Controlled by a 3p32A air switch, with
 overcurrent protection.
 size: 525*535*380mm
 weight: 27KG

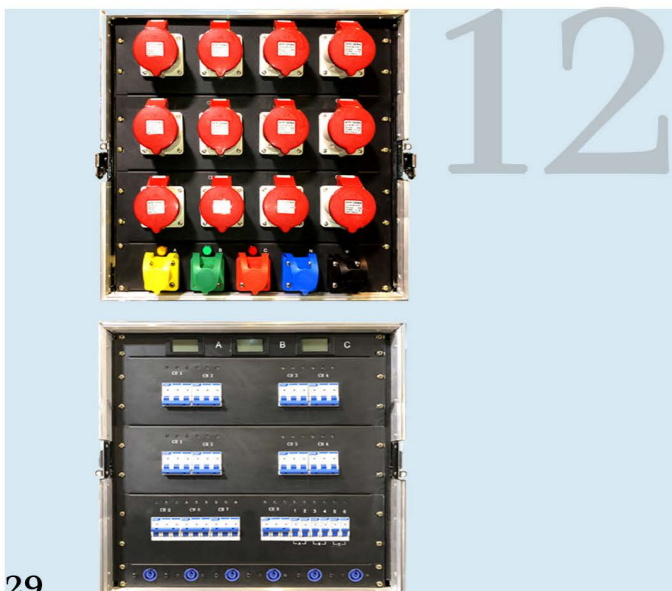
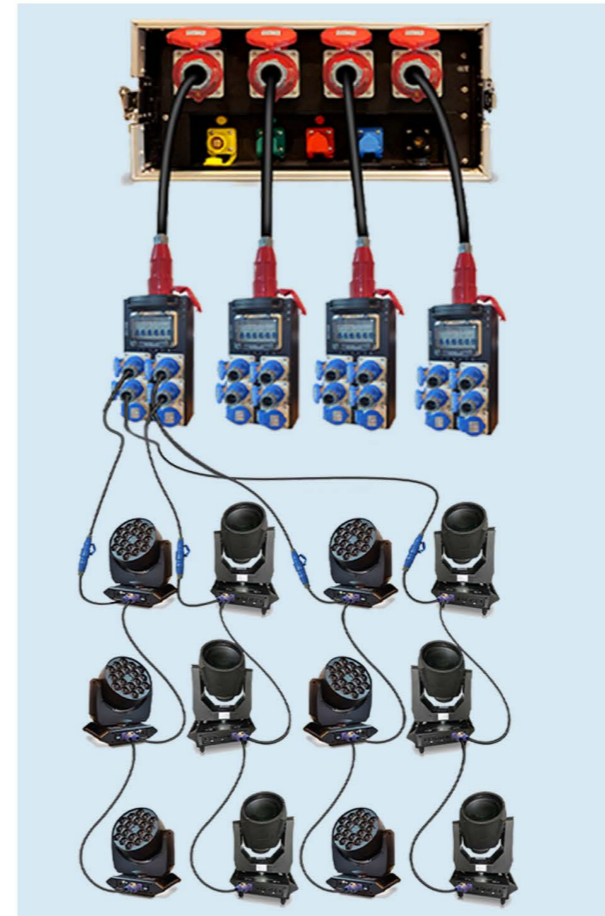

8



12

- Hive-1232**
 +  200A/400A
 Terminal Male
 +  *12 5P32A

12ways, each circuit output32A, input: 380V
 waterproof rating: IP44
 Controlled by a 3P32A air switch, with
 overcurrent protection.
 size: 525*535*490mm
 weight: 33KG



12

Hive-1216&432

12ways each circuit output 16A, and 4ways 32A.
waterproof rating: IP44.
16A WEIPU output base controlled by a 1p20A 12-bit air switch.
32A WEIPU 5-pin output base controlled by a 3P32A 4-bit air switch.
250A Main Control Switch, with overcurrent protection.
A 380V Reverse Output.
5 Pieces of 400A Rhino Main Input.
size: **600*700*670mm**
weight: **40KG**



- +  400A Terminal Male
- +  *4 5P32A



24

FS-2416

Three-phase voltage and current with separate numerical display.
24ways, each circuit output16A, with indicator light, with leakage protection.
waterproof rating: IP44
Controlled by a 3P32A air switch, with overcurrent protection.
400A Rhino Main Input,400A Rhino output.
size: **600*700*759mm**
weight: **61.5KG**



- +  400A Terminal Male
- +  *2 5P32A



On wheels

input 400A
each circuit output
32A/16A 21kw

Characteristics and Advantages of these two type.

Both of these two power supply boxes feature three-phase voltage and current with separate numerical displays and 5 pieces of 400A Rhino main inputs.

Apart from differences in external dimensions and weight, their distinctions are as follows:

The 10U cabinet (Hive-1216&432) is equipped with 12 channels of 16A outputs, 4 channels of 32A outputs, and an additional 380V reverse output.

The 13U cabinet(FS-2416) is distinguished by its leakage protection function, along with 24 channels of 16A outputs and 4 pieces of 400A Rhino outputs.

You can directly buy the existing products of the factory or customize the products you need.

The factory is located in Guangdong, China. For customize waterproof series , please contact the factory boss Cathy directly +86 17300997560.

Number of output circuits in the Waterproof series

66



9000+

Number of
Factory Customers
Who Placed Orders

≤ 50%

Deposit for customer-customized
power distribution box

100%

Factory Customer
Repurchase Rate

www.instage.cc

For more information

WhatsApp Contact of the
Custom Power Distribution Box
Factory Owner

Cathy +86 173 0099 7560

12

size: 520*380*380mm
weight: 18KG



Three input methods

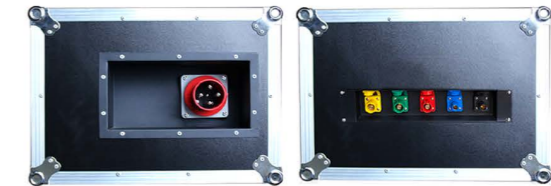

Waterproof 63A input Rhino head 400A / Rhino head 200A

24

size: 600*700*820mm
weight: 55KG



36



WEIPU 3P16A+Rhino head 400A

size: 600*700*1120mm
weight: 60KG

48



WEIPU 3P16A+Rhino head 400A

size: 600*700*1210mm
weight: 65KG

12-channel Digital Through Box

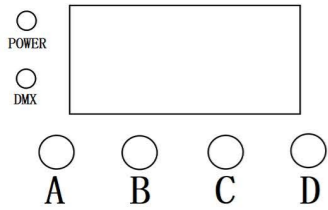

Instruction Manual

Power -- Power indicator

DMX--DMX512 Signal Indicator

A-Menu key -- Show the main menu or go back to the previous level of contents

B-arrow keys--modify data increment, up key

C-arrow keys--modify data decrement, down keys

D-Confirm key to enter the submenu or save key

Display of Previous Related Products

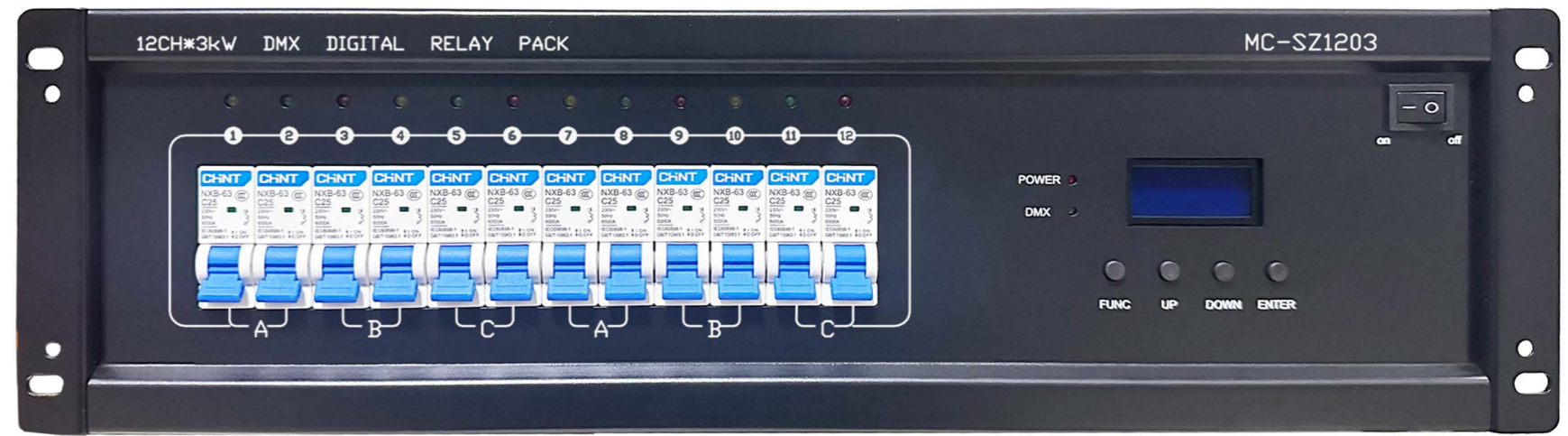



嘉兴鸳鸯湖音乐节

华润万家2013全国供应商大会



flight cases



Customized



Build your system



power boxes



stage effects

Since 1999

Hangzhou & Guangzhou IN stage equipment Co.,Ltd

- ✓ flight cases: Waterproof IP44-IP68
- ✓ Build your stage power supply system:
Power boxes + flight cases + Stage lighting + Attachments
- ✓ Stage effects: Stage lighting and shadow + Special effects + Stage Audio

CEO&founder of IN stage: Cathy

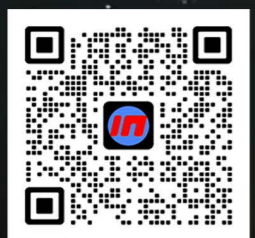

WeChat
+86 17300997560



WhatsApp
+86 17300997560



IN factory
Details display