

Descendants of (AYU) OTWAY

5 October 2021

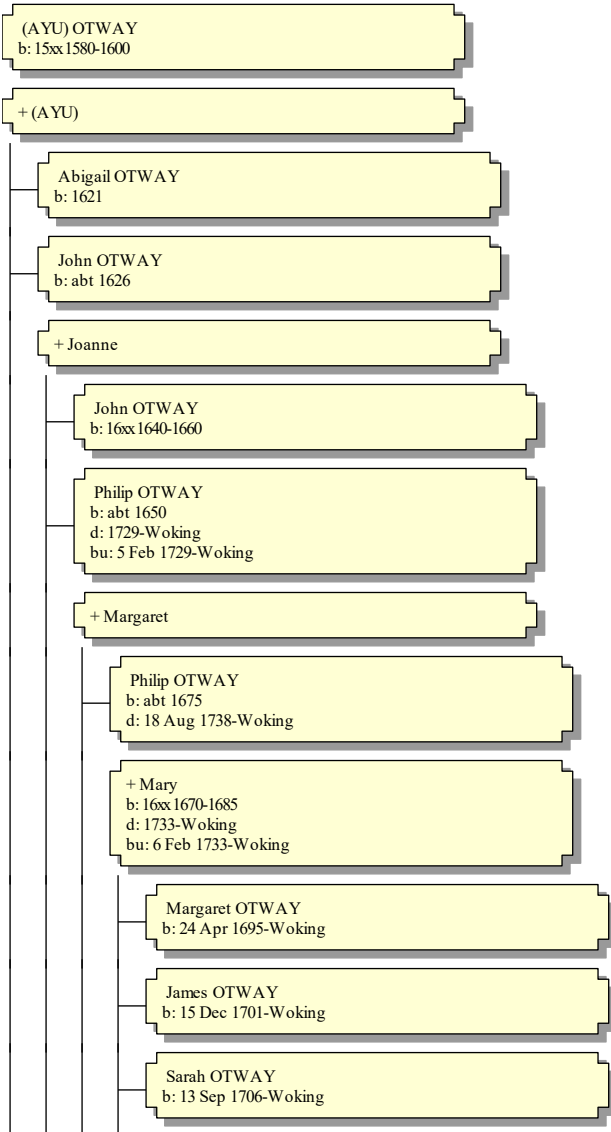

Descendants of (AYU) OTWAY

5 October 2021

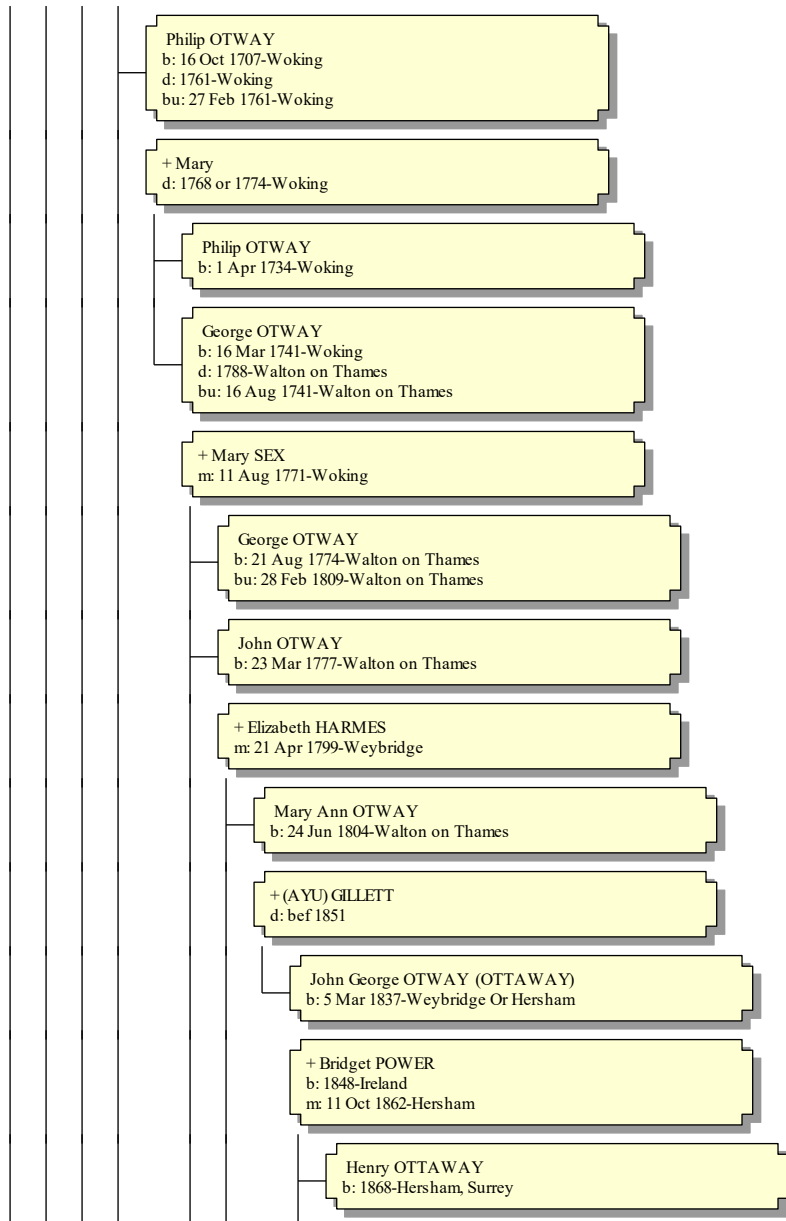

Descendants of (AYU) OTWAY

5 October 2021

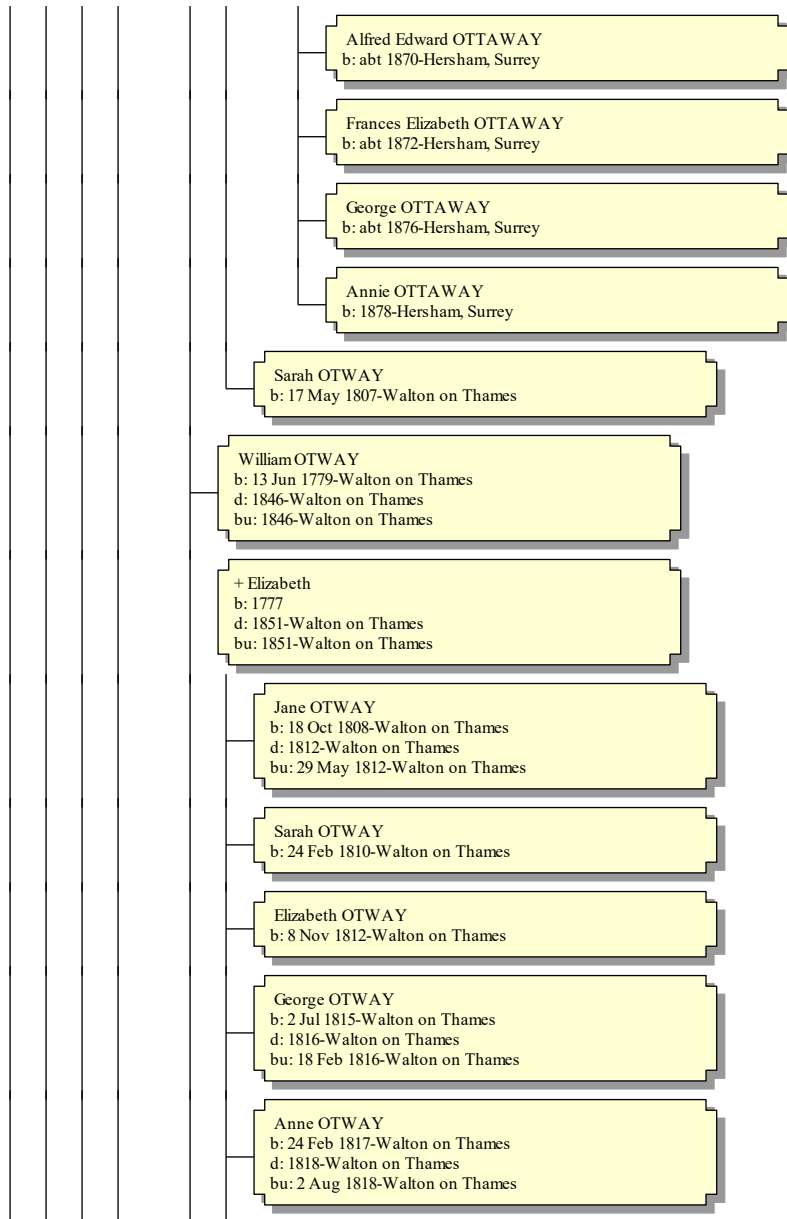

Descendants of (AYU) OTWAY

5 October 2021

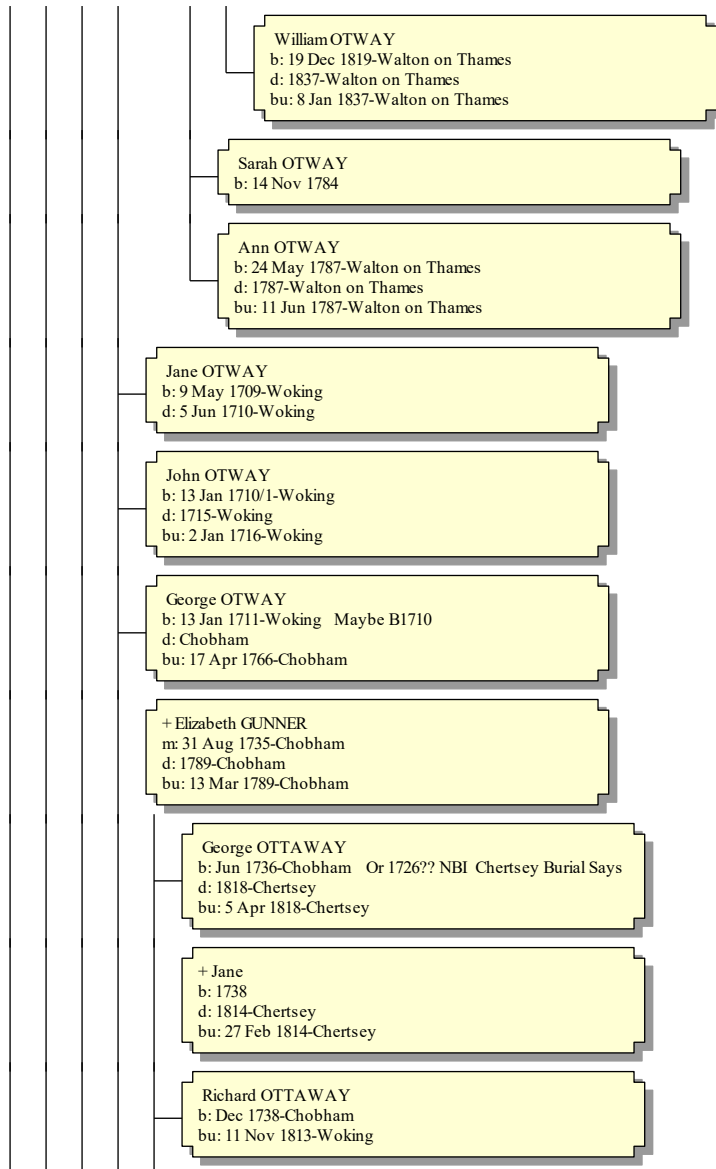

Descendants of (AYU) OTWAY

5 October 2021

+ Susannah WELLBELOVED
b: Windlesham
m: 11 Jul 1762-Bagshot
d: 1780-Chobham
bu: 6 Mar 1780-Chobham

Henry OTTAWAY
b: abt 1764
d: Jun 1835-Chobham
bu: 1 Jul 1835-Chobham

+ Alice TICKNER
b: 1762-Chobham
m: 4 Nov 1789-Chobham
d: aft 1851

Henry OTTAWAY
b: Jan 1790-Chobham

+ Ann COLLYER
b: 1793-Pirbright Surrey
m: 1 Oct 1815-Chobham

Henry OTTAWAY
b: Jan 1819-Chobham
d: Apr 1835-Chobham
bu: 22 Apr 1835-Chobham

James OTTAWAY
b: 21 Oct 1792-Chobham
d: 1855-Chobham
bu: 1855-Chobham

+ Ann HUGHES
b: 1783-Chobham
m: 22 Apr 1816-Chobham

Ann OTTAWAY
b: Oct 1816-Chobham

+ George LEE
m: 1845

Charlotte OTTAWAY
b: Nov 1818-Chobham

Descendants of (AYU) OTWAY

5 October 2021

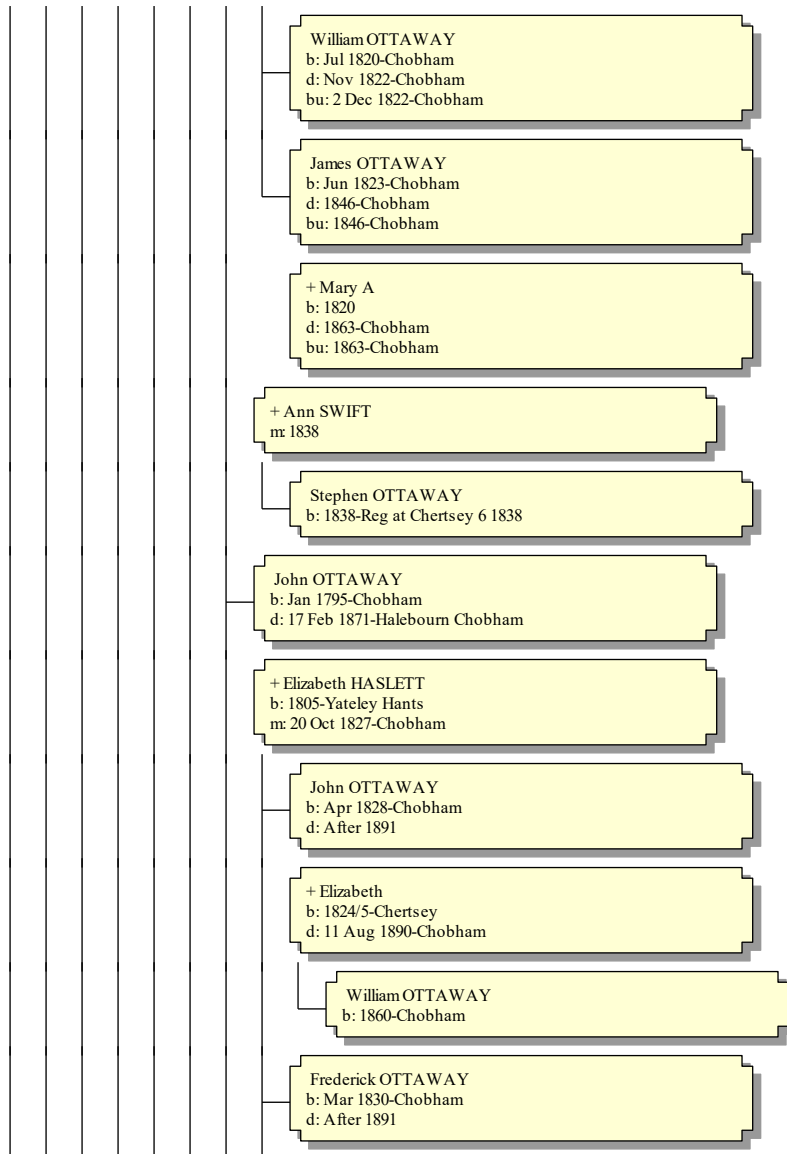

Descendants of (AYU) OTWAY

5 October 2021

+ Eliza HONER
b: 1830-Purbright Surrey
m: 20 Dec 1856-Stoke Next Guildford
d: After 1881 Bef 1891

Florence OTTAWAY
b: abt 1857-Chobham

Frederick William OTTAWAY
b: 25 Mar 1859-Chobham Regt At Chertsey 6 1859

Harriet Hannah Alice OTTAWAY
b: 1861-Chobham Reg At Chertsey

Eliza OTTAWAY
b: abt 1863-Long Whittingham, Berks

Annie OTTAWAY
b: abt 1865-Long Whittingham, Berks

Elizabeth OTTAWAY
b: abt 1867-Long Whittingham, Berks

Lilly OTTAWAY
b: abt 1871-Long Whittingham, Berks

William OTTAWAY
b: abt 1876-Iffley, Oxon

Mary OTTAWAY
b: Jan 1834-Chobham

William OTTAWAY
b: Oct 1797-Chobham

Charlotte OTTAWAY
b: 26 Aug 1800-Chobham

Elizabeth OTTAWAY
b: 5 May 1803-Chobham
d: 6 May 1803-Chobham
bu: 8 May 1803-Chobham

Descendants of (AYU) OTWAY

5 October 2021

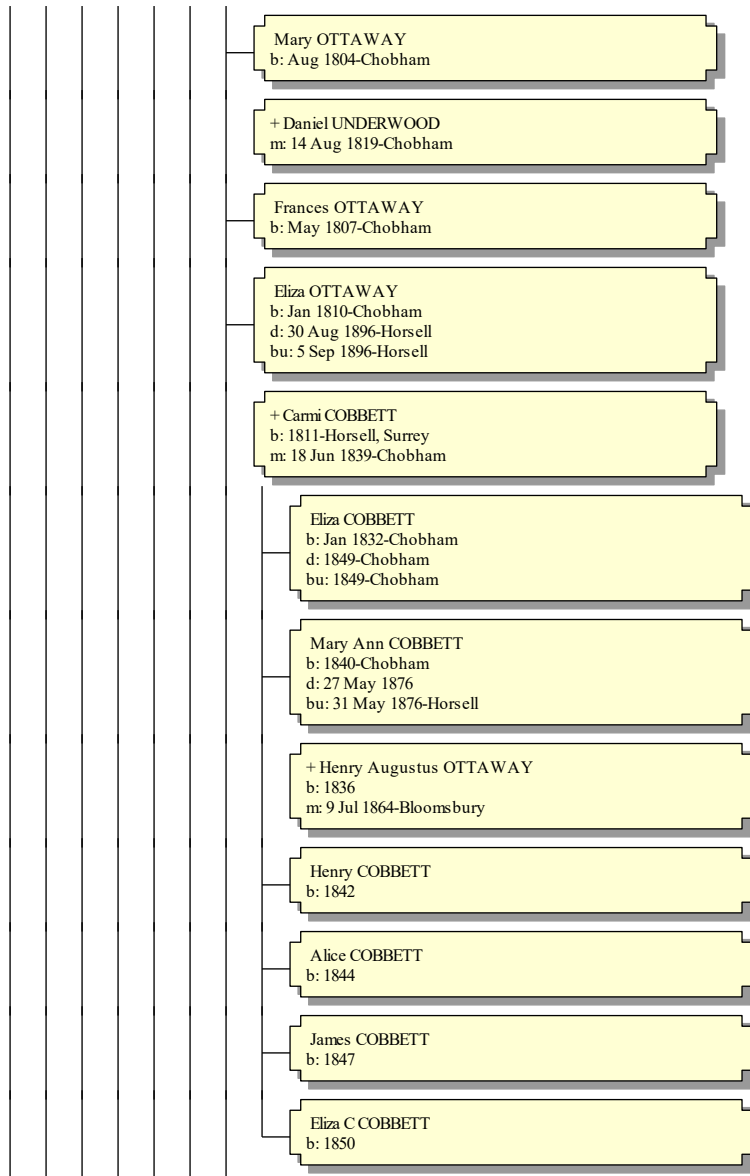

Descendants of (AYU) OTWAY

5 October 2021

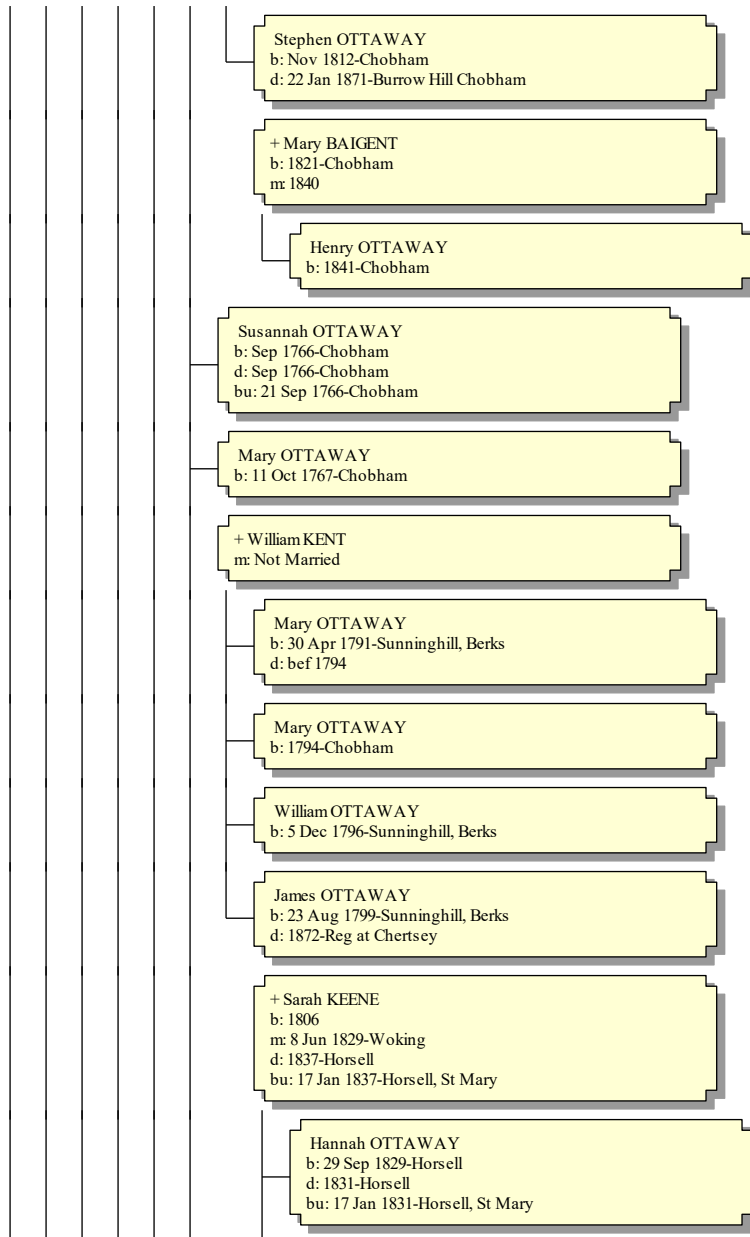

Descendants of (AYU) OTWAY

5 October 2021

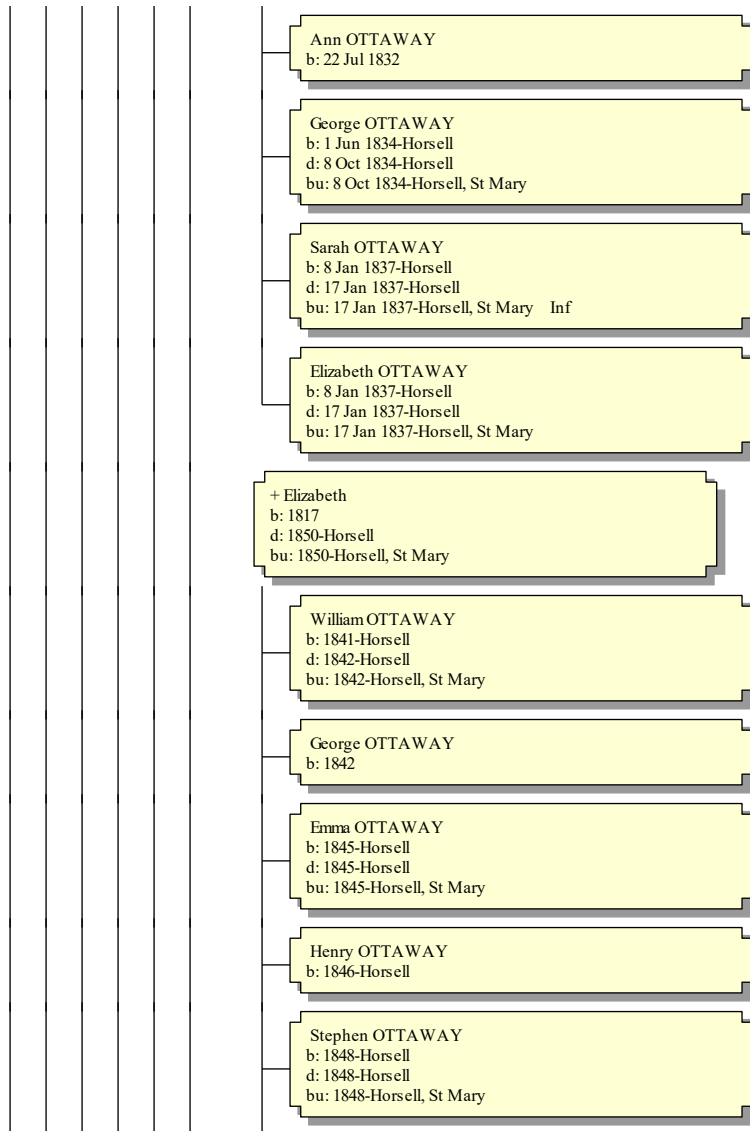

Descendants of (AYU) OTWAY

5 October 2021

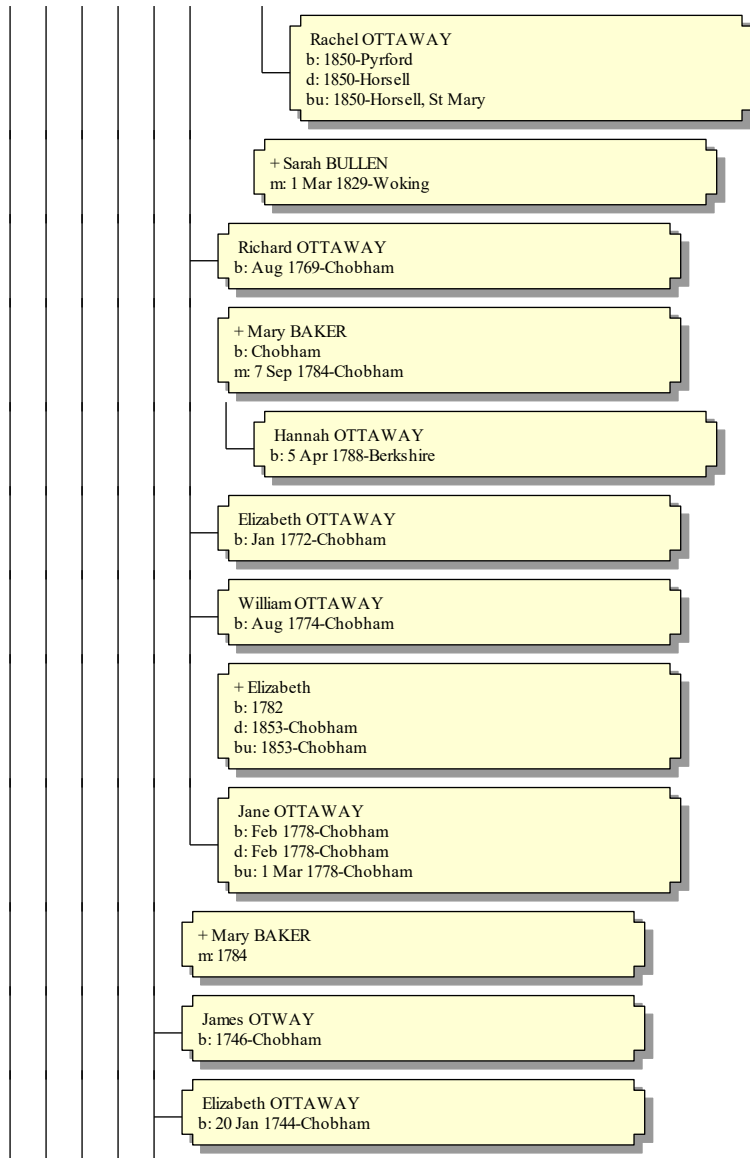

Descendants of (AYU) OTWAY

5 October 2021

John OTTAWAY
b: 31 Jan 1745-Chobham
d: 1828-Chobham
bu: 7 May 1828-Chobham

+ Martha TAPLEY
b: 1743
m: 25 Feb 1770-Chobham
d: Oct 1832-Chobham
bu: 13 Oct 1832-Chobham

John OTTAWAY
b: Mar 1770-Chobham
d: 1852-Chobham
bu: 1852-Chobham

+ Jane HOWARD
b: 1772
d: 1851-Chobham
bu: 1851-Chobham

Mary OTTAWAY
b: 8 Dec 1795

James OTTAWAY
b: Mar 1799-Chobham
d: Mar 1832-Chobham
bu: 4 Apr 1832-Chobham

Thomas OTTAWAY
b: Feb 1801-Chobham
d: bef 1881

+ Mary CANNEN
b: 1801-Windlesham, Surrey
m: 12 Oct 1822-St Lawrence, Chobham

Henry OTTAWAY
b: 13 Mar 1825-Windlesham Surrey

+ Harriet UNDERWOOD

Elizabeth OTTAWAY
b: abt 1852-Winkfield

Descendants of (AYU) OTWAY

5 October 2021

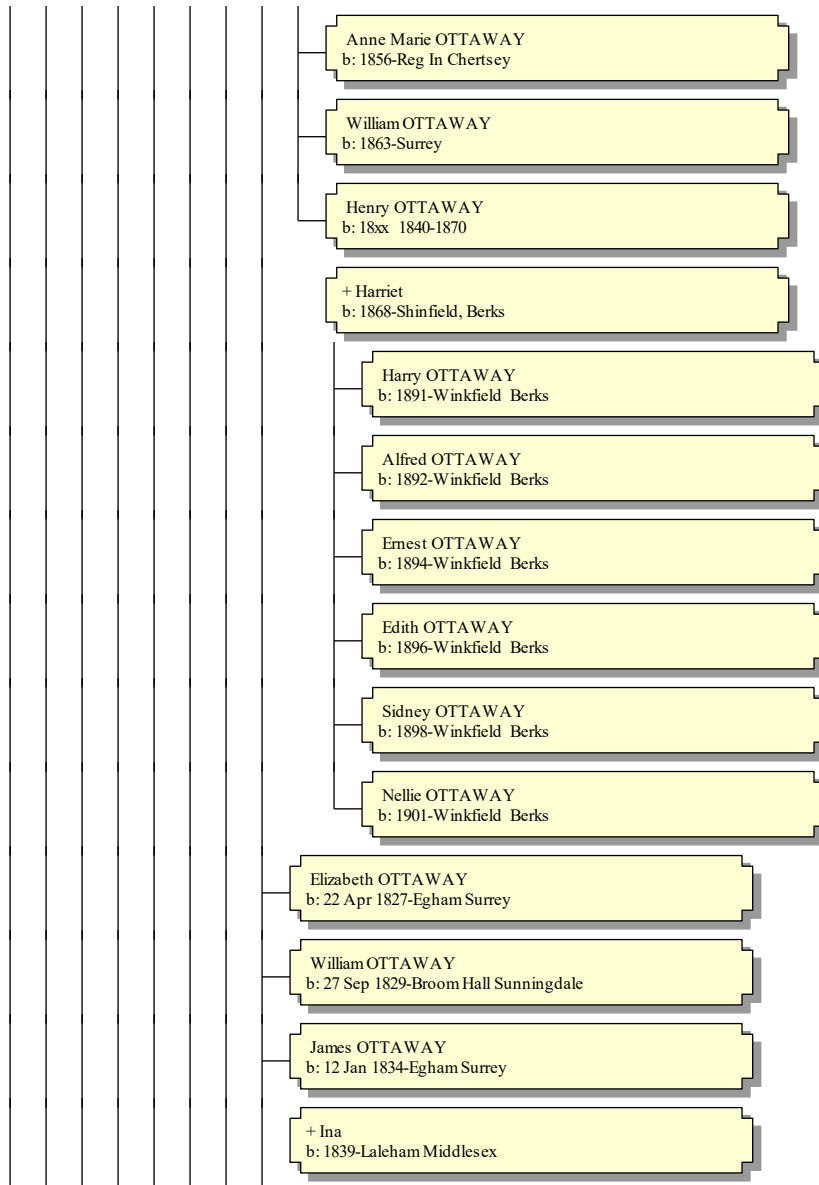

Descendants of (AYU) OTWAY

5 October 2021

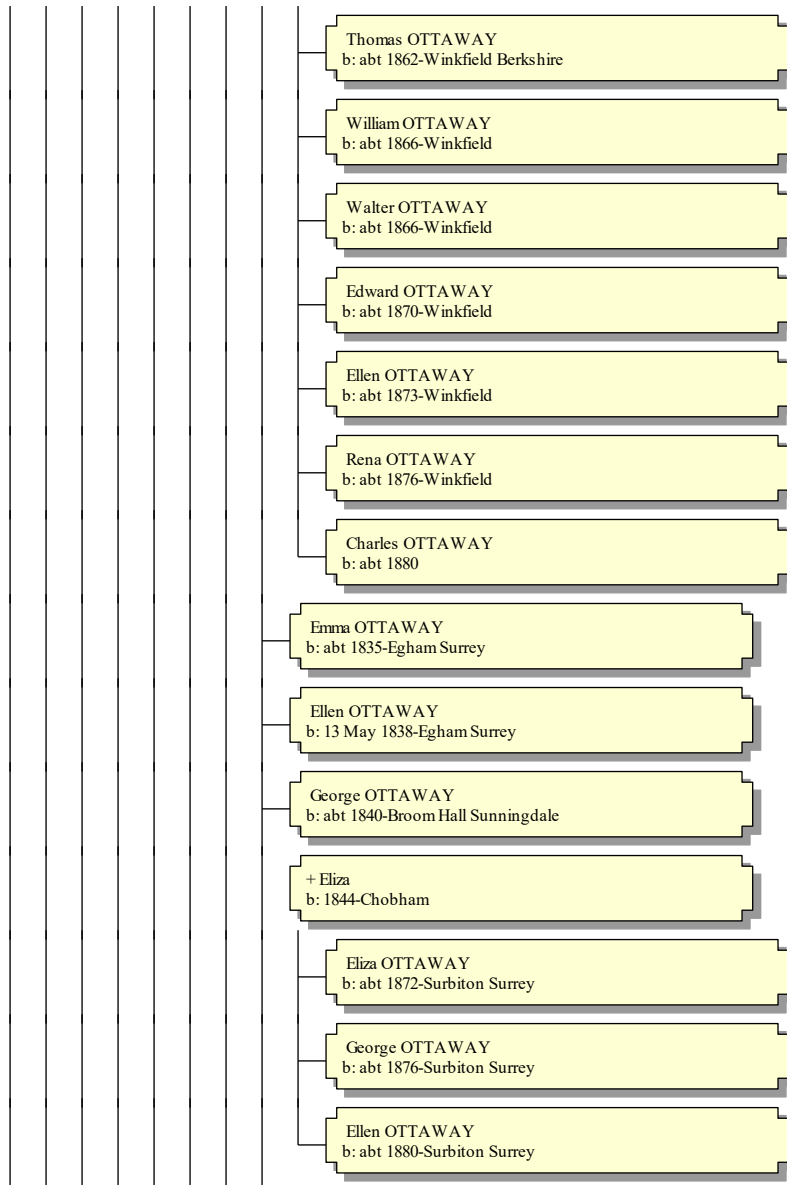

Descendants of (AYU) OTWAY

5 October 2021

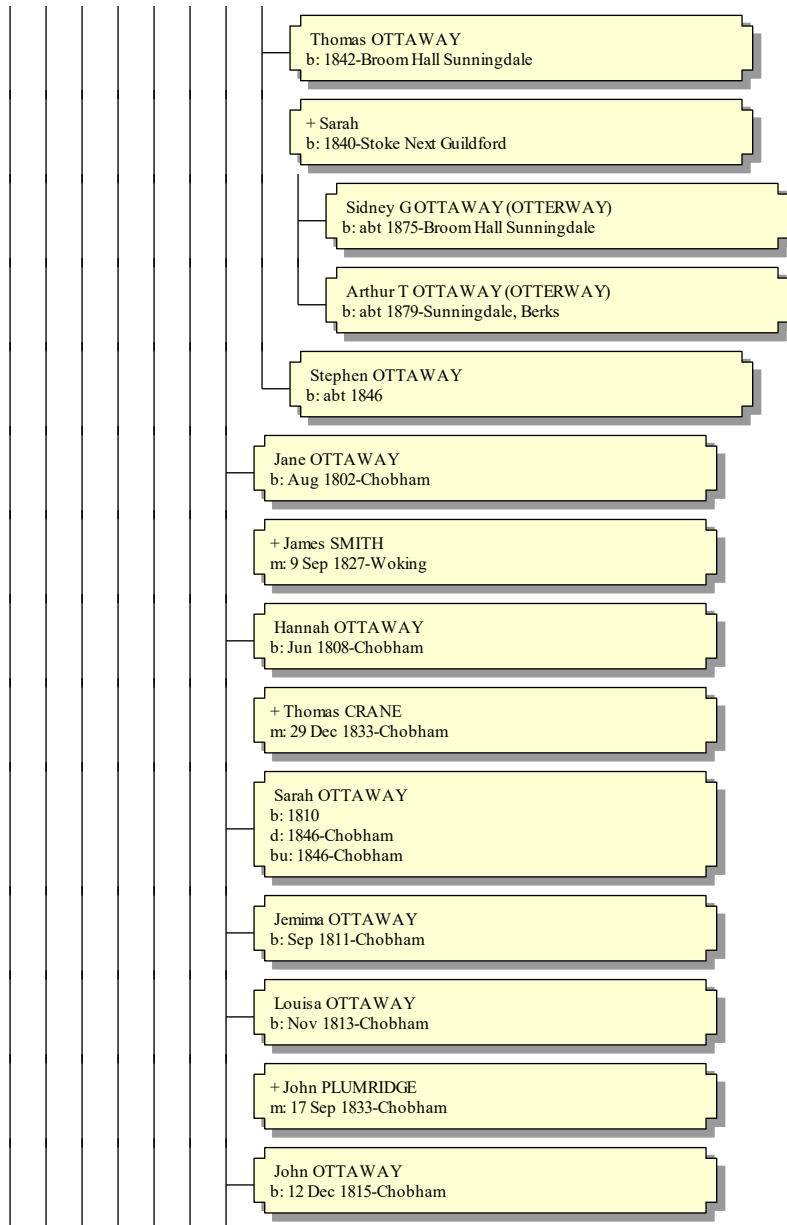

Descendants of (AYU) OTWAY

5 October 2021

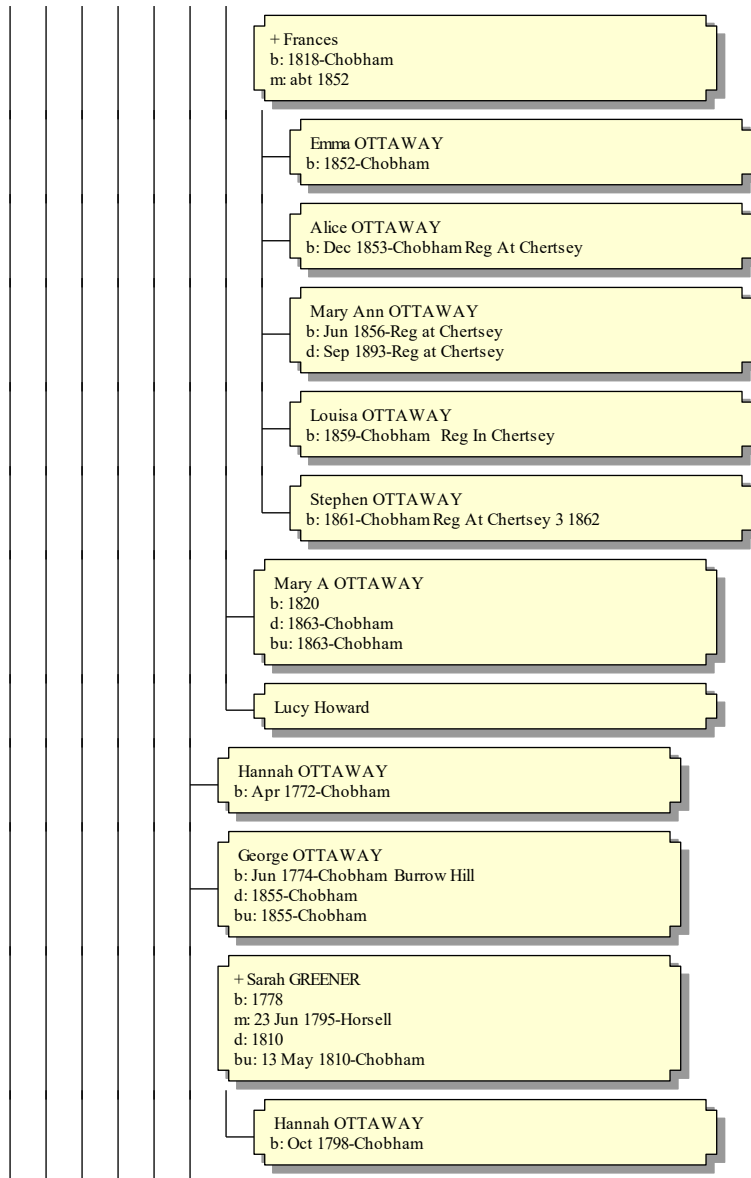

Descendants of (AYU) OTWAY

5 October 2021

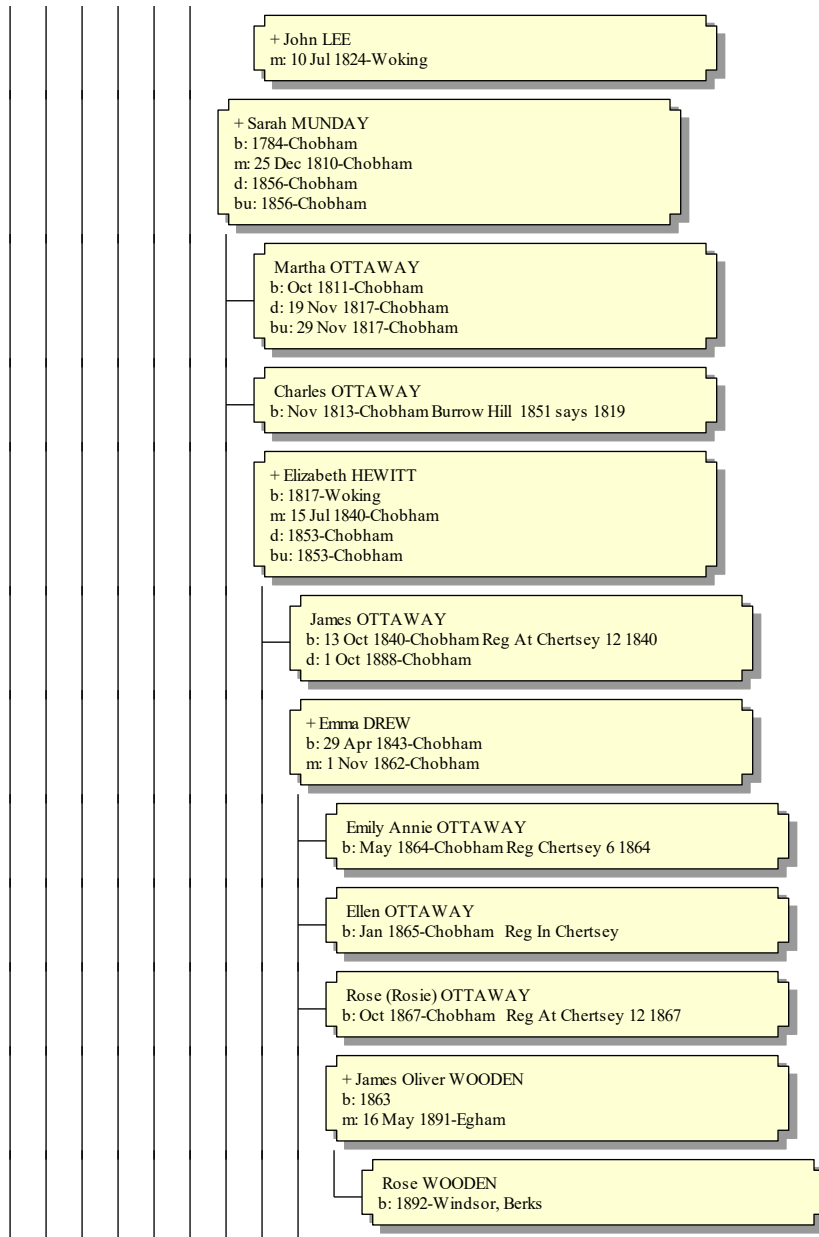

Descendants of (AYU) OTWAY

5 October 2021

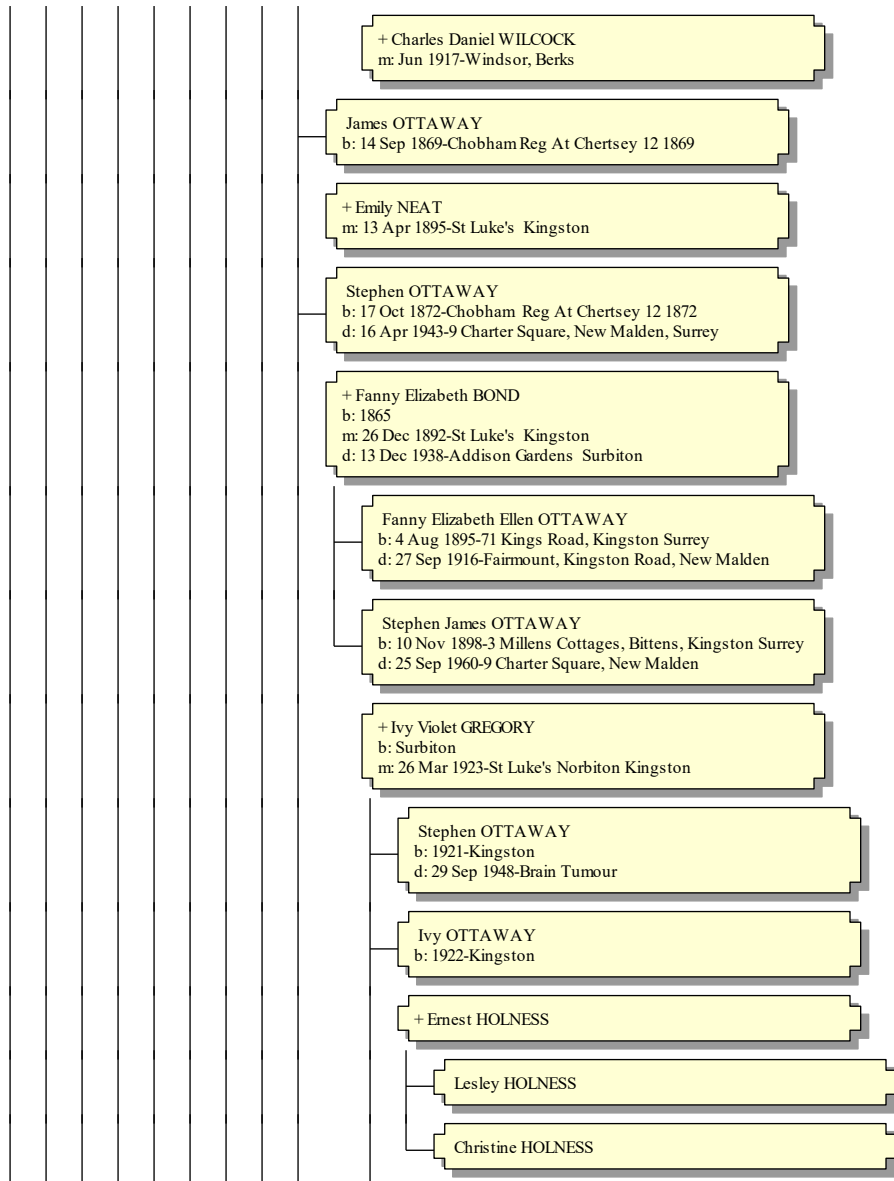

Descendants of (AYU) OTWAY

5 October 2021

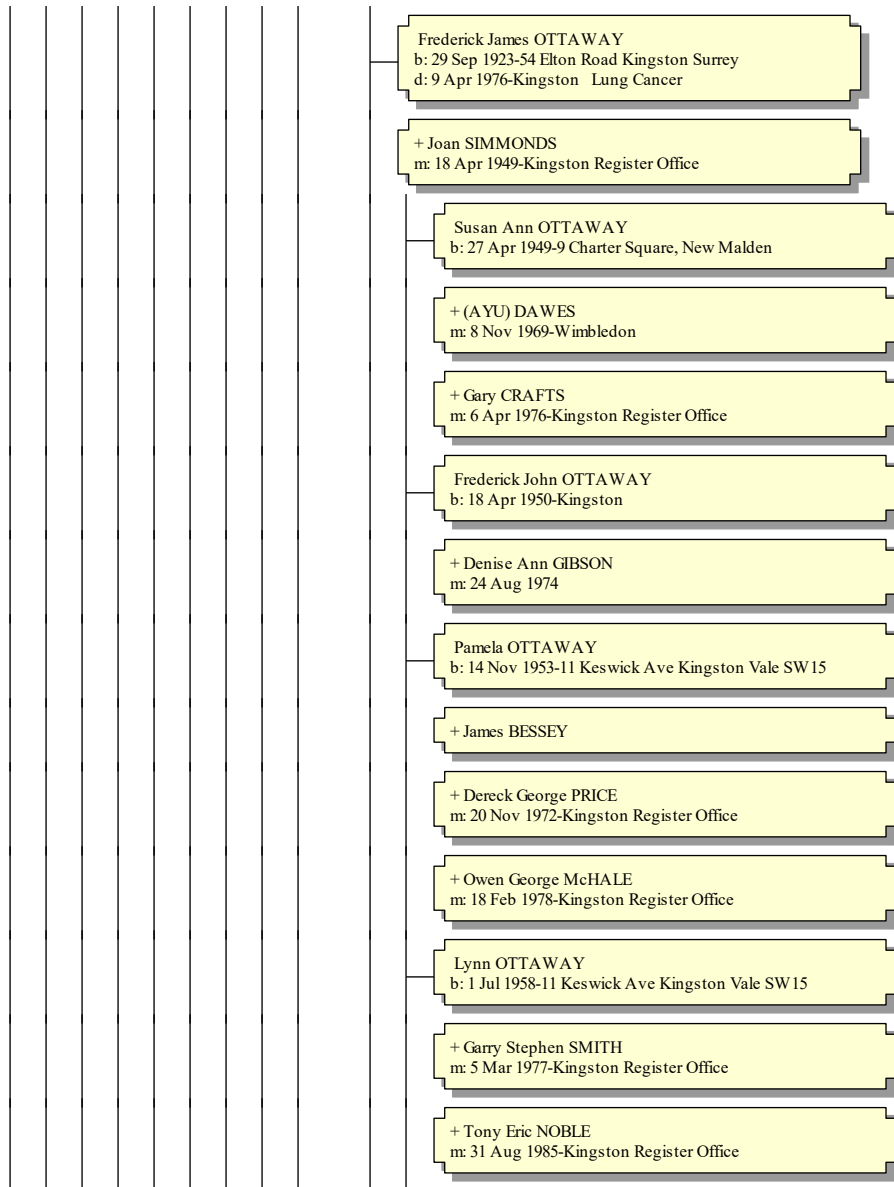

Descendants of (AYU) OTWAY

5 October 2021

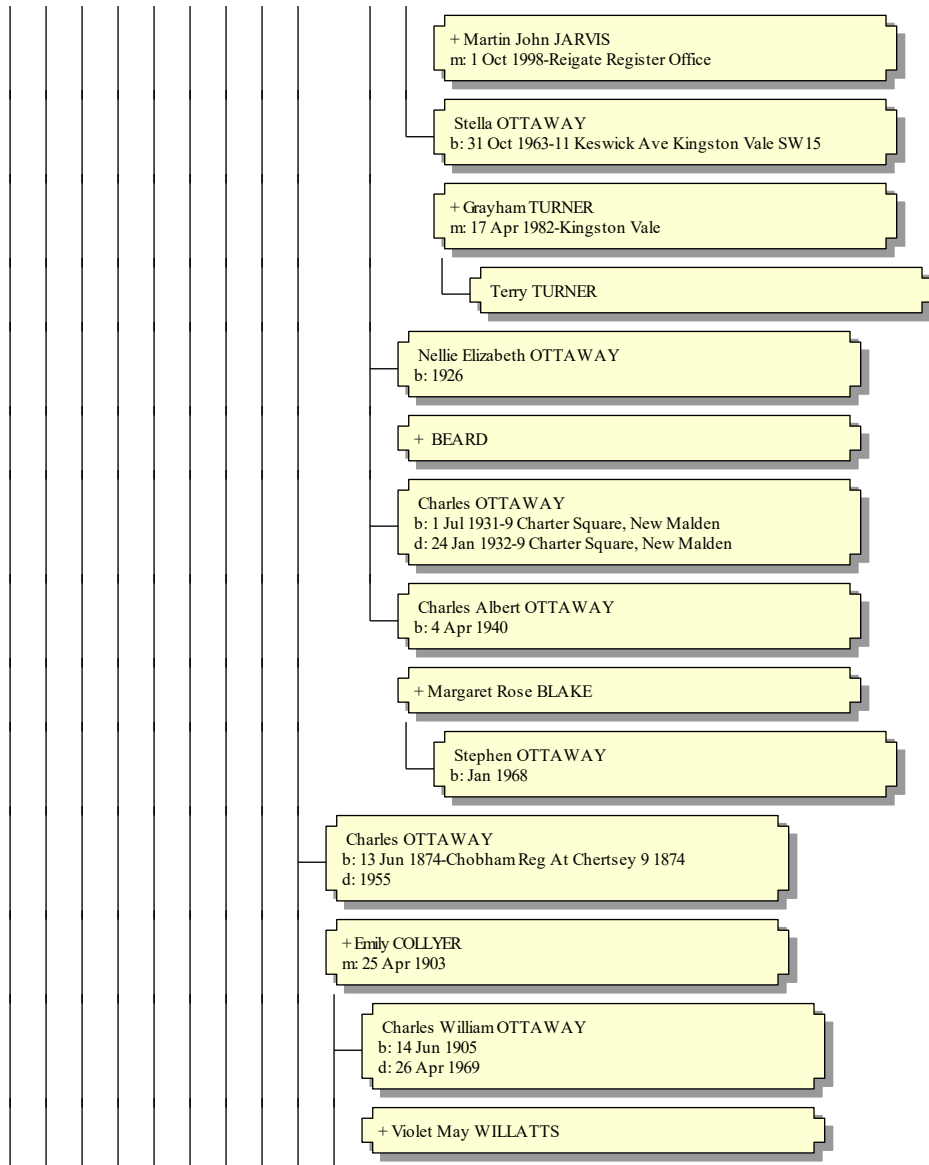

Descendants of (AYU) OTWAY

5 October 2021

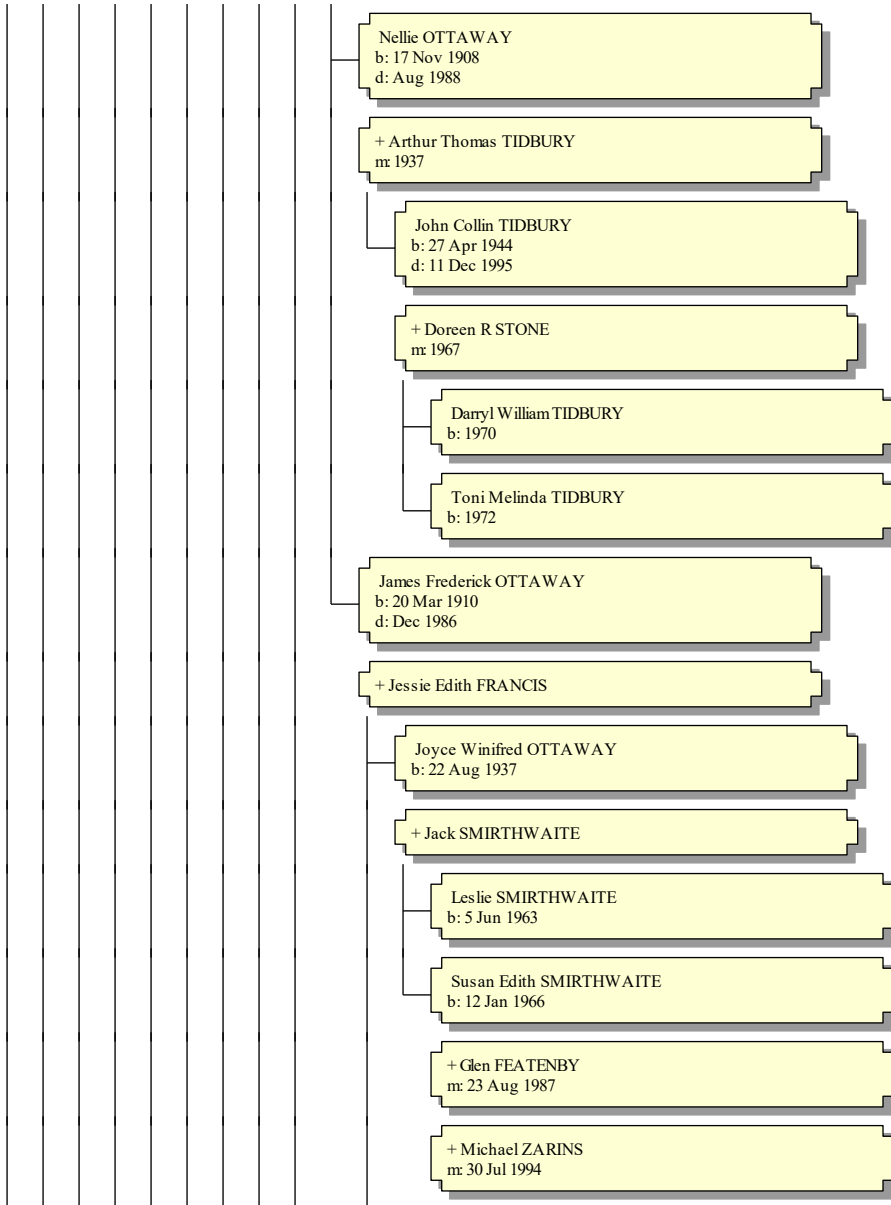

Descendants of (AYU) OTWAY

5 October 2021

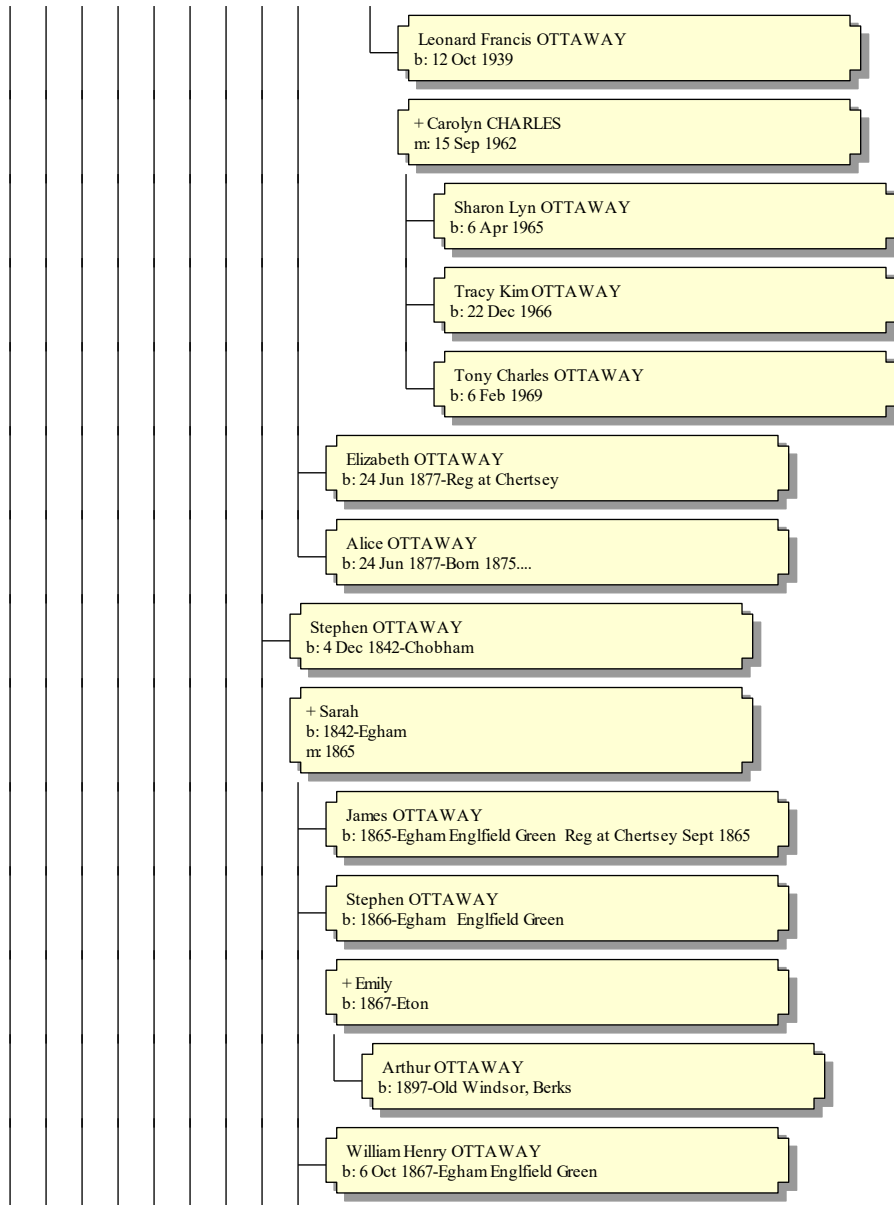

Descendants of (AYU) OTWAY

5 October 2021

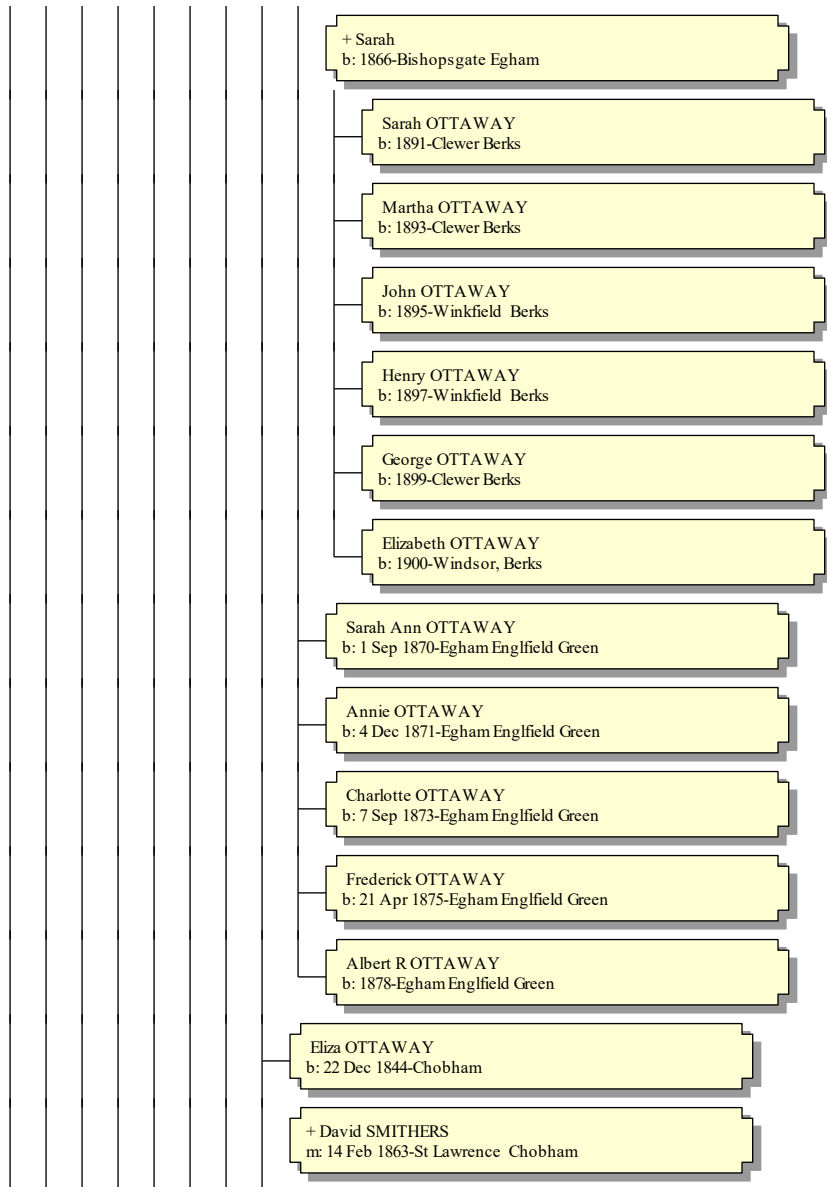

Descendants of (AYU) OTWAY

5 October 2021

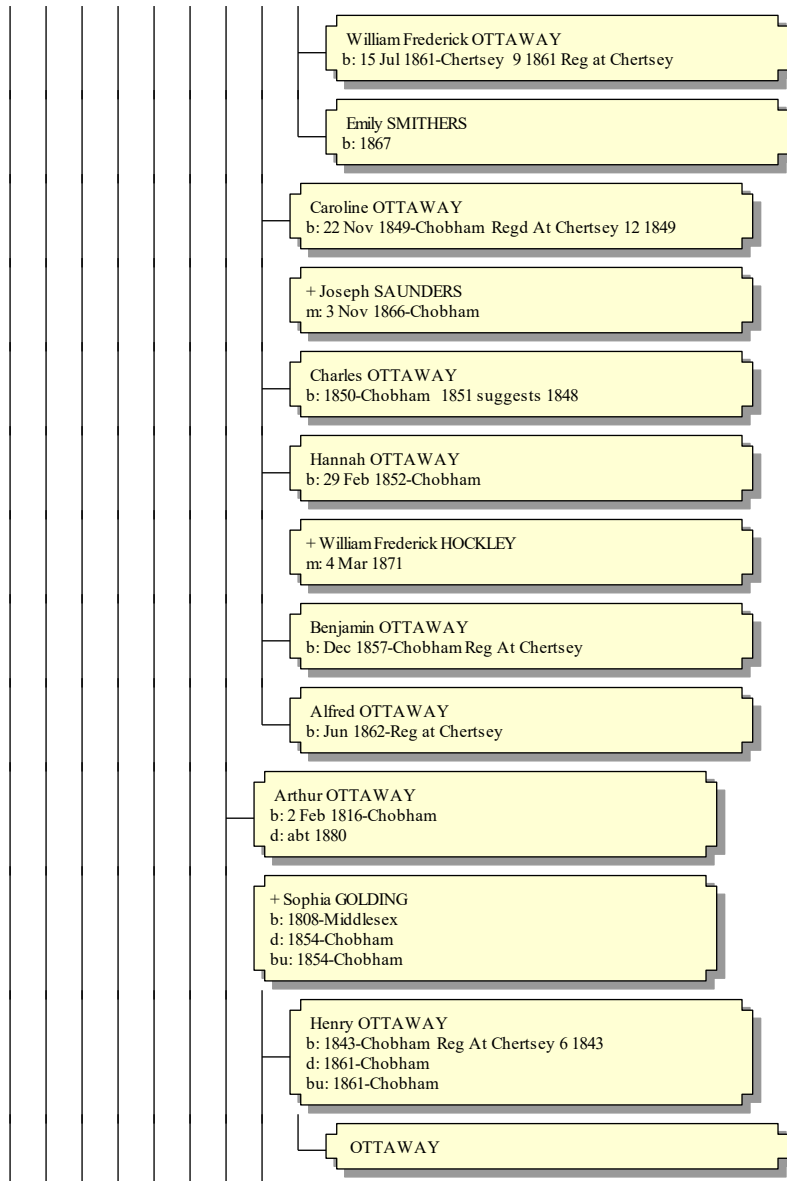

Descendants of (AYU) OTTAWAY

5 October 2021

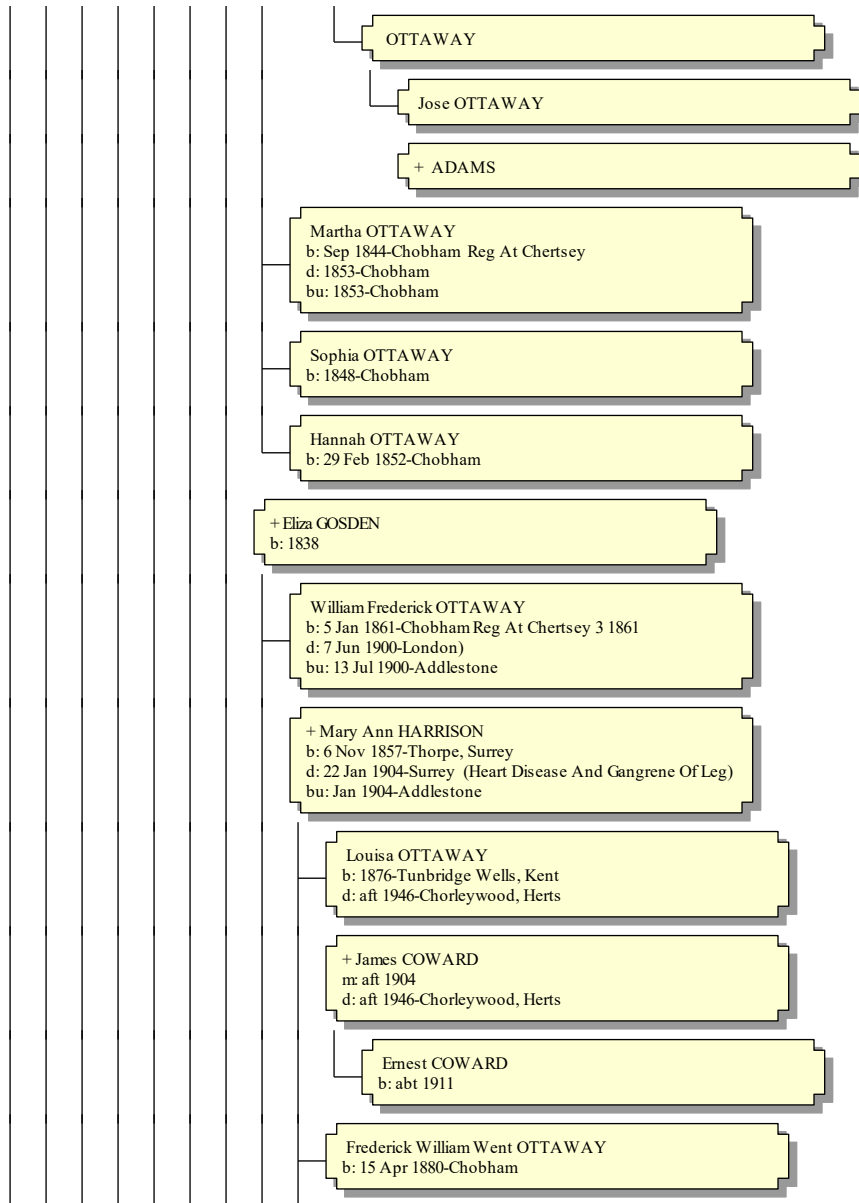

Descendants of (AYU) OTWAY

5 October 2021

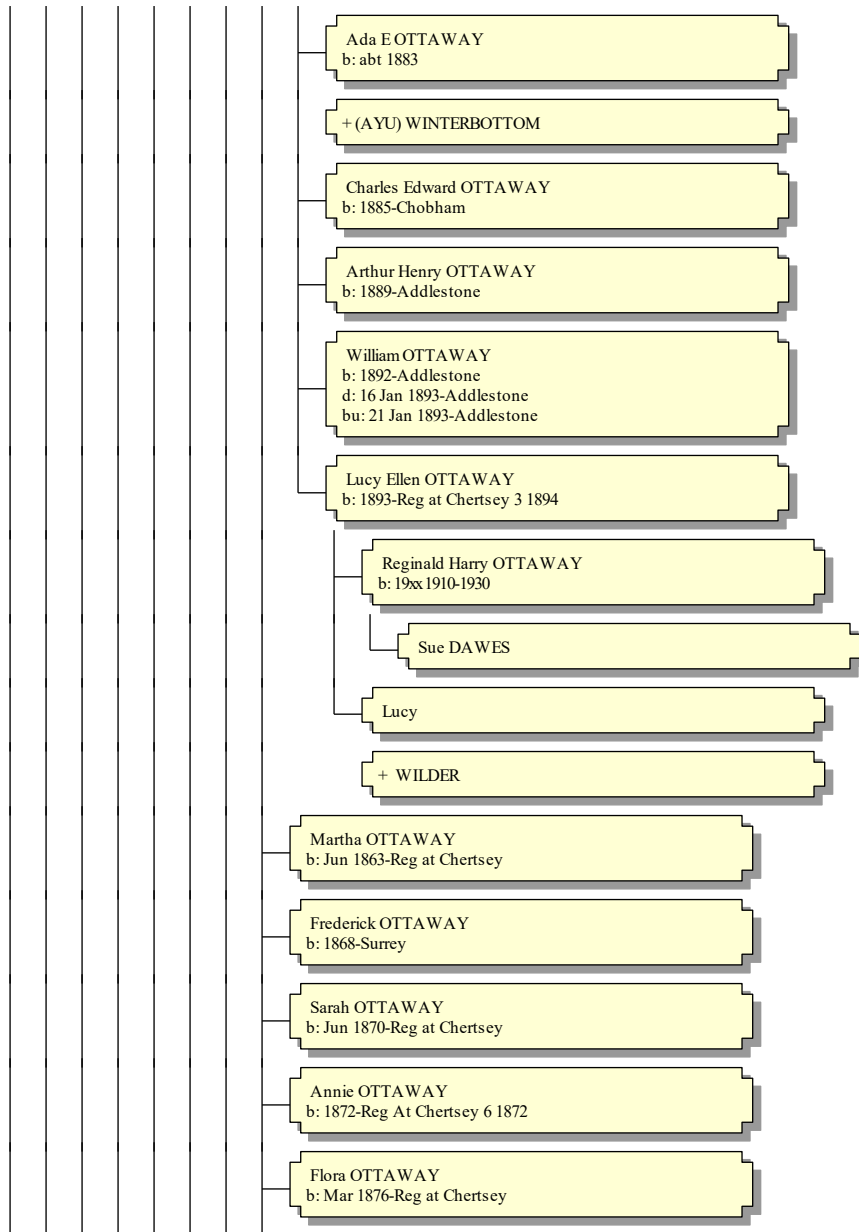

Descendants of (AYU) OTWAY

5 October 2021

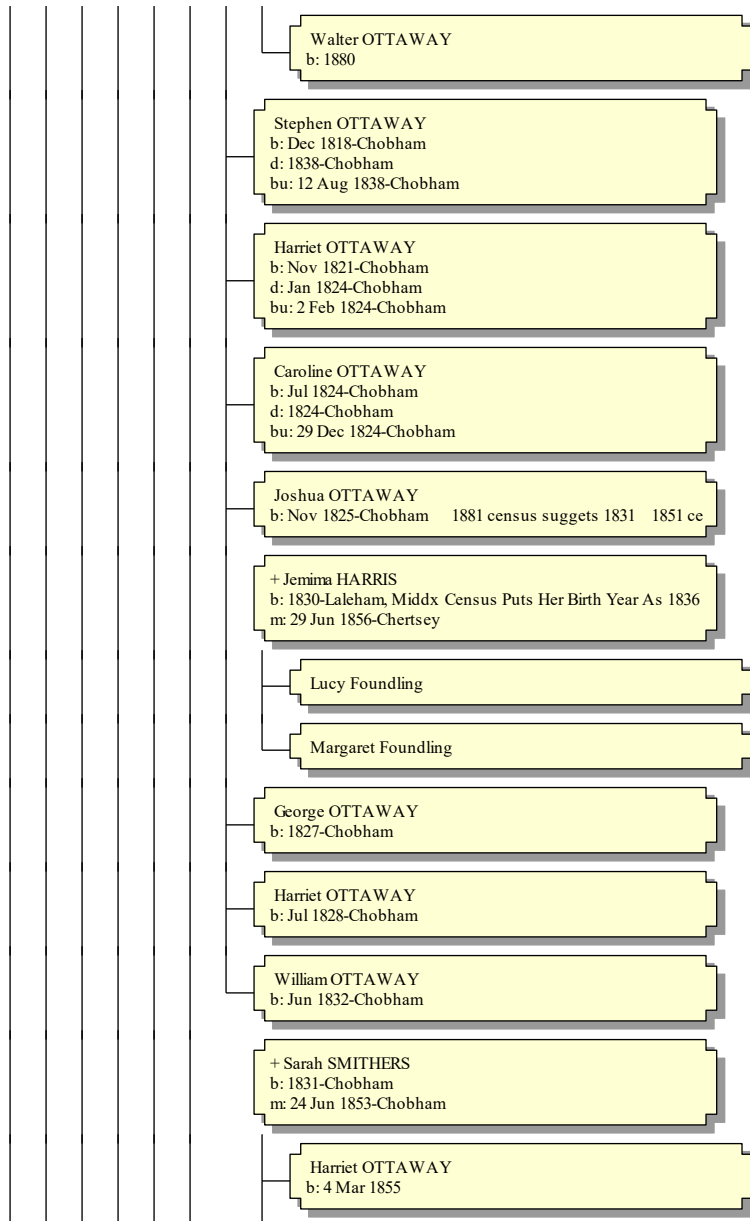

Descendants of (AYU) OTWAY

5 October 2021

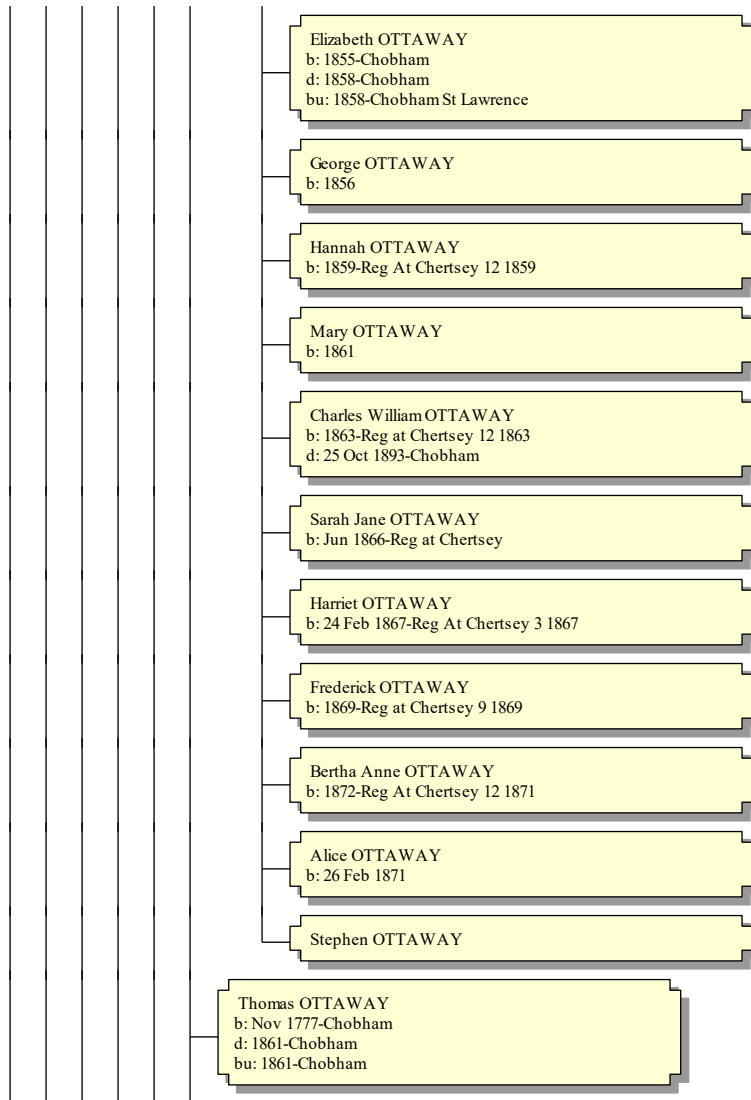

Descendants of (AYU) OTWAY

5 October 2021

+ Lydia SALE
b: 1778
m: 24 Oct 1802-Chobham
d: 1844-Chobham Reg Chertsey March 1844
bu: 1844-Chobham

Jane OTTAWAY
b: Mar 1803-Chobham
d: abt 1803

Jane OTTAWAY
b: Jan 1805-Chobham

+ William CRANE
m: 14 Aug 1825-Chobham

William OTTAWAY
b: Jun 1806-Chobham
d: Dec 1815-Chobham
bu: 2 Jan 1816-Chobham

Joseph OTTAWAY
b: Mar 1808-Chobham

+ Sarah

Eliza OTTAWAY
b: 1832

William OTTAWAY
b: 1834

James OTTAWAY
b: 1839-Surrey
d: aft 1881

Robert OTTAWAY
b: 8 Feb 1846-Chobham Reg At Chertsey 3 1846

George OTTAWAY
b: 21 Jan 1844-Chobham
d: 1852-Chobham
bu: 1852-Chobham

Descendants of (AYU) OTWAY

5 October 2021

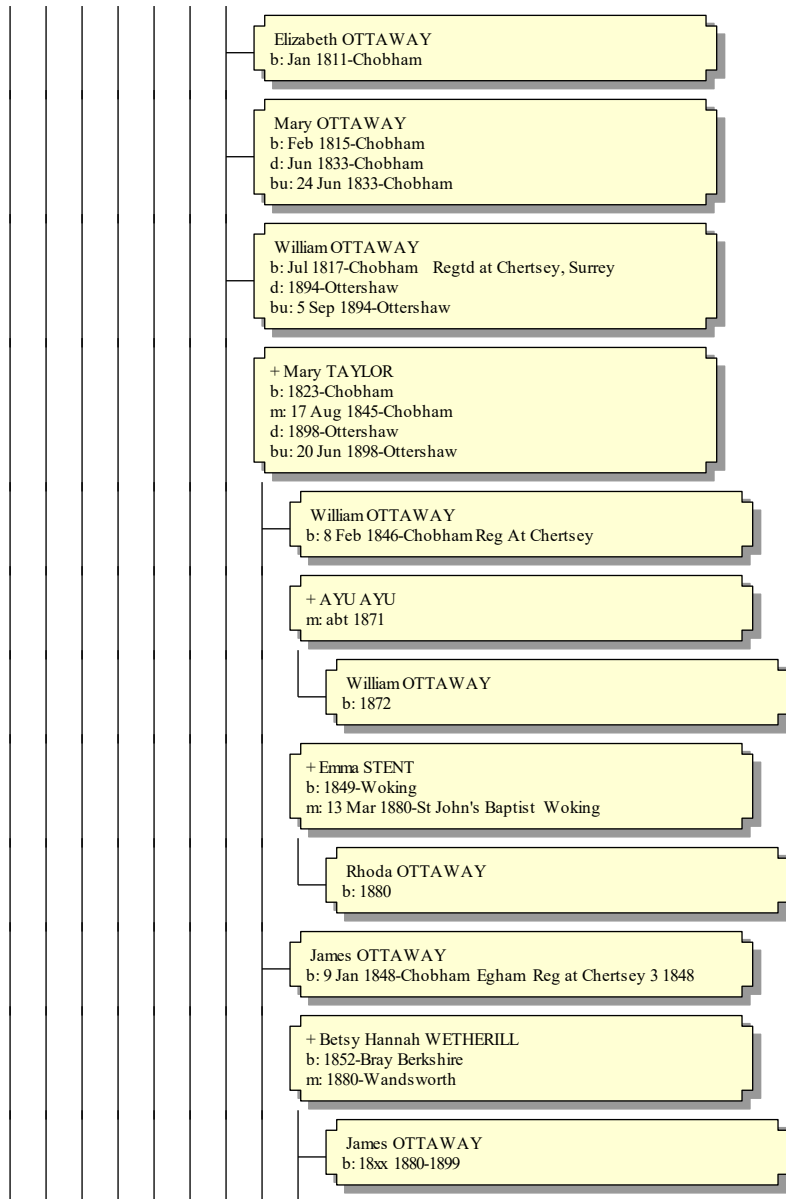

Descendants of (AYU) OTWAY

5 October 2021

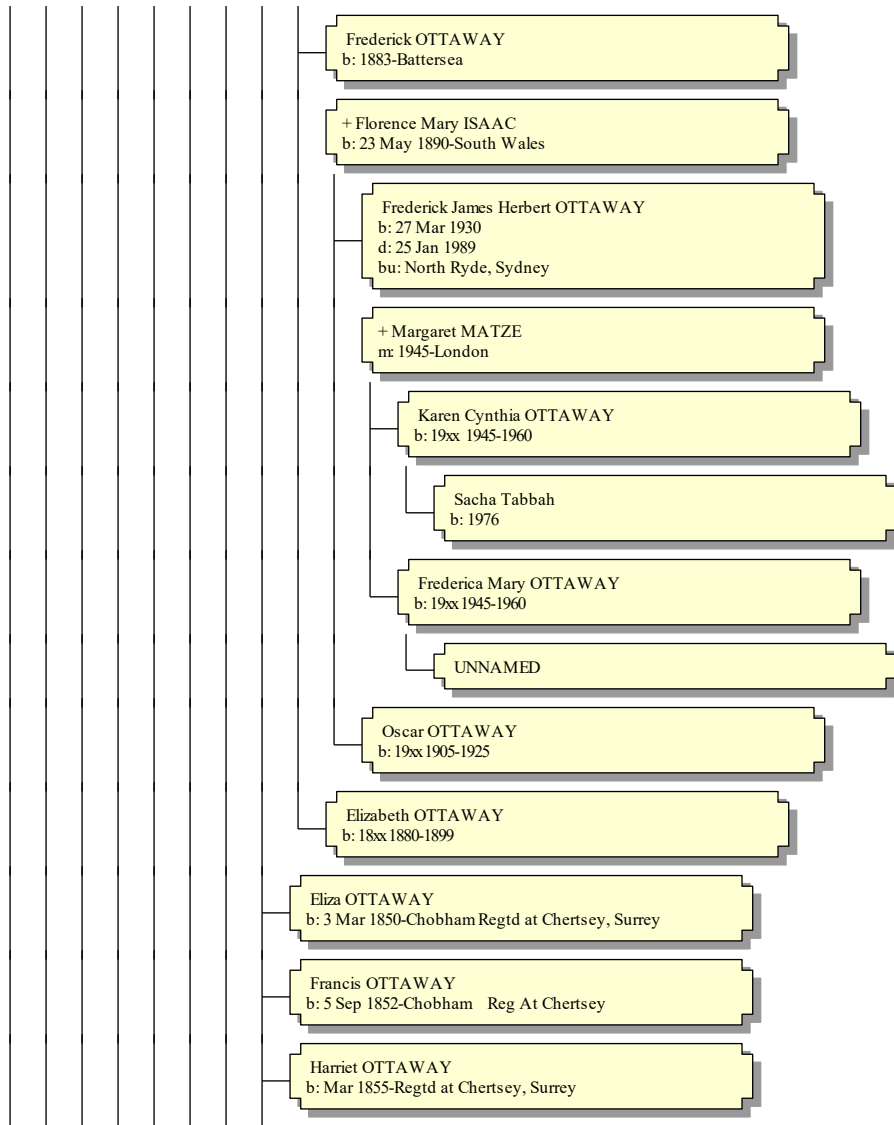

Descendants of (AYU) OTWAY

5 October 2021

Thomas OTTAWAY
b: 1857-Chobham Regtd at Chertsey, Surrey
d: 1950-Regtd at Chertsey, Surrey
bu: 8 Dec 1950-Ottershaw

+ Charlotte CHOAT
b: 1867
m: 16 Jan 1892-Ottershaw, Surrey
d: May 1961-Green Lane, Addlestone
bu: 13 May 1961-Ottershaw

Lotte Hannah May OTTAWAY
b: 1892-Ottershaw
d: ABT

+ J PIPER

(AYU) PIPER

Stephen OTTAWAY
b: 5 May 1859-Chobham Regtd at Chertsey, Surrey
d: 28 Jun 1933-Holly Brox, Ottershaw
bu: 24 Jun 1933-Ottershaw Church

+ Mary Ann MEPHAN
b: 1856-Longcross
m: 8 Apr 1882-Ottershaw Regtd at Chertsey, Surrey
d: 3 Sep 1893-Chertsey
bu: 22 Jul 1893-Ottershaw

William OTTAWAY
b: 3 Mar 1883-Ottershaw.... Regtd At Chertsey, Surrey
d: 27 Mar 1947-Ottershaw.... Regtd At Chertsey, Surrey
bu: 31 Mar 1947-Ottershaw

+ Helen Louisa HAYNES
b: 1880
d: 15 Apr 1952-Croydon
bu: 19 Apr 1952-Ottershaw

Edith May OTTAWAY
b: 1908-Tithe Barn Cottages, Longford, Middlesex
d: maybe 13 Feb 1975-Melbourne Australia
bu: Australia

Descendants of (AYU) OTWAY

5 October 2021

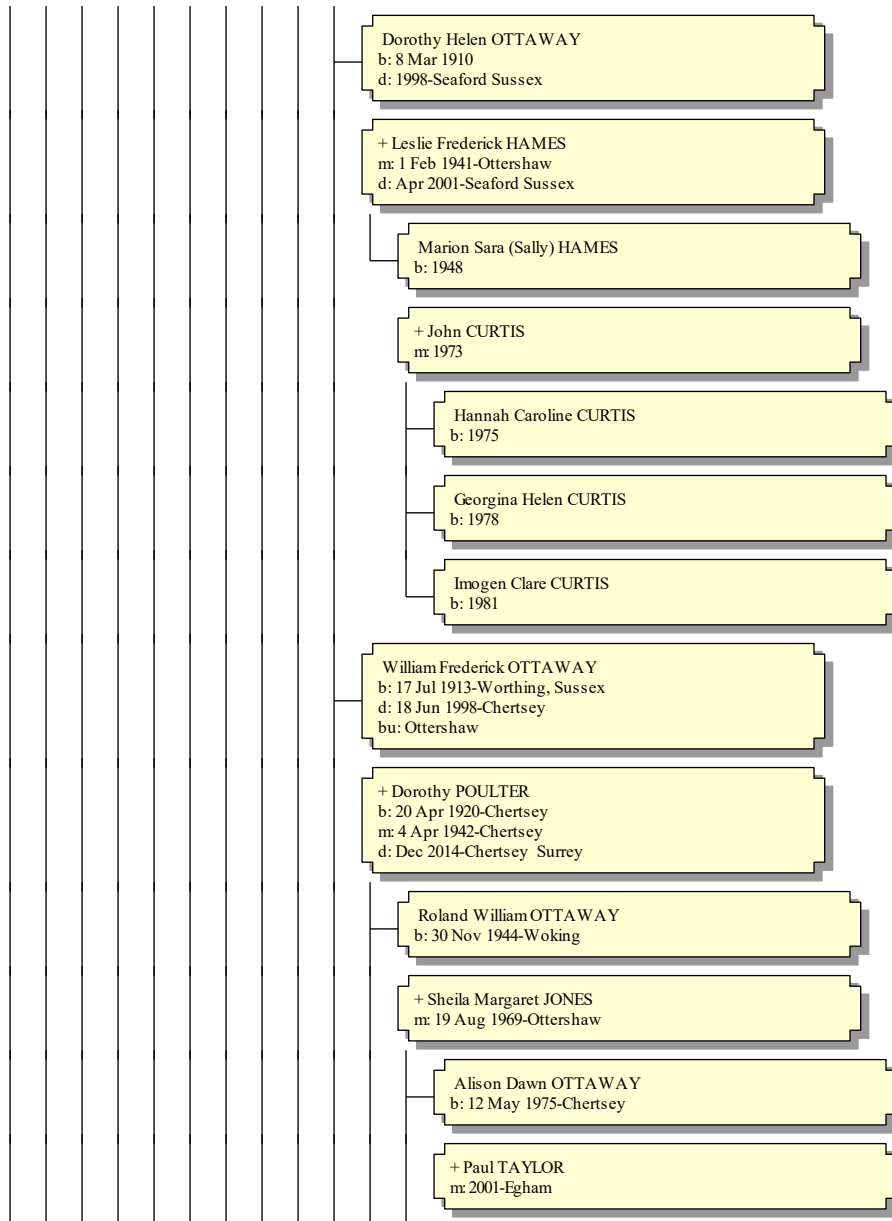

Descendants of (AYU) OTWAY

5 October 2021

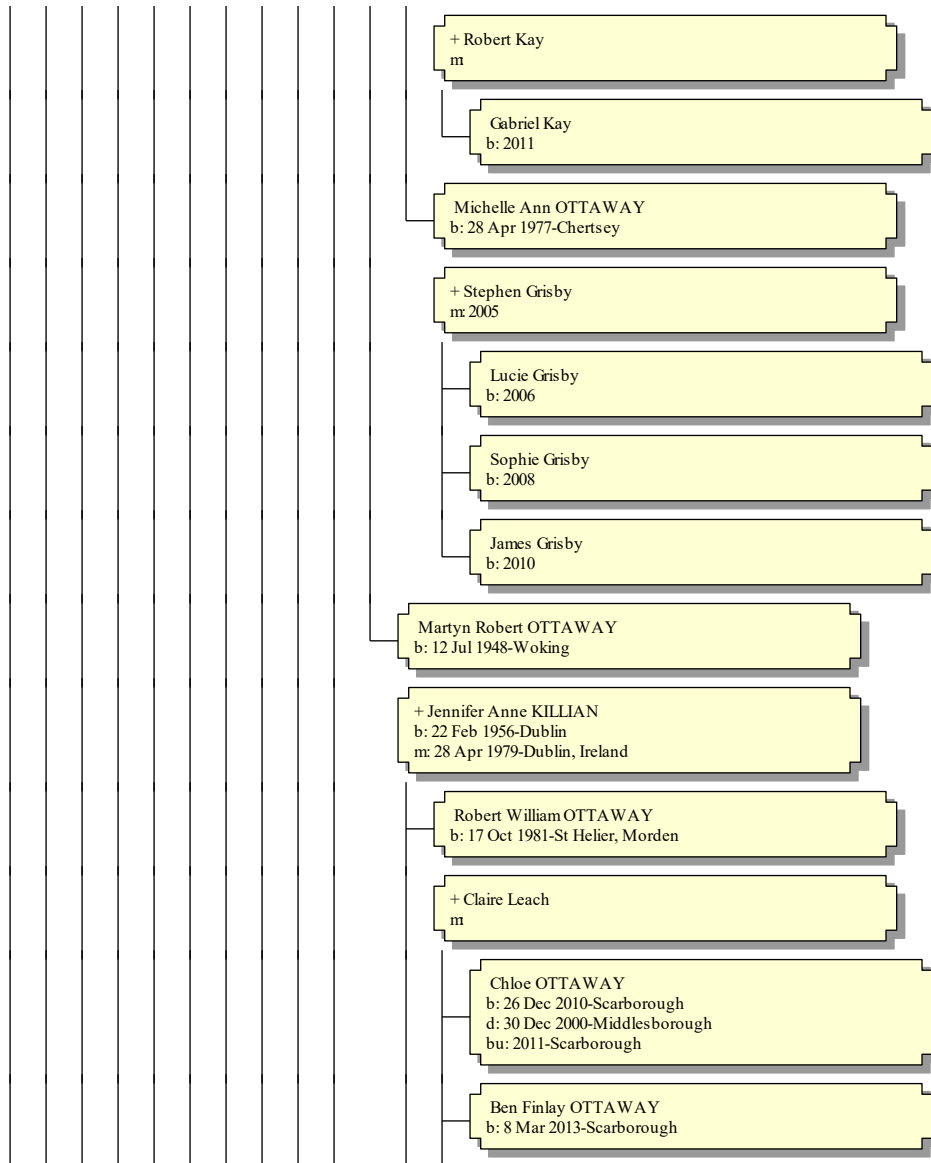

Descendants of (AYU) OTWAY

5 October 2021

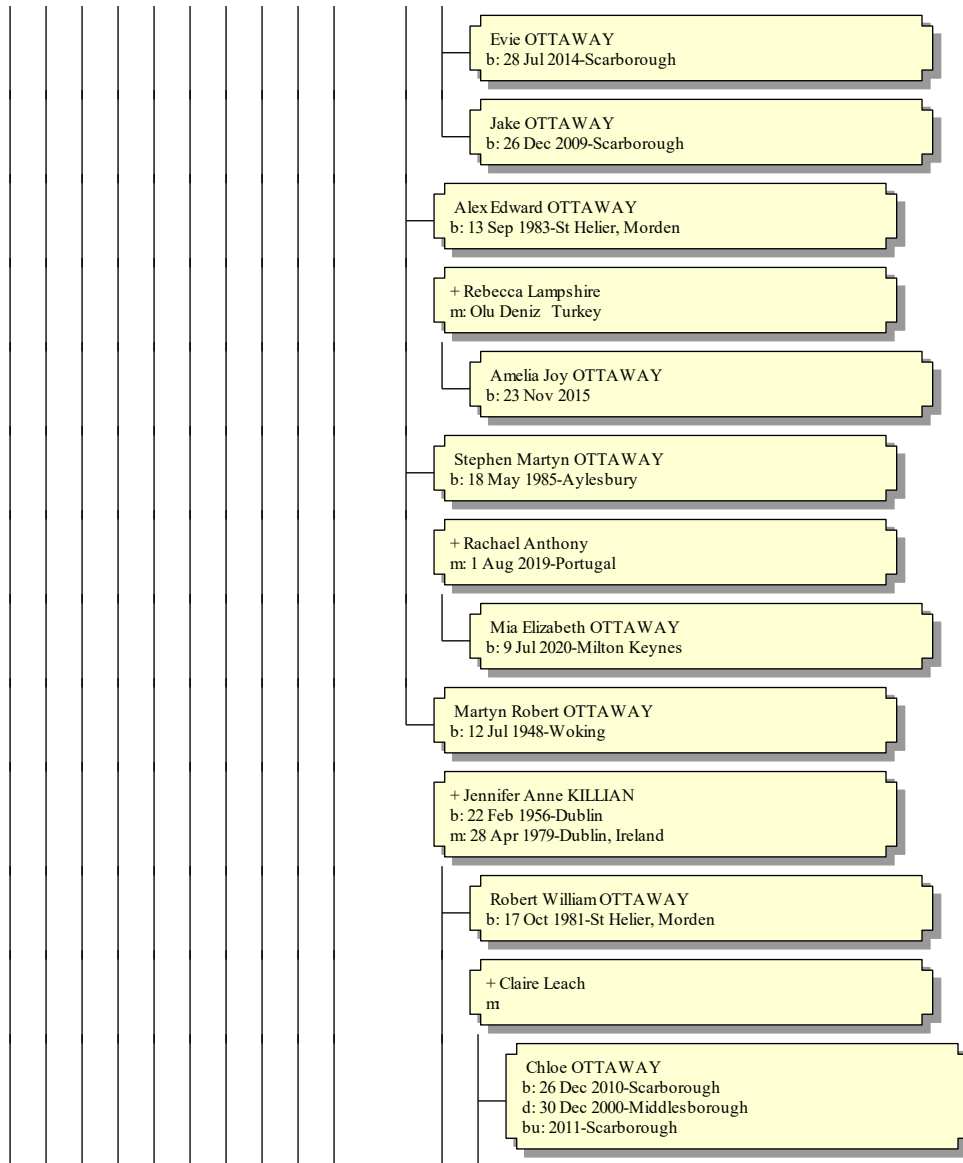

Descendants of (AYU) OTWAY

5 October 2021

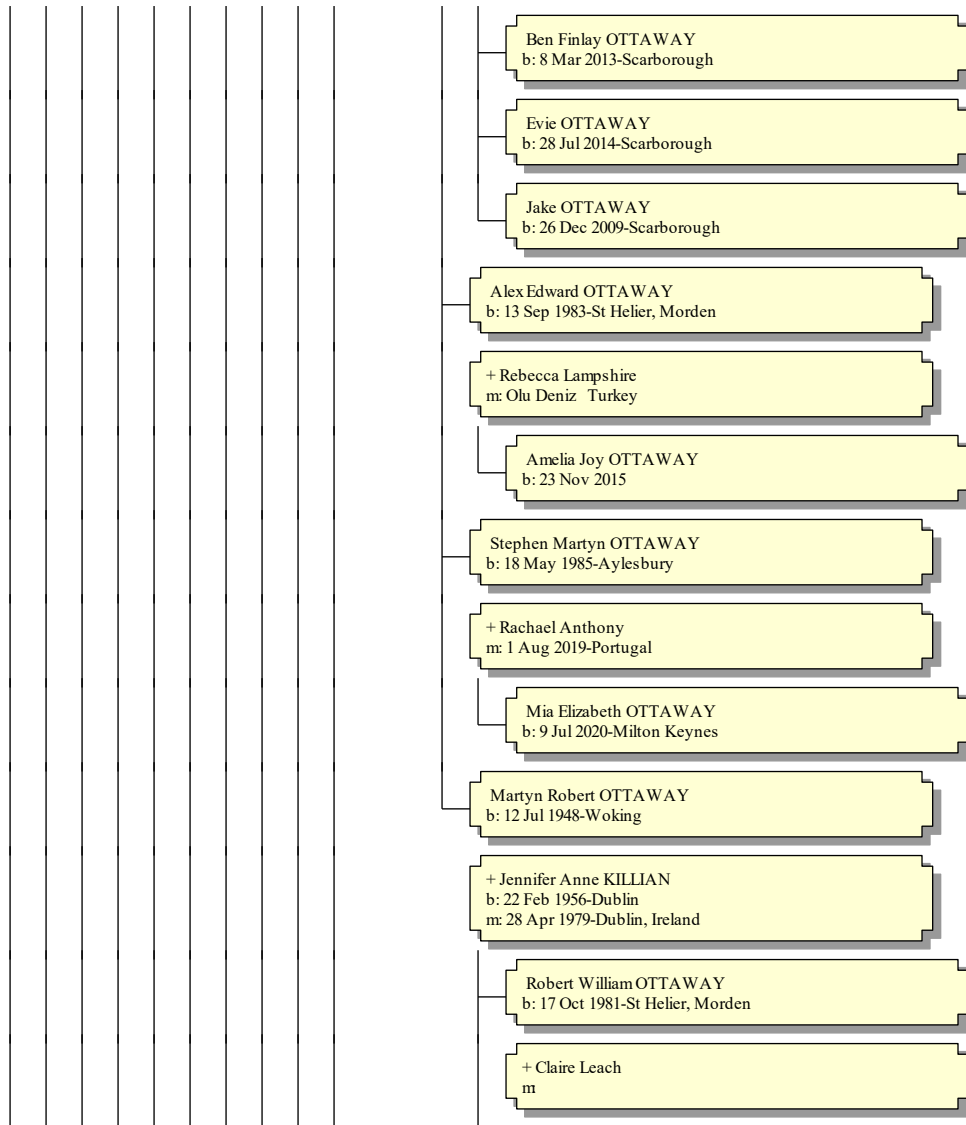

Descendants of (AYU) OTWAY

5 October 2021

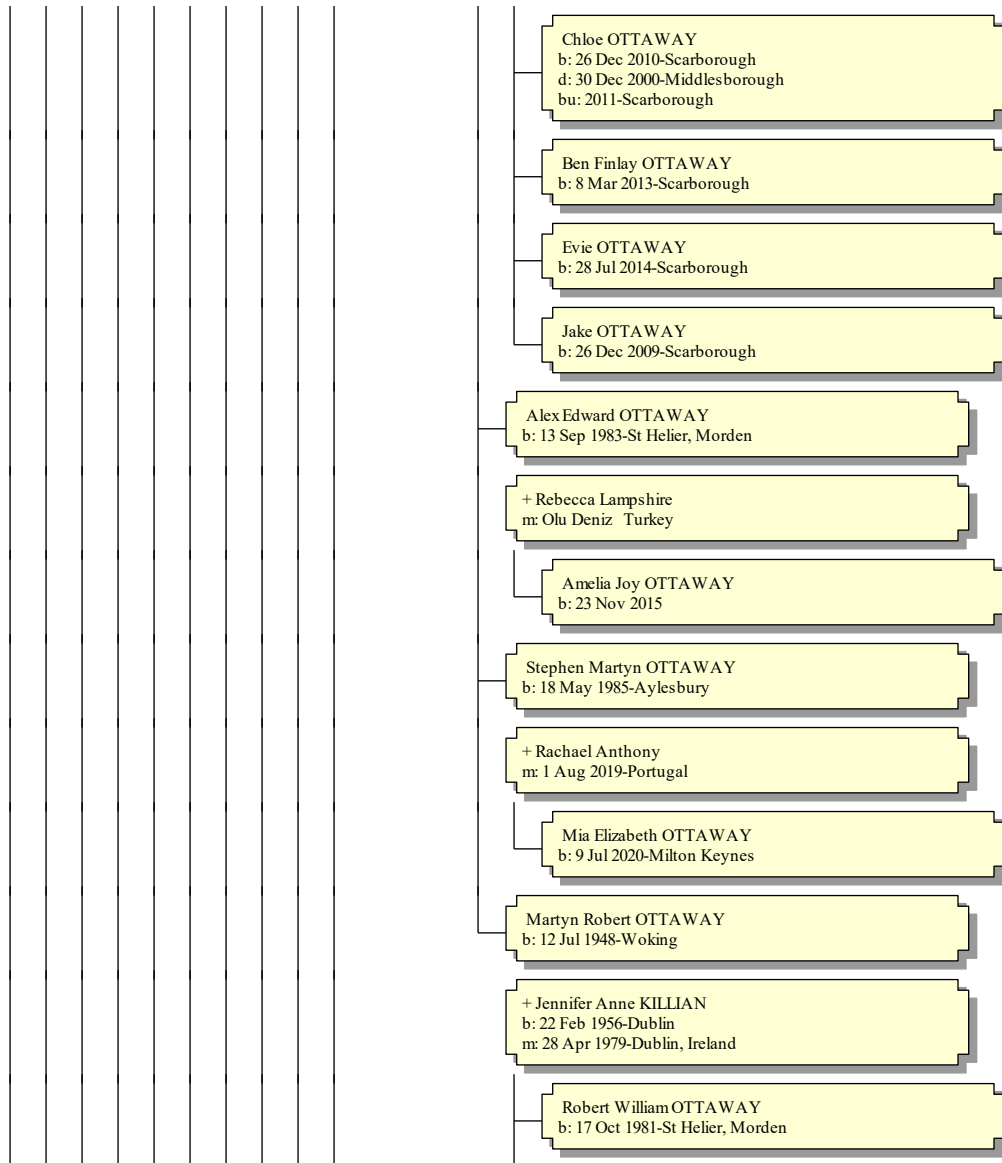

Descendants of (AYU) OTWAY

5 October 2021

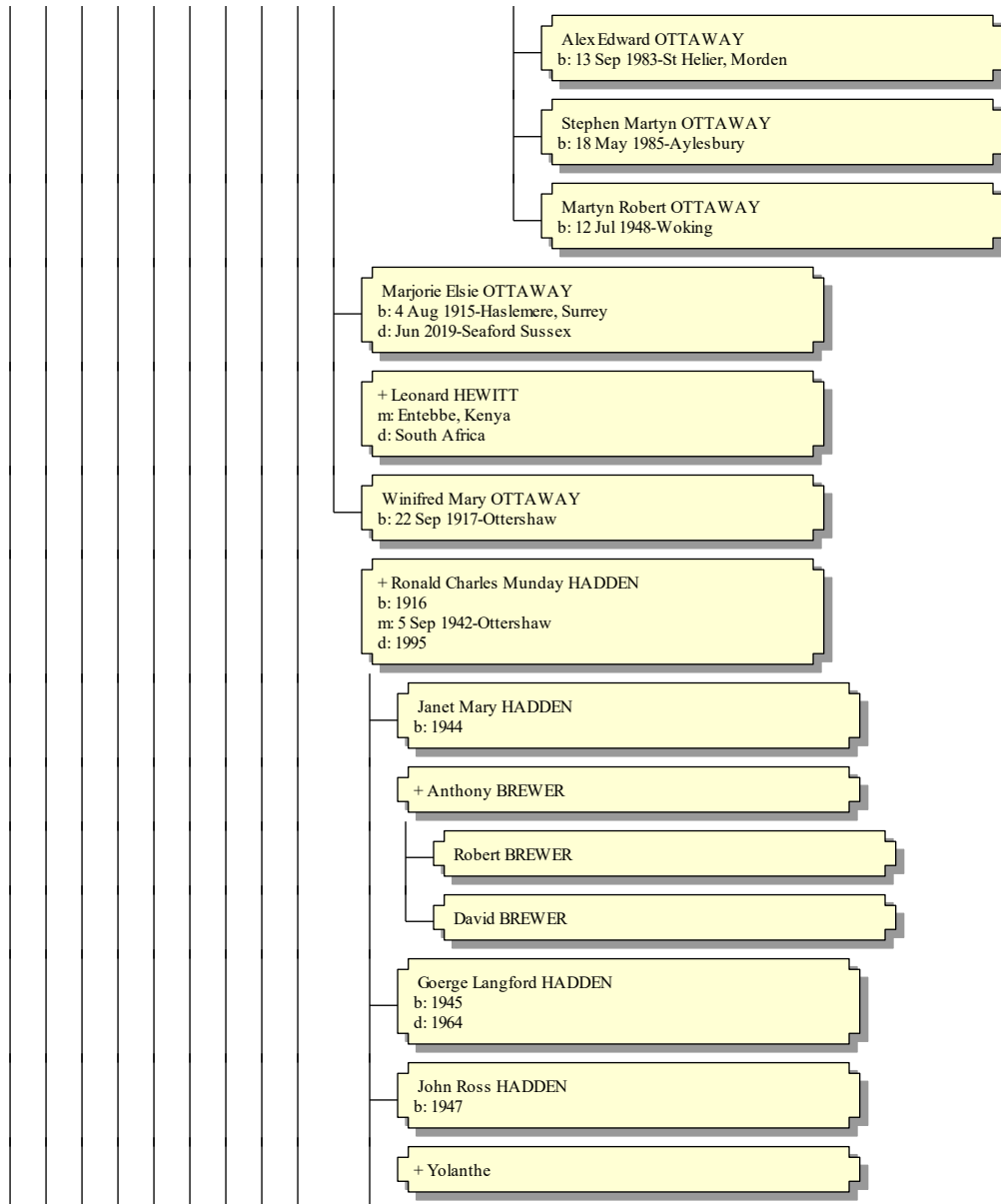

Descendants of (AYU) OTWAY

5 October 2021

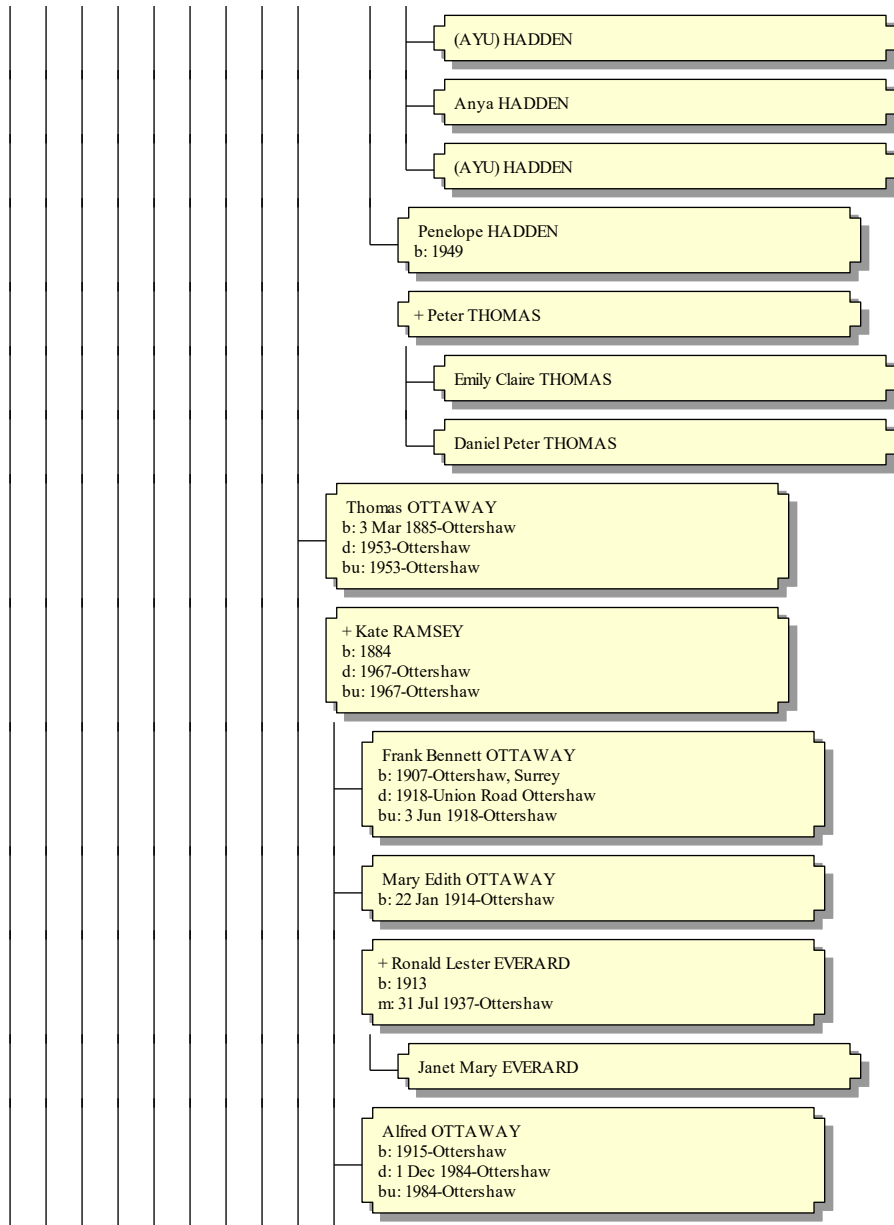

Descendants of (AYU) OTWAY

5 October 2021

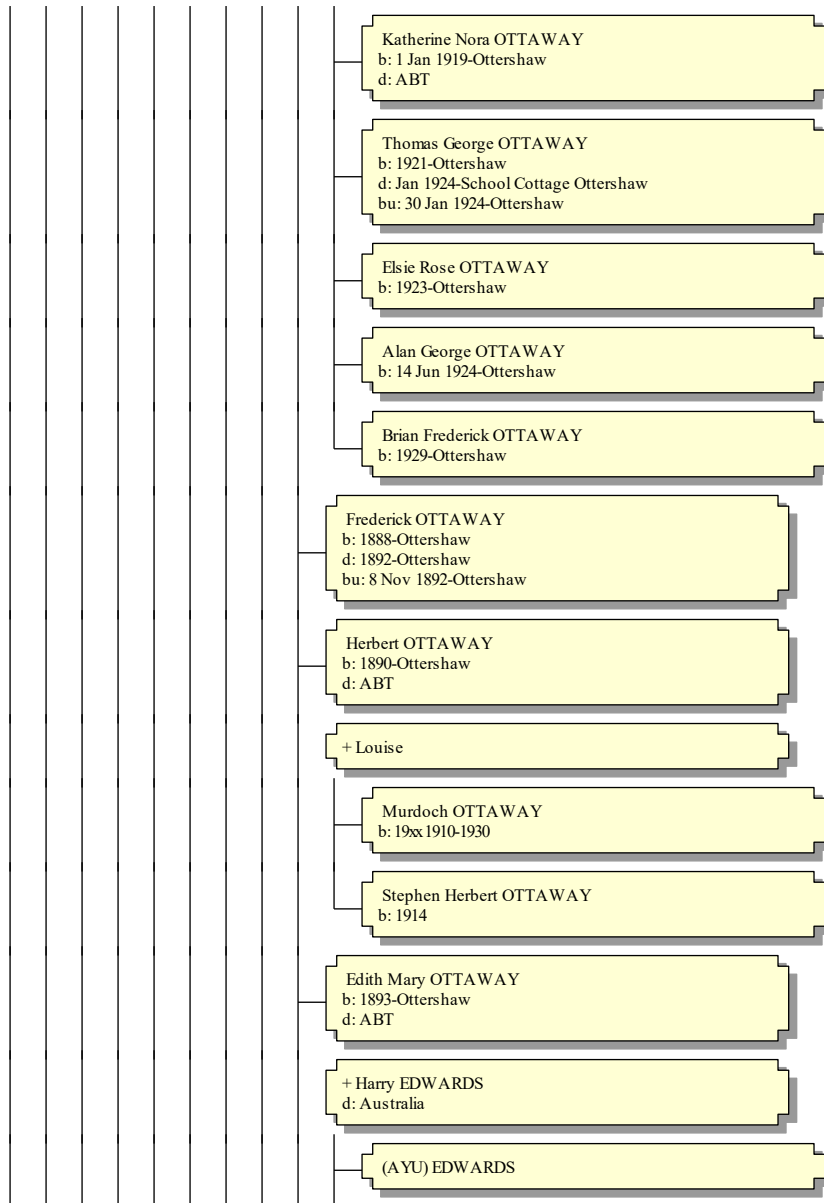

Descendants of (AYU) OTWAY

5 October 2021

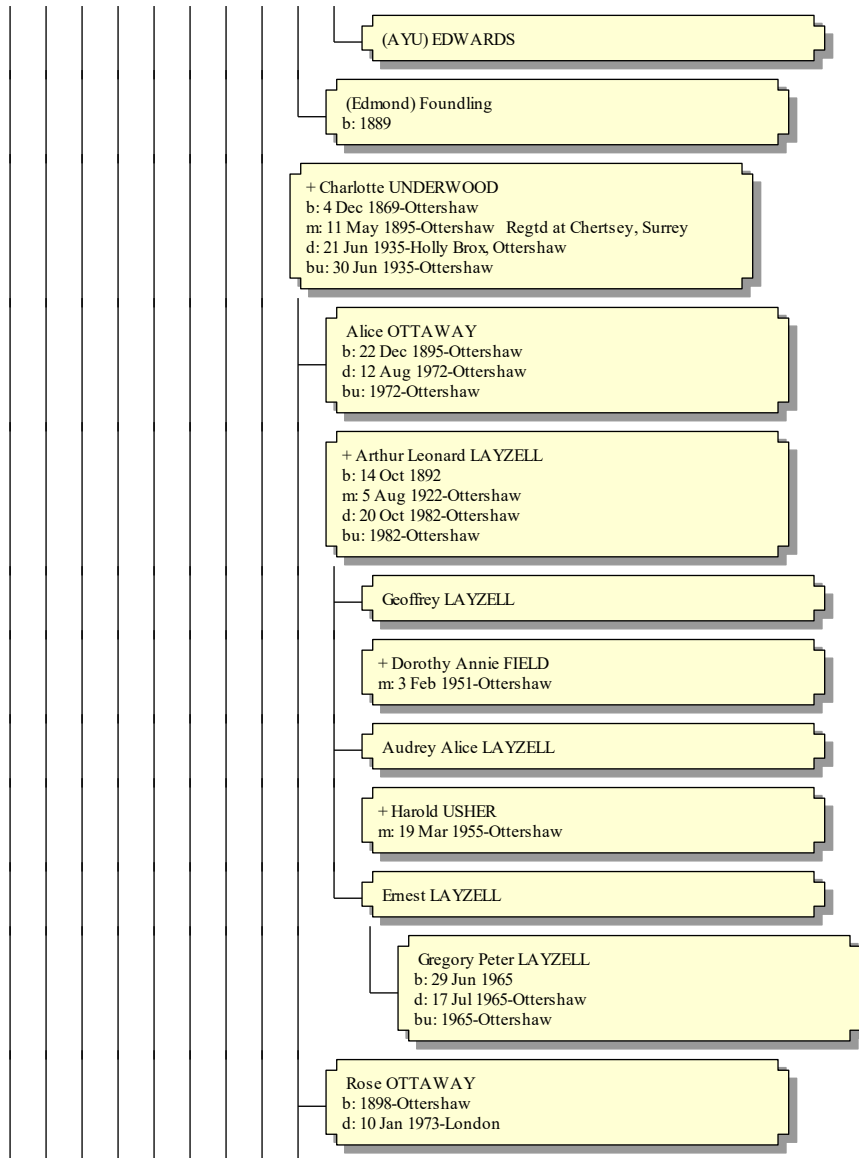

Descendants of (AYU) OTWAY

5 October 2021

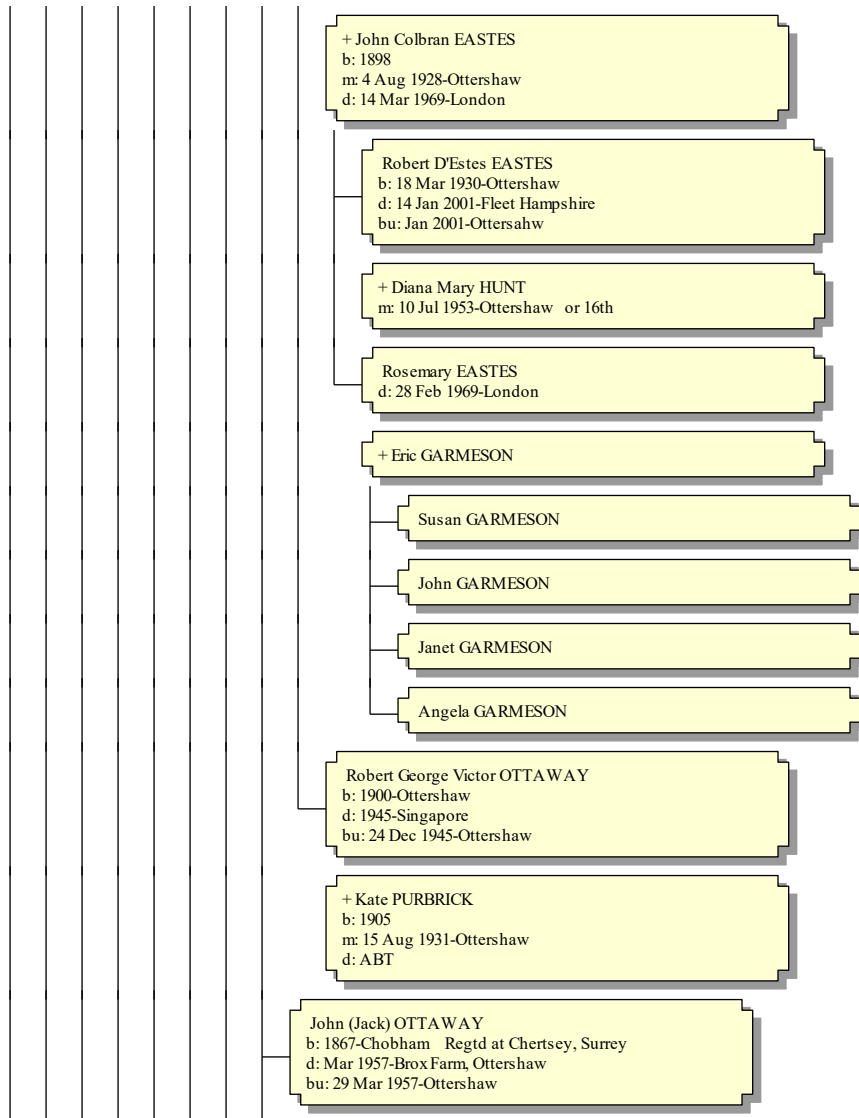

Descendants of (AYU) OTWAY

5 October 2021

+ Caroline ROWE
b: 1868-Langham, Norfolk
m: 31 Mar 1887-Ottershaw
d: 1898-Ottershaw
bu: 2 Apr 1898

Ethel May OTTAWAY
b: 1887-Ottershaw

Charles Frederick OTTAWAY
b: 2 Jan 1889-Ottershaw

Elsie Maud OTTAWAY
b: 1891-Ottershaw

+ George PURBRICK

+ Ellen Louisa
b: abt 1879
m: 1901
d: Dec 1948-Brox Farm, Ottershaw
bu: 31 Dec 1948-Ottershaw

Mabel Annie OTTAWAY
b: 21 Sep 1904-Ottershaw, Surrey
d: 20 Sep 1985-Woking

+ Harold CRANSTON
b: 20 Dec 1906-Addlestone, Surrey
m: 17 Nov 1934-Ottershaw
d: 31 Aug 1991-Addlestone, Surrey

Roy CRANSTON
b: 28 Apr 1936-Addlestone, Surrey

+ Joyce Ann DIDCOCK
b: 23 Jan 1937-West Byfleet
m: 25 Oct 1958-West Byfleet

Andrew Gordon CRANSTON
b: 27 Jul 1964-Woking

+ Sarah Jane RICE
m: 20 Aug 1994

Descendants of (AYU) OTWAY

5 October 2021

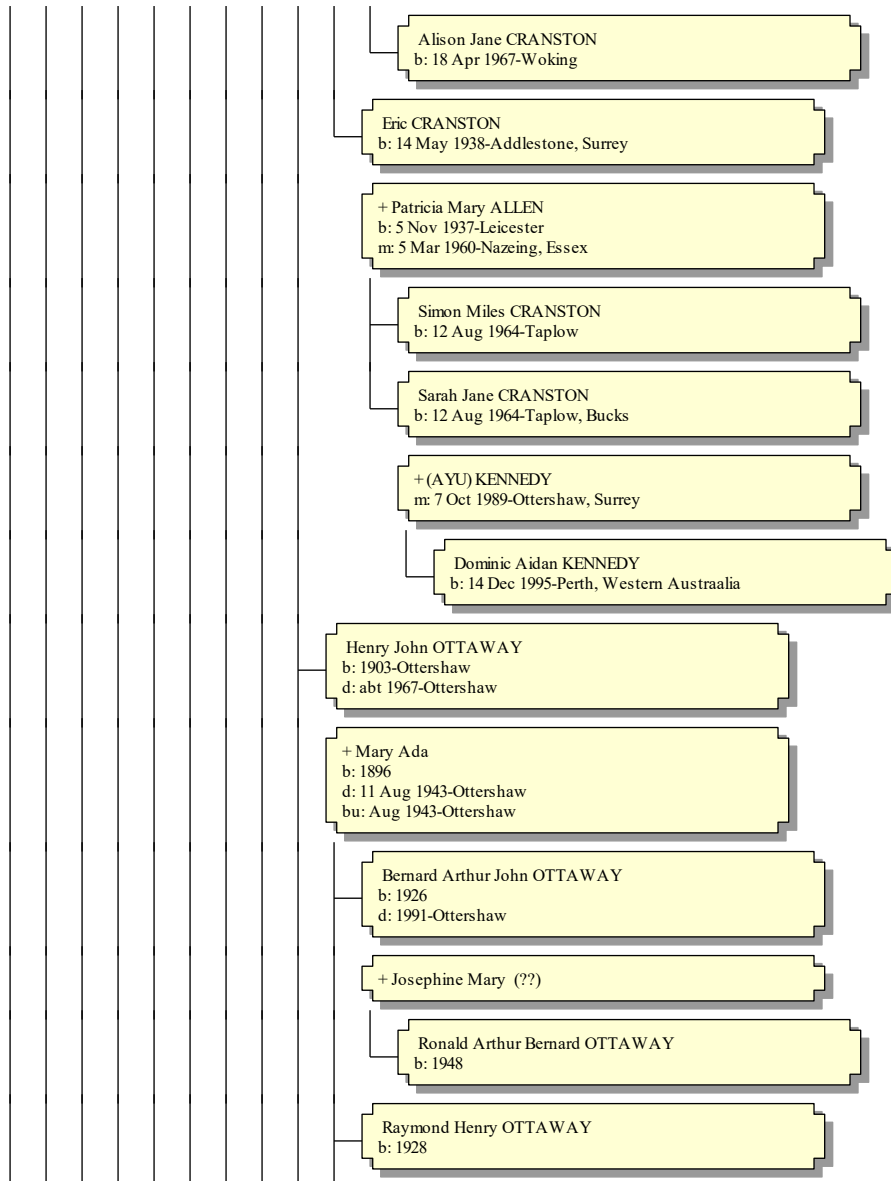

Descendants of (AYU) OTWAY

5 October 2021

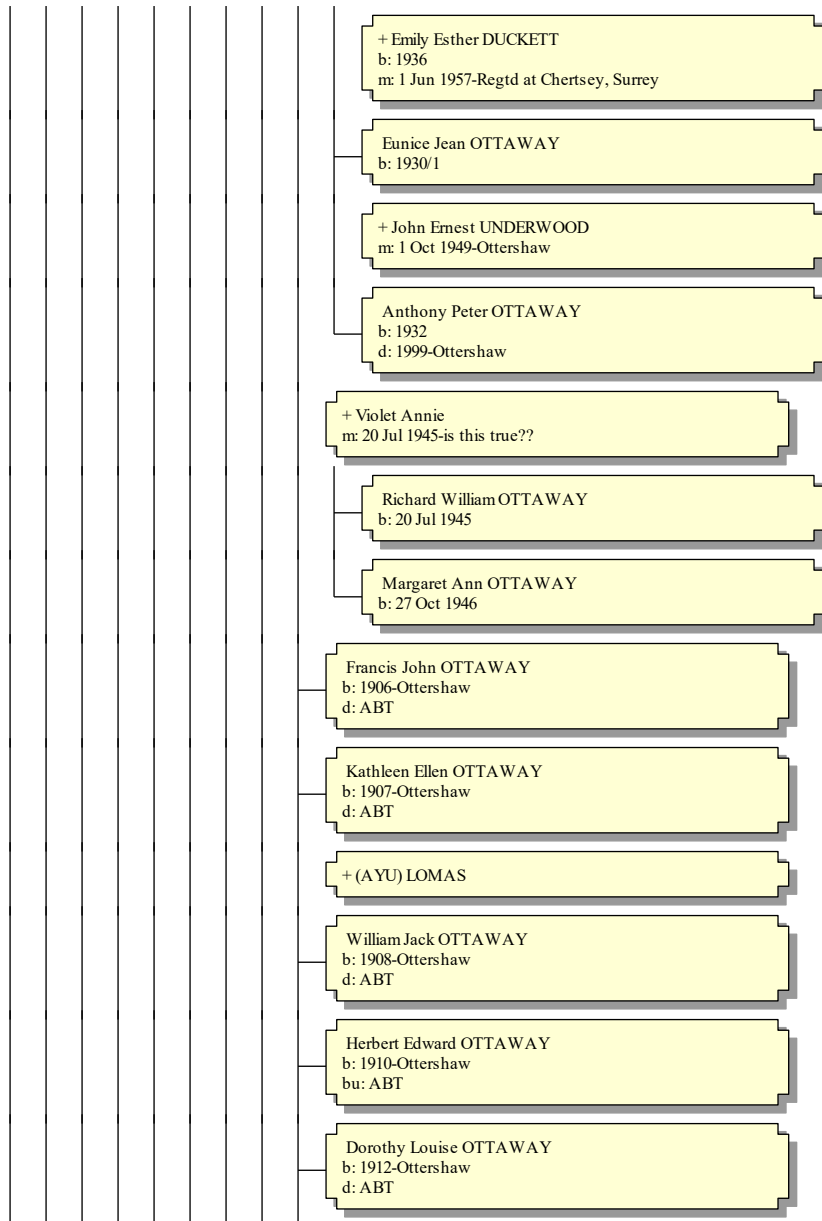

Descendants of (AYU) OTWAY

5 October 2021

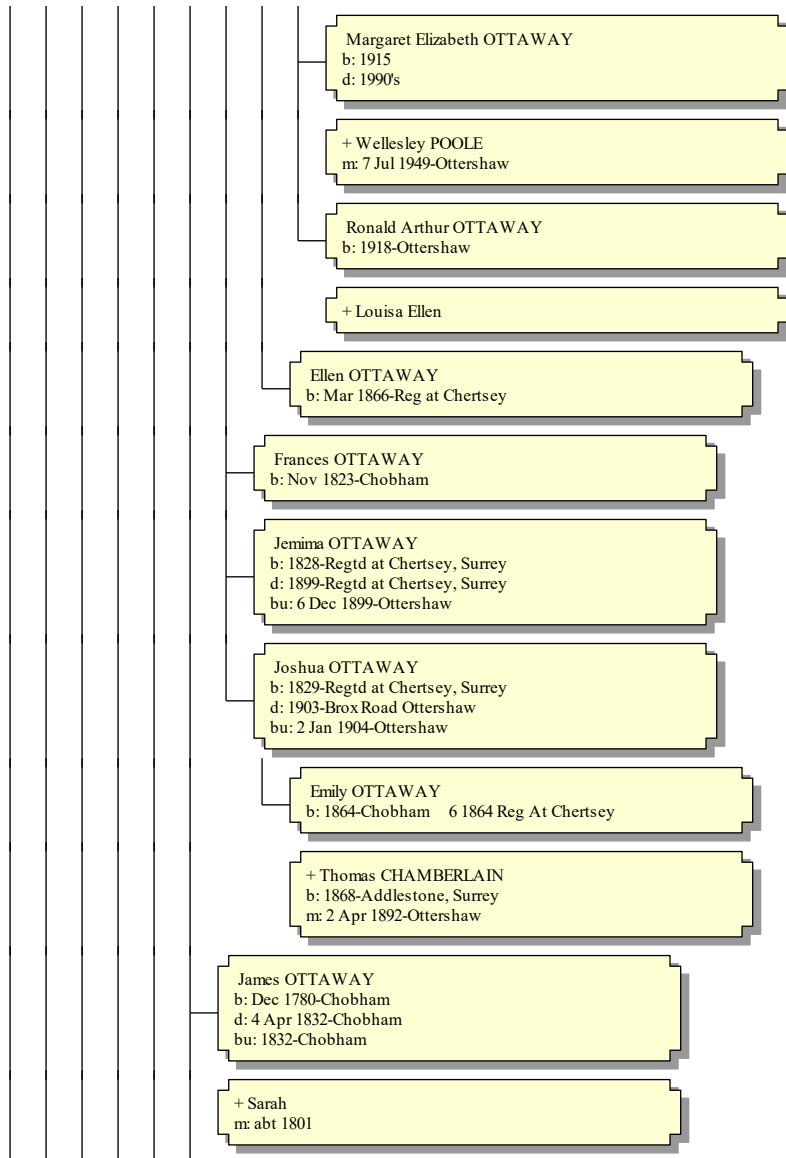

Descendants of (AYU) OTWAY

5 October 2021

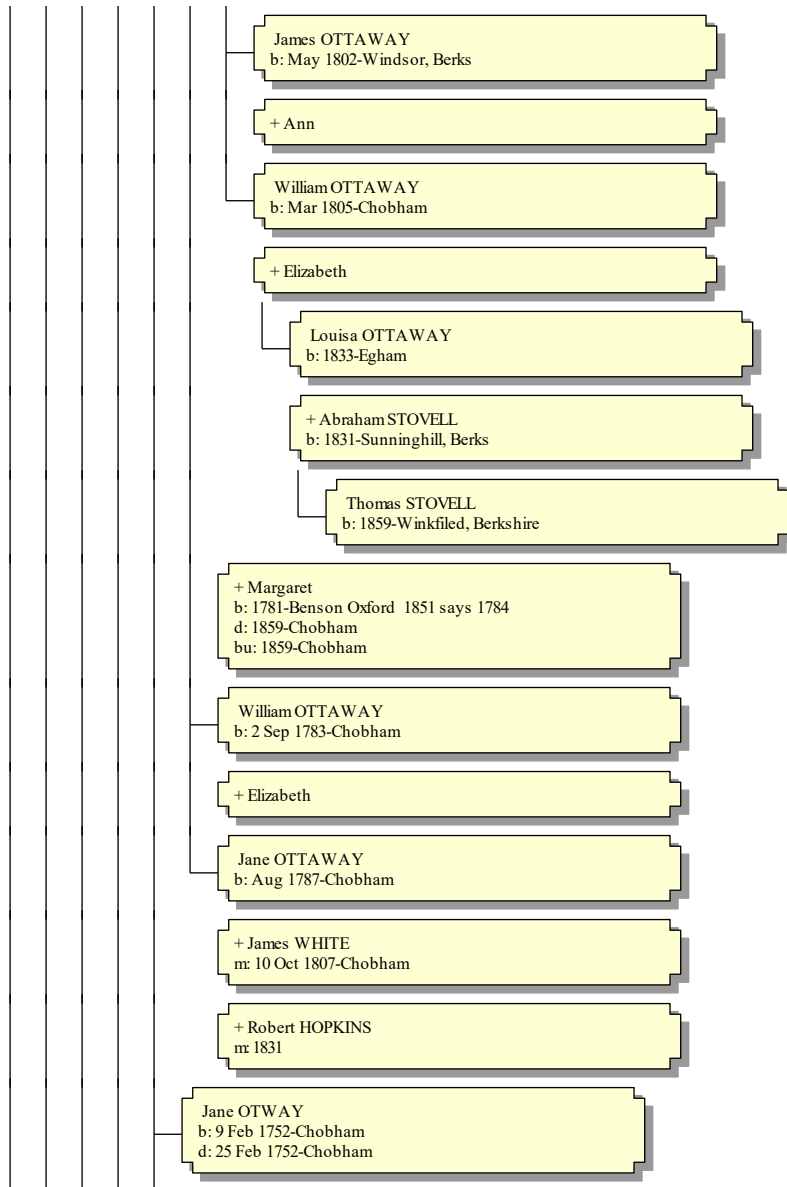

Descendants of (AYU) OTWAY

5 October 2021

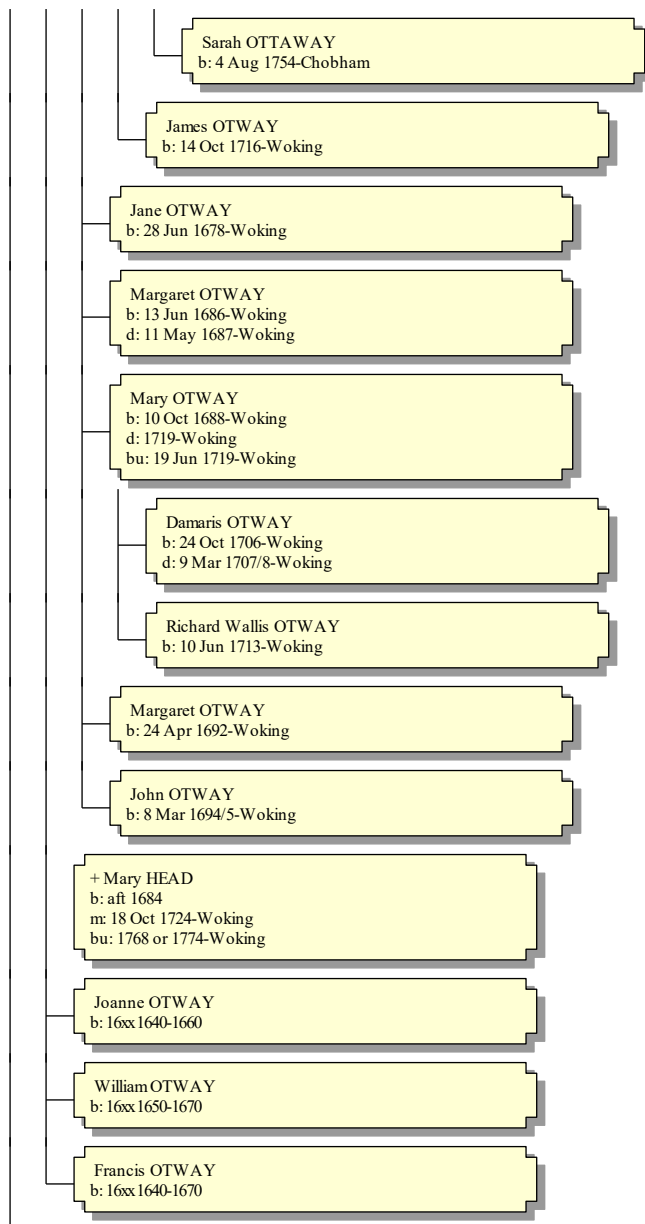

Descendants of (AYU) OTWAY

5 October 2021

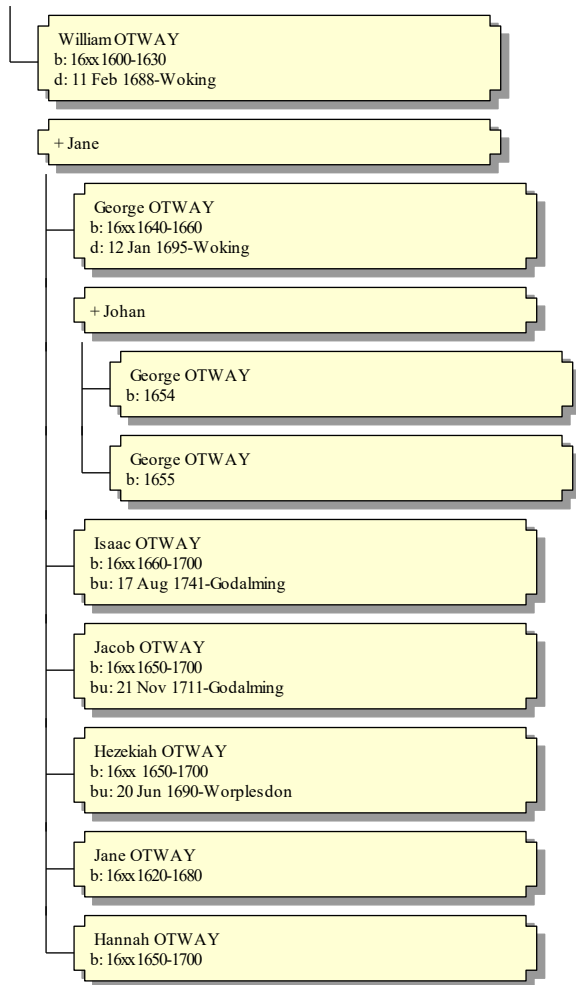

Prepared 5 October 2021 by:

<NO SURNAME>

(AYU) . . . 1
 Ann . . . 47
 Eliza (b. 1844) . . . 14
 Elizabeth . . . 47
 Elizabeth (b. 1777) . . . 3
 Elizabeth (b. 1782) . . . 11
 Elizabeth (b. 1817) . . . 10
 Elizabeth (b. 1824) . . . 6
 Ellen Louisa (b. 1879) . . . 43
 Emily (b. 1867) . . . 22
 Frances (b. 1818) . . . 16
 Harriet (b. 1868) . . . 13
 Ina (b. 1839) . . . 13
 Jane . . . 49
 Jane (b. 1738) . . . 4
 Joanne . . . 1
 Johan . . . 49
 Josephine Mary (??) . . . 44
 Louisa Ellen . . . 46
 Louise . . . 40
 Lucy . . . 26
 Margaret . . . 1
 Margaret (b. 1781) . . . 47
 Mary . . . 1–2
 Mary A (b. 1820) . . . 6
 Mary Ada (b. 1896) . . . 44
 Sacha Tabbah (b. 1976) . . . 31
 Sarah . . . 29, 46
 Sarah (b. 1840) . . . 15
 Sarah (b. 1842) . . . 22
 Sarah (b. 1866) . . . 23
 UNNAMED . . . 31
 Violet Annie . . . 45
 Yolante . . . 38

ADAMS
 . . . 25

ALLEN
 Patricia Mary (b. 1937) . . . 44

ANTHONY
 Rachael . . . 35–37

AYU
 AYU . . . 30

BAIGENT
 Mary (b. 1821) . . . 9

BAKER
 Mary . . . 11

BEARD
 . . . 20

BESSEY
 James . . . 19

BLAKE
 Margaret Rose . . . 20

BOND
 Fanny Elizabeth (b. 1865) . . . 18

BREWER
 Anthony . . . 38
 David . . . 38
 Robert . . . 38

BULLEN
 Sarah . . . 11

CANNEN
 Mary (b. 1801) . . . 12

CHAMBERLAIN
 Thomas (b. 1868) . . . 46

CHARLES
 Carolyn . . . 22

CHOAT
 Charlotte (b. 1867) . . . 32

COBBETT
 Alice (b. 1844) . . . 8
 Carmi (b. 1811) . . . 8
 Eliza (b. 1832) . . . 8
 Eliza C (b. 1850) . . . 8
 Henry (b. 1842) . . . 8
 James (b. 1847) . . . 8
 Mary Ann (b. 1840) . . . 8

COLLYER
 Ann (b. 1793) . . . 5
 Emily . . . 20

COWARD
 Ernest (b. 1911) . . . 25
 James . . . 25

CRAFTS
 Gary . . . 19

CRANE
 Thomas . . . 15
 William . . . 29

CRANSTON
 Alison Jane (b. 1967) . . . 44
 Andrew Gordon (b. 1964) . . . 43
 Eric (b. 1938) . . . 44
 Harold (b. 1906) . . . 43
 Roy (b. 1936) . . . 43
 Sarah Jane (b. 1964) . . . 44
 Simon Miles (b. 1964) . . . 44

CURTIS
 Georgina Helen (b. 1978) . . . 33
 Hannah Caroline (b. 1975) . . . 33
 Imogen Clare (b. 1981) . . . 33
 John . . . 33

DAWES
 (AYU) . . . 19
 Sue . . . 26

DIDCOCK
 Joyce Ann (b. 1937) . . . 43

DREW
 Emma (b. 1843) . . . 17

DUCKETT
 Emily Esther (b. 1936) . . . 45

EASTES
 John Colbran (b. 1898) . . . 42
 Robert D'Estes (b. 1930) . . . 42
 Rosemary . . . 42

EDWARDS
 (AYU) . . . 40–41
 Harry . . . 40

EVERARD

- Janet Mary . . . 39
 Ronald Lester (b. 1913) . . . 39
- FEATENBY
 Glen . . . 21
- FIELD
 Dorothy Annie . . . 41
- FOUNDLING
 (Edmond) (b. 1889) . . . 41
 Lucy . . . 27
 Margaret . . . 27
- FRANCIS
 Jessie Edith . . . 21
- GARMESON
 Angela . . . 42
 Eric . . . 42
 Janet . . . 42
 John . . . 42
 Susan . . . 42
- GIBSON
 Denise Ann . . . 19
- GILLETT
 (AYU) . . . 2
- GOLDING
 Sophia (b. 1808) . . . 24
- GOSDEN
 Eliza (b. 1838) . . . 25
- GREENER
 Sarah (b. 1778) . . . 16
- GREGORY
 Ivy Violet . . . 18
- GRISBY
 James (b. 2010) . . . 34
 Lucie (b. 2006) . . . 34
 Sophie (b. 2008) . . . 34
 Stephen . . . 34
- GUNNER
 Elizabeth . . . 4
- HADDEN
 (AYU) . . . 39
 Anya . . . 39
 Goerge Langford (b. 1945) . . . 38
 Janet Mary (b. 1944) . . . 38
 John Ross (b. 1947) . . . 38
 Penelope (b. 1949) . . . 39
 Ronald Charles Munday (b. 1916) . . . 38
- HAMES
 Leslie Frederick . . . 33
 Marion Sara (Sally) (b. 1948) . . . 33
- HARMES
 Elizabeth . . . 2
- HARRIS
 Jemima (b. 1830) . . . 27
- HARRISON
 Mary Ann (b. 1857) . . . 25
- HASLETT
 Elizabeth (b. 1805) . . . 6
- HAYNES
 Helen Louisa (b. 1880) . . . 32
- HEAD
 Mary (b. 1684) . . . 48
- HEWITT
 Elizabeth (b. 1817) . . . 17
 Leonard . . . 38
- HOCKLEY
 William Frederick . . . 24
- HOLNESS
 Christine . . . 18
 Ernest . . . 18
 Lesley . . . 18
- HONER
 Eliza (b. 1830) . . . 7
- HOPKINS
 Robert . . . 47
- HOWARD
 Jane (b. 1772) . . . 12
 Lucy . . . 16
- HUGHES
 Ann (b. 1783) . . . 5
- HUNT
 Diana Mary . . . 42
- ISAAC
 Florence Mary (b. 1890) . . . 31
- JARVIS
 Martin John . . . 20
- JONES
 Sheila Margaret . . . 33
- KAY
 Gabriel (b. 2011) . . . 34
 Robert . . . 34
- KEENE
 Sarah (b. 1806) . . . 9
- KENNEDY
 (AYU) . . . 44
 Dominic Aidan (b. 1995) . . . 44
- KENT
 William . . . 9
- KILLIAN
 Jennifer Anne (b. 1956) . . . 34–37
- LAMPSHIRE
 Rebecca . . . 35–37
- LAYZELL
 Arthur Leonard (b. 1892) . . . 41
 Audrey Alice . . . 41
 Ernest . . . 41
 Geoffrey . . . 41
 Gregory Peter (b. 1965) . . . 41
- LEACH
 Claire . . . 34–36
- LEE
 George . . . 5
 John . . . 17
- LOMAS
 (AYU) . . . 45
- MATZE
 Margaret . . . 31
- MCHALE
 Owen George . . . 19
- MEPHAN

- Mary Ann (b. 1856) . . . 32
- MUNDAY
- Sarah (b. 1784) . . . 17
- NEAT
- Emily . . . 18
- NOBLE
- Tony Eric . . . 19
- OTTAWAY
- . . . 24–25
- Ada E (b. 1883) . . . 26
- Alan George (b. 1924) . . . 40
- Albert R (b. 1878) . . . 23
- Alex Edward (b. 1983) . . . 35–38
- Alfred (b. 1862) . . . 24
- Alfred (b. 1892) . . . 13
- Alfred (b. 1915) . . . 39
- Alfred Edward (b. 1870) . . . 3
- Alice (b. 1853) . . . 16
- Alice (b. 1871) . . . 28
- Alice (b. 1877) . . . 22
- Alice (b. 1895) . . . 41
- Alison Dawn (b. 1975) . . . 33
- Amelia Joy (b. 2015) . . . 35–37
- Ann (b. 1816) . . . 5
- Ann (b. 1832) . . . 10
- Anne Marie (b. 1856) . . . 13
- Annie (b. 1865) . . . 7
- Annie (b. 1871) . . . 23
- Annie (b. 1872) . . . 26
- Annie (b. 1878) . . . 3
- Anthony Peter (b. 1932) . . . 45
- Arthur (b. 1816) . . . 24
- Arthur (b. 1897) . . . 22
- Arthur Henry (b. 1889) . . . 26
- Ben Finlay (b. 2013) . . . 34, 36–37
- Benjamin (b. 1857) . . . 24
- Bernard Arthur John (b. 1926) . . . 44
- Bertha Anne (b. 1872) . . . 28
- Brian Frederick (b. 1929) . . . 40
- Caroline (b. 1824) . . . 27
- Caroline (b. 1849) . . . 24
- Charles (b. 1813) . . . 17
- Charles (b. 1850) . . . 24
- Charles (b. 1874) . . . 20
- Charles (b. 1880) . . . 14
- Charles (b. 1931) . . . 20
- Charles Albert (b. 1940) . . . 20
- Charles Edward (b. 1885) . . . 26
- Charles Frederick (b. 1889) . . . 43
- Charles William (b. 1863) . . . 28
- Charles William (b. 1905) . . . 20
- Charlotte (b. 1800) . . . 7
- Charlotte (b. 1818) . . . 5
- Charlotte (b. 1873) . . . 23
- Chloe (b. 2010) . . . 34–35, 37
- Dorothy Helen (b. 1910) . . . 33
- Dorothy Louise (b. 1912) . . . 45
- Edith (b. 1896) . . . 13
- Edith Mary (b. 1893) . . . 40
- Edith May (b. 1908) . . . 32
- Edward (b. 1870) . . . 14
- Eliza (b. 1810) . . . 8
- Eliza (b. 1832) . . . 29
- Eliza (b. 1844) . . . 23
- Eliza (b. 1850) . . . 31
- Eliza (b. 1863) . . . 7
- Eliza (b. 1872) . . . 14
- Elizabeth . . . 31
- Elizabeth (b. 1744) . . . 11
- Elizabeth (b. 1772) . . . 11
- Elizabeth (b. 1803) . . . 7
- Elizabeth (b. 1811) . . . 30
- Elizabeth (b. 1827) . . . 13
- Elizabeth (b. 1837) . . . 10
- Elizabeth (b. 1852) . . . 12
- Elizabeth (b. 1855) . . . 28
- Elizabeth (b. 1867) . . . 7
- Elizabeth (b. 1877) . . . 22
- Elizabeth (b. 1900) . . . 23
- Ellen (b. 1838) . . . 14
- Ellen (b. 1865) . . . 17
- Ellen (b. 1866) . . . 46
- Ellen (b. 1873) . . . 14
- Ellen (b. 1880) . . . 14
- Elsie Maud (b. 1891) . . . 43
- Elsie Rose (b. 1923) . . . 40
- Emily (b. 1864) . . . 46
- Emily Annie (b. 1864) . . . 17
- Emma (b. 1835) . . . 14
- Emma (b. 1845) . . . 10
- Emma (b. 1852) . . . 16
- Ernest (b. 1894) . . . 13
- Ethel May (b. 1887) . . . 43
- Eunice Jean (b. 1930) . . . 45
- Evie (b. 2014) . . . 35–37
- Fanny Elizabeth Ellen (b. 1895) . . . 18
- Flora (b. 1876) . . . 26
- Florence (b. 1857) . . . 7
- Frances (b. 1807) . . . 8
- Frances (b. 1823) . . . 46
- Frances Elizabeth (b. 1872) . . . 3
- Francis (b. 1852) . . . 31
- Francis John (b. 1906) . . . 45
- Frank Bennett (b. 1907) . . . 39
- Frederica Mary . . . 31
- Frederick (b. 1830) . . . 6
- Frederick (b. 1868) . . . 26
- Frederick (b. 1869) . . . 28
- Frederick (b. 1875) . . . 23
- Frederick (b. 1883) . . . 31
- Frederick (b. 1888) . . . 40
- Frederick James (b. 1923) . . . 19
- Frederick James Herbert (b. 1930) . . . 31
- Frederick John (b. 1950) . . . 19
- Frederick William (b. 1859) . . . 7
- Frederick William Went (b. 1880) . . . 25
- George (b. 1736) . . . 4
- George (b. 1774) . . . 16

- George (b. 1827) . . . 27
 George (b. 1834) . . . 10
 George (b. 1840) . . . 14
 George (b. 1842) . . . 10
 George (b. 1844) . . . 29
 George (b. 1856) . . . 28
 George (b. 1876) . . . 3, 14
 George (b. 1899) . . . 23
 Hannah (b. 1772) . . . 16
 Hannah (b. 1788) . . . 11
 Hannah (b. 1798) . . . 16
 Hannah (b. 1808) . . . 15
 Hannah (b. 1829) . . . 9
 Hannah (b. 1852) . . . 24–25
 Hannah (b. 1859) . . . 28
 Harriet (b. 1821) . . . 27
 Harriet (b. 1828) . . . 27
 Harriet (b. 1855) . . . 27, 31
 Harriet (b. 1867) . . . 28
 Harriet Hannah Alice (b. 1861) . . . 7
 Harry (b. 1891) . . . 13
 Henry . . . 13
 Henry (b. 1764) . . . 5
 Henry (b. 1790) . . . 5
 Henry (b. 1819) . . . 5
 Henry (b. 1825) . . . 12
 Henry (b. 1841) . . . 9
 Henry (b. 1843) . . . 24
 Henry (b. 1846) . . . 10
 Henry (b. 1868) . . . 2
 Henry (b. 1897) . . . 23
 Henry Augustus (b. 1836) . . . 8
 Henry John (b. 1903) . . . 44
 Herbert (b. 1890) . . . 40
 Herbert Edward (b. 1910) . . . 45
 Ivy (b. 1922) . . . 18
 Jake (b. 2009) . . . 35–37
 James . . . 30
 James (b. 1780) . . . 46
 James (b. 1792) . . . 5
 James (b. 1799) . . . 9, 12
 James (b. 1802) . . . 47
 James (b. 1823) . . . 6
 James (b. 1834) . . . 13
 James (b. 1839) . . . 29
 James (b. 1840) . . . 17
 James (b. 1848) . . . 30
 James (b. 1865) . . . 22
 James (b. 1869) . . . 18
 James Frederick (b. 1910) . . . 21
 Jane (b. 1778) . . . 11
 Jane (b. 1787) . . . 47
 Jane (b. 1802) . . . 15
 Jane (b. 1803) . . . 29
 Jane (b. 1805) . . . 29
 Jemima (b. 1811) . . . 15
 Jemima (b. 1828) . . . 46
 John (b. 1745) . . . 12
 John (b. 1770) . . . 12
 John (b. 1795) . . . 6
 John (b. 1815) . . . 15
 John (b. 1828) . . . 6
 John (b. 1895) . . . 23
 John (Jack) (b. 1867) . . . 42
 Jose . . . 25
 Joseph (b. 1808) . . . 29
 Joshua (b. 1825) . . . 27
 Joshua (b. 1829) . . . 46
 Joyce Winifred (b. 1937) . . . 21
 Karen Cynthia . . . 31
 Katherine Nora (b. 1919) . . . 40
 Kathleen Ellen (b. 1907) . . . 45
 Leonard Francis (b. 1939) . . . 22
 Lilly (b. 1871) . . . 7
 Lotte Hannah May (b. 1892) . . . 32
 Louisa (b. 1813) . . . 15
 Louisa (b. 1833) . . . 47
 Louisa (b. 1859) . . . 16
 Louisa (b. 1876) . . . 25
 Lucy Ellen (b. 1893) . . . 26
 Lynn (b. 1958) . . . 19
 Mabel Annie (b. 1904) . . . 43
 Margaret Ann (b. 1946) . . . 45
 Margaret Elizabeth (b. 1915) . . . 46
 Marjorie Elsie (b. 1915) . . . 38
 Martha (b. 1811) . . . 17
 Martha (b. 1844) . . . 25
 Martha (b. 1863) . . . 26
 Martha (b. 1893) . . . 23
 Martyn Robert (b. 1948) . . . 34–38
 Mary (b. 1767) . . . 9
 Mary (b. 1791) . . . 9
 Mary (b. 1794) . . . 9
 Mary (b. 1795) . . . 12
 Mary (b. 1804) . . . 8
 Mary (b. 1815) . . . 30
 Mary (b. 1834) . . . 7
 Mary (b. 1861) . . . 28
 Mary A (b. 1820) . . . 16
 Mary Ann (b. 1856) . . . 16
 Mary Edith (b. 1914) . . . 39
 Mia Elizabeth (b. 2020) . . . 35–37
 Michelle Ann (b. 1977) . . . 34
 Murdoch . . . 40
 Nellie (b. 1901) . . . 13
 Nellie (b. 1908) . . . 21
 Nellie Elizabeth (b. 1926) . . . 20
 Oscar . . . 31
 Pamela (b. 1953) . . . 19
 Rachel (b. 1850) . . . 11
 Raymond Henry (b. 1928) . . . 44
 Reginald Harry . . . 26
 Rena (b. 1876) . . . 14
 Rhoda (b. 1880) . . . 30
 Richard (b. 1738) . . . 4
 Richard (b. 1769) . . . 11
 Richard William (b. 1945) . . . 45
 Robert (b. 1846) . . . 29

- Robert George Victor (b. 1900) . . . 42
 Robert William (b. 1981) . . . 34–37
 Roland William (b. 1944) . . . 33
 Ronald Arthur (b. 1918) . . . 46
 Ronald Arthur Bernard (b. 1948) . . . 44
 Rose (b. 1898) . . . 41
 Rose (Rosie) (b. 1867) . . . 17
 Sarah (b. 1754) . . . 48
 Sarah (b. 1810) . . . 15
 Sarah (b. 1837) . . . 10
 Sarah (b. 1870) . . . 26
 Sarah (b. 1891) . . . 23
 Sarah Ann (b. 1870) . . . 23
 Sarah Jane (b. 1866) . . . 28
 Sharon Lyn (b. 1965) . . . 22
 Sidney (b. 1898) . . . 13
 Sophia (b. 1848) . . . 25
 Stella (b. 1963) . . . 20
 Stephen . . . 28
 Stephen (b. 1812) . . . 9
 Stephen (b. 1818) . . . 27
 Stephen (b. 1838) . . . 6
 Stephen (b. 1842) . . . 22
 Stephen (b. 1846) . . . 15
 Stephen (b. 1848) . . . 10
 Stephen (b. 1859) . . . 32
 Stephen (b. 1861) . . . 16
 Stephen (b. 1866) . . . 22
 Stephen (b. 1872) . . . 18
 Stephen (b. 1921) . . . 18
 Stephen (b. 1968) . . . 20
 Stephen Herbert (b. 1914) . . . 40
 Stephen James (b. 1898) . . . 18
 Stephen Martyn (b. 1985) . . . 35–38
 Susan Ann (b. 1949) . . . 19
 Susannah (b. 1766) . . . 9
 Thomas (b. 1777) . . . 28
 Thomas (b. 1801) . . . 12
 Thomas (b. 1842) . . . 15
 Thomas (b. 1857) . . . 32
 Thomas (b. 1862) . . . 14
 Thomas (b. 1885) . . . 39
 Thomas George (b. 1921) . . . 40
 Tony Charles (b. 1969) . . . 22
 Tracy Kim (b. 1966) . . . 22
 Walter (b. 1866) . . . 14
 Walter (b. 1880) . . . 27
 William (b. 1774) . . . 11
 William (b. 1783) . . . 47
 William (b. 1796) . . . 9
 William (b. 1797) . . . 7
 William (b. 1805) . . . 47
 William (b. 1806) . . . 29
 William (b. 1817) . . . 30
 William (b. 1820) . . . 6
 William (b. 1829) . . . 13
 William (b. 1832) . . . 27
 William (b. 1834) . . . 29
 William (b. 1841) . . . 10
 William (b. 1846) . . . 30
 William (b. 1860) . . . 6
 William (b. 1863) . . . 13
 William (b. 1866) . . . 14
 William (b. 1872) . . . 30
 William (b. 1876) . . . 7
 William (b. 1883) . . . 32
 William (b. 1892) . . . 26
 William Frederick (b. 1861) . . . 24–25
 William Frederick (b. 1913) . . . 33
 William Henry (b. 1867) . . . 22
 William Jack (b. 1908) . . . 45
 Winifred Mary (b. 1917) . . . 38
 OTTAWAY (OTTERWAY)
 Arthur T (b. 1879) . . . 15
 Sidney G (b. 1875) . . . 15
 OTWAY
 (AYU) . . . 1
 Abigail (b. 1621) . . . 1
 Ann (b. 1787) . . . 4
 Anne (b. 1817) . . . 3
 Damaris (b. 1706) . . . 48
 Elizabeth (b. 1812) . . . 3
 Francis . . . 48
 George . . . 49
 George (b. 1654) . . . 49
 George (b. 1655) . . . 49
 George (b. 1711) . . . 4
 George (b. 1741) . . . 2
 George (b. 1774) . . . 2
 George (b. 1815) . . . 3
 Hannah . . . 49
 Hezekiah . . . 49
 Isaac . . . 49
 Jacob . . . 49
 James (b. 1701) . . . 1
 James (b. 1716) . . . 48
 James (b. 1746) . . . 11
 Jane . . . 49
 Jane (b. 1678) . . . 48
 Jane (b. 1709) . . . 4
 Jane (b. 1752) . . . 47
 Jane (b. 1808) . . . 3
 Joanne . . . 48
 John . . . 1
 John (b. 1626) . . . 1
 John (b. 1694) . . . 48
 John (b. 1710) . . . 4
 John (b. 1777) . . . 2
 Margaret (b. 1686) . . . 48
 Margaret (b. 1692) . . . 48
 Margaret (b. 1695) . . . 1
 Mary (b. 1688) . . . 48
 Mary Ann (b. 1804) . . . 2
 Philip (b. 1650) . . . 1
 Philip (b. 1675) . . . 1
 Philip (b. 1707) . . . 2
 Philip (b. 1734) . . . 2
 Richard Wallis (b. 1713) . . . 48

- Sarah (b. 1706) . . . 1
 Sarah (b. 1784) . . . 4
 Sarah (b. 1807) . . . 3
 Sarah (b. 1810) . . . 3
 William . . . 48–49
 William (b. 1779) . . . 3
 William (b. 1819) . . . 4
 OTWAY (OTTAWAY)
 John George (b. 1837) . . . 2
 PIPER
 (AYU) . . . 32
 J . . . 32
 PLUMRIDGE
 John . . . 15
 POOLE
 Wellesley . . . 46
 POULTER
 Dorothy (b. 1920) . . . 33
 POWER
 Bridget (b. 1848) . . . 2
 PRICE
 Dereck George . . . 19
 PURBRICK
 George . . . 43
 Kate (b. 1905) . . . 42
 RAMSEY
 Kate (b. 1884) . . . 39
 RICE
 Sarah Jane . . . 43
 ROWE
 Caroline (b. 1868) . . . 43
 SALE
 Lydia (b. 1778) . . . 29
 SAUNDERS
 Joseph . . . 24
 SEX
 Mary . . . 2
 SIMMONDS
 Joan . . . 19
 SMIRTHWAITE
 Jack . . . 21
 Leslie (b. 1963) . . . 21
 Susan Edith (b. 1966) . . . 21
 SMITH
 Garry Stephen . . . 19
 James . . . 15
 SMITHERS
 David . . . 23
 Emily (b. 1867) . . . 24
 Sarah (b. 1831) . . . 27
 STENT
 Emma (b. 1849) . . . 30
 STONE
 Doreen R . . . 21
 STOVELL
 Abraham (b. 1831) . . . 47
 Thomas (b. 1859) . . . 47
 SWIFT
 Ann . . . 6
 TAPLEY
 Martha (b. 1743) . . . 12
 TAYLOR
 Mary (b. 1823) . . . 30
 Paul . . . 33
 THOMAS
 Daniel Peter . . . 39
 Emily Claire . . . 39
 Peter . . . 39
 TICKNER
 Alice (b. 1762) . . . 5
 TIDBURY
 Arthur Thomas . . . 21
 Darryl William (b. 1970) . . . 21
 John Collin (b. 1944) . . . 21
 Toni Melinda (b. 1972) . . . 21
 TURNER
 Grayham . . . 20
 Terry . . . 20
 UNDERWOOD
 Charlotte (b. 1869) . . . 41
 Daniel . . . 8
 Harriet . . . 12
 John Ernest . . . 45
 USHER
 Harold . . . 41
 WELLBELOVED
 Susannah . . . 5
 WETHERILL
 Betsy Hannah (b. 1852) . . . 30
 WHITE
 James . . . 47
 WILCOCK
 Charles Daniel . . . 18
 WILDER
 . . . 26
 WILLATTS
 Violet May . . . 20
 WINTERBOTTOM
 (AYU) . . . 26
 WOODEN
 James Oliver (b. 1863) . . . 17
 Rose (b. 1892) . . . 17
 ZARINS
 Michael . . . 21

- 11 Keswick Ave Kingston Vale SW15 . . . 19–20
 1973 . . . 33
 1990's . . . 46
 54 Elton Road Kingston Surrey . . . 19
 Addison Gardens Surbiton . . . 18
 Addlestone . . . 25–26
 Green Lane . . . 32
 After 1881 Bef 1891 . . . 7
 After 1891 . . . 6
 Australia . . . 32, 40
 Aylesbury . . . 35–38
 Bagshot . . . 5
 Battersea . . . 31
 Benson Oxford 1851 says 1784 . . . 47
 Berks
 Long Whittingham . . . 7
 Old Windsor . . . 22
 Shinfield . . . 13
 Sunningdale . . . 15
 Sunninghill . . . 9, 47
 Windsor . . . 17–18, 23, 47
 Berkshire . . . 11
 Winkfiled . . . 47
 Bishopsgate Egham . . . 23
 Bloomsbury . . . 8
 Born 1875 . . . 22
 Brain Tumour . . . 18
 Bray Berkshire . . . 30
 Broom Hall Sunningdale . . . 13–15
 Brox Road Ottershaw . . . 46
 Bucks
 Taplow . . . 44
 Burrow Hill Chobham . . . 9
 Chertsey . . . 4, 6, 27, 32–34
 Chertsey 9 1861 Reg at Chertsey . . . 24
 Chertsey Surrey . . . 33
 Chobham . . . 4–9, 11–12, 14–17, 22–30, 46–48
 St Lawrence . . . 12
 Chobham 1881 census suggests 1831 1851 census
 suggests 1839! . . . 27
 Chobham 6 1864 Reg At Chertsey . . . 46
 Chobham Or 1726?? NBI Chertsey Burial Says Died
 Age 92 - This Puts Birth At 1725/6 . . . 4
 Chobham Reg At Chertsey . . . 31
 Chobham 1851 suggests 1848 . . . 24
 Chobham Reg At Chertsey 12 1867 . . . 17
 Chobham Reg In Chertsey . . . 16–17
 Chobham Burrow Hill . . . 16
 Chobham Egham Reg at Chertsey 3 1848 . . . 30
 Chobham Reg At Chertsey . . . 7, 25
 Chobham Reg At Chertsey 12 1872 . . . 18
 Chobham Reg At Chertsey 3 1846 . . . 29
 Chobham Reg At Chertsey 6 1843 . . . 24
 Chobham Reg Chertsey March 1844 . . . 29
 Chobham Regd At Chertsey 12 1849 . . . 24
 Chobham Regt At Chertsey 6 1859 . . . 7
 Chobham Burrow Hill 1851 says 1819 . . . 17
 Chobham Reg At Chertsey . . . 16, 24, 30
 Chobham Reg At Chertsey 12 1840 . . . 17
 Chobham Reg At Chertsey 12 1869 . . . 18
 Chobham Reg At Chertsey 3 1861 . . . 25
 Chobham Reg At Chertsey 3 1862 . . . 16
 Chobham Reg At Chertsey 9 1874 . . . 20
 Chobham Reg Chertsey 6 1864 . . . 17
 Chobham St Lawrence . . . 28
 Clewer Berks . . . 23
 Croydon . . . 32
 Dublin . . . 34–37
 Egham . . . 17, 22, 33, 47
 Egham Englfield Green . . . 22
 Egham Englfield Green . . . 22–23
 Egham Englfield Green Reg at Chertsey Sept 1865 . . .
 22
 Egham Surrey . . . 13–14
 Essex
 Nazeing . . . 44
 Eton . . . 22
 Fleet Hampshire . . . 42
 Godalming . . . 49
 Halebourn Chobham . . . 6
 Hersham . . . 2
 Herts
 Chorleywood . . . 25
 Horsell . . . 8–11, 16
 Ireland . . . 2
 Dublin . . . 34–37
 is this true?? . . . 45
 Kent
 Tunbridge Wells . . . 25
 Kenya
 Entebbe . . . 38
 Kingston . . . 18–19
 Kingston Lung Cancer . . . 19
 Kingston Register Office . . . 19
 Kingston Surrey
 71 Kings Road . . . 18
 Bittens
 3 Millens Cottages . . . 18
 Kingston Vale . . . 20
 Laleham Middlesex . . . 13
 Leicester . . . 44
 London . . . 31, 41–42
 London)
 Surrey (Heart Disease Charing Cross Hospital
 Addlestone . . . 25
 Longcross . . . 32
 Melbourne Australia . . . 32
 Middlesborough . . . 34–35, 37
 Middlesex . . . 24
 Longford
 Tithe Barn Cottages . . . 32
 Middx Census Puts Her Birth Year As 1836
 Laleham . . . 27
 Milton Keynes . . . 35–37
 Morden
 St Helier . . . 34–38
 New Malden
 9 Charter Square . . . 18–20

- Kingston Road
Fairmount . . . 18
- Norfolk
Langham . . . 43
- Not Married . . . 9
- Olu Deniz Turkey . . . 35–37
- Ottersahw . . . 42
- Ottershaw . . . 30, 32–33, 38–46
Brox Farm . . . 42–43
Holly Brox . . . 32, 41
- Ottershaw or 16th . . . 42
- Ottershaw Church . . . 32
- Oxon
Iffley . . . 7
- Pirbright Surrey . . . 5
- Portugal . . . 35–37
- Purbright Surrey . . . 7
- Pyrford . . . 11
- Reg at Chertsey . . . 9, 16, 22, 24, 26, 28, 46
- Reg At Chertsey 12 1859 . . . 28
- Reg at Chertsey 12 1863 . . . 28
- Reg At Chertsey 12 1871 . . . 28
- Reg At Chertsey 3 1867 . . . 28
- Reg at Chertsey 3 1894 . . . 26
- Reg at Chertsey 6 1838 . . . 6
- Reg At Chertsey 6 1872 . . . 26
- Reg at Chertsey 9 1869 . . . 28
- Reg In Chertsey
1901 Says 1860 In Wokingham But 1856 In
Bagshot . . . 13
- Reigate Register Office . . . 20
- Scarborough . . . 34–37
- School Cottage Ottershaw . . . 40
- Seaford Sussex . . . 33, 38
- Singapore . . . 42
- South Africa . . . 38
- South Wales . . . 31
- St John's Baptist Woking . . . 30
- St Lawrence Chobham . . . 23
- St Luke's Kingston . . . 18
- St Luke's Norbiton Kingston . . . 18
- St Mary
Horsell . . . 9–11
- St Mary Inf
Horsell . . . 10
- Stoke Next Guildford . . . 7, 15
- Surbiton . . . 18
- Surbiton Surrey . . . 14
- Surrey . . . 13, 26, 29
Addlestone . . . 43–44, 46
Chobham Regtd at Chertsey . . . 30, 32, 42
Chobham Regtd at Chertsey . . . 31–32
Haslemere . . . 38
Hersham . . . 2–3
Horsell . . . 8
New Malden
9 Charter Square . . . 18
Ottershaw . . . 32, 39, 43–44
Ottershaw Regtd at Chertsey . . . 41
Ottershaw Regtd at Chertsey . . . 32
Ottershaw.... Regtd At Chertsey . . . 32
Regtd at Chertsey . . . 31–32, 45–46
Thorpe . . . 25
Windlesham . . . 12
- Surrey (Heart Disease And Gangrene Of Leg)
Addlestone . . . 25
- Sussex
Worthing . . . 33
- Sydney
North Ryde
Northerfn Suburbs Memorial Gardens . . . 31
- Taplow . . . 44
- Union Road Ottershaw . . . 39
- Walton on Thames . . . 2–4
- Wandsworth . . . 30
- West Byfleet . . . 43
- Western Australia
Perth . . . 44
- Weybridge . . . 2
- Weybridge Or Hersham . . . 2
- Wimbledon . . . 19
- Windlesham . . . 5
- Windlesham Surrey . . . 12
- Winkfield . . . 12, 14
- Winkfield Berks . . . 13, 23
- Winkfield Berkshire . . . 14
- Woking . . . 1–2, 4, 9, 11, 15, 17, 30, 33–38, 43–44,
48–49
- Woking Maybe B1710 . . . 4
- Worplesdon . . . 49
- Yateley Hants . . . 6