

virgis.com
CREATIVE FILTRATION

CARTUCCE ARIA & FILTRI CABINA

Air elements & cabin filters

CATALOGO TECNICO

Technical catalogue



VIRGIS[®]
VAFILTER





Tutti i prodotti del presente catalogo sono realizzati in ottemperanza alle vigenti norme Europee riguardanti la sicurezza, lo smaltimento e la riciclabilità del prodotto o di sue parti, l'assenza di sostanze pericolose o inquinanti, garantendo nel contempo la salute dell'uomo.

IT

All the products in this catalogue are manufactured in compliance with the current European regulations on the safety, disposal and recycling of the product or its components and freedom from dangerous or polluting substances, ensuring human health.

EN

Tous les produits de ce catalogue sont réalisés conformément aux normes Européennes en vigueur concernant la sécurité, l'élimination et le recyclage des produits ou de leurs parties et l'absence de substances dangereuses ou polluantes, tout en veillant à la santé humaine.

FR

Um Gesundheit der Mensch zu garantieren werden alle Produkte in diesem Katalog unter Einhaltung der Europaischen Richtlinien betreffend Sicherheit, Entsorgung und Wiederverwertung des Produktes bzw. der Produktkomponenten sowie unter Garantie der Reinhaltung von geahrlichen oder umweltschaedlichen Substanzen produziert.

DE

Todos los productos de este catálogo están realizados de conformidad con las vigentes normas Europeas referentes a la seguridad, la eliminación y el reciclaje del producto o de sus partes, la ausencia de sustancias peligrosas o contaminantes, al mismo tiempo garantizar la salud humana.

ES



INDICE / Index

Politica per la qualità / Quality policy	6
TABELLE DI EQUIVALENZA DEI COSTRUTTORI riferimenti tra fabbricanti di filtri e O.E.M. per i loro codici CROSS REFERENCE BY MANUFACTURER cross reference competitive part and O.E.M. by part numbers	9
CARTUCCE ARIA applicazioni, foto e dimensioni dei filtri AIR ELEMENTS general application, photo and dimensions	59
CARTUCCE ARIA IN ORDINE DI DIMENSIONE AIR ELEMENTS LISTED BY DIMENSION	117
FILTRI CABINA applicazioni, foto e dimensioni dei filtri CABIN FILTERS general application, photo and dimensions	123
FILTRI CABINA IN ORDINE DI DIMENSIONE CABIN FILTERS LISTED BY DIMENSION	155

POLITICA PER LA QUALITÀ

QUALITY POLICY



È UN ESIGENZA E UNO STATO DI NECESSITÀ

La Virgis Filter considera la Qualità come il mezzo per soddisfare tutte le aspettative del cliente e per il miglioramento continuo della organizzazione aziendale e rappresenta, inoltre, il fulcro della nostra strategia per ottenere prodotti di qualità a prezzi competitivi.

La nostra politica di qualità è basata sui seguenti punti :

1. Soddisfazione del cliente
2. Innovazione tecnica
3. Miglioramento continuo del prodotto e dell' organizzazione aziendale
4. Coinvolgimento attivo dei dipendenti
5. Partecipazione dei fornitori

IT IS NECESSARY AND A STATE OF MIND

Virgis Filter consider Quality as the tool to satisfy customer expectations and to continually improve,

furthermore it is key to our strategy of delivering quality products at competitive prices.

Our policy is based as follows :

1. Customer satisfaction / Development
2. Innovation a technology
3. Continuous product and management structure improvement
4. Active involvement of employees
5. Cooperation with suppliers



TABELLE DI EQUIVALENZA DEI COSTRUTTORI

Cross reference by manufacturer

TABELLE DI EQUIVALENZA DEI COSTRUTTORI

Cross reference by manufacturer

MFRS Cod.	VIRGIS Cod.	MFRS Cod.	VIRGIS Cod.	MFRS Cod.	VIRGIS Cod.	MFRS Cod.	VIRGIS Cod.	MFRS Cod.	VIRGIS Cod.
AC		A476CL	8001131700	PC215	8001223500	AG498898	8601909200	ARM119612	8001130800
25096141	8001227800	A527C	8001167500	PC217	8001217700	AIFO		ARM119648	8001105600
A1003C	8001227800	A529C	8001128800	PC299K	8001128800	8020729	8001388000	ARM119649	8001222600
A1019C	8001228300	A549C	8001410400	PC331	8001130800	8023027	8001411100	ARM119775	8001103800
A101C	8001111000	A550C	8001473300	PC333	8001131700	AIR ENERGIE		ARM119778	8001226500
A1028C	8001224800	A559C	8001222100	PC334	8001224400	10965	8001110600	ARM120022	8001224400
A1029C	8001238600	A574C	8001335600	PC389	8001222500	10966	8001167500	ARM120281	8001146700
A1030C	8001223500	A575C	8001335700	PC390	8001228500	AIR MAZE		ARM120307	8001341000
A1032C	8001265300	A587C	8001128800	PC41	8001134800	CD01625502830	8001286700	ARM122492	8001224300
A1033C	8001239700	A588C	8001131600	PC411	8001131600	CD0615502830	8001286700	ARM122510	8001110600
A1035C	8001224200	A602C	8001284700	PC422	8001282600	CD0615506830	8001286700	ARM123160	8001434300
A1042C	8001223100	A614C	8001146700	PC445	8001121100	CD0615610-830	8001286700	ARM123412	8601409000
A1043C	8001209100	A619C	8001222600	PC49	8601568000	CD1221B05826	8001278100	ARM124164	8001222800
A1045C	8001222800	A620C	8001105600	PC88	8001138900	ED03013	8001222900	ARM124165	8001222900
A1056C	8001286700	A631C	8001217700	ACTIVE		UD080300107	8001284700	ARM124445	8001129500
A10578R	8001266000	A670C	8001131500	22497	8601725700	AIR REFRINER		ARM124526	8001131700
A1057C	8001341000	A671C	8001129500	ADVANCE MACHINE		ARM101237	8001225100	ARM127532	8001227600
A1072C	8601409000	A674C	8001128800	478463	8001167500	ARM101275	8001110600	ARM127784	8001222800
A1185C	8001240300	A677C	8001314100	478720	8001146700	ARM102745	8001167500	ARM127787	8001222900
A1554C	8001204800	A685C	8001239500	478722	8001341000	ARM105043	8001222100	ARM128407	8001723000
A1565C	8001248500	A702C	8601567700	2478463	8001167500	ARM105368	8001128800	ARM128408	8001723200
A1581C	8001222800	A727C	8001130800	AG CHEM EQUIPMENT		ARM106587	8001138900	ARM131394	8001111000
A1592C	8001194100	A846C	8001238500	27407	8001225300	ARM106769	8001224500	ARM151276	8001353000
A209C	8001221400	A880C	8601567700	609374	8001139100	ARM106775	8001225400	ARM153476	8001353100
A255C	8001121100	A888C	8001434300	701165	8001130800	ARM106834	8001139100	ARM1553	8001223100
A256C	8001102000	A889C	8001224400	702455	8001224500	ARM108668	8001130800	ARM155676	8001352700
A260C	8001222500	A901C	8001707000	702463	8001225400	ARM108674	8001131700	ARM1700	8001222500
A266C	8001315600	A902C	8001707500	720189	8001138900	ARM108736	8001220200	ARM1740	8001209100
A288C	8001315000	A910C	8001226500	720257	8001100300	ARM109085	8001227400	ARM1750	8001298000
A290C	8001315700	A953C	8001723000	721012	8001225200	ARM109200	8001226900	ARM1753	8001238600
A296C	8001225100	A976C	8001223400	721237	8001138900	ARM110022	8001224400	ARM1761	8001227800
A297C	8001110600	AF1072C	8601409000	721237023A	8001138900	ARM1113	8001221400	ARM181034	8001138900
A297CL	8001110600	PC134K	8001225100	AGRIFUL		ARM111415	8001240300	ARM181035	8001225100
A299CL	8001100300	PC135	8001224500	59901104	8001222600	ARM1126	8001224500	ARM181042	8001723000
A408C	8001138900	PC138	8001110600	59905104	8001131500	ARM113341	8001130800	ARM181044	8001226900
A417CL	8001227300	PC138K	8001110600	730190101	8001105600	ARM113343	8001239500	ARM181046	8001224500
A424C	8001227400	PC139	8001265300	730190201	8001220200	ARM114500	8001131500	ARM181050	8001110600
A424CL	8001227400	PC177	8001223100	730190601	8001129500	ARM114747	8001222100	ARM181059	8001128800
A428C	8001224500	PC178	8001298000	AGRITALIA		ARM1163	8001239700	ARM181063	8001224400
A443C	8001225400	PC179	8001238600	45401	8001067700	ARM117580	8001227300	ARM181064	8001130800
A445C	8001226900	PC183	8001238500	45409	8001100300	ARM117781	8001707500	ARM181104	8001221400
A445CL	8001226900	PC185	8001224200	45449	8001126900	ARM117782	8001707000	ARM181126	8001240300
A457C	8001220200	PC186	8001224800	45450	8001125500	ARM118211	8001335600	ARM2052	8001238500
A457CL	8001220200	PC187	8001223500	45452	8001125300	ARM118216	8001335700	ARM2301	8001224200
A462C	8001139100	PC188	8001217700	45453	8001100300	ARM119135	8001129500	ARM2302	8001224800
A462CL	8001139100	PC196	8001239700	AG396530	8601871900	ARM119136	8001128800	ARM2350	8001223400
A475C	8001130800	PC197	8001223800	AG397218	8601872600	ARM119363	8001128800	ARM2350/1	8001224200
A475CL	8001130800	PC200	8001223400	AG488038	8601894300	ARM119410	8001131600	ARM2400	8001687300
A476C	8001131700	PC212	8001209100	AG488039	8601894200	ARM119538	8001473300	ARM2401	8001223500

MFRS Cod.	VIRGIS Cod.	MFRS Cod.	VIRGIS Cod.	MFRS Cod.	VIRGIS Cod.	MFRS Cod.	VIRGIS Cod.	MFRS Cod.	VIRGIS Cod.
ARM2407	8001223800	MD320K	8001222100	3051818	8001225100	17200329	8001239700	1153	8001314100
ARM260	8001249100	MD360	8001221400	3067508	8001131600	ACM		1169	8001146700
ARM261	8001248500	MD382	8001224200	4055745	8001134800	958C	8001167500	1170	8001473300
ARM2706	8001121100	MD388	8001121100	4146001	8001134800	MA4481	8001421100	1209	8001224400
ARM3002	8001227800	MD392	8001222500	4789056	8001110600	AMERICAN HIOST		1210	8001226500
ARM307K	8001167500	MD410	8601568000	4841879	8001110600	526023	8001110600	1212	8001131500
ARM410	8001110600	MD484	8001687300	4907794	8001110600	832046	8001224500	1254	8001105600
ARM410K	8001110600	MD488	8001298000	4996253	8001110600	832047	8001225400	1258	8001434300
ARM419K	8001220200	MD492	8001209100	6626089	8001131700	834629	8001224500	1259	8001131700
ARM46976	8001410400	MD494	8001228500	6626097	8001139100	834635	8001225400	1264	8001335600
ARM475386	8001228300	MD498	8001223100	6676852	8001227400	834639	8001225300	1265	8001335700
ARM505K	8001473300	MD512	8001227300	9623788	8001224500	834644	8001225200	1338	8001217700
ARM522450	8001260500	MD514	8001227400	30474977	8001225100	023881	8001110600	1447	8001239500
ARM6002	8001194100	MD520	8001224800	42480759	8001352700	A2211	8001110600	1498	8001128800
ARM600K	8001222100	MD522K	8001220200	45480068	8001134800	A2321	8001224300	1547	8001131600
ARM60619	8001228300	ALFA ROMEO		72097371	8001110600	E230115	8001224300	1550	8601409000
ARM610K	8001222100	701009/E	8001213500	72257812	8001239500	M272651	8001110600	1574	8001138900
ARM611	8001224300	ALLIS-CHALMERS		99100307	8001222500	AMERICAN PARTS		1575	8001139100
ARM616K	8001128800	107974	8001131600	30000440155	8001129500	214	8601409000	1581	8001723000
ARM712	8001315700	257024	8001128800	01902129	8001227800	288	8001225100	1582	8001723200
ARM713	8001315600	257029	8001131600	02165054	8001224200	295	8001315700	1594	8001111000
ARM716	8001315000	266787	8001224400	02394637	8001352900	298	8001221400	1599	8001341000
ARM806K	8001130800	267953	8001226500	0239513	8001110600	303	8001315600	1602	8001238500
ARM8094	8001249100	614103	8001335600	0239518	8001110600	304	8001315000	93046	8001315000
ARM8095	8001248500	614104	8001335700	0240760	8001167500	320	8001110600	93048	8001315700
ARM8155	8001286700	674967	8001227300	0244570	8001139100	340	8001222100	93119	8001138900
ARM911K	8001225100	684734	8001224500	0250699	8001110600	352	8001167500	93123	8001220200
ARM997064	8001222500	1007973	8001128800	0256395	8001224400	402	8001139100	93142	8001100300
ARM9972	8001314100	1010407	8001128800	0256983	8001128800	403	8001138900	93208	8001224500
ARP15	8601409000	1014652	8001146700	0257597	8001110600	404	8001224500	93209	8001225400
ARP192	8001217700	1140889	8001110600	0260309	8001128800	405	8001225400	93225	8001227300
ARP2163	8001134800	1181296	8001226500	0267075	8001224400	431	8001130800	93226	8001227400
ARP65	8001284700	1183993	8001131700	0267931	8001131700	432	8001239500	93237	8001225100
VF160R	8001102000	1909116	8001222800	0267962	8001131700	920	8001226900	93238	8001707000
ALASKA DIESEL		1909128	8001105600	0648734	8001224500	922	8001227400	93239	8001707500
6001819200	8001128800	1909129	8001222600	0654409	8001130800	939	8001410400	93258	8001723000
ALCO		1909136	8001138900	0658451	8001224500	976	8001110600	93259	8001723200
MD022	8001217700	1909140	8001222600	0659533	8001224500	981	8001222100	93276	8001110600
MD152K	8001110600	1909141	8001105600	0660360	8001138900	983	8001128800	93321	8001128800
MD160	8001266000	2083768	8001139100	0660360/9	8001138900	991	8001225100	93334	8001221400
MD202	8001265300	2083771	8001138900	0662477	8001225400	996	8001130800	93335	8001315600
MD220K	8001225100	2097035	8001110600	0662607	8001225300	1012	8001220200	93336	8001314100
MD222	8001224500	2097407	8001167500	0662608	8001131700	1028	8001222600	93489	8001146700
MD224	8001138900	3039681	8001225100	0662609	8001139100	1033	8601567700	93503	8001222100
MD230	8001238500	3042922	8001138900	0667685	8001227400	1093	8001224500	93518	8001473300
MD234	8001223800	3045860	8001225100	0684732	8001130800	1149	8001707500	93522	8001224400
MD238	8001223500	3047497	8001225100	0684733	8001138900	1150	8001707000	93595	8601567700
MD260K	8001128800	3050258	8001138900	662689/9	8001131700	ALUP			
MD300	8001238600	3050899	8001225100						

MFRS Cod.	VIRGIS Cod.	MFRS Cod.	VIRGIS Cod.	MFRS Cod.	VIRGIS Cod.	MFRS Cod.	VIRGIS Cod.	MFRS Cod.	VIRGIS Cod.
93608	8001223500	94547	8001228300	AP3323	8001224200	AP3530A	8001105600	LK3331	8001238600
93609	8001352900	94554	8001238500	AP3323A	8001224200	AP3531	8001222600	LK3335	8001266000
93630	8001217700	94560	8001226500	AP3331	8001238600	AP3531A	8001222600	LK3347	8001238500
93631	8001105600	94569	8001441300	AP3331A	8001238600	AP3532	8001222800	LK3422	8001110600
93632	8001222600	94580	8601409000	AP3335	8001266000	AP3532A	8001222800	LK3446	8001223100
93656	8001335600	94594	8001223400	AP3335A	8001266000	AP3533	8001222900	LK3451	8001121100
93657	8001335700	94606	8001129500	AP3347	8001238500	AP3533A	8001222900	LK3486	8001275200
93679	8001131500	94613	8001327000	AP3347A	8001238500	AP3635	8001278100	LK3497	8001167500
93710	8001283900	94625	8001194200	AP3354A	8001128800	AP3658	8001648700	LK3504	8001139100
93769	8001434300	94642	8001227600	AP3422	8001110600	AP3659	8001353000	LK3507	8001225400
93868	8001128800	94643	8001131700	AP3422K	8001110600	AP3660	8001353100	LK3510	8001129500
93918	8001410400	94652	8001407400	AP3446	8001223100	AP3661	8001352700	LK3511	8001131500
93919	8001130800	94741	8001227800	AP3446A	8001223100	AP3662	8001352900	LK3516	8001226900
93920	8001131700	94868	8001102000	AP3451A	8001121100	AP500	8001217700	LK3518	8001227300
93924	8001139100	ANTONIO CARRARO		AP3486	8001275200	AP500A	8001217700	LK3519	8001227400
93927	8001226900	45305270	8601857300	AP3486A	8001275200	AP700	8001138900	LK3520	8001707000
94210	8001284700	45305278	8601857200	AP3497	8001167500	AP700A	8001138900	LK3521	8001707500
94263	8001498000	45305294	8601858400	AP3497A	8001167500	AP706A	8001266000	LK3522	8001130800
94270	8001167500	45305404	8601860000	AP3504	8001139100	AP713	8001265300	LK3523	8001131700
94294	8001209100	45305574	8601858300	AP3504A	8001139100	AP713A	8001265300	LK3524	8001224400
94313	8001239700	45305768	8601857400	AP3507	8001225400	AP744	8001266000	LK3527	8001226500
94330	8001228500	45320264	8601859500	AP3507A	8001225400	AP795	8001224500	LK3529	8001131700
94352	8001240300	45320366	8601857500	AP3510	8001129500	AP795A	8001224500	LK3530	8001105600
94360	8001110600	45320367	8601860100	AP3510A	8001129500	AP839	8001223500	LK3531	8001222600
94375	8001111000	45325091	8601871600	AP3511	8001131500	AP839A	8001223500	LK3532	8001222800
94378	8001260500	45325207	8601860200	AP3511A	8001131500	AP850K	8001225100	LK3533	8001222900
94407	8001471500	45325229	8601859400	AP3516	8001226900	AP855	8001224800	LK3635	8001278100
94408	8001248500	45325293	8601867100	AP3516A	8001226900	AP855A	8001224800	LK3658	8001648700
94414	8001224800	45325299	8601866900	AP3518	8001227300	AP856A	8001224300	LK3659	8001353000
94430	8001223100	45325321	8601862400	AP3518A	8001227300	AP860	8001128800	LK3660	8001353100
94466	8001222800	45325361	8601871700	AP3519	8001227400	AP860K	8001128800	LK3661	8001352700
94467	8001222900	45305277	8601876900	AP3519A	8001227400	AP923A	8001239700	LK3662	8001352900
94487	8001222800	AP LOCKHEED		AP3521	8001707500	AP924K	8001222800	LK3682	8001228300
94496	8001271600	AP-3008	8001315700	AP3521A	8001707500	AP925	8001220200	LK3740	8001285700
94498	8001249100	AP-451	8001121100	AP3522	8001130800	APH3397A	8001209100	LK3748	8001286700
94502	8001472200	AP191	8001283900	AP3522A	8001130800	APP191A	8001283900	LK500	8001217700
94504	8001433400	AP192	8001217700	AP3523	8001131700	APP3132A	8001134800	LK700	8001138900
94510	8001222500	AP192A	8001217700	AP3523A	8001131700	APP744A	8001266000	LK713	8001265300
94515	8001238600	AP3008A	8001315700	AP3524	8001224400	LK191	8001283900	LK795	8001224500
94517	8001341000	AP3027	8001225400	AP3524A	8001224400	LK192	8001217700	LK839	8001223500
94522	8001131600	AP3027A	8001225400	AP3527	8001226500	LK3008	8001315700	LK850	8001225100
94525	8001353100	AP3029	8001220200	AP3527A	8001226500	LK3027	8001225400	LK855	8001224800
94526	8001194100	AP3032	8001220200	AP3528	8001227600	LK3029	8001220200	LK860	8001128800
94532	8001353000	AP3032K	8001220200	AP3528A	8001227600	LK3032	8001220200	LK920	8601568000
94537	8001222800	AP3290	8001295300	AP3529	8001131700	LK3290	8001295300	LK925	8001220200
94538	8001222900	AP3290A	8001295300	AP3529A	8001131700	LK3309	8001131600	APCO	
94541	8001224200	AP3309	8001131600	AP3530	8001105600	LK3323	8001224200	AA163	8601409000

MFRS Cod.	VIRGIS Cod.	MFRS Cod.	VIRGIS Cod.	MFRS Cod.	VIRGIS Cod.	MFRS Cod.	VIRGIS Cod.	MFRS Cod.	VIRGIS Cod.
ARROW MANUFACTURING		16195699	8001352800	848924	8001105600	LL1886	8001227300	PA2416	8001238600
4001363	8001224300	29000206	8001227800	1318209	8001110600	LL1895	8001226900	PA2418FN	8001128800
ASAHI		97061483	8001283900	2601863	8001223500	LL1902FN	8001130800	PA2419	8001131600
IA378	8001167500	1613872000	8001754200	2601874	8001352900	LL2344FN	8001146700	PA2420	8001128800
MA464	8001130800	1613900100	8001754100	AVCO		LL2360FN	8001473300	PA2422	8001209100
ASTON-MARTIN		1619279800	8001224200	292737	8001110600	LL2426FN	8001224400	PA2423	8001222500
4808801	8001217700	1619279900	8001223500	703112	8001224300	LL2453	8001707000	PA2426FN	8001224400
ASTRA		1619284700	8001238500	AVELING-BARFORD		LL2562	8001723000	PA2427	8001226500
21685	8001226900	1619532700	8001353100	506357	8001111000	LL2608	8001102000	PA2453	8001707000
21886	8001224500	1619554500	8001352700	2811070	8001110600	LL2641	8001227600	PA2454	8001707500
28442	8001130800	1619569800	8001352900	9007585	8001222900	PA1634	8001221400	PA2474	8001224200
30257	8001138900	1619569900	8001352800	9007611	8001222900	PA1646FN	8001225100	PA2475	8001223500
104147	8001225400	2900050100	8001352700	9007613	8001222800	PA1647	8001315700	PA2489	8001434300
104412	8001227400	2900052500	8001352900	9007690	8001130800	PA1670	8001315000	PA2541FN	8001129500
111340	8001567300	2900059300	8001228500	9007691	8001131700	PA1675	8001315600	PA2554	8601409000
111341	8001568100	2900534800	8001128800	ABP3001558	8001227400	PA1690FN	8001110600	PA2562	8001723000
119925	8001629400	2900648800	8001110600	ABP3001559	8001723200	PA1719	8001217700	PA2563	8001723200
119926	8001630100	2914500000	8001224500	ABP3001560	8001723000	PA1753FN	8001222100	PA2570	8001111000
023881A	8001110600	2914500400	8001130800	ABP3001567	8001286700	PA1765	8601567700	PA2588	8001286700
P47629	8001224300	2914500500	8001131700	ABP3001571	8001111000	PA1822FN	8001128800	PA2602	8001341000
P49360	8001224300	2914501000	8001629400	ABP3001572	8001227300	PA1865FN	8001167500	PA2608	8001102000
P81571	8001110600	2914501700	8001697100	ABP3003085	8001110600	PA1865N	8001167500	PA2641	8001227600
P82301	8001110600	2914501800	8001697200	GDQ621001	8001110600	PA1878	8001240300	PA2645	8001433400
P85059	8001224400	2914504400	8001130800	MG621100301	8001226900	PA1884	8001138900	PA2653	8001240300
ATHEY		3216261400	8001139100	MT621024302	8001131700	PA1885	8001224500	PA2664	8001260400
P85148	8001341000	3216277100	8001226900	PG621523301	8001224500	PA1886	8001227300	PA2665	8001260500
P85149	8001146700	3216277200	8001131700	PG621523302	8001225400	PA1889	8001284700	PA2669FN	8001222800
P85842	8001138900	3216328600	8001224500	SW621456A301	8001707000	PA1893	8001225400	PA2670	8001222900
P85843	8001139100	3216328700	8001225400	SW621456A302	8001707500	PA1895	8001226900	PA2707	8001228300
ATLAS		3216523700	8001193500	AWD		PA1902FN	8001130800	PA2727	8001249100
869065	8001138900	3216523800	8001131600	91112964	8001309000	PA1904	8001227400	PA2728	8001248500
869076	8001139100	3216708001	8001194200	BADGER		PA1907FN	8001220200	PA2757	8001121100
2981124	8001441300	3216708202	8001239500	9120014	8001167500	PA1911	8001139100	PA2764	8001265300
2991546	8001407400	3222188191	8001629400	76109223	8001224500	PA1912	8001131700	PA2765	8001239700
291 1788	8001440900	5412291500	8001128800	BAKER		PA1919	8001131700	PA2767	8001223100
298 1113	8001441000	5415291500	8001128800	13943951	8001110600	PA1940	8001410400	PA2768FN	8001222800
ATLAS COPCO		5415291500	8001128800	9033AX1	8001224300	PA1981	8001239500	PA2769	8001222900
16191879	8001225100	5415291600	8001131600	9033AY1	8001110600	PA2222	8601585600	PA2770	8601568000
16192796	8001223100	ATLAS WEYHAUSEN		BALDWIN		PA2310	8001314100	PA2772	8001228500
16192797	8001238600	423841	8001224400	LL1634	8001221400	PA2332	8001131500	PA2773	8001230200
16192798	8001224200	424580	8001224400	LL1646FN	8001225100	PA2344FN	8001146700	PA2776	8001227800
16192799	8001223500	431181	8001226500	LL1667FN	8001103800	PA2345	8001335600	PA2790FN	8001194100
16192847	8001238500	451867	8001227600	LL1681FN	8001100300	PA2346	8001335700	PA2808	8001278100
16192867	8001239700	458455	8001128800	LL1690FN	8001110600	PA2360FN	8001473300	PA2813	8001238700
16192997	8001238600	463009	8001131600	LL1846	8001225300	PA2380FN	8001105600	PA2814	8001352900
16195441	8001648700	466535	8001130800	LL1884	8001138900	PA2381	8001222600	PA2833	8001556500
16195698	8001352900	466546	8001131700	LL1885	8001224500	PA2405	8001238500	PA2834	8001560400

MFRS Cod.	VIRGIS Cod.	MFRS Cod.	VIRGIS Cod.	MFRS Cod.	VIRGIS Cod.	MFRS Cod.	VIRGIS Cod.	MFRS Cod.	VIRGIS Cod.
PA2835	8001353100	PA3839	8601544100	N08463	8001224500	023408	8001129500	6598362	8001110900
PA2836	8001352700	PA3842	8601569000	N08464	8001225400	023409	8001131500	6646494	8001110600
PA2837	8001353000	PA3843	8601569300	N08466	8001226500	023411	8001128800	6666333	8001605000
PA2845	8001238600	PA3848FN	8001381100	N08567	8001130800	023412	8001131600	6666334	8001605400
PA2862	8001295300	PA3849	8001279000	N08568	8001131700	023414	8001224400	6671969	8001111000
PA2888	8001280900	PA3850	8001134300	N10119	8001131600	023415	8001226500	6672467	8001588700
PA2891	8001224800	PA3854FN	8001445500	BEDFORD		BITELLI		BOGE	
PA2911	8001223100	PA3855FN	8001234500	91107151	8001285700	265004	8001238600	569000901	8001751200
PA2912	8001287000	PA3859	8001307500	91112964	8001309000	265005	8001353000	BOMAG	
PA2917	8001687300	PA3860	8001279400	BELL		BLACKWELDERS		53521226	8001128800
PA2964	8001222500	PA3866	8001110900	200276	8001131600	42103	8001110600	05730105	8001139100
PA2976FN	8001188000	PA608	8601409000	200277	8001128800	42137	8001110600	05730106	8001224400
PA2977FN	8001327000	RS3542	8001407400	200443	8001224500	421371	8001110600	05730110	8001128800
PA3405	8001285700	RS3543	8001427000	200444	8001225400	2307428	8001224300	05730112	8001131600
PA3427	8001266000	RS3544	8001736500	200451	8001226500	4210370	8001110600	05730113	8001227400
PA3428	8001193500	RS3545	8001441300	200452	8001224400	20518240	8001128800	05730114	8001138900
PA3437	8001381100	RS3546	8001440900	200467	8001139100	20519240	8001131600	05730115	8001227400
PA3476	8001271600	RS3547	8001440200	200468	8001224500	BLAW-KNOX		05730116	8001225100
PA3477	8001687300	RS3702	8001605000	220132	8001723000	16475701	8001224400	05730119	8001224500
PA3491	8001472200	RS3703	8001605400	220133	8001723200	BLH		05730120	8001225400
PA3492	8001471500	RS3714	8001490000	220947	8001138900	X161WA653	8001225100	05730130	8001204800
PA3494	8001352800	RS3715	8001441200	BENATI		BLOUNT		05821012	8001238500
PA3558	8001530400	RS3724	8001489600	1849104	8001130800	525665	8001224500	05821013	8001238600
PA3566	8001250700	RS3726	8001490200	1849105	8001131700	537986	8001100300	05821014	8001353100
PA3572	8001223800	RS3727	8001652300	1849106	8001224500	537987	8001111000	05821015	8001353000
PA3593	8001238700	RS3744	8001668900	1849107	8001225400	538214	8001224400	05821018	8001224200
PA3597	8001282500	RS3870	8001629400	1849108	8001138900	538235	8001138900	058211019	8001352700
PA3605	8001223400	RS3871	8001630100	1849109	8001139100	538237	8001224500	05821301	8001228500
PA3612	8001239700	RS3885	8001538000	1849111	8001131600	538239	8001128800	BOMBARDIER	
PA3669FN	8001193500	RS3871	8001630100	1849112	8001128800	541559	8001224500	114113900	8001225100
PA3675	8001279800	RS3885	8001538000	1849119	8001129500	541559	8001224500	BOSCH	
PA3682	8001688000	BARBER GREEN		1849121	8001225400	541560	8001224500	1457429032	8001134800
PA3683	8001687600	16F94	8001128800	1849124	8001131500	565487	8001100300	1457429035	8001687300
PA3684	8001687900	BARKO HOUSINGS		1849125	8001224400	565526	8001226500	1457429039	8001266000
PA3686	8001648700	53501025	8001473300	1849126	8001226500	565527	8001224400	1457429941	8001223100
PA3687	8001648800	BARKOHYDRAULICS		1849438	8001193500	565528	8001224400	1457429942	8001209100
PA3688	8001530000	53501110	8001473300	BENFRA		BOBARD		1457429944	8001228500
PA3690	8001194200	53501257	8001224500	10476	8001279400	80029720	8601891000	1457429945	8001222500
PA3699	8001529400	53501258	8001225400	10479	8001279400	80029746	8601896500	1457429946	8001238600
PA3752	8001178900	BAUER		40199	8001234500	80029747	8601891200	1457429950	8001238500
PA3752	8001298000	N01371	8001225100	54957	8001204800	80029772	8601896300	1457429966	8001224200
PA3753	8001298000	N02206	8001110600	1849133	8001279800	80029774	8601896200	1457429967	8001224800
PA3754	8001376300	N07698	8001128800	8322160	8001130800	80029885	8601896100	1457429968	8001223400
PA3772	8001209300	N08109	8001224400	8322161	8001131700	80029886	8601896400	1457429969	8001227800
PA3779FN	8001222800	N08152	8001129500	0052222	8001103800	80029899	8601891100	1457429975	8001223500
PA3787	8001747000	N08176	8001138900	0052223	8001110900	BOBCAT		1457429976	8001138900
PA3808FN	8001347300	N08177	8001139100	BERNARD		6598222	8001498000	1457429977	8001224500

MFRS Cod.	VIRGIS Cod.	MFRS Cod.	VIRGIS Cod.	MFRS Cod.	VIRGIS Cod.	MFRS Cod.	VIRGIS Cod.	MFRS Cod.	VIRGIS Cod.
1457429979	8001282600	0005A	8001224500	BUSSING		CFM813	8001238600	CFM884	8001723000
1457429999	8001121100	0008A	8001238600	801155191	8001223800	CFM816	8001224200	CFM885	8001723200
1.457.433.900	8001490000	0009A	8001110600	801155196	8001223400	CFM822	8001223500	CFM982	8001209100
1987430001	8001238500	0010A	8001224800	90801155191	8001223800	CFM85	8001315000	CFM986	8001687300
1987430003	8001138900	0012A	8001224200	BUSSING-OM		CFM852	8601409000	CARQUEST	
1987430004	8001223500	0020A	8001209100	801155191	8001223800	CFM884	8001723000	87046	8001315000
1987430005	8001224500	0022A	8001228500	801155196	8001223400	CFM885	8001723200	87048	8001315700
1987430008	8001238600	0024A	8001222500	90801155191	8001223800	CFM982	8001209100	87119	8001138900
1987430009	8001110600	0028A	8001225100	CALSA		CFM986	8001687300	87123	8001220200
1987430010	8001224800	0030A	8001687300	E100267	8001298000	CANADIAN FILTER MFG.		87142	8001100300
1987430011	8001225400	0038A	8001223100	E100880	8001238500	CFM1003	8001146700	87208	8001224500
1987430012	8001224200	0050A	8001266000	E101225	8001238600	CFM101F	8001225100	87209	8001225400
1987430022	8001228500	0056A	8001223400	E117207	8001223100	CFM134F	8001110600	87225	8001227300
1987430024	8001222500	0060A	8001223800	E124398	8001353100	CFM2006	8001227800	87226	8001227400
1987430028	8001225100	0060A	8001224200	CANADIAN FILTER		CFM202	8601567700	87237	8001225100
1987430030	8001687300	1 987 430 056	8001223400	CFM1003	8001146700	CFM249	8001225400	87238	8001707000
1987430038	8001223100	1 987 430 060	8001223800	CFM101F	8001225100	CFM286	8001224500	87239	8001707500
1987430050	8001266000	BOSS TRUCKS		CFM134F	8001110600	CFM361	8001226900	87258	8001723000
1987430063	8001225300	8863355	8001129500	CFM2006	8001227800	CFM385	8001138900	87259	8001723200
1987430064	8001139100	D055379	8001239700	CFM202	8601567700	CFM421F	8001130800	87276	8001110600
1987430068	8001121100	SX5006	8001129500	CFM249	8001225400	CFM432	8001139100	87321	8001128800
1987430071	8001128800	BOTTARINI		CFM286	8001224500	CFM434	8001131700	87334	8001221400
1987430075	8001131600	220901	8001110600	CFM361	8001226900	CFM435	8001227400	87335	8001315600
1987430077	8001227800	220902	8001100300	CFM385	8001138900	CFM437	8001226900	87336	8001314100
1987430078	8001223800	220903	8001111700	CFM421F	8001130800	CFM538	8001314100	87489	8001146700
9451160001	8001238500	220905	8001138800	CFM432	8001139100	CFM573F	8001222100	87503	8001222100
9451160003	8001138900	220913	8001247400	CFM434	8001131700	CFM574	8001707000	87518	8001473300
9451160004	8001223500	220918	8001350000	CFM435	8001227400	CFM601F	8001473300	87522	8001224400
9451160005	8001224500	220981	8001128800	CFM437	8001226900	CFM608	8001227300	87595	8601567700
9451160008	8001238600	BRAUD		CFM538	8001314100	CFM617	8001707500	87608	8001223500
9451160009	8001110600	20008157	8001128800	CFM573F	8001222100	CFM632F	8001105600	87609	8001352900
9451160010	8001224800	20008158	8001131600	CFM574	8001707000	CFM641	8001335600	87630	8001217700
9451160011	8001225400	20015933	8001193500	CFM601F	8001473300	CFM642	8001335700	87631	8001105600
9451160012	8001224200	20015934	8001204800	CFM608	8001227300	CFM644F	8001146700	87632	8001222600
9451160020	8001209100	BRIMONT		CFM617	8001707500	CFM690F	8001128800	87656	8001335600
9451160022	8001228500	1196112	8001110600	CFM632F	8001105600	CFM77	8001315700	87657	8001335700
9451160024	8001222500	BROYT		CFM641	8001335600	CFM777F	8001224400	87679	8001131500
9451160028	8001225100	2914533	8001225400	CFM642	8001335700	CFM78	8001221400	87710	8001283900
9451160030	8001687300	2914534	8001224500	CFM644F	8001146700	CFM782F	8001110600	87769	8001434300
9451160038	8001223100	BUCYRUS- ERIE		CFM690F	8001128800	CFM79	8001315600	87868	8001128800
9451160050	8001266000	104516	8001225100	CFM77	8001315700	CFM791	8001238500	87918	8001410400
9451160056	8001223400	46134465	8001225100	CFM777F	8001224400	CFM799	8001102000	87919	8001130800
9451160060	8001223800	46140235	8001225100	CFM78	8001221400	CFM813	8001238600	87920	8001131700
9451160060	8001224200	46140236	8001225100	CFM782F	8001110600	CFM816	8001224200	87921	8001239500
0001A	8001238500	46151725	8001225100	CFM79	8001315600	CFM822	8001223500	87924	8001139100
0003A	8001138900	62300685	8001225200	CFM791	8001238500	CFM85	8001315000	87927	8001226900
0004A	8001223500	62300686	8001225300	CFM799	8001102000	CFM852	8601409000	88210	8001284700

MFRS Cod.	VIRGIS Cod.	MFRS Cod.	VIRGIS Cod.	MFRS Cod.	VIRGIS Cod.	MFRS Cod.	VIRGIS Cod.	MFRS Cod.	VIRGIS Cod.
88263	8001498000	45409	8001100300	L35496	8001225400	1966965C1	8001100300	529852R2	8001131500
88270	8001167500	45449	8001126900	L52042	8001224300	222421A1	8001441000	529852R3	8001131500
88294	8001209100	45450	8001125500	L82775	8001128800	222422A1	8001441300	529852R4	8001131500
88313	8001239700	45452	8001125300	N6656	8001226900	285016A1	8001110900	529852R5	8001131500
88330	8001228500	45453	8001100300	N6660	8001139100	3039972R1	8001225200	530270R2	8001139100
88352	8001240300	45305049	8601857000	N6778	8001473300	3066498R91	8001110600	537335R1	8001222600
88360	8001110600	45305061	8601858500	N7028	8001224400	3115559R91	8001222900	537335R2	8001222600
88375	8001111000	45320263	8601859200	N8153	8001131600	3115560R2	8001204800	537335R3	8001222600
88378	8001260500	45320269	8601924800	P1050506	8001707500	3115560R91	8001222800	6278976C1	8001335700
88407	8001471500	48013056	8601858500	P1050507	8001707000	3115569R2	8001204800	627975C2	8001335600
88408	8001248500	CARRARO ANTONIO		P2150506	8001239500	3124011R1	8001222800	627976C1	8001335700
88414	8001224800	6155529	8001105600	P250566	8001131500	3124011R2	8001222800	702322C1	8001224500
88430	8001223100	6155539	8001110600	P250581	8001131600	3124012R1	8001222900	702323C1	8001225400
88466	8001222800	6155540	8001134800	P250599	8001224400	3125253R1	8001204800	702753C1	8001227400
88467	8001222900	6155543	8001110800	P450543	8001227600	3126100R1	8001353000	848623R1	8001139100
88487	8001222800	44509001	8001146700	P450544	8001131700	3135188R1	8001131600	924280C1	8001239500
88496	8001271600	CARRIER		P850501	8001226500	3146576R1	8001223100	924779C1	8001105600
88498	8001249100	941070	8001167500	P850551	8001226900	3146939R1	8001238600	924779C2	8001105600
88502	8001472200	66U12155	8001110600	P850561	8001139100	3147878R1	8001648700	926783C1	8001224500
88504	8001433400	66U152621	8001110600	P850562	8001138900	3147878R2	8001648700	926784C1	8001225400
88510	8001222500	CASE		P850568	8001227300	3148080R1	8001648800	MHC203252	8001238500
88515	8001238600	82571	8001167500	P850569	8001227400	3153187R1	8001128800	TRA8273235	8001341000
88517	8001341000	1050507	8001707000	R28797	8001130800	3153188R1	8001131600	Z2950577	8001441300
88522	8001131600	82034441	8001710300	R29295	8001130800	3154700R1	8001130800	CATERPILLAR	
88525	8001353100	627975C3	8001335600	R36361	8001131700	3154701R1	8001131700	21685	8001226900
88526	8001194100	A141041	8001110600	R39392	8001146700	3178080R1	8001648800	774592	8001224500
88532	8001353000	A173290	8001473300	R39393	8001341000	3210185R1	8001138900	775869	8001225100
88534	8001286700	A43656	8001225300	S113979	8001146700	3216100R1	8001353000	776258	8001225400
88537	8001222800	A55203	8001110600	S117745	8001224400	3216100R2	8001353000	946352	8001139100
88538	8001222900	A59999	8001224300	S117746	8001226500	3219420R91	8001238500	971217	8001110600
88541	8001224200	D40349	8001110600	S221313	8001225100	3219421R1	8001353100	1006846	8001445500
88547	8001228300	D43712	8001110600	S231996	8001138900	3226416R1	8001238500	1106326	8001736500
88554	8001238500	D48198	8001110600	S236468	8001146700	3291210R1	8001128800	1106331	8001441300
88560	8001226500	D53106	8001110600	T40348	8001110600	3371378R1	8001224400	1318822	8001878300
88569	8001441300	D55164	8001110600	T40349	8001110600	3371379R1	8001226500	1348726	8001605000
88580	8601409000	D55203	8001110600	V36474	8001167500	3372006R1	8001227600	1402337	8001605400
88594	8001223400	D55864	8001128800	V37721	8001238600	3375263R1	8001139100	1421340	8001692200
88606	8001129500	D56453	8001128800	XA76507	8001110600	3375264R1	8001138900	2931183	8601866600
88613	8001327000	D56463	8001128800	XB39303	8001110600	3405458R1	8001238600	096-9624	8001224500
88625	8001194200	D82571	8001167500	XD91927	8001473300	355607C1	8001224500	1N4864	8001723200
88642	8001227600	D82775	8001341000	CASE HOUSINGS		381343R91	8001110600	151286	8001315600
88643	8001131700	E41535	8001110900	L13534	8001225100	389263R91	8001224300	151287	8001315000
88652	8001407400	E43780	8001103800	CASE/INTERNATIONAL		389567R91	8001110600	1W3636	8001707500
88741	8001227800	H425256	8001110600	09060	8001130800	461249C1	8001138900	1W3637	8001707000
88868	8001102000	K922630	8001217700	1105717C1	8001128800	465249C1	8001138900	2P8863	8001221400
CARRARO		L30937	8001225100	1269652C1	8001167500	529821R1	8001138900	251285	8001315700
45401	8001067700	L35495	8001224500	146939R1	8001238600	529821R2	8001138900	251286	8001315600

MFRS Cod.	VIRGIS Cod.	MFRS Cod.	VIRGIS Cod.	MFRS Cod.	VIRGIS Cod.	MFRS Cod.	VIRGIS Cod.	MFRS Cod.	VIRGIS Cod.
2S1287	8001315000	9Y6804	8001225400	LAF281	8001146700	3401261	8001224300	946897	8001224500
3I0105	8001707500	9Y6805	8001139100	LAF334	8001221400	3401368	8001224300	948313	8001130800
3I0126	8001225400	9Y6806	8001131700	LAF335	8001315600	75060642	8001138900	949363	8001225200
3I0167	8001434300	9Y6807	8001341000	LAF46	8001315000	CLAAS		949524	8001227400
3I0215	8001723200	9Y6817	8001105600	LAF4714	8601567700	71242	8001227800	949525	8001227300
3I0795	8001723000	9Y6821	8001222600	LAF48	8001315700	176168	8001353100	960243	8001224500
3I0799	8001224500	9Y6823	8001111000	LAF5368	8001128800	176169	8001353000	961000	8001224400
3I0836	8001238600	9Y6828	8001224500	LAF6587	8001138900	643331	8001352900	961001	8001226500
3I0925	8001226900	9Y6834	8001225100	LAF6769	8001224500	676600	8001238600	961161	8001227400
3I0929	8001110600	9Y6836	8001723000	LAF6834	8001139100	677434	8001238500	993608	8001138900
3I2147	8001588700	9Y6839	8001110600	LAF8211	8001335600	722390	8001352800	993609	8001139100
4M8048	8001315700	9Y6842	8001473300	LAF8668	8001130800	723561	8001223100	993688	8001138900
4M9334	8001221400	9Y6843	8001130800	LAF8674	8001131700	773820	8001747000	993689	8001139100
4M9335	8001315600	9Y6846	8001146700	LAF9085	8001227400	940084	8001353100	1503857	8001130800
4M9339	8001315600	9Y6853	8001260500	LAF9200	8001226900	1761680	8001353100	1514669	8001225200
4N0015	8601409000	9Y7805	8001139100	CHAMPION		1761690	8001353000	1564806	8001226900
5W2716	8001226500	9Y7808	8001138900	1522830	8001220200	1770460	8001224200	1616513	8001110600
5W3402	8001131700	9Y7810	8001226900	1522841	8001222800	1784291	8001353000	1624567	8001224300
5W3403	8001227600	9Y7811	8001224500	1523749	8001277500	3200020	8001111000	1642645	8001110600
5W5889	8001128800	9Y7813	8001128800	3325106	8001224400	3414590	8001286700	1704269	8001110600
5W5890	8001131600	9Y7814	8001224400	LAF4127	8001220200	3417790	8001110600	1727868	8001224300
6A5110	8001238600	CESAB		LAF4139	8001222800	6431690	8001223500	1911724	8001225400
6A5110V	8001238600	991322	8001125500	LAF4514	8001277500	6433310	8001352900	1911725	8001139100
6A5162	8001239700	991323	8001124600	W705	8001238600	6575640	8001352700	1990248	8001138900
6A5162V	8001239700	991673	8001129500	W706	8001228500	6774340	8001238500	2311778	8001110600
6I6582	8001139100	991674	8001131500	W711	8001223100	9420840	8001353100	2318016	8001110600
6L4714	8601567700	CHAMP		CHAMPION ROAD		03414590	8001286700	2824613	8001110600
6L6873	8601567700	AF1275	8001110600	11564	8001227400	03417790	8001110600	3493878	8001110600
6N6064	8001227300	AF1418	8001138900	16307	8001226900	070905	8001227800	4149908	8001129500
6N6065	8001227400	AF15	8601409000	24149	8001224400	071242	8001227800	4155107	8001352700
7E0974	8001224400	AF1625	8001131700	24150	8001226500	0722390	8001352800	5209957	8001130800
7E0975	8001128800	AF237	8001225100	CHARLES MACHINE WORKS		0773820	8001747000	6518192	8001110600
7M9046	8001315000	AF2745A	8001167500	195426	8001110600	CLARK		6544578	8001110600
7W5317	8001221400	AF334	8001221400	195427	8001110600	333494	8001110600	6598222	8001498000
8C3047	8001225400	AF335	8001315600	195671	8001110600	335494	8001110600	6598362	8001434300
8N5317	8001221400	AF4747	8001222100	195682	8001110600	335498	8001110600	6598491	8001110600
8N5373	8001221400	AF5368	8001128800	195703	8001224400	616513	8001110600	6598898	8001131500
8N6309	8001240300	AF6769	8001224500	195709	8001224400	886544	8001110600	6620140	8001110600
8T5600	8001138900	AF6834	8001139100	195711	8001224300	889097	8001110600	6630939	8001473300
8T6305	8001128800	AF8211	8001335600	195735	8001100300	889098	8001110600	6663418	8001110600
8T7462	8001224400	AF8216	8001335700	CHICAGO-PNEUMATIC		897064	8001167500	6666376	8001427000
8T8076	8001224500	AF8668	8001130800	15PS2690	8001224300	933688	8001138900	15H668	8001110600
8U2601	8001224400	AF9085	8001227400	56PS4670	8001227400	933689	8001139100	161WA653	8001225100
9L0699	8001221400	AF9778	8001226500	6PS2690	8001224300	944404	8001224500	HCF11590	8001224300
9M1827	8001221400	LAF1275	8001110600	75PS2690	8001225100	945059	8001225100	HCF14205	8001224300
9S9972	8001314100	LAF237	8001225100	CHRYSLER		945059	8001225100	HCF15919	8001224300
9Y6803	8001225200	LAF2745A	8001167500	1852569	8601409000	946847	8001224500	CLEAN	

MFRS Cod.	VIRGIS Cod.	MFRS Cod.	VIRGIS Cod.	MFRS Cod.	VIRGIS Cod.	MFRS Cod.	VIRGIS Cod.	MFRS Cod.	VIRGIS Cod.
MA384	8001138900	C11158/1041	8001224200	AEK2046	8001146700	AES2523	8001411300	AZA314T	8001224500
MA567	8001227800	C11561724	8001128800	AEK2128	8001473300	AES2563	8001478700	AZA319	8001128800
MA744	8001280900	C16012/52	8001228500	AEK2494	8001105600	AES2595	8001693800	AZA319T	8001128800
CLEVELAND		C16012052	8001228500	AEK2522	8001229000	AES2609	8001239500	AZA323T	8001225200
9832046	8001224500	C16012189	8001238500	AEK2568	8001327000	AG140	8001217700	AZA324T	8001225300
9832047	8001225400	C16012190	8001224200	AEK2574	8001347300	AG142	8001283900	AZA326	8001139100
CLIMAX		DP605332	8001478700	AEK2576	8001277000	AG385	8001266000	AZA326T	8001139100
172121	8001225100	R01000/89	8001217700	AEK2578	8001483500	AG417	8001282600	AZA327	8001130800
10CX49	8001225100	CONSOLIDATED PNEUMATIC		AEK2584	8001277000	AG445	8001266000	AZA328	8001131700
COFAM		655FPS1087	8001138900	AEK2608	8001445500	AG464	8601568000	AZA328T	8001131700
NCM101	8001110600	CONTINENTA		AEM2014	8001723000	AZA003	8001283900	AZA332	8001128800
COLES		PCA1532	8001473300	AEM2022	8001707000	AZA003T	8001283900	AZA332T	8001128800
552894	8001225100	PCA1543SY	8001131500	AEM2050	8001556500	AZA008	8001217700	AZA333	8001131600
726960	8001225100	PCA1544SY	8001131600	AEM2068	8001260400	AZA008T	8001217700	AZA333T	8001131600
8283485	8001224500	PCA1570	8001707000	AEM2076	8001335600	AZA042	8001238500	AZA335	8001222900
8351075	8001224500	PCA1570SY	8001707500	AEM2090	8001250000	AZA045	8601568000	AZA336	8001222800
8576344	8001225100	PCA226	8001221400	AEM2128	8001473300	AZA101	8001238600	AZA337	8001110600
8584532	8001138900	PCA226SY	8001314100	AEM2176	8001230200	AZA123	8001298000	AZA337T	8001110600
8729984	8001138900	PCA234	8001315000	AEM2188	8001134800	AZA126	8001239700	AZA340	8001128800
8752811	8001138900	PCA236	8001315600	AEM2486	8001224500	AZA127	8001223800	AZA343	8001225400
8754231	8001224500	PCA237	8001315700	AEM2510	8001410400	AZA128	8001223500	AZA343T	8001225400
8755193	8601568000	PCA2523	8001224400	AEM2542	8001134300	AZA128T	8001223500	AZA351	8001129500
8779594	8001130800	PCA2523SY	8001226500	AEM2556	8001282500	AZA129	8001223100	AZA363	8001167500
8935978	8001224500	PCA256	8001110600	AEM2560	8001318500	AZA132	8001224200	AZA364	8001222600
8970415	8001224500	PCA2571	8601409000	AEM2630	8001277500	AZA147	8001282600	AZA365	8001105600
8973286	8001138900	PCA258	8001100300	AEM2632	8001410700	AZA151	8001266000	AZA366	8001224400
8975053	8001138900	PCA2595	8001723000	AEM2752	8001668900	AZA159	8001209100	AZA367	8001226500
8985294	8001222500	PCA2595SY	8001723200	AEP3514	8601567700	AZA165	8001220200	AZA373	8001220200
8987765	8001224400	PCA3280	8001223500	AEP3515	8601409000	AZA166	8001222500	AZA374T	8001131700
COLT INDUSTRIES		PCA502	8001228300	AEP3518	8601569000	AZA169	8001223400	AZA375	8001227600
20803	8001225400	PCA502SY	8001225200	AEP3519	8601569300	AZA171	8001687300	AZA376	8001111000
20804	8001224500	PCA507	8001224500	AES2015	8001723200	AZA177	8001224800	AZA376T	8001111000
21097	8001225100	PCA507SY	8001225400	AES2023	8001707500	AZA179T	8001275200	AZA386	8001194100
22274	8001224300	PCA510	8001222100	AES2045	8001434300	AZA189	8001121100	AZA409	8001309000
22344	8001100300	PCA523	8001138900	AES2047	8001341000	AZA189T	8001121100	AZA421	8001278100
22345	8001103800	PCA523SY	8001139100	AES2051	8001560400	AZA197T	8001286700	AZA443	8001353100
COMPAIR		PCA535	8001227300	AES2069	8001260500	AZA203	8001353000	AZA446	8001352700
6486	8001110600	PCA535SY	8001227400	AES2077	8001335700	AZA203T	8001353000	AZA450	8001352900
1077A12300	8001225100	PCA546	8001130800	AES2091	8001227900	AZA204	8001228500	AZA462	8001228300
1078A30930	8001224500	PCA546SY	8001131700	AES2265	8001131500	AZA251	8001285700	AZA464A	8001228300
1078A31300	8001138900	PCA563	8001226900	AES2279	8001110900	AZA251T	8001285700	AZA485	8001295300
98262/5025	8001224500	CONTINENTAL		AES2281	8001648800	AZA309	8001138900	AZA510	8001227300
A13316774	8001441000	F227F502	8001110600	AES2283	8001352800	AZA309T	8001138900	AZA511	8001227400
A13368674	8001629400	LO176	8001110600	AES2285	8001648700	AZA311	8001225100	AZA511T	8001227400
A2950436	8001751200	COOPERS		AES2287	8001314100	AZA311T	8001225100	AZA512	8001226900
C11153/1014	8001238600	5040T	8001217700	AES2391	8001222500	AZA313	8001265300	AZA514	8001707000
C11158/1014	8001238600	5296T	8001283900	AES2495	8001222600	AZA314	8001224500	AZA515	8001707500

MFRS Cod.	VIRGIS Cod.	MFRS Cod.	VIRGIS Cod.	MFRS Cod.	VIRGIS Cod.	MFRS Cod.	VIRGIS Cod.	MFRS Cod.	VIRGIS Cod.
AZA604	8001315700	L95407	8001265300	9580	8001315600	9516K	8001222800	AF27953	8001930500
AZA609	8001221400	L95408	8001138900	9586	8001315700	9527K	8001130800	CUMMINS HOUSING	
AZA610	8001315600	L95412K	8001225100	9590	8001275200	9560K	8001222100	156768	8001225100
AZA611	8001315000	L95414K	8001110600	9592	8001228300	9611K	8001129500	156769	8001225100
AZA815	8001227800	L95417	8001282600	9595	8001286700	962K	8001110600	196676	8001130800
AZA852	8001238700	L95419	8001224500	9599	8001278100	964K	8001225100	204623	8001130800
AZA856	8001238700	L95425	8001221400	9613	8001131500	9654K	8001224400	650577	8001224500
AZA863	8001280900	L95445	8001266000	9615	8001222500	9681K	8001105600	708748	8001224500
AZA885	8001530000	COOPERS HOUSINGS		9617	8001139100	9705K	8001194100	CUSTOM VACUUM	
AZA894	8001410700	CD 2502	8001130800	9618	8001131600	9722K	8001277000	645200	8001110600
AZC001	8001110600	CD 2504	8001130800	9635	8001131700	9732K	8001193500	645450	8001110600
AZC002	8001110600	CD1302	8001110600	9638	8001227600	9733K	8001327000	64520002	8001110600
AZC005	8001110600	CD1304	8001110600	9640	8001225400	9739K	8001381100	64545005	8001110600
AZC054	8001265300	CD2002	8001128800	9647	8001227800	977K	8001128800	CYCLONE	
AZC105	8001128800	CD2004	8001128800	9648	8001352700	997K	8001128800	PMA101237	8001225100
AZC107	8001131600	CD3002	8001138900	9649	8001353000	CUMMINS		PMA101237K	8001225100
AZC108	8001128800	CD3004	8001138900	9650	8001353100	196677	8001130800	PMA101246	8001224300
AZC109	8001222900	CD3502	8001224500	9653	8001315000	204538	8001224500	PMA101275K	8001110600
AZC110	8001222100	CD3504	8001224500	9655	8001226500	204624	8001131700	PMA102745	8001167500
AZC206	8001130800	CROSLAND		9659	8001228500	204631	8001138900	PMA102745K	8001167500
AZC207	8001131700	746	8001138900	9664	8001285700	204632	8001139100	PMA103951	8601567700
AZC250	8001138900	810	8001283900	9665	8001648700	204635	8001225300	PMA105043K	8001222100
AZC251	8001138900	830	8001217700	9667	8001648800	204636	8001225200	PMA105368K	8001128800
AZC252	8001225100	838	8001134800	9670	8001280900	204638	8001224500	PMA106587	8001138900
AZC253	8001225100	944	8001138900	9673	8001249100	204639	8001225400	PMA106769	8001224500
AZC254	8001138900	952	8001266000	9674	8001248500	253565	8001315000	PMA106775	8001225400
AZC255	8001139100	965	8001224500	9682	8001222600	299353	8001225100	PMA108668K	8001130800
AZC300	8001224500	969	8001265300	9714	8001238700	299418	8001138900	PMA108674	8001131700
AZC301	8001224500	8040	8001421100	9715	8001309000	650152	8001138900	PMA108736	8001220200
AZC303	8001225400	9009	8001295300	9724	8001434300	650930	8001224500	PMA109085	8001227400
AZF003	8001283900	9226	8601569000	9729	8001687600	706396	8001225100	PMA109200	8001226900
AZF008	8001217700	9264	8601569300	9735	8001204800	706425	8001138900	PMA117781	8001707500
DU1206S	8001138900	9510	8001238500	9742	8001223400	3013206	8001225300	PMA117782	8001707000
DU1206TS	8001138900	9522	8001223500	9745	8001352900	3013207	8001225200	PMA118211	8001335600
DU1233S	8001225100	9523	8001687300	9748	8001688000	3013208	8001224500	PMA118216	8001335700
DU1233TS	8001225100	9529	8001298000	9749	8001410700	3013209	8001225400	PMA119649	8001222600
DU1454	8001265300	9532	8001239700	9750	8001352800	3013212	8001723000	PMA1424HD	8001138900
DU1518S	8001224500	9533	8001223800	9765	8001282500	3013213	8001723200	PMA192HD	8001217700
DU1518TS	8001224500	9550	8001224800	9776	8001478700	3230272	8001138900	PMA46976	8001410400
DU1705T	8001128800	9551	8001238600	9779	8001318500	3230273	8001139100	PMA4M8048	8001315700
DU2222	8001128800	9552	8001221400	9783	8001736500	3315187	8001138900	PMA4M9334	8001221400
DU2231	8001131600	9555	8001282600	9784	8001441300	3318279	8001110600	PMA4M9335	8001315600
DU2354	8001222800	9556	8001224200	9795	8001529400	3325291	8001225400	PMA6500HD	8001284700
DU2399	8001110600	9561	8001223100	9796	8001250700	3325292	8001224500	PMA7M9046	8001315000
DU664S	8001110600	9572	8001227300	9799	8001440900	3353440	8001238500	DAEWOO	
DU664TS	8001110600	9573	8001227400	8243K	8001234500	3429703	8601491000	24719023	8001234500
EAP3518	8601569000	9576	8001121100	920K	8601568000	3905241	8001224300	24746025	8001139100

MFRS Cod.	VIRGIS Cod.	MFRS Cod.	VIRGIS Cod.	MFRS Cod.	VIRGIS Cod.	MFRS Cod.	VIRGIS Cod.	MFRS Cod.	VIRGIS Cod.
24749015	8001128800	763AIR	8001225400	DENNIS		FC106	8001238500	DU2354	8001222800
24749019	8001131700	764AIR	8001227400	606341/2	8001225100	FC109	8001224800	DU664	8001110600
24749020	8001130800	765AIR	8001227300	610826/1	8001130800	FC201	8001129500	DU770CT	8001100300
94749001	8001279800	768AIR	8001131700	DEUTZ		FC202	8001224400	DU770T	8001100300
94749002	8001239500	785AIR	8001131500	1319822	8601680000	FC212	8001128800	E500075	8001265300
DAF		789AIR	8001410400	2165044	8001238600	FC214	8001131600	E500150	8001110600
110376	8001687300	835AIR	8001224500	2243946	8001352700	FC215	8001131500	E500667	8001155500
393561	8001410700	836AIR	8001138900	2415950	8001353000	FC216	8001131700	E501042	8001105600
506337	8001687300	K480AIR	8001110600	4384103	8001222500	FC217	8001223500	E700119	8001128800
607179	8001223500	K567AIR	8001128800	01319822	8601680000	FC218	8001687300	E700127	8001129500
691280	8001352900	K591AIR	8001225100	DIAMOND		FC220	8001223100	EAF5002	8001225300
691733	8001223100	K592AIR	8001220200	DX0143/1	8001287000	FC221	8001222500	EAF5034	8001138900
692380	8001353100	K685AIR	8001167500	DX1722	8001298000	FC222	8001225100	EAF5040	8001707000
694218	8001227800	K703AIR	8001222100	DX211	8001314100	DIVERSIFIED IND.		EAF5041	8001227300
695633	8001238600	K705AIR	8001128800	DX214	8001315700	EDC032	8001227300	EAF5042	8001723000
1295090	8001668900	K767AIR	8001130800	DX215	8001315600	DOMINION		EAF5044	8001226900
DAIHATSU		K783AIR	8001224400	DX302	8001238600	11564	8001227400	EAF5046	8001224500
1780187601	8001183700	DEMAG		DX307	8001239700	11565	8001227300	P019159	8001221400
DAVEY		515162	8001130800	DX309	8001222500	16307	8001226900	P101237	8001225100
A49329	8001224300	746444	8001224200	DX311	8001228500	DONALDSON		P101275	8001110600
A60743	8001225100	901069	8001110600	DX315	8001315000	900635	8001222500	P102525	8001225100
C46155	8001224300	956571	8001129500	DX380	8001227300	2625023-000-440	8001783000	P102745	8001167500
T40348	8001110600	964013	8001238600	DX381	8001227400	B085001	9351655000.	P103688	8601567700
DAVID BROWN		988575	8001228500	DX395	8001282600	B085011	9351656000.	P103951	8601567700
922630	8001217700	988585	8001238500	DX4043	8001224800	B085024	9351686200.	P104384	8001315700
DAVIS		988595	8001353100	DX613	8001221400	B085034	9351685900.	P104385	8001315600
146290	8001110600	988596	8001223500	L3	8001209100	B085056	9351711400.	P104387	8001315000
149534	8001110600	988633	8001227300	DIAMOND T		B100094	9351716300.	P105043	8001222100
152553	8001110600	988634	8001227400	3107368H2	8001138900	B105006	9351614100.	P105368	8001128800
8J3714629	8001110600	988673	8001227800	896688H2	8001225100	B105013	9351686400.	P105555	8001167500
DELUXE		988674	8001352800	DIGOMAT		B120439	9351711100.	P105629	8001110600
302AIR	8601409000	988740	8001353000	DGM/L 01128	8001434300	B125011	9351575100.	P105961	8601567700
474AIR	8001224300	988765	8001352900	DGMMO1378K	8001167500	C045001	9351971100.	P106587	8001138900
477AIR	8001139100	988766	8001224200	DGMO1378K	8001167500	C055003	9351891900.	P106769	8001224500
480AIR	8001110600	988767	8001352700	DITCH WITCH		C065001	9351771000.	P106775	8001225400
498AIR	8001315000	4278774	8001223500	195426	8001110600	C065003	9351733000.	P106834	8001139100
499AIR	8001221400	5150574	8001129500	195427	8001110600	C085001	9351733300.	P107672	8001224500
567AIR	8001128800	29504356	8001223500	195671	8001110600	C085002	9351733100.	P107868	8001128800
569AIR	8001131600	29504376	8001238500	195682	8001110600	C085004	9351732900.	P108668	8001130800
577AIR	8001226500	29504476	8001228500	195703	8001224400	C085035	9351785200.	P108674	8001131700
589AIR	8001240300	39468640	8001353000	195709	8001224400	C105003	9351782300.	P108736	8001220200
598AIR	8001315700	76141573	8001723000	195711	8001224300	C105004	9351733500.	P109085	8001227400
600AIR	8001315600	76141673	8001723200	195735	8001100300	C125004	9351733600.	P109200	8001226900
653AIR	8601567700	97387973	8001234500	DITEX		D065008	9351733200.	P110544	8001167500
683AIR	8001707500	00405174	8001238500	FC103	8001130800	DU1206T	8001138900	P110545	8001110600
684AIR	8001707000	04005074	8001238600	FC104	8001138900	DU1233	8001225100	P110554	8001130800
689AIR	8001226900	0746444	8001224200	FC105	8001238600	DU1518T	8001224500	P110555	8001131700

MFRS Cod.	VIRGIS Cod.	MFRS Cod.	VIRGIS Cod.	MFRS Cod.	VIRGIS Cod.	MFRS Cod.	VIRGIS Cod.	MFRS Cod.	VIRGIS Cod.
P110556	8001138900	P119410	8001131600	P123405	8001128800	P132597	8001224500	P142141	8001238600
P110557	8001139100	P119538	8001473300	P123412	8601409000	P132598	8001225200	P142742	8001226900
P110558	8001224500	P119576	8001227300	P123753	8001128800	P132599	8001227400	P142743	8001227300
P110559	8001225400	P119612	8001130800	P123770	8001226500	P132601	8001224500	P142744	8001138900
P111065	8001228400	P119613	8001239500	P124154	8001100300	P132604	8001138900	P142746	8001707500
P111098	8601567700	P119648	8001105600	P124156	8001110600	P132605	8001139100	P142747	8001707000
P111776	8001227400	P119649	8001222600	P124164	8001222800	P132609	8001225400	P142750	8001227400
P112031	8001225100	P119674	8001100300	P124173	8001128800	P132976	8001224300	P142752	8001225200
P113179	8001227300	P119677	8001227400	P124176	8001225100	P132977	8001110600	P142753	8001139100
P113341	8001130800	P119696	8001225100	P124179	8001265300	P133138	8001239500	P142755	8001226500
P113343	8001239500	P119775	8001103800	P124525	8001227600	P133140	8001130800	P142756	8001224400
P113501	8001410400	P119776	8001110600	P124526	8001131700	P133149	8001225300	P143316	8001138900
P114500	8001131500	P119778	8001226500	P126334	8001130800	P133152	8001225200	P143571	8001167500
P114506	8001131500	P120022	8001224400	P126343	8001139100	P133320	8001138900	P145444	8001110600
P114747	8001222100	P120113	8001110600	P126984	8001222600	P133321	8001224500	P145520	8001226900
P115623	8001138900	P120281	8001146700	P127532	8001227600	P133322	8001139100	P145521	8001227300
P116501	8001138900	P120307	8001341000	P127784	8001222800	P133323	8001225400	P145655	8001167500
P116502	8001139100	P120591	8001224400	P127787	8001222900	P133546	8001110600	P145695	8001227400
P116541	8001139100	P120841	8001225300	P128047	8001723000	P136256	8001130800	P145700	8001279800
P116570	8001314100	P120842	8001224500	P128149	8001128800	P136259	8001105600	P145895	8001224400
P117433	8001226900	P120949	8001498000	P128406	8001723200	P136657	8001227400	P148380	8001138900
P117435	8001227300	P121200	8001110600	P128407	8001723000	P136658	8001707000	P148381	8001130800
P117437	8001224500	P121240	8001167500	P128408	8001723200	P136659	8001707500	P148383	8001110600
P117439	8001138900	P121414	8001222600	P128517	8001227400	P136660	8001225200	P148384	8001226500
P117443	8001225300	P121415	8001131500	P128531	8001111000	P136824	8001227400	P148821	8001138900
P117580	8001227300	P121642	8001105600	P129200	8001226900	P136840	8001110600	P148823	8001222900
P117781	8001707500	P121643	8001222600	P129610	8001707000	P136989	8001226900	P148967	8001146700
P117781	8001707500	P121673	8001130800	P130760	8001105600	P136991	8001723200	P148969	8001110600
P117782	8001707000	P121674	8001138900	P130761	8001105600	P138133	8001227300	P148970	8001167500
P117939	8001138900	P121675	8001224500	P130765	8001138900	P138336	8001204800	P150061	8001224500
P118160	8001100300	P122026	8001131600	P130771	8001410400	P138748	8001110600	P150135	8601409000
P118166	8001130800	P122073	8001128800	P130776	8001222600	P138752	8001221400	P150610	8001128800
P118211	8001335600	P122074	8001131600	P131280	8001335600	P138861	8001240300	P150611	8001473300
P118216	8001335700	P122133	8001226500	P131282	8001224400	P138999	8001167500	P150612	8001224400
P119100	8001224400	P122155	8001131700	P131328	8001130800	P140101	8001227800	P150908	8001221400
P119135	8001129500	P122156	8001139100	P131329	8001130800	P140110	8001223500	P150921	8001314100
P119136	8001128800	P122157	8001225400	P131333	8001227300	P140122	8001687300	P150933	8001315700
P119235	8001227300	P122329	8001138900	P131334	8001239500	P140123	8001238500	P150934	8001315600
P119237	8001225300	P122330	8001224500	P131344	8001131600	P140136	8001224200	P150935	8001315000
P119340	8001110600	P122510	8001110600	P131346	8001105600	P140185	8001223800	P151135	8001723000
P119363	8001128800	P122696	8001225100	P131350	8001131700	P140186	8001223100	P151145	8001128800
P119370	8001227400	P122836	8001225300	P131351	8001139100	P140187	8001238600	P151156	8001225100
P119372	8001225200	P122837	8001225200	P131352	8001225400	P140237	8001707000	P151157	8001224500
P119373	8001225400	P122860	8001105600	P131394	8001111000	P140537	8001167500	P151179	8001473300
P119374	8001139100	P122991	8001131600	P131399	8001225200	P141628	8001224500	P151323	8001110600
P119375	8001131700	P123160	8001110900	P131403	8001128800	P141629	8001225400	P151596	8001227300
P119409	8001128800	P123160	8001434300	P132566	8001105600	P141770	8001286700	P151757	8001131500

MFRS Cod.	VIRGIS Cod.	MFRS Cod.	VIRGIS Cod.	MFRS Cod.	VIRGIS Cod.	MFRS Cod.	VIRGIS Cod.	MFRS Cod.	VIRGIS Cod.
P151771	8001224500	P158182	8001238500	P182090	8001227600	P770181	8001204800	P771552	8001307400
P151774	8001128800	P158557	8001128800	P182173	8001224500	P770197	8001193500	P771553	8001483500
P151775	8001473300	P158661	8001315700	P184034	8001138900	P770198	8001131600	P771555	8001445500
P151776	8001146700	P158662	8001315600	P184035	8001225100	P770221	8001275200	P771556	8001438600
P151777	8001723000	P158663	8001315000	P184041	8001227300	P770364	8001307400	P771557	8001222500
P151903	8001225400	P158669	8001314100	P184042	8001723000	P770367	8001194200	P771558	8001227800
P151904	8001225100	P160558	8001224300	P184044	8001226900	P770373	8001110600	P771561	8001238500
P151905	8001226500	P170180	8001188000	P184046	8001224500	P770397	8001229000	P771564	8001222800
P151906	8001224400	P181034	8001138900	P185002	8001225300	P770414	8001227600	P771572	8001340400
P151910	8001131700	P181035	8001225100	P185034	8001138900	P770494	8001131700	P771575	8001238700
P151917	8001227400	P181041	8001227300	P185040	8001707000	P770495	8001226500	P771593	8001228500
P151918	8001227300	P181042	8001723000	P185041	8001227300	P770504	8001224800	P771594	8001209100
P151921	8001224500	P181044	8001226900	P185042	8001723000	P770520	8001131700	P772504	8001227600
P151951	8001223400	P181046	8001224500	P185044	8001226900	P770589	8001736500	P772520	8001279400
P151966	8001723200	P181046	8001224500	P185046	8001224500	P770666	8001134300	P772521	8001530000
P152038	8001238500	P181050	8001110600	P19159	8001221400	P770677	8001279400	P772522	8001279800
P152302	8001498000	P181054	8001100300	P500243	8001495000	P770709	8001530000	P772527	8001134300
P152576	8001224500	P181059	8001128800	P522450	8001260500	P770734	8001279800	P772529	8001194200
P152583	8001224500	P181062	8001473300	P522839	8001224200	P770736	8001225400	P772530	8001279000
P152643	8001110600	P181063	8001224400	P525027	8001167500	P770739	8001224500	P772531	8001234500
P152644	8001128800	P181064	8001130800	P526504	8001286700	P770800	8001279000	P772532	8001131700
P152647	8001167500	P181072	8001146700	P526660	8001473300	P770833	8001445500	P772534	8001410400
P152648	8001225100	P181088	8001238600	P526755	8001130800	P770834	8001234500	P772545	8001130800
P152652	8001224400	P181089	8001223100	P529556	8001341000	P770954	8001423700	P772549	8001188000
P152654	8001473300	P181090	8001227600	P529596	8001225300	P771004	8001410400	P772550	8001193500
P152655	8001130800	P181104	8001221400	P530645	8001295300	P771174	8001560400	P772552	8001307400
P152656	8001146700	P181126	8001240300	P531034	8001353100	P771504	8001227600	P772553	8001483500
P152659	8001138900	P181137	8001223500	P532003	8001352900	P771507	8001687300	P772555	8001445500
P152712	8001341000	P181173	8001224500	P532006	8001648800	P771508	8001224200	P772564	8001222800
P152714	8001226500	P181184	8001223500	P532007	8001353100	P771509	8001223800	P772565	8001307500
P152716	8001139100	P181186	8001102000	P532008	8001352700	P771511	8001111700	P772578	8001440900
P152718	8001131700	P181206	8001209100	P532012	8001298000	P771515	8001275200	P772579	8001407400
P153351	8001225100	P182002	8001225300	P533332	8001271600	P771516	8001224800	P772580	8001441000
P153352	8001138900	P182034	8001138900	P535332	8001427000	P771520	8001279400	P772581	8001567300
P153353	8001139100	P182040	8001707000	P535362	8001271600	P771521	8001530000	P772585	8001529400
P153354	8001224500	P182040	8001707000	P536457	8001878300	P771522	8001279800	P772586	8001556500
P153355	8001130800	P182041	8001227300	P537876	8001668900	P771527	8001134300	P772587	8001415400
P153356	8001225400	P182042	8001723000	P537877	8001629000	P771529	8001194200	P772597	8001347300
P153358	8001167500	P182044	8001226900	P538494	8001588700	P771530	8001279000	P773605	8001327000
P153359	8001110600	P182046	8001224500	P539466	8001209100	P771531	8001234500	P774501	8001556500
P153361	8001131700	P182050	8001110600	P606948	8001878100	P771532	8001423700	P774502	8001138900
P153386	8001335600	P182052	8001103800	P607351	8001472200	P771534	8001410400	P774504	8001227600
P154003	8001434300	P182054	8001100300	P77-0227	8001266000	P771537	8001265300	P774505	8001226900
P154631	8001434300	P182062	8001473300	P770027	8001228300	P771545	8001130800	P774509	8001193500
P154632	8001128800	P182063	8001224400	P770035	8001121100	P771549	8001188000	P774518	8001224500
P155334	8001131600	P182064	8001130800	P770145	8001105600	P771550	8001193500	P774524	8001224500
P155698	8001723200	P182072	8001146700	P770180	8001188000	P771551	8001266000	P774538	8001279800

MFRS Cod.	VIRGIS Cod.	MFRS Cod.	VIRGIS Cod.	MFRS Cod.	VIRGIS Cod.	MFRS Cod.	VIRGIS Cod.	MFRS Cod.	VIRGIS Cod.
P774550	8001193500	P777638	8001692800	P809315	8001224500	P900715	8001224500	SMP771509	8001223800
P774551	8001530400	P777639	8001538000	P811004	8001130800	P900717	8001225400	SMP771515	8001275200
P774552	8001530000	P777654	8001547500	P811200	8001225100	P900830	8001130800	SMP771516	8001224800
P774576	8001529400	P777655	8001547500	P811203	8001138900	P900831	8001131700	SMP771520	8001279400
P774578	8001347300	P777868	8001629400	P811213	8001225100	P900832	8001260400	SMP771521	8001530000
P774583	8001225400	P777869	8001630100	P811413	8001224500	P900833	8001260500	SMP771522	8001279800
P775064	8001250700	P777871	8001652100	P811500	8001110600	P900836	8001128800	SMP771527	8001134300
P775074	8001250700	P777875	8001652200	P812016	8001130800	P900929	8001279000	SMP771529	8001194200
P775298	8001440200	P778131	8001687600	P812204	8001138900	P900942	8001279400	SMP771530	8001279000
P775300	8001427000	P778335	8001489600	P812223	8001138900	P901512	8001315700	SMP771531	8001234500
P775302	8001441300	P778336	8001490200	P812405	8001224500	P901514	8001315600	SMP771532	8001131700
P775339	8001568100	P778404	8001239700	P812408	8001224500	P901516	8001315000	SMP771534	8001410400
P775366	8001648800	P778441	8001410700	P812506	8001110600	P901526	8001221400	SMP771537	8001265300
P775367	8001648700	P778509	8001438700	P812513	8001277000	P901550	8001314100	SMP771545	8001130800
P775368	8001353000	P780272	8001318500	P812600	8001225300	P903914	8001224500	SMP771549	8001188000
P775369	8001352700	P780522	8001672900	P812602	8001225300	R800969	8001225400	SMP771550	8001193500
P775370	8001352900	P780523	8001673100	P814539	8001139100	R804200	8001279800	SMP771551	8001266000
P775371	8001352800	P780621	8001878400	P814723	8001277000	R804201	8001224500	SMP771552	8001307400
P775372	8001353100	P780622	8001652300	P815267	8001273900	R804300	8001138900	SMP771553	8001327000
P775457	8001482900	P780622	8001652300	P815288	8001193500	R804301	8001335600	SMP771555	8001445500
P775500	8001560400	P780647	8001407400	P815840	8001167500	R804523	8001110900	SMP771564	8001238500
P775631	8001440900	P780910	8001668900	P815850	8001110600	R804523	8001434300	SMP771572	8001340400
P775687	8001277000	P781039	8001537100	P815851	8001110600	R804570	8001226500	SMP771594	8001209100
P775704	8001687900	P781741	8001692200	P815852	8001110600	SMP181034	8001138900	XLP182002	8001225300
P775739	8001238600	P781911	8001441000	P815861	8001103800	SMP181035	8001225100	XLP182034	8001138900
P775792	8001223100	P782099	8001629400	P815880	8001128800	SMP181041	8001227300	XLP182040	8001707000
P775803	8001250700	P784015	8601570000	P815881	8001128800	SMP181042	8001723000	XLP182041	8001227300
P775804	8001530400	P784574	8601570100	P821575	8001588700	SMP181044	8001226900	XLP182042	8001723000
P775843	8001376300	P786107	8001930500	P821938	8001881200	SMP181046	8001224500	XLP182044	8001226900
P776260	8001282500	P786421	8001981800	P822143	8001139100	SMP181050	8001110600	XLP182046	8001224500
P776284	8001445500	P7886829	8001227800	P822144	8001225400	SMP181059	8001128800	XLP182050	8001110600
P776358	8001194100	P801843	8001130800	P822686	8001441200	SMP181062	8001473300	XLP182052	8001103800
P776565	8001110900	P802507	8001225200	P822768	8001605000	SMP181063	8001224400	XLP182062	8001473300
P776694	8001353000	P802781	8001225400	P822769	8001605400	SMP181064	8001130800	XLP182063	8001224400
P776695	8001353100	P803914	8001224500	P822858	8001610800	SMP181072	8001146700	XLP182064	8001130800
P776696	8001352700	P803915	8001224500	P823333	8001441300	SMP181088	8001238600	XLP182072	8001146700
P776697	8001352900	P804874	8001225400	P826982	8001139100	SMP181089	8001223100	XLP182090	8001227600
P776745	8001652300	P806412	8001434300	P827653	8001749000	SMP181090	8001227600	XLP184034	8001138900
P776895	8001478700	P806426	8001224500	P827655	8001547500	SMP181104	8001221400	XLP184035	8001225100
P777279	8001668900	P806660	8001225200	P828889	8001736500	SMP181126	8001240300	XLP184041	8001227300
P777408	8001629000	P806766	8001225400	P829332	8001427000	SMP181137	8001223500	XLP184042	8001723000
P777409	8001488800	P806767	8001224500	P829333	8001736600	SMP181184	8001223500	XLP184044	8001226900
P777414	8001629000	P807219	8001224500	P900152	8001223100	SMP181206	8001209100	XLP184046	8001224500
P777523	8001648800	P807335	8001335700	P900433	8001128800	SMP771174	8001560400	XLP772504	8001227600
P777524	8001648700	P807336	8001335600	P900434	8001131500	SMP771504	8001227600	XLP772520	8001279400
P777551	8001352800	P807628	8001222600	P900635	8001222500	SMP771507	8001687300	XLP772521	8001530000
P777579	8001490000	P807641	8001105600	P900685	8001222500	SMP771508	8001224200	XLP772522	8001279800

MFRS Cod.	VIRGIS Cod.	MFRS Cod.	VIRGIS Cod.	MFRS Cod.	VIRGIS Cod.	MFRS Cod.	VIRGIS Cod.	MFRS Cod.	VIRGIS Cod.
XLP772527	8001134300	FHG080205	8001128800	FWA080055	8001224300	FWG052579	8001110600	4930052	8001266000
XLP772529	8001194200	FHG080233	8001128800	FWA080517	8001222100	FWG052597	8001110600	4930060	8001128800
XLP772530	8001279000	FHG080270	8001128800	FWA080518	8001222100	FWG052619	8001110600	4930096	8001224800
XLP772531	8001234500	FHG080281	8001222800	FWA080519	8001222100	FWG080035	8001222100	4930140	8001228500
XLP772532	8001131700	FHG080306	8001128800	FWA080520	8001222100	FWG080044	8001128800	4930142	8001131700
XLP772534	8001410400	FHG080307	8001128800	FWA120003	8001225100	FWG080228	8001224300	4930309	8001227800
XLP772545	8001130800	FHG080310	8001131600	FWA120008	8001225100	FWG080229	8001224300	4930324	8001295300
XLP772549	8001188000	FHG090021	8001224400	FWA120024	8001225100	FWG080239	8001222100	4930363	8001352700
XLP772550	8001193500	FHG090024	8001224400	FWA120025	8001225100	FWG080276	8001100300	4930372	8001353000
XLP772552	8001307400	FHG090025	8001224400	FWA120035	8001225100	FWG090071	8001410400	4930384	8001139100
XLP772553	8001483500	FHG090031	8001226500	FWA120036	8001225100	FWG100007	8001139100	4930387	8001222500
XLP772555	8001445500	FHG090046	8001226500	FWA120044	8001225100	FWG100084	8001224400	4930393	8001298000
XLP772564	8001222800	FHG090053	8001226500	FWA120051	8001225100	FWG120015	8001225100	4930405	8001129500
XLP772565	8001307500	FHG090081	8001224400	FWA120053	8001225100	FWG120024	8001225100	4930432	8001105600
XLP772586	8001556500	FHG100028	8001130800	FWA120054	8001225100	FWG120034	8001138900	4930436	8001224500
XLP772587	8001234500	FHG100035	8001130800	FWA120061	8001225100	FWG120059	8001225100	4930439	8001225400
XLP772597	8001347300	FHG100044	8001130800	FWA120063	8001225100	FWG120061	8001225100	4930440	8001222600
XLP774501	8001556500	FHG100123	8001130800	FWA120075	8001225100	FWG120063	8001225100	4930449	8001223100
XLP774524	8001224500	FHG120012	8001138900	FWA120082	8001225100	FWG120084	8001225100	4930487	8001352900
XLP774552	8001530000	FHG120037	8001138900	FWA120084	8001225100	FWG120109	8001225100	4930497	8001138900
XLP774576	8001529400	FHG120062	8001138900	FWA120085	8001225100	FWG120111	8001225100	4930509	8001224400
DONALDSON HOUSINGS		FHG120102	8001138900	FWA120091	8001225100	FWG140028	8001224500	4930511	8001224400
EBB120070	8001221400	FHG120105	8001138900	FWA120092	8001225100	FWG140052	8001224500	4930549	8001226500
FHG052558	8001146700	FHG120106	8001138900	FWA120094	8001225100	FWG140118	8001224500	4930550	8001353100
FHG052559	8001146700	FHG120134	8001138900	FWA120098	8001225100	KAX000171	8001167500	4930646	8001110600
FHG052560	8001146700	FHG120135	8001138900	FWD042501	8001167500	KAX000510	8001110600	4930684	8001239700
FHG052561	8001146700	FHG120152	8001131700	FWG042501	8001167500	KAX000514	8001139100	4130115U	8001130800
FHG052562	8001146700	FHG120154	8001139100	FWG042503	8001167500	KAX002079	8001138900	413095B	8001224200
FHG052567	8001220200	FHG140023	8001224500	FWG042504	8001167500	KAX002416	8001138900	DRESSER/GALION	
FHG052594	8001110600	FHG140055	8001224500	FWG042529	8001167500	KAX002459	8001138900	99737	8001138900
FHG052595	8001110600	FHG140065	8001224500	FWG052509	8001110600	KAX002594	8001224500	99739	8001139100
FHG052599	8001110600	FHG140103	8001224500	FWG052510	8001110600	KAX002595	8001225300	103259	8001225400
FHG065104	8001473300	FHG140118	8001224500	FWG052511	8001110600	KAX003845	8001224500	106576	8001130800
FHG065115	8001473300	FHG140121	8001224500	FWG052512	8001110600	KYX000460	8001315700	106579	8001131700
FHG065124	8001129500	FHG140152	8001225400	FWG052513	8001110600	KYX000461	8001315600	DRILTECH	
FHG065137	8001129500	FHG140164	8001224500	FWG052516	8001110600	KYX003507	8001131700	001036061	8001707000
FHG065140	8001222600	FHG140194	8001224500	FWG052518	8001110600	SRG200031	8001707500	00103653	8001707500
FHG065152	8001105600	FHG140208	8001224500	FWG052522	8001110600	STG140338	8001227300	00103661	8001707000
FHG065155	8001129500	FHG160225	8001225300	FWG052523	8001110600	DONIT		DROTT	
FHG065175	8001105600	FHG160254	8001225300	FWG052525	8001220200	413033	8001134800	208433	8001224300
FHG065181	8001105600	FWA052526	8001110600	FWG052527	8001110600	413042	8001223500	505694	8001224300
FHG065191	8001105600	FWA052527	8001110600	FWG052528	8001110600	413082	8001238600	609421	8001138900
FHG065199	8001105600	FWA052542	8001110600	FWG052530	8001110600	413086	8001209100	5512140	8001146700
FHG065205	8001131500	FWA052551	8001110600	FWG052539	8001110600	413090	8001225300	A43656	8001226900
FHG065207	8001222600	FWA052552	8001110600	FWG052545	8001110600	413095	8001223400	A436576	8001226900
FHG065211	8001105600	FWA052563	8001110600	FWG052563	8001167500	413098	8001238500	DYNAPAC	
FHG080195	8001128800	FWA080054	8001224300	FWG052575	8001110600	493022	8001225100	212145	8001193500

MFRS Cod.	VIRGIS Cod.	MFRS Cod.	VIRGIS Cod.	MFRS Cod.	VIRGIS Cod.	MFRS Cod.	VIRGIS Cod.	MFRS Cod.	VIRGIS Cod.
499208	8001167500	9034529	8001227300	P26510214	8001128800	4134370	8001353000	F198810140010	8601568800
499306	8001224400	9035368	8001227400	YMR000060	8001110600	4134389	8001138900	F205200091010	8001648800
499307	8001226500	9035428	8001227400	YMR000463	8001110600	4134403	8001223500	F278201090020	8001228500
499309	8001110600	9036278	8001227400	FAIRBANKS - MORSE		4134406	8001224200	F280200090030	8001352700
499345	8001128800	9037346	8001227400	16006108	8001110600	4134407	8001352700	F291200090100	8001223500
499346	8001131600	9038349	8001707500	16006114	8001110600	4134415	8001352900	F291200090110	8001352900
499514	8001227400	9038350	8001707000	FAIRMONT RAILWAY		4134419	8001352800	F345200090010	8001648800
499553	8001130800	9038407	8001226900	F17526	8001224300	4134428	8001648800	F385202090010	8001224200
814256	8001131700	9038898	8001225100	FAIRMONT RAILWAY MOTORS		9746444	8001224200	H515200090100	8001692800
814257	8001130800	9038899	8001227300	F17526	8001224300	0746232	8001225100	H515200090110	8001538000
902199	8001478700	9049489	8001227400	FAMEL		0746237	8001225100	H716200090100	8001692800
E-ZGO CAR		9049490	8001225200	FR1006	8001352900	0746369	8001238500	H716200090110	8001538000
50133GZ	8001167500	9053258	8001723200	FR1018	8001128800	0746383	8001238600	X810270072	8001687900
A10706G1	8001167500	9059564	8001723000	FR1023	8001723000	0746385	8001687300	FENWICK	
E.R.F.		9059575	8001227600	FR1024	8001723200	0746389	8001227800	8100346	8001167500
33664	8001138900	9065371	8001227400	FR861	8001223100	0746444	8001224200	8100778	8001110600
39134	8001224500	9240849	8001227400	FR865	8001223500	0746554	8001131600	8101220	8001110900
942786	8001225200	9247285	8001227400	FR868	8001352700	0746555	8001128800	8103598	8001204800
942792	8001225300	9377816	8001225400	FR983	8001687300	0746712	8001353100	8104273	8001353000
987768	8001445500	9391941	8001129500	FR985	8001648700	0746713	8001707000	9831604	8001238500
991312	8001223500	9394161	8001224500	FR986	8001353000	0746714	8001707500	9839012	8001239700
1318965	8001224200	9398482	8001224500	FR987	8001353100	0746718	8001227400	9839014	8001223100
ECOMAT		9398483	8001225400	FARMHAND		0746725	8001223100	9839015	8001238600
Y1500001	8001204800	EXCEL		1R2005	8001224500	0746910	8001239700	9839016	8001648800
EDER		57448	8001110600	1R2006	8001225400	0746911	8001687300	9839017	8001648700
900136	8001131700	57455	8001110600	FARYMANN		0746916	8001224500	9839019	8001228500
900137	8001227600	FACO		5410612	8001287000	0746928	8001227800	9839331	8001110600
ELGIN SWEEPER		10050	8001434300	FAUN- FRISCH		0746931	8001226500	983 9020	8001353100
7072938	8001131500	FAHR		1170781	8001223500	0747082	8001723000	FM8104273	8001353000
A11569	8001224300	1111401910300	8001223100	1416433	8001224200	0747083	8001723200	FIAAM	
AY2011	8001224300	1111402030400	8001353000	1470630	8001353100	0747092	8001131700	FLI6195	8001315700
ENUMCLAW		1111402030600	8001238600	1470631	8001238600	0747093	8001227600	FLI6203	8001315000
17580	8001224300	1210602017700	8001223100	1470634	8001353000	1470629	8001238500	FLI6273	8001266000
ERICKSON		1210702019500	8001238500	1470637	8001223500	4134366	8001238500	FLI6276	8001315600
35176	8001110600	1210702033400	8001224200	1470661	8001131600	FENDT		FLI6277	8001221400
35178	8001110600	1210702033500	8001352700	1470695	8001223500	F135201090020	8001239700	FLI6304	8001209100
35508	8001110600	1212302023600	8001353100	1470696	8001227800	F135203092010	8001209100	FLI6406	8001222100
35767	8001110600	8121918027400	8001353100	1470702	8001224200	F178200090010	8001223100	FLI6411	8001220200
EUCLID		FAI		1470703	8001352700	F178200090020	8001648700	FLI6412	8001129500
4001135	8001226900	848100069	8001188000	1470717	8001352900	F178810140010	8601568800	FLI6413	8001131500
4001156	8001226900	848101065	8001128800	1470718	8001223500	F182200090010	8001238600	FLI6416	8001238500
4003987	8001227400	848101104	8001131600	1470721	8001352800	F184200090010	8001238600	FLI6417	8001238600
4012359	8001226900	848101113	8001155500	1470731	8001648800	F184200090040	8001353000	FLI6418	8001131600
4012360	8001227400	848101114	8001110600	2165039	8001223100	F184230090050	8001238500	FLI6421	8001167500
4012361	8001227300	848101116	8001161800	4134352	8001130800	F184230090100	8001353100	FLI6423	8001130800
4058189	8001131700	848101155	8001128800	4134367	8001353100	F186200091010	8001298000	FLI6424	8001131700
9030894	8001225100	P26510192	8001110600	4134368	8001238600	F198200090010	8001238600	FLI6427	8001110600

MFRS Cod.	VIRGIS Cod.	MFRS Cod.	VIRGIS Cod.	MFRS Cod.	VIRGIS Cod.	MFRS Cod.	VIRGIS Cod.	MFRS Cod.	VIRGIS Cod.
FLI6435	8001128800	FLI6826	8001567300	1007973	8001128800	22190599	8001279000	71420350	8001234500
FLI6438	8001222500	FLI6838	8001410700	1010407	8001128800	42015789	8001223500	71909116	8001222800
FLI6439	8001222600	FLI6860	8001688000	1140887	8001224300	70107974	8001131600	71909128	8001105600
FLI6440	8001105600	FLI6862	8001687900	1140889	8001110600	70197588	8001225200	71909129	8001222600
FLI6441	8001314100	FIAT		1183993	8001131700	70239513	8001110600	71909136	8001138900
FLI6446	8001138900	74191441	8601836400	1901902	8001224500	70239518	8001110600	71909140	8001222600
FLI6456	8001222800	FIAT HITACHI		1902129	8001227800	70244570	8001139100	71909141	8001105600
FLI6457	8001222900	1930174	8001134300	1909116	8001222800	70247060	8001167500	71930174	8001134300
FLI6459	8001223100	1930602	8001234500	1909117	8001222900	70250699	8001110600	71930175	8001131700
FLI6466	8001223400	1930603	8001445500	1909131	8001223500	70256395	8001224400	72083768	8001139100
FLI6467	8001223500	1930748	8001225400	1909132	8001352900	70256983	8001128800	72083771	8001138900
FLI6471	8001687300	1930752	8001131700	1909135	8001131700	70257024	8001128800	72097035	8001110600
FLI6475	8001223800	1930787	8001438600	1909138	8001434300	70257029	8001131600	73039681	8001225100
FLI6491	8001224200	1930824	8001483500	1909139	8001103800	70257597	8001110600	73042922	8001138900
FLI6495	8001224400	1930825	8001222900	1909957	8001128800	70264740	8001226900	73044713	8001224300
FLI6496	8001224500	4290940	8001605000	1909964	8001131600	70266787	8001224400	73045860	8001225100
FLI6503	8001224800	4971958	8001220300	1930174	8001134300	70267075	8001224400	73047497	8001225100
FLI6507	8001298000	4975549	8001220300	1930604	8001415400	70267931	8001131700	73050258	8001138900
FLI6510	8001225100	8322160	8001220300	1930726	8001226500	70267953	8001226500	73051818	8001225100
FLI6515	8001139100	8822160	8001220300	1930728	8001131500	70267962	8001131700	73067507	8001128800
FLI6516	8001225400	71405431	8001483500	1930729	8001129500	70440155	8001129500	73067508	8001131600
FLI6523	8001125200	71406283	8001222900	1930747	8001224500	70440158	8001131500	73119795	8001128800
FLI6524	8001249100	71416994	8001239500	1930751	8001130800	70648734	8001224500	74021443	8001224300
FLI6525	8001248500	71467030	8001445500	1930765	8001193500	70654409	8001130800	74055745	8001134800
FLI6528	8001351000	71467031	8001239500	1930787	8001438600	70659387	8001225300	74146001	8001134800
FLI6529	8001352000	76040385	8001225400	1930790	8001239500	70659533	8001224500	74371576	8001134800
FLI6546	8001222800	76547841	8001605000	1930795	8001131600	70660360	8001138900	74789056	8001110600
FLI6579	8001121100	76568665	8001273900	1930826	8001445500	70662477	8001225400	74841879	8001110600
FLI6588	8001226500	76579880	8001277000	2097035	8001110600	70662608	8001131700	74861641	8001224300
FLI6593	8001226900	76585406	8001167500	4021443	8001224300	70662609	8001139100	74907794	8001110600
FLI6599	8001227300	86512355	8001222900	4788592	8001238700	70666432	8001130800	74909733	8001224300
FLI6600	8001227400	86512356	8001222800	4789056	8001110600	70667685	8001227400	74980649	8001223500
FLI6604	8001433400	131063680	8001438800	4841879	8001110600	70667686	8001227300	74996253	8001110600
FLI6613	8001227600	151849148	8001736500	4861641	8001224300	70667690	8001227300	75247062	8001238500
FLI6619	8001227800	151849149	8001441300	4907794	8001110600	70674967	8001227300	75247063	8001353100
FLI6620	8001193500	151849501	8001125500	4909733	8001224300	70684732	8001130800	75248729	8001224200
FLI6622	8001131700	151849502	8001126900	6626089	8001131700	70684733	8001138900	76626089	8001131700
FLI6624	8001228300	FIAT-ALLIS		6626097	8001139100	70684734	8001224500	76626097	8001139100
FLI6627	8001228500	239513	8001110600	7066432	8001131700	71005365	8001224300	76676852	8001227400
FLI6689	8001410400	244570	8001139100	7304497	8001225100	71007973	8001128800	77021413	8001225100
FLI6781	8001178900	250699	8001110600	8011014	8001224300	71007974	8001131600	77306750	8001128800
FLI6788	8001352900	256983	8001128800	8015977	8001335700	71010407	8001128800	77659533	8001224500
FLI6789	8001352700	267931	8001131700	8016976	8001335600	71014652	8001146700	77662477	8001225400
FLI6794	8001134300	267962	8001131700	8322986	8001227800	71140887	8001224300	77722126	8001138900
FLI6799	8001648700	684732	8001130800	9083212	8001128800	71140889	8001110600	77825060	8001224400
FLI6801	8001353100	1004421	8001224300	9292365	8001239700	71181296	8001226500	77980508	8001227600
FLI6818	8001282500	1005365	8001224300	9927506	8001228400	71183993	8001131700	78041782	8001224500

MFRS Cod.	VIRGIS Cod.	MFRS Cod.	VIRGIS Cod.	MFRS Cod.	VIRGIS Cod.	MFRS Cod.	VIRGIS Cod.	MFRS Cod.	VIRGIS Cod.
78332987	8001227300	70660360/9	8001138900	A2412	8001130800	017027000	8001348900	FAC999	8001139100
78721029	8001225400	70662689/9	8001131700	A2426	8001139100	FINN		LI2616	8001134800
78721219	8001226500	70684732/1	8001130800	A2427	8001238600	FFA10883	8001238500	LI2695	8001134800
78722126	8001138900	AX64724	8001110600	A2428	8001224800	FFA741	8001134800	FLEETGUARD	
79011386	8001128800	F09917881	8001225100	A2430	8001227400	FFA745	8001266000	AF55894	8601884800
79011387	8001131600	FIATAGRI		A2431	8001227300	FFA746	8001282600	AA2983	8601855800
79022025	8001105600	1930174	8001134300	A2432	8001222500	FFA788	8001687300	AA2984	8601858700
79022026	8001222600	1930349	8001438000	A2434	8001224200	FFA792A	8001225300	AF-4067	8001223000
79042203	8001226500	1930536	8001307500	A2437	8001266000	FFA792B	8001225200	AF-4568	8001224100
79043778	8001138900	1930587	8001486500	A2438	8001282600	FFA795	8001138900	AF-4744	8001218100
79043779	8001139100	1930588	8001427000	A2442	8001223500	FFA799	8001224500	AF1604	8001723200
79043780	8001224500	1930589	8001736500	A2464	8001131500	FFA803	8001221400	AF1605M	8001723000
79043781	8001225400	1930590	8001441300	A2465	8001128800	FFA805	8001298000	AF1606K	8001473300
79049790	8001131500	1930591	8001440900	A2466	8001131600	FFA827	8001223500	AF1606KM	8001473300
79049791	8001129500	1930592	8001440200	A2467	8001223100	FFA833	8001238500	AF1614	8001275200
79062700	8001204800	1930746	8001139100	A2477	8001167500	FFA835	8001223800	AF1658K	8001167500
79067204	8001193500	1930748	8001225400	A2480	8001687300	FFA842	8001223400	AF1733K	8001128800
79072797	8001193500	1930752	8001131700	A2485	8001228500	FFA895	8001225100	AF1735K	8001224400
79081327	8001105600	1930784	8001279800	A2498	8001222100	FFA897	8001266000	AF1782	8001278100
79081328	8001222600	1930786	8001279000	A2513AL	8001224400	FFA898	8001228300	AF1798	8001223400
79083212	8001128800	1930787	8001438600	A2527	8001265300	FFA937	8001224200	AF1801	8001298000
79083213	8001131600	1930825	8001222900	FILTER MEX		FFA944	8001315600	AF1802	8001227800
79292365	8001239700	71415282	8001445500	FMA1532K	8001473300	FFA955	8001121100	AF1804	8001223800
79917419	8001225100	FIELD QUEEN		FMA1544S	8001131600	FISPA		AF1823K	8001146700
79917881	8001225100	72056	72056	FMA1570	8001707000	FAC508	8001134800	AF1824	8001341000
79921320	8001138900	73430	73430	FMA1570S	8001707500	FAC677	8001220200	AF1830KM	8001105600
79923130	8001138900	73431	73431	FMA2	8601567700	FAC681	8001105600	AF1835	8001286700
79933225	8001222800	FILGA		FMA226	8001221400	FAC682	8001131600	AF1839	8001222600
79933226	8001222900	FFA900	8001224800	FMA253	8001103800	FAC683	8001128800	AF1840	8001353100
79933276	8001224500	FFA901	8001238600	FMA256K	8001110600	FAC800	8001222900	AF1841	8001352700
79935594	8001224400	FFA905	8001239700	FMA258K	8001100300	FAC801	8001222800	AF1842	8001353000
79955749	8001222600	FILT		FMA258SY	8001111000	FAC804	8001129500	AF1843	8001352900
79955976	8001105600	A2009	8001134800	FMA4N0015	8601409000	FAC805	8001131500	AF1859	8001125200
79957810	8001222600	A2219	8001283900	FMA502	8001225300	FAC972	8001280900	AF1869	8601409000
79957811	8001105600	A2222	8001315700	FMA502SY	8001225200	FAC974	8001238600	AF1904M	8001225400
79957888	8001131700	A2234	8001315000	FMA507	8001224500	FAC975	8001238500	AF1905M	8001224500
79957889	8001138900	A2276	8001209100	FMA523	8001138900	FAC980	8001223500	AF1929	8001227600
80110141	8001224300	A2289	8001110600	FMA523SY	8001139100	FAC981	8001224200	AF1945	8001285700
92313000	8001227300	A2289AL	8001110600	FMA535	8001227300	FAC982	8001223100	AF1960	8001351000
300138019	8001279800	A2312	8001225100	FMA535SY	8001227400	FAC984	8001230200	AF1961	8001352000
700052302	8001279400	A2336	8001221400	FMA546	8001130800	FAC985	8001224800	AF1962	8001260400
700053475	8001204800	A2338	8001315600	FMA546SY	8001131700	FAC986	8001352700	AF1963	8001260500
700055856	8001234500	A2359	8001224500	FMA563	8001226900	FAC988	8001224500	AF1966	8001434300
801101411	8001224300	A2369	8001138900	FINI		FAC989	8001223500	AF1980	8001111000
920007502	8001111700	A2402	8001238500	017023000	8001100300	FAC990	8001110600	AF25000	8001309000
920015933	8001193500	A2407	8001225400	017025000	8001121000	FAC993	8001225400	AF25002M	8001307500
684732/1	8001130800	A2411	8001138900	017026000	8001253200	FAC996	8001121100	AF25006K	8001382400

MFRS Cod.	VIRGIS Cod.	MFRS Cod.	VIRGIS Cod.	MFRS Cod.	VIRGIS Cod.	MFRS Cod.	VIRGIS Cod.	MFRS Cod.	VIRGIS Cod.
AF25029	8001438000	AF25477	8001878200	AF25770	8001697200	AF4135	8001223100	AF4856M	8001194200
AF25057	8001134300	AF25484	8001427000	AF25773GK	8601501500	AF4137	8001209100	AF4867	8001250700
AF25060KM	8001347300	AF25485	8001441300	AF25794	8001470800	AF4150	8001226500	AF4872	8001284700
AF25061	8001319000	AF25490	8001688000	AF25795	8001470300	AF4164K	8001222800	AF4890	8001318500
AF25064	8001238500	AF25491	8001538000	AF25799	8601491000	AF4165	8001222900	AF4891M	8001307400
AF25065	8001224200	AF25492	8001692800	AF25825	8601547000	AF418	8001138900	AF4892K	8001327000
AF25066	8001238700	AF25497	8001605400	AF25841	8601567100	AF418M	8001138900	AF4893M	8001279000
AF25084	8001693800	AF25499	8001709200	AF25849	8601589100	AF421M	8001227300	AF4894KM	8001445500
AF25200K	8001273900	AF25500K	8001421100	AF25855	8601585700	AF424	8001224500	AF4901	8001340400
AF25230	8001747000	AF25502K	8001229000	AF25957	8001672900	AF424M	8001224500	AF4905M	8001279800
AF25249M	8001530000	AF25503	8001411300	AF25964	8001537100	AF427M	8001226900	AF4909K	8001381100
AF25250	8001388900	AF25523	8001629000	AF25978	8001482900	AF434KM	8001130800	AF490M	8001139100
AF25251	8001393900	AF25526	8001407400	AF26119	8601618500	AF435KM	8001110600	AF4915	8601569000
AF25260	8001438700	AF25529	8001478700	AF26226	8601835300	AF437KM	8001103800	AF4916	8601569300
AF25264	8001490000	AF25538	8001441200	AF26230	8001628400	AF4500	8001248500	AF4917	8001178900
AF25290	8001440900	AF25539	8001440900	AF26348	8001688800	AF4501	8001249100	AF4920	8001376300
AF25291	8001486500	AF25551	8001588700	AF26387	8001687800	AF4503	8001227800	AF4927	8001529400
AF25292	8001736500	AF25555	8001749000	AF26403	8001754100	AF4510	8001110900	AF4939	8001271600
AF25302	8001472200	AF25558	8001736600	AF26419	8001754200	AF4521	8001648800	AF4941	8001224300
AF25303	8001471500	AF25565	8001649000	AF26439	8001720300	AF4522	8001648700	AF4968	8001410700
AF25305	8601544100	AF25566	8001649400	AF26455	8001737200	AF4523	8001352800	AF4972	8001282500
AF25306	8601569900	AF25574	8601570100	AF27843	8001759400	AF4525	8001295300	AF4980KM	8001234500
AF25308	8001878000	AF25575	8001588700	AF27854	8601764400	AF4551	8001222500	AF4981M	8001279400
AF25313	8001490200	AF25589	8001878300	AF27866	8601784400	AF4565	8001250000	AF4991	8001277500
AF25314	8001489600	AF25618	8001673100	AF27869	8001776200	AF4566	8001227900	AF55737	8601817300
AF25315K	8001415400	AF25619	8001652100	AF27945	8601802600	AF4569	8001249800	AF55739	8601820300
AF25319	8601570000	AF25622	8001652200	AF27960	8601817400	AF4570K	8001194100	AF55740	8601823500
AF25321	8001418300	AF25627	8001692200	AF27963	8601855900	AF4573K	8001878100	AF55741	8601856300
AF25326	8001568100	AF25702	8001525500	AF335M	8001221400	AF4589	8001239500	AF55766	8601701400
AF25331	8001423700	AF25703K	8001526700	AF338	8001315600	AF4609	8001240300	AF55774	8601847400
AF25333	8001652300	AF25715RH	8001541100	AF340	8001315000	AF4641M	8001121100	AF55776	8601856800
AF25335	8001567300	AF25716RH	8001540000	AF343	8001315700	AF4644	8001230200	AF55778	8601866600
AF25337M	8001547500	AF25721	8001649100	AF353K	8001225100	AF4654	8001204800	AF55792	8601864900
AF25343	8001433400	AF25722	8001649500	AF4024	8001217700	AF4655KM	8001188000	AF55793	8601864800
AF25344	8001434000	AF25723	8001649200	AF4039	8001266000	AF4657	8001556500	AF55822	8601945900
AF25348K	8001483500	AF25724	8001649600	AF4049	8601568000	AF4658	8001560400	AF5586200JX	8601753400
AF25351	8001287000	AF25726	8001687700	AF4057	8001224800	AF4663	8601568800	AF56006	8601885000
AF25352	8001441000	AF25727	8001648900	AF4058	8001238600	AF4691	8001280900	AF56046	8601929000
AF25353	8001364400	AF25728	8001649300	AF4059K	8001128800	AF4714	8001209300	AF804M	8001131700
AF25414	8001881200	AF25729	8001688100	AF4060	8001223500	AF471M	8001225200	AF818K	8001222100
AF25424	8001687900	AF25730	8001687500	AF4064	8001265300	AF4720	8001228300	AF819KM	8001220200
AF25434	8001440200	AF25741	8001268900	AF4066	8001239700	AF472M	8001225300	AF820M	8001225400
AF25436	8001605000	AF25753	8001555700	AF4085	8001134800	AF4745	8001687600	AF821M	8001227400
AF25437	8001668900	AF25756	8001488800	AF409KM	8001100300	AF4748K	8001193500	AF830	8001410400
AF25454	8001629400	AF25767	8001696900	AF4103	8001131600	AF4758KM	8001277000	AF880	8001707500
AF25457	8001710300	AF25768	8001697000	AF4106	8001283900	AF4841	8001530400	AF889	8001335700
AF25468	8001630100	AF25769	8001697100	AF4128	8601567700	AF4850	8001498000	AF899M	8001707000

MFRS Cod.	VIRGIS Cod.	MFRS Cod.	VIRGIS Cod.	MFRS Cod.	VIRGIS Cod.	MFRS Cod.	VIRGIS Cod.	MFRS Cod.	VIRGIS Cod.
AF901	8001335600	173837	8001225100	A830X9601ALA	8001225100	5011304	8001223100	CA234	8001315000
AF940K	8001129500	197362	8001146700	A830X9601AMA	8001687300	5011310	8001110600	CA236	8001315600
AF959	8001314100	198492	8001110600	A830X9601ANA	8001223500	5011316	8001128800	CA237	8001315700
AF969	8001282600	217490	8001110600	A830X9601ARA	8001223800	5011317	8001298000	CA2521SY	8001222600
AF970	8001687300	221406	8001146700	A830X9601ASA	8001266000	5011318	8001238600	CA2523SY	8001226500
AF988	8001131500	221407	8001146700	A830X9601BDA	8001224500	5011319	8001224400	CA2524	8001105600
AF990	8001228500	221409	8001473300	A830X9601BEA	8001227800	5011321	8001238500	CA2557SY	8001434300
AF991	8001222500	221688	8001146700	A830X9601BFA	8001228300	5011325	8001224200	CA256	8001110600
AF996M	8001102000	222531	8001225100	A830X9601BGA	8001121100	5011326	8001224800	CA258SY	8001111000
AH1107	9351732900.	227456	8001138900	A830X9601BKA	8601568000	5011327	8001225100	CA2595	8001723000
AH1136	9351655000.	227671	8001139100	A830X9601BSA	8001223100	5011328	8001687300	CA2611	8001217700
AH1141	9351656000.	249571	8001130800	A830X9601BUA	8001128800	5011329	8001223500	CA266SY	8001314100
AH1190	9351733100.	249572	8001131700	A830X9601CAA	8001298000	5011330	8001223800	CA3105SY	8001648800
AH1196	9351733500.	254521	8001110600	A830X9601CCA	8001238500	5011331	8001266000	CA3194	8001227800
AH1198	9351733300.	272744	8001341000	A830X9601CGA	8001224200	5011337	8001224500	CA3227	8001266000
AH19002	9351686200.	276766	8001224500	A830X9601CHA	8001224800	5011338	8001227800	CA3227A	8001266000
AH19003	9351685900.	276767	8001225400	A830X9601CJA	8001225100	5011339	8001228300	CA3249	8001209100
AH19004	9351686400.	373376	8001128800	A830X9601CKA	8001687300	5011340	8001121100	CA3262	8001130800
AH19037	9351614100.	375272	8001226500	A830X9601CLA	8001223500	5011343	8601568000	CA3276	8001224200
AH19220	9351733600.	375273	8001224400	A830X9601LA	8001110600	5011545	8001110600	CA3276SY	8001352700
AH8513	9351575100.	376826	8001131600	A830X9601SA	8001223100	5011547	8001223100	CA3277	8001224800
FS19605	8601680000	377055	8001129500	A830X9601UA	8001128800	5011549	8001128800	CA3280	8001223500
FS19615	8601566000	377059	8001131500	C6JZ9600B	8001224300	5011550	8001298000	CA3280SY	8001352900
FS19733	8601680500	452529	8001279400	C7JZ9600C	8001224300	5011552	8001238500	CA3281	8001238500
FS19752	8601680300	516716	8001224300	C7TA9600G	8001130800	5011556	8001224200	CA3281SY	8001353100
FS19803	8601673800	616520	8001110600	C8TZ9601C	8001130800	5011557	8001224800	CA3283	8001265300
FLEETRITE		616720	8001110600	D0HZ9601G	8001224500	5011558	8001225100	CA3290A	8001223500
AFR8435KM	8001110600	8256032	8001110600	D0JJ9600B	8001224300	5011559	8001687300	CA3291SY	8001353100
FLUXFILTER		8257914	8001110600	D2JL9600B	8001130800	5011560	8001223500	CA3295	8001223100
AC226	8001221400	86509128	8001223500	D2JL9600B1	8001131700	6089378	8001138900	CA3295SY	8001648700
AC236	8001315600	86509129	8001352900	E9NN9B618BA	8001472200	18630081	8001472200	CA3307	8001284700
AC237	8001315700	86512886	8001167500	E9NN9R500AB	8001471500	18695551	8001471500	CA3907	8001295300
AC266SY	8001314100	200E6228	8001110600	F4BZ7A098A	8001139100	FRAM		CA4202	8001238600
AC535	8001227300	6F2647B	8001131600	SBA314530360	8001167500	C2595SY	8001723200	CA4202SY	8001353000
FODEN		81DB9601BA	8001138900	SBA314531072	8001110600	C7178	8001224200	CA4205	8001223400
42391/1	8001138900	A700X9601AHA	8001134800	X13692	8001225100	CA1507SY	8001707500	CA4208	8001223800
Y02520504	8001138900	A760X9601CA	8001134800	FORD FINISCODE		CA1531SY	8001341000	CA4210	8001298000
Y03547112	8001224500	A780X9601AFA	8001138900	1499359	8001134800	CA1543SY	8001131500	CA4214	8001282600
Y05753412	8001138900	A780X9601CA	8001239700	1863008	8001472200	CA1544SY	8001131600	CA4215	8001227800
Y05753510	8001224500	A780XX9601AFA	8001138900	1866308	8001472200	CA1569	8001335600	CA4216	8001222500
Y05754209	8001225300	A800X9601HA	8001134800	1869555	8001471500	CA1569SY	8001335700	CA4219	8001228500
FORD		A830X9601AAA	8001298000	2003726	8001472200	CA1570	8001707000	CA4276	8001227600
129040	8001224300	A830X9601ABA	8001238600	2003739	8001471500	CA1570SY	8001707500	CA4277	8001228300
138169	8001225100	A830X9601ACA	8001224400	5002462	8001134800	CA1589	8001222600	CA4278	8001121100
138641	8001224300	A830X9601AEA	8001238500	5004264	8001239700	CA163PL	8601409000	CA4300	8001239700
143644	8001225100	A830X9601AJA	8001224200	5004772	8001138900	CA226	8001221400	CA4584	8001280900
164090	8001110600	A830X9601AKA	8001224800	5006576	8001134800	CA226SY	8001314100	CA4666	8001410700

MFRS Cod.	VIRGIS Cod.	MFRS Cod.	VIRGIS Cod.	MFRS Cod.	VIRGIS Cod.	MFRS Cod.	VIRGIS Cod.	MFRS Cod.	VIRGIS Cod.
CA4684SY	8001352900	CA7178	8001223400	CAK7109	8001194100	2010260	8001138900	AH/1022	8001228300
CA4685SY	8001352700	CA7178	8001224200	CAK7324	8001277000	2010262	8001224500	AH/1023	8001121100
CA4686	8001298000	CA7201	8001260400	CAK7468	8001129500	2010508	8001138900	AH/1026	8001139100
CA4771	8001278100	CA7201SY	8001260500	CAK7687	8001222800	2010509	8001224500	AH/1027	8001228500
CA4772SY	8001286700	CA7211SY	8001352700	CAK7702	8001188000	2010697	8001225400	AH/1029	8001223400
CA4812	8001433400	CA7242	8001239700	P29748	8001138900	2010698	8001225200	AH/1030	8001223800
CA4838	8001223500	CA7244	8001223100	P31488	8001223500	2010699	8001139100	AH/1040	8001221400
CA4893	8001238700	CA7458	8001209100	PA2	8601567700	2109069	8001128800	AH/1043	8001315700
CA4919	8001285700	CA7458SY	8001687900	PA2571	8601409000	GEHL		AH/1044	8001315600
CA4942	8001121100	CA7459	8001222500	PA2713	8601568000	55017	8001110600	AH/1047	8001224800
CA4948	8001228300	CA7467	8001227600	FRANKLIN		56014	8001110600	AH/1053	8001131600
CA4962	8001223100	CA7470SY	8001204800	1501725	8001225100	63733	8001167500	AH/1054	8001129500
CA5022	8001238600	CA7490	8001240300	10501684	8001100300	87860	8001473300	AH/1056	8001227800
CA5026SY	8001146700	CA7670	8001472200	FRIGIKING		92397	8001146700	AH/1071	8001227800
CA507	8001224500	CA7670SY	8001471500	941078	8001167500	92398	8001341000	AH/1081	8001110600
CA507SY	8001225400	CA7687SY	8001222900	FUCHS		131852	8001100300	AH/1091	8001131500
CA5155	8001228300	CA7690	8001194200	00073052	8001238500	131853	8001111000	AH/1093	8001227600
CA5176	8001249800	CA7691	8001228500	FURUKAWA		600023	8001225100	AH/1096	8001131700
CA5222	8001178900	CA7709	8001423700	50103065	8001110600	GENERAL ELECTRIC		AH/1109	8001239700
CA523	8001138900	CA7712	8001298000	340106012	8001128800	0DA551/4	8001217700	AH30	8001134800
CA5232	8001134300	CA7712SY	8001353000	510106023	8001131700	0L551E/4	8001138900	GMC	
CA523SY	8001139100	CAK1531	8001146700	510106024	8001130800	0L551M/4	8001225100	675911	8001224500
CA5321SY	8001352800	CAK1532	8001473300	520106004	8001138900	0L551N/4	8001224500	700016	8001225300
CA535	8001227300	CAK1544	8001128800	520106013	8001139100	DA551/4	8001217700	1553966	8601409000
CA535SY	8001227400	CAK1563	8001110600	38802111210	8001668900	L551E/4	8001138900	5141521	8001224300
CA5364	8001376300	CAK2521	8001105600	38802111220	8001629000	L551M/4	8001225100	6421540	8001221400
CA5368	8001282500	CAK2523	8001224400	627975C2	8001335600	L551N/4	8001224500	6423137	8001315600
CA541	8001240300	CAK255	8001225100	GALION		GETMAN		6424409	8001315700
CA5435	8601569000	CAK256	8001110600	625	8001131700	284054	8001128800	6424410	8001315000
CA5453	8001318500	CAK3272	8001129500	D103258	8001224500	284055	8001131600	6424687	8001225100
CA5455SY	8001478700	CAK352	8001167500	D103259	8001225400	604948	8001225400	6424688	8001110600
CA5465SY	8001131700	CAK3819	8001130800	D106576	8001130800	604950	8001224500	6486931	8001138900
CA5521	8001295300	CAK4361	8001222800	D114359	8001224300	GIESSE		6486941	8001227300
CA559	8001224500	CAK4414	8001224400	D115548	8001167500	AH/1001	8001225400	6487013	8001227400
CA563	8001226900	CAK4817	8001193500	D119394	8001110600	AH/1003	8001225100	6487036	8001224500
CA586	8001410400	CAK5050S	8001224300	D79041	8001225100	AH/1004	8001223100	6487136	8001225400
CA5872	8001668900	CAK5052S	8001110600	D99737	8001138900	AH/1006	8001138900	6487244	8001226900
CA6317	8001223400	CAK510	8001222100	D99739	8001139100	AH/1007	8001222500	6487434	8001220200
CA663PL	8001134800	CAK530	8001167500	H99737	8001138900	AH/1008	8001209100	6487468	8001139100
CA6666	8001410700	CAK546	8001130800	GARDNER-DENVER		AH/1009	8001223500	6487754	8001130800
CA667PL	8001283900	CAK5520	8001483500	150726	8001226900	AH/1010	8001238500	6487756	8001131700
CA681PL	8001295300	CAK553	8001220200	156292	8001227400	AH/1012	8001266000	6488182	8001410400
CA6916SY	8001222900	CAK5568	8001445500	156296	8001227400	AH/1014	8001687300	6488342	8001167500
CA6918	8001102000	CAK565	8001128800	156297	8001227300	AH/1015	8001224500	6488346	8001128800
CA7088	8001271600	CAK565A	8001128800	172994	8001227300	AH/1017	8001224200	7980474	8601568000
CA7111	8001238600	CAK6916	8001222800	2009590	8601567700	AH/1018	8001128800	7980585	8601568000
CA7137SY	8001239500	CAK7082	8001327000	2010137	8001225100	AH/1019	8001238600	7987957	8001138900

MFRS Cod.	VIRGIS Cod.	MFRS Cod.	VIRGIS Cod.	MFRS Cod.	VIRGIS Cod.	MFRS Cod.	VIRGIS Cod.	MFRS Cod.	VIRGIS Cod.
8994210	8001222100	25041957	8001238500	GA1286M	8001315600	F277F502	8001110600	8001110600	8001130800
8994494	8001473300	25042135	8601567700	GA1287	8001315600	L176	8001110600	8001110600	8001146700
8994516	8001335600	25042136	8601567700	GA1287M	8001315000	L177	8001110600	8001225100	8001224500
8994518	8001335700	25095197	8001223400	GA206	8001225400	LO177	8001110600	8001138900	8001224500
8994522	8001128800	25096141	8001227800	GA206M	8001225400	TD427F43	8001224300	8001265300	8001138900
8994524	8001131600	25096178	8001222500	GA2286	8001314100	GREGOIRE		8001128800	8001224500
8994542	8001284700	25096184	8001102000	GA24M	8001225100	170044	8001193500	8001128800	8001225300
8994564	8001146700	25096188	8001121100	GA262	8001227400	170046	8001222500	8001224500	8001225300
8994587	8001222600	25096234	8001224800	GA2798M	8001224200	GREYFRIARS		8001223500	8001139100
8994589	8001105600	25096238	8001223500	GA326	8001224500	127A	8001217700	8001224800	8001225400
8994635	8001131500	25096242	8001265300	GA326M	8001224500	1345A	8001478700	8001238600	8001473300
8994637	8001129500	25096250	8001224200	GA33	8001110600	170A	8001134800	8001224200	8001131600
8994643	8001128800	25096276	8001222800	GA33M	8001110600	205A	8001282600	8001238500	8001146700
8994649	8001314100	25096324	8001286700	GA360	8001138900	216A	8601568000	8001266000	8001131700
8994728	8001100300	25096432	8601409000	GA360M	8001138900	235A	8001110600	8001121100	8001167500
8994729	8001224300	91008551	8001224500	GA361	8001139100	235AF	8001110600	8001110900	8001225300
8994732	8001138900	91021394	8001225300	GA405	8001223500	238AF	8001225100	8001278100	8001223500
8994736	8001227300	91107151	8001285700	GA416	8001105600	239A	8001138900	8001131600	8001224500
8994737	8001227300	93152016	8001222500	GA461	8001260500	246A	8001265300	8001223100	8001225400
8994740	8001224500	93152017	8001228500	GA569	8001707000	247A	8001128800	8001130800	8001352700
8994742	8001226900	93152088	8001131600	GA569M	8001707000	247AF	8001128800	8001130800	8001224200
8994743	8001226900	93152216	8001209100	GA570M	8001707500	251A	8001224500	8001285700	8001167500
8994744	8001130800	93152236	8001282600	GA892	8001131500	259A	8001223500	8001286700	8001209100
8994745	8001130800	93152421	8001121100	GA9334	8001221400	261A	8001224800	8001353100	8001138900
8994746	8001110600	GOLDEN FILTER		GA9334M	8001221400	272A	8001238600	8001352700	8001139100
8994747	8001110600	AF109	8001240300	GA98M	8001222100	287A	8001224200	8001167500	8001224400
8994750	8001103800	AF859	8001110900	GAK1532	8001473300	288A	8001238500	8001167500	8001225200
8994764	8001139100	GOLDEN SUPER		GAK216	8001105600	291A	8001266000	GUARDIAN	
8994765	8001139100	1031PL	8001224300	GAK24	8001225100	299A	8001121100	G101222	8001103800
8994766	8001131700	GOLDONI		GAK625	8001224400	310A	8001110900	G101237	8001225100
8994767	8001131700	27516	8001213500	GAK98	8001222100	321A	8001278100	G101275	8001110600
8994768	8001220200	6340310	8001110600	GAK98M	8001222100	327A	8001131600	G102745	8001167500
8994770	8001225400	6340317	8001110800	GAP379	8601567700	328A	8001223100	G103951	8601567700
8994772	8001227400	6340328	8001100300	GAP379M	8601567700	329A	8001130800	G106587	8001138900
8994937	8001217700	6340366	8001199800	GAP381	8601409000	329AF	8001130800	G106632	8001225300
8994979	8001239500	6340421	8001210600	GPC		339A	8001285700	G106769	8001224500
8994985	8001131500	00064789	8601872400	FC106	8001238500	344A	8001286700	G106775	8001225400
9030894	8001225100	L000938	8601887900	FC217	8001223500	349A	8001353100	G106834	8001139100
9038407	8001226900	GONHER		FC252	8001224200	350A	8001352700	G108668	8001130800
9038898	8001225100	G1285M	8001315700	FC538	8001376300	351A	8001167500	G108674	8001131700
9038899	8001227300	GA106	8001224500	FC818	8001668900	351AF	8001167500	G108736	8001220200
9049489	8001227400	GA106M	8001224500	FC832	8001692800	GROVE		G109085	8001227400
9391461	8001224500	GA118	8001220200	FC833	8001538000	8001217700	8001222500	G109086	8001227300
9974646	8001130800	GA118M	8001223100	FC843	8001629400	8001478700	8001138900	G109200	8001226900
9974648	8001131700	GA1285	8001315700	FC844	8001630100	8001134800	8601568000	G113343	8001239500
9974649	8001224400	GA1285M	8001315700	GRAY MARINE		8001282600	8001222500	G114500	8001131500
25041956	8001238500	GA1286	8001315600	F227F50	8001110600	8601568000	8001128800	G114747	8001222100

MFRS Cod.	VIRGIS Cod.	MFRS Cod.	VIRGIS Cod.	MFRS Cod.	VIRGIS Cod.	MFRS Cod.	VIRGIS Cod.	MFRS Cod.	VIRGIS Cod.
G117781	8001707500	76.50.092	8601567700	ADG808	8001238600	278947	8001298000	AF2168	8001194100
G117782	8001707000	GUD		AG139	8001134800	353264	8001209100	AF217	8001138900
G118211	8001335600	ADG458	8001209100	AG140A	8001217700	2241329	8001353100	AF2170	8001228300
G118216	8001335700	ADG478	8001227400	AG142	8001283900	HANOMAG-HENSCHEL		AF218	8001224500
G119135	8001129500	ADG479	8001227300	AG385	8001266000	197946146	8001225100	AF2187	8001222900
G119136	8001128800	ADG492	8001226900	AG417	8001282600	197946184	8001139100	AF219	8001225400
G119363	8001128800	ADG494	8001138900	AG445	8001266000	197946185	8001138900	AF2234	8001248500
G119410	8001131600	ADG508	8001222500	AG524	8001224500	197946201	8001687300	AF2235	8001249100
G119538	8001473300	ADG516	8001238500	GUIOT		4916566M1	8001427000	AF2241	8001227800
G119649	8001222600	ADG518	8001222100	G.507	8001224500	4916567M1	8001407400	AF2262	8001472200
G119778	8001226500	ADG519	8001128800	GA1050	8001224800	HARMO		AF235K	8001128800
G120022	8001224400	ADG524	8001224500	GA1065	8001266000	A2067	8001134800	AF245K	8001130800
G120281	8001146700	ADG525	8001225400	GA1066	8001238600	A2085	8001238500	AF246	8001131700
G120307	8001341000	ADG533	8001139100	GA1067	8001238500	A618	8001283900	AF284	8001227400
G122492	8001224300	ADG534	8001128800	GA1068	8001224800	A626	8001217700	AF300	8001410400
G122510	8001110600	ADG535	8001131600	GA1070	8001223500	A634	8001134800	AF319	8001284700
G123160	8001434300	ADG537	8001130800	GA1087	8001687300	A703	8601568000	AF324K	8001220200
G124164	8001222800	ADG538	8001131700	GA255	8001225100	A720	8001138900	AF327	8001226900
G124526	8001131700	ADG543	8001110600	GA256	8001110600	A721	8001266000	AF336	8601567700
G127532	8001227600	ADG563	8001225100	GA523	8001138900	A744	8001224300	AF363K	8001105600
G127787	8001222900	ADG577	8001223100	GA663	8001134800	CUA618	8001283900	AF365	8001222600
G128407	8001723000	ADG586	8001129500	GULDNER		CUA755	8001130800	AF370	8001335600
G128408	8001723200	ADG587	8001131500	9831604	8001238500	CUA788	8001225100	AF371	8001335700
G130761	8001105600	ADG603A	8001238600	9839010	8001295300	P101	8601567700	AF458	8001131500
G130771	8001410400	ADG619	8001224400	9839012	8001239700	HART-CARTER		AF463	8001130800
G131333	8001227300	ADG620	8001226500	9839014	8001223100	257045	8001224300	AF465	8001227400
G131394	8001111000	ADG625	8001105600	9839015	8001238600	HASTINGS		AF477	8001128800
G151276	8001353000	ADG626	8001222600	9839016	8001648800	AF105	8001315700	AF478	8001131600
G171340	8001209100	ADG631	8001353000	9839017	8001648700	AF108	8001221400	AF480	8001129500
G172250	8001298000	ADG644	8001315700	9839019	8001228500	AF116	8001315600	AF481	8001128800
G172253	8001238600	ADG649	8001221400	9839020	8001353100	AF117	8001315000	AF496	8001314100
G172500	8001222500	ADG650	8001315600	9839331	8001110600	AF133K	8001110600	AF498	8001473300
G234401	8001224200	ADG652	8001315000	GURIA		AF153K	8001222100	AF514	8001224400
G234402	8001224800	ADG654	8001315700	145315	8001279800	AF167K	8001167500	AF515	8001226500
G235000	8001223400	ADG674	8001224200	145317	8001239500	AF20	8601409000	AF576	8001707000
G235001	8001224200	ADG694	8001224500	HAGIE		AF2007	8001240300	AF577	8001707500
G246501	8001223500	ADG695	8001222100	29294	8001224300	AF2016	8001223100	AF588	8001146700
G247001	8001223800	ADG699	8001434300	319700P01	8001110600	AF2058	8001239700	AF597	8001286700
G251285	8001315700	ADG708	8001222900	319700PO	8001110600	AF2068	8001224200	AF631	8001434300
G251286	8001315600	ADG709	8001222800	319709P01	8001110600	AF2082	8001102000	AF635	8001238500
G251287	8001315000	ADG752	8001285700	HAKO		AF2092	8001223500	AF637	8001222500
G431600	8001102000	ADG761	8001223100	9933006	8001239700	AF2095	8001228500	AF638	8001209100
G4M9334	8001221400	ADG766	8001648700	HALLA		AF2153	8001315700	AF639	8001238600
G4N0015	8601409000	ADG779	8001249100	79103228	8001138900	AF2154	8001315600	AF643	8001227600
G803915	8001224500	ADG780	8001248500	439203768	8001138900	AF2158	8001223400	AF644	8001131700
G9S9972	8001314100	ADG792	8001353100	1904550L	8001227800	AF216	8001139100	AF648	8001217700
GUASCOR		ADG794	8001227800	HAMM		AF2166	8001224800	AF658	8001723000

MFRS Cod.	VIRGIS Cod.	MFRS Cod.	VIRGIS Cod.	MFRS Cod.	VIRGIS Cod.	MFRS Cod.	VIRGIS Cod.	MFRS Cod.	VIRGIS Cod.
AF659	8001723200	HDA1399	8001225200	HDA9410	8001131600	708722126	8001138900	D911519	8001138900
AF661	8001341000	HDA2745	8001167500	HDA9538	8001473300	708722134	8001139100	D911762	8001225100
AF673	8601409000	HDA3149	8001225300	HDA9576	8001227300	HINO		D914453	8001139100
AF744	8001239500	HDA3152	8001225200	HDA9778	8001226500	178011090	8001225400	LH42924001	8001103800
AF762	8001224500	HDA3160	8001434300	HDA9972	8001314100	178011110	8001224500	X4326841	8001605400
AF97K	8001225100	HDA3179	8001227300	HDA99721	8001314100	178011180	8001139100	HOBART	
FAF108	8001221400	HDA4500	8001131500	HEDEN		178011190	8001138900	403997	8001224300
FAF133K	8001110600	HDA4526	8001131700	29800164	8001382400	178012020	8001227300	HOKUETSU KOGYO	
FAF245K	8001130800	HDA4714	8601567700	59501503	8001130800	178012260	8001227300	3214300200	8001167500
FAF97K	8001225100	HDA4747	8001222100	69800011	8001486500	178012270	8001227300	3214300300	8001227400
GF219	8001225400	HDA5444	8001110600	Z7602AF932	8001167500	178012290	8001227300	3214300600	8001225100
KF11	8001315700	HDA5695	8001227400	HENGST		178011090A	8001225400	3214300900	8001225100
KF12	8001315600	HDA5700	8001224500	285L	8001280900	178011110A	8001224500	3214302200	8001227400
KF13	8001314100	HDA5961	8601567700	AF235	8001280900	178011180A	8001139100	3214302600	8001227400
KF9	8001315000	HDA6256	8001130800	E111L	8001239700	178011190A	8001138900	3214302700	8001138900
HAULAMATIC		HDA6257	8001100300	E112LS	8001648800	178012030A	8001131700	3214303600	8001224500
900020	8001138900	HDA6259	8001105600	E113L	8001223100	178012040A	8001130800	HOUGH	
HAWKER SIDDELEY CANADA		HDA6587	8001138900	E114L	8001238600	HITACHI		8419892	8001225100
2705583	8001138900	HDA6658	8001707000	E114LS	8001353000	500.414	8001352700	HUBER-WARCO	
69100108	8001224500	HDA6659	8001707500	E115L	8001238500	501488	8001139100	104905	8001138900
HEAVY DUTY AIR		HDA6660	8001225200	E115LS	8001353100	502826	8001224500	111202	8001110600
HDA0022	8001224400	HDA6769	8001224500	E116L	8001224200	502827	8001225400	403217	8001110600
HDA0281	8001146700	HDA6775	8001225400	E116L01	8001224800	502850	8001224200	8T2405	8001110600
HDA0307	8001341000	HDA6834	8001139100	E116LS	8001352700	4059818	8001139100	HY-DYNAMIC	
HDA0591	8001224400	HDA6840	8001110600	E117L	8001223500	4080065	8001131700	104516	8001225100
HDA0760	8001105600	HDA6984	8001222600	E118L	8001227800	4080066	8001130800	HYDRA-MAC	
HDA0761	8001105600	HDA6989	8001226900	E118LS	8001352800	4085787	8001224500	4100021	8001167500
HDA0771	8001410400	HDA7443	8001225300	E120L	8001228500	4085788	8001225400	4108311	8001110600
HDA0776	8001222600	HDA7532	8001227600	E127L	8001121100	4090408	8001138900	HYMAC	
HDA0949	8001498000	HDA7781	8001707500	E149L	8001298000	4090409	8001139100	2700228	8001110600
HDA1237	8001225100	HDA7784	8001222800	E151L	8001578800	4100806	8001138900	2709026	8001138900
HDA12401	8001167500	HDA7868	8001128800	E199L	8601569000	4122937	8001224500	HYSTER	
HDA1275	8001110600	HDA8216	8001335700	E209L	8601569300	4137604	8001128800	123730	8001110600
HDA1282	8001224400	HDA8336	8001204800	E218L	8001238700	4146898	8001224500	125846	8001110600
HDA1285	8001315700	HDA8407	8001723000	E237L	8001490000	4206272	8001723000	150836	8001225100
HDA1286	8001315600	HDA8408	8001723200	E277L	8001209100	4206273	8001723000	154818	8001224300
HDA1287	8001315000	HDA8668	8001130800	E278L	8001222500	4237633	8001224500	155748	8001225100
HDA1328	8001130800	HDA8674	8001131700	E278LS	8001687600	4237663	8001224500	170681	8001224300
HDA1329	8001130800	HDA8736	8001220200	E282L	8001223800	4244607	8001139100	179930	8001225100
HDA1333	8001227300	HDA8748	8001110600	E285L	8001280900	4294845	8001273900	179948	8001110600
HDA1334	8001239500	HDA8999	8001167500	E286L	8001223400	4294846	8001277000	179955	8001224300
HDA1344	8001131600	HDA9085	8001227400	E289L	8001266000	4326841	8001605400	223137	8001224300
HDA1346	8001105600	HDA9135	8001129500	E291L	8001228300	4337639	8001225400	252792	8001225400
HDA1350	8001131700	HDA9200	8001226900	E76L	8001134800	151849134	8001194200	326483	8001110600
HDA13511	8001139100	HDA9334	8001221400	HERCULES		3214300200	8001167500	390221	8001224300
HDA1352	8001225400	HDA9340	8001110600	400000614	8001224300	3214305900	8001167500	395841	8001128800
HDA1394	8001111000	HDA9363	8001128800	HESSTON		D106587	8001138900	395842	8001131600

MFRS Cod.	VIRGIS Cod.	MFRS Cod.	VIRGIS Cod.	MFRS Cod.	VIRGIS Cod.	MFRS Cod.	VIRGIS Cod.	MFRS Cod.	VIRGIS Cod.
1352670	8001167500	AR253	8001103800	59438804	8001128800	AF6182	8001352700	9142151840	8001130800
1369809	8001110600	AR256	8001110600	59567255	8001473300	AFI6121	8001648800	9142151932	8001225100
SKS41373	8001110600	AR502	8001225300	59825562	8001130800	AFI6123	8001648700	IVECO	
SKS413732	8001110600	AR507	8001224500	59888891	8001128800	AFI6159	8001353100	197588	8001225200
T966133	8001225100	AR507SY	8001225400	85400646	8001440900	AFI6180	8001353000	266786	8001130800
TC10206102	8001225100	AR523	8001138900	85400679	8001407400	AFI6215	8001111000	638274	8001100300
HYUNDAI		INGERSOLL-RAND		85400729	8001441000	AFI6220	8001352900	659387	8001225300
2813044000	8001167500	825562	8001130800	91634337	8001225200	AFI6225	8001121100	667078	8001238700
E2112103	8001130800	5227739	8001707500	91634345	8001225300	AFI6225	8001228300	667690	8001227300
IHC HOUSINGS		10349866	8001110600	91672675	8001224500	AFI6235	8001298000	1186044	8001128800
259921-C91	8001225100	10349868	8001110600	91672683	8001225400	AFI6251K	8001128800	1186046	8001238500
259921-C92	8001225100	35103217	8001284700	92035948	8001227800	AFI6252	8001131600	1186389	8001224200
306909-C91	8001225100	35109156	8001224500	92035955	8001352800	ISEKI		1901779	8001223500
323272-C91	8001225100	35109206	8001225400	92055530	8001227800	1792705006	8601792400	1901901	8001228400
323273-C91	8001225100	35109263	8001225300	92058885	8001283900	17297050151	8601689200	1901902	8001224500
366379-C91	8001225100	35109271	8001225200	92079425	8001130800	142710101400	8001329700	1901903	8001138900
380347-R91	8001110600	35274752	8001226900	92117431	8001128800	142710128400	8001167500	1901925	8001223500
380347-R92	8001110600	35275965	8001227400	92124213	8001228500	144410137000	8001329600	1902040	8001410400
388126-R1	8001110600	35275973	8001227300	92147353	8001473300	148010420700	8001220200	1902048	8001224200
388126-R91	8001110600	35291509	8001146700	92147453	8001473300	154410420200	8001269400	1902077	8001238500
389290-R91	8001110600	35291970	8001473300	92266485	8001225100	155010420200	8001329400	1902121	8001223100
594686-R91	8001110600	35298108	8001723000	92266519	8001138900	156010320240	8001271600	1902127	8001238600
750205-C91	8001225100	35298116	8001723200	92273705	8001224500	156010320250	8001551200	1902128	8001224800
752616-C91	8001225100	35318252	8001128800	92686922	8001224200	157210325000	8001404700	1902129	8001227800
761490-C91	8001225100	35326230	8001224400	92686930	8001352700	167510421300	8001759000	1902130	8001353000
766442-C91	8001224500	35902295	8001224300	92686948	8001223500	ISUZU		1902131	8001353100
769432-C91	8001224500	36876423	8001473300	92686955	8001352900	1142150070	8001138900	1902132	8001352900
769436-C91	8001224500	39125547	8001284700	92740984	8001227800	1142150071	8001138900	1902465	8001224200
769436-C92	8001224500	39708466	8001284300	92740992	8001352800	1142150072	8001138900	1904550	8001227800
769722-C91	8001225100	50265321	8001225100	92793025	8001441000	1142150140	8001110600	1904581	8001223100
771456-C91	8001225100	50616416	8001227400	92867357	8001320500	1142150330	8001225400	1905620	8001352800
771456-C92	8001225100	50616424	8001227300	92888718	8001311500	1142150340	8001225400	1905710	8001376300
771456-C93	8001225100	51278133	8001138900	92889534	8001311600	1142150460	8001224500	1905983	8001282500
773305-C91	8001225100	52146958	8001723000	93191542	8001383500	1142150461	8001224500	1907553	8001410700
774564-C91	8001225100	52146966	8001723200	93793025	8001441000	1142150470	8001139100	1908233	8001438700
873737-C91	8001138900	52252061	8001723000	118/H/1106	8001225100	1878100670	8001130800	1908868	8001438700
887977-C91	8001225100	52269875	8001227300	118/H/1144	8001224500	5142150020	8001167500	1909116	8001222800
924279C1	8001130800	52277381	8001707000	118/H/1154	8001138900	5142150021	8001167500	1909128	8001105600
INDUCONTRO		56778442	8001226900	INSLEY		8970423170	8001167500	1909132	8001352900
AR1570	8001707000	58923442	8001131600	915613	8001225100	9142150170	8001131700	1909138	8001434300
AR1570SY	8001707500	59046797	8001441000	IOWA		9142150340	8001225400	1909139	8001103800
AR2	8601567700	59046805	8001441300	4569000115	8001224300	9142150461	8001224500	1930476	8001139100
AR226	8001221400	59106393	8001736500	45690001152	8001100300	9142151402	8001225100	1930587	8001407400
AR226SY	8001314100	59144170	8001605000	IRLEMP		9142151531	8001130800	1930589	8001441000
AR234	8001315000	59144188	8001605400	AF24650	8001687300	9142151661	8001128800	1930592	8001440200
AR236	8001315600	59341560	8001382400	AF24650/1	8001223500	9142151700	8001131700	1930603	8001445500
AR237	8001315700	59407973	8001167500	AF6154	8001227800	9142151830	8001100300	1930730	8001204800

MFRS Cod.	VIRGIS Cod.	MFRS Cod.	VIRGIS Cod.	MFRS Cod.	VIRGIS Cod.	MFRS Cod.	VIRGIS Cod.	MFRS Cod.	VIRGIS Cod.
1930747	8001224500	8106840	8001353100	07980507	8001131700	AH19847	8001110600	DQ08521	8001224200
1930764	8001188000	8109774	8001238600	09917419	8001225100	AH20487H	8001224300	DQ08522	8001352700
1930783	8001279400	8122408	8001238700	09921320	8001138900	AH21421	8001222100	GG42031932	8001167500
1930784	8001279800	8561046	8001128800	09923130	8001138900	AL27159	8001222600	MG221406	8001146700
1930786	8001279000	9917419	8001225100	09927604	8001128800	AM102746	8001220200	MG272744	8001341000
1930792	8001188000	9921320	8001138900	09932594	8001224400	AN150200	8001110600	PAT44377	8001100300
2165039	8001223100	9923130	8001138900	09933276	8001224500	AN153119	8001434300	RE33884	8001194200
2165044	8001238600	9927604	8001128800	09981555	8001226500	AR21424	8001222100	RE35522	8001204800
2165049	8001238500	9932594	8001224400	09983764	8001223500	AR39798	8001222100	RE35523	8001307400
2165054	8001224200	9933276	8001224500	J.C.BAMFORD		AR45943	8001138900	RE42725	8001234500
2165059	8001223500	9981555	8001226500	2600601	8001110600	AR46003	8001138900	RE42725	8001234500
2168629	8001224800	9983764	8001223500	32/201601	8001139100	AR46004	8001139100	RE45827	8001222800
2241329	8001353100	19303669	8001441000	32/201602	8001138900	AR46973	8001410400	RE45828	8001222900
2243946	8001352700	20008157	8001128800	32/202501	8001139100	AR64104	8001105600	RT6005011111	8001441000
2414950	8001353000	41272534	8001227800	32/202601	8001131600	AR71635	8001105600	RT6005011112	8001441300
3046858	8001100300	42480759	8001352700	32/202602	8001128800	AR84228	8001105600	T115437	8001434300
4059252	8001100300	42481020	8001352900	32/206002	8001194100	AT1131N	8001110600	T46316	8001130800
7980507	8001131700	42481021	8001352900	32/208304	8001131700	AT131683	8001225400	T46317	8001239500
8014390	8001128800	42484344	8001128800	32/903001	8001318500	AT175223	8001668900	U44956	8001225400
8014410	8001130800	42484726	8001138900	32/903601	8001327000	AT25981	8001224300	U44957	8001224500
8014430	8001100300	42488361	8001227800	32/905002	8001478700	AT31825	8001110600	JOHN DEERE HOUSINGS	
8015448	8001111000	59905104	8001131500	32/912901	8001692800	AT44377	8001100300	AR45669	8001410400
8015449	8001131600	61654541	8001138900	32/912902	8001538000	AT44378	8001111000	JOY	
8015450	8001131700	79067204	8001193500	32/913602	8001204800	AT45018	8001130800	501072	8001224300
8016660	8001138800	79083213	8001131600	988/00031	8001265300	AT49022	8001335600	516566	8001224300
8016666	8001139000	242495001	8001105600	AC210	8001283900	AT69307	8001227400	518566	8001224300
8016966	8001225400	300136922	8001138900	B03210033	8001110600	AZ18968	8001223100	1660264	8001284700
8016967	8001224500	303048581	8001100300	KAP0482	8001277000	AZ20623	8001238600	51900235	8001224300
8016976	8001335600	320498850	8001131600	JAEGER		AZ20625	8001224400	360628320	8001225200
8016977	8001335700	321549250	8001225400	739051	8001224300	AZ20626	8001238600	00501072	8001224300
8019342	8001363200	920015933	8001193500	JENBACHER WERKE		AZ21745	8001130800	005010720030	8001224300
8019343	8001363600	01186044	8001128800	162860	8001224400	AZ25498	8001353000	01660264	8001284700
8020729	8001388000	01186046	8001238500	JOHN BEAN		AZ25867	8001226500	TAX33N	8001224400
8023027	8001411100.	01186389	8001224200	1410546	8001225100	AZ25868	8001224400	KAELBLE	
8025818	8001225300	02165039	8001223100	1410549	8001225100	AZ26007	8001352700	24000389	8001224500
8031211	8001407400	02165044	8001238600	1410903	8001110600	AZ26091	8001224200	24000504	8001223500
8031565	8001427000	02165049	8001238500	1410910	8001110600	AZ30757	8001238500	24000505	8001352900
8032064	8001441000	02165054	8001224200	JOHN DEERE		AZ30758	8001353100	34000091	8001130800
8032066	8001441300	02165059	8001223500	12X20957A	8001222100	AZ45870	8001225400	34000191	8001352700
8034304	8001587000	02168629	8001224800	21X11983C	8001224300	AZ48195	8001223500	34000291	8001225100
8092438	8001353000	02241329	8001353100	21X11984A	8001224300	AZ48196	8001352900	34000320	8001138900
8092439	8001238500	02243946	8001352700	31X10894A	8001110600	CH12767	8001110600	34000330	8001225400
8092441	8001224200	02414950	8001353000	41X10894A	8001110600	CH15451	8001167500	34000460	8001224200
8092442	8001352700	059905104	8001131500	AE31723	8001105600	CH18287	8001128800	34000489	8001238500
8092444	8001352800	0638274	8001100300	AE31724	8001222600	DDX18911	8001194200	34000490	8001353100
8092445	8001223500	0659387	8001225300	AF19847	8001110600	DDX18913	8001279800	40600261	8001225400
8092446	8001352900	0667690	8001227300	AH19846	8001110600	DOX18913	8001279800	874080789	8001131700

MFRS Cod. VIRGIS Cod.

874080790 8001130800

KAESER

602190 8001228500

619960 8001238600

619970 8001238500

619990 8001353100

KALAMAZOO

10000025 8001110600

KALMAR

1321840 8001353100

9231100577 8001668900

9231100578 8001629000

19207230003 8001353100

KALORI

34070238 8601897900

34070250 8601898200

KARCHER

59870000 8601886100

59870010 8601886500

64220410 8601885800

64222870 8601886000

96670170 8601885900

KASSBOHRER

8319000050 8001227400

8319009084 8001238500

8319039104 8001225100

8319039109 8001225100

8319085102 8001224200

8319086094 8001687300

8319095116 8001227800

8319098117 8001687300

83190586094 8001223500

KATO

11961202000 8001130800

KAWASAKY

3098170110 8001128800

YYP101237 8001225100

YYP106587 8001138900

YYP106769 8001224500

YYP106775 8001225400

YYP106834 8001139100

YYP108668 8001130800

YYP108674 8001131700

YYP117431 8001225100

YYP117437 8001224500

YYP119373 8001225400

MFRS Cod. VIRGIS Cod.

KHD(KLOCKNER-HUMBOLDT-DEUTZ)

1163766 8001138900

1169024 8001129500

1169116 8001128800

1169117 8001131600

1186044 8001128800

1186046 8001238500

2165029 8001239700

2165038 8001223100

2165039 8001223100

2165041 8001224200

2165044 8001238600

2165049 8001238500

2165054 8001224200

2165056 8001223500

2165059 8001223500

2165074 8001224200

2168629 8001224800

2211565 8001209100

2216260 8001687300

2240348 8001687300

2241036 8001298000

2241038 8001298000

2241329 8001353100

2243521 8001687900

2243946 8001352700

2311565 8001209100

2322855 8001222500

2323855 8001222500

2339812 8001209100

2339813 8001209100

2339823 8001222500

2352341 8001224500

2352343 8001225400

2379161 8001688000

2379163 8001687600

2394637 8001352900

2408868 8001224800

2414950 8001353000

2415950 8001353000

2508228 8001224800

2508238 8001224800

2912005 8001238600

2912007 8001224800

2914182 8001224800

2985037 8001353000

MFRS Cod. VIRGIS Cod.

4144896 8001648800

4144966 8001352900

4149014 8001130800

4149022 8001131700

4308634 8001688000

4308636 8001687600

4319256 8001222900

4319257 8001222800

4319262 8001131700

4319263 8001227600

4384102 8001209100

4384103 8001222500

4397234 8001279400

41448896 8001648800

2165044EZ 8001238600

KIRKALDIE ENG.

KA100 8001221400

KA111 8001224200

KA113 8001238500

KA114 8001238600

KA125 8001239700

KA126 8001687300

KA14 8001225100

KA14K 8001225100

KA15 8001110600

KA15K 8001110600

KA18 8001138900

KA21 8001265300

KA22K 8001128800

KA29 8001266000

KA30 8001224500

KA96 8001223500

KA97 8001224800

KNECHT

AF86 8001239700

AG101 8001224800

AG102 8001687300

AG136 8001209100

AG137 8001110600

AG145 8001225100

AG155 8001707000

AG156 8001707500

AG184 8001131600

AG202 8001222500

AG207 8001128800

AG235 8001280900

AG243 8001121100

MFRS Cod. VIRGIS Cod.

AG262 8001228500

AG300 8001287000

AG64 8001223400

AG74 8001238500

AG86 8001239700

AG87 8001223100

AG88 8001238600

AG89 8001223500

AG90 8001227800

AG94 8001223800

AG96 8001224200

AG98 8001298000

EL502N 8001295300

LKS37 8001353100

LX335 8601569300

LX345 8001410700

LX437 8001287000

LX496 8001178900

LX531 8001238700

LX584 8001410400

LX612 8001490000

LX631 8001530400

LXS371 8001353100

LXS401 8001648800

LXS411 8001353000

LXS421 8001352700

LXS431 8001352900

LXS51 8001648700

LXS61 8001688000

SE045 8001648800

SE046 8001688000

SE080 8001353000

SE081 8001687600

SE082 8001131600

SE120 8001353100

SE150 8001352700

SE210 8001352900

SE280 8001352800

KOBELCO

3173081800 8001128800

2446R27755 8001224400

2446U154S2 8001131700

2446U154S3 8001130800

2446U185S3 8001224500

2446U212S2 8001225200

2446U244S1 8001434300

2446U299S2 8001434300

MFRS Cod. VIRGIS Cod.

2451R1243A 8001128800

2451U1243A 8001138900

2451U1243B 8001139100

2451U1803A 8001130800

2451U1803B 8001131700

2451U2063 8001131700

2451U2213 8001110600

2460U1964 8001225400

KOCKUM-LANDSVERK

79443768 8001234500

KOEHRING

124326 8001224300

124348 8001225100

124366 8001224300

4203568 8001224300

4203572 8001225100

7304539 8001110600

8273006 8001224300

8273234 8001146700

8273235 8001341000

8273237 8001128800

8273238 8001131600

8273267 8001473300

21001095 8001130800

21001107 8001131700

853521072 8001110600

853521073 8001110600

853521198 8001100300

K6275 8001110600

KOHLER

A249753 8001110600

KOMATSU

848101105 8001111000

6001816560 8001139100

3EC0125830 8001271600

41801K1170 8001139100

YMR000463 8001439300

Z7602AF931 8001110600

KOMATSU DRESSER

99737 800113

MFRS Cod.	VIRGIS Cod.	MFRS Cod.	VIRGIS Cod.	MFRS Cod.	VIRGIS Cod.	MFRS Cod.	VIRGIS Cod.	MFRS Cod.	VIRGIS Cod.
848101081	8001129500	VE1061	8001723200	LA286	8001224500	LA816	8001224200	1735111080	8001277500
2050173570	8001347300	VE1062	8001723000	LA298	8001217700	LA817	8001224800	1735111083	8001277500
2050173750	8001347300	VJ5175	8001707000	LA325	8001224500	LA818	8001223800	1921511220	8001167500
3059131021	8001110600	YM12112012901	8001110600	LA346	8001134800	LA822	8001223500	1940411081	8001227400
3819763261	8001138900	YM1710221253	8001167500	LA361	8001226900	LA85	8001315000	1945887480	8001514500
5501642705	8001228500	YM17102212530	8001167500	LA364	8001167500	LA852	8601409000	4023152300	8001138900
5527655841	8001167500	Z760118130	8001277000	LA364F	8001167500	LA884	8001723000	4025156400	8001227400
5810212130	8001707500	Z760125830	8001271600	LA385	8001138900	LA885	8001723200	4025156500	8001139100
6001812461	8001260500	Z760225550	8001434300	LA390	8001240300	LA890	8001222800	7000011080	8001103800
6001812500	8001260400	Z760234750	8001486500	LA395	8001284700	LA890F	8001222800	7000011081	8001110600
6001813800	8001224500	KRALINATOR		LA399F	8001220200	LA891	8001222900	7000011221	8001167500
6001814211	8001225400	LA1003	8001146700	LA421F	8001130800	LA906	8001227600	7000014500	8001103800
6001814212	8001225400	LA101F	8001225100	LA432	8001139100	LA907	8001131700	7661158420	8001167500
6001814230	8001225400	LA1048	8001228300	LA434	8001131700	LA913	8001223100	51852110801	8001167500
6001814300	8001224500	LA1049	8001121100	LA435	8001227400	LA977	8001239700	KUKJE MACHINERY CO.	
6001814311	8001224500	LA1102	8001353000	LA472	8001410400	LA981	8001222500	AE31724	8001222600
6001814330	8001224500	LA1103	8001353100	LA538	8001314100	LA982	8001209100	L B FILTERS	
6001814600	8001224500	LA1104	8001352700	LA549	8001239500	LA986	8001687300	A546	8001128800
6001816360	8001131700	LA1113F	8001103800	LA573F	8001222100	LA992	8001434300	A651	8001315000
6001818260	8001130800	LA1159	8001227800	LA574	8001707000	KRAMER		A654	8001315700
6001818300	8001130800	LA1166	8001227800	LA601F	8001473300	805187	8001407400	A658	8001282600
6001818360	8001131700	LA1258F	8001222800	LA608	8001227300	9931106	8001239700	A665	8001221400
6001819200	8001128800	LA1259	8001222900	LA617	8001707500	KUBOTA		A666	8001315600
6001819240	8001128800	LA1281	8001260500	LA632	8001105600	6677983	8601865800	A683	8001139100
6001821100	8001110600	LA134	8001110600	LA632F	8001105600	6678207	8601865700	A698	8001225100
6127817310	8001225300	LA134F	8001110600	LA633	8001222600	1510411080	8001110600	A701	8001227300
6127817320	8001225300	LA135	8001224300	LA641	8001335600	1522111223	8001167500	A702	8001227400
6127819031	8001225200	LA140	8001111000	LA642	8001335700	1522211220	8001167500	A711	8001224500
115548H45	8001167500	LA1434	8001222500	LA644	8001146700	1522211221	8001167500	A720	8001110600
1201734H1	8001225400	LA1490	8001194200	LA644F	8001146700	1522211223	8001167500	A734	8001130800
1266091H1	8001224500	LA1491	8001248500	LA658	8001128800	1522211224	8001167500	A735	8001131700
20301K1130	8001193500	LA1500	8001249100	LA658F	8001128800	1522711221	8001167500	A819	8001314100
20301K1290	8001131600	LA1526	8001271600	LA675	8001131600	1528711080	8001110600	A820	8001128800
34A0234130	8001167500	LA1538F	8001188000	LA690F	8001128800	1528711081	8001110600	A821	8001131600
34B0231930	8001110600	LA1553	8001472200	LA691	8001131500	1531911221	8001167500	A870	8001335700
37Z02AF931	8001110600	LA1584	8001194100	LA692	8001129500	1532111011	8001167500	LACRE	
37Z02AF931L	8001110600	LA161F	8001222100	LA755	8001226500	1532111221	8001167500	60441	8001110600
37Z02AF932	8001167500	LA1623	8001204800	LA77	8001315700	1532811221	8001167500	LANCER BOSS	
37Z02AF932L	8001167500	LA1625	8001471500	LA776F	8001130800	1540111080	8001110600	865775	8001138900
3EA0112130	8001277000	LA1628	8001498000	LA777F	8001224400	1558111081	8001227400	8620140	8001224500
3EA0116120	8001167500	LA1638F	8001100300	LA78	8001221400	1560611080	8001103800	8620159	8001110600
3EA0118130	8001277000	LA1765	8001352900	LA781F	8001224300	1560696015	8001130800	8620204	8001128800
3EA0118130L	8001277000	LA18	8601409000	LA782F	8001110600	1561211180	8001434300	8620212	8001131700
3EB0125380	8001271600	LA202	8601567700	LA79	8001315600	1574111080	8001271600	8639028	8001473300
3EB0225550	8001434300	LA202B	8601567700	LA791	8001238500	1574111083	8001271600	8657795	8001138900
CUAF418M	8001138900	LA231F	8001128800	LA812	8001298000	1627111080	8001687200	8862651	8001139100
CUAF490M	8001139100	LA249	8001225400	LA813	8001238600	1732511080	8001110600	9260261	8001110600

MFRS Cod.	VIRGIS Cod.	MFRS Cod.	VIRGIS Cod.	MFRS Cod.	VIRGIS Cod.	MFRS Cod.	VIRGIS Cod.	MFRS Cod.	VIRGIS Cod.
D600689	8001167500	434931	8001110600	5106509	8001223800	70002403	8001223100	69100108	8001224500
DO55379	8001239700	436351	8001110600	5106525	8001353000	70002639	8001131600	75727890	8001867200
K26046	8001224500	X43422	8001224300	5507989	8001128800	70005286	8001130800	02705419	8001110600
LANDINI		LEYLAND		5507991	8001224500	70005287	8001239500	02705583	8001138900
3310357	8001204800	735724	8001138900	5507994	8001723000	70005424	8001128800	JF35A/6	8001217700
3310358	8001188000	10906043	8001225100	5507995	8001723200	550799214	8001224500	ZPF35/6	8001283900
VP125395	8001440900	10906053	8001224500	5600615	8001226900	737095503	8001629400	LOCKWOOD	
LANSING-BAGNALL		10906079	8001138900	5601964	8001224200	510 6181	8001223500	85319	8001224300
1041308	8001217700	35516458	8001224500	5604683	8001227400	510 6191	8001227800	85328	8001110600
LANSING-LINDE		41007448	8001138900	6425549	8001130800	560 1963	8001352700	85329	8001110600
000E068-019001	8001224500	41008819	8001224500	6425550	8001131700	7 367 183	8001223500	LOED CORPORATION	
E725047003	8001110600	41017302	8001224500	6425723	8001138900	LINDE		200230	8001224300
LAUTRETTE		41735724	8001138900	6425724	8001139100	9831604	8001238500	LORAIN	
EL1684S	8001125200	37H2004	8001265300	7008443	8001723000	9839012	8001239700	P11913	8001225100
EL1780S	8001248500	37H3739	8001128800	7009285	8001138900	9839014	8001223100	P55591	8001138900
EL1781P	8001351000	AAU3669	8001283900	7009286	8001139100	9839015	8001238600	P55596	8001138900
EL1781S	8001352000	ABU4557	8001225300	7010578	8001225400	9839017	8001648700	P55602	8001139100
EL2106P	8001249100	ABU6138	8001224500	7360149	8001224400	9839019	8001228500	P55605	8001224500
EL2106S	8001248500	ABU6151	8001139100	7360150	8001226500	9839331	8001110600	P55606	8001225400
EL2107P	8001250000	ABU8508	8001225100	7360230	8001131600	000 983 9016	8001648800	LOSENHAUSEN	
EL2107S	8001227900	ABU8516	8601568000	7360733	8001353100	983 9020	8001353100	04003/08015	8001239700
EL2134P	8001434000	ABU8518	8001266000	7360753	8001238500	FM8104273	8001353000	04021/19504	8001238600
EL2134S	8001433400	ABU8522	8001224200	7360972	8001227600	LINK-BELT		4022/19502	8001238500
EL2151P	8001249800	ABU8524	8001223500	7360973	8001131700	253053	8001224300	4022/19505	8001353100
EL3049	8001138900	ABU8525	8001238500	7361346	8001353000	1409265	8001224300	LPM	
EL3051	8001225100	ABU8530	8001121100	7361347	8001238600	1410546	8001225100	00013504276	8001110600
EL3053	8001110600	ABU9670	8001224500	7362587	8001225400	1410903	8001110600	LUBERFINER	
EL3054	8001224500	ABU9896	8001227600	7362686	8001224500	1410910	8001110600	LAF1246B	8001224300
EL3083	8001238500	ACU2889	8001275200	7362687	8001225400	1416129	8001224300	LAF1275	8001110600
EL3084	8001223500	ACU2915	8001278100	7363362	8001130800	2341502	8001224300	LAF1275B	8001110600
EL3085	8001224800	ACU3426	8001224500	7364869	8001723000	33242237	8001225100	LAF1394	8001111000
EL3086	8001224200	ACU7896	8001128800	7364870	8001723200	3H218	8001225100	LAF1466	8001194100
EL3087	8001238600	ACU8223	8001227800	7367182	8001352900	JLH100	8001193500	LAF15	8601409000
EL3089	8001687300	ACU9896	8001227600	7368215	8001747000	JLH101	8001131600	LAF1544	8001128800
EL3304P	8001249100	BBU4784	8001193500	7370955	8001629400	KRH0786	8001139100	LAF1711	8001648800
EL3304S	8001248500	BBU6549	8001223100	7370956	8001630100	LISTER PETTER		LAF1712	8001223100
LAVERDA		BBU6634	8001285700	7371156	8001538000	194008	8001283900	LAF1713	8001648700
300137988	8001279000	BBU8346	8001121100	7371157	8001692800	194010	8001217700	LAF1714	8001238600
320651750	8001279400	CRF508027	8001138900	7401316	8001224400	292364	8001283900	LAF1715	8001353000
LEROI		RDK6220	8001225400	7402027	8001131700	397079	8001110600	LAF1716	8001224200
22099	8001110600	RTC3479	8001285700	7405233	8001279800	397305	8001167500	LAF1717	8001352700
43422	8001224300	LIEBHERR		7412732	8001692800	35243820	8001217700	LAF1718	8001223500
43493	8001110600	701468	8001209100	7412733	8001538000	36608105	8001440900	LAF1719	8001352900
43635	8001110600	5106180	8001223100	7615526	8001194200	36608109	8001486500	LAF1720	8001353100
43646	8001225100	5106182	8001238600	7619404	8001441000	36608110	8001427000	LAF1721	8001131600
220099	8001110600	5106189	8001238500	7619405	8001441300	38207903	8001340400	LAF1722	8001129500
434221	8001224300	5106368	8001138900	70002402	8001648700	60241760	8001110600	LAF1723	8001131500

MFRS Cod.	VIRGIS Cod.	MFRS Cod.	VIRGIS Cod.	MFRS Cod.	VIRGIS Cod.	MFRS Cod.	VIRGIS Cod.	MFRS Cod.	VIRGIS Cod.
LAF1725	8001226500	LAF6775	8001225400	LAF8649	8001530000	MA6637P	8001224200	81083040060	8001223500
LAF1726	8001227800	LAF6834	8001139100	LAF8651	8001282500	MA6655	8001265300	81083040062	8001138900
LAF1727	8001352800	LAF7672	8001224500	LAF8658	8001410700	MA6679	8001238600	81083040063	8001139100
LAF1732	8001239700	LAF7781	8001707500	LAF8659	8001220200	MA6684	8001121100	81083040064	8001224200
LAF1733	8001209100	LAF7782	8001707000	LAF8662	8001130800	MA6702	8001239700	81083040065	8001352900
LAF1734	8001105600	LAF8166	8001388900	LAF8664	8001279800	MA6708	8001217700	81083040066	8001747000
LAF1735	8001222600	LAF8211	8001335600	LAF8665	8001125200	MA6709	8001138900	81083040074	8001410700
LAF1737	8001278100	LAF8216	8001335700	LAF8668	8001130800	MA6713	8001283900	81083040076	8001410700
LAF1741	8001228500	LAF8407	8001723000	LAF8674	8001131700	MA674P	8001266000	81083040083	8001490000
LAF1743	8001121100	LAF8408	8001723200	LAF8736	8001220200	MA684	8001223500	81083040083	8001490000
LAF1747	8001228300	LAF8503	8001298000	LAF8804	8001188000	MAK6693	8001110600	81083040094	8001490000
LAF1750	8001238700	LAF8515	8001194100	LAF8809	8001309000	MAT 6702	8001239700	81083040097	8001490000
LAF1777	8001335700	LAF8525	8001110900	LAF8811	8001352000	MAT6684	8001121100	81084050008	8001352700
LAF1793	8001434300	LAF8526	8001110900	LAF8814	8001223900	M.A.N.		81084050011	8001352800
LAF1798	8001223400	LAF8529	8001285700	LAF8817	8001351000	83040024	8001223400	81084050013	8001352800
LAF1826	8001240300	LAF8557	8001228300	LAF8818	8001277000	810830424	8001223400	81084050024	8001223400
LAF1842	8001222100	LAF8560	8001123900	LAF8819	8001260500	8183040040	8001223500	81541310001	8001295300
LAF1948	8001341000	LAF8561	8001111700	LAF8820	8001295300	8183040055	8001238500	86083044001	8001223400
LAF2052	8001238500	LAF8562	8001110800	LAF8821	8001260400	50083040003	8001130800	90801155196	8001223400
LAF237	8001225100	LAF8564	8001266000	LAF8822	8001445500	50083040004	8001224400	35A255106	8001223400
LAF237A	8001225100	LAF8567	8001222500	LAF8823	8001271600	50083040005	8001224500	A5008340004	8001224400
LAF2608	8001102000	LAF8568	8001687600	LAF8974E	8001307500	55508304015	8001225400	M.T.U.	
LAF2736	8001315700	LAF8569	8001230200	LAF8976E	8001279000	81055040033	8001223800	8690940	8001227800
LAF2745	8001167500	LAF8571	8001282600	LAF8977E	8001279400	81082050005	8001223500	10945104	8001223500
LAF2745A	8001167500	LAF8576	8001280900	LAF8979E	8001134300	81083040023	8001223800	8690940013	8001707000
LAF281	8001146700	LAF8579	8001265300	LAF8980E	8001319000	81083040024	8001223400	8690940430	8001238500
LAF334	8001221400	LAF8583	8001193500	LAF8991	8001376300	81083040029	8001223400	0010945104	8001223500
LAF335	8001315600	LAF8584	8001318500	LAF9001	8001224400	81083040032	8001687300	M.W.M.	
LAF336	8001314100	LAF8589	8001478700	LAF9085	8001227400	81083040036	8001224200	11806560005	8001225300
LAF3702	8001687300	LAF8598	8001418300	LAF9086	8001227300	81083040038	8001227800	11807490001	8001225100
LAF3704	8001224800	LAF8601	8001223800	LAF9200	8001226900	81083040039	8001223800	605412970031	8001298000
LAF3710	8001286700	LAF8602	8001381100	LAF9373	8001225400	81083040040	8001223500	605412970032	8001238600
LAF3714	8001227600	LAF8603	8001327000	LAF9410	8001131600	81083040041	8001223500	605412970034	8001238500
LAF3951	8601567700	LAF8605	8001418300	LAF9538	8001473300	81083040043	8001227800	605413900006	8001110600
LAF398	8001410400	LAF8606	8001248500	LAF9778	8001226500	81083040044	8001227800	606901670110	8001227800
LAF4514	8001277500	LAF8607	8001249100	LAF9972	8001314100	81083040045	8001224200	606901670111	8001352800
LAF4544	8001736500	LAF8608	8001249800	LUCAS		81083040046	8001352700	606901670113	8001238600
LAF4545	8001441300	LAF8609	8001178900	T236	8001134800	81083040048	8001223500	606901670114	8001353000
LAF46	8001315000	LAF8610	8001194200	LUGLI		81083040049	8001238500	606901670115	8001353100
LAF4714	8601567700	LAF8611	8001250000	2754234	8001100300	81083040050	8001225400	606901670116	8001238500
LAF4747	8001222100	LAF8612	8001227900	2754235	8001334900	81083040051	8001224500	011806560005	8001225300
LAF48	8001315700	LAF8613	8001230200	M FILTER		81083040053	8001238600	011807490001	8001225100
LAF5043	8001222100	LAF8618	8001222900	MA6611P	8001238500	81083040054	8001238600	MACDON	
LAF5368	8001128800	LAF8619	8001222800	MA6618	8001687300	81083040055	8001238500	30049	8001473300
LAF5859	8001275200	LAF8623	8001687900	MA6620	8001266000	81083040057	8001223500	MACK	
LAF6587	8001138900	LAF8625	8001217700	MA6622P	8001298000	81083040058	8001225200	2191P101237	8001225100
LAF6769	8001224500	LAF8635	8001382400	MA6628	8001228300	81083040059	8001225300	2MD2133	8001225100

MFRS Cod.	VIRGIS Cod.	MFRS Cod.	VIRGIS Cod.	MFRS Cod.	VIRGIS Cod.	MFRS Cod.	VIRGIS Cod.	MFRS Cod.	VIRGIS Cod.
2MD433	8001225100	LXS25	8001225400	4588092304	8001227800	C17250	8001222500	C31 1256	8001530400
81SD25	8001225100	LXS30	8001131700	C 1132	8001751200	C17337	8001441000	C311093	8001228300
MACO-MEUDON		LXS34	8001226500	C11100	8001687800	C18436	8001224400	C311093/1	8001228300
25221	8001225100	LXS37	8001353100	C1112	8001295300	C19157	8001225200	C311093/2	8001228300
520730	8001128800	LXS40	8001648800	C1131	8001311500	C1989/1	8001578800	C311226	8001225300
520731	8001131600	LXS41	8001353000	C1131/1	8001311500	C20215	8001227400	C311226/1	8001530000
520837	8001138900	LXS42	8001352700	C1140	8001754100	C20325/2	8001238500	C311495	8001692200
520942	8001129500	LXS43	8001352900	C1176/3	8001239700	C20500	8001649200	C321420/2	8001945000
520943	8001131500	LXS44	8001352800	C1188	8001110600	C21431	8001130800	C321752/1	8001878400
521542	8001224400	LXS62	8001687600	C12100	8001131700	C21630/1	8001692800	C331476	8001376300
521745	8001130800	MANITOU		C12100/1	8001131700	C21925	8001282600	C45 3265	8001707000
528052	8001445500	9865	8001110600	C1250	8001754200	C23440/1	8001224200	C60148	8601568800
MAHLE		169468	8001110600	C1258	8001139100	C23440/2	8001224800	C60230	8601569000
LX13	8001167500	169470	8001139100	C1281	8001139100	C23440/3	8001224200	C60345	8601569300
LX14	8001110600	169471	8001131600	C13131	8001364400	C23500	8001223400	C630	8001753900
LX174	8001217700	169472	8001128800	C13135	8001228700	C23610	8001688100	C711/1	8001740600
LX179	8001178900	169473	8001265300	C13154	8001876200	C24355	8001223900	CF100	8001687700
LX18	8001128800	169476	8001138900	C1368	8001311600	C24393	8001282500	CF1000	8001353100
LX192	8001295300	169478	8001225100	C1371	8001315700	C24508	8001410700	CF1122	8001226500
LX196	8001209100	169481	8001223100	C1392	8001287000	C24516	8001225100	CF1200	8001352700
LX21	8001225100	169483	8001239700	C14079	8001167500	C24517	8001138900	CF1300	8001352900
LX227	8001224200	169487	8001238600	C1417	8001569600	C24650	8001687300	CF1600	8001352800
LX231	8001224800	177129	8001382400	C14179/1	8001105600	C24650/1	8001223500	CF200	8001649300
LX236	8001238600	177130	8001381100	C14190	8001129500	C24700/1	8001223800	CF2100	8001747000
LX240	8001223400	177178	8001555700	C1426	8001134800	C24719	8001138900	CF2100	8001747000
LX241	8001687300	177179	8001418300	C14490	8001129500	C24813	8001530000	CF300	8001649400
LX242	8001298000	185578	8001381800	C15127/1	8001178900	C24870	8001227600	CF400	8001649500
LX265	8001238500	227959	8001486500	C15165/1	8001223100	C25710/3	8001696900	CF500	8001649600
LX27	8001130800	227960	8001427000	C15165/3	8001223100	C26315/4	8001266000	CF600	8001648800
LX271	8001223500	448037	8001128800	C15248	8001280900	C271406	8001121100	CF610	8001687500
LX272	8001239700	455044	8001129500	C15300	8001649000	C271520	8001121100	CF700	8001648700
LX273	8001227800	563415	8001470800	C16140	8001315600	C27836	8001226900	CF7001	8001876000
LX274	8001223800	563416	8001470300	C16147	8001314100	C28750	8001279800	CF710	8001697000
LX275	8001223100	780978	8601877400	C16154	8001222100	C291055	8001529400	CF711	8001688000
LX28	8001138900	882133	8601877600	C16175	8001315000	C29624	8001221400	CF800	8001353000
LX29	8001224500	921110	8601877500	C16190/1	8001224300	C29624/1	8001221400	CF810	8001697200
LX32	8001129500	MANN & HUMMEL		C16247/1	8001438700	C29920	8001224500	CF811	8001687600
LX33	8001224400	4510054134	8001383500	C16302	8001128800	C29939	8001224500	CF820	8001687900
LX334	8601569000	4511455209	8001648800	C1633/1	8001495000	C301240	8001489600	CF821	8001687900
LX83	8001280900	4516555224	8001223100	C16400	8001649100	C301353	8001490000	CF840	8001222600
LX84	8001121100	4516555239	8001648700	C17126	8001225400	C301500	8001490200	CF922	8001131600
LX93	8001228300	4522555229	8001353000	C17134	8001209100	C30703	8001238700	CF923	8001131500
LX99	8001228500	4522592304	8001238600	C17149	8001225400	C30810/3	8001697100	CF924	8001111000
LXS19	8001315700	4532592304	8001238500	C17201	8001228500	C30850/2	8001227800	CS18106	8001393900
LXS201	8001139100	4544092304	8001224200	C17225	8001298000	C308502	8001227800	CS19175	8001388900
LXS212	8001131500	4544092664	8001224200	C17225/2	8001238600	C308506	8001227800	CS19195	8001319000
LXS214	8001131600	4565092304	8001223500	C17225/3	8001238600	C308507	8001227800	CU3959	8601893200

MFERS Cod.	VIRGIS Cod.	MFERS Cod.	VIRGIS Cod.	MFERS Cod.	VIRGIS Cod.	MFERS Cod.	VIRGIS Cod.	MFERS Cod.	VIRGIS Cod.
CU42001	8601820300	1621646M91	8001129500	3621275M1	8001473300	15A339	8001110600	15A739	8001110600
CU45120	8601835300	1633719M1	8001433400	3621282M1	8001128800	15A739	8001110600	15H665	8001110600
CUK26005	8601891700	1635988M91	8001248500	3621283M1	8001131600	15H665	8001110600	15H668	8001110600
LA1434	8001222500	1635989M91	8001249800	3621284M1	8001194100	15H668	8001110600	MERLO	
MARSHALL FOWLER		1644333M1	8001433400	3902806M1	8001696900	MENARINI		053215	8601813500
900785	8001222900	1644334M1	8001434000	3902812M1	8001697000	178624	8001225400	MICRO PORE	
2811070	8001110600	1678294M1	8001249100	506645M91	8001224300	178625	8001224500	A2771	8001227300
9007613	8001222800	1678295M1	8001248500	513605M91	8001220200	MENGELE		A5619A	8001138900
MASSEY-FERGUSON		1678296M1	8001249100	525611M91	8001138900	98026633	8001224200	A5619B	8001139100
19746201	8001687300	1678308M91	8001249800	525612M1	8001225400	98029974	8001352700	A5620B	8001225400
19796201	8001687300	1698375M1	8001125200	525612M91	8001139100	98039890	8001227800	AC74735	8001130800
197946201	8001687300	1698675M2	8001351000	579873M1	8001110600	98039927	8001223500	AC7486	8001224500
7277153200	8001423700	1698676M1	8001352000	6191362M1	8001441200	98039928	8001352900	AC74895	8001103800
1031436M91	8001110600	1698679M1	8001249100	723360M91	8001224300	98041118	8001352800	AF2771	8001227300
1031885M1	8001225100	1698680M1	8001248500	726199M1	8001128800	MERCEDES-BENZ		MILLER ELECTRIC	
1031885M91	8001225100	1699779M1	8001249100	CL677434C0	8001238500	3760947104	8001130800	017309	8001110600
1032762M91	8001220200	1699780M1	8001248500	TDX27493	8001110600	8690940020	8001227800	018765	8001110600
1037735M91	8001131500	1804507M91	8001167500	TRA8273234	8001146700	61100190020	8001353000	025092	8001224300
1040764M91	8001473300	1866048M92	8001128800	TRA8273235	8001341000	61200190033	8001353100	MIOFILTRE	
1040830M91	8001138900	1886670M1	8001423700	TRA8273267	8001473300	344094730494	8001353100	20051	8001110600
1040919M91	8001139100	240737M91	8001224300	MASTE		0010944204	8001238500	20053	8001225100
1042412M91	8001224400	246918M91	8001110600	IS124	8001298000	0010944604	8001238600	20055	8001138900
1043327M91	8001434300	258522M91	8001131600	IS152	8001687300	0010944704	8001224200	20061	8001238500
1055493M91	8001105600	258541M91	8001128800	IS164	8001138900	0010945204	8001238500	20063	8001224800
1055494M91	8001222600	273572M91	8001224400	IS166	8001223500	0010947904	8001223500	20064	8001687300
1062501M91	8001194200	273743M91	8001226500	IS177	8001238500	0010947904	8001223500	MITSUBISHI	
1070329M91	8001105600	2874126M1	8001225100	IS187	8001228300	0010948004	8001687300	38610107	8001167500
1073508M91	8001222600	2874154M1	8001138900	IS190	8001224200	0010948204	8001223100	3003083100	8001139100
1089774M91	8001224500	2874165M1	8001687300	IS207	8001121100	0010949604	8001298000	3003084100	8001130800
1089937M91	8001225400	2874186M1	8001139100	IS214	8001238600	0020940004	8001238500	3003084200	8001131700
1090109M91	8001138900	2879154M1	8001138900	IS248	8001239700	0020943304	8001648700	3063056800	8001110600
1090110M91	8001139100	3072893M1	8001128800	IS75	8001266000	0020943404	8001223100	3113002900	8001130800
1093682M91	8001128800	3074305M1	8001227600	IS91	8001282600	0020946004	8001238600	3113016400	8001138900
1093683M91	8001131600	3074307M1	8001226500	MATBRO		0020946104	8001353000	3123002112	8001130800
1093683M92	8001131600	3074308M1	8001131700	31020/003	8001111000	0020947004	8001280900	3123002900	8001130800
1093686M91	8001131600	3252001M1	8001648800	P14314/1	8001100300	0020949204	8601569000	3123012700	8001224500
1096416M91	8001225300	3281825M1	8001167500	P7271/1	8001110600	0020949304	8601569300	3123080500	8001225400
1096417M91	8001225200	3310354M1	8001204800	MC CORMICK		0020949404	8601569000	3123084800	8001224500
1096475M91	8001226500	3310355M1	8001193500	248124A1	8601618500	0030943904	8001178900	3193035100	8001225100
1420740M91	8001128800	3310357M1	8001204800	MEADOWS		0030946004	8001410700	3214304100	8001138900
1428739M91	8001129500	3310358M1	8001188000	15A339	8001110600	0030947504	8601569900	3214305300	8001225400
1428745M91	8001130800	3385733M1	8001423700	15A739	8001110600	0090940502	8001227800	3214306500	8001139100
1428747M91	8001131700	3388840M2	8601589100	15H665	8001110600	0120948702	8001223500	3214306800	8001130800
1428748M91	8001128800	3389792M2	8001279400	15H668	8001110600	0130941702	8001224200	3453001030	8001227400
1429717M91	8001130800	3438717M1	8001434300	MELROE		0130941802	8001238500	3453002300	8001227400
1429718M91	8001131700	3580723M1	8001279400	6646494	8001110600	MERCUISER		4574070210	8001221400
1433650M92	8001131600	3595519M1	8001204800	6666376	8001427000	15A339	8001110600	4722012012	8001138900

MFRS Cod.	VIRGIS Cod.	MFRS Cod.	VIRGIS Cod.	MFRS Cod.	VIRGIS Cod.	MFRS Cod.	VIRGIS Cod.	MFRS Cod.	VIRGIS Cod.
4722012820	8001139100	EFA264	8001138900	FA648	8001227300	2258	8001723000	6467	8001222900
4722022810	8001225400	EFA300	8001110600	FA663	8001131500	2259	8001723200	6487	8001222800
4722022820	8001224500	EFA304	8001223100	FA735	8001315700	2276	8001110600	6496	8001271600
4722024800	8001224500	EFA306	8001128800	FA738	8001224400	2321	8001128800	6498	8001249100
5240200100	8001227400	EFA307	8001298000	FA740	8601567700	2334	8001221400	6502	8001472200
6060800800	8001224500	EFA308	8001238600	FA756	8001707000	2335	8001315600	6504	8001433400
6190800100	8001225400	EFA309	8001224400	FA805	8001707500	2336	8001314100	6510	8001222500
6260800200	8001224500	EFA311	8001238500	FA810	8001128800	2489	8001146700	6515	8001238600
6432010415	8001227400	EFA315	8001224200	FA816	8001146700	2503	8001222100	6517	8001341000
6660201800	8001130800	EFA316	8001224800	FA822	8001473300	2518	8001473300	6522	8001131600
6660203700	8001131700	EFA317	8001225100	FA837	8001105600	2522	8001224400	6525	8001353100
9126100700	8001110600	EFA318	8001687300	FA90	8001224500	2595	8601567700	6526	8001194100
9126110110	8001110600	EFA319	8001223500	FA931	8001434300	2608	8001223500	6532	8001353000
9146100500	8001110600	EFA320	8001223800	FA954	8001110600	2609	8001352900	6534	8001286700
34102111120	8001139100	EFA321	8001266000	FA991	8001167500	2630	8001217700	6537	8001222800
34102111140	8001138900	EFA327	8001224500	MOTORI VM		2631	8001105600	6538	8001222900
47722012810	8001138900	EFA328	8001227800	4113006	8001128800	2632	8001222600	6541	8001224200
91261007000	8001110600	EFA329	8001228300	4113007	8001130800	2645	8001167500	6547	8001228300
3453002300E	8001227400	EFA330	8001121100	4113008	8001129500	2656	8001335600	6554	8001238500
AE063150	8001224500	EFA333	8601568000	4113009	8001131500	2657	8001335700	6560	8001226500
AE063155	8001225400	FA1010	8001111000	4113026	8001131600	2679	8001131500	6569	8001441300
MD620563	8001421100	FA1013	8001341000	4113027	8001131700	2710	8001283900	6580	8601409000
ME063874	8001224500	FA130	8001225100	4113705	8001224500	2769	8001434300	6594	8001223400
ME063879	8001130800	FA132	8001110600	MOXY		2868	8001128800	6606	8001129500
MM510109	8001167500	FA137	8001315000	151570	8001225400	2918	8001410400	6613	8001327000
MZ311786	8001421100	FA138	8001221400	151571	8001224500	2919	8001130800	6625	8001194200
MOHAWK MFG.		FA139	8001315600	MURPHY		2920	8001131700	6642	8001227600
86083044001	8001223400	FA157	8001167500	MD3882	8001138900	2921	8001239500	6643	8001131700
MOPAR		FA158	8001139100	MD3883	8001139100	2924	8001139100	6652	8001407400
L151	8601409000	FA176	8001128800	MDA3823	8001225100	2927	8001226900	6741	8001227800
L422	8001225100	FA185	8001225400	MUSTANG MFG.CO.		5295	8001227300	6868	8001102000
MORBARK		FA186	8001220200	42034599	8001146700	6210	8001284700	7048	8001225200
29234527	8001473300	FA188	8001138900	42035886	8001427000	6263	8001498000	7052	8001225300
29321022	8001111000	FA190	8001227400	NAPA		6270	8001167500	NATIONAL MINE	
29321211	8001225200	FA211	8001239500	2042	8601409000	6294	8001209100	64071475	8001225100
29321212	8001225300	FA232	8001222100	2046	8001315000	6304	8001220200	NELSON/WINSLOW	
29321218	8001131600	FA233	8001131700	2048	8001315700	6313	8001239700	70070	8001138900
29321219	8001128800	FA235	8001226900	2119	8001138900	6330	8001228500	70077	8001335600
29321255	8001723000	FA270	8001410400	2123	8001220200	6352	8001240300	70098	8001167500
29321256	8001723200	FA296	8001227300	2142	8001100300	6360	8001110600	70293	8001473300
MOTOR COACH		FA525	8001315700	2208	8001224500	6375	8001111000	70333	8001131600
9C3107	8001224300	FA564	8001130800	2209	8001225400	6378	8001260500	70334	8001128800
MOTORCRAFT		FA565	8001138900	2225	8001227300	6407	8001471500	70367	8001131500
EFA120	8001134800	FA616	8001314100	2226	8001227400	6408	8001248500	101237	8001225100
EFA152	8001134800	FA619	8001217700	2237	8001225100	6414	8001224800	101275	8001110600
EFA228	8001239700	FA631	8001335600	2238	8001707000	6430	8001223100	106587	8001138900
EFA234	8001138900	FA632	8001335700	2239	8001707500	6466	8001222800	106769	8001224500

MFRS Cod.	VIRGIS Cod.	MFRS Cod.	VIRGIS Cod.	MFRS Cod.	VIRGIS Cod.	MFRS Cod.	VIRGIS Cod.	MFRS Cod.	VIRGIS Cod.
106775	8001225400	70237N	8001224500	84700S	8001687300	614104	8001335700	47565055	8601834700
106834	8001139100	70250N	8001146700	84713S	8001228500	922214	8601568800	47675769	8601838700
107868	8001128800	70251N	8001315600	84714S	8001222500	1909116	8001222800	47688952	8601849800
108668	8001130800	70252N	8001315000	84718S	8001102000	1930138	8001453300	47744116	8601853600
108674	8001131700	70259N	8001314100	84723S	8001723200	1930174	8001134300	47744117	8601853700
109085	8001227400	70269N	8001225400	84724S	8001121100	1930349	8001438000	47807838	8601929300
109200	8001226900	70293N	8001473300	84730S	8001275200	9702158	8001473300	47807844	8601920700
113538	8001473300	70301N	8001130800	84766S	8001167500	9811231	8001352800	47808599	8601862100
114747	8001222100	70302N	8001224400	84824S	8001128800	79043778	8001138900	51485094	8601907100
117781	8001707500	70333N	8001131600	84826S	8001224400	80748274	8001227800	82014790	8601738300
118216	8001335700	70334N	8001128800	84864S	8001278100	81868102	8601570100	82034662	8601701400
119410	8001131600	70338N	8001131600	84874S	8001223400	81869555	8001471500	84135146	8601756100
119538	8001473300	70344N	8001434300	84877S	8001298000	82001780	8001709200	84189518	8601756200
120281	8001146700	70367N	8001131500	84878S	8001227800	82001820	8001710300	84219716	8601757100
128407	8001723000	70410N	8001226500	84880S	8001223800	82003726	8001472200	84280229	8601761100
130771	8001410400	70413N	8001221400	84894S	8001341000	82003739	8001471500	84391298	8601775700
131346	8001105600	70415N	8001315700	84902S	8001286700	82004413	8001709200	84443965	8001930500
131350	8001131700	70482N	8001220200	84905S	8001222600	82008597	8001709200	84518807	8601783800
145700	8001224500	70497N	8001341000	84906S	8001353100	82008600	8001472200	84524327	8601793300
251285	8001315700	70515N	8001111000	84907S	8001352700	82008601	8001471500	84524358	8601793500
251286	8001315600	70517N	8001222600	84908S	8001353000	82008607	8001710300	84524359	8601793400
251287	8001315000	70530N	8001249100	84909S	8001352900	82011402	8001472200	84571033	8601806300
4M9334	8001221400	70595S	8001134800	84925S	8001125200	82034441	8001710300	84572478	8601806400
4N0015	8601409000	70597S	8001283900	84966S	8001239500	82981152	8001736500	87309516	8601701600
6L4714	8601567700	70603S	8601567700	84975S	8001217700	84030107	8001629400	87311194	8601703600
70060N	8001226900	70604S	8001223100	84982S	8001266000	86504143	8001434300	87385322	8601701200
70063N	8001224500	70605S	8001209100	84983S	8001238500	86519866	8001588700	87726675	8601701300
70067N	8001139100	70609S	8001226500	84988S	8601568000	86529587	8001222800	87726699	8601705200
70070N	8001138900	70611S	8001222800	84990S	8001224800	89811231	8001352800	944032451	8601756900
70077N	8001335600	70612S	8001222900	84991S	8001238600	89835746	8001747000	360260A2	8601847400
70098N	8001167500	70615N	8001131500	84992S	8001223500	151849501	8001125500	NIPPON	
70101N	8001139100	70617N	8001146700	84994S	8001265300	151849502	8001126900	AC7473	8001130800
70102N	8001128800	70627N	8001240300	84996S	8001239700	NEW HOLLAND (CNH)		AC74735	8001130800
70104N	8001131700	70819N	8001239500	84999S	8001224200	5097838	8601753400	AC7473S	8001130800
70108N	8001222100	70831N	8001227600	959972	8001314100	44911740	8601721700	AC7486	8001224500
70113N	8001227400	70868N	8001260500	W6L4714	8601567700	47129095	8601716400	AF2771	8001227300
70114N	8001227300	70903N	8001248500	NEM		47129134	8601716500	NISSAN	
70121N	8001707500	70954N	8001588700	NE6003	8001224500	47131906	8601715900	1650696015	8001130800
70125N	8001707000	83627A	8601567700	NE625S	8001130800	47131907	8601716800	1654625004	8001130800
70129N	8001335700	83627N	8601567700	NEUSON		47131908	8601716700	1654686017	8001224500
70172N	8001723000	83722N	8001284700	1211071	8001167500	47131909	8601716600	1654690204	8001227400
70181N	8001225100	83893N	8601409000	4505514	8001434300	47133993	8601717000	1654695001	8001225100
70189N	8001410400	84611S	8001220200	5005004	8001110600	47360660	8601800500	1654695003	8001225100
70194N	8001105600	84655S	8001335600	5005028	8001498000	47404997	8601811500	1654695010	8001226500
70203N	8001131700	84682S	8001129500	NEW HOLLAND		47405000	8601811600	1654696003	8001130800
70206N	8001110600	84698S	8001228300	59133	8001473300	47409571	8601812100	1654696010	8001139100
70226C	8001110600	84699S	8001282600	614103	8001335600	47564223	8601832700	1654696011	8001138900

MFRS Cod.	VIRGIS Cod.	MFRS Cod.	VIRGIS Cod.	MFRS Cod.	VIRGIS Cod.	MFRS Cod.	VIRGIS Cod.	MFRS Cod.	VIRGIS Cod.
1654696014	8001225400	140P842	8001167500	1416434	8001352700	1DX88	8001225300	AI3284	8001238600
1654696015	8001130800	ONAN HOUSINGS		1426098	8001227600	OTIS MATL HANDLING		AI329708	8001222100
1654696016	8001138900	140P1248	8001167500	1447316	8001121100	13943951	8001110600	AI3298	8001131600
1654696026	8001130800	ORENSTEIN & KOPPEL		1448081	8001128800	14279911	8001224300	AI3301	8001224200
1654696027	8001138900	101158	8001307400	1448534	8001224500	9033AX1	8001224300	AI3302	8001238500
1654696028	8001130800	101212	8001194200	1448535	8001225300	9033AY1	8001110600	AI3303	8001223500
1654696029	8001138900	124909	8001130800	1448989	8001110600	A50991	8001167500	AI3307	8001223100
1654696060	8001225100	145142	8601409000	1449409	8001315700	OWATONNA		AI330908	8001105600
1654696125	8001224500	178637	8001224500	1449410	8001110900	4201815	8001110600	AI3315	8001227600
1654697009	8001138900	178638	8001225400	1449429	8001648700	4201923	8001110600	AI3316	8001222500
1654697015	8001138900	202550	8001131700	1449527	8001224500	4202127	8001110600	AI3328	8001687300
1654699015	8001227400	202551	8001130800	1449640	8001295300	42018158	8001110600	AI3332	8001353100
1654699204	8001110900	243153	8001110600	1450231	8001224400	42018567	8001110600	AI3333	8001352700
1654602K00	8001287000	440337	8001224500	1450585	8001221400	42019238	8001110600	AI333608	8001224400
165461G000	8001364400	490238	8001129500	1450586	8001315600	42031932	8001167500	AI3350	8001226500
16546Z5003	8001239500	490328	8001129500	1451794	8001239500	P & H HARNISCHFEGER		AI3352	8001239700
16546Z5004	8001130800	524658	8001167500	1454260	8001225400	1046Z283	8001138900	AI3357	8001353000
16546Z5025	8001130800	524685	8001225100	1455283	8001260400	1046Z329	8001224500	AI3358	8001227800
16546Z5026	8001130800	576975	8001131500	1455327	8001260500	1046Z335	8001130800	AI3358	8001227800
NKK		576977	8001131500	1463932	8001314100	1046Z378	8001224400	AI3359	8001352800
4F1007F	8001130800	583135	8001224400	1471158	8001629400	221046Z38	8001224500	AI3361	8001648700
4ID1008F	8001225100	583136	8001226500	1471159	8001630100	221046Z39	8001225400	AI3363	8001648800
OM		583226	8001298000	1476636	8001490000	221046Z48	8001224500	AI3369	8001260400
9819406	8001110600	589562	8001225100	1499654	8001352800	221046Z5	8001238500	AI3370	8001260500
OMNI EQUIPMENT		599753	8001226900	1499655	8001222600	221046Z6	8001224200	AI3373	8001178900
3633631	8001228500	599756	8001226900	1499661	8001648800	46Z166	8001225100	AI3381	8001121100
9931106	8001239700	718023	8001138900	1499695	8001227800	P.B.R.		AI3394	8001238700
ONAN		718024	8001139100	1499704	8001266000	AC3284	8001238600	AI341008	8001194100
1400765	8001110600	718057	8001131600	1499708	8001223800	AI3003	8601567700	AI344608	8001421100
1401248	8001167500	718058	8001128800	1499709	8001687300	AI3203	8001221400	AI3679	8001438700
1401251	8001167500	718059	8001131600	1499714	8001227800	AI3206	8001315600	AI5109	8601569000
1401540	8001473300	744821	8001238600	1499743	8001222100	AI3207	8001315700	AI5169	8601569300
1401617	8001130800	762792	8001222500	1499747	8001228500	AI3215	8001315000	AL3359	8001352800
1401618	8001131700	765568	8001239700	1499752	8001105600	AI3221	8001138900	AL3361	8001648700
1401619	8001128800	765821	8001353000	1499756	8001209100	AI3233	8001314100	AL3363	8001648800
1401620	8001131600	773604	8001353100	2271979	8001441000	AI3237	8001298000	PACCAR	
1401621	8001224400	773605	8001238500	2271980	8001441300	AI3239	8001224500	Y05753412	8001138900
1401622	8001226500	776604	8001353100	2292386	8001239500	AI3240	8001225400	Y05753510	8001224500
1401851	8001146700	788422	8001223500	2292387	8001445500	AI3246	8001224300	Y05754209	8001225300
1402328	8001167500	917275	8001648700	8003742	8001353000	AI324708	8001225100	PANCLEAN	
1402762	8001286700	917276	8001223100	8003751	8001223500	AI3273	8001128800	AP8181	8601986400
1403119	8001605000	933360	8001223100	8005628	8001283900	AI327408	8001129500	AX6254	8601990400
1852090	8001167500	966360	8001223100	8005814	8001353100	AI327608	8001130800	AX7228	8601984500
140P1002	8601409000	1102149	8001128800	8006605	8001238500	AI3277	8001131700	AX8194	8601985400
140P1251	8001167500	1408296	8001227300	8406317	8001238600	AI3279	8001110600	AX9294	8601982500
140P721	8001110600	1408297	8001227400	OSHKOSH		AI327908	8001110600	AXH1021	8601981000
140P765	8001110600	1415870	8001352900	1DX31	8001225100	AI3282	8001282600	AXH1080	8601871900

MFRS Cod. VIRGIS Cod.	MFRS Cod. VIRGIS Cod.	MFRS Cod. VIRGIS Cod.	MFRS Cod. VIRGIS Cod.	MFRS Cod. VIRGIS Cod.	
PANHARD		26510343 8001441300	FA1433 8001388900	PAK988 8001128800	
431455 8001193500	26510353 8001692800	FA1456 8001319000	PAK992 8001130800	040907 8001288800	
PATAPSCO & BACK RIVERS RR		26510354 8001692800	FA1462 8001393900	PETTIBONE-MULLIKEN	
0607B0102 8001110600	26510362 8001440900	FA1566 8001530400	2813P 8001224300	041327 8001110600	041430 8001223500
PEERLESS		26510380 8001890500	FA1569 8001529400	A2318014 8001224300	041500 8001227800
300521402 8001138900	197946201 8001687300	FA3107 8001410700	A2318018 8001225100	POCLAIN	
PEGASO		24811/2 8001226500	FA3113 8001280900	A2318023 8001224300	150549 8001225100
173260 8001410700	6LS551A/4 8001223500	FA3116 8001209300	CM921 8001224300	250566 8001131500	250567 8001129500
190537 8001238500	CV20948 8001668900	FA3121 8001376300	CM94 8001110600	250590 8001223100	250591 8001238500
197588 8001227800	P102913 8001131600	FA3127 8001110600	EMP67 8001110600	450543 8001227600	850501 8001226500
197589 8001352800	PF60011 8001110600	FA3131 8001129500	LL847144 8001224500	850561 8001138900	850562 8001139100
534478 8001238600	PF60053 8001225100	FA3132 8001282500	LL84743 8001225100	850568 8001227300	850569 8001227400
584576 8001223500	PF60999 8001418300	FA3141 8001249100	PIPERCROSS		
632114 8001224200	PI02619 8001123900	FA3147 8001352000	PX102 8001138900	1050506 8001707500	1050507 8001707000
634478 8001238600	PI02620 8001139000	FA3150 8001248500	PX1030 8001222800	A0850528 8001225300	C1150531 8001110600
634479 8001223100	PI02673 8001131500	FA3153 8001121100	PX104 8001103800	E0250567 8001129500	E0250566 8001131500
645372 8001238500	PI02679 8001128800	FA3162 8001228300	PX105 8001110600	E0850568 8001227300	E1050506 8001707500
691030 8001224400	PI02688 8001131600	FA3192 8001131600	PX1052 8001648800	E1250560 8001221400	E2750574 8001352900
691031 8001226500	PI026880 8001131600	FA3193 8001131500	PX1053 8001648700	F0250566 8001131500	F0250590 8001223100
691351 8001238500	PI02689 8001226500	FA3301 8001298000	PX106 8001224200	F0250567 8001129500	F0850545 8001353100
698089 8001223500	PI02707 8001131700	FA3321 8001687300	PX109 8001224500	F0850568 8001227300	F1050507 8001707000
699435 8001352700	PI02871 8001155500	FA3839 8001282600	PX110 8001238500	F1250561 8001315600	G0250591 8001238500
760884 8001353100	PI02876 8001111700	FA4000 8001178900	PX112 8001225100	G0850546 8001648700	G0850569 8001227400
PEL-JOB		PI02912 8001111000	PX115 8001128800	H0850501 8001226500	H1010578 8001131700
E6050036 8001110600	PI02913 8001131600	FA4101 8601569000	PX118 8001282600	H1050578 8001131700	K1750562 8001227800
E7410157 8001167500	PI02914 8001110800	FA4102 8601569300	PX123 8001223500	L0350530 8001238500	M0850529 8001225200
E7415256 8001440900	PI02916 8001161800	PERRY			M0850551 8001226900
PERKINS		PI02917 8001193500	PA302 8601409000	M2150534 8001279800	N0850529 8001225200
26510143 8001110600	PI02924 8001139100	PA474 8001224300	PX124 8001121100	P2050509 8001221400	Q0150549 8001225100
26510154 8001138900	PI02927 8001105600	PA480 8001110600	PX127 8001221400		
26510192 8001110600	PI02928 8001222600	PA498 8001315000	PX134 8001687300		
26510208 8001130800	PI02929 8001204800	PA499 8001221400	PX140 8001227300		
26510211 8001100300	PI02930 8001188000	PA589 8001240300	PX142 8001228300		
26510214 8001128800	PI02931 8001407400	PA598 8001315700	PX144 8001130800		
26510228 8001131600	PI02932 8001427000	PA600 8001315600	PX149 8001224800		
26510229 8001128800	TX56178 8001224400	PA789 8001410400	PX158 8001275200		
26510230 8001139100	PERLINI				
26510231 8001129500	1000965 8001225400	PA835 8001224500	PX175 8001223400		
26510235 8001224400	1000967 8001224500	PA836 8001138900	PX859 8001298000		
26510238 8001224500	66002073 8001225100	PA972 8001227300	PX938 8001224500		
26510288 8001131600	350044AA 8001227800	PA975 8001220200	PLASTIC SYSTEMS		
26510289 8001224500	350087A 8001567300	PAK480 8001110600	31901069 8001757700		
26510306 8001445500	350088A 8001568100	PAK591 8001225100	31901070 8001757800		
26510313 8001239500	PERMATIC			31901071 8001757600	
26510337 8001407400	FA 3126 8001103800	PAK703 8001222100	31901072 8001757500		
26510338 8001427000	FA1371 8001250000	PAK705 8001128800	PNEUMOFOR		
26510342 8001736500	FA1372 8001227900	PAK826 8001222600	040428 8001298500		
		PAK827 8001146700	040436 8001239700		
		PAK925 8001335600	040659 8001223100		
		PAK939 8001105600	040741 8001238500		

MFRS Cod.	VIRGIS Cod.	MFRS Cod.	VIRGIS Cod.	MFRS Cod.	VIRGIS Cod.	MFRS Cod.	VIRGIS Cod.	MFRS Cod.	VIRGIS Cod.
Q0250599	8001224400	A786	8001266000	A22011	8001167500	A69334	8001221400	AF3028	8001224400
S0850510	8001128800	A793	8001687300	A27050	8601569300	A70014	8601567700	AF3029	8001226500
T1950555	8001193500	A795	8001298000	A27758	8001239700	A72921	8001707500	AF3031	8001131500
TI950555	8001193500	A797	8001223800	A32238	8001220200	A72922	8001707000	AF3098	8001648800
U0450543	8001227600	A799	8001224800	A34536	8001209100	A73162	8001335600	AF3100	8001353000
V0250550	8001131600	A800	8001282600	A40015	8601409000	A73163	8001335700	AF3101	8001353100
V0250581	8001131600	A801	8001223100	A42019	8001110600	A73498	8001223500	AF3102	8001352700
V0450443	8001227600	A802	8001121100	A42039	8001222100	A73502	8001723200	AF3103	8001352900
W0350586	8001223500	A807	8001209100	A42073	8001225100	A73536	8001723000	AF3104	8001352800
W0450544	8001131700	A813	8001227800	A42896	8001222600	AF14	8601567700	AF3116	8001222500
W2750544	8001352700	A814	8001353000	A43156	8001434300	AF2011	8001167500	AF3152	8001105600
X0850561	8001139100	A815	8001353100	A44548	8001240300	AF2011K	8001167500	AF3156	8001434300
Z0850562	8001138900	A821	8001222500	A52052	8001315700	AF2019	8001110600	AF3157	8001131700
POWER BOSS		A866	8001239700	A52053	8001315600	AF2019K	8001110600	AF3162	8001335600
302597	8001498000	A866PL	8001239700	A52220	8001138900	AF2039K	8001222100	AF3163	8001335700
302842	8001110600	A869	8001227400	A52266	8001139100	AF2040	8001224300	AF3314	8001239500
POWERPART		A871	8001228300	A52928	8001314100	AF2044K	8001128800	AF3346	8001217700
AM044901	8001225100	A873	8001131500	A53152	8001105600	AF2052	8001315700	AF3393	8001128800
AM044902	8601568000	A875	8001131700	A53511	8001111000	AF2053	8001315600	AF3425	8001280900
AM044906	8001283900	A876	8001227600	A53516	8001341000	AF2055	8001315000	AF3427	8001121100
PPM		A877	8001352700	A61568	8001224200	AF2073K	8001225100	AF3438	8601409000
C6150593	8001629400	A878	8001224400	A61605	8001238600	AF2140	8001224500	AF3459	8001131600
D6150594	8001630100	A879	8001228500	A62044	8001128800	AF2200	8001225400	AF3492	8001228300
L2650576	8001445500	A880	8001648700	A62055	8001315000	AF2202	8001226900	AF3498	8001223500
W0450543	8001227600	A883	8001105600	A62200	8001225400	AF2204K	8001130800	AF3502	8001723200
PRINS MOTOREN		A884	8001222600	A62202	8001226900	AF2206	8001227400	AF3511	8001111000
P101540111080	8001110600	A886	8001238700	A62204	8001130800	AF2220	8001138900	AF3516	8001341000
P101560611080	8001103800	A890	8001352900	A62206	8001227400	AF2220H	8001138900	AF3519	8001238500
P101574111080	8001271600	A906	8001388900	A62221	8001224500	AF2221	8001224500	AF3536	8001723000
PURFLUX		A914	8001167500	A62222	8001227300	AF2222	8001227300	AF3537	8001228500
A287	8001530000	A916	8001315000	A62973	8001146700	AF2238K	8001220200	AF4428	8001286700
A473	8001393900	A920	8001314100	A62974	8001473300	AF2255	8001410400	AF4536	8001209100
A537	8001225100	A923	8001221400	A63028	8001224400	AF2256	8001131700	AF4548	8001240300
A540	8001110600	A948	8001223400	A63029	8001226500	AF2266	8001139100	AF4551	8001222500
A542	8001224500	A949	8001130800	A63031	8001131500	AF2266H	8001139100	AF4559	8001227600
A543	8001138900	A956	8001280900	A63101	8001353100	AF2269	8001224500	AF4560	8001131700
A544	8001225300	A969	8001530400	A63102	8001352700	AF2896	8001222600	AF9334	8001221400
A545	8001129500	A970	8001250700	A63157	8001131700	AF2908	8001131500	AFP15	8601409000
A546	8001128800	A971	8001529400	A63314	8001239500	AF2909	8001129500	AM1139	8001131500
A550	8001225400	PUROLATOR		A63393	8001128800	AF2915	8001110600	LI2695	8001134800
A551	8001139100	6675974	8001225100	A63438	8601409000	AF2918	8001314100	LX84	8001121100
A552	8001131600	6678200	8001138900	A63459	8001131600	AF2921	8001707500	MF192A	8001217700
A598	8001238600	6678201	8001224500	A63519	8001238500	AF2922	8001707000	MF500A	8001217700
A599	8001238500	6696758	8001707000	A64428	8001286700	AF2928	8001314100	MF700A	8001138900
A600	8001224200	9304811	8001221400	A64551	8001222500	AF2952	8001335700	MF706A	8001266000
A602	8001223500	A11042	8001295300	A64559	8001227600	AF2973	8001146700	MF713A	8001265300
A784	8001217700	A13346	8001217700	A64560	8001131700	AF2974	8001473300	MF839A	8001223500

MFRS Cod.	VIRGIS Cod.	MFRS Cod.	VIRGIS Cod.	MFRS Cod.	VIRGIS Cod.	MFRS Cod.	VIRGIS Cod.	MFRS Cod.	VIRGIS Cod.
MF860K	8001128800	QSA1569SY	8001335700	7701025065	8001648800	5000783932	8001224200	003563608	8001223500
MFP191A	8001283900	QSA226	8001221400	RENAULT V.I.		5000802977	8001353100	003563616	8001239700
MFP192A	8001217700	QSA226SY	8001314100	3563021	8001227800	5000802978	8001352700	003564001	8001225100
PEA526	8001265300	QSA234	8001315000	3563512	8001238500	5000806317	8001227800	003564024	8001110600
PEA559	8001139100	QSA236	8001315600	3563513	8001223500	5000806377	8001227800	003564105	8001128800
PM1042	8001295300	QSA237	8001315700	3563565	8001238600	5000814797	8001556500	003564106	8001131600
PM1073	8001209100	QSA3307	8001284700	3563570	8001223100	5000814798	8001560400	003564115	8001139100
PM1102	8001139100	QSA507	8001224500	3563592	8001298000	5000814947	8001319000	003564117	8001138900
PM1123	8001131600	QSA507SY	8001225400	3563595	8001224200	5000814950	8001393900	003564118	8001224500
PM1139	8001131500	QSA523	8001138900	3563608	8001223500	5000814957	8001388900	003564120	8001224500
PM1141	8001131600	QSA523SY	8001139100	3563616	8001239700	5000819339	8001138900	003564125	8001130800
PM1568	8001224200	QSA535	8001227300	3564001	8001225100	5000819340	8001224500	003564126	8001131700
PM1574	8001224800	QSA535SY	8001227400	3564024	8001110600	5000819341	8001225100	003564127	8001131700
PM1588	8001266000	QSA546SY	8001131700	3564105	8001128800	5001829572	8001223500	003564137	8001225300
PM1605	8001238600	QSA563	8001226900	3564106	8001131600	5001834600	8001530000	004207090	8001238600
PM1621	8001223400	QSA586	8001410400	3564115	8001139100	5001836978	8001529400	004212747	8001238500
PM1623	8001687300	QSAK1531	8001146700	3564117	8001138900	5010064371	8001530400	004212748	8001224200
PM1627	8001298000	QSAK1544	8001128800	3564118	8001224500	5010064372	8001250700	004214189	8001224200
PM1709	8001238500	QSAK1563	8001110600	3564119	8001225400	5010066304	8001530000	004214313	8001238500
PM175	8001223500	QSAK255	8001225100	3564120	8001224500	5010066387	8001225200	004214314	8001224200
PM1750	8001223500	QSAK256	8001110600	3564125	8001130800	5010094092	8001529400	0060377200	8001238500
PM1758	8001239700	QSAK510	8001222100	3564126	8001131700	5010094094	8001530400	REXNORD	
PM1760	8001227800	QSAK530	8001167500	3564127	8001131700	5010094144	8001224200	10281780	8001224300
PM1761	8001223800	QSAK546	8001130800	3564137	8001225300	5010094145	8001250700	102817801	8001224300
PM1762	8001223100	QSAK553	8001220200	3564138	8001225400	5010094146	8001529400	1021006610	8001225300
PM2080	8001128800	QSAK565	8001128800	4207090	8001238600	5010094154	8001530400	1021006611	8001225200
QIF-AIR		RAYGO		4212747	8001238500	5010140505	8001238600	REYTOR	
ACA226	8001221400	205747	8001225100	4212748	8001224200	5010230841	8001652300	IT100853	8001473300
ACA226SY	8001314100	216921	8001226900	4214189	8001224200	5010305203	8001530400	IT101222	8001103800
ACA234	8001315000	1340013	8001110600	4214313	8001238500	7701019017	8001238600	IT101246	8001100300
ACA236	8001315600	13420020	8001110600	4214314	8001224200	7701019018	8001353000	IT101275	8001110600
ACA237	8001315700	13420052	8001224300	4214489	8001224200	7701021498	8001353100	IT106587	8001138900
ACA507SY	8001225400	67000024	8001224500	4309015	8001238600	7701027436	8001250000	IT106641	8001225200
ACA510	8001222100	67000037	8001110600	22004800	8001224200	7701027437	8001227900	IT106769	8001224500
ACA523SY	8001139100	67000043	8001224500	22860400	8001223500	0003563021	8001227800	IT106775	8001225400
ACA546	8001130800	221688A	8001146700	24551160	8001238600	0003563592	8001298000	IT106834	8001139100
AP117433	8001226900	READY-POWER		24551184	8001238500	0003564119	8001225400	IT108674	8001131700
AP117435	8001227300	602450	8001110600	60377200	8001238500	0003564138	8001225400	IT109085	8001227400
AP117437	8001224500	5500416	8001224300	500241796	8001238500	0004214489	8001224200	IT109086	8001227300
AP117439	8001138900	5500560	8001139100	500242503	8001224200	0004309015	8001238600	IT109200	8001226900
AP117782	8001707000	5500611	8001110600	4033109540	8001298000	0022004800	8001224200	IT1113	8001221400
AP119363	8001128800	6024501	8001110600	5000241756	8001238500	0022860400	8001223500	IT114500	8001131500
AP128407	8001723000	RQ34083	8001110600	5000241796	8001238500	0024551184	8001238500	IT117781	8001707500
QUAKER STATE		REDDOT		5000242503	8001224200	003563512	8001238500	IT117782	8001707000
QSA1543SY	8001131500	RD-3-12486-0	RD-3-12486-0	5000242504	8001223500	003563513	8001223500	IT118211	8001335600
QSA1544SY	8001131600	RD-5-11989-0	RD-5-11989-0	5000751590	8001250700	003563570	8001223100	IT118216	8001335700
QSA1569	8001335600	RENAULT AGRICULTURE		5000751674	8001529400	003563595	8001224200	IT120022	8001224400

MFRS Cod.	VIRGIS Cod.	MFRS Cod.	VIRGIS Cod.	MFRS Cod.	VIRGIS Cod.	MFRS Cod.	VIRGIS Cod.	MFRS Cod.	VIRGIS Cod.
IT128407	8001723000	R9601S	8001352700	HDA5395	8001707500	51021000	8001167500	SAURER	
IT128408	8001723200	RYCO		HDA5396	8001707000	55010001	8001194100	4631072	8001238500
IT712	8001315700	A201	8001217700	HDA5402	8001335600	10050521E	8001307400	4631072000	8001224200
IT713	8001315600	A209	8001209100	HDA5403	8001335700	10050530L	8001194200	4631072010	8001687300
IT9972	8001314100	A26	8001134800	HDA5409	8001129500	SAME		4631072020	8001224200
RICHIER		A264	8001209100	HDA5414	8001131600	242292001	8001307400	SAVARA	
556012165	8001224400	A48	8001283900	HDA5415	8001473300	242490101	8001167500	923518	8001352900
556012179	8001131500	HDA5050	8001167500	HDA5417	8001130800	242490106	8001167500	923539	8001134300
556012181	8001128800	HDA5061	8001110600	HDA5418	8001105600	242490401	8001129500	923677	8001352700
556012182	8001128800	HDA5109	8001315700	HDA5419	8001222600	242490501	8001220200	92028217	8001315700
556012183	8001131600	HDA5110	8001315600	HDA5420	8001226500	242490504	8001222600	92213717	8001134800
556012184	8001129500	HDA5111	8001315000	HDA5422	8001224400	242490601	8001129500	92286117	8001217700
556012185	8001224400	HDA5119	8001130800	HDA5426	8001146700	242490608	8001129500	92289717	8001131700
556012186	8001226500	HDA5132	8001225100	HDA5427	8001341000	242490702	8001131500	92290117	8001221400
556012187	8001128800	HDA5157	8001221400	HDA5442	8001110600	242490704	8001131500	92290317	8001225400
556012189	8001128800	HDA5162	8001239700	HDA5447	8001434300	242490801	8001105600	92290617	8001224500
556012190	8001131600	HDA5183	8001223100	HDA5450	8601409000	242490802	8001222600	92294417	8001110600
556012193	8001225100	HDA5192	8001222500	HDA5459	8001222800	242491101	8001222100	92294617	8001167500
556012197	8001110600	HDA5193	8001209100	HDA5465	8001131700	242491102	8001222100	92295017	8001138900
556012198	8001131700	HDA5194	8001298000	HDA5488	8001227600	242491300	8001128800	92295117	8001139100
556012199	8001130800	HDA5202	8001224800	HDA5490	8001222800	242491301	8001128800	92300217	8601409000
597033071	8001224400	HDA5206	8001687300	HDA5493	8001723000	242491302	8001131600	92303317	8001315000
ROLLS ROYCE		HDA5207	8001223500	HDA5494	8001723200	242491307	8001131600	92303517	8001315600
CV4170	8001224500	HDA5210	8001224500	HDA5507	8001111000	242491308	8001128800	92303617	8001315700
CV4180	8001138900	HDA5212	8001121100	HDA5526	8001353000	242491309	8001131600	92304817	8001225100
CV507	8001530000	HDA5232	8001286700	HDA5527	8001353100	242491310	8001193500	92311317	8001222100
CV9685	8001530000	HDA5246	8001314100	HDA5528	8001352700	242491706	8001105600	92313017	8001227300
OE45176	8001130800	HDA5272	8001228300	HDA5588	8001228500	242491901	8001220200	92313117	8001227400
UE5801	8001217700	HDA5281	8001225100	HDA5623	8001222500	242492501	8001220500	92315117	8001226900
UE9813	8001217700	HDA5285	8001100300	HDA5664	8001129500	242492801	8001131700	92316917	8001283900
ROMA		HDA5286	8001110600	HDA5666	8001103800	242492803	8001227600	92323717	8001266000
R1050	8001227800	HDA5292	8001167500	HDA5711	8001223800	242492901	8001222800	92324317	8001209100
R1096S	8001131700	HDA5305	8001222100	HDA5741	8001284700	242493104	8001193500	92324417	8601567700
R3005	8001139100	HDA5308	8001128800	HDA5757	8001227800	242493401	8001229000	92324517	8601568000
R517	8001223500	HDA5317	8001138900	HDA5760	8001277000	242493402	8001411300	92333217	8001131600
R517S	8001352900	HDA5321	8001224500	SAKAI		242493601	8001138900	92336217	8001130800
R5386	8001228300	HDA5322	8001225400	440414002	8001131700	242493801	8001279800	92336317	8001128800
R637	8001224500	HDA5323	8001139100	440414003	8001130800	242493802	8001239500	92340417	8001223500
R637S	8001225400	HDA5327	8001130800	SAMBRON		242495001	8001105600	92341617	8001227800
R6460	8001298000	HDA5328	8001131700	24999	8001110900	242495002	8001222600	92342017	8001238500
R650	8001687300	HDA5330	8001220200	63494	8001486500	SAMSUNG		92344600	8001224200
R797	8001238600	HDA5334	8001227400	393199	8001238600	991240800	8001239500	92344617	8001224200
R804	8001223100	HDA5335	8001227300	539536	8001131500	991245700	8001138900	92346717	8001238600
R8047S	8001315700	HDA5338	8001226900	618074	8001204800	991245800	8001139100	92347117	8001223800
R918	8001110600	HDA5357	8001239500	634972	8001427000	SANDERSON		92351817	8001352900
R930S	8001648800	HDA5364	8001131500	664482	8001736500	ABP3001567	8001286700	92367617	8001223100
R940S	8001353100	HDA5367	8001222100	664490	8001441300	ABP3001571	8001111000	92371117	8001227800

MFRS Cod.	VIRGIS Cod.	MFRS Cod.	VIRGIS Cod.	MFRS Cod.	VIRGIS Cod.	MFRS Cod.	VIRGIS Cod.	MFRS Cod.	VIRGIS Cod.
92384317	8001376300	STRCOUH-378	8001224300	124817	8001131600	FCA3285	8001249800	61200190037	8001238500
SA919	8001438700	SEDDON-ATKINSON		124902	8001226500	FCA3287	8001125200	99000190075	8001224200
SAXBY- TRACMA		42391/1	8001138900	125001	8001123900	FCA3306	8001131700	99000190137	8001223500
25722360	8001110600	43327/1	8001225100	125201	8001139000	FCA3307	8001129500	99000190701	8001238500
903011790	8001110600	47426/1	8001224500	125202	8001139100	FCA3308	8001227600	99000190702	8001224200
E70154329	8001529400	SEDEMS		125602	8001225200	FCA3309	8001131500	99012190030	8001352900
E70154330	8001250700	S010042783	8001193500	126101	8001209100	FCA3310	8001226500	99012190037	8001223500
E70210046	8001128800	SEMAT		126201	8001228500	FCA3311	8001209100	99012190137	8001223500
E70210052	8001110600	20223	8001307500	126701	8001327000	FCA3312	8001222500	99012190196	8001352700
E70210066	8001131500	197501139	8001110600	126705	8001194100	FCA3313	8001226900	99012190701	8001224200
E70210067	8001129500	IH20223	8001307500	126706	8001327000	FCA3315	8001224400	99012190705	8001223500
E70210071	8001128800	SIAC		127002	8001130800	FCA3321	8001352700	99014190033	8001227800
E70210077	8001128800	541322150	8601836400	127012	8001225100	FCA3322	8001225400	99112190030	8001352900
E70210078	8001131600	SICARD		127013	8001138900	FDA3105	8001221400	99112190705	8001223500
E70211103	8001130800	461253	8001225100	127022	8001130800	FDA3106	8001315600	99114190025	8001352800
E70211401	8001131700	SIFO		127202	8001138900	FDA3110	8001315000	559000710020	8001687300
E70211703	8001138900	130022	8001110600	127222	8001138900	FDA3117	8001315700	STIHL	
E70211803	8001224400	192003	8001167500	127622	8001225300	FDA3140	8001238500	42011410300	8001295300
E70211804	8001226500	1205013	8001167500	12360700	8001382400	FDA3142	8001224800	42011410303	8001295300
E70211902	8001225400	SISU		12366643	8001188000	FDA3143	8001687300	42231410300	8601585700
E70211905	8001224500	1263400241	8001687300	12370107	8001486500	FDA3144	8001223800	STILL	
E70212061	8001129500	1293400332	8001723000	12380700	8001381100	FDA3156	8001238600	141790	8001239700
SCANIA		1293400342	8001723200	12382707	8001381800	FDA3260	8001224200	SULLAIR	
211589	8001687300	1293400401	8001530000	12460700	8001555700	FDA3261	8001223100	1144	8001238500
217517	8001223500	SOFILTRA		12470107	8001427000	FDA3263	8001223500	41120	8001227400
218989	8001238500	123501	8001110600	12480700	8001418300	FLA3007	8001225100	42668	8001224500
219517	8001223500	123502	8001220200	12486807	8001470800	FPA3014	8001134800	45141	8001227300
235586	8001224200	123511	8001110600	12540200	8001225400	STEIGER		45142	8001227400
310813	8001224500	123611	8001103800	12573500	8001204800	09020	8001224500	42268-1	8001224500
310814	8001225400	123615	8001129500	12670500	8001194100	09026	8001138900	SUMITOMO	
310816	8001225300	123622	8001129500	12670600	8001327000	09027	8001139100	BRH0281	8001128800
310817	8001225200	123802	8001222100	12680900	8001193500	09029	8001139100	BRH0282	8001131500
368016	8001352900	123811	8001100300	12686807	8001470300	09060	8001130800	BRH0575	8001130800
395773	8001238700	123816	8001128800	12742200	8001224500	28020	8001224500	BRH0576	8001131700
1335678	8001490200	123817	8001128800	SOFIMA		28021	8001225400	BRP0027	8001138900
1335679	8001489600	123823	8001128800	7178A	8001376300	45213	8001226900	BRP0028	8001139100
1387548	8001692200	123827	8001381800	S7356A	8001441000	45213S1	8001226900	JLH0100	8001193500
1421021	8001490200	123922	8001224400	SOPARIS		STEYR-DAIMLER-PUCH		JLH101	8001131600
1421022	8001489600	124005	8001111700	FCA3005	8001110600	3110019019	8001648800	KSP0027	8001138900
2195196470	8001223500	124015	8001111700	FCA3007	8001225100	31100190019	8001648800	KSP0028	8001139100
SCHAEFF		124201	8001225100	FCA3024	8001138900	41185190007	8001648700	SUZUKI	
5501642717	8001222500	124205	8001138800	FCA3025	8001224500	41185190010	8001223100	1650696015	8001130800
5501642727	8001687600	124501	8001110800	FCA3161	8001266000	44185190010	8001223100	T.C.M.	
5527655810	8001110600	124601	8001110900	FCA3201	8001139100	61100190020	8001353000	2080103101	8001130800
SCHLUTER		124602	8001131500	FCA3205	8001298000	61100190028	8001238600	2080103161	8001138900
SAJ502	8001238500	124603	8001110900	FCA3206	8001128800	61200190027	8001238600	2080103361	8001605000
SCHRAMM		124802	8001131600	FCA3207S	8001131600	61200190033	8001353100	T.R.S.	

MFRS Cod.	VIRGIS Cod.	MFRS Cod.	VIRGIS Cod.	MFRS Cod.	VIRGIS Cod.	MFRS Cod.	VIRGIS Cod.	MFRS Cod.	VIRGIS Cod.
25311500	8001167500	AR9835	8001227800	A556	8001224500	TERBERG		177314183071	8001167500
TADANO		A5801	8001648800	A557	8001298000	28040299	8001238500	177412360071	8001547500
34670015040	8001131700	A5805	8001648700	A562	8001224200	TEREX		177432360071	8001547500
34670015050	8001130800	A5810	8001353000	A565	8001410400	15240188	15240188	177911112071	8001110600
99701499695	8001223500	A5820	8001353100	A566	8001167500	15270188	15270188	177912200071	8001434300
99708406317	8001298000	A5830	8001352700	A570	8001220200	15270189	15270189	TRANE	
TALBOT		A5840	8001352900	A572	8001129500	THERMO-KING		X2409001	8001110600
27059900	8001223100	A5860	8001352800	A574	8001131500	113331	8001110600	X24090019	8001110600
TAMROCK		TECAFILTRES		A576	8001222100	115692	8001167500	TRU-AIR	
81166609	8001217700	9450993	8001225100	A580	8001128800	2047B64G01	8001110600	T101237	8001225100
81721449	8001226500	9450995	8001110600	A581	8001193500	2068B74	8001110600	T103951	8601567700
85225039	8001227400	TECALEMIT-TJ		A582	8001131600	2091B09G01	8001110600	T105043	8001222100
85831809	8001239500	B161	8601568000	A585	8001105600	2091B09H06	8001110600	T105368	8001128800
85832099	8001131600	B77	8001217700	A587	8001222600	3182C44G01	8001110600	T106587	8001138900
86529569	8001279000	B91	8001134800	A589	8001204800	P398991	8001110600	T106769	8001224500
TAYLOR MACHINE		TECNOCAR		A590	8001238600	TIMBERJACK		T106834	8001139100
2403700	8001224300	A-665	8001415200	A663	8001134800	403756	8001225100	T107672	8001224500
4044300	8001100300	A164	8001134300	A700	8001228300	415039	8001224400	T108668	8001130800
TEC-FIL		A303	8601569000	A702	8001121100	415040	8001226500	T109085	8001227400
AP2710	8001238600	A304	8601569300	A704	8001352000	F434072	8001537100	T114747	8001222100
AP4440	8001224200	A480	8001110600	A706	8001351000	TOKYO ROKI		T1286	8001315600
AP4650	8001687300	A481	8001438700	A712	8001248500	8113000200	8001167500	T1287	8001315000
AP4650/1	8001223500	A482	8001225400	A714	8001249100	TORO		T46976	8001410400
AP4934	8001221400	A491	8001353000	A717	8001224400	277100	8001110600	T9334	8001221400
AP4935	8001315600	A493	8001353100	A720	8001224800	277110	8001110600	TA7315	8001217700
AP5569	8001228300	A494	8001223100	A724	8001227300	932195	8001441200	TA7356	8001284700
AP6460	8001298000	A495	8001352700	A726	8001226900	TOWMOTOR		TA7365	8001315700
AP7108	8001223100	A497	8001280900	A731	8001223800	663384	8001224300	TA7366	8001221400
AP8048	8001315700	A498	8001139100	A732	8001130800	668373	8001224300	TA7367	8001315600
AP9834	8001238500	A5004	8001239700	A734	8001131700	684163	8001224300	TA7375	8001315000
AP9835	8001227800	A501	8001227800	A742	8001530400	686911	8001100300	TA7383	8001225100
AR2710	8001238600	A510	8001138900	A743	8001438000	687744	8001224300	TA7386B	8001224300
AR4650	8001687300	A511	8001227600	A752	8001227600	687746	8001224300	TA7387	8001110600
AR4650/1	8001223500	A524	8001222500	A758	8001238700	813923	8001138900	TA7387B	8001110600
AR4934	8001221400	A526	8001209100	A761	8001227800	813957	8001139100	TA7392	8001167500
AR4935	8001315600	A527	8001222900	A765	8001282500	971217	8001110600	TA7392B	8001167500
AR5569	8001228300	A528	8001315000	A766	8001410700	971426	8001167500	TA7399	8601567700
AR6460	8001298000	A529	8001222800	A767	8001226500	0946081	8001225400	TA7401	8001222100
AR7108	8001223100	A530	8001221400	A770	8001376300	0946353	8001138900	TA7404	8001128800
AR801	8001648800	A534	8001315700	TEHO FILTER		645110V	8001238600	TA7410	8001138900
AR8048	8001315700	A536	8001315600	183A	8001239700	TOYOTA		TA7413	8001224500
AR805	8001648700	A540	8001223500	TENNANT		1773141830	8001167500	TA7414	8001225400
AR820	8001353100	A541	8001352900	12538	8001226900	1773241830	8001167500	TA7415	8001110600
AR830	8001352700	A542	8001238500	51561	8001110600	1779111120	8001227400	TA7417	8001227400
AR840	8001352900	A546	8001138900	54141	8001110600	2361244790	8001131700	TA7418	8001227300
AR859	8001131700	A548	8001266000	515601	8001110600	2361344790	8001130800	TA7427	8001131500
AR860	8001352800	A550	8001687300	54141-1	8001110600	17743236007	8001547500	TA7467	8001410400

MFERS Cod. VIRGIS Cod.	MFERS Cod. VIRGIS Cod.	MFERS Cod. VIRGIS Cod.	MFERS Cod. VIRGIS Cod.	MFERS Cod. VIRGIS Cod.	
TRUCKCARE					
07-3-0202-0	8001223500	2792300	8001130800	U09200	
07-3-0203-0	8001238500	2792400	8001110600	U13343	
07-3-0205-0	8001224200	2792600	8001227300	U13501	
07-3-0206-0	8001687300	2793100	8001105600	U19370	
07-3-0220-0	8001138900	2793200	8001128800	U4M8048	
07-3-0221-0	8001139100	2793300	8001167500	U4M9334	
07-3-0224-0	8001224500	2793500	8001225100	U4M9335	
07-3-0225-0	8001225400	2793600	8001222100	U7M9046	
07-3-0227-0	8001121100	2794500	8001225300	V250D253F5	
07-3-0228-0	8001228300	2794900	8001131600	UNITED ENGINE LIFE	
07-3-0280-0	8001353100	2795000	8001230200	CP4N0015	8601409000
07-3-0281-0	8001352700	2796400	8001222900	CP6L4714	8601567700
07-3-0300-0	8001223800	2796500	8001222800	UNITED TRACTOR & EQT.	
07-3-0301-0	8001223400	2796600	8001121100	UT37441	8001110600
07-3-0320-0	8001227800	2890800	8001134800	UT41251	8001224300
07-3-0321-0	8001238600	UNI DIESEL		V.A.G. (VOLKSWAGEN, AUDI)	
07-3-0322-0	8001224800	45811353	8001224500	70129620	8001239700
07-3-0323-0	8001352900	45815763	8001225300	044129620A	8001228500
07-3-0532-0	8601568000	45816412	8001225400	075129620A	8001238600
07-3-0538-0	8001128800	45822298	8001225200	113129620A	8001239700
07-3-0540-0	8001278100	UNIPART		VALMET	
07-3-0550-0	8001224500	GFE1102	8001285700	836115237	8001298000
UFI		GFE1202	8001138900	836316408	8001238500
2700700	8001227800	GFE1204	8601568000	VAN HOOL	
2701400	8001226500	GFE1206	8001128800	9933276	8001224500
2702400	8001225200	GFE2102	8001138900	631200870	8001138900
2714800	8001410400	UNIT RIG		631201530	8001223500
2721700	8001567300	901619	8001707000	631202860	8001223400
2770700	8001134800	901620	8001707500	631401380	8001223800
2779300	8001138900	UNITED AIR CLEANER		920920110	8001629400
2780100	8001239700	250C1315	8001335600	VAPORMATIC	
2780200	8001238500	250C152	8001111000	CPD7012	8001286700
2780400	8001238600	250D275	8001335700	CPD7015	8001248500
2780500	8001224200	U01237	8001225100	CPD7026	8001105600
2780600	8001223500	U01275	8001110600	CPD7038	8001648700
2782800	8001223100	U01760	8001103800	CPD7040	8001353000
2783700	8001209100	U02745	8001167500	CPD7078	8001131700
2783800	8001687300	U05043	8001222100	CPD7124	8001128800
2786300	8001266000	U06587	8001138900	CPD7129	8001352700
2787500	8001224800	U06769	8001224500	CPD7141	8001307500
2787900	8001224400	U06775	8001225400	CPD7143	8001239500
2788900	8001298000	U06834	8001139100	CPD7150	8001134300
2789200	8001227600	U07868	8001128800	CPD7152	8001279000
2789300	8001224500	U08668	8001130800	CPD7157	8001298000
2789400	8001225400	U08674	8001131700	CPD7177	8001250000
2791900	8001220200	U08736	8001220200	CPD7178	8001227900
		U09085	8001227400	CPD7233	8001473300
CPD7244	8001279400				
CPM8006	8601568800				
VPD 7124	8001128800				
VPD 7141	8001307500				
VPD7012	8001286700				
VPD7015	8001248500				
VPD7016	8001249100				
VPD7026	8001105600				
VPD7033	8001223100				
VPD7034	8001238600				
VPD7036	8001204800				
VPD7038	8001648700				
VPD7039	8001648800				
VPD7040	8001353000				
VPD7045	8001194200				
VPD7056	8001204800				
VPD7061	8001131600				
VPD7062	8001131600				
VPD7063	8001222600				
VPD7069	8001238600				
VPD7073	8001222900				
VPD7074	8001222800				
VPD7075	8001238500				
VPD7076	8001353100				
VPD7078	8001131700				
VPD7079	8001209100				
VPD7084	8001687600				
VPD7086	8001128800				
VPD7091	8001194100				
VPD7093	8001318500				
VPD7097	8001327000				
VPD7100	8001265300				
VPD7129	8001352700				
VPD7150	8001134300				
VPD7152	8001279000				
VPD7157	8001298000				
VPD7178	8001227900				
VPD7233	8001473300				
VPM8006	8601568800				
VERMEER					
2143003	8001110600				
2150007	8001100300				
28918005	8001227400				
28918009	8001227300				
85632009	8001226900				
97611005	8001473300				
200867004	8001473300				
289180051	8001227400				
901498003	8001224400				
901498007	8001226500				
905427005	8001167500				
VERSATILE					
30924	8001227300				
30927	8001227400				
VIC					
A353	8001130800				
A366	8001224500				
A367	8001225400				
A558S	8001225100				
A564	8001138900				
A565	8001139100				
A609	8001227300				
VIRGIS					
CH-10677	8001067700				
CH-10689	8001068900				
CH-11020	8001102000				
CH-11063	8001106300				
CH-11210	8001121000				
CH-11211	8001121100				
CH-11219	8001121900				
CH-11348	8001134800				
CH-11360	8001136000				
CH-11463	8001146300				
CH-11590	8001159000				
CH-11603	8001160300				
CH-11621	8001162100				
CH-11622	8001162200				
CH-11623	8001162300				
CH-11702	8001170200				
CH-11712	8001171200				
CH-11716	8001171600				
CH-11731	8001173100				
CH-11732	8001173200				
CH-11749	8001174900				
CH-11752	8001175200				
CH-11755	8001175500				
CH-11758	8001175800				
CH-11761	8001176100				
CH-11764	8001176400				
CH-11789	8001178900				
CH-11808	8001180800				
CH-11929	8001192900				
CH-11940	8001194000				
CH-11958	8001195800				

MFRS Cod.	VIRGIS Cod.	MFRS Cod.	VIRGIS Cod.	MFRS Cod.	VIRGIS Cod.	MFRS Cod.	VIRGIS Cod.	MFRS Cod.	VIRGIS Cod.
CH-12091	8001209100	CH-12507	8001250700	CH-13185	8001318500	CH-13948	8001394800	CH-15300	8001530000
CH-12093	8001209300	CH-12532	8001253200	CH-13190	8001319000	CH-13982	8001398200	CH-15304	8001530400
CH-12135	8001213500	CH-12598	8001259800	CH-13205	8001320500	CH-14006	8001400600	CH-15310	8001531000
CH-12150	8001215000	CH-12604	8001260400	CH-13270	8001327000	CH-14015	8001401500	CH-15447	8001544700
CH-12177	8001217700	CH-12605	8001260500	CH-13294	8001329400	CH-14047	8001404700	CH-15475	8001547500
CH-12181	8001218100	CH-12653	8001265300	CH-13296	8001329600	CH-14058	8001405800	CH-15512	8001551200
CH-12203	8001220300	CH-12660	8001266000	CH-13297	8001329700	CH-14063	8001406300	CH-15565	8001556500
CH-12205	8001220500	CH-12688	8001268800	CH-13300	8001330000	CH-14104	8001410400	CH-15614	8001561400
CH-12214	8001221400	CH-12694	8001269400	CH-13310	8001331000	CH-14107	8001410700	CH-15633	8001563300
CH-12225	8001222500	CH-12712	8001271200	CH-13349	8001334900	CH-14111	8001411100	CH-15673	8001567300
CH-12225	8001222500	CH-12713	8001271300	CH-13400	8001340000	CH-14133	8001413300	CH-15696	8001569600
CH-12230	8001223000	CH-12716	8001271600	CH-13404	8001340400	CH-14152	8001415200	CH-15788	8001578800
CH-12231	8001223100	CH-12739	8001273900	CH-13423	8001342300	CH-14154	8001415400	CH-15949	8001594900
CH-12234	8001223400	CH-12752	8001275200	CH-13424	8001342400	CH-14211	8001421100	CH-16086	8001608600
CH-12235	8001223500	CH-12770	8001277000	CH-13467	8001346700	CH-14214	8001421400	CH-16284	8001628400
CH-12238	8001223800	CH-12775	8001277500	CH-13473	8001347300	CH-14237	8001423700	CH-16294	8001629400
CH-12239	8001223900	CH-12781	8001278100	CH-13477	8001347700	CH-14245	8001424500	CH-16378	8001637800
CH-12241	8001224100	CH-12790	8001279000	CH-13489	8001348900	CH-14257	8001425700	CH-16384	8001638400
CH-12242	8001224200	CH-12794	8001279400	CH-13495	8001349500	CH-14259	8001425900	CH-16489	8001648900
CH-12248	8001224800	CH-12798	8001279800	CH-13500	8001350000	CH-14312	8001431200	CH-16490	8001649000
CH-12269	8001226900	CH-12809	8001280900	CH-13506	8001350600	CH-14334	8001433400	CH-16491	8001649100
CH-12273	8001227300	CH-12817	8001281700	CH-13510	8001351000	CH-14340	8001434000	CH-16492	8001649200
CH-12276	8001227600	CH-12818	8001281800	CH-13520	8001352000	CH-14380	8001438000	CH-16521	8001652100
CH-12278	8001227800	CH-12825	8001282500	CH-13561	8001356100	CH-14386	8001438600	CH-16523	8001652300
CH-12278	8001227800	CH-12826	8001282600	CH-13562	8001356200	CH-14387	8001438700	CH-16523	8001652300
CH-12279	8001227900	CH-12839	8001283900	CH-13573	8001357300	CH-14388	8001438800	CH-16533	8001653300
CH-12283	8001228300	CH-12843	8001284300	CH-13577	8001357700	CH-14393	8001439300	CH-16689	8001668900
CH-12284	8001228400	CH-12847	8001284700	CH-13579	8001357900	CH-14425	8001442500	CH-16824	8001682400
CH-12285	8001228500	CH-12857	8001285700	CH-13591	8001359100	CH-14533	8001453300	CH-16873	8001687300
CH-12287	8001228700	CH-12867	8001286700	CH-13597	8001359700	CH-14536	8001453600	CH-16878	8001687800
CH-12290	8001229000	CH-12870	8001287000	CH-13623	8001362300	CH-14722	8001472200	CH-16881	8001688100
CH-12291	8001229100	CH-12884	8001288400	CH-13644	8001364400	CH-14735	8001473500	CH-16888	8001688800
CH-12302	8001230200	CH-12888	8001288800	CH-13692	8001369200	CH-14738	8001473800	CH-16922	8001692200
CH-12345	8001234500	CH-12953	8001295300	CH-13763	8001376300	CH-14888	8001488800	CH-16928	8001692800
CH-12385	8001238500	CH-12980	8001298000	CH-13771	8001377100	CH-14896	8001489600	CH-16969	8001696900
CH-12386	8001238600	CH-12985	8001298500	CH-13797	8001379700	CH-14900	8001490000	CH-16971	8001697100
CH-12387	8001238700	CH-13074	8001307400	CH-13811	8001381100	CH-14902	8001490200	CH-17203	8001720300
CH-12397	8001239700	CH-13075	8001307500	CH-13818	8001381800	CH-14928	8001492800	CH-17303	8001730300
CH-12403	8001240300	CH-13090	8001309000	CH-13824	8001382400	CH-14950	8001495000	CH-17372	8001737200
CH-12405	8001240500	CH-13115	8001311500	CH-13824	8001382400	CH-14955	8001495500	CH-17406	8001740600
CH-12463	8001246300	CH-13116	8001311600	CH-13835	8001383500	CH-15005	8001500500	CH-17490	8001749000
CH-12474	8001247400	CH-13141	8001314100	CH-13848	8001384800	CH-15166	8001516600	CH-17512	8001751200
CH-12485	8001248500	CH-13150	8001315000	CH-13880	8001388000	CH-15180	8001518000	CH-17531	8001753100
CH-12491	8001249100	CH-13156	8001315600	CH-13889	8001388900	CH-15196	8001519600	CH-17539	8001753900
CH-12498	8001249800	CH-13157	8001315700	CH-13905	8001390500	CH-15247	8001524700	CH-17541	8001754100
CH-12500	8001250000	CH-13173	8001317300	CH-13939	8001393900	CH-15267	8001526700	CH-17542	8001754200
		CH-13177	8001317700	CH-13947	8001394700	CH-15294	8001529400	CH-17575	8001757500

MFRS Cod.	VIRGIS Cod.	MFRS Cod.	VIRGIS Cod.	MFRS Cod.	VIRGIS Cod.	MFRS Cod.	VIRGIS Cod.	MFRS Cod.	VIRGIS Cod.
CH-17576	8001757600	CH06-14733	8001473300	DL-15751	9351575100	PF-16803	8601680300	PF-17846	8601784600
CH-17577	8001757700	CH06-16050	8001605000	DL-16097	9351609700	PF-16805	8601680500	PF-17847	8601784700
CH-17578	8001757800	CH07-14074	8001407400	DL-16141	9351614100	PF-16892	8601689200	PF-17924	8601792400
CH-17590	8001759000	CH07-14865	8001486500	DL-16550	9351655000	PF-17012	8601701200	PF-17933	8601793300
CH-17594	8001759400	CH08-11003	8001100300	DL-16560	9351656000	PF-17013	8601701300	PF-17934	8601793400
CH-17712	8001771200	CH08-11254	8001125400	DL-16597	9351659700	PF-17014	8601701400	PF-17935	8601793500
CH-17762	8001776200	CH08-11288	8001128800	DL-16859	9351685900	PF-17016	8601701600	PF-18005	8601800500
CH-17830	8001783000	CH08-11288	8001128800	DL-16862	9351686200	PF-17036	8601703600	PF-18026	8601802600
CH-18090	8001809000	CH08-11730	8001173000	DL-16864	9351686400	PF-17052	8601705200	PF-18044	8601804400
CH-18168	8001816800	CH08-11837	8001183700	DL-17111	9351711100	PF-17159	8601715900	PF-18063	8601806300
CH-18249	8001824900	CH08-11935	8001193500	DL-17114	9351711400	PF-17164	8601716400	PF-18064	8601806400
CH-18334	8001833400	CH08-11942	8001194200	DL-17163	9351716300	PF-17165	8601716500	PF-18084	8601808400
CH-18461	8001846100	CH08-11998	8001199800	DL-17329	9351732900	PF-17166	8601716600	PF-18101	8601810100
CH-18672	8001867200	CH08-12221	8001222100	DL-17330	9351733000	PF-17167	8601716700	PF-18106	8601810600
CH-18762	8001876200	CH08-12228	8001222800	DL-17331	9351733100	PF-17168	8601716800	PF-18115	8601811500
CH-18780	8001878000	CH08-12243	8001224300	DL-17332	9351733200	PF-17170	8601717000	PF-18116	8601811600
CH-18781	8001878100	CH08-14410	8001441000	DL-17333	9351733300	PF-17217	8601721700	PF-18121	8601812100
CH-18782	8001878200	CH08-14703	8001470300	DL-17335	9351733500	PF-17257	8601725700	PF-18135	8601813500
CH-18783	8001878300	CH08-14830	8001483000	DL-17336	9351733600	PF-17383	8601738300	PF-18173	8601817300
CH-18784	8001878400	CH08-14835	8001483500	DL-17604	9351760400	PF-17443	8601744300	PF-18174	8601817400
CH-18812	8001881200	CH08-17365	8001736500	DL-17606	9351760600	PF-17444	8601744400	PF-18203	8601820300
CH-18868	8001886800	CH08-18056	8001805600	DL-17710	9351771000	PF-17448	8601744800	PF-18235	8601823500
CH-18905	8001890500	CH09-12244	8001224400	DL-17823	9351782300	PF-17480	8601748000	PF-18327	8601832700
CH-19345	8001934500	CH09-16729	8001672900	DL-17852	9351785200	PF-17482	8601784200	PF-18341	8601834100
CH-19450	8001945000	CH09-19157	8001915700	DL-18919	9351891900	PF-17483	8601748300	PF-18347	8601834700
CH-19818	8001981800	CH10-11117	8001111700	DL-19711	9351971100	PF-17487	8601748700	PF-18350	8601835000
CH04-11675	8001167500	CH10-11308	8001130800	PF-14090	8601409000	PF-17517	8601751700	PF-18353	8601835300
CH04-14412	8001441200	CH10-12390	8001445500	PF-14910	8601491000	PF-17525	8601752500	PF-18355	8601835500
CH04-15145	8001514500	CH10-14455	8001445500	PF-15015	8601501500	PF-17534	8601753400	PF-18356	8601835600
CH05-11106	8001110600	CH10-15371	8001537100	PF-15441	8601544100	PF-17555	8601755500	PF-18357	8601835700
CH05-11467	8001146700	CH10-15711	8001571100	PF-15470	8601547000	PF-17561	8601756100	PF-18358	8601835800
CH05-11555	8001155500	CH12-11343	8001134300	PF-15660	8601566000	PF-17562	8601756200	PF-18360	8601836000
CH05-12202	8001220200	CH12-11388	8001138800	PF-15671	8601567100	PF-17569	8601756900	PF-18364	8601836400
CH05-12222	8001220200	CH12-11389	8001138900	PF-15677	8601567700	PF-17571	8601757100	PF-18368	8601836800
CH05-14409	8001440900	CH12-11389	8001138900	PF-15680	8601568000	PF-17611	8601761100	PF-18369	8601836900
CH05-14409	8001440900	CH12-12251	8001225100	PF-15688	8601568800	PF-17629	8601762900	PF-18377	8601837700
CH05-14827	8001482700	CH12-13632	8001363200	PF-15690	8601569000	PF-17630	8601763000	PF-18387	8601838700
CH05-15078	8001507800	CH12-16418	8001641800	PF-15693	8601569300	PF-17631	8601763100	PF-18392	8601839200
CH05-15887	8001588700	CH14-12245	8001224500	PF-15699	8601569900	PF-17632	8601763200	PF-18393	8601839300
CH05-15887	8001588700	CH14-12245	8001224500	PF-15700	8601570000	PF-17633	8601763300	PF-18394	8601839400
CH06-11038	8001103800	CH14-12245	8001224500	PF-15701	8601570100	PF-17644	8601764400	PF-18395	8601839500
CH06-11056	8001105600	CH14-13356	8001335600	PF-15856	8601585600	PF-17757	8601775700	PF-18396	8601839600
CH06-11255	8001125500	CH15-18201	8001820100	PF-15857	8601585700	PF-17767	8601776700	PF-18397	8601839700
CH06-11295	8001129500	CH16-12253	8001225300	PF-15891	8601589100	PF-17816	8601781600	PF-18398	8601839800
CH06-11880	8001188000	CH16-15762	8001576200	PF-16185	8601618500	PF-17817	8601781700	PF-18399	8601839900
CH06-11941	8001194100	CH18-17230	8001723000	PF-16738	8601673800	PF-17838	8601783800	PF-18408	8601840800
CH06-14733	8001473300	CH21-17070	8001707000	PF-16800	8601680000	PF-17844	8601784400	PF-18409	8601840900

MFRS Cod.	VIRGIS Cod.	MFRS Cod.	VIRGIS Cod.	MFRS Cod.	VIRGIS Cod.	MFRS Cod.	VIRGIS Cod.	MFRS Cod.	VIRGIS Cod.
PF-18410	8601841000	PF-18703	8601870300	PF-18912	8601891200	PF-19564	8601956400	ST-14343	8001434300
PF-18416	8601841600	PF-18712	8601871200	PF-18917	8601891700	PF-19569	8601956900	ST-14715	8001471500
PF-18418	8601841800	PF-18713	8601871300	PF-18932	8601893200	PF-19616	8601961600	ST-14758	8001475800
PF-18450	8601845000	PF-18714	8601871400	PF-18935	8601893500	PF-19662	8601966200	ST-14787	8001478700
PF-18474	8601847400	PF-18715	8601871500	PF-18936	8601893600	PF-19667	8601966700	ST-15255	8001525500
PF-18488	8601848800	PF-18716	8601871600	PF-18937	8601893700	PF-19810	8601981000	ST-15400	8001540000
PF-18498	8601849800	PF-18717	8601871700	PF-18938	8601893800	PF-19825	8601982500	ST-15411	8001541100
PF-18499	8601849900	PF-18719	8601871900	PF-18939	8601893900	PF-19845	8601984500	ST-15557	8001555700
PF-18536	8601853600	PF-18724	8601872400	PF-18940	8601894000	PF-19854	8601985400	ST-16487	8001648700
PF-18537	8601853700	PF-18726	8601872600	PF-18941	8601894100	PF-19864	8601986400	ST-16488	8001648800
PF-18558	8601855800	PF-18732	8601873200	PF-18942	8601894200	PF-19904	8601990400	ST-16493	8001649300
PF-18559	8601855900	PF-18733	8601873300	PF-18943	8601894300	PFM-14095	8601409000	ST-16494	8001649400
PF-18563	8601856300	PF-18738	8601873800	PF-18961	8601896100	PSC-18073	8601807300	ST-16495	8001649500
PF-18568	8601856800	PF-18739	8601873900	PF-18962	8601896200	PSC08-19620	8601962000	ST-16496	8001649600
PF-18569	8601856900	PF-18745	8601874500	PF-18963	8601896300	PSC09-19158	8601915800	ST-16872	8001687200
PF-18570	8601857000	PF-18761	8601876100	PF-18964	8601896400	SC-12252	8001225200	ST-16875	8001687500
PF-18571	8601857100	PF-18769	8601876900	PF-18965	8601896500	SC-12274	8001227400	ST-16876	8001687600
PF-18572	8601857200	PF-18774	8601877400	PF-18979	8601897900	SC-15604	8001560400	ST-16877	8001687700
PF-18573	8601857300	PF-18775	8601877500	PF-18979	8601889700	SC-15681	8001568100	ST-16879	8001687900
PF-18574	8601857400	PF-18776	8601877600	PF-18982	8601898200	SC-16290	8001629000	ST-16880	8001688000
PF-18575	8601857500	PF-18795	8601879500	PF-18999	8601899900	SC-16301	8001630100	ST-16938	8001693800
PF-18576	8601857600	PF-18807	8601880700	PF-19000	8601900000	SC-16522	8001652200	ST-16970	8001697000
PF-18583	8601858300	PF-18808	8601880800	PF-19020	8601902000	SC-19305	8001930500	ST-16972	8001697200
PF-18584	8601858400	PF-18809	8601880900	PF-19056	8601905600	SC06-11246	8001124600	ST-17092	8001709200
PF-18585	8601858500	PF-18811	8601881100	PF-19068	8601906800	SC06-11252	8001125200	ST-17103	8001710300
PF-18587	8601858700	PF-18846	8601884600	PF-19071	8601907100	SC06-11269	8001126900	ST-17260	8001726000
PF-18592	8601859200	PF-18847	8601884700	PF-19092	8601909200	SC08-11253	8001125300	ST-17470	8001747000
PF-18594	8601859400	PF-18848	8601884800	PF-19116	8601911600	SC10-11317	8001131700	ST-17477	8001747700
PF-18595	8601859500	PF-18850	8601885000	PF-19117	8601911700	SC10-12395	8001239500	ST-18760	8001876000
PF-18600	8601860000	PF-18858	8601885800	PF-19118	8601911800	SC12-11391	8001139100	ST04-15170	8001517000
PF-18601	8601860100	PF-18859	8601885900	PF-19122	8601912200	SC12-13636	8001363600	ST05-11108	8001110800
PF-18602	8601860200	PF-18860	8601886000	PF-19137	8601913700	SC14-12254	8001225400	ST05-11618	8001161800
PF-18621	8601862100	PF-18861	8601886100	PF-19147	8601914700	SC14-12254	8001225400	ST05-11655	8001165500
PF-18624	8601862400	PF-18862	8601886200	PF-19207	8601920700	SC14-13357	8001335700	ST05-14402	8001440200
PF-18630	8601863000	PF-18865	8601886500	PF-19244	8601924400	SC18-17232	8001723200	ST05-14980	8001498000
PF-18647	8601864700	PF-18866	8601886600	PF-19248	8601924800	SC21-17075	8001707500	ST05-16108	8001610800
PF-18648	8601864800	PF-18867	8601886700	PF-19257	8601925700	ST-12106	8001210600	ST06-11109	8001110900
PF-18649	8601864900	PF-18869	8601886900	PF-19268	8601926800	ST-12226	8001222600	ST06-11315	8001131500
PF-18657	8601865700	PF-18871	8601887100	PF-19284	8601928400	ST-12689	8001268900	ST06-12048	8001204800
PF-18658	8601865800	PF-18872	8601887200	PF-19287	8601928700	ST-13410	8001341000	ST06-14160	8001416000
PF-18666	8601866600	PF-18873	8601887300	PF-19290	8601929000	ST-13527	8001352700	ST06-16054	8001605400
PF-18669	8601866900	PF-18879	8601887900	PF-19293	8601929300	ST-13528	8001352800	ST07-14270	8001427000
PF-18671	8601867100	PF-18899	8601889900	PF-19326	8601932600	ST-13529	8001352900	ST08-11110	8001111000
PF-18678	8601867800	PF-18908	8601890800	PF-19382	8601938200	ST-13530	8001353000	ST08-11316	8001131600
PF-18679	8601867900	PF-18909	8601890900	PF-19419	8601941900	ST-13531	8001353100	ST08-12229	8001222900
PF-18680	8601868000	PF-18910	8601891000	PF-19424	8601942400	ST-14113	8001411300	ST08-12459	8001245900
PF-18681	8601868100	PF-18911	8601891100	PF-19459	8601945900	ST-14183	8001418300		

MFRS Cod.	VIRGIS Cod.	MFRS Cod.	VIRGIS Cod.	MFRS Cod.	VIRGIS Cod.	MFRS Cod.	VIRGIS Cod.	MFRS Cod.	VIRGIS Cod.
ST08-12576	8001257600	3576571	8001193500	66451196	8001138900	VP-0357	8001138900	WERKLUST	
ST08-14413	8001441300	4758610	8001238600	73622243	8001238500	VS-1956	8001130800	6962224	8001138900
ST08-14708	8001470800	4780961	8001238500	74751918	8001139100	VS-1968	8001138900	6962225	8001139100
ST08-14829	8001482900	4785610	8001238600	79253654	8001227400	VS-2318	8001226900	WGB	
ST08-17366	8001736600	4785611	8001353000	79253662	8001227300	VS-2395	8001131700	SA100	8001110600
ST09-12265	8001226500	4785612	8001238600	79258257	8001225100	VY-8537	8001227300	SA100A	8001110600
ST09-16731	8001673100	4785746	8001352700	79359626	8001224200	VY-8538	8001227400	SA110	8001315700
ST10-11239	8001123900	4785748	8001223500	79384772	8001224500	VY-9209	8001224500	SA113	8001221400
ST10-15380	8001538000	4785749	8001352900	79384780	8001225400	VY-9210	8001225400	SA130	8001315600
ST12-11390	8001139000	4785921	8001225200	81436917	8601544100	X43-545	8001130800	SA134	8001315000
ST12-15870	8001587000	4785922	8001225300	110331295	8001352800	X43-564	8001225100	SA15	8601409000
ST12-16419	8001641900	4880631	8001227600	110337839	8001352900	WABCO HOUSINGS		SA209	8001134800
VM		4880632	8001131700	119924629	8001298000	VP-4365	8001138900	SA263	800138900
41130007A	8001130800	6639203	8001283900	217362224	8001238500	VP-4711	8001130800	SA270	8001225400
41130008A	8001129500	6640289	8001223500	VOLVO CONSTRUCTION EQUIPMENT		VP-4712	8001224500	SA278	8001222100
41132011A	8001128800	6642047	8001353100	3570821	8001250000	VP-7377	8001130800	SA283	8001224500
41132013A	8001131700	6644839	8001238600	3570822	8001227900	VY-5281	8001224500	SA294	8001224300
VME (VOLVO BM/MICH./ EUCLID)		6644840	8001353000	3622248	8001238500	WAGNER MINING		SA330	8601567700
6241405	8001723000	6644988	8001353100	11033777	8001353000	328181	8001224300	SA334	8001139100
6241406	8001723200	6644990	8001224200	11033996	8001629400	328185	8001224300	SA374	8001220200
6644991	8001224200	6645119	8001138900	11033997	8001630100	346396	8001224500	SA380	8001224500
11033129	8001352800	6645833	8001353100	11110023	8001629000	346397	8001225400	SA387	8001217700
11033777	8001353000	6897064	8001222500	11110149	8001353100	346398	8001224500	SA418	8001130800
11033779	8001353100	7008166	8001130800	111037771	8001353000	346399	8001225400	SA420	8001410400
11033781	8001352700	7009363	8001128800	M12000149	8001227300	347686	8001224300	SA422	8001128800
11033783	8001352900	7009375	8001131700	VOLVO-BM		360956	8001138900	SA423	8001131600
M12000149	8001227300	7009410	8001131600	40123606	8001227400	WAKO		SA430	8001131700
VOLVO		7362224	8001238500	110337797	8001353100	LA288	8001225100	SA434	8001128800
347138	8001282600	7475191	8001139100	110337813	8001352700	LA368	8001130800	SA448	8001224400
347437	8001266000	8143691	8601544100	110337839	8001352900	LA368S	8001130800	SA449	8001226500
475081	8001224500	8144430	8601544100	110337839	8001352900	WALDON		SA469	8001129500
475190	8001138900	8293904	8001128800	110339967	8001629400	42770	8001110600	SA97A	8001225100
475191	8001139100	11110022	8001488800	110339975	8001630100	42796	8001110600	WHITE	
475339	8001266000	12000189	8001224500	VORTOX		55574	8001224300	640114	8001128800
475386	8001228300	15427438	8001228300	VF160R	8001102000	WARNER & SWASEY		664578	8001110600
475755	8001121100	15442981	8001230200	VORTOX HOUSING		251429	8001225100	703112	8001224300
858488	8001500500	16603755	8001121100	AN150H	8001102000	650156	8001224300	896688	8001225100
900691	8001238500	16606196	8001228300	WABCO		WAUKESHA		1156603	8001224300
1080920	8001693800	16616674	8001209300	VJ-0560	8001138900	199206	8001110600	1190153	8001224300
1542743	8001228300	16616674	8001209300	VJ-0561	8001139100	199421	8001224400	1196733	8001224300
1544298	8001230200	47856109	8001238600	VJ-1881	8001224500	207965	8001473300	27074164	8001138900
1544428	8001121100	47856117	8001353000	VJ-1882	8001138900	493016	8001224400	27074252	8001224500
1660375	8001121100	47857461	8001352700	VJ-1884	8001225400	493017	8001473300	27074458	8001138900
1660619	8001228300	47857487	8001223500	VJ-1885	8001139100	WAUSAU IRON		27075128	8001225300
1661667	8001209300	47857495	8001352900	VJ-2325	8001227400	201415	8001130800	203004805	8001110600
3471380	8001282600	66392036	8001283900	VJ-5175	8001707000	WAYNE			
		66449885	8001353100	VJ-5176	8001707500	604334	8001110600		
		66449901	8001224200						

MFRS Cod.	VIRGIS Cod.	MFRS Cod.	VIRGIS Cod.	MFRS Cod.	VIRGIS Cod.	MFRS Cod.	VIRGIS Cod.	MFRS Cod.	VIRGIS Cod.
203004926	8001110600	42142	8001100300	46378	8001260500	A122	8001225100	WGA1094	8001279000
207000615	8001139100	42208	8001224500	46407	8001471500	A124	8001265300	WGA1109	8001605000
207002172	8001130800	42209	8001225400	46408	8001248500	A139	8001239700	WGA111	8001224200
207300768	8001110600	42225	8001227300	46414	8001224800	A146	8001225400	WGA111S	8001352700
302012251	8001138900	42226	8001227400	46430	8001223100	A149	8001128800	WGA113	8001238500
302012324	8001139100	42237	8001225100	46466	8001222800	A150	8001223100	WGA113S	8001353100
303070342	8001130800	42238	8001707000	46467	8001222900	A152	8001238500	WGA114	8001238600
303070352	8001130800	42239	8001707500	46487	8001222800	A154	8001266000	WGA114S	8001353000
312755007	8001224400	42258	8001723000	46496	8001271600	A159	8001139100	WGA1179	8001530400
312755017	8001226500	42259	8001723200	46498	8001249100	A160	8001238600	WGA125	8001239700
312755067	8001130800	42276	8001110600	46502	8001472200	A161	8001224200	WGA128	8001223100
312755077	8001131700	42321	8001128800	46504	8001433400	A32	8001134800	WGA128S	8001648700
312755087	8001130800	42334	8001221400	46510	8001222500	A55	8001217700	WGA129K	8001130800
312990561	8001222800	42335	8001315600	46515	8001238600	A65	8001266000	WGA129KE	8001130800
027074453	8001225100	42336	8001314100	46517	8001341000	A66	8001138900	WGA129S	8001131700
10A19708	8001224300	42489	8001146700	46522	8001131600	A76	8001217700	WGA12KE	8001103800
10P2652	8001225100	42503	8001222100	46525	8001353100	A85	8001224500	WGA12S	8001434300
157959AS	8001224300	42518	8001473300	46526	8001194100	AK120	8001110600	WGA131	8001282600
159089A	8001128800	42522	8001224400	46532	8001353000	DT1237	8001225100	WGA133	8001298000
162814AS	8001224300	42595	8601567700	46534	8001286700	DT1275	8001110600	WGA135	8601568000
166068A	8001239500	42608	8001223500	46537	8001222800	DT42	8601409000	WGA143	8001121100
167067A	8001130800	42609	8001352900	46538	8001222900	DT8048	8001315700	WGA14K	8001225100
167068A	8001239500	42630	8001217700	46541	8001224200	DT9046	8001315000	WGA152	8001283900
3107368H2	8001138900	42631	8001105600	46547	8001228300	DT9334	8001221400	WGA15K	8001110600
3314H2	8001225100	42632	8001222600	46554	8001238500	DT9335	8001315600	WGA15KE	8001110600
3341H2	8001225100	42645	8001167500	46560	8001226500	WOODGATE		WGA160S	8001648800
35A8197	8001110600	42656	8001335600	46562	8001222900	WGA100	8001221400	WGA168	8001278100
35A8260	8001110600	42657	8001335700	46569	8001441300	WGA1028S	8001693800	WGA16KE	8001100300
35P1601	8001110600	42679	8001131500	46580	8601409000	WGA1029	8001209300	WGA16S	8001111000
40A134	8001110600	42710	8001283900	46594	8001223400	WGA1030K	8001445500	WGA171K	8001220200
896688H2	8001225100	42769	8001434300	46606	8001129500	WGA1042	8001194200	WGA178	8001275200
CM94	8001110600	42868	8001128800	46613	8001327000	WGA1049K	8001234500	WGA18	8001138900
X27780	8601567700	42918	8001410400	46625	8001194200	WGA1050S	8001204800	WGA189	8001128800
Y531281	8001225100	42919	8001130800	46642	8001227600	WGA1054K	8001382400	WGA18E	8001138900
WIPAC		42920	8001131700	46643	8001131700	WGA1057	8001530000	WGA18S	8001139100
AP113	8601568000	42921	8001239500	46652	8001407400	WGA1060	8001282500	WGA194	8001286700
AP903	8001110600	42924	8001139100	46672	8001427000	WGA107	8001228300	WGA205	8001217700
WISCONSIN		42927	8001226900	46741	8001227800	WGA1070S	8001222500	WGA206	8001223400
EP78	8001110600	46210	8001284700	46868	8001102000	WGA1072	8001556500	WGA21	8001265300
LO176	8001110600	46263	8001498000	47048	8001225200	WGA1075K	8001188000	WGA22K	8001128800
WIX		46270	8001167500	47052	8001225300	WGA1077S	8001440200	WGA22S	8001131600
15295	8001227300	46294	8001209100	546683	8001193500	WGA1079	8001407400	WGA29	8001266000
42042	8601409000	46313	8001239700	751754	8001193500	WGA1080	8001441000	WGA30	8001224500
42046	8001315000	46330	8001228500	211A	8001283900	WGA1083S	8001352000	WGA301S	8001226500
42048	8001315700	46352	8001240300	A10	8001283900	WGA1087	8001271600	WGA303	8001227600
42119	8001138900	46360	8001110600	A108	8601568000	WGA1091S	8001204800	WGA304E	8001227300
42123	8001220200	46375	8001111000	A116	8001223500	WGA1093	8001376300	WGA304S	8001227400









MFERS Cod.	VIRGIS Cod.	MFERS Cod.	VIRGIS Cod.	MFERS Cod.	VIRGIS Cod.	MFERS Cod.	VIRGIS Cod.
WGA307	8001226900	WGA599	8001410400	2022514	8001225100	ZETOR	
WGA307E	8001226900	WGA605S	8001260500	2047874	8001224300	10011906	8001238500
WGA309K	8001129500	WGA670	8001102000	2078387	8001130800	10011907	8001353100
WGA309KE	8001129500	WGA835	8001111000	2991489	8001225100	79011296	8001204800
WGA309S	8001131500	WGA921	8001295300	2991764	8001138900	ZETTELMAYER	
WGA30E	8001224500	WGA927	8001279800	2992216	8001224500	2061350	8001223100
WGA30S	8001225400	WGA927S	8001239500	5040251	8001224300	2078240	8001238600
WGA325	8001227800	WGA928	8001307400	5300504	8001146700	2078241	8001298000
WGA330	8001228500	WGA96	8001223500	6537850	8001110600	2137030	8001239700
WGA331	8001222500	WGA964K	8001381100	6952789	8001130800	2240880	8001224200
WGA331S	8001687600	WGA96S	8001352900	6953030	8001225300	2240890	8001352700
WGA334	8001223800	WGA97	8001224800	6953031	8001225200	20613504	8001223100
WGA338K	8001222100	WGA986	8001410700	6953104	8001138900	20782403	8001238600
WGA338KE	8001222100	WGA987	8001410400	6953105	8001139100	20782411	8001298000
WGA339KE	8001224400	WGA989	8001309000	6953106	8001225400	22408800	8001224200
WGA340KE	8001222800	WGA991	8001433400	6953107	8001224500	22624805	8001353000
WGA340S	8001222900	WGA993	8001285700	8403756	8001225100	02031600	8001648800
WGA343	8001315700	WGA995	8001249800	150012700	8001110600		
WGA344	8001315000	WGS236	8001314100	150023100	8001110600		
WGA345	8001315600	WORTHINGTON		150071600	8001110600		
WGA355	8001209100	11453900	8001629400	440042467	8001130800		
WGA378K	8001167500	522082536	8001271200	440042468	8001131700		
WGA382K	8001105600	522082537	8001271300	440051973	8001110600		
WGA382S	8001222600	522082538	8001394800	440052940	8001239700		
WGA395	8001314100	522082539	8001394700	440056440	8001128800		
WGA400	8001335600	522082544	8001482700	440056441	8001131600		
WGA400S	8001335700	WORTHINGTON PUMP		506973401	8001224300		
WGA406	8001707000	522082536	8001271200	515865800	8001110600		
WGA406S	8001707500	522082537	8001271300	901515400	8001110600		
WGA412K	8001130800	522082538	8001394800	902225300	8001110600		
WGA434	8601567700	522082539	8001394700	YANMAR			
WGA439S	8001230200	522082544	8001482700	2330387307	8001110600		
WGA440	8001121100	CLE-371	8001110600	11465012591	8001688800		
WGA442	8001228300	CLE-390	8001224400	12112012001	8001439300		
WGA453K	8001194100	ELM-44	8001110600	12112012901	8001110600		
WGA454	8001280900	ELM-54	8001130800	12122012901	8001110600		
WGA462K	8001327000	ELM-56	8001131700	12125612510	8001110600		
WGA466S	8001248500	ELM-74	8001131600	12142012511	8001110600		
WGA467K	8001193500	ELM-78	8001224400	12152012510	8001167500		
WGA470S	8001478700	ELM-79	8001226500	12192212510	8001128800		
WGA477	8001723000	ELM-85	8001167500	12406612510	8001167500		
WGA477S	8001723200	YALE & TOWNE		12665212620	8001138900		
WGA478K	8001146700	103059	8001224300	12665412620	8001225400		
WGA478S	8001341000	105025	8001224300	12665412630	8001224500		
WGA486	8001318500	403756	8001225100	17102212530	8001167500		
WGA494K	8001268800	653785	8001110600	41650550810	8001423700		
WGA54E	8001225300	1297646	8001110600	52152012510	8001167500		





























CARTUCCE ARIA

Air elements

Codice / Code	8001067700	mm	inch	Codice / Code	8001068900	mm	inch
	Altezza / Height	237	9,33		Altezza / Height	223	8,78
	Diametro esterno Outer diameter	164	6,46		Diametro esterno Outer diameter	183	7,20
	Diametro interno Internal diameter	86	3,39		Diametro interno Internal diameter	106	4,17
	Diametro foro borchia Stud hole diameter	8,5	0,33		Diametro foro borchia Stud hole diameter	9,5	0,37
	Tipo mezzo filtrante Filter media type	Cellulosa / Cellulose			Tipo mezzo filtrante Filter media type	Cellulosa / Cellulose	
	Stile / Style	Rotondo a tenuta assiale Round axial seal			Stile / Style	Rotondo a tenuta assiale Round axial seal	
	Tipo / Type	Cartuccia primaria / Primary cartridge			Tipo / Type	Cartuccia primaria / Primary cartridge	
Note / Notes	L'altezza non include la guarnizione Height not include gasket		Note / Notes	L'altezza non include la guarnizione Height not include gasket			
Codice / Code	8001100300	mm	inch	Codice / Code	8001102000	mm	inch
	Altezza / Height	304	11,97		Altezza / Height	662	26,06
	Diametro esterno Outer diameter	155	6,10		Diametro esterno Outer diameter	324	12,76
	Diametro interno Internal diameter	88	3,46		Diametro interno Internal diameter	214	8,43
	Diametro foro borchia Stud hole diameter	18	0,71		Diametro foro borchia Stud hole diameter	13	0,51
	Tipo mezzo filtrante Filter media type	Cellulosa / Cellulose			Tipo mezzo filtrante Filter media type	Cellulosa / Cellulose	
	Stile / Style	Rotondo a tenuta assiale con alette Round axial seal with fins			Stile / Style	Rotondo a tenuta assiale Round axial seal	
	Tipo / Type	Cartuccia primaria / Primary cartridge			Tipo / Type	Cartuccia primaria / Primary cartridge	
Note / Notes	L'altezza non include la guarnizione Height not include gasket		Note / Notes	L'altezza non include la guarnizione Height not include gasket			
Cartuccia di sicurezza abbinata / Matched security cartridge							
800111000							
Codice / Code	8001103800	mm	inch	Codice / Code	8001105600	mm	inch
	Altezza / Height	280	11,02		Altezza / Height	304	11,97
	Diametro esterno Outer diameter	134	5,28		Diametro esterno Outer diameter	134	5,28
	Diametro interno Internal diameter	68	2,68		Diametro interno Internal diameter	92,5	3,64
	Diametro foro borchia Stud hole diameter	19	0,75		Diametro foro borchia Stud hole diameter	18	0,71
	Tipo mezzo filtrante Filter media type	Cellulosa / Cellulose			Tipo mezzo filtrante Filter media type	Cellulosa / Cellulose	
	Stile / Style	Rotondo a tenuta assiale con alette Round axial seal with fins			Stile / Style	Rotondo a tenuta assiale con alette Round axial seal with fins	
	Tipo / Type	Cartuccia primaria / Primary cartridge			Tipo / Type	Cartuccia primaria / Primary cartridge	
Note / Notes	L'altezza non include la guarnizione Height not include gasket		Note / Notes	L'altezza non include la guarnizione Height not include gasket			
Cartuccia di sicurezza abbinata / Matched security cartridge				8001125200			
Codice / Code	8001106300	mm	inch	Codice / Code	8001110600	mm	inch
	Altezza / Height	120	4,72		Altezza / Height	253	9,96
	Diametro esterno Outer diameter	69	2,72		Diametro esterno Outer diameter	104	4,09
	Diametro interno Internal diameter	26	1,02		Diametro interno Internal diameter	63	2,48
	Diametro foro borchia Stud hole diameter	-	-		Diametro foro borchia Stud hole diameter	18	0,71
	Tipo mezzo filtrante Filter media type	Cellulosa / Cellulose			Tipo mezzo filtrante Filter media type	Cellulosa / Cellulose	
	Stile / Style	Rotondo a tenuta radiale Round radial seal			Stile / Style	Rotondo a tenuta assiale con alette Round axial seal with fins	
	Tipo / Type	Cartuccia primaria / Primary cartridge			Tipo / Type	Cartuccia primaria / Primary cartridge	
Note / Notes	-		Note / Notes	L'altezza non include la guarnizione Height not include gasket			
Cartuccia di sicurezza abbinata / Matched security cartridge				8001110800			

Codice / Code	8001110800	mm	inch	Codice / Code	8001110900	mm	inch
	Altezza / Height	242	9,53		Altezza / Height	262	10,31
	Diametro esterno Outer diameter	62	2,44		Diametro esterno Outer diameter	66	2,60
	Diametro interno Internal diameter	52	2,05		Diametro interno Internal diameter	56	2,20
	Diametro foro borchia Stud hole diameter	8,5	0,33		Diametro foro borchia Stud hole diameter	8,5	0,33
	Tipo mezzo filtrante Filter media type	Tessuto poliestere / Polyester Fiber			Tipo mezzo filtrante Filter media type	Tessuto poliestere / Polyester Fiber	
Cartuccia primaria abbinata Matched primary cartridge	Stile / Style	Rotondo a tenuta assiale Round axial seal		Cartuccia primaria abbinata Matched primary cartridge	Stile / Style	Rotondo a tenuta assiale Round axial seal	
8001110600	Tipo / Type	Cartuccia di sicurezza / Security cartridge		8001103800	Tipo / Type	Cartuccia di sicurezza / Security cartridge	
	Note / Notes	L'altezza non include la guarnizione Height not include gasket			Note / Notes	L'altezza non include la guarnizione Height not include gasket	
Codice / Code	8001111000	mm	inch	Codice / Code	8001111700	mm	inch
	Altezza / Height	287	11,30		Altezza / Height	344	13,54
	Diametro esterno Outer diameter	85	3,35		Diametro esterno Outer diameter	201	7,91
	Diametro interno Internal diameter	75	2,95		Diametro interno Internal diameter	90	3,54
	Diametro foro borchia Stud hole diameter	8,5	0,33		Diametro foro borchia Stud hole diameter	19	0,75
	Tipo mezzo filtrante Filter media type	Tessuto poliestere / Polyester Fiber			Tipo mezzo filtrante Filter media type	Cellulosa / Cellulose	
Cartuccia primaria abbinata Matched primary cartridge	Stile / Style	Rotondo a tenuta assiale Round axial seal		Cartuccia di sicurezza abbinata Matched security cartridge	Stile / Style	Rotondo a tenuta assiale con alette Round axial seal with fins	
8001100300	Tipo / Type	Cartuccia di sicurezza / Security cartridge		8001123900	Tipo / Type	Cartuccia primaria / Primary cartridge	
	Note / Notes	L'altezza non include la guarnizione Height not include gasket			Note / Notes	L'altezza non include la guarnizione Height not include gasket	
Codice / Code	8001121000	mm	inch	Codice / Code	8001121100	mm	inch
	Altezza / Height	55	2,17		Altezza / Height	568	22,36
	Diametro esterno Outer diameter	140	5,51		Diametro esterno Outer diameter	265	10,43
	Diametro interno Internal diameter	94	3,70		Diametro interno Internal diameter	153	6,02
	Diametro foro borchia Stud hole diameter	-	-		Diametro foro borchia Stud hole diameter	17	0,67
	Tipo mezzo filtrante Filter media type	Cellulosa / Cellulose			Tipo mezzo filtrante Filter media type	Cellulosa / Cellulose	
	Stile / Style	Rotondo a tenuta assiale Round axial seal			Stile / Style	Rotondo a tenuta assiale Round axial seal	
	Tipo / Type	-			Tipo / Type	Cartuccia primaria / Primary cartridge	
	Note / Notes	-			Note / Notes	L'altezza non include la guarnizione Height not include gasket	
Codice / Code	8001121900	mm	inch	Codice / Code	8001123900	mm	inch
	Altezza / Height	190	7,48		Altezza / Height	330	12,99
	Diametro esterno sup. Upper outer diameter	104	4,09		Diametro esterno sup. Upper outer diameter	120	4,72
	Diametro interno Internal diameter	63	2,48		Diametro esterno inf. Lower outer diameter	85	3,35
	Diametro foro borchia Stud hole diameter	19	0,75		Diametro interno Internal diameter	79	3,11
	Tipo mezzo filtrante Filter media type	Cellulosa / Cellulose			Diametro foro borchia Stud hole diameter	10,5	0,41
	Stile / Style	Rotondo a tenuta assiale con alette Round axial seal with fins		Cartuccia primaria abbinata Matched primary cartridge	Tipo mezzo filtrante Filter media type	Tessuto poliestere / Polyester Fiber	
	Tipo / Type	Cartuccia primaria / Primary cartridge		8001111700	Stile / Style	Rotondo a tenuta assiale Round axial seal	
	Note / Notes	L'altezza non include la guarnizione Height not include gasket			Tipo / Type	Cartuccia di sicurezza / Security cartridge	
					Note / Notes	L'altezza non include la guarnizione Height not include gasket	

Codice / Code	8001124600	mm	inch	Codice / Code	8001125200	mm	inch
	Altezza / Height	262	10,31		Altezza / Height	290	11,42
	Diametro esterno Outer diameter	90	3,54		Diametro esterno Outer diameter	90	3,54
	Diametro interno Internal diameter	60	2,36		Diametro interno Internal diameter	60	2,36
	Diametro foro borchia Stud hole diameter	8,5	0,33		Diametro foro borchia Stud hole diameter	8,5	0,33
	Tipo mezzo filtrante Filter media type	Cellulosa / Cellulose			Tipo mezzo filtrante Filter media type	Cellulosa / Cellulose	
Cartuccia primaria abbinata Matched primary cartridge	Stile / Style	Rotondo a tenuta assiale Round axial seal		Cartuccia primaria abbinata Matched primary cartridge	Stile / Style	Rotondo a tenuta assiale Round axial seal	
8001125500	Tipo / Type	Cartuccia di sicurezza / Security cartridge		8001105600	Tipo / Type	Cartuccia di sicurezza / Security cartridge	
	Note / Notes	L'altezza non include la guarnizione Height not include gasket			Note / Notes	L'altezza non include la guarnizione Height not include gasket	
Codice / Code	8001125300	mm	inch	Codice / Code	8001125400	mm	inch
	Altezza / Height	290	11,42		Altezza / Height	304	11,97
	Diametro esterno Outer diameter	90	3,54		Diametro esterno Outer diameter	155	6,10
	Diametro interno Internal diameter	60	2,36		Diametro interno Internal diameter	82,5	3,25
	Diametro foro borchia Stud hole diameter	8,5	0,33		Diametro foro borchia Stud hole diameter	18	0,71
	Tipo mezzo filtrante Filter media type	Cellulosa / Cellulose			Tipo mezzo filtrante Filter media type	Cellulosa / Cellulose	
	Stile / Style	Rotondo a tenuta assiale Round axial seal		Cartuccia di sicurezza abbinata Matched security cartridge	Stile / Style	Rotondo a tenuta assiale con alette Round axial seal with fins	
	Tipo / Type	Cartuccia di sicurezza / Security cartridge		8001111000	Tipo / Type	Cartuccia primaria / Primary cartridge	
	Note / Notes	L'altezza non include la guarnizione Height not include gasket			Note / Notes	L'altezza non include la guarnizione Height not include gasket	
Codice / Code	8001125500	mm	inch	Codice / Code	8001126900	mm	inch
	Altezza / Height	280	11,02		Altezza / Height	262	10,31
	Diametro esterno Outer diameter	134	5,28		Diametro esterno Outer diameter	90	3,54
	Diametro interno Internal diameter	82,5	3,25		Diametro interno Internal diameter	60	2,36
	Diametro foro borchia Stud hole diameter	19	0,75		Diametro foro borchia Stud hole diameter	8,5	0,33
	Tipo mezzo filtrante Filter media type	Cellulosa / Cellulose			Tipo mezzo filtrante Filter media type	Cellulosa / Cellulose	
Cartuccia di sicurezza abbinata Matched security cartridge	Stile / Style	Rotondo a tenuta assiale con alette Round axial seal with fins		Cartuccia primaria abbinata Matched primary cartridge	Stile / Style	Rotondo a tenuta assiale Round axial seal	
8001126900	Tipo / Type	Cartuccia primaria / Primary cartridge		8001125500	Tipo / Type	Cartuccia di sicurezza / Security cartridge	
	Note / Notes	L'altezza non include la guarnizione Height not include gasket			Note / Notes	L'altezza non include la guarnizione Height not include gasket	
Codice / Code	8001128800	mm	inch	Codice / Code	8001129500	mm	inch
	Altezza / Height	383	15,08		Altezza / Height	383	15,08
	Diametro esterno Outer diameter	155	6,10		Diametro esterno Outer diameter	134	5,28
	Diametro interno Internal diameter	88	3,46		Diametro interno Internal diameter	92,5	3,64
	Diametro foro borchia Stud hole diameter	19	0,75		Diametro foro borchia Stud hole diameter	19	0,75
	Tipo mezzo filtrante Filter media type	Cellulosa / Cellulose			Tipo mezzo filtrante Filter media type	Cellulosa / Cellulose	
Cartuccia di sicurezza abbinata Matched security cartridge	Stile / Style	Rotondo a tenuta assiale con alette Round axial seal with fins		Cartuccia di sicurezza abbinata Matched security cartridge	Stile / Style	Rotondo a tenuta assiale con alette Round axial seal with fins	
8001131600	Tipo / Type	Cartuccia primaria / Primary cartridge		8001131500	Tipo / Type	Cartuccia primaria / Primary cartridge	
	Note / Notes	L'altezza non include la guarnizione Height not include gasket			Note / Notes	L'altezza non include la guarnizione Height not include gasket	











Codice / Code	8001130800	mm	inch	Codice / Code	8001131500	mm	inch
	Altezza / Height	406	15,98		Altezza / Height	352	13,86
	Diametro esterno Outer diameter	201	7,91		Diametro esterno sup. Upper outer diameter	91	3,58
	Diametro interno Internal diameter	135	5,31		Diametro esterno inf. Lower outer diameter	85	3,35
	Diametro foro borchia Stud hole diameter	19	0,75		Diametro interno Internal diameter	74	2,91
	Tipo mezzo filtrante Filter media type	Cellulosa / Cellulose			Diametro foro borchia Stud hole diameter	17	0,67
	Stile / Style	Rotondo a tenuta assiale con alette Round axial seal with fins			Tipo mezzo filtrante Filter media type	Tessuto poliestere / Polyester Fiber	
8001131700	Tipo / Type	Cartuccia primaria / Primary cartridge	8001129500	Stile / Style	Rotondo a tenuta assiale Round axial seal		
	Note / Notes	L'altezza non include la guarnizione Height not include gasket		Tipo / Type	Cartuccia di sicurezza / Security cartridge		
				Note / Notes	L'altezza non include la guarnizione Height not include gasket		
Codice / Code	8001131600	mm	inch	Codice / Code	8001131700	mm	inch
	Altezza / Height	355	13,98		Altezza / Height	397	15,63
	Diametro esterno sup. Upper outer diameter	106	4,17		Diametro esterno sup. Upper outer diameter	145	5,71
	Diametro esterno inf. Lower outer diameter	85	3,35		Diametro esterno inf. Lower outer diameter	117	4,61
	Diametro interno Internal diameter	74	2,91		Diametro interno Internal diameter	88	3,46
	Diametro foro borchia Stud hole diameter	17	0,67		Diametro foro borchia Stud hole diameter	17	0,67
	Tipo mezzo filtrante Filter media type	Tessuto poliestere / Polyester Fiber			Tipo mezzo filtrante Filter media type	Cellulosa / Cellulose	
8001128800	Stile / Style	Rotondo a tenuta assiale Round axial seal	8001127600	Stile / Style	Rotondo a tenuta assiale Round axial seal		
	Tipo / Type	Cartuccia di sicurezza / Security cartridge		Tipo / Type	Cartuccia di sicurezza / Security cartridge		
	Note / Notes	L'altezza non include la guarnizione Height not include gasket		Note / Notes	L'altezza non include la guarnizione Height not include gasket		
Codice / Code	8001134300	mm	inch	Codice / Code	8001134800	mm	inch
	Altezza / Height	330	12,99		Altezza / Height	66	2,60
	Diametro esterno sup. Upper outer diameter	234	9,21		Diametro esterno Outer diameter	140	5,51
	Diametro esterno inf. Lower outer diameter	275	10,83		Diametro interno Internal diameter	94	3,70
	Diametro interno Internal diameter	124	4,88		Diametro foro borchia Stud hole diameter	-	-
	Diametro foro borchia Stud hole diameter	14	0,55		Tipo mezzo filtrante Filter media type	Cellulosa / Cellulose	
	Tipo mezzo filtrante Filter media type	Cellulosa / Cellulose			Stile / Style	Rotondo a tenuta assiale Round axial seal	
	Stile / Style	Rotondo a tenuta assiale Round axial seal		Tipo / Type	-		
	Tipo / Type	Cartuccia primaria / Primary cartridge		Note / Notes	-		
	Note / Notes	L'altezza non include la guarnizione Height not include gasket					
Codice / Code	8001136000	mm	inch	Codice / Code	8001138800	mm	inch
	Altezza / Height	95	3,74		Altezza / Height	345	13,58
	Diametro esterno Outer diameter	183	7,20		Diametro esterno Outer diameter	234	9,21
	Diametro interno Internal diameter	107	4,21		Diametro interno Internal diameter	127	5,00
	Diametro foro borchia Stud hole diameter	M6	M6		Diametro foro borchia Stud hole diameter	16,5	0,65
	Tipo mezzo filtrante Filter media type	Cellulosa / Cellulose			Tipo mezzo filtrante Filter media type	Cellulosa / Cellulose	
	Stile / Style	Rotondo a tenuta assiale Round axial seal			Stile / Style	Rotondo a tenuta assiale con alette Round axial seal with fins	
	Tipo / Type	-	8001139000	Tipo / Type	Cartuccia primaria / Primary cartridge		
	Note / Notes	-		Note / Notes	L'altezza non include la guarnizione Height not include gasket		









Codice / Code	8001138900	mm	inch	Codice / Code	8001139000	mm	inch
	Altezza / Height	330	12,99		Altezza / Height	331	13,03
	Diametro esterno Outer diameter	234	9,21		Diametro esterno Outer diameter	110	4,33
	Diametro interno Internal diameter	124	4,88		Diametro interno Internal diameter	70	2,76
	Diametro foro borchia Stud hole diameter	16,5	0,65		Diametro foro borchia Stud hole diameter	19,2	0,76
	Tipo mezzo filtrante Filter media type	Cellulosa / Cellulose			Tipo mezzo filtrante Filter media type	Tessuto poliestere / Polyester Fiber	
Cartuccia di sicurezza abbinata Matched security cartridge 8001139100	Stile / Style	Rotondo a tenuta assiale Round axial seal		Cartuccia primaria abbinata Matched primary cartridge 8001138800	Stile / Style	Rotondo a tenuta assiale Round axial seal	
	Tipo / Type	Cartuccia primaria / Primary cartridge			Tipo / Type	Cartuccia di sicurezza / Security cartridge	
	Note / Notes	L'altezza non include la guarnizione Height not include gasket			Note / Notes	L'altezza non include la guarnizione Height not include gasket	











Codice / Code	8001139100	mm	inch	Codice / Code	8001146300	mm	inch
	Altezza / Height	330	12,99		Altezza / Height	71	2,80
	Diametro esterno sup. Upper outer diameter	145	5,71		Diametro esterno Outer diameter	140	5,51
	Diametro esterno inf. Lower outer diameter	117	4,61		Diametro interno Internal diameter	94	3,70
	Diametro interno Internal diameter	88	3,46		Diametro foro borchia Stud hole diameter	-	-
	Diametro foro borchia Stud hole diameter	17	0,67		Tipo mezzo filtrante Filter media type	Cellulosa / Cellulose	
Cartuccia primaria abbinata Matched primary cartridge 8001138900	Tipo mezzo filtrante Filter media type	Cellulosa / Cellulose		Stile / Style	Rotondo a tenuta assiale Round axial seal		
	Stile / Style	Rotondo a tenuta assiale Round axial seal			Tipo / Type	-	
	Tipo / Type	Cartuccia di sicurezza / Security cartridge			Note / Notes	-	
Note / Notes	L'altezza non include la guarnizione Height not include gasket						

Codice / Code	8001146700	mm	inch	Codice / Code	8001155500	mm	inch
	Altezza / Height	355	13,98		Altezza / Height	145	5,71
	Diametro esterno Outer diameter	104	4,09		Diametro esterno Outer diameter	104	4,09
	Diametro interno Internal diameter	63	2,48		Diametro interno Internal diameter	63	2,48
	Diametro foro borchia Stud hole diameter	18	0,71		Diametro foro borchia Stud hole diameter	18	0,71
	Tipo mezzo filtrante Filter media type	Cellulosa / Cellulose			Tipo mezzo filtrante Filter media type	Cellulosa / Cellulose	
Cartuccia di sicurezza abbinata Matched security cartridge 8001341000	Stile / Style	Rotondo a tenuta assiale con alette Round axial seal with fins		Cartuccia di sicurezza abbinata Matched security cartridge 8001161800	Stile / Style	Rotondo a tenuta assiale con alette Round axial seal with fins	
	Tipo / Type	Cartuccia primaria / Primary cartridge			Tipo / Type	Cartuccia primaria / Primary cartridge	
	Note / Notes	L'altezza non include la guarnizione Height not include gasket			Note / Notes	L'altezza non include la guarnizione Height not include gasket	

Codice / Code	8001159000	mm	inch	Codice / Code	8001160300	mm	inch
	Altezza / Height	304	11,97		Altezza / Height	100	3,94
	Diametro esterno Outer diameter	155	6,10		Diametro esterno Outer diameter	120	4,72
	Diametro interno Internal diameter	88	3,46		Diametro interno Internal diameter	70	2,76
	Diametro foro borchia Stud hole diameter	19	0,75		Diametro foro borchia Stud hole diameter	M6	M6
	Tipo mezzo filtrante Filter media type	Cellulosa / Cellulose			Tipo mezzo filtrante Filter media type	Cellulosa / Cellulose	
Stile / Style	Rotondo a tenuta assiale con alette Round axial seal with fins		Tipo / Type	Rotondo a tenuta assiale Round axial seal			
	Cartuccia primaria / Primary cartridge			-			
	L'altezza non include la guarnizione Height not include gasket			-			

Codice / Code	8001161800	mm	inch	Codice / Code	8001162100	mm	inch
 <p>Cartuccia primaria abbinata Matched primary cartridge 8001155500</p>	Altezza / Height	134	5,28		Altezza / Height	340	13,39
	Diametro esterno Outer diameter	62	2,44		Diametro esterno Outer diameter	170	6,69
	Diametro interno Internal diameter	52	2,05		Diametro interno Internal diameter	91,5	3,60
	Diametro foro borchia Stud hole diameter	8,5	0,33		Diametro foro borchia Stud hole diameter	8	0,31
	Tipo mezzo filtrante Filter media type	Tessuto poliestere / Polyester Fiber			Tipo mezzo filtrante Filter media type	Cellulosa / Cellulose	
	Stile / Style	Rotondo a tenuta assiale Round axial seal			Stile / Style	Rotondo a tenuta assiale Round axial seal	
Tipo / Type	Cartuccia di sicurezza / Security cartridge		Tipo / Type	Cartuccia primaria / Primary cartridge			
Note / Notes	L'altezza non include la guarnizione Height not include gasket		Note / Notes	-			
Codice / Code	8001162200	mm	inch	Codice / Code	8001162300	mm	inch
	Altezza / Height	95	3,74		Altezza / Height	202	7,95
	Diametro esterno Outer diameter	183	7,20		Diametro esterno Outer diameter	170	6,69
	Diametro interno Internal diameter	106	4,17		Diametro interno Internal diameter	91,5	3,60
	Diametro foro borchia Stud hole diameter	9,5	0,37		Diametro foro borchia Stud hole diameter	8	0,31
	Tipo mezzo filtrante Filter media type	Cellulosa / Cellulose			Tipo mezzo filtrante Filter media type	Cellulosa / Cellulose	
	Stile / Style	Rotondo a tenuta assiale Round axial seal			Stile / Style	Rotondo a tenuta assiale Round axial seal	
Tipo / Type	Cartuccia primaria / Primary cartridge		Tipo / Type	Cartuccia primaria / Primary cartridge			
Note / Notes	L'altezza non include la guarnizione Height not include gasket		Note / Notes	L'altezza non include la guarnizione Height not include gasket			
Codice / Code	8001165500	mm	inch	Codice / Code	8001167500	mm	inch
	Altezza / Height	340	13,39		Altezza / Height	175	6,89
	Diametro esterno sup. Upper outer diameter	66	2,60		Diametro esterno Outer diameter	83	3,27
	Diametro esterno inf. Lower outer diameter	62	2,44		Diametro interno Internal diameter	46	1,81
	Diametro interno Internal diameter	48	1,89		Diametro foro borchia Stud hole diameter	10	0,39
	Diametro foro borchia Stud hole diameter	8,5	0,33		Tipo mezzo filtrante Filter media type	Cellulosa / Cellulose	
	Tipo mezzo filtrante Filter media type	Tessuto poliestere / Polyester Fiber			Stile / Style	Rotondo a tenuta assiale con alette Round axial seal with fins	
Stile / Style	Rotondo a tenuta assiale Round axial seal		Tipo / Type	Cartuccia primaria / Primary cartridge			
Tipo / Type	Cartuccia primaria / Primary cartridge		Note / Notes	L'altezza non include la guarnizione Height not include gasket			
Note / Notes	L'altezza non include la guarnizione Height not include gasket						
Codice / Code	8001170200	mm	inch	Codice / Code	8001171200	mm	inch
	Altezza / Height	360	14,17		Altezza / Height	217	8,54
	Diametro esterno Outer diameter	190	7,48		Diametro esterno Outer diameter	234	9,21
	Diametro interno Internal diameter	116	4,57		Diametro interno Internal diameter	124	4,88
	Diametro foro borchia Stud hole diameter	-	-		Diametro foro borchia Stud hole diameter	15	0,59
	Tipo mezzo filtrante Filter media type	Cellulosa / Cellulose			Tipo mezzo filtrante Filter media type	Cellulosa / Cellulose	
	Stile / Style	Rotondo / Round			Stile / Style	Rotondo a tenuta assiale Round axial seal	
Tipo / Type	-		Tipo / Type	Cartuccia primaria / Primary cartridge			
Note / Notes	L'altezza non include la guarnizione Height not include gasket		Note / Notes	L'altezza non include la guarnizione Height not include gasket			
Codice / Code	8001171600	mm	inch	Codice / Code	8001173000	mm	inch
	Altezza / Height	100	3,94		Altezza / Height	150	5,91
	Diametro esterno Outer diameter	120	4,72		Diametro esterno Outer diameter	155	6,10
	Diametro interno Internal diameter	65	2,56		Diametro interno Internal diameter	88	3,46
	Diametro foro borchia Stud hole diameter	6,5	0,26		Diametro foro borchia Stud hole diameter	19	0,75
	Tipo mezzo filtrante Filter media type	Cellulosa / Cellulose			Tipo mezzo filtrante Filter media type	Cellulosa / Cellulose	
	Stile / Style	Rotondo a tenuta assiale Round axial seal			Stile / Style	Rotondo a tenuta assiale con alette Round axial seal with fins	
Tipo / Type	-		Tipo / Type	Cartuccia primaria / Primary cartridge			
Note / Notes	-		Note / Notes	L'altezza non include la guarnizione Height not include gasket			

Codice / Code	8001173100	mm	inch	Codice / Code	8001173200	mm	inch
	Altezza / Height	200	7,87		Altezza / Height	402	15,83
	Diametro esterno Outer diameter	183	7,20		Diametro esterno Outer diameter	234	9,21
	Diametro interno Internal diameter	120	4,72		Diametro interno Internal diameter	133	5,24
	Diametro foro borchia Stud hole diameter	M6	M6		Diametro foro borchia Stud hole diameter	16,5	0,65
	Tipo mezzo filtrante Filter media type	Cellulosa / Cellulose			Tipo mezzo filtrante Filter media type	Elemento filtrante metallico Metallic filter element	
	Stile / Style	Rotondo a tenuta assiale Round axial seal			Stile / Style	Rotondo a tenuta assiale Round axial seal	
Tipo / Type	-		Tipo / Type	-			
Note / Notes	-		Note / Notes	L'altezza non include la guarnizione Height not include gasket			
Codice / Code	8001174900	mm	inch	Codice / Code	8001175200	mm	inch
	Altezza / Height	284	11,18		Altezza / Height	202	7,95
	Diametro esterno Outer diameter	120	4,72		Diametro esterno Outer diameter	164	6,46
	Diametro interno Internal diameter	70	2,76		Diametro interno Internal diameter	86	3,39
	Diametro foro borchia Stud hole diameter	6,5	0,26		Diametro foro borchia Stud hole diameter	9	0,35
	Tipo mezzo filtrante Filter media type	Cellulosa / Cellulose			Tipo mezzo filtrante Filter media type	Elemento filtrante metallico Metallic filter element	
	Stile / Style	Rotondo a tenuta assiale Round axial seal			Stile / Style	Rotondo a tenuta assiale Round axial seal	
Tipo / Type	-		Tipo / Type	-			
Note / Notes	-		Note / Notes	L'altezza non include la guarnizione Height not include gasket			
Codice / Code	8001175500	mm	inch	Codice / Code	8001175800	mm	inch
	Altezza / Height	332	13,07		Altezza / Height	94	3,70
	Diametro esterno Outer diameter	164	6,46		Diametro esterno Outer diameter	120	4,72
	Diametro interno Internal diameter	86	3,39		Diametro interno Internal diameter	80	3,15
	Diametro foro borchia Stud hole diameter	9	0,35		Diametro foro borchia Stud hole diameter	6,5	0,26
	Tipo mezzo filtrante Filter media type	Elemento filtrante metallico Metallic filter element			Tipo mezzo filtrante Filter media type	Elemento filtrante metallico Metallic filter element	
	Stile / Style	Rotondo a tenuta assiale Round axial seal			Stile / Style	Rotondo a tenuta assiale Round axial seal	
Tipo / Type	-		Tipo / Type	-			
Note / Notes	L'altezza non include la guarnizione Height not include gasket		Note / Notes	L'altezza non include la guarnizione Height not include gasket			
Codice / Code	8001176100	mm	inch	Codice / Code	8001176400	mm	inch
	Altezza / Height	58	2,28		Altezza / Height	788	31,02
	Diametro esterno Outer diameter	134	5,28		Diametro esterno Outer diameter	392	15,43
	Diametro interno Internal diameter	92,5	3,64		Diametro interno Internal diameter	302	11,89
	Diametro foro borchia Stud hole diameter	-	-		Diametro foro borchia Stud hole diameter	14	0,55
	Tipo mezzo filtrante Filter media type	Elemento filtrante metallico Metallic filter element			Tipo mezzo filtrante Filter media type	Cellulosa / Cellulose	
	Stile / Style	Rotondo a tenuta assiale Round axial seal			Stile / Style	Rotondo a tenuta assiale Round axial seal	
Tipo / Type	-		Tipo / Type	Cartuccia primaria / Primary cartridge			
Note / Notes	L'altezza non include la guarnizione Height not include gasket		Note / Notes	L'altezza non include la guarnizione Height not include gasket			

Codice / Code	8001178900	mm	inch	Codice / Code	8001180800	mm	inch
	Altezza / Height	218	8,58		Altezza / Height	360	14,17
	Diametro esterno Outer diameter	150	5,91		Diametro esterno Outer diameter	190	7,48
	Diametro interno Internal diameter	72	2,83		Diametro interno Internal diameter	130	5,12
	Diametro foro borchia Stud hole diameter	11	0,43		Diametro foro borchia Stud hole diameter	11	0,43
	Tipo mezzo filtrante Filter media type	Cellulosa / Cellulose			Tipo mezzo filtrante Filter media type	Cellulosa / Cellulose	
	Stile / Style	Rotondo a tenuta assiale Round axial seal			Stile / Style	Rotondo a tenuta assiale Round axial seal	
	Tipo / Type	Cartuccia primaria / Primary cartridge			Tipo / Type	Cartuccia primaria / Primary cartridge	
	Note / Notes	L'altezza non include la guarnizione Height not include gasket			Note / Notes	L'altezza non include la guarnizione Height not include gasket	
Codice / Code	8001183700	mm	inch	Codice / Code	8001188000	mm	inch
	Altezza / Height	150	5,91		Altezza / Height	289	11,38
	Diametro esterno Outer diameter	155	6,10		Diametro esterno sup. Upper outer diameter	162	6,38
	Diametro interno Internal diameter	88	3,46		Diametro esterno inf. Lower outer diameter	138	5,43
	Diametro foro borchia Stud hole diameter	19	0,75		Diametro interno Internal diameter	72	2,83
	Tipo mezzo filtrante Filter media type	Cellulosa / Cellulose			Diametro foro borchia Stud hole diameter	7/16 UNF - 20	
	Stile / Style	Rotondo a tenuta assiale Round axial seal			Tipo mezzo filtrante Filter media type	Cellulosa / Cellulose	
	Tipo / Type	Cartuccia primaria / Primary cartridge			Stile / Style	Rotondo a tenuta assiale con alette Round axial seal with fins	
	Note / Notes	L'altezza non include la guarnizione Height not include gasket			Tipo / Type	Cartuccia primaria / Primary cartridge	
				Note / Notes	L'altezza non include la guarnizione Height not include gasket		
Codice / Code	8001192900	mm	inch	Codice / Code	8001193500	mm	inch
	Altezza / Height	145	5,71		Altezza / Height	382	15,04
	Diametro esterno Outer diameter	120	4,72		Diametro esterno sup. Upper outer diameter	214	8,43
	Diametro interno Internal diameter	70	2,76		Diametro esterno inf. Lower outer diameter	195	7,68
	Diametro foro borchia Stud hole diameter	6,5	0,26		Diametro interno Internal diameter	88	3,46
	Tipo mezzo filtrante Filter media type	Cellulosa / Cellulose			Diametro foro borchia Stud hole diameter	7/16 UNF - 20	
	Stile / Style	Rotondo a tenuta assiale Round axial seal			Tipo mezzo filtrante Filter media type	Cellulosa / Cellulose	
	Tipo / Type	-			Stile / Style	Rotondo a tenuta assiale con alette Round axial seal with fins	
	Note / Notes	-			Tipo / Type	Cartuccia primaria / Primary cartridge	
				Note / Notes	L'altezza non include la guarnizione Height not include gasket		
Codice / Code	8001194000	mm	inch	Codice / Code	8001194100	mm	inch
	Altezza / Height	600	23,62		Altezza / Height	344	13,54
	Diametro esterno Outer diameter	324	12,76		Diametro esterno sup. Upper outer diameter	170	6,69
	Diametro interno Internal diameter	214	8,43		Diametro esterno inf. Lower outer diameter	137	5,39
	Diametro foro borchia Stud hole diameter	13	0,51		Diametro interno Internal diameter	72	2,83
	Tipo mezzo filtrante Filter media type	Cellulosa / Cellulose			Diametro foro borchia Stud hole diameter	M10 x 1,5	M10 x 1,5
	Stile / Style	Rotondo a tenuta assiale Round axial seal			Tipo mezzo filtrante Filter media type	Cellulosa / Cellulose	
	Tipo / Type	-			Stile / Style	Rotondo a tenuta assiale con alette Round axial seal with fins	
	Note / Notes	L'altezza non include la guarnizione Height not include gasket			Tipo / Type	Cartuccia primaria / Primary cartridge	
				Note / Notes	L'altezza non include la guarnizione Height not include gasket		
Codice / Code	8001194200	mm	inch	Codice / Code	8001195800	mm	inch
	Altezza / Height	378	14,88		Altezza / Height	79	3,11
	Diametro esterno sup. Upper outer diameter	213	8,39		Diametro esterno Outer diameter	140	5,51
	Diametro esterno inf. Lower outer diameter	197	7,76		Diametro interno Internal diameter	94	3,70
	Diametro interno Internal diameter	87	3,43		Diametro foro borchia Stud hole diameter	-	-
	Diametro foro borchia Stud hole diameter	7/16 UNF - 20			Tipo mezzo filtrante Filter media type	Cellulosa / Cellulose	
	Tipo mezzo filtrante Filter media type	Cellulosa / Cellulose			Stile / Style	Rotondo a tenuta assiale Round axial seal	
	Stile / Style	Rotondo a tenuta assiale Round axial seal			Tipo / Type	-	
	Tipo / Type	Cartuccia primaria / Primary cartridge			Note / Notes	-	
	Note / Notes	L'altezza non include la guarnizione Height not include gasket					



Codice / Code	8001199800	mm	inch	Codice / Code	8001204800	mm	inch
	Altezza / Height	225	8,86		Altezza / Height	251	9,88
	Diametro esterno Outer diameter	155	6,10		Diametro esterno sup. Upper outer diameter	92,5	3,64
	Diametro interno Internal diameter	88	3,46		Diametro esterno inf. Lower outer diameter	70	2,76
	Diametro foro borchia Stud hole diameter	19	0,75		Diametro interno Internal diameter	92	3,62
	Tipo mezzo filtrante Filter media type	Cellulosa / Cellulose			Diametro foro borchia Stud hole diameter	17	0,67
Stile / Style	Rotondo a tenuta assiale con alette Round axial seal with fins		Tipo mezzo filtrante Filter media type	Tessuto poliestere / Polyester Fiber			
Tipo / Type	Cartuccia primaria / Primary cartridge		Stile / Style	Rotondo a tenuta assiale Round axial seal			
Note / Notes	L'altezza non include la guarnizione Height not include gasket		Tipo / Type	Cartuccia di sicurezza / Security cartridge			
			Note / Notes	L'altezza non include la guarnizione Height not include gasket			

Cartuccia di sicurezza
abbinata
Matched security cartridge

8001210600

Cartuccia primaria abbinata
Matched primary cartridge

8001188000

Codice / Code	8001209100	mm	inch	Codice / Code	8001209300	mm	inch
	Altezza / Height	200	7,87		Altezza / Height	656	25,83
	Diametro esterno Outer diameter	164	6,46		Diametro esterno sup. Upper outer diameter	335	13,19
	Diametro interno Internal diameter	86	3,39		Diametro esterno inf. Lower outer diameter	280	11,02
	Tipo mezzo filtrante Filter media type	Cellulosa / Cellulose			Diametro interno Internal diameter	182	7,17
	Stile / Style	Rotondo a tenuta assiale Round axial seal			Tipo mezzo filtrante Filter media type	Cellulosa / Cellulose	
Tipo / Type	Cartuccia primaria / Primary cartridge		Stile / Style	Rotondo a tenuta assiale Round axial seal			
Note / Notes	L'altezza non include la guarnizione Height not include gasket		Tipo / Type	-			
			Note / Notes	L'altezza non include la guarnizione Height not include gasket			

Cartuccia di sicurezza
abbinata
Matched security cartridge

8001475800

Codice / Code	8001210600	mm	inch	Codice / Code	8001213500	mm	inch
	Altezza / Height	186	7,32		Altezza / Height	64	2,52
	Diametro esterno sup. Upper outer diameter	106	4,17		Diametro esterno Outer diameter	210	8,27
	Diametro esterno inf. Lower outer diameter	85	3,35		Diametro interno Internal diameter	165	6,50
	Diametro interno Internal diameter	74	2,91		Diametro foro borchia Stud hole diameter	-	-
	Diametro foro borchia Stud hole diameter	10,2	0,40		Tipo mezzo filtrante Filter media type	Cellulosa / Cellulose	
Tipo mezzo filtrante Filter media type	Tessuto poliestere / Polyester fiber		Stile / Style	Rotondo a tenuta assiale Round axial seal			
Stile / Style	Rotondo a tenuta assiale Round axial seal		Tipo / Type	-			
Tipo / Type	Cartuccia di sicurezza / Security cartridge		Note / Notes	-			
Note / Notes	L'altezza non include la guarnizione Height not include gasket						

Codice / Code	8001215000	mm	inch	Codice / Code	8001217700	mm	inch	
	Altezza / Height	66	2,60		Altezza / Height	96	3,78	
	Diametro esterno Outer diameter	168	6,61		Diametro esterno Outer diameter	210	8,27	
	Diametro interno Internal diameter	108	4,25		Diametro interno Internal diameter	149,5	5,89	
	Tipo mezzo filtrante Filter media type	Cellulosa / Cellulose			Tipo mezzo filtrante Filter media type	Cellulosa / Cellulose		
	Stile / Style	Rotondo a tenuta assiale Round axial seal			Stile / Style	Rotondo a tenuta assiale Round axial seal		
Tipo / Type	-		Tipo / Type	-				

Codice / Code	8001218100	mm	inch	Codice / Code	8001220200	mm	inch
	Altezza / Height	240	9,45		Altezza / Height	190	7,48
	Diametro esterno Outer diameter	83	3,27		Diametro esterno Outer diameter	104	4,09
	Diametro interno Internal diameter	54	2,13		Diametro interno Internal diameter	63	2,48
	Diametro foro borchia Stud hole diameter	16,5	0,65		Diametro foro borchia Stud hole diameter	19	0,75
	Tipo mezzo filtrante Filter media type	Cellulosa / Cellulose			Tipo mezzo filtrante Filter media type	Cellulosa / Cellulose	
	Stile / Style	Rotondo a tenuta assiale Round axial seal			Stile / Style	Rotondo a tenuta assiale con alette Round axial seal with fins	
	Tipo / Type	Cartuccia primaria / Primary cartridge			Tipo / Type	Cartuccia primaria / Primary cartridge	
	Note / Notes	L'altezza non include la guarnizione Height not include gasket			Note / Notes	L'altezza non include la guarnizione Height not include gasket	

Codice / Code	8001220300	mm	inch	Codice / Code	8001220500	mm	inch
	Altezza / Height	406	15,98		Altezza / Height	316	12,44
	Diametro esterno Outer diameter	236	9,29		Diametro esterno sup. Upper outer diameter	162	6,38
	Diametro interno Internal diameter	124	4,88		Diametro esterno inf. Lower outer diameter	149	5,87
	Diametro foro borchia Stud hole diameter	12	0,47		Diametro interno Internal diameter	80,5	3,17
	Tipo mezzo filtrante Filter media type	Cellulosa / Cellulose			Diametro foro borchia Stud hole diameter	-	-
	Stile / Style	Rotondo a tenuta assiale Round axial seal			Tipo mezzo filtrante Filter media type	Cellulosa / Cellulose	
	Tipo / Type	Cartuccia primaria / Primary cartridge			Stile / Style	Rotondo a tenuta assiale con alette Round axial seal with fins	
	Note / Notes	L'altezza non include la guarnizione Height not include gasket			Tipo / Type	Cartuccia primaria / Primary cartridge	
				Note / Notes	L'altezza non include la guarnizione Height not include gasket		

Codice / Code	8001220800	mm	inch	Codice / Code	8001221000	mm	inch
	Altezza / Height	305	12,01		Altezza / Height	406	15,98
	Diametro esterno Outer diameter	234	9,21		Diametro esterno sup. Upper outer diameter	282	11,10
	Diametro interno Internal diameter	123	4,84		Diametro interno Internal diameter	170,5	6,71
	Tipo mezzo filtrante Filter media type	Cellulosa / Cellulose			Tipo mezzo filtrante Filter media type	Cellulosa / Cellulose	
	Stile / Style	Rotondo a tenuta assiale Round axial seal			Stile / Style	Rotondo a tenuta assiale Round axial seal	
	Tipo / Type	Cartuccia primaria / Primary cartridge			Tipo / Type	Cartuccia primaria / Primary cartridge	
	Note / Notes	L'altezza non include la guarnizione Height not include gasket			Note / Notes	L'altezza non include la guarnizione Height not include gasket	
	Cartuccia di sicurezza abbinata Matched security cartridge 8001315700					Cartuccia di sicurezza abbinata Matched security cartridge 8001315000	









Codice / Code	8001221400	mm	inch	Codice / Code	8001222100	mm	inch
	Altezza / Height	330	12,99		Altezza / Height	254	10,00
	Diametro esterno Outer diameter	282	11,10		Diametro esterno Outer diameter	155	6,10
	Diametro interno Internal diameter	170	6,69		Diametro interno Internal diameter	88	3,46
	Diametro foro borchia Stud hole diameter	-	-		Diametro foro borchia Stud hole diameter	19	0,75
	Tipo mezzo filtrante Filter media type	Cellulosa / Cellulose			Tipo mezzo filtrante Filter media type	Cellulosa / Cellulose	
	Stile / Style	Rotondo a tenuta assiale Round axial seal			Stile / Style	Rotondo a tenuta assiale con alette Round axial seal with fins	
	Tipo / Type	Cartuccia primaria / Primary cartridge			Tipo / Type	Cartuccia primaria / Primary cartridge	
	Note / Notes	L'altezza non include la guarnizione Height not include gasket			Note / Notes	L'altezza non include la guarnizione Height not include gasket	
Cartuccia di sicurezza abbinata Matched security cartridge 8001315600							









Codice / Code	8001222200	mm	inch	Codice / Code	8001222500	mm	inch
	Altezza / Height	228	8,98		Altezza / Height	321	12,64
	Diametro esterno Outer diameter	104	4,09		Diametro esterno Outer diameter	164	6,46
	Diametro interno Internal diameter	63	2,48		Diametro interno Internal diameter	86	3,39
	Diametro foro borchia Stud hole diameter	19	0,75		Diametro foro borchia Stud hole diameter	-	-
	Tipo mezzo filtrante Filter media type	Cellulosa / Cellulose			Tipo mezzo filtrante Filter media type	Cellulosa / Cellulose	
	Stile / Style	Rotondo a tenuta assiale con alette Round axial seal with fins			Stile / Style	Rotondo a tenuta assiale Round axial seal	
Cartuccia di sicurezza abbinata Matched security cartridge				Cartuccia primaria / Primary cartridge			
8001498000				Note / Notes			
L'altezza non include la guarnizione Height not include gasket				L'altezza non include la guarnizione Height not include gasket			

Codice / Code	8001222600	mm	inch	Codice / Code	8001222800	mm	inch
	Altezza / Height	280	11,02		Altezza / Height	328	12,91
	Diametro esterno sup. Upper outer diameter	92,5	3,64		Diametro esterno Outer diameter	155	6,10
	Diametro esterno inf. Lower outer diameter	75	2,95		Diametro interno Internal diameter	88	3,46
	Diametro interno Internal diameter	62	2,44		Diametro foro borchia Stud hole diameter	17	0,67
	Diametro foro borchia Stud hole diameter	17	0,67		Tipo mezzo filtrante Filter media type	Cellulosa / Cellulose	
	Tipo mezzo filtrante Filter media type	Tessuto poliestere / Polyester Fiber			Stile / Style	Rotondo a tenuta assiale con alette Round axial seal with fins	
Cartuccia primaria abbinata Matched primary cartridge				Cartuccia di sicurezza abbinata Matched security cartridge			
8001105600				8001222900			
Note / Notes				Note / Notes			
L'altezza non include la guarnizione Height not include gasket				L'altezza non include la guarnizione Height not include gasket			

Codice / Code	8001222900	mm	inch	Codice / Code	8001223000	mm	inch
	Altezza / Height	305	12,01		Altezza / Height	284	11,18
	Diametro esterno sup. Upper outer diameter	105	4,13		Diametro esterno sup. Upper outer diameter	126	4,96
	Diametro esterno inf. Lower outer diameter	85	3,35		Diametro interno Internal diameter	65	2,56
	Diametro interno Internal diameter	74	2,91		Diametro foro borchia Stud hole diameter	8,5	0,33
	Diametro foro borchia Stud hole diameter	17	0,67		Tipo mezzo filtrante Filter media type	Cellulosa / Cellulose	
	Tipo mezzo filtrante Filter media type	Tessuto poliestere / Polyester fiber			Stile / Style	Rotondo a tenuta assiale Round axial seal	
Cartuccia primaria abbinata Matched primary cartridge				Cartuccia primaria / Primary cartridge			
8001222800				Note / Notes			
L'altezza non include la guarnizione Height not include gasket				L'altezza non include la guarnizione Height not include gasket			

Codice / Code	8001223100	mm	inch	Codice / Code	8001223400	mm	inch
	Altezza / Height	325	12,80		Altezza / Height	369	14,53
	Diametro esterno Outer diameter	150	5,91		Diametro esterno Outer diameter	227	8,94
	Diametro interno Internal diameter	71	2,80		Diametro interno Internal diameter	117	4,61
	Diametro foro borchia Stud hole diameter	9	0,35		Diametro foro borchia Stud hole diameter	-	-
	Tipo mezzo filtrante Filter media type	Cellulosa / Cellulose			Tipo mezzo filtrante Filter media type	Cellulosa / Cellulose	
	Stile / Style	Rotondo a tenuta assiale Round axial seal			Stile / Style	Rotondo a tenuta assiale Round axial seal	
Cartuccia primaria / Primary cartridge				Cartuccia primaria / Primary cartridge			
8001222800				Note / Notes			
L'altezza non include la guarnizione Height not include gasket				L'altezza non include la guarnizione Height not include gasket			

Codice / Code	8001223500	mm	inch	Codice / Code	8001223800	mm	inch
 <p>Cartuccia di sicurezza abbinata Matched security cartridge</p> <p>8001352900</p>	Altezza / Height	484	19,06		Altezza / Height	484	19,06
	Diametro esterno Outer diameter	242	9,53		Diametro esterno Outer diameter	242	9,53
	Diametro interno Internal diameter	132	5,20		Diametro interno Internal diameter	132	5,20
	Diametro foro borchia Stud hole diameter	11	0,43		Diametro foro borchia Stud hole diameter	-	-
	Tipo mezzo filtrante Filter media type	Cellulosa / Cellulose			Tipo mezzo filtrante Filter media type	Cellulosa / Cellulose	
	Stile / Style	Rotondo a tenuta assiale Round axial seal			Stile / Style	Rotondo a tenuta assiale Round axial seal	
Tipo / Type	Cartuccia primaria / Primary cartridge		Tipo / Type	Cartuccia primaria / Primary cartridge			
Note / Notes	L'altezza non include la guarnizione Height not include gasket			Note / Notes	L'altezza non include la guarnizione Height not include gasket		
Codice / Code	8001223900	mm	inch	Codice / Code	8001224100	mm	inch
	Altezza / Height	217	8,54		Altezza / Height	268	10,55
	Diametro esterno Outer diameter	242	9,53		Diametro esterno sup. Upper outer diameter	113,5	4,47
	Diametro interno Internal diameter	132	5,20		Diametro esterno inf. Lower outer diameter	128	5,04
	Tipo mezzo filtrante Filter media type	Cellulosa / Cellulose			Diametro interno Internal diameter	57	2,24
	Stile / Style	Rotondo a tenuta assiale Round axial seal			Tipo mezzo filtrante Filter media type	Cellulosa / Cellulose	
	Tipo / Type	Cartuccia primaria / Primary cartridge			Stile / Style	Rotondo a tenuta assiale Round axial seal	
Note / Notes	L'altezza non include la guarnizione Height not include gasket			Tipo / Type	Cartuccia primaria / Primary cartridge		
Note / Notes	L'altezza non include la guarnizione Height not include gasket			Note / Notes	L'altezza non include la guarnizione Height not include gasket		
Codice / Code	8001224200	mm	inch	Codice / Code	8001224300	mm	inch
 <p>Cartuccia di sicurezza abbinata Matched security cartridge</p> <p>8001352700</p>	Altezza / Height	369	14,53		Altezza / Height	306	12,05
	Diametro esterno Outer diameter	227	8,94		Diametro esterno Outer diameter	155	6,10
	Diametro interno Internal diameter	117	4,61		Diametro interno Internal diameter	88	3,46
	Diametro foro borchia Stud hole diameter	10,5	0,41		Diametro foro borchia Stud hole diameter	-	-
	Tipo mezzo filtrante Filter media type	Cellulosa / Cellulose			Tipo mezzo filtrante Filter media type	Cellulosa / Cellulose	
	Stile / Style	Rotondo a tenuta assiale Round axial seal			Stile / Style	Rotondo a tenuta assiale con alette Round axial seal with fins	
Tipo / Type	Cartuccia primaria / Primary cartridge		Tipo / Type	Cartuccia primaria / Primary cartridge			
Note / Notes	L'altezza non include la guarnizione Height not include gasket			Note / Notes	L'altezza non include la guarnizione Height not include gasket		
Codice / Code	8001224400	mm	inch	Codice / Code	8001224500	mm	inch
 <p>Cartuccia di sicurezza abbinata Matched security cartridge</p> <p>8001226500</p>	Altezza / Height	406	15,98		Altezza / Height	408	16,06
	Diametro esterno Outer diameter	174	6,85		Diametro esterno Outer diameter	282	11,10
	Diametro interno Internal diameter	107	4,21		Diametro interno Internal diameter	171	6,73
	Diametro foro borchia Stud hole diameter	17	0,67		Diametro foro borchia Stud hole diameter	17	0,67
	Tipo mezzo filtrante Filter media type	Cellulosa / Cellulose			Tipo mezzo filtrante Filter media type	Cellulosa / Cellulose	
	Stile / Style	Rotondo a tenuta assiale con alette Round axial seal with fins			Stile / Style	Rotondo a tenuta assiale Round axial seal	
Tipo / Type	Cartuccia primaria / Primary cartridge		Tipo / Type	Cartuccia primaria / Primary cartridge			
Note / Notes	L'altezza non include la guarnizione Height not include gasket			Note / Notes	L'altezza non include la guarnizione Height not include gasket		
Note / Notes	L'altezza non include la guarnizione Height not include gasket			Note / Notes	L'altezza non include la guarnizione Height not include gasket		

Codice / Code	8001224800	mm	inch	Codice / Code	8001225100	mm	inch
	Altezza / Height	285	11,22		Altezza / Height	254	10,00
	Diametro esterno Outer diameter	227	8,94		Diametro esterno Outer diameter	234,5	9,23
	Diametro interno Internal diameter	117	4,61		Diametro interno Internal diameter	122,5	4,82
	Diametro foro borchia Stud hole diameter	10,5	0,41		Diametro foro borchia Stud hole diameter	17	0,67
	Tipo mezzo filtrante Filter media type	Cellulosa / Cellulose			Tipo mezzo filtrante Filter media type	Cellulosa / Cellulose	
	Stile / Style	Rotondo a tenuta assiale Round axial seal			Stile / Style	Rotondo a tenuta assiale con alette Round axial seal with fins	
	Tipo / Type	Cartuccia primaria / Primary cartridge			Tipo / Type	Cartuccia primaria / Primary cartridge	
Note / Notes	L'altezza non include la guarnizione Height not include gasket		Note / Notes	L'altezza non include la guarnizione Height not include gasket			
Codice / Code	8001225200	mm	inch	Codice / Code	8001225300	mm	inch
	Altezza / Height	450	17,72		Altezza / Height	456	17,95
	Diametro esterno sup. Upper outer diameter	217	8,54		Diametro esterno Outer diameter	308	12,13
	Diametro esterno inf. Lower outer diameter	185	7,28		Diametro interno Internal diameter	195	7,68
	Diametro interno Internal diameter	157	6,18		Diametro foro borchia Stud hole diameter	17	0,67
	Diametro foro borchia Stud hole diameter	17	0,67		Tipo mezzo filtrante Filter media type	Cellulosa / Cellulose	
	Tipo mezzo filtrante Filter media type	Cellulosa / Cellulose			Stile / Style	Rotondo a tenuta assiale Round axial seal	
	Stile / Style	Rotondo a tenuta assiale Round axial seal			Tipo / Type	Cartuccia primaria / Primary cartridge	
Note / Notes	L'altezza non include la guarnizione Height not include gasket		Note / Notes	L'altezza non include la guarnizione Height not include gasket			
Cartuccia primaria abbinata Matched primary cartridge	8001225300			Cartuccia di sicurezza abbinata / Matched security cartridge	8001225200		
Codice / Code	8001225400	mm	inch	Codice / Code	8001226500	mm	inch
	Altezza / Height	406	15,98		Altezza / Height	381	15,00
	Diametro esterno sup. Upper outer diameter	195	7,68		Diametro esterno sup. Upper outer diameter	123	4,84
	Diametro esterno inf. Lower outer diameter	162,5	6,40		Diametro esterno inf. Lower outer diameter	104	4,09
	Diametro interno Internal diameter	134	5,28		Diametro interno Internal diameter	93	3,66
	Diametro foro borchia Stud hole diameter	17	0,67		Diametro foro borchia Stud hole diameter	17,5	0,69
	Tipo mezzo filtrante Filter media type	Cellulosa / Cellulose			Tipo mezzo filtrante Filter media type	Tessuto poliestere / Polyester fiber	
	Stile / Style	Rotondo a tenuta assiale Round axial seal			Stile / Style	Rotondo a tenuta assiale Round axial seal	
Tipo / Type	Cartuccia di sicurezza / Security cartridge		Tipo / Type	Cartuccia di sicurezza / Security cartridge			
Note / Notes	L'altezza non include la guarnizione Height not include gasket		Note / Notes	L'altezza non include la guarnizione Height not include gasket			
Cartuccia primaria abbinata Matched primary cartridge	8001224500			Cartuccia primaria abbinata Matched primary cartridge	8001228600		
Codice / Code	8001226900	mm	inch	Codice / Code	8001227300	mm	inch
	Altezza / Height	355	13,98		Altezza / Height	407	16,02
	Diametro esterno Outer diameter	264	10,39		Diametro esterno Outer diameter	307	12,09
	Diametro interno Internal diameter	153	6,02		Diametro interno Internal diameter	196	7,72
	Diametro foro borchia Stud hole diameter	23	0,91		Diametro foro borchia Stud hole diameter	23	0,91
	Tipo mezzo filtrante Filter media type	Cellulosa / Cellulose			Tipo mezzo filtrante Filter media type	Cellulosa / Cellulose	
	Stile / Style	Rotondo a tenuta assiale Round axial seal			Stile / Style	Rotondo a tenuta assiale Round axial seal	
	Tipo / Type	Cartuccia primaria / Primary cartridge			Tipo / Type	Cartuccia primaria / Primary cartridge	
Note / Notes	L'altezza non include la guarnizione Height not include gasket		Note / Notes	-			

Codice / Code	8001227600	mm	inch	Codice / Code	8001227800	mm	inch
	Altezza / Height	404	15,91		Altezza / Height	460	18,11
	Diametro esterno Outer diameter	234	9,21		Diametro esterno Outer diameter	302	11,89
	Diametro interno Internal diameter	124	4,88		Diametro interno Internal diameter	191	7,52
	Diametro foro borchia Stud hole diameter	17	0,67		Diametro foro borchia Stud hole diameter	11	0,43
	Tipo mezzo filtrante Filter media type	Cellulosa / Cellulose			Tipo mezzo filtrante Filter media type	Cellulosa / Cellulose	
	Stile / Style	Rotondo a tenuta assiale Round axial seal			Stile / Style	Rotondo a tenuta assiale Round axial seal	
	Tipo / Type	Cartuccia primaria / Primary cartridge			Tipo / Type	Cartuccia primaria / Primary cartridge	
Note / Notes	L'altezza non include la guarnizione Height not include gasket		Note / Notes	L'altezza non include la guarnizione Height not include gasket			
				8001352800			

Codice / Code	8001227900	mm	inch	Codice / Code	8001228300	mm	inch
	Altezza / Height	336	13,23		Altezza / Height	356	14,02
	Diametro esterno Outer diameter	132	5,20		Diametro esterno Outer diameter	310	12,20
	Diametro interno Internal diameter	103	4,06		Diametro interno Internal diameter	200	7,87
	Diametro foro borchia Stud hole diameter	8,5	0,33		Diametro foro borchia Stud hole diameter	17	0,67
	Tipo mezzo filtrante Filter media type	Cellulosa / Cellulose			Tipo mezzo filtrante Filter media type	Cellulosa / Cellulose	
	Stile / Style	Rotondo a tenuta assiale Round axial seal			Stile / Style	Rotondo a tenuta assiale Round axial seal	
	Tipo / Type	Cartuccia di sicurezza / Security cartridge			Tipo / Type	Cartuccia primaria / Primary cartridge	
Note / Notes	L'altezza non include la guarnizione Height not include gasket		Note / Notes	L'altezza non include la guarnizione Height not include gasket			
				8001230200			

Cartuccia primaria abbinata
Matched primary cartridge
8001250000

Cartuccia di sicurezza
abbinata
Matched security cartridge
8001230200

Codice / Code	8001228400	mm	inch	Codice / Code	8001228500	mm	inch
	Altezza / Height	355	13,98		Altezza / Height	226	8,90
	Diametro esterno Outer diameter	280	11,02		Diametro esterno Outer diameter	165	6,50
	Diametro interno Internal diameter	172	6,77		Diametro interno Internal diameter	86,5	3,41
	Diametro foro borchia Stud hole diameter	17	0,67		Diametro foro borchia Stud hole diameter	-	-
	Tipo mezzo filtrante Filter media type	Cellulosa / Cellulose			Tipo mezzo filtrante Filter media type	Cellulosa / Cellulose	
	Stile / Style	Rotondo a tenuta assiale Round axial seal			Stile / Style	Rotondo a tenuta assiale Round axial seal	
	Tipo / Type	Cartuccia primaria / Primary cartridge			Tipo / Type	-	
Note / Notes	L'altezza non include la guarnizione Height not include gasket		Note / Notes	L'altezza non include la guarnizione Height not include gasket			

Codice / Code	8001228700	mm	inch	Codice / Code	8001229000	mm	inch
	Altezza / Height	225	8,86		Altezza / Height	315	12,40
	Diametro esterno Outer diameter	126	4,96		Diametro esterno sup. Upper outer diameter	162	6,38
	Diametro interno Internal diameter	65	2,56		Diametro esterno inf. Lower outer diameter	149	5,87
	Diametro foro borchia Stud hole diameter	-	-		Diametro interno Internal diameter	80,5	3,17
	Tipo mezzo filtrante Filter media type	Cellulosa / Cellulose			Diametro foro borchia Stud hole diameter	7/16 UNF - 20	7/16 UNF - 20
	Stile / Style	Rotondo a tenuta assiale Round axial seal			Tipo mezzo filtrante Filter media type	Cellulosa / Cellulose	
	Tipo / Type	-			Stile / Style	Rotondo a tenuta assiale con alette Round axial seal with fins	
Note / Notes	L'altezza non include la guarnizione Height not include gasket		Tipo / Type	Cartuccia primaria / Primary cartridge			
				8001411300			

Cartuccia di sicurezza
abbinata
Matched security cartridge
8001411300

Codice / Code	8001229100	mm	inch	Codice / Code	8001230200	mm	inch
	Altezza / Height	95	3,74		Altezza / Height	314	12,36
	Diametro esterno Outer diameter	120	4,72		Diametro esterno Outer diameter	197	7,76
	Diametro interno Internal diameter	70	2,76		Diametro interno Internal diameter	176	6,93
	Diametro foro borchia Stud hole diameter	9	0,35		Diametro foro borchia Stud hole diameter	10,5	0,41
	Tipo mezzo filtrante Filter media type	Cellulosa / Cellulose			Tipo mezzo filtrante Filter media type	Cellulosa / Cellulose	
	Stile / Style	Rotondo a tenuta assiale Round axial seal			Stile / Style	Rotondo a tenuta assiale Round axial seal	
Tipo / Type	-		Tipo / Type	Cartuccia di sicurezza / Security cartridge			
Note / Notes	L'altezza non include la guarnizione Height not include gasket		Note / Notes	L'altezza non include la guarnizione Height not include gasket			

Cartuccia primaria abbinata
Matched primary cartridge
8001228300

Codice / Code	8001234500	mm	inch	Codice / Code	8001238500	mm	inch
	Altezza / Height	404	15,91		Altezza / Height	362	14,25
	Diametro esterno sup. Upper outer diameter	264	10,39		Diametro esterno Outer diameter	198	7,80
	Diametro esterno inf. Lower outer diameter	317,5	12,50		Diametro interno Internal diameter	104	4,09
	Diametro foro borchia Stud hole diameter	7/16 UNF - 20	7/16 UNF - 20		Diametro foro borchia Stud hole diameter	8,5	0,33
	Tipo mezzo filtrante Filter media type	Cellulosa / Cellulose			Tipo mezzo filtrante Filter media type	Cellulosa / Cellulose	
	Stile / Style	Rotondo a tenuta assiale con alette Round axial seal with fins			Stile / Style	Rotondo a tenuta assiale Round axial seal	
Tipo / Type	Cartuccia primaria / Primary cartridge		Tipo / Type	Cartuccia primaria / Primary cartridge			
Note / Notes	L'altezza non include la guarnizione Height not include gasket		Note / Notes	L'altezza non include la guarnizione Height not include gasket			



Cartuccia di sicurezza abbinata
Matched security cartridge
8001353100

Codice / Code	8001238600	mm	inch	Codice / Code	8001238700	mm	inch
	Altezza / Height	340	13,39		Altezza / Height	365	14,37
	Diametro esterno Outer diameter	164	6,46		Diametro esterno Outer diameter	302	11,89
	Diametro interno Internal diameter	86	3,39		Diametro interno Internal diameter	191	7,52
	Diametro foro borchia Stud hole diameter	9	0,35		Diametro foro borchia Stud hole diameter	10,5	0,41
	Tipo mezzo filtrante Filter media type	Cellulosa / Cellulose			Tipo mezzo filtrante Filter media type	Cellulosa / Cellulose	
	Stile / Style	Rotondo a tenuta assiale Round axial seal			Stile / Style	Rotondo a tenuta assiale Round axial seal	
Tipo / Type	Cartuccia primaria / Primary cartridge		Tipo / Type	Cartuccia primaria / Primary cartridge			
Note / Notes	L'altezza non include la guarnizione Height not include gasket		Note / Notes	L'altezza non include la guarnizione Height not include gasket			

Cartuccia di sicurezza abbinata / Matched security cartridge
8001353000

Codice / Code	8001239000	mm	inch	Codice / Code	8001239500	mm	inch
	Altezza / Height	406	15,98		Altezza / Height	380	14,96
	Diametro esterno sup. Upper outer diameter	279	10,98		Diametro esterno Outer diameter	117	4,61
	Diametro esterno inf. Lower outer diameter	201	7,91		Diametro interno Internal diameter	88	3,46
	Diametro foro borchia Stud hole diameter	7/16 UNF - 20	7/16 UNF - 20		Diametro foro borchia Stud hole diameter	17	0,67
	Tipo mezzo filtrante Filter media type	Cellulosa / Cellulose			Tipo mezzo filtrante Filter media type	Cellulosa / Cellulose	
	Stile / Style	Rotondo a tenuta assiale con alette Round axial seal with fins			Stile / Style	Rotondo a tenuta assiale Round axial seal	
Tipo / Type	Cartuccia primaria / Primary cartridge		Tipo / Type	Cartuccia di sicurezza / Security cartridge			
Note / Notes	L'altezza non include la guarnizione Height not include gasket		Note / Notes	L'altezza non include la guarnizione Height not include gasket			

Codice / Code	8001239700	mm	inch	Codice / Code	8001240300	mm	inch
	Altezza / Height	217	8,54		Altezza / Height	250	9,84
	Diametro esterno Outer diameter	109	4,29		Diametro esterno Outer diameter	485	19,09
	Diametro interno Internal diameter	52	2,05		Diametro interno Internal diameter	335	13,19
	Diametro foro borchia Stud hole diameter	8,5	0,33		Diametro foro borchia Stud hole diameter	-	-
	Tipo mezzo filtrante Filter media type	Cellulosa / Cellulose			Tipo mezzo filtrante Filter media type	Cellulosa / Cellulose	
	Stile / Style	Rotondo a tenuta assiale Round axial seal			Stile / Style	Rotondo a tenuta assiale Round axial seal	
	Tipo / Type	Cartuccia primaria / Primary cartridge			Tipo / Type	-	
	Note / Notes	L'altezza non include la guarnizione Height not include gasket			Note / Notes	L'altezza non include la guarnizione Height not include gasket	



Codice / Code	8001240500	mm	inch	Codice / Code	8001245900	mm	inch
	Altezza / Height	788	31,02		Altezza / Height	188	7,40
	Diametro esterno Outer diameter	324	12,76		Diametro esterno Outer diameter	85	3,35
	Diametro interno Internal diameter	214	8,43		Diametro interno Internal diameter	72	2,83
	Diametro foro borchia Stud hole diameter	13	0,51		Diametro foro borchia Stud hole diameter	10,2	0,40
	Tipo mezzo filtrante Filter media type	Cellulosa / Cellulose			Tipo mezzo filtrante Filter media type	Tessuto poliestere / Polyester Fiber	
	Stile / Style	Rotondo a tenuta assiale Round axial seal			Stile / Style	Rotondo a tenuta assiale Round axial seal	
	Tipo / Type	Cartuccia primaria / Primary cartridge			Tipo / Type	Cartuccia di sicurezza / Security cartridge	
	Note / Notes	L'altezza non include la guarnizione Height not include gasket			Note / Notes	L'altezza non include la guarnizione Height not include gasket	

Codice / Code	8001246300	mm	inch	Codice / Code	8001247400	mm	inch
	Altezza / Height	92	3,62		Altezza / Height	95	3,74
	Diametro esterno Outer diameter	210	8,27		Diametro esterno Outer diameter	140	5,51
	Diametro interno Internal diameter	165	6,50		Diametro interno Internal diameter	94	3,70
	Tipo mezzo filtrante Filter media type	Cellulosa / Cellulose			Tipo mezzo filtrante Filter media type	Cellulosa / Cellulose	
	Stile / Style	Rotondo a tenuta assiale Round axial seal			Stile / Style	Rotondo a tenuta assiale Round axial seal	
	Tipo / Type	-			Tipo / Type	-	



Codice / Code	8001248500	mm	inch	Codice / Code	8001249100	mm	inch
	Altezza / Height	290	11,42		Altezza / Height	312	12,28
	Diametro esterno Outer diameter	74	2,91		Diametro esterno sup. Upper outer diameter	132	5,20
	Diametro interno Internal diameter	48	1,89		Diametro esterno inf. Lower outer diameter	146	5,75
	Diametro foro borchia Stud hole diameter	8,5	0,33		Diametro interno Internal diameter	76	2,99
	Tipo mezzo filtrante Filter media type	Cellulosa / Cellulose			Diametro foro borchia Stud hole diameter	10	0,39
	Stile / Style	Rotondo a tenuta assiale Round axial seal			Tipo mezzo filtrante Filter media type	Cellulosa / Cellulose	
	Tipo / Type	Cartuccia di sicurezza / Security cartridge			Stile / Style	Rotondo a tenuta assiale Round axial seal	
	Note / Notes	L'altezza non include la guarnizione Height not include gasket			Tipo / Type	Cartuccia primaria / Primary cartridge	

Cartuccia primaria abbinata
Matched primary cartridge
8001249100









Cartuccia di sicurezza
abbinata / Matched security
cartridge
8001248500









Codice / Code	8001249800	mm	inch	Codice / Code	8001250000	mm	inch
	Altezza / Height	312	12,28		Altezza / Height	359	14,13
	Diametro esterno sup. / Upper outer diameter	132	5,20		Diametro esterno sup. / Upper outer diameter	211	8,31
	Diametro esterno inf. / Lower outer diameter	135	5,31		Diametro esterno inf. / Lower outer diameter	230	9,06
	Diametro interno / Internal diameter	76	2,99		Diametro interno / Internal diameter	135	5,31
	Diametro foro borchia / Stud hole diameter	10	0,39		Diametro foro borchia / Stud hole diameter	10	0,39
Cartuccia di sicurezza abbinata / Matched security cartridge 8001248500	Tipo mezzo filtrante / Filter media type	Cellulosa / Cellulose		Cartuccia di sicurezza abbinata / Matched security cartridge 8001227900	Tipo mezzo filtrante / Filter media type	Cellulosa / Cellulose	
	Stile / Style	Rotondo a tenuta assiale / Round axial seal			Stile / Style	Rotondo a tenuta assiale / Round axial seal	
	Tipo / Type	Cartuccia primaria / Primary cartridge			Tipo / Type	Cartuccia primaria / Primary cartridge	
Note / Notes	L'altezza non include la guarnizione / Height not include gasket		Note / Notes	L'altezza non include la guarnizione / Height not include gasket			









Codice / Code	8001250700	mm	inch	Codice / Code	8001253200	mm	inch
	Altezza / Height	380	14,96		Altezza / Height	92	3,62
	Diametro esterno sup. / Upper outer diameter	247	9,72		Diametro esterno / Outer diameter	215	8,46
	Diametro esterno inf. / Lower outer diameter	186	7,32		Diametro interno / Internal diameter	146	5,75
	Diametro interno / Internal diameter	119,5	4,70		Diametro foro borchia / Stud hole diameter	-	-
	Diametro foro borchia / Stud hole diameter	17	0,67		Tipo mezzo filtrante / Filter media type	Cellulosa / Cellulose	
Stile / Style	Rotondo a tenuta assiale / Round axial seal		Stile / Style	Rotondo a tenuta assiale / Round axial seal			
	Tipo / Type	Cartuccia primaria / Primary cartridge		Tipo / Type	-		
	Note / Notes	L'altezza non include la guarnizione / Height not include gasket		Note / Notes	-		









Codice / Code	8001257600	mm	inch	Codice / Code	8001259800	mm	inch
	Altezza / Height	287	11,30		Altezza / Height	95	3,74
	Diametro esterno sup. / Upper outer diameter	105	4,13		Diametro esterno / Outer diameter	183	7,20
	Diametro esterno inf. / Lower outer diameter	85	3,35		Diametro interno / Internal diameter	106	4,17
	Diametro interno / Internal diameter	74	2,91		Diametro foro borchia / Stud hole diameter	M6	M6
	Diametro foro borchia / Stud hole diameter	17	0,67		Tipo mezzo filtrante / Filter media type	Cellulosa / Cellulose	
Stile / Style	Rotondo a tenuta assiale / Round axial seal		Stile / Style	Rotondo a tenuta assiale / Round axial seal			
	Tipo / Type	Cartuccia di sicurezza / Security cartridge		Tipo / Type	-		
	Note / Notes	L'altezza non include la guarnizione / Height not include gasket		Note / Notes	L'altezza non include la guarnizione / Height not include gasket		









Codice / Code	8001260400	mm	inch	Codice / Code	8001260500	mm	inch
	Altezza / Height	320	12,60		Altezza / Height	268	10,55
	Diametro esterno sup. / Upper outer diameter	248	9,76		Diametro esterno / Outer diameter	140	5,51
	Diametro interno / Internal diameter	143,5	5,65		Diametro interno / Internal diameter	107,5	4,23
	Diametro foro borchia / Stud hole diameter	M10 x 1,5	M10 x 1,5		Diametro foro borchia / Stud hole diameter	16	0,63
	Tipo mezzo filtrante / Filter media type	Cellulosa / Cellulose			Tipo mezzo filtrante / Filter media type	Cellulosa / Cellulose	
Cartuccia di sicurezza abbinata / Matched security cartridge 8001260500	Stile / Style	Rotondo a tenuta assiale / Round axial seal		Cartuccia primaria abbinata / Matched primary cartridge 8001260400	Stile / Style	Rotondo a tenuta assiale / Round axial seal	
	Tipo / Type	Cartuccia primaria / Primary cartridge			Tipo / Type	Cartuccia di sicurezza / Security cartridge	
	Note / Notes	L'altezza non include la guarnizione / Height not include gasket			Note / Notes	L'altezza non include la guarnizione / Height not include gasket	

Codice / Code	8001265300	mm	inch	Codice / Code	8001266000	mm	inch
	Altezza / Height	285	11,22		Altezza / Height	269	10,59
	Diametro esterno Outer diameter	121	4,76		Diametro esterno Outer diameter	268	10,55
	Diametro interno Internal diameter	54	2,13		Diametro interno Internal diameter	195	7,68
	Diametro foro borchia Stud hole diameter	9,5	0,37		Diametro foro borchia Stud hole diameter	-	-
	Tipo mezzo filtrante Filter media type	Cellulosa / Cellulose			Tipo mezzo filtrante Filter media type	Cellulosa / Cellulose	
	Stile / Style	Rotondo a tenuta assiale Round axial seal			Stile / Style	Rotondo a tenuta assiale Round axial seal	
	Tipo / Type	Cartuccia primaria / Primary cartridge			Tipo / Type	-	
Note / Notes	L'altezza non include la guarnizione Height not include gasket		Note / Notes	L'altezza non include la guarnizione Height not include gasket			
Codice / Code	8001268800	mm	inch	Codice / Code	8001268900	mm	inch
	Altezza / Height	280	11,02		Altezza / Height	260	10,24
	Diametro esterno Outer diameter	134	5,28		Diametro esterno Outer diameter	82	3,23
	Diametro interno Internal diameter	84	3,31		Diametro interno Internal diameter	64	2,52
	Diametro foro borchia Stud hole diameter	16,5	0,65		Diametro foro borchia Stud hole diameter	12	0,47
	Tipo mezzo filtrante Filter media type	Cellulosa / Cellulose			Tipo mezzo filtrante Filter media type	Tessuto poliestere / Polyester Fiber	
	Stile / Style	Rotondo a tenuta assiale con alette Round axial seal with fins			Stile / Style	Rotondo a tenuta assiale Round axial seal	
	Tipo / Type	Cartuccia primaria / Primary cartridge			Tipo / Type	Cartuccia di sicurezza / Security cartridge	
Note / Notes	L'altezza non include la guarnizione Height not include gasket		Note / Notes	L'altezza non include la guarnizione Height not include gasket			
Codice / Code	8001269400	mm	inch	Codice / Code	8001271200	mm	inch
	Altezza / Height	177	6,97		Altezza / Height	119	4,69
	Diametro esterno sup. Upper outer diameter	83	3,27		Diametro esterno Outer diameter	148	5,83
	Diametro esterno inf. Lower outer diameter	127	5,00		Diametro interno Internal diameter	47,8	1,88
	Diametro interno Internal diameter	46	1,81		Diametro foro borchia Stud hole diameter	-	-
	Diametro foro borchia Stud hole diameter	6	0,24		Tipo mezzo filtrante Filter media type	Cellulosa / Cellulose	
	Tipo mezzo filtrante Filter media type	Cellulosa / Cellulose			Stile / Style	Rotondo a tenuta assiale Round axial seal	
	Stile / Style	Rotondo a tenuta assiale Round axial seal			Tipo / Type	-	
Tipo / Type	Cartuccia primaria / Primary cartridge		Note / Notes	L'altezza non include la guarnizione Height not include gasket			
Note / Notes	L'altezza non include la guarnizione Height not include gasket		Note / Notes	L'altezza non include la guarnizione Height not include gasket			
Codice / Code	8001271300	mm	inch	Codice / Code	8001271600	mm	inch
	Altezza / Height	146	5,75		Altezza / Height	253	9,96
	Diametro esterno Outer diameter	204	8,03		Diametro esterno sup. Upper outer diameter	104	4,09
	Diametro interno Internal diameter	78,8	3,10		Diametro esterno inf. Lower outer diameter	146	5,75
	Diametro foro borchia Stud hole diameter	-	-		Diametro interno Internal diameter	64,5	2,54
	Tipo mezzo filtrante Filter media type	Cellulosa / Cellulose			Diametro foro borchia Stud hole diameter	7	0,28
	Stile / Style	Rotondo a tenuta assiale Round axial seal			Tipo mezzo filtrante Filter media type	Cellulosa / Cellulose	
	Tipo / Type	-			Stile / Style	Rotondo a tenuta assiale Round axial seal	
Note / Notes	L'altezza non include la guarnizione Height not include gasket		Tipo / Type	Cartuccia primaria / Primary cartridge			
				Note / Notes	L'altezza non include la guarnizione Height not include gasket		
				Cartuccia di sicurezza abbinata Matched security cartridge			
				8001687200			

Codice / Code	8001273900	mm	inch	Codice / Code	8001275200	mm	inch
	Altezza / Height	178	7,01		Altezza / Height	279	10,98
	Diametro esterno sup. Upper outer diameter	128	5,04		Diametro esterno Outer diameter	234	9,21
	Diametro esterno inf. Lower outer diameter	109	4,29		Diametro interno Internal diameter	124	4,88
	Diametro interno Internal diameter	43	1,69		Diametro foro borchia Stud hole diameter	16,5	0,65
	Diametro foro borchia Stud hole diameter	10,5	0,41		Tipo mezzo filtrante Filter media type	Cellulosa / Cellulose	
	Tipo mezzo filtrante Filter media type	Cellulosa / Cellulose			Stile / Style	Rotondo a tenuta assiale Round axial seal	
	Stile / Style	Rotondo a tenuta assiale Round axial seal			Tipo / Type	Cartuccia primaria / Primary cartridge	
	Tipo / Type	Cartuccia primaria / Primary cartridge			Note / Notes	L'altezza non include la guarnizione Height not include gasket	
	Note / Notes	L'altezza non include la guarnizione Height not include gasket					
Codice / Code	8001277000	mm	inch	Codice / Code	8001277500	mm	inch
	Altezza / Height	254	10,00		Altezza / Height	280	11,02
	Diametro esterno sup. Upper outer diameter	150	5,91		Diametro esterno sup. Upper outer diameter	134	5,28
	Diametro esterno inf. Lower outer diameter	129	5,08		Diametro esterno inf. Lower outer diameter	180	7,09
	Diametro interno Internal diameter	63	2,48		Diametro interno Internal diameter	72	2,83
	Diametro foro borchia Stud hole diameter	17	0,67		Diametro foro borchia Stud hole diameter	13,5	0,53
	Tipo mezzo filtrante Filter media type	Cellulosa / Cellulose			Tipo mezzo filtrante Filter media type	Cellulosa / Cellulose	
	Stile / Style	Rotondo a tenuta assiale con alette Round axial seal with fins			Stile / Style	Rotondo a tenuta assiale Round axial seal	
	Tipo / Type	Cartuccia primaria / Primary cartridge			Tipo / Type	Cartuccia primaria / Primary cartridge	
	Note / Notes	L'altezza non include la guarnizione Height not include gasket			Note / Notes	L'altezza non include la guarnizione Height not include gasket	
Codice / Code	8001278100	mm	inch	Codice / Code	8001279000	mm	inch
	Altezza / Height	456	17,95		Altezza / Height	406	15,98
	Diametro esterno Outer diameter	254	10,00		Diametro esterno sup. Upper outer diameter	279	10,98
	Diametro interno Internal diameter	170	6,69		Diametro esterno inf. Lower outer diameter	234	9,21
	Diametro foro borchia Stud hole diameter	11	0,43		Diametro interno Internal diameter	124	4,88
	Tipo mezzo filtrante Filter media type	Cellulosa / Cellulose			Diametro foro borchia Stud hole diameter	7/16 UNF - 20	7/16 UNF - 20
	Stile / Style	Rotondo a tenuta assiale Round axial seal			Tipo mezzo filtrante Filter media type	Cellulosa / Cellulose	
	Tipo / Type	Cartuccia primaria / Primary cartridge			Stile / Style	Rotondo a tenuta assiale Round axial seal	
	Note / Notes	-			Tipo / Type	Cartuccia primaria / Primary cartridge	
					Note / Notes	L'altezza non include la guarnizione Height not include gasket	
Codice / Code	8001279400	mm	inch	Codice / Code	8001279800	mm	inch
	Altezza / Height	406	15,98		Altezza / Height	406	15,98
	Diametro esterno sup. Upper outer diameter	317,5	12,50		Diametro esterno sup. Upper outer diameter	276,5	10,89
	Diametro esterno inf. Lower outer diameter	265	10,43		Diametro esterno inf. Lower outer diameter	254	10,00
	Diametro interno Internal diameter	153	6,02		Diametro interno Internal diameter	123	4,84
	Diametro foro borchia Stud hole diameter	7/16 UNF - 20	7/16 UNF - 20		Diametro foro borchia Stud hole diameter	7/16 UNF - 20	7/16 UNF - 20
	Tipo mezzo filtrante Filter media type	Cellulosa / Cellulose			Tipo mezzo filtrante Filter media type	Cellulosa / Cellulose	
	Stile / Style	Rotondo a tenuta assiale Round axial seal			Stile / Style	Rotondo a tenuta assiale Round axial seal	
	Tipo / Type	Cartuccia primaria / Primary cartridge			Tipo / Type	Cartuccia primaria / Primary cartridge	
	Note / Notes	L'altezza non include la guarnizione Height not include gasket			Note / Notes	L'altezza non include la guarnizione Height not include gasket	

Codice / Code	8001280900	mm	inch	Codice / Code	8001281700	mm	inch
	Altezza / Height	292	11,50		Altezza / Height	197	7,76
	Diametro esterno Outer diameter	150	5,91		Diametro esterno Outer diameter	150	5,91
	Diametro interno Internal diameter	71	2,80		Diametro interno Internal diameter	71	2,80
	Diametro foro borchia Stud hole diameter	10,5	0,41		Diametro foro borchia Stud hole diameter	12,5	0,49
	Tipo mezzo filtrante Filter media type	Cellulosa / Cellulose			Tipo mezzo filtrante Filter media type	Cellulosa / Cellulose	
	Stile / Style	Rotondo a tenuta assiale Round axial seal			Stile / Style	Rotondo a tenuta assiale Round axial seal	
	Tipo / Type	Cartuccia primaria / Primary cartridge			Tipo / Type	-	
	Note / Notes	L'altezza non include la guarnizione Height not include gasket			Note / Notes	L'altezza non include la guarnizione Height not include gasket	
Codice / Code	8001281800	mm	inch	Codice / Code	8001282500	mm	inch
	Altezza / Height	94	3,70		Altezza / Height	286	11,26
	Diametro esterno Outer diameter	183	7,20		Diametro esterno Outer diameter	243	9,57
	Diametro interno Internal diameter	106	4,17		Diametro interno Internal diameter	132	5,20
	Diametro foro borchia Stud hole diameter	9,5	0,37		Diametro foro borchia Stud hole diameter	11	0,43
	Tipo mezzo filtrante Filter media type	Elemento filtrante metallico Metallic filter element			Tipo mezzo filtrante Filter media type	Cellulosa / Cellulose	
	Stile / Style	Rotondo a tenuta assiale Round axial seal			Stile / Style	Rotondo a tenuta assiale Round axial seal	
	Tipo / Type	-			Tipo / Type	Cartuccia primaria / Primary cartridge	
	Note / Notes	L'altezza non include la guarnizione Height not include gasket			Note / Notes	L'altezza non include la guarnizione Height not include gasket	
Codice / Code	8001282600	mm	inch	Codice / Code	8001283900	mm	inch
	Altezza / Height	275	10,83		Altezza / Height	67	2,64
	Diametro esterno sup. Upper outer diameter	213	8,39		Diametro esterno Outer diameter	132,5	5,22
	Diametro esterno inf. Lower outer diameter	235	9,25		Diametro interno Internal diameter	78	3,07
	Diametro interno Internal diameter	105	4,13		Diametro foro borchia Stud hole diameter	-	-
	Diametro foro borchia Stud hole diameter	9	0,35		Tipo mezzo filtrante Filter media type	Cellulosa / Cellulose	
	Tipo mezzo filtrante Filter media type	Cellulosa / Cellulose			Stile / Style	Rotondo a tenuta assiale Round axial seal	
	Stile / Style	Rotondo a tenuta assiale Round axial seal			Tipo / Type	-	
	Note / Notes	L'altezza non include la guarnizione Height not include gasket			Note / Notes	-	
Codice / Code	8001284300	mm	inch	Codice / Code	8001284700	mm	inch
	Altezza / Height	121	4,76		Altezza / Height	74	2,91
	Diametro esterno Outer diameter	277	10,91		Diametro esterno Outer diameter	199	7,83
	Diametro interno Internal diameter	157	6,18		Diametro interno Internal diameter	105	4,13
	Diametro foro borchia Stud hole diameter	-	-		Diametro foro borchia Stud hole diameter	-	-
	Tipo mezzo filtrante Filter media type	Cellulosa / Cellulose			Tipo mezzo filtrante Filter media type	Cellulosa / Cellulose	
	Stile / Style	Rotondo a tenuta assiale Round axial seal			Stile / Style	Rotondo a tenuta assiale Round axial seal	
	Tipo / Type	-			Tipo / Type	-	

Codice / Code	8001285700	mm	inch	Codice / Code	8001286700	mm	inch	
	Altezza / Height	359	14,13		Altezza / Height	342	13,46	
	Diametro esterno sup. / Upper outer diameter	164	6,46		Diametro esterno / Outer diameter	72	2,83	
	Diametro esterno inf. / Lower outer diameter	192	7,56		Diametro interno / Internal diameter	60,5	2,38	
	Diametro interno / Internal diameter	98	3,86		Diametro foro borchia / Stud hole diameter	11,8	0,46	
	Diametro foro borchia / Stud hole diameter	16	0,63		Tipo mezzo filtrante / Filter media type	Tessuto poliestere / Polyester Fiber		
	Tipo mezzo filtrante / Filter media type	Cellulosa / Cellulose						
	Stile / Style	Rotondo a tenuta assiale / Round axial seal			Stile / Style	Rotondo a tenuta assiale / Round axial seal		
	Tipo / Type	Cartuccia primaria / Primary cartridge			Tipo / Type	Cartuccia di sicurezza / Security cartridge		
Note / Notes	L'altezza non include la guarnizione / Height not include gasket		Note / Notes	L'altezza non include la guarnizione / Height not include gasket				
Codice / Code	8001287000	mm	inch	Codice / Code	8001288400	mm	inch	
	Altezza / Height	164	6,46		Altezza / Height	600	23,62	
	Diametro esterno / Outer diameter	126	4,96		Diametro esterno / Outer diameter	324	12,76	
	Diametro interno / Internal diameter	65	2,56		Diametro interno sup. / Upper internal diameter	214	8,43	
	Diametro foro borchia / Stud hole diameter	9	0,35		Diametro interno inf. / Lower internal diameter	214	8,43	
	Tipo mezzo filtrante / Filter media type	Cellulosa / Cellulose			Diametro foro borchia / Stud hole diameter		0,00	
					Tipo mezzo filtrante / Filter media type	Cellulosa / Cellulose		
	Stile / Style	Rotondo a tenuta assiale / Round axial seal			Stile / Style	-		
	Tipo / Type	Cartuccia primaria / Primary cartridge			Tipo / Type	Per impianti di verniciatura / Painting Plants		
Note / Notes	L'altezza non include la guarnizione / Height not include gasket		Note / Notes	L'altezza non include la guarnizione / Height not include gasket				
Codice / Code	8001288800	mm	inch	Codice / Code	8001295300	mm	inch	
	Altezza / Height	160	6,30		Altezza / Height	70	2,76	
	Diametro esterno / Outer diameter	104	4,09		Diametro esterno / Outer diameter	98	3,86	
	Diametro interno / Internal diameter	63	2,48		Diametro interno sup. / Upper internal diameter	60	2,36	
	Diametro foro borchia / Stud hole diameter	8,5	0,33		Diametro interno inf. / Lower internal diameter	60	2,36	
	Tipo mezzo filtrante / Filter media type	Cellulosa / Cellulose			Diametro foro borchia / Stud hole diameter	-	-	
					Tipo mezzo filtrante / Filter media type	Cellulosa / Cellulose		
	Stile / Style	Rotondo a tenuta assiale / Round axial seal			Stile / Style	Rotondo a tenuta assiale / Round axial seal		
	Tipo / Type	Cartuccia primaria / Primary cartridge			Tipo / Type	-		
Note / Notes	L'altezza non include la guarnizione / Height not include gasket		Note / Notes	-				
Codice / Code	8001298000	mm	inch	Codice / Code	8001298500	mm	inch	
	Altezza / Height	340	13,39		Altezza / Height	163	6,42	
	Diametro esterno sup. / Upper outer diameter	164	6,46		Diametro esterno / Outer diameter	93	3,66	
	Diametro esterno inf. / Lower outer diameter	200,5	7,89		Diametro interno / Internal diameter	44	1,73	
	Diametro interno / Internal diameter	86	3,39		Diametro foro borchia / Stud hole diameter	8,5	0,33	
	Diametro foro borchia / Stud hole diameter	9	0,35		Tipo mezzo filtrante / Filter media type	Cellulosa / Cellulose		
	Tipo mezzo filtrante / Filter media type	Cellulosa / Cellulose						
	Stile / Style	Rotondo a tenuta assiale / Round axial seal			Stile / Style	Rotondo a tenuta assiale / Round axial seal		
	Tipo / Type	Cartuccia primaria / Primary cartridge			Tipo / Type	Cartuccia primaria / Primary cartridge		
Note / Notes	L'altezza non include la guarnizione / Height not include gasket		Note / Notes	L'altezza non include la guarnizione / Height not include gasket				

Codice / Code	8001307400	mm	inch	Codice / Code	8001307500	mm	inch
	Altezza / Height	290	11,42		Altezza / Height	342	13,46
	Diametro esterno sup. / Upper outer diameter	180	7,09		Diametro esterno sup. / Upper outer diameter	180	7,09
	Diametro esterno inf. / Lower outer diameter	140	5,51		Diametro esterno inf. / Lower outer diameter	138	5,43
	Diametro interno / Internal diameter	72	2,83		Diametro interno / Internal diameter	72	2,83
	Diametro foro borchia / Stud hole diameter	7/16 UNF - 20	7/16 UNF - 20		Diametro foro borchia / Stud hole diameter	7/16 UNF - 20	7/16 UNF - 20
	Tipo mezzo filtrante / Filter media type	Cellulosa / Cellulose			Tipo mezzo filtrante / Filter media type	Cellulosa / Cellulose	
	Stile / Style	Rotondo a tenuta assiale / Round axial seal			Stile / Style	Rotondo a tenuta assiale / Round axial seal	
	Tipo / Type	Cartuccia primaria / Primary cartridge			Tipo / Type	Cartuccia primaria / Primary cartridge	
Note / Notes	L'altezza non include la guarnizione / Height not include gasket		Note / Notes	L'altezza non include la guarnizione / Height not include gasket			
Codice / Code	8001309000	mm	inch	Codice / Code	8001311500	mm	inch
	Altezza / Height	354	13,94		Altezza / Height	120	4,72
	Diametro esterno sup. / Upper outer diameter	196,3	7,73		Diametro esterno / Outer diameter	112	4,41
	Diametro esterno inf. / Lower outer diameter	229,3	9,03		Diametro interno / Internal diameter	50	1,97
	Diametro interno / Internal diameter	128,5	5,06		Diametro foro borchia / Stud hole diameter	-	-
	Diametro foro borchia / Stud hole diameter	16,5	0,65		Tipo mezzo filtrante / Filter media type	Cellulosa / Cellulose	
	Tipo mezzo filtrante / Filter media type	Cellulosa / Cellulose			Stile / Style	-	
	Stile / Style	Rotondo a tenuta assiale / Round axial seal			Tipo / Type	-	
	Tipo / Type	Cartuccia primaria / Primary cartridge			Note / Notes	-	
Note / Notes	L'altezza non include la guarnizione / Height not include gasket						
Codice / Code	8001311600	mm	inch	Codice / Code	8001314100	mm	inch
	Altezza / Height	151	5,94		Altezza / Height	333	13,11
	Diametro esterno / Outer diameter	130	5,12		Diametro esterno sup. / Upper outer diameter	230	9,06
	Diametro interno / Internal diameter	76	2,99		Diametro esterno inf. / Lower outer diameter	160	6,30
	Tipo mezzo filtrante / Filter media type	Cellulosa / Cellulose			Diametro interno / Internal diameter	117	4,61
	Stile / Style	-			Tipo mezzo filtrante / Filter media type	Cellulosa / Cellulose	
	Tipo / Type	-			Stile / Style	Rotondo a tenuta assiale / Round axial seal	
					Tipo / Type	Cartuccia di sicurezza / Security cartridge	
					8001221400		
Codice / Code	8001315000	mm	inch	Codice / Code	8001315600	mm	inch
	Altezza / Height	446	17,56		Altezza / Height	371	14,61
	Diametro esterno sup. / Upper outer diameter	230	9,06		Diametro esterno sup. / Upper outer diameter	230	9,06
	Diametro esterno inf. / Lower outer diameter	160	6,30		Diametro esterno inf. / Lower outer diameter	160	6,30
	Diametro interno / Internal diameter	117	4,61		Diametro interno / Internal diameter	117	4,61
	Diametro foro borchia / Stud hole diameter	-	-		Diametro foro borchia / Stud hole diameter	-	-
	Tipo mezzo filtrante / Filter media type	Cellulosa / Cellulose			Tipo mezzo filtrante / Filter media type	Cellulosa / Cellulose	
	Stile / Style	Rotondo a tenuta assiale / Round axial seal			Stile / Style	Rotondo a tenuta assiale / Round axial seal	
	Tipo / Type	Cartuccia di sicurezza / Security cartridge			Tipo / Type	Cartuccia di sicurezza / Security cartridge	
Cartuccia primaria abbinata / Matched primary cartridge			8001221000	Cartuccia primaria abbinata / Matched primary cartridge			

Codice / Code	8001315700	mm	inch
	Altezza / Height	344	13,54
	Diametro esterno sup. / Upper outer diameter	185	7,28
	Diametro esterno inf. / Lower outer diameter	121	4,76
	Diametro interno / Internal diameter	92	3,62
	Diametro foro borchia / Stud hole diameter	-	-
	Tipo mezzo filtrante / Filter media type	Cellulosa / Cellulose	
	Stile / Style	Rotondo a tenuta assiale / Round axial seal	
	Tipo / Type	Cartuccia di sicurezza / Security cartridge	
Note / Notes	-		

Cartuccia primaria abbinata
Matched primary cartridge

8001220800

Codice / Code	8001317300	mm	inch
	Altezza / Height	340	13,39
	Diametro esterno / Outer diameter	324	12,76
	Diametro interno / Internal diameter	214	8,43
	Diametro foro borchia / Stud hole diameter	13	0,51
	Tipo mezzo filtrante / Filter media type	Cellulosa / Cellulose	
	Stile / Style	Rotondo a tenuta assiale / Round axial seal	
	Tipo / Type	Cartuccia primaria / Primary cartridge	
	Note / Notes	L'altezza non include la guarnizione / Height not include gasket	

Codice / Code	8001317700	mm	inch
	Altezza / Height	180	7,09
	Diametro esterno / Outer diameter	90	3,54
	Diametro interno / Internal diameter	60	2,36
	Diametro foro borchia / Stud hole diameter	8,5	0,33
	Tipo mezzo filtrante / Filter media type	Cellulosa / Cellulose	
	Stile / Style	Rotondo a tenuta assiale / Round axial seal	
	Tipo / Type	Cartuccia primaria / Primary cartridge	
	Note / Notes	L'altezza non include la guarnizione / Height not include gasket	









Codice / Code	8001318500	mm	inch
	Altezza / Height	250	9,84
	Diametro esterno sup. / Upper outer diameter	150	5,91
	Diametro esterno inf. / Lower outer diameter	174	6,85
	Diametro interno / Internal diameter	81	3,19
	Diametro foro borchia / Stud hole diameter	M10 x 1,5	M10 x 1,5
	Tipo mezzo filtrante / Filter media type	Cellulosa / Cellulose	
	Stile / Style	Rotondo a tenuta assiale / Round axial seal	
	Tipo / Type	Cartuccia primaria / Primary cartridge	
Note / Notes	L'altezza non include la guarnizione / Height not include gasket		

Codice / Code	8001319000	mm	inch
	Altezza / Height	375	14,76
	Diametro esterno / Outer diameter	188	7,40
	Diametro interno / Internal diameter	160	6,30
	Diametro foro borchia / Stud hole diameter	14	0,55
	Tipo mezzo filtrante / Filter media type	Bulpren	
	Stile / Style	-	
	Tipo / Type	-	
	Note / Notes	-	









Codice / Code	8001320500	mm	inch
	Altezza / Height	382	15,04
	Diametro esterno / Outer diameter	164	6,46
	Diametro interno sup. / Upper internal diameter	192	7,56
	Diametro interno inf. / Lower internal diameter	98	3,86
	Diametro foro borchia / Stud hole diameter	M10 x 1,5	M10 x 1,5
	Tipo mezzo filtrante / Filter media type	Cellulosa / Cellulose	
	Stile / Style	Rotondo a tenuta assiale / Round axial seal	
	Tipo / Type	Cartuccia primaria / Primary cartridge	
Note / Notes	L'altezza non include la guarnizione / Height not include gasket		









Codice / Code	8001327000	mm	inch
	Altezza / Height	382	15,04
	Diametro esterno sup. / Upper outer diameter	214	8,43
	Diametro esterno inf. / Lower outer diameter	198	7,80
	Diametro interno / Internal diameter	88	3,46
	Diametro foro borchia / Stud hole diameter	M10 x 1,5	M10 x 1,5
	Tipo mezzo filtrante / Filter media type	Cellulosa / Cellulose	
	Stile / Style	Rotondo a tenuta assiale con alette / Round axial seal with fins	
	Tipo / Type	Cartuccia primaria / Primary cartridge	
Note / Notes	L'altezza non include la guarnizione / Height not include gasket		





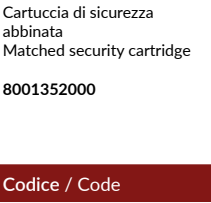



Codice / Code	8001329400	mm	inch
	Altezza / Height	236	9,29
	Diametro esterno sup. / Upper outer diameter	83	3,27
	Diametro esterno inf. / Lower outer diameter	127	5,00
	Diametro interno / Internal diameter	46	1,81
	Diametro foro borchia / Stud hole diameter	6	0,24
	Tipo mezzo filtrante / Filter media type	Cellulosa / Cellulose	
	Stile / Style	Rotondo a tenuta assiale / Round axial seal	
	Tipo / Type	Cartuccia primaria / Primary cartridge	
Note / Notes	L'altezza non include la guarnizione / Height not include gasket		

Codice / Code	8001329600	mm	inch	Codice / Code	8001329700	mm	inch
	Altezza / Height	236	9,29		Altezza / Height	161	6,34
	Diametro esterno Outer diameter	83	3,27		Diametro esterno Outer diameter	90,5	3,56
	Diametro interno Internal diameter	46	1,81		Diametro interno Internal diameter	41,5	1,63
	Diametro foro borchia Stud hole diameter	11	0,43		Diametro foro borchia Stud hole diameter	7	0,28
	Tipo mezzo filtrante Filter media type	Cellulosa / Cellulose			Tipo mezzo filtrante Filter media type	Cellulosa / Cellulose	
	Stile / Style	Rotondo a tenuta assiale Round axial seal			Stile / Style	Rotondo a tenuta assiale Round axial seal	
	Tipo / Type	Cartuccia primaria / Primary cartridge			Tipo / Type	Cartuccia primaria / Primary cartridge	
Note / Notes	L'altezza non include la guarnizione Height not include gasket		Note / Notes	L'altezza non include la guarnizione Height not include gasket			
Codice / Code	8001330000	mm	inch	Codice / Code	8001331000	mm	inch
	Altezza / Height	189	7,44		Altezza / Height	165	6,50
	Diametro esterno Outer diameter	155	6,10		Diametro esterno Outer diameter	85	3,35
	Diametro interno Internal diameter	88	3,46		Diametro interno Internal diameter	56	2,20
	Diametro foro borchia Stud hole diameter	18	0,71		Diametro foro borchia Stud hole diameter	17	0,67
	Tipo mezzo filtrante Filter media type	Cellulosa / Cellulose			Tipo mezzo filtrante Filter media type	Cellulosa / Cellulose	
	Stile / Style	Rotondo a tenuta assiale Round axial seal			Stile / Style	Rotondo a tenuta assiale Round axial seal	
	Tipo / Type	Cartuccia primaria / Primary cartridge			Tipo / Type	Cartuccia primaria / Primary cartridge	
Note / Notes	L'altezza non include la guarnizione Height not include gasket		Note / Notes	L'altezza non include la guarnizione Height not include gasket			
Codice / Code	8001334900	mm	inch	Codice / Code	8001335600	mm	inch
	Altezza / Height	235	9,25		Altezza / Height	508	20,00
	Diametro esterno Outer diameter	166	6,54		Diametro esterno Outer diameter	282	11,10
	Diametro interno Internal diameter	86,5	3,41		Diametro interno Internal diameter	171	6,73
	Diametro foro borchia Stud hole diameter	-	-		Diametro foro borchia Stud hole diameter	17	0,67
	Tipo mezzo filtrante Filter media type	Cellulosa / Cellulose			Tipo mezzo filtrante Filter media type	Cellulosa / Cellulose	
	Stile / Style	Rotondo a tenuta assiale Round axial seal			Stile / Style	Rotondo a tenuta assiale Round axial seal	
	Tipo / Type	-			Tipo / Type	Cartuccia primaria / Primary cartridge	
Note / Notes	-		Note / Notes	L'altezza non include la guarnizione Height not include gasket			
Codice / Code	8001335700	mm	inch	Codice / Code	8001340000	mm	inch
	Altezza / Height	508	20,00		Altezza / Height	600	23,62
	Diametro esterno sup. Upper outer diameter	195	7,68		Diametro esterno Outer diameter	324	12,76
	Diametro esterno inf. Lower outer diameter	162,5	6,40		Diametro interno Internal diameter	214	8,43
	Diametro interno Internal diameter	134	5,28		Diametro foro borchia Stud hole diameter	13	0,51
	Diametro foro borchia Stud hole diameter	17	0,67		Tipo mezzo filtrante Filter media type	Tela poliestere / Cloth Polyester	
	Tipo mezzo filtrante Filter media type	Cellulosa / Cellulose			Stile / Style	Rotondo a tenuta assiale Round axial seal	
	Stile / Style	Rotondo a tenuta assiale Round axial seal			Tipo / Type	-	
Tipo / Type	Cartuccia di sicurezza / Security cartridge		Note / Notes	L'altezza non include la guarnizione Height not include gasket			
Note / Notes	L'altezza non include la guarnizione Height not include gasket		Note / Notes	L'altezza non include la guarnizione Height not include gasket			

Cartuccia primaria abbinata
Matched primary cartridge
8001335600

Codice / Code	8001340400	mm	inch	Codice / Code	8001341000	mm	inch
	Altezza / Height	342	13,46		Altezza / Height	330	12,99
	Diametro esterno sup. Upper outer diameter	174	6,85		Diametro esterno sup. Upper outer diameter	60,7	2,39
	Diametro esterno inf. Lower outer diameter	140	5,51		Diametro esterno inf. Lower outer diameter	115,5	4,55
	Diametro interno Internal diameter	72	2,83		Diametro interno Internal diameter	48,5	1,91
	Diametro foro borchia Stud hole diameter	7/16 UNF - 20	7/16 UNF - 20		Diametro foro borchia Stud hole diameter	17	0,67
	Tipo mezzo filtrante Filter media type	Cellulosa / Cellulose		Cartuccia primaria abbinata Matched primary cartridge	Tipo mezzo filtrante Filter media type	Tessuto poliestere / Polyester Fiber	
	Stile / Style	Rotondo a tenuta assiale Round axial seal		8001146700	Stile / Style	Rotondo a tenuta assiale Round axial seal	
	Tipo / Type	Cartuccia primaria / Primary cartridge			Tipo / Type	Cartuccia di sicurezza / Security cartridge	
	Note / Notes	L'altezza non include la guarnizione Height not include gasket			Note / Notes	L'altezza non include la guarnizione Height not include gasket	
Codice / Code	8001342300	mm	inch	Codice / Code	8001342400	mm	inch
	Altezza / Height	202	7,95		Altezza / Height	335	13,19
	Diametro esterno Outer diameter	163	6,42		Diametro esterno Outer diameter	163	6,42
	Diametro interno Internal diameter	98	3,86		Diametro interno Internal diameter	98	3,86
	Diametro foro borchia Stud hole diameter	8,5	0,33		Diametro foro borchia Stud hole diameter	8,5	0,33
	Tipo mezzo filtrante Filter media type	Elemento filtrante metallico Metallic filter element			Tipo mezzo filtrante Filter media type	Elemento filtrante metallico Metallic filter element	
	Stile / Style	Rotondo a tenuta assiale Round axial seal			Stile / Style	Rotondo a tenuta assiale Round axial seal	
	Tipo / Type	-			Tipo / Type	-	
	Note / Notes	L'altezza non include la guarnizione Height not include gasket			Note / Notes	L'altezza non include la guarnizione Height not include gasket	
Codice / Code	8001346700	mm	inch	Codice / Code	8001347300	mm	inch
	Altezza / Height	92	3,62		Altezza / Height	440	17,32
	Diametro esterno Outer diameter	215	8,46		Diametro esterno sup. Upper outer diameter	279	10,98
	Diametro interno Internal diameter	146	5,75		Diametro esterno inf. Lower outer diameter	201	7,91
	Diametro foro borchia Stud hole diameter	-	-		Diametro interno Internal diameter	135	5,31
	Tipo mezzo filtrante Filter media type	Cellulosa / Cellulose			Diametro foro borchia Stud hole diameter	7/16 UNF - 20	7/16 UNF - 20
	Stile / Style	Rotondo a tenuta assiale Round axial seal			Tipo mezzo filtrante Filter media type	Cellulosa / Cellulose	
	Tipo / Type	-			Stile / Style	Rotondo a tenuta assiale Round axial seal	
	Note / Notes	-			Tipo / Type	Cartuccia primaria / Primary cartridge	
					Note / Notes	L'altezza non include la guarnizione Height not include gasket	
Codice / Code	8001347700	mm	inch	Codice / Code	8001348900	mm	inch
	Altezza / Height	330	12,99		Altezza / Height	78	3,07
	Diametro esterno sup. Upper outer diameter	276,5	10,89		Diametro esterno Outer diameter	207	8,15
	Diametro esterno inf. Lower outer diameter	234	9,21		Diametro interno Internal diameter	153	6,02
	Diametro interno Internal diameter	123	4,84		Diametro foro borchia Stud hole diameter	-	-
	Diametro foro borchia Stud hole diameter	7/16 UNF - 20	7/16 UNF - 20		Tipo mezzo filtrante Filter media type	Cellulosa / Cellulose	
	Tipo mezzo filtrante Filter media type	Cellulosa / Cellulose			Stile / Style	Rotondo a tenuta assiale Round axial seal	
	Stile / Style	Rotondo a tenuta assiale Round axial seal			Tipo / Type	-	
	Tipo / Type	Cartuccia primaria / Primary cartridge			Note / Notes	-	
	Note / Notes	L'altezza non include la guarnizione Height not include gasket					

Codice / Code	8001349500	mm	inch	Codice / Code	8001350000	mm	inch
	Altezza / Height	497	19,57		Altezza / Height	48	1,89
	Diametro esterno Outer diameter	282	11,10		Diametro esterno Outer diameter	242	9,53
	Diametro interno Internal diameter	171	6,73		Diametro interno Internal diameter	194	7,64
	Diametro foro borchia Stud hole diameter	17	0,67		Diametro foro borchia Stud hole diameter	-	-
	Tipo mezzo filtrante Filter media type	Elemento filtrante metallico Metallic filter element			Tipo mezzo filtrante Filter media type	Cellulosa / Cellulose	
	Stile / Style	Rotondo a tenuta assiale Round axial seal			Stile / Style	Rotondo a tenuta assiale Round axial seal	
	Tipo / Type	-			Tipo / Type	-	
	Note / Notes	L'altezza non include la guarnizione Height not include gasket			Note / Notes	-	
Codice / Code	8001350600	mm	inch	Codice / Code	8001351000	mm	inch
	Altezza / Height	197	7,76		Altezza / Height	230	9,06
	Diametro esterno Outer diameter	121	4,76		Diametro esterno sup. Upper outer diameter	108	4,25
	Diametro interno Internal diameter	75	2,95		Diametro esterno inf. Lower outer diameter	115	4,53
	Diametro foro borchia Stud hole diameter	9,5	0,37		Diametro interno Internal diameter	67	2,64
	Tipo mezzo filtrante Filter media type	Cellulosa / Cellulose			Diametro foro borchia Stud hole diameter	9,5	0,37
	Stile / Style	Rotondo a tenuta assiale Round axial seal			Tipo mezzo filtrante Filter media type	Cellulosa / Cellulose	
	Tipo / Type	-		Cartuccia di sicurezza abbinata Matched security cartridge	Stile / Style	Rotondo a tenuta assiale Round axial seal	
	Note / Notes	-		8001352000	Tipo / Type	Cartuccia primaria / Primary cartridge	
					Note / Notes	L'altezza non include la guarnizione Height not include gasket	
Codice / Code	8001352000	mm	inch	Codice / Code	8001352700	mm	inch
	Altezza / Height	209	8,23		Altezza / Height	380	14,96
	Diametro esterno Outer diameter	66	2,60		Diametro esterno Outer diameter	113	4,45
	Diametro interno Internal diameter	41	1,61		Diametro interno Internal diameter	105	4,13
	Diametro foro borchia Stud hole diameter	8,5	0,33		Diametro foro borchia Stud hole diameter	17	0,67
	Tipo mezzo filtrante Filter media type	Cellulosa / Cellulose			Tipo mezzo filtrante Filter media type	Tela poliestere / Cloth Polyester	
Cartuccia primaria abbinata Matched primary cartridge	Stile / Style	Rotondo a tenuta assiale Round axial seal		Cartuccia primaria abbinata Matched primary cartridge	Stile / Style	Rotondo a tenuta assiale Round axial seal	
8001351000	Tipo / Type	Cartuccia di sicurezza / Security cartridge		8001224200	Tipo / Type	Cartuccia di sicurezza / Security cartridge	
Codice / Code	8001352800	mm	inch	Codice / Code	8001352900	mm	inch
	Altezza / Height	470	18,50		Altezza / Height	479	18,86
	Diametro esterno Outer diameter	155	6,10		Diametro esterno Outer diameter	130	5,12
	Diametro interno Internal diameter	145	5,71		Diametro interno Internal diameter	125	4,92
	Diametro foro borchia Stud hole diameter	17	0,67		Diametro foro borchia Stud hole diameter	17	0,67
	Tipo mezzo filtrante Filter media type	Tela poliestere / Polyester Fiber			Tipo mezzo filtrante Filter media type	Tela poliestere / Polyester Fiber	
Cartuccia primaria abbinata Matched primary cartridge	Stile / Style	Rotondo a tenuta assiale Round axial seal		Cartuccia primaria abbinata Matched primary cartridge	Stile / Style	Rotondo a tenuta assiale Round axial seal	
8001227800	Tipo / Type	Cartuccia di sicurezza / Security cartridge		8001223500	Tipo / Type	Cartuccia di sicurezza / Security cartridge	

Codice / Code	8001353000	mm	inch	Codice / Code	8001353100	mm	inch
	Altezza / Height	345	13,58		Altezza / Height	370	14,57
	Diametro esterno Outer diameter	82	3,23		Diametro esterno Outer diameter	99	3,90
	Diametro interno Internal diameter	72	2,83		Diametro interno Internal diameter	89	3,50
	Diametro foro borchia Stud hole diameter	17	0,67		Diametro foro borchia Stud hole diameter	17	0,67
	Tipo mezzo filtrante Filter media type	Tessuto poliestere / Polyester Fiber			Tipo mezzo filtrante Filter media type	Tessuto poliestere / Polyester Fiber	
	Stile / Style	Rotondo a tenuta assiale Round axial seal			Stile / Style	Rotondo a tenuta assiale Round axial seal	
Cartuccia primaria abbinata Matched primary cartridge 8001238600				Cartuccia primaria abbinata Matched primary cartridge 8001238500			
Codice / Code	8001356100	mm	inch	Codice / Code	8001356200	mm	inch
	Altezza / Height	340	13,39		Altezza / Height	200	7,87
	Diametro esterno sup. Upper outer diameter	165	6,50		Diametro esterno Outer diameter	183	7,20
	Diametro esterno inf. Lower outer diameter	201	7,91		Diametro interno Internal diameter	120	4,72
	Diametro interno Internal diameter	118	4,65		Diametro foro borchia Stud hole diameter	9,5	0,37
	Diametro foro borchia Stud hole diameter	8,5	0,33		Tipo mezzo filtrante Filter media type	Cellulosa / Cellulose	
	Tipo mezzo filtrante Filter media type	Cellulosa / Cellulose			Stile / Style	Rotondo a tenuta assiale Round axial seal	
Stile / Style	Rotondo a tenuta assiale Round axial seal		Tipo / Type	-			
Tipo / Type	Cartuccia primaria / Primary cartridge		Note / Notes	-			
Note / Notes	L'altezza non include la guarnizione Height not include gasket						
Codice / Code	8001357300	mm	inch	Codice / Code	8001357700	mm	inch
	Altezza / Height	340	13,39		Altezza / Height	400	15,75
	Diametro esterno Outer diameter	164	6,46		Diametro esterno Outer diameter	234	9,21
	Diametro interno Internal diameter	86	3,39		Diametro interno Internal diameter	133	5,24
	Diametro foro borchia Stud hole diameter	9	0,35		Diametro foro borchia Stud hole diameter	16,5	0,65
	Tipo mezzo filtrante Filter media type	Cellulosa / Cellulose			Tipo mezzo filtrante Filter media type	Cellulosa / Cellulose	
	Stile / Style	Rotondo a tenuta assiale Round axial seal			Stile / Style	Rotondo a tenuta assiale Round axial seal	
Tipo / Type	Cartuccia primaria / Primary cartridge		Tipo / Type	Cartuccia primaria / Primary cartridge			
Note / Notes	L'altezza non include la guarnizione Height not include gasket		Note / Notes	L'altezza non include la guarnizione Height not include gasket			
Codice / Code	8001357900	mm	inch	Codice / Code	8001359100	mm	inch
	Altezza / Height	205	8,07		Altezza / Height	600	23,62
	Diametro esterno Outer diameter	164	6,46		Diametro esterno Outer diameter	324	12,76
	Diametro interno Internal diameter	86	3,39		Diametro interno sup. Upper internal diameter	214	8,43
	Diametro foro borchia Stud hole diameter	9	0,35		Diametro interno inf. Lower internal diameter	214	8,43
	Tipo mezzo filtrante Filter media type	Cellulosa / Cellulose			Diametro foro borchia Stud hole diameter	-	-
	Stile / Style	Rotondo a tenuta assiale Round axial seal			Tipo mezzo filtrante Filter media type	Tela poliestere / Cloth Polyester	
Tipo / Type	Cartuccia primaria / Primary cartridge		Stile / Style	-			
Note / Notes	L'altezza non include la guarnizione Height not include gasket		Tipo / Type	Per impianti di verniciatura Painting Plants			
Note / Notes	L'altezza non include la guarnizione Height not include gasket		Note / Notes	L'altezza non include la guarnizione Height not include gasket			

Codice / Code	8001359700	mm	inch
	Altezza / Height	189	7,44
	Diametro esterno sup. / Upper outer diameter	104	4,09
	Diametro esterno inf. / Lower outer diameter	150	5,91
	Diametro interno / Internal diameter	64	2,52
	Diametro foro borchia / Stud hole diameter	7	0,28
	Tipo mezzo filtrante / Filter media type	Cellulosa / Cellulose	
	Stile / Style	Rotondo a tenuta assiale / Round axial seal	
Tipo / Type	Cartuccia primaria / Primary cartridge		
Note / Notes	L'altezza non include la guarnizione / Height not include gasket		

Codice / Code	8001362300	mm	inch
	Altezza / Height	255	10,04
	Diametro esterno sup. / Upper outer diameter	104	4,09
	Diametro esterno inf. / Lower outer diameter	150	5,91
	Diametro interno / Internal diameter	64	2,52
	Diametro foro borchia / Stud hole diameter	7	0,28
	Tipo mezzo filtrante / Filter media type	Cellulosa / Cellulose	
	Stile / Style	Rotondo a tenuta assiale con alette / Round axial seal with fins	
Tipo / Type	Cartuccia primaria / Primary cartridge		
Note / Notes	L'altezza non include la guarnizione / Height not include gasket		

Codice / Code	8001363200	mm	inch
	Altezza / Height	456	17,95
	Diametro esterno / Outer diameter	234	9,21
	Diametro interno / Internal diameter	124	4,88
	Diametro foro borchia / Stud hole diameter	16,5	0,65
	Tipo mezzo filtrante / Filter media type	Cellulosa / Cellulose	
	Stile / Style	Rotondo a tenuta assiale con alette / Round axial seal with fins	
	Tipo / Type	Cartuccia primaria / Primary cartridge	
Note / Notes	L'altezza non include la guarnizione / Height not include gasket		

Cartuccia di sicurezza abbinata / Matched security cartridge
8001363600

Codice / Code	8001363600	mm	inch
	Altezza / Height	450	17,72
	Diametro esterno sup. / Upper outer diameter	148	5,83
	Diametro esterno inf. / Lower outer diameter	117	4,61
	Diametro interno / Internal diameter	88	3,46
	Diametro foro borchia / Stud hole diameter	17	0,67
	Tipo mezzo filtrante / Filter media type	Cellulosa / Cellulose	
	Stile / Style	Rotondo a tenuta assiale / Round axial seal	
Tipo / Type	Cartuccia di sicurezza / Security cartridge		
Note / Notes	L'altezza non include la guarnizione / Height not include gasket		









Cartuccia primaria abbinata / Matched primary cartridge
8001363200











Codice / Code	8001364400	mm	inch
	Altezza / Height	224	8,82
	Diametro esterno / Outer diameter	126	4,96
	Diametro interno / Internal diameter	65	2,56
	Diametro foro borchia / Stud hole diameter	9	0,35
	Tipo mezzo filtrante / Filter media type	Cellulosa / Cellulose	
	Stile / Style	Rotondo a tenuta assiale / Round axial seal	
	Tipo / Type	Cartuccia primaria / Primary cartridge	
Note / Notes	L'altezza non include la guarnizione / Height not include gasket		

Codice / Code	8001369200	mm	inch
	Altezza / Height	460	18,11
	Diametro esterno / Outer diameter	282	11,10
	Diametro interno / Internal diameter	198	7,80
	Diametro foro borchia / Stud hole diameter	17	0,67
	Tipo mezzo filtrante / Filter media type	Cellulosa / Cellulose	
	Stile / Style	Rotondo a tenuta assiale / Round axial seal	
	Tipo / Type	Cartuccia primaria / Primary cartridge	
Note / Notes	L'altezza non include la guarnizione / Height not include gasket		

Codice / Code	8001376300	mm	inch
	Altezza / Height	458	18,03
	Diametro esterno / Outer diameter	327	12,87
	Diametro interno / Internal diameter	216	8,50
	Diametro foro borchia / Stud hole diameter	16	0,63
	Tipo mezzo filtrante / Filter media type	Cellulosa / Cellulose	
	Stile / Style	Rotondo a tenuta assiale / Round axial seal	
	Tipo / Type	Cartuccia primaria / Primary cartridge	
Note / Notes	L'altezza non include la guarnizione / Height not include gasket		

Codice / Code	8001377100	mm	inch
	Altezza / Height	838	32,99
	Diametro esterno / Outer diameter	327	12,87
	Diametro interno / Internal diameter	255	10,04
	Diametro foro borchia / Stud hole diameter	16	0,63
	Tipo mezzo filtrante / Filter media type	Cellulosa / Cellulose	
	Stile / Style	Rotondo a tenuta assiale / Round axial seal	
	Tipo / Type	Cartuccia primaria / Primary cartridge	
Note / Notes	L'altezza non include la guarnizione / Height not include gasket		

Codice / Code	8001379700	mm	inch	Codice / Code	8001381100	mm	inch
	Altezza / Height	497	19,57		Altezza / Height	296	11,65
	Diametro esterno Outer diameter	282	11,10		Diametro esterno Outer diameter	155	6,10
	Diametro interno Internal diameter	198	7,80		Diametro interno Internal diameter	92	3,62
	Diametro foro borchia Stud hole diameter	17	0,67		Diametro foro borchia Stud hole diameter	18	0,71
	Tipo mezzo filtrante Filter media type	Elemento filtrante metallico Metallic filter element			Tipo mezzo filtrante Filter media type	Cellulosa / Cellulose	
Stile / Style	Rotondo a tenuta assiale Round axial seal		Stile / Style	Rotondo a tenuta assiale con alette Round axial seal with fins			
Tipo / Type	-		Tipo / Type	Cartuccia primaria / Primary cartridge			
Note / Notes	L'altezza non include la guarnizione Height not include gasket		Note / Notes	L'altezza non include la guarnizione Height not include gasket			
Codice / Code	8001381800	mm	inch	Codice / Code	8001382400	mm	inch
	Altezza / Height	374	14,72		Altezza / Height	273	10,75
	Diametro esterno Outer diameter	155	6,10		Diametro esterno Outer diameter	134	5,28
	Diametro interno Internal diameter	92	3,62		Diametro interno Internal diameter	70	2,76
	Diametro foro borchia Stud hole diameter	18	0,71		Diametro foro borchia Stud hole diameter	18	0,71
	Tipo mezzo filtrante Filter media type	Cellulosa / Cellulose			Tipo mezzo filtrante Filter media type	Cellulosa / Cellulose	
Stile / Style	Rotondo a tenuta assiale con alette Round axial seal with fins		Stile / Style	Rotondo a tenuta assiale con alette Round axial seal with fins			
Tipo / Type	Cartuccia primaria / Primary cartridge		Tipo / Type	Cartuccia primaria / Primary cartridge			
Note / Notes	L'altezza non include la guarnizione Height not include gasket		Note / Notes	L'altezza non include la guarnizione Height not include gasket			
Codice / Code	8001383500	mm	inch	Codice / Code	8001384800	mm	inch
	Altezza / Height	165	6,50		Altezza / Height	383	15,08
	Diametro esterno Outer diameter	160	6,30		Diametro esterno Outer diameter	155	6,10
	Diametro interno Internal diameter	77	3,03		Diametro interno Internal diameter	88	3,46
	Diametro foro borchia Stud hole diameter	-	-		Diametro foro borchia Stud hole diameter	19	0,75
	Tipo mezzo filtrante Filter media type	Cellulosa / Cellulose			Tipo mezzo filtrante Filter media type	Cellulosa / Cellulose	
Stile / Style	-		Stile / Style	Rotondo a tenuta assiale con alette Round axial seal with fins			
Tipo / Type	-		Tipo / Type	Cartuccia primaria / Primary cartridge			
Note / Notes	-		Note / Notes	L'altezza non include la guarnizione Height not include gasket			
Codice / Code	8001388000	mm	inch	Codice / Code	8001388900	mm	inch
	Altezza / Height	600	23,62		Altezza / Height	336	13,23
	Diametro esterno Outer diameter	485	19,09		Diametro esterno Outer diameter	188	7,40
	Diametro interno Internal diameter	335	13,19		Diametro interno Internal diameter	160	6,30
	Diametro foro borchia Stud hole diameter	-	-		Diametro foro borchia Stud hole diameter	14,5	0,57
	Tipo mezzo filtrante Filter media type	Cellulosa / Cellulose			Tipo mezzo filtrante Filter media type	Bulpren	
Stile / Style	Rotondo a tenuta assiale Round axial seal		Stile / Style	-			
Tipo / Type	-		Tipo / Type	-			
Note / Notes	L'altezza non include la guarnizione Height not include gasket		Note / Notes	-			

Codice / Code	8001390500	mm	inch	Codice / Code	8001393900	mm	inch
	Altezza / Height	508	20,00		Altezza / Height	324	12,76
	Diametro esterno Outer diameter	282	11,10		Diametro esterno Outer diameter	178	7,01
	Diametro interno Internal diameter	171	6,73		Diametro interno Internal diameter	155	6,10
	Diametro foro borchia Stud hole diameter	17	0,67		Diametro foro borchia Stud hole diameter	-	-
	Tipo mezzo filtrante Filter media type	Cellulosa / Cellulose			Tipo mezzo filtrante Filter media type	Bulpren	
	Stile / Style	Rotondo a tenuta assiale Round axial seal			Stile / Style	-	
	Tipo / Type	Cartuccia primaria / Primary cartridge			Tipo / Type	-	
Note / Notes	L'altezza non include la guarnizione Height not include gasket		Note / Notes	-			
Codice / Code	8001394700	mm	inch	Codice / Code	8001394800	mm	inch
	Altezza / Height	156	6,14		Altezza / Height	316	12,44
	Diametro esterno Outer diameter	280	11,02		Diametro esterno sup. Upper outer diameter	280	11,02
	Diametro interno Internal diameter	138	5,43		Diametro interno Internal diameter	178	7,01
	Tipo mezzo filtrante Filter media type	Cellulosa / Cellulose			Tipo mezzo filtrante Filter media type	-	
	Stile / Style	-			Stile / Style	-	
	Tipo / Type	-			Tipo / Type	-	
Codice / Code	8001398200	mm	inch	Codice / Code	8001400600	mm	inch
	Altezza / Height	145	5,71		Altezza / Height	74	2,91
	Diametro esterno Outer diameter	120	4,72		Diametro esterno Outer diameter	207	8,15
	Diametro interno Internal diameter	70	2,76		Diametro interno Internal diameter	153	6,02
	Diametro foro borchia Stud hole diameter	6,5	0,26		Diametro foro borchia Stud hole diameter	-	-
	Tipo mezzo filtrante Filter media type	Cellulosa / Cellulose			Tipo mezzo filtrante Filter media type	Bulpren	
	Stile / Style	Rotondo a tenuta assiale Round axial seal			Stile / Style	Rotondo a tenuta assiale Round axial seal	
Tipo / Type	-		Tipo / Type	-			
Codice / Code	8001401500	mm	inch	Codice / Code	8001404700	mm	inch
	Altezza / Height	228	8,98		Altezza / Height	254	10,00
	Diametro esterno Outer diameter	104	4,09		Diametro esterno sup. Upper outer diameter	104	4,09
	Diametro interno Internal diameter	63	2,48		Diametro esterno inf. Lower outer diameter	150	5,91
	Diametro foro borchia Stud hole diameter	19	0,75		Diametro interno Internal diameter	63	2,48
	Tipo mezzo filtrante Filter media type	Cellulosa / Cellulose			Diametro foro borchia Stud hole diameter	14	0,55
	Stile / Style	Rotondo a tenuta assiale con alette Round axial seal with fins			Tipo mezzo filtrante Filter media type	Cellulosa / Cellulose	
	Tipo / Type	Cartuccia primaria / Primary cartridge			Stile / Style	Rotondo a tenuta assiale Round axial seal	
Note / Notes	L'altezza non include la guarnizione Height not include gasket		Tipo / Type	Cartuccia primaria / Primary cartridge			
Codice / Code	8001405800	mm	inch	Codice / Code	8001406300	mm	inch
	Altezza / Height	788	31,02		Altezza / Height	198	7,80
	Diametro esterno Outer diameter	324	12,76		Diametro esterno Outer diameter	111	4,37
	Diametro interno Internal diameter	214	8,43		Diametro interno Internal diameter	50	1,97
	Diametro foro borchia Stud hole diameter	13	0,51		Diametro foro borchia Stud hole diameter	-	-
	Tipo mezzo filtrante Filter media type	Cellulosa / Cellulose			Tipo mezzo filtrante Filter media type	Cellulosa / Cellulose	
	Stile / Style	Rotondo a tenuta assiale Round axial seal			Stile / Style	-	
	Tipo / Type	-			Tipo / Type	-	
Note / Notes	L'altezza non include la guarnizione Height not include gasket		Note / Notes	-			

Codice / Code	8001407400	mm	inch
	Altezza / Height	329	12,95
	Diametro esterno Outer diameter	142	5,59
	Diametro interno Internal diameter	82	3,23
	Diametro foro borchia Stud hole diameter	-	-
	Tipo mezzo filtrante Filter media type	Cellulosa / Cellulose	
	Stile / Style	Rotondo a tenuta radiale Round radial seal	
	Tipo / Type	Cartuccia primaria / Primary cartridge	
Note / Notes	-		

Cartuccia di sicurezza abbinata
Matched security cartridge
8001427000

Codice / Code	8001410400	mm	inch
	Altezza / Height	356	14,02
	Diametro esterno Outer diameter	173	6,81
	Diametro interno Internal diameter	88	3,46
	Diametro foro borchia Stud hole diameter	17	0,67
	Tipo mezzo filtrante Filter media type	Cellulosa / Cellulose	
	Stile / Style	Rotondo a tenuta assiale Round axial seal	
	Tipo / Type	Cartuccia primaria / Primary cartridge	
Note / Notes	L'altezza non include la guarnizione Height not include gasket		

Codice / Code	8001410700	mm	inch
	Altezza / Height	356	14,02
	Diametro esterno Outer diameter	242	9,53
	Diametro interno Internal diameter	132	5,20
	Diametro foro borchia Stud hole diameter	11	0,43
	Tipo mezzo filtrante Filter media type	Cellulosa / Cellulose	
	Stile / Style	Rotondo a tenuta assiale Round axial seal	
	Tipo / Type	Cartuccia primaria / Primary cartridge	
Note / Notes	L'altezza non include la guarnizione Height not include gasket		

Codice / Code	8001411100	mm	inch
	Altezza / Height	171	6,73
	Diametro esterno Outer diameter	160	6,30
	Diametro interno Internal diameter	60,5	2,38
	Diametro foro borchia Stud hole diameter	-	-
	Tipo mezzo filtrante Filter media type	Cellulosa / Cellulose	
	Stile / Style	-	
	Tipo / Type	-	
Note / Notes	-		









Codice / Code	8001411300	mm	inch
	Altezza / Height	283	11,14
	Diametro esterno sup. Upper outer diameter	50	1,97
	Diametro esterno inf. Lower outer diameter	92,5	3,64
	Diametro interno Internal diameter	62	2,44
	Diametro foro borchia Stud hole diameter	17	0,67
	Tipo mezzo filtrante Filter media type	Tessuto poliestere / Polyester Fiber	
	Stile / Style	Rotondo a tenuta assiale Round axial seal	
Tipo / Type	Cartuccia di sicurezza / Security cartridge		
Note / Notes	L'altezza non include la guarnizione Height not include gasket		

Cartuccia primaria abbinata
Matched primary cartridge
8001229000

Codice / Code	8001413300	mm	inch
	Altezza / Height	986	38,82
	Diametro esterno Outer diameter	324	12,76
	Diametro interno Internal diameter	214	8,43
	Diametro foro borchia Stud hole diameter	13	0,51
	Tipo mezzo filtrante Filter media type	Cellulosa / Cellulose	
	Stile / Style	Rotondo a tenuta assiale Round axial seal	
	Tipo / Type	Per impianti di verniciatura Painting Plants	
Note / Notes	L'altezza non include la guarnizione Height not include gasket		

Codice / Code	8001415200	mm	inch
	Altezza / Height	210	8,27
	Diametro esterno Outer diameter	110	4,33
	Diametro interno Internal diameter	63	2,48
	Diametro foro borchia Stud hole diameter	-	-
	Tipo mezzo filtrante Filter media type	Cellulosa / Cellulose	
	Stile / Style	Rotondo a tenuta assiale Round axial seal	
	Tipo / Type	-	
Note / Notes	-		

Codice / Code	8001415400	mm	inch
	Altezza / Height	406	15,98
	Diametro esterno Outer diameter	245,5	9,67
	Diametro interno Internal diameter	154	6,06
	Diametro foro borchia Stud hole diameter	16	0,63
	Tipo mezzo filtrante Filter media type	Cellulosa / Cellulose	
	Stile / Style	Rotondo a tenuta assiale con alette Round axial seal with fins	
	Tipo / Type	Cartuccia primaria / Primary cartridge	
Note / Notes	L'altezza non include la guarnizione Height not include gasket		

Codice / Code	8001416000	mm	inch	Codice / Code	8001418300	mm	inch
	Altezza / Height	262	10,31		Altezza / Height	285	11,22
	Diametro esterno Outer diameter	66	2,60		Diametro esterno sup. Upper outer diameter	95,5	3,76
	Diametro interno Internal diameter	56	2,20		Diametro esterno inf. Lower outer diameter	85,5	3,37
	Diametro foro borchia Stud hole diameter	17	0,67		Diametro interno Internal diameter	74,5	2,93
	Tipo mezzo filtrante Filter media type	Tessuto poliestere / Polyester Fiber			Diametro foro borchia Stud hole diameter	9	0,35
	Stile / Style	Rotondo a tenuta assiale Round axial seal			Tipo mezzo filtrante Filter media type	Tessuto poliestere / Polyester Fiber	
	Tipo / Type	Cartuccia di sicurezza / Security cartridge			Stile / Style	Rotondo a tenuta assiale Round axial seal	
Note / Notes	L'altezza non include la guarnizione Height not include gasket		Tipo / Type	Cartuccia di sicurezza / Security cartridge			
Note / Notes	L'altezza non include la guarnizione Height not include gasket		Note / Notes	L'altezza non include la guarnizione Height not include gasket			
Codice / Code	8001421100	mm	inch	Codice / Code	8001421400	mm	inch
	Altezza / Height	189	7,44		Altezza / Height	220	8,66
	Diametro esterno Outer diameter	155	6,10		Diametro esterno Outer diameter	120	4,72
	Diametro interno Internal diameter	88	3,46		Diametro interno Internal diameter	70	2,76
	Diametro foro borchia Stud hole diameter	18	0,71		Diametro foro borchia Stud hole diameter	6,5	0,26
	Tipo mezzo filtrante Filter media type	Cellulosa / Cellulose			Tipo mezzo filtrante Filter media type	Cellulosa / Cellulose	
	Stile / Style	Rotondo a tenuta assiale con alette Round axial seal with fins			Stile / Style	Rotondo a tenuta assiale Round axial seal	
	Tipo / Type	Cartuccia primaria / Primary cartridge			Tipo / Type	-	
Note / Notes	L'altezza non include la guarnizione Height not include gasket		Note / Notes	-			
Codice / Code	8001423700	mm	inch	Codice / Code	8001424500	mm	inch
	Altezza / Height	331	13,03		Altezza / Height	60	2,36
	Diametro esterno sup. Upper outer diameter	279	10,98		Diametro esterno Outer diameter	120	4,72
	Diametro esterno inf. Lower outer diameter	234	9,21		Diametro interno Internal diameter	70	2,76
	Diametro interno Internal diameter	124	4,88		Diametro foro borchia Stud hole diameter	-	-
	Diametro foro borchia Stud hole diameter	7/16 UNF - 20	7/16 UNF - 20		Tipo mezzo filtrante Filter media type	Cellulosa / Cellulose	
	Tipo mezzo filtrante Filter media type	Cellulosa / Cellulose			Stile / Style	Rotondo a tenuta assiale Round axial seal	
	Stile / Style	Rotondo a tenuta assiale Round axial seal			Tipo / Type	-	
Tipo / Type	Cartuccia primaria / Primary cartridge		Note / Notes	-			
Note / Notes	L'altezza non include la guarnizione Height not include gasket		Note / Notes	-			
Codice / Code	8001425700	mm	inch	Codice / Code	8001425900	mm	inch
	Altezza / Height	217	8,54		Altezza / Height	376	14,80
	Diametro esterno Outer diameter	234	9,21		Diametro esterno Outer diameter	302	11,89
	Diametro interno Internal diameter	133	5,24		Diametro interno Internal diameter	191	7,52
	Diametro foro borchia Stud hole diameter	15	0,59		Diametro foro borchia Stud hole diameter	10,5	0,41
	Tipo mezzo filtrante Filter media type	Cellulosa / Cellulose			Tipo mezzo filtrante Filter media type	Cellulosa / Cellulose	
	Stile / Style	Rotondo a tenuta assiale Round axial seal			Stile / Style	Rotondo a tenuta assiale Round axial seal	
	Tipo / Type	Cartuccia primaria / Primary cartridge			Tipo / Type	Cartuccia primaria / Primary cartridge	
Note / Notes	L'altezza non include la guarnizione Height not include gasket		Note / Notes	L'altezza non include la guarnizione Height not include gasket			

Codice / Code	8001427000	mm	inch
	Altezza / Height	315	12,40
	Diametro esterno sup. / Upper outer diameter	78	3,07
	Diametro esterno inf. / Lower outer diameter	85	3,35
	Diametro interno / Internal diameter	63	2,48
	Diametro foro borchia / Stud hole diameter	-	-
	Tipo mezzo filtrante / Filter media type	Tessuto poliestere / Polyester Fiber	
Stile / Style	Rotondo a tenuta radiale / Round radial seal		
Tipo / Type	Cartuccia di sicurezza / Security cartridge		
Note / Notes	-		

Cartuccia primaria abbinata
Matched primary cartridge

8001407400

Codice / Code	8001431200	mm	inch
	Altezza / Height	408	16,06
	Diametro esterno / Outer diameter	282	11,10
	Diametro interno / Internal diameter	171	6,73
	Diametro foro borchia / Stud hole diameter	17	0,67
	Tipo mezzo filtrante / Filter media type	Elemento filtrante metallico / Metallic filter element	
	Stile / Style	Rotondo a tenuta assiale / Round axial seal	
Tipo / Type	-		
Note / Notes	L'altezza non include la guarnizione / Height not include gasket		

Codice / Code	8001433400	mm	inch
	Altezza / Height	310	12,20
	Diametro esterno sup. / Upper outer diameter	211	8,31
	Diametro esterno inf. / Lower outer diameter	230	9,06
	Diametro interno / Internal diameter	135	5,31
	Diametro foro borchia / Stud hole diameter	10	0,39
	Tipo mezzo filtrante / Filter media type	Cellulosa / Cellulose	
Stile / Style	Rotondo a tenuta assiale / Round axial seal		
Tipo / Type	Cartuccia primaria / Primary cartridge		
Note / Notes	L'altezza non include la guarnizione / Height not include gasket		

Codice / Code	8001434000	mm	inch
	Altezza / Height	283	11,14
	Diametro esterno / Outer diameter	132	5,20
	Diametro interno / Internal diameter	103	4,06
	Diametro foro borchia / Stud hole diameter	8,5	0,33
	Tipo mezzo filtrante / Filter media type	Cellulosa / Cellulose	
	Stile / Style	Rotondo a tenuta assiale / Round axial seal	
Tipo / Type	Cartuccia primaria / Primary cartridge		
Note / Notes	L'altezza non include la guarnizione / Height not include gasket		

Codice / Code	8001434300	mm	inch
	Altezza / Height	254	10,00
	Diametro esterno sup. / Upper outer diameter	79	3,11
	Diametro esterno inf. / Lower outer diameter	64,5	2,54
	Diametro interno / Internal diameter	56	2,20
	Diametro foro borchia / Stud hole diameter	17	0,67
	Tipo mezzo filtrante / Filter media type	Tessuto poliestere / Polyester Fiber	
Stile / Style	Rotondo a tenuta assiale / Round axial seal		
Tipo / Type	Cartuccia di sicurezza / Security cartridge		
Note / Notes	L'altezza non include la guarnizione / Height not include gasket		

Codice / Code	8001438000	mm	inch
	Altezza / Height	332	13,07
	Diametro esterno sup. / Upper outer diameter	272	10,71
	Diametro esterno inf. / Lower outer diameter	254,5	10,02
	Diametro interno / Internal diameter	123,5	4,86
	Diametro foro borchia / Stud hole diameter	7/16 UNF - 20	7/16 UNF - 20
	Tipo mezzo filtrante / Filter media type	Cellulosa / Cellulose	
Stile / Style	Rotondo a tenuta assiale / Round axial seal		
Tipo / Type	Cartuccia di sicurezza / Security cartridge		
Note / Notes	L'altezza non include la guarnizione / Height not include gasket		

Codice / Code	8001438600	mm	inch
	Altezza / Height	407	16,02
	Diametro esterno sup. / Upper outer diameter	214	8,43
	Diametro esterno inf. / Lower outer diameter	198	7,80
	Diametro interno / Internal diameter	88	3,46
	Diametro foro borchia / Stud hole diameter	7/16 UNF - 20	7/16 UNF - 20
	Tipo mezzo filtrante / Filter media type	Cellulosa / Cellulose	
Stile / Style	Rotondo a tenuta assiale con alette / Round axial seal with fins		
Tipo / Type	Cartuccia primaria / Primary cartridge		
Note / Notes	L'altezza non include la guarnizione / Height not include gasket		

Codice / Code	8001438700	mm	inch
	Altezza / Height	342	13,46
	Diametro esterno / Outer diameter	154	6,06
	Diametro interno / Internal diameter	80	3,15
	Diametro foro borchia / Stud hole diameter	-	-
	Tipo mezzo filtrante / Filter media type	Cellulosa / Cellulose	
	Stile / Style	Rotondo a tenuta radiale / Round radial seal	
Tipo / Type	Cartuccia primaria / Primary cartridge		
Note / Notes	-		

Codice / Code	8001438800	mm	inch
	Altezza / Height	285	11,22
	Diametro esterno Outer diameter	166	6,54
	Diametro interno Internal diameter	75	2,95
	Diametro foro borchia Stud hole diameter	-	-
	Tipo mezzo filtrante Filter media type	Cellulosa / Cellulose	
Stile / Style	Rotondo a tenuta radiale Round radial seal		
Tipo / Type	-		
Note / Notes	-		

Codice / Code	8001439300	mm	inch
	Altezza / Height	253	9,96
	Diametro esterno Outer diameter	104	4,09
	Diametro interno Internal diameter	63	2,48
	Diametro foro borchia Stud hole diameter	18	0,71
	Tipo mezzo filtrante Filter media type	Cellulosa / Cellulose	
Stile / Style	Rotondo a tenuta assiale con alette Round axial seal with fins		
Tipo / Type	Cartuccia primaria / Primary cartridge		
Note / Notes	L'altezza non include la guarnizione Height not include gasket		

Codice / Code	8001440200	mm	inch
	Altezza / Height	286	11,26
	Diametro esterno sup. Upper outer diameter	56	2,20
	Diametro esterno inf. Lower outer diameter	59	2,32
	Diametro interno Internal diameter	41	1,61
	Tipo mezzo filtrante Filter media type	Tessuto poliestere / Polyester Fiber	
Stile / Style	Rotondo a tenuta radiale Round radial seal		
Tipo / Type	Cartuccia di sicurezza / Security cartridge		

Cartuccia primaria abbinata
Matched primary cartridge
8001440900

Codice / Code	8001440900	mm	inch
	Altezza / Height	296	11,65
	Diametro esterno Outer diameter	105	4,13
	Diametro interno Internal diameter	61	2,40
	Tipo mezzo filtrante Filter media type	Cellulosa / Cellulose	
	Stile / Style	Rotondo a tenuta radiale Round radial seal	
Tipo / Type	Cartuccia primaria / Primary cartridge		

Cartuccia di sicurezza abbinata
Matched security cartridge
8001440200

Codice / Code	8001441000	mm	inch
	Altezza / Height	342	13,46
	Diametro esterno Outer diameter	162	6,38
	Diametro interno Internal diameter	90	3,54
	Tipo mezzo filtrante Filter media type	Cellulosa / Cellulose	
	Stile / Style	Rotondo a tenuta radiale Round radial seal	
Tipo / Type	Cartuccia primaria / Primary cartridge		

Cartuccia di sicurezza abbinata
Matched security cartridge
8001441300









Codice / Code	8001441200	mm	inch
	Altezza / Height	184	7,24
	Diametro esterno Outer diameter	89	3,50
	Diametro interno Internal diameter	46	1,81
	Tipo mezzo filtrante Filter media type	Cellulosa / Cellulose	
	Stile / Style	Rotondo a tenuta radiale Round radial seal	
Tipo / Type	Cartuccia primaria / Primary cartridge		











Cartuccia di sicurezza abbinata
Matched security cartridge
8001517000

Codice / Code	8001441300	mm	inch
	Altezza / Height	338	13,31
	Diametro esterno sup. Upper outer diameter	88	3,46
	Diametro esterno inf. Lower outer diameter	92	3,62
	Diametro interno Internal diameter	73	2,87
	Diametro foro borchia Stud hole diameter	-	-
Tipo mezzo filtrante Filter media type	Tessuto poliestere / Polyester Fiber		
Stile / Style	Rotondo a tenuta radiale Round radial seal		
Tipo / Type	Cartuccia di sicurezza / Security cartridge		
Note / Notes	-		

Cartuccia primaria abbinata
Matched primary cartridge
8001441000

Codice / Code	8001442500	mm	inch
	Altezza / Height	96	3,78
	Diametro esterno Outer diameter	164	6,46
	Diametro interno Internal diameter	86	3,39
	Diametro foro borchia Stud hole diameter	9	0,35
	Tipo mezzo filtrante Filter media type	Cellulosa / Cellulose	
Stile / Style	Rotondo a tenuta assiale Round axial seal		
Tipo / Type	Cartuccia primaria / Primary cartridge		
Note / Notes	L'altezza non include la guarnizione Height not include gasket		

Codice / Code	8001445500	mm	inch	Codice / Code	8001453300	mm	inch
	Altezza / Height	406	15,98		Altezza / Height	330	12,99
	Diametro esterno sup. Upper outer diameter	279	10,98		Diametro esterno sup. Upper outer diameter	213	8,39
	Diametro esterno inf. Lower outer diameter	201	7,91		Diametro esterno inf. Lower outer diameter	197	7,76
	Diametro interno Internal diameter	135	5,31		Diametro interno Internal diameter	87	3,43
	Diametro foro borchia Stud hole diameter	7/16 UNF - 20	7/16 UNF - 20		Diametro foro borchia Stud hole diameter	7/16 UNF - 20	7/16 UNF - 20
	Tipo mezzo filtrante Filter media type	Cellulosa / Cellulose			Tipo mezzo filtrante Filter media type	Cellulosa / Cellulose	
	Stile / Style	Rotondo a tenuta assiale con alette Round axial seal with fins			Stile / Style	Rotondo a tenuta assiale Round axial seal	
	Tipo / Type	Cartuccia primaria / Primary cartridge			Tipo / Type	Cartuccia primaria / Primary cartridge	
	Note / Notes	L'altezza non include la guarnizione Height not include gasket			Note / Notes	L'altezza non include la guarnizione Height not include gasket	
Codice / Code	8001453600	mm	inch	Codice / Code	8001470300	mm	inch
	Altezza / Height	200	7,87		Altezza / Height	345	13,58
	Diametro esterno Outer diameter	234	9,21		Diametro esterno Outer diameter	162	6,38
	Diametro interno Internal diameter	133	5,24		Diametro interno Internal diameter	90	3,54
	Diametro foro borchia Stud hole diameter	16,5	0,65		Diametro foro borchia Stud hole diameter	-	-
	Tipo mezzo filtrante Filter media type	Cellulosa / Cellulose			Tipo mezzo filtrante Filter media type	Cellulosa / Cellulose	
	Stile / Style	Rotondo a tenuta assiale Round axial seal			Stile / Style	Rotondo a tenuta radiale Round radial seal	
	Tipo / Type	Cartuccia primaria / Primary cartridge			Tipo / Type	Cartuccia primaria / Primary cartridge	
	Note / Notes	L'altezza non include la guarnizione Height not include gasket			Note / Notes	-	
				8001470800			
Codice / Code	8001470800	mm	inch	Codice / Code	8001471500	mm	inch
	Altezza / Height	331	13,03		Altezza / Height	288	11,34
	Diametro esterno sup. Upper outer diameter	88	3,46		Diametro esterno sup. Upper outer diameter	112	4,41
	Diametro esterno inf. Lower outer diameter	92	3,62		Diametro esterno inf. Lower outer diameter	92	3,62
	Diametro interno Internal diameter	73	2,87		Diametro interno Internal diameter	76,5	3,01
	Diametro foro borchia Stud hole diameter	-	-		Diametro foro borchia Stud hole diameter	11	0,43
	Tipo mezzo filtrante Filter media type	Tessuto poliestere / Polyester Fiber			Tipo mezzo filtrante Filter media type	Tessuto poliestere / Polyester Fiber	
	Stile / Style	Rotondo a tenuta radiale Round radial seal			Stile / Style	Rotondo a tenuta assiale Round axial seal	
	Tipo / Type	Cartuccia di sicurezza / Security cartridge			Tipo / Type	Cartuccia di sicurezza / Security cartridge	
	Note / Notes	-			Note / Notes	L'altezza non include la guarnizione Height not include gasket	
Cartuccia primaria abbinata Matched primary cartridge				Cartuccia primaria abbinata Matched primary cartridge			
8001470300				8001472200			
Codice / Code	8001472200	mm	inch	Codice / Code	8001473300	mm	inch
	Altezza / Height	324	12,76		Altezza / Height	383	15,08
	Diametro esterno sup. Upper outer diameter	189	7,44		Diametro esterno Outer diameter	134	5,28
	Diametro esterno inf. Lower outer diameter	196	7,72		Diametro interno Internal diameter	83,5	3,29
	Diametro interno Internal diameter	96	3,78		Diametro foro borchia Stud hole diameter	19	0,75
	Diametro foro borchia Stud hole diameter	M10 x 1,5	M10 x 1,5		Tipo mezzo filtrante Filter media type	Cellulosa / Cellulose	
	Tipo mezzo filtrante Filter media type	Cellulosa / Cellulose			Stile / Style	Rotondo a tenuta assiale con alette Round axial seal with fins	
	Stile / Style	Rotondo a tenuta assiale Round axial seal			Tipo / Type	Cartuccia primaria / Primary cartridge	
	Tipo / Type	Cartuccia primaria / Primary cartridge			Note / Notes	L'altezza non include la guarnizione Height not include gasket	
	Note / Notes	L'altezza non include la guarnizione Height not include gasket			Note / Notes	L'altezza non include la guarnizione Height not include gasket	
Cartuccia di sicurezza abbinata / Matched security cartridge							
8001471500							

Codice / Code	8001473500	mm	inch	Codice / Code	8001473800	mm	inch	
	Altezza / Height	200	7,87		Altezza / Height	96	3,78	
	Diametro esterno Outer diameter	183	7,20		Diametro esterno Outer diameter	164	6,46	
	Diametro interno Internal diameter	120	4,72		Diametro interno Internal diameter	86	3,39	
	Diametro foro borchia Stud hole diameter	9,5	0,37		Diametro foro borchia Stud hole diameter	9	0,35	
	Tipo mezzo filtrante Filter media type	Cellulosa / Cellulose			Tipo mezzo filtrante Filter media type	Elemento filtrante metallico Metallic filter element		
	Stile / Style	Rotondo a tenuta assiale Round axial seal			Stile / Style	Rotondo a tenuta assiale Round axial seal		
Note / Notes	-		Note / Notes	L'altezza non include la guarnizione Height not include gasket				
Codice / Code	8001475800	mm	inch	Codice / Code	8001478700	mm	inch	
	Altezza / Height	188	7,40		Altezza / Height	175	6,89	
	Diametro esterno Outer diameter	85	3,35		Diametro esterno sup. Upper outer diameter	92,5	3,64	
	Diametro interno Internal diameter	74	2,91		Diametro esterno inf. Lower outer diameter	70	2,76	
	Diametro foro borchia Stud hole diameter	10,2	0,40		Diametro interno Internal diameter	62	2,44	
	Tipo mezzo filtrante Filter media type	Tessuto poliestere / Polyester Fiber			Diametro foro borchia Stud hole diameter	17	0,67	
	Stile / Style	Rotondo a tenuta assiale Round axial seal			Tipo mezzo filtrante Filter media type	Tessuto poliestere / Polyester Fiber		
Cartuccia primaria abbinata Matched primary cartridge			Stile / Style	Rotondo a tenuta assiale Round axial seal				
8001209100			Tipo / Type	Cartuccia di sicurezza / Security cartridge				
Note / Notes	L'altezza non include la guarnizione Height not include gasket		Note / Notes	L'altezza non include la guarnizione Height not include gasket				
Codice / Code	8001482700	mm	inch	Codice / Code	8001482900	mm	inch	
	Altezza / Height	253	9,96		Altezza / Height	303	11,93	
	Diametro esterno Outer diameter	104	4,09		Diametro esterno sup. Upper outer diameter	106	4,17	
	Diametro interno Internal diameter	63	2,48		Diametro esterno inf. Lower outer diameter	85	3,35	
	Diametro foro borchia Stud hole diameter	18	0,71		Diametro interno Internal diameter	74	2,91	
	Tipo mezzo filtrante Filter media type	Cellulosa / Cellulose			Diametro foro borchia Stud hole diameter	17	0,67	
	Stile / Style	Rotondo a tenuta assiale Round axial seal			Tipo mezzo filtrante Filter media type	Tessuto poliestere / Polyester Fiber		
Tipo / Type	Cartuccia primaria / Primary cartridge		Stile / Style	Rotondo a tenuta assiale Round axial seal				
Note / Notes	L'altezza non include la guarnizione Height not include gasket		Tipo / Type	Cartuccia di sicurezza / Security cartridge				
Note / Notes	L'altezza non include la guarnizione Height not include gasket		Note / Notes	L'altezza non include la guarnizione Height not include gasket				
Codice / Code	8001483000	mm	inch	Codice / Code	8001483500	mm	inch	
	Altezza / Height	382	15,04		Altezza / Height	341	13,43	
	Diametro esterno sup. Upper outer diameter	214	8,43		Diametro esterno sup. Upper outer diameter	214	8,43	
	Diametro esterno inf. Lower outer diameter	198	7,80		Diametro esterno inf. Lower outer diameter	159	6,26	
	Diametro interno Internal diameter	88	3,46		Diametro interno Internal diameter	88	3,46	
	Diametro foro borchia Stud hole diameter	7/16 UNF - 20	7/16 UNF - 20		Diametro foro borchia Stud hole diameter	7/16 UNF - 20	7/16 UNF - 20	
	Tipo mezzo filtrante Filter media type	Cellulosa / Cellulose			Tipo mezzo filtrante Filter media type	Cellulosa / Cellulose		
Cartuccia di sicurezza abbinata / Matched security cartridge			Stile / Style	Rotondo a tenuta assiale con alette Round axial seal with fins				
8001131600			Tipo / Type	Cartuccia primaria / Primary cartridge				
Note / Notes	L'altezza non include la guarnizione Height not include gasket		Note / Notes	L'altezza non include la guarnizione Height not include gasket				
Codice / Code	8001484400	mm	inch					
	Altezza / Height	306	12,05		Altezza / Height	306	12,05	
	Diametro esterno sup. Upper outer diameter	78	3,07		Diametro esterno sup. Upper outer diameter	78	3,07	
	Diametro esterno inf. Lower outer diameter	82	3,23		Diametro esterno inf. Lower outer diameter	82	3,23	
	Diametro interno Internal diameter	63	2,48		Diametro interno Internal diameter	63	2,48	
	Tipo mezzo filtrante Filter media type	Tessuto poliestere / Polyester Fiber			Tipo mezzo filtrante Filter media type	Tessuto poliestere / Polyester Fiber		
	Stile / Style	Rotondo a tenuta radiale Round radial seal			Stile / Style	Rotondo a tenuta radiale Round radial seal		
Tipo / Type	Cartuccia di sicurezza / Security cartridge		Tipo / Type	Cartuccia di sicurezza / Security cartridge				
Note / Notes	L'altezza non include la guarnizione Height not include gasket		Note / Notes	L'altezza non include la guarnizione Height not include gasket				
Note / Notes	L'altezza non include la guarnizione Height not include gasket		Note / Notes	L'altezza non include la guarnizione Height not include gasket				

Codice / Code	8001486500	mm	inch
	Altezza / Height	322	12,68
	Diametro esterno Outer diameter	142	68,58
	Diametro interno Internal diameter	82	3,23
	Tipo mezzo filtrante Filter media type	Cellulosa / Cellulose	
	Stile / Style	Rotondo a tenuta radiale Round radial seal	

Cartuccia di sicurezza
abbinata / Matched security
cartridge

8001484400

Tipo / Type Cartuccia primaria / Primary cartridge

Codice / Code	8001488800	mm	inch
	Altezza / Height	523	20,59
	Diametro esterno Outer diameter	280	11,02
	Diametro interno Internal diameter	146,5	5,77
	Tipo mezzo filtrante Filter media type	Cellulosa / Cellulose	
	Stile / Style	Rotondo a tenuta radiale Round radial seal	

Cartuccia di sicurezza
abbinata / Matched security
cartridge

8001629000

Tipo / Type Cartuccia primaria / Primary cartridge

Codice / Code	8001489600	mm	inch
	Altezza / Height	445	17,52
	Diametro esterno Outer diameter	303	11,93
	Diametro interno Internal diameter	168,5	6,63
	Tipo mezzo filtrante Filter media type	Cellulosa / Cellulose	
	Stile / Style	Rotondo a tenuta radiale Round radial seal	
Tipo / Type	Cartuccia primaria / Primary cartridge		

Codice / Code	8001490000	mm	inch
	Altezza / Height	483	19,02
	Diametro esterno Outer diameter	303	11,93
	Diametro interno Internal diameter	168,5	6,63
	Tipo mezzo filtrante Filter media type	Cellulosa / Cellulose	
	Stile / Style	Rotondo a tenuta radiale Round radial seal	
Tipo / Type	Cartuccia primaria / Primary cartridge		

Codice / Code	8001490200	mm	inch
	Altezza / Height	526	20,71
	Diametro esterno Outer diameter	303	11,93
	Diametro interno Internal diameter	168,5	6,63
	Diametro foro borchia Stud hole diameter	-	-
	Tipo mezzo filtrante Filter media type	Cellulosa / Cellulose	
	Stile / Style	Rotondo a tenuta radiale Round radial seal	
Tipo / Type	Cartuccia primaria / Primary cartridge		
Note / Notes	-		

Codice / Code	8001492800	mm	inch
	Altezza / Height	202	7,95
	Diametro esterno Outer diameter	164	6,46
	Diametro interno Internal diameter	86	3,39
	Diametro foro borchia Stud hole diameter	9	0,35
	Tipo mezzo filtrante Filter media type	Elemento filtrante metallico Metallic filter element	
	Stile / Style	Rotondo a tenuta assiale Round axial seal	
Tipo / Type	-		
Note / Notes	L'altezza non include la guarnizione Height not include gasket		

Codice / Code	8001495000	mm	inch
	Altezza / Height	76	2,99
	Diametro esterno Outer diameter	160	6,30
	Diametro interno Internal diameter	120	4,72
	Diametro foro borchia Stud hole diameter	-	-
	Tipo mezzo filtrante Filter media type	Cellulosa / Cellulose	
	Stile / Style	Rotondo a tenuta assiale Round axial seal	
Tipo / Type	-		
Note / Notes	-		









Codice / Code	8001495500	mm	inch
	Altezza / Height	788	31,02
	Diametro esterno Outer diameter	324	12,76
	Diametro interno Internal diameter	214	8,43
	Diametro foro borchia Stud hole diameter	13	0,51
	Tipo mezzo filtrante Filter media type	Cellulosa / Cellulose	
	Stile / Style	Rotondo a tenuta assiale Round axial seal	
Tipo / Type	Cartuccia primaria / Primary cartridge		
Note / Notes	L'altezza non include la guarnizione Height not include gasket		

Codice / Code	8001498000	mm	inch
	Altezza / Height	209	8,23
	Diametro esterno sup. Upper outer diameter	60,7	2,39
	Diametro esterno inf. Lower outer diameter	115,5	4,55
	Diametro interno Internal diameter	48,5	1,91
	Diametro foro borchia Stud hole diameter	17	0,67
	Tipo mezzo filtrante Filter media type	Tessuto poliestere / Polyester Fiber	
	Stile / Style	Rotondo a tenuta assiale Round axial seal	
Tipo / Type	Cartuccia di sicurezza / Security cartridge		
Note / Notes	L'altezza non include la guarnizione Height not include gasket		

Cartuccia primaria abbinata
Matched primary cartridge

8001222200



Codice / Code	8001500500	mm	inch
	Altezza / Height	101	3,98
	Diametro esterno Outer diameter	203	7,99
	Diametro interno Internal diameter	98	3,86
	Diametro foro borchia Stud hole diameter	-	-
	Tipo mezzo filtrante Filter media type	Cellulosa / Cellulose	
	Stile / Style	Rotondo a tenuta assiale Round axial seal	
	Tipo / Type	-	
Note / Notes	-		

Codice / Code	8001507800	mm	inch	Codice / Code	8001514500	mm	inch
	Altezza / Height	355	13,98		Altezza / Height	179	7,05
	Diametro esterno Outer diameter	104	4,09		Diametro esterno Outer diameter	89	3,50
	Diametro interno Internal diameter	63	2,48		Diametro interno Internal diameter	41	1,61
	Diametro foro borchia Stud hole diameter	18	0,71		Diametro foro borchia Stud hole diameter		0,00
	Tipo mezzo filtrante Filter media type	Cellulosa / Cellulose			Tipo mezzo filtrante Filter media type	Cellulosa / Cellulose	
	Stile / Style	Rotondo a tenuta assiale Round axial seal			Stile / Style	Rotondo a tenuta radiale Round radial seal	
	Tipo / Type	Cartuccia primaria / Primary cartridge			Tipo / Type	Cartuccia primaria / Primary cartridge	
Note / Notes	L'altezza non include la guarnizione Height not include gasket		Note / Notes	-			
Codice / Code	8001516600	mm	inch	Codice / Code	8001517000	mm	inch
	Altezza / Height	332	13,07		Altezza / Height	173	6,81
	Diametro esterno Outer diameter	164	6,46		Diametro esterno Outer diameter	45	1,77
	Diametro interno Internal diameter	86	3,39		Diametro interno Internal diameter	35	1,38
	Diametro foro borchia Stud hole diameter	9	0,35		Diametro foro borchia Stud hole diameter	-	-
	Tipo mezzo filtrante Filter media type	Elemento filtrante metallico Metallic filter element			Tipo mezzo filtrante Filter media type	Tessuto poliestere / Polyester Fiber	
	Stile / Style	Rotondo a tenuta assiale Round axial seal			Stile / Style	Rotondo a tenuta radiale Round radial seal	
	Tipo / Type	-			Tipo / Type	Cartuccia di sicurezza / Security cartridge	
Note / Notes	L'altezza non include la guarnizione Height not include gasket		Note / Notes	-			
				Cartuccia primaria abbinata Matched primary cartridge			
				8001441200			
Codice / Code	8001518000	mm	inch	Codice / Code	8001519600	mm	inch
	Altezza / Height	508	20,00		Altezza / Height	355	13,98
	Diametro esterno Outer diameter	282	11,10		Diametro esterno Outer diameter	104	4,09
	Diametro interno Internal diameter	171	6,73		Diametro interno Internal diameter	63	2,48
	Diametro foro borchia Stud hole diameter	17	0,67		Diametro foro borchia Stud hole diameter	18	0,71
	Tipo mezzo filtrante Filter media type	Cellulosa / Cellulose			Tipo mezzo filtrante Filter media type	Elemento filtrante metallico Metallic filter element	
	Stile / Style	Rotondo a tenuta assiale Round axial seal			Stile / Style	Rotondo a tenuta assiale Round axial seal	
	Tipo / Type	Cartuccia primaria / Primary cartridge			Tipo / Type	-	
Note / Notes	L'altezza non include la guarnizione Height not include gasket		Note / Notes	L'altezza non include la guarnizione Height not include gasket			
Codice / Code	8001524700	mm	inch	Codice / Code	8001525500	mm	inch
	Altezza / Height	325	12,80		Altezza / Height	158	6,22
	Diametro esterno Outer diameter	150	5,91		Diametro esterno sup. Upper outer diameter	51	2,01
	Diametro interno Internal diameter	71	2,80		Diametro esterno inf. Lower outer diameter	55	2,17
	Diametro foro borchia Stud hole diameter	-	-		Diametro interno Internal diameter	40	1,57
	Tipo mezzo filtrante Filter media type	Cellulosa / Cellulose			Diametro foro borchia Stud hole diameter	16,5	0,65
	Stile / Style	Rotondo a tenuta assiale Round axial seal			Tipo mezzo filtrante Filter media type	Tessuto poliestere / Polyester Fiber	
	Tipo / Type	Cartuccia primaria / Primary cartridge			Stile / Style	Rotondo / Round	
Note / Notes	L'altezza non include la guarnizione Height not include gasket		Tipo / Type	Cartuccia di sicurezza / Security cartridge			
				Note / Notes	-		

Codice / Code	8001526700	mm	inch	Codice / Code	8001529400	mm	inch
	Altezza / Height	177	6,97		Altezza / Height	374	14,72
	Diametro esterno Outer diameter	83	3,27		Diametro esterno Outer diameter	282	11,10
	Diametro interno Internal diameter	54	2,13		Diametro interno Internal diameter	171	6,73
	Diametro foro borchia Stud hole diameter	16,5	0,65		Diametro foro borchia Stud hole diameter	17	0,67
	Tipo mezzo filtrante Filter media type	Cellulosa / Cellulose			Tipo mezzo filtrante Filter media type	Cellulosa / Cellulose	
	Stile / Style	Rotondo a tenuta assiale con alette Round axial seal with fins			Stile / Style	Rotondo a tenuta assiale Round axial seal	
	Tipo / Type	Cartuccia primaria / Primary cartridge			Tipo / Type	Cartuccia primaria / Primary cartridge	
	Note / Notes	L'altezza non include la guarnizione Height not include gasket			Note / Notes	L'altezza non include la guarnizione Height not include gasket	









Codice / Code	8001530000	mm	inch	Codice / Code	8001530400	mm	inch
	Altezza / Height	456	17,95		Altezza / Height	385	15,16
	Diametro esterno Outer diameter	308	12,13		Diametro esterno Outer diameter	308	12,13
	Diametro interno Internal diameter	195	7,68		Diametro interno Internal diameter	195	7,68
	Diametro foro borchia Stud hole diameter	17	0,67		Diametro foro borchia Stud hole diameter	17	0,67
	Tipo mezzo filtrante Filter media type	Cellulosa / Cellulose			Tipo mezzo filtrante Filter media type	Cellulosa / Cellulose	
	Stile / Style	Rotondo a tenuta assiale Round axial seal			Stile / Style	Rotondo a tenuta assiale Round axial seal	
	Tipo / Type	Cartuccia primaria / Primary cartridge			Tipo / Type	Cartuccia primaria / Primary cartridge	
	Note / Notes	L'altezza non include la guarnizione Height not include gasket			Note / Notes	L'altezza non include la guarnizione Height not include gasket	

Codice / Code	8001531000	mm	inch	Codice / Code	8001537100	mm	inch
	Altezza / Height	143	5,63		Altezza / Height	418	16,46
	Diametro esterno Outer diameter	120	4,72		Diametro esterno Outer diameter	206	8,11
	Diametro interno Internal diameter	80	3,15		Diametro interno Internal diameter	106,5	4,19
	Diametro foro borchia Stud hole diameter	6,5	0,26		Diametro foro borchia Stud hole diameter	-	-
	Tipo mezzo filtrante Filter media type	Elemento filtrante metallico Metallic filter element			Tipo mezzo filtrante Filter media type	Cellulosa / Cellulose	
	Stile / Style	Rotondo a tenuta assiale Round axial seal			Stile / Style	Rotondo a tenuta radiale Round radial seal	
	Tipo / Type	-			Tipo / Type	Cartuccia primaria / Primary cartridge	
	Note / Notes	L'altezza non include la guarnizione Height not include gasket			Note / Notes	-	

Codice / Code	8001538000	mm	inch	Codice / Code	8001540000	mm	inch
	Altezza / Height	406	15,98		Altezza / Height	278	10,94
	Diametro esterno sup. Upper outer diameter	102	4,02		Diametro esterno Outer diameter	75	2,95
	Diametro esterno inf. Lower outer diameter	106	4,17		Diametro interno Internal diameter	62	2,44
	Diametro interno Internal diameter	87	3,43		Diametro foro borchia Stud hole diameter	11	0,43
	Diametro foro borchia Stud hole diameter	-	-		Tipo mezzo filtrante Filter media type	Tessuto poliestere / Polyester Fiber	
	Tipo mezzo filtrante Filter media type	Tessuto poliestere / Polyester Fiber			Stile / Style	Rotondo a tenuta assiale Round axial seal	
	Stile / Style	Rotondo a tenuta radiale Round radial seal			Tipo / Type	Cartuccia di sicurezza / Security cartridge	
	Note / Notes	-			Note / Notes	L'altezza non include la guarnizione Height not include gasket	

Cartuccia primaria abbinata
Matched primary cartridge

8001537100

Codice / Code	8001541100	mm	inch	Codice / Code	8001544700	mm	inch
	Altezza / Height	203	7,99		Altezza / Height	128	5,04
	Diametro esterno Outer diameter	75	2,95		Diametro esterno Outer diameter	112	4,41
	Diametro interno Internal diameter	62	2,44		Diametro interno Internal diameter	40	1,57
	Diametro foro borchia Stud hole diameter	11	0,43		Diametro foro borchia Stud hole diameter	-	-
	Tipo mezzo filtrante Filter media type	Tessuto poliestere / Polyester Fiber			Tipo mezzo filtrante Filter media type	Cellulosa / Cellulose	
	Stile / Style	Rotondo a tenuta assiale Round axial seal			Stile / Style	-	
	Tipo / Type	Cartuccia di sicurezza / Security cartridge			Tipo / Type	-	
Note / Notes	L'altezza non include la guarnizione Height not include gasket		Note / Notes	-			
Codice / Code	8001547500	mm	inch	Codice / Code	8001551200	mm	inch
	Altezza / Height	282	11,10		Altezza / Height	254	10,00
	Diametro esterno Outer diameter	138	5,43		Diametro esterno sup. Upper outer diameter	104	4,09
	Diametro interno Internal diameter	81,5	3,21		Diametro esterno inf. Lower outer diameter	150	5,91
	Diametro foro borchia Stud hole diameter	-	-		Diametro interno Internal diameter	63	2,48
	Tipo mezzo filtrante Filter media type	Cellulosa / Cellulose			Diametro foro borchia Stud hole diameter	7	0,28
	Stile / Style	Rotondo a tenuta radiale Round radial seal			Tipo mezzo filtrante Filter media type	Cellulosa / Cellulose	
	Tipo / Type	Cartuccia primaria / Primary cartridge			Stile / Style	Rotondo a tenuta assiale Round axial seal	
Note / Notes	-		Tipo / Type	Cartuccia primaria / Primary cartridge			
				Note / Notes	L'altezza non include la guarnizione Height not include gasket		
Codice / Code	8001555700	mm	inch	Codice / Code	8001556500	mm	inch
	Altezza / Height	255	10,04		Altezza / Height	375	14,76
	Diametro esterno sup. Upper outer diameter	77	3,03		Diametro esterno Outer diameter	308	12,13
	Diametro esterno inf. Lower outer diameter	66	2,60		Diametro interno Internal diameter	195	7,68
	Diametro interno Internal diameter	56	2,20		Diametro foro borchia Stud hole diameter	17	0,67
	Diametro foro borchia Stud hole diameter	8,5	0,33		Tipo mezzo filtrante Filter media type	Cellulosa / Cellulose	
	Tipo mezzo filtrante Filter media type	Tessuto poliestere / Polyester Fiber			Stile / Style	Rotondo a tenuta assiale Round axial seal	
	Stile / Style	Rotondo a tenuta assiale Round axial seal			Tipo / Type	Cartuccia primaria / Primary cartridge	
Tipo / Type	Cartuccia di sicurezza / Security cartridge		Note / Notes	L'altezza non include la guarnizione Height not include gasket			
Note / Notes	L'altezza non include la guarnizione Height not include gasket						
Codice / Code	8001560400	mm	inch	Codice / Code	8001561400	mm	inch
	Altezza / Height	368	14,49		Altezza / Height	600	23,62
	Diametro esterno sup. Upper outer diameter	217	8,54		Diametro esterno Outer diameter	327	12,87
	Diametro esterno inf. Lower outer diameter	185	7,28		Diametro interno Internal diameter	216	8,50
	Diametro interno Internal diameter	157	6,18		Diametro foro borchia Stud hole diameter	16	0,63
	Diametro foro borchia Stud hole diameter	17	0,67		Tipo mezzo filtrante Filter media type	Cellulosa / Cellulose	
	Tipo mezzo filtrante Filter media type	Cellulosa / Cellulose			Stile / Style	Rotondo a tenuta assiale Round axial seal	
	Stile / Style	Rotondo a tenuta assiale Round axial seal			Tipo / Type	Cartuccia primaria / Primary cartridge	
Tipo / Type	Cartuccia di sicurezza / Security cartridge		Note / Notes	L'altezza non include la guarnizione Height not include gasket			
Note / Notes	L'altezza non include la guarnizione Height not include gasket						

Cartuccia primaria abbinata
Matched primary cartridge

8001556500

Cartuccia di sicurezza
abbinata
Matched security cartridge

8001560400

Codice / Code	8001563300	mm	inch
	Altezza / Height	77	3,03
	Diametro esterno Outer diameter	76	2,99
	Diametro interno Internal diameter	34	1,34
	Diametro foro borchia Stud hole diameter	-	-
	Tipo mezzo filtrante Filter media type	Cellulosa / Cellulose	
	Stile / Style	Rotondo a tenuta radiale Round radial seal	
Tipo / Type	-		
Note / Notes	-		

Codice / Code	8001567300	mm	inch
	Altezza / Height	610	24,02
	Diametro esterno Outer diameter	308	12,13
	Diametro interno Internal diameter	195	7,68
	Diametro foro borchia Stud hole diameter	17	0,67
	Tipo mezzo filtrante Filter media type	Cellulosa / Cellulose	
	Stile / Style	Rotondo a tenuta assiale Round axial seal	
Tipo / Type	Cartuccia primaria / Primary cartridge		
Note / Notes	L'altezza non include la guarnizione Height not include gasket		

Cartuccia di sicurezza
abbinata
Matched security cartridge
8001568100

Codice / Code	8001568100	mm	inch
	Altezza / Height	600	23,62
	Diametro esterno sup. Upper outer diameter	217	8,54
	Diametro esterno inf. Lower outer diameter	185	7,28
	Diametro interno Internal diameter	157	6,18
	Diametro foro borchia Stud hole diameter	17	0,67
	Tipo mezzo filtrante Filter media type	Cellulosa / Cellulose	
Stile / Style	Rotondo a tenuta assiale Round axial seal		
Tipo / Type	Cartuccia di sicurezza / Security cartridge		
Note / Notes	L'altezza non include la guarnizione Height not include gasket		

Cartuccia primaria abbinata
Matched primary cartridge
8001567300

Codice / Code	8001569600	mm	inch
	Altezza / Height	46	1,81
	Diametro esterno Outer diameter	135	5,31
	Diametro interno Internal diameter	54	2,13
	Diametro foro borchia Stud hole diameter	-	-
	Tipo mezzo filtrante Filter media type	Cellulosa / Cellulose	
	Stile / Style	Rotondo a tenuta assiale Round axial seal	
Tipo / Type	-		
Note / Notes	-		









Codice / Code	8001571100	mm	inch
	Altezza / Height	344	13,54
	Diametro esterno Outer diameter	201	7,91
	Diametro interno Internal diameter	90	3,54
	Diametro foro borchia Stud hole diameter	19	0,75
	Tipo mezzo filtrante Filter media type	Cellulosa / Cellulose	
	Stile / Style	Rotondo a tenuta assiale Round axial seal	
Tipo / Type	Cartuccia primaria / Primary cartridge		
Note / Notes	L'altezza non include la guarnizione Height not include gasket		











Cartuccia di sicurezza
abbinata
Matched security cartridge
8001123900











Codice / Code	9351575100	mm	inch
	Altezza / Height	262	10,31
	Diametro esterno Outer diameter	316	12,44
	Diametro interno Internal diameter	127	5,00
	Diametro foro borchia Stud hole diameter	-	-
	Tipo mezzo filtrante Filter media type	Cellulosa / Cellulose	
	Stile / Style	Rotondo / Round	
Tipo / Type	ViroLite		
Note / Notes	Oliata per applicazioni marine Oiled for marine applications		











Codice / Code	8001576200	mm	inch
	Altezza / Height	455	17,91
	Diametro esterno Outer diameter	307	12,09
	Diametro interno Internal diameter	196	7,72
	Diametro foro borchia Stud hole diameter	17	0,67
	Tipo mezzo filtrante Filter media type	Elemento filtrante metallico Metallic filter element	
	Stile / Style	Rotondo a tenuta assiale Round axial seal	
Note / Notes	L'altezza non include la guarnizione Height not include gasket		









Codice / Code	8001578800	mm	inch
	Altezza / Height	135	5,31
	Diametro esterno Outer diameter	186	7,32
	Diametro interno Internal diameter	133,5	5,26
	Diametro foro borchia Stud hole diameter	-	-
	Tipo mezzo filtrante Filter media type	Cellulosa / Cellulose	
	Stile / Style	Rotondo a tenuta assiale Round axial seal	
Note / Notes	-		









Codice / Code	8001587000	mm	inch	Codice / Code	8001588700	mm	inch
 <p>Cartuccia primaria abbinata Matched primary cartridge 8001363200</p>	Altezza / Height	446	17,56	 <p>Cartuccia di sicurezza abbinata Matched security cartridge 8001610800</p>	Altezza / Height	273	10,75
	Diametro esterno sup. Upper outer diameter	149	5,87		Diametro esterno Outer diameter	105	4,13
	Diametro esterno inf. Lower outer diameter	117	4,61		Diametro interno Internal diameter	62	2,44
	Diametro interno Internal diameter	105,5	4,15		Diametro foro borchia Stud hole diameter	-	-
	Diametro foro borchia Stud hole diameter	17	0,67		Tipo mezzo filtrante Filter media type	Cellulosa / Cellulose	
	Tipo mezzo filtrante Filter media type	Tessuto poliestere / Polyester Fiber			Stile / Style	Rotondo a tenuta radiale Round radial seal	
Stile / Style	Rotondo a tenuta assiale Round axial seal		Tipo / Type	Cartuccia di sicurezza / Security cartridge			
Tipo / Type	Cartuccia di sicurezza / Security cartridge			Tipo / Type	Cartuccia primaria / Primary cartridge		
Codice / Code	8001594900	mm	inch	Codice / Code	8001605000	mm	inch
	Altezza / Height	406	15,98	 <p>Cartuccia di sicurezza abbinata Matched security cartridge 8001605400</p>	Altezza / Height	311	12,24
	Diametro esterno sup. Upper outer diameter	317,5	12,50		Diametro esterno Outer diameter	128	5,04
	Diametro esterno inf. Lower outer diameter	240	9,45		Diametro interno Internal diameter	84	3,31
	Diametro interno Internal diameter	153	6,02		Diametro foro borchia Stud hole diameter	-	-
	Diametro foro borchia Stud hole diameter	7/16 UNF - 20	7/16 UNF - 20		Tipo mezzo filtrante Filter media type	Cellulosa / Cellulose	
	Tipo mezzo filtrante Filter media type	Cellulosa / Cellulose			Stile / Style	Rotondo a tenuta radiale Round radial seal	
Stile / Style	Rotondo a tenuta assiale Round axial seal		Tipo / Type	Cartuccia primaria / Primary cartridge			
Tipo / Type	Cartuccia primaria / Primary cartridge		Note / Notes	L'altezza non include la guarnizione Height not include gasket			
Note / Notes	L'altezza non include la guarnizione Height not include gasket			Note / Notes	-		
Codice / Code	8001605400	mm	inch	Codice / Code	9351609700	mm	inch
 <p>Cartuccia primaria abbinata Matched primary cartridge 8001605000</p>	Altezza / Height	299	11,77		Altezza / Height	165	6,50
	Diametro esterno sup. Upper outer diameter	78	3,07		Diametro esterno Outer diameter	160	6,30
	Diametro esterno inf. Lower outer diameter	82	3,23		Diametro interno Internal diameter	77	3,03
	Diametro interno Internal diameter	63	2,48		Tipo mezzo filtrante Filter media type	Cellulosa / Cellulose	
	Tipo mezzo filtrante Filter media type	Tessuto poliestere / Polyester Fiber			Stile / Style	Rotondo / Round	
	Stile / Style	Rotondo a tenuta radiale Round radial seal			Tipo / Type	ViroLite	
Tipo / Type	Cartuccia di sicurezza / Security cartridge						
Codice / Code	8001610800	mm	inch	Codice / Code	9351614100	mm	inch
 <p>Cartuccia primaria abbinata Matched primary cartridge 8001588700</p>	Altezza / Height	260	10,24		Altezza / Height	300	11,81
	Diametro esterno sup. Upper outer diameter	56	2,20		Diametro esterno Outer diameter	266	10,47
	Diametro esterno inf. Lower outer diameter	59	2,32		Diametro interno Internal diameter	101	3,98
	Diametro interno Internal diameter	41	1,61		Tipo mezzo filtrante Filter media type	Cellulosa / Cellulose	
	Tipo mezzo filtrante Filter media type	Tessuto poliestere / Polyester Fiber			Stile / Style	Rotondo / Round	
	Stile / Style	Rotondo a tenuta radiale Round radial seal			Tipo / Type	ViroLite	
Tipo / Type	Cartuccia di sicurezza / Security cartridge						



Codice / Code	8001628400	mm	inch	Codice / Code	8001629000	mm	inch		
 PHOTO NOT AVAILABLE	Altezza / Height	169	6,65		Altezza / Height	500	19,68		
	Diametro esterno Outer diameter	83	3,27		Diametro esterno sup. Upper outer diameter	142,5	5,61		
	Diametro interno sup. Upper internal diameter	46	1,81		Diametro esterno inf. Lower outer diameter	149,5	5,89		
	Diametro interno inf. Lower internal diameter	46	1,81		Diametro interno Internal diameter	109	4,29		
Tipo mezzo filtrante Filter media type	Cellulosa / Cellulose		Cartuccia primaria abbinata Matched primary cartridge	Tipo mezzo filtrante Filter media type	Cellulosa / Cellulose		Stile / Style	Rotondo a tenuta radiale Round radial seal	
Stile / Style	Rotondo a tenuta assiale Round axial seal		8001488800	Tipo / Type	Cartuccia di sicurezza / Security cartridge		Stile / Style	Rotondo a tenuta radiale Round radial seal	
Tipo / Type	-			Tipo / Type	-				
Codice / Code	8001629400	mm	inch	Codice / Code	8001630100	mm	inch		
	Altezza / Height	522	20,55		Altezza / Height	508	20,00		
	Diametro esterno Outer diameter	312	12,28		Diametro esterno sup. Upper outer diameter	173	6,81		
	Diametro interno Internal diameter	178	7,01		Diametro esterno inf. Lower outer diameter	178	7,01		
	Tipo mezzo filtrante Filter media type	Cellulosa / Cellulose			Diametro interno Internal diameter	146	5,75		
Stile / Style	Rotondo a tenuta radiale Round radial seal		Cartuccia primaria abbinata Matched primary cartridge	Tipo mezzo filtrante Filter media type	Cellulosa / Cellulose		Stile / Style	Rotondo a tenuta radiale Round radial seal	
Tipo / Type	Cartuccia primaria / Primary cartridge		8001629400	Tipo / Type	Cartuccia di sicurezza / Security cartridge				
Cartuccia di sicurezza abbinata Matched security cartridge	8001630100								
Codice / Code	8001637800	mm	inch	Codice / Code	8001638400	mm	inch		
	Altezza / Height	95	3,74		Altezza / Height	102	4,02		
	Diametro esterno Outer diameter	183	7,20		Diametro esterno Outer diameter	101	3,98		
	Diametro interno Internal diameter	107	4,21		Diametro interno Internal diameter	67	2,64		
	Diametro foro borchia Stud hole diameter	M6	M6		Diametro foro borchia Stud hole diameter	-	-		
Tipo mezzo filtrante Filter media type	Cellulosa / Cellulose		Stile / Style	Rotondo a tenuta radiale Round radial seal		Tipo mezzo filtrante Filter media type	Cellulosa / Cellulose		
Stile / Style	Rotondo a tenuta assiale Round axial seal		Tipo / Type	-		Stile / Style	Rotondo a tenuta radiale Round radial seal		
Tipo / Type	-					Tipo / Type	-		
Codice / Code	8001641800	mm	inch	Codice / Code	8001641900	mm	inch		
	Altezza / Height	494	19,45		Altezza / Height	475	18,70		
	Diametro esterno Outer diameter	240	9,45		Diametro esterno sup. Upper outer diameter	119	4,69		
	Diametro interno Internal diameter	123	4,84		Diametro esterno inf. Lower outer diameter	123,5	4,86		
	Diametro foro borchia Stud hole diameter	-	-		Diametro interno Internal diameter	108	4,25		
Tipo mezzo filtrante Filter media type	Cellulosa / Cellulose		Cartuccia primaria abbinata Matched primary cartridge	Diametro foro borchia Stud hole diameter	-	-	Tipo mezzo filtrante Filter media type	Tessuto poliestere / Polyester Fiber	
Stile / Style	Rotondo a tenuta radiale Round radial seal		8001641800	Stile / Style	Rotondo a tenuta radiale Round radial seal		Stile / Style	Rotondo a tenuta radiale Round radial seal	
Tipo / Type	Cartuccia primaria / Primary cartridge			Tipo / Type	Cartuccia di sicurezza / Security cartridge		Tipo / Type	Cartuccia di sicurezza / Security cartridge	
Cartuccia di sicurezza abbinata Matched security cartridge	8001641900								
Codice / Code	8001648700	mm	inch	Codice / Code	8001648800	mm	inch		
	Altezza / Height	327	12,87		Altezza / Height	284	11,18		
	Diametro esterno sup. Upper outer diameter	80	3,15		Diametro esterno sup. Upper outer diameter	69,5	2,74		
	Diametro esterno inf. Lower outer diameter	68	2,68		Diametro esterno inf. Lower outer diameter	61,5	2,42		
	Diametro interno Internal diameter	66	2,60		Diametro interno Internal diameter	56,5	2,22		
Diametro foro borchia Stud hole diameter	17	0,67	Diametro foro borchia Stud hole diameter	17	0,67	Tipo mezzo filtrante Filter media type	Tessuto poliestere / Polyester Fiber		
Tipo mezzo filtrante Filter media type	Tessuto poliestere / Polyester Fiber		Stile / Style	Rotondo a tenuta assiale Round axial seal		Stile / Style	Rotondo a tenuta assiale Round axial seal		
Stile / Style	Rotondo a tenuta assiale Round axial seal		Tipo / Type	Cartuccia di sicurezza / Security cartridge		Tipo / Type	Cartuccia di sicurezza / Security cartridge		
Tipo / Type	Cartuccia di sicurezza / Security cartridge								

Codice / Code	8001648900	mm	inch	Codice / Code	8001649000	mm	inch
	Altezza / Height	320	12,60		Altezza / Height	360	14,17
	Diametro esterno Outer diameter	125	4,92		Diametro esterno Outer diameter	149	5,87
	Diametro interno Internal diameter	74	2,91		Diametro interno Internal diameter	84	3,31
	Tipo mezzo filtrante Filter media type	Cellulosa / Cellulose			Tipo mezzo filtrante Filter media type	Cellulosa / Cellulose	
	Stile / Style	Rotondo a tenuta radiale Round radial seal			Stile / Style	Rotondo a tenuta radiale Round radial seal	
Cartuccia di sicurezza abbinata Matched security cartridge	Tipo / Type	Cartuccia primaria / Primary cartridge		Cartuccia di sicurezza abbinata Matched security cartridge	Tipo / Type	Cartuccia primaria / Primary cartridge	
8001649300				8001649400			
Codice / Code	8001649100	mm	inch	Codice / Code	8001649200	mm	inch
	Altezza / Height	375	14,76		Altezza / Height	400	15,75
	Diametro esterno Outer diameter	159	6,26		Diametro esterno Outer diameter	194	7,64
	Diametro interno Internal diameter	94	3,70		Diametro interno Internal diameter	114	4,49
	Tipo mezzo filtrante Filter media type	Cellulosa / Cellulose			Tipo mezzo filtrante Filter media type	Cellulosa / Cellulose	
	Stile / Style	Rotondo a tenuta radiale Round radial seal			Stile / Style	Rotondo a tenuta radiale Round radial seal	
Cartuccia di sicurezza abbinata Matched security cartridge	Tipo / Type	Cartuccia primaria / Primary cartridge		Cartuccia di sicurezza abbinata Matched security cartridge	Tipo / Type	Cartuccia primaria / Primary cartridge	
8001649500				8001649600			
Codice / Code	8001649300	mm	inch	Codice / Code	8001649400	mm	inch
	Altezza / Height	305	12,01		Altezza / Height	345	13,58
	Diametro esterno sup. Upper outer diameter	67	2,64		Diametro esterno sup. Upper outer diameter	76	2,99
	Diametro esterno inf. Lower outer diameter	65	2,56		Diametro esterno inf. Lower outer diameter	74	2,91
	Diametro interno Internal diameter	-	-		Diametro interno Internal diameter	-	-
	Tipo mezzo filtrante Filter media type	Tessuto poliestere / Polyester Fiber			Tipo mezzo filtrante Filter media type	Tessuto poliestere / Polyester Fiber	
Cartuccia primaria abbinata Matched primary cartridge	Stile / Style	Rotondo a tenuta radiale Round radial seal		Cartuccia primaria abbinata Matched primary cartridge	Stile / Style	Rotondo a tenuta radiale Round radial seal	
8001648900	Tipo / Type	Cartuccia di sicurezza / Security cartridge		8001649000	Tipo / Type	Cartuccia di sicurezza / Security cartridge	
Codice / Code	8001649500	mm	inch	Codice / Code	8001649600	mm	inch
	Altezza / Height	360	14,17		Altezza / Height	385	15,16
	Diametro esterno sup. Upper outer diameter	87	3,43		Diametro esterno sup. Upper outer diameter	107	4,21
	Diametro esterno inf. Lower outer diameter	84,5	3,33		Diametro esterno inf. Lower outer diameter	104,5	4,11
	Diametro interno Internal diameter	-	-		Diametro interno Internal diameter	-	-
	Tipo mezzo filtrante Filter media type	Tessuto poliestere / Polyester Fiber			Tipo mezzo filtrante Filter media type	Tessuto poliestere / Polyester Fiber	
Cartuccia primaria abbinata Matched primary cartridge	Stile / Style	Rotondo a tenuta radiale Round radial seal		Cartuccia primaria abbinata Matched primary cartridge	Stile / Style	Rotondo a tenuta radiale Round radial seal	
8001649100	Tipo / Type	Cartuccia di sicurezza / Security cartridge		8001649200	Tipo / Type	Cartuccia di sicurezza / Security cartridge	
Codice / Code	8001652100	mm	inch	Codice / Code	8001652200	mm	inch
	Altezza / Height	582	22,91		Altezza / Height	564	22,20
	Diametro esterno Outer diameter	312	12,28		Diametro esterno sup. Upper outer diameter	173	6,81
	Diametro interno Internal diameter	178	7,01		Diametro esterno inf. Lower outer diameter	178	7,01
	Tipo mezzo filtrante Filter media type	Cellulosa / Cellulose			Diametro interno Internal diameter	146	5,75
	Stile / Style	Rotondo a tenuta radiale Round radial seal			Tipo mezzo filtrante Filter media type	Cellulosa / Cellulose	
Cartuccia di sicurezza abbinata Matched security cartridge	Stile / Style	Rotondo a tenuta radiale Round radial seal		Cartuccia primaria abbinata Matched primary cartridge	Stile / Style	Rotondo a tenuta radiale Round radial seal	
8001652200	Tipo / Type	Cartuccia primaria / Primary cartridge		8001652100	Tipo / Type	Cartuccia di sicurezza / Security cartridge	

Codice / Code	8001652300	mm	inch	Codice / Code	8001653300	mm	inch
	Altezza / Height	461	18,15		Altezza / Height	640	25,20
	Diametro esterno Outer diameter	312	12,28		Diametro esterno Outer diameter	282	11,10
	Diametro interno Internal diameter	178	7,01		Diametro interno Internal diameter	171	6,73
	Diametro foro borchia Stud hole diameter	-	-		Diametro foro borchia Stud hole diameter	17	0,67
	Tipo mezzo filtrante Filter media type	Cellulosa / Cellulose			Tipo mezzo filtrante Filter media type	Cellulosa / Cellulose	
	Stile / Style	Rotondo a tenuta radiale Round radial seal			Stile / Style	Rotondo a tenuta assiale Round axial seal	
	Tipo / Type	Cartuccia primaria / Primary cartridge			Tipo / Type	Cartuccia primaria / Primary cartridge	
Note / Notes	-		Note / Notes	L'altezza non include la guarnizione Height not include gasket			
Codice / Code	9351655000	mm	inch	Codice / Code	9351656000	mm	inch
	Altezza / Height	314	12,36		Altezza / Height	314	12,36
	Diametro esterno Outer diameter	217	8,54		Diametro esterno Outer diameter	217	8,54
	Diametro interno Internal diameter	76	2,99		Diametro interno Internal diameter	101	3,98
	Tipo mezzo filtrante Filter media type	Cellulosa / Cellulose			Tipo mezzo filtrante Filter media type	Cellulosa / Cellulose	
	Stile / Style	Rotondo / Round			Stile / Style	Rotondo / Round	
	Tipo / Type	ViroLite			Tipo / Type	ViroLite	
Codice / Code	9351659700	mm	inch	Codice / Code	8001668900	mm	inch
	Altezza / Height	262	10,31		Altezza / Height	523	20,59
	Diametro esterno Outer diameter	316	12,44		Diametro esterno Outer diameter	280	11,02
	Diametro interno Internal diameter	127	5,00		Diametro interno Internal diameter	146,5	5,77
	Tipo mezzo filtrante Filter media type	Cellulosa / Cellulose			Tipo mezzo filtrante Filter media type	Cellulosa / Cellulose	
	Stile / Style	Rotondo / Round			Stile / Style	Rotondo a tenuta radiale Round radial seal	
Tipo / Type	ViroLite		Tipo / Type	Cartuccia primaria / Primary cartridge			
Codice / Code	8001672900	mm	inch	Codice / Code	8001673100	mm	inch
	Altezza / Height	387	15,24		Altezza / Height	380	14,96
	Diametro esterno Outer diameter	185	7,28		Diametro esterno sup. Upper outer diameter	101	3,98
	Diametro interno Internal diameter	106	4,17		Diametro esterno inf. Lower outer diameter	107	4,21
	Tipo mezzo filtrante Filter media type	Cellulosa / Cellulose			Diametro interno Internal diameter	87,5	3,44
Cartuccia di sicurezza abbinata Matched security cartridge	Stile / Style	Rotondo a tenuta radiale Round radial seal		Tipo mezzo filtrante Filter media type	Tessuto poliestere / Polyester Fiber		
8001673100	Tipo / Type	Cartuccia primaria / Primary cartridge		Stile / Style	Rotondo a tenuta radiale Round radial seal		
				8001672900	Tipo / Type	Cartuccia di sicurezza / Security cartridge	
Codice / Code	8001682400	mm	inch	Codice / Code	9351685900	mm	inch
	Altezza / Height	94	3,70		Altezza / Height	314	12,36
	Diametro esterno Outer diameter	77	3,03		Diametro esterno Outer diameter	217	8,54
	Diametro interno Internal diameter	23	0,91		Diametro interno Internal diameter	76	2,99
	Tipo mezzo filtrante Filter media type	Elemento filtrante metallico Metallic filter element			Tipo mezzo filtrante Filter media type	Cellulosa / Cellulose	
	Stile / Style	Rotondo / Round			Stile / Style	Rotondo / Round	
	Tipo / Type	Cartuccia per macchina resinatrice Cartridge for resin machine			Tipo / Type	ViroLite	
Note / Notes	-		Note / Notes	Oliata per applicazioni marine Oiled for marine applications			



Codice / Code	9351686200	mm	inch	Codice / Code	9351686400	mm	inch
	Altezza / Height	314	12,36		Altezza / Height	300	11,81
	Diametro esterno Outer diameter	217	8,54		Diametro esterno Outer diameter	266	10,47
	Diametro interno Internal diameter	101	3,98		Diametro interno Internal diameter	101	3,98
	Tipo mezzo filtrante Filter media type	Cellulosa / Cellulose			Tipo mezzo filtrante Filter media type	Cellulosa / Cellulose	
	Stile / Style	Rotondo / Round			Stile / Style	Rotondo / Round	
	Tipo / Type	ViroLite			Tipo / Type	ViroLite	
	Note / Notes	Oliata per applicazioni marine Oiled for marine applications			Note / Notes	Oliata per applicazioni marine Oiled for marine applications	
Codice / Code	8001687200	mm	inch	Codice / Code	8001687300	mm	inch
	Altezza / Height	243	9,57		Altezza / Height	497	19,57
	Diametro esterno Outer diameter	62	2,44		Diametro esterno sup. Upper outer diameter	242	9,53
	Diametro interno Internal diameter	52	2,05		Diametro esterno inf. Lower outer diameter	309	12,17
	Diametro foro borchia Stud hole diameter	11	0,43		Diametro interno Internal diameter	132	5,20
	Tipo mezzo filtrante Filter media type	Tessuto poliestere / Polyester Fiber			Diametro foro borchia Stud hole diameter	10,5	0,41
	Stile / Style	Rotondo a tenuta assiale Round axial seal			Tipo mezzo filtrante Filter media type	Cellulosa / Cellulose	
	Tipo / Type	Cartuccia di sicurezza / Security cartridge			Stile / Style	Rotondo a tenuta assiale Round axial seal	
	Note / Notes	-			Tipo / Type	Cartuccia primaria / Primary cartridge	
					Note / Notes	L'altezza non include la guarnizione Height not include gasket	
Cartuccia primaria abbinata Matched primary cartridge 8001271600							
Codice / Code	8001687400	mm	inch	Codice / Code	8001687500	mm	inch
	Altezza / Height	220	8,66		Altezza / Height	387	15,24
	Diametro esterno Outer diameter	334	13,15		Diametro esterno sup. Upper outer diameter	117	4,61
	Diametro interno Internal diameter	205	8,07		Diametro esterno inf. Lower outer diameter	114,5	4,51
	Tipo mezzo filtrante Filter media type	Cellulosa / Cellulose			Diametro interno Internal diameter	-	-
	Stile / Style	Rotondo a tenuta assiale Round axial seal			Tipo mezzo filtrante Filter media type	Tessuto poliestere / Polyester Fiber	
	Tipo / Type	-			Stile / Style	Rotondo a tenuta radiale Round radial seal	
	Note / Notes	L'altezza non include la guarnizione Height not include gasket			Tipo / Type	Cartuccia di sicurezza / Security cartridge	
					Note / Notes	-	
				Cartuccia primaria abbinata Matched primary cartridge 8001688100			
Codice / Code	8001687600	mm	inch	Codice / Code	8001687700	mm	inch
	Altezza / Height	325	12,80		Altezza / Height	238	9,37
	Diametro esterno sup. Upper outer diameter	90	3,54		Diametro esterno sup. Upper outer diameter	57	2,24
	Diametro esterno inf. Lower outer diameter	82,5	3,25		Diametro esterno inf. Lower outer diameter	54,5	2,15
	Diametro interno Internal diameter	76	2,99		Diametro interno Internal diameter	-	-
	Diametro foro borchia Stud hole diameter	11	0,43		Diametro foro borchia Stud hole diameter	-	-
	Tipo mezzo filtrante Filter media type	Tessuto poliestere / Polyester Fiber			Tipo mezzo filtrante Filter media type	Tessuto poliestere / Polyester Fiber	
	Stile / Style	Rotondo / Round			Stile / Style	Rotondo a tenuta radiale Round radial seal	
	Tipo / Type	Cartuccia di sicurezza / Security cartridge			Tipo / Type	Cartuccia di sicurezza / Security cartridge	
				Cartuccia primaria abbinata Matched primary cartridge 8001687800			

Codice / Code	8001687800	mm	inch	Codice / Code	8001687900	mm	inch
	Altezza / Height	253	9,96		Altezza / Height	191	7,52
	Diametro esterno Outer diameter	115	4,53		Diametro esterno sup. Upper outer diameter	85	3,35
	Diametro interno Internal diameter	64	2,52		Diametro esterno inf. Lower outer diameter	82,5	3,25
	Diametro foro borchia Stud hole diameter	-	-		Diametro interno Internal diameter	8	0,31
	Tipo mezzo filtrante Filter media type	Cellulosa / Cellulose			Diametro foro borchia Stud hole diameter	0,00	
Cartuccia di sicurezza abbinata Matched security cartridge	Stile / Style	Rotondo a tenuta radiale Round radial seal		Tipo mezzo filtrante Filter media type	Tessuto poliestere / Polyester Fiber		
8001687700	Tipo / Type	Cartuccia primaria / Primary cartridge		Stile / Style	Rotondo / Round		
				Tipo / Type	Cartuccia di sicurezza / Security cartridge		
Codice / Code	8001688000	mm	inch	Codice / Code	8001688100	mm	inch
	Altezza / Height	200	7,87		Altezza / Height	403	15,87
	Diametro esterno sup. Upper outer diameter	80	3,15		Diametro esterno Outer diameter	220	8,66
	Diametro esterno inf. Lower outer diameter	68	2,68		Diametro interno Internal diameter	124	4,88
	Diametro interno Internal diameter	66	2,60		Diametro foro borchia Stud hole diameter	-	-
	Diametro foro borchia Stud hole diameter	9	0,35		Tipo mezzo filtrante Filter media type	Cellulosa / Cellulose	
Tipo mezzo filtrante Filter media type	Tessuto poliestere / Polyester Fiber		Cartuccia di sicurezza abbinata Matched security cartridge	Stile / Style	Rotondo a tenuta radiale Round radial seal		
8001687500	Stile / Style	Rotondo a tenuta assiale Round axial seal		Tipo / Type	Cartuccia di sicurezza / Security cartridge		
	Tipo / Type	Cartuccia di sicurezza / Security cartridge					
Codice / Code	8001688800	mm	inch	Codice / Code	8001692200	mm	inch
	Altezza / Height	72,5	2,85		Altezza / Height	522	20,55
	Diagonale lunga Long diagonal	142	5,59		Diametro esterno Outer diameter	312	12,28
	Diagonale corta Short diagonal	92	3,62		Diametro interno Internal diameter	178	7,01
	Diametro foro borchia Stud hole diameter	8	0,31		Diametro foro borchia Stud hole diameter	-	-
	Tipo mezzo filtrante Filter media type	Cellulosa / Cellulose - Bulpren			Tipo mezzo filtrante Filter media type	Cellulosa / Cellulose	
Stile / Style	Ovale a tenuta assiale Oval axial seal		Stile / Style	Rotondo a tenuta radiale Round radial seal			
Tipo / Type	-		Tipo / Type	Cartuccia primaria / Primary cartridge			
Codice / Code	8001692800	mm	inch	Codice / Code	8001693800	mm	inch
	Altezza / Height	418	16,46		Altezza / Height	568	22,36
	Diametro esterno Outer diameter	206	8,11		Diametro esterno sup. Upper outer diameter	172	6,77
	Diametro interno Internal diameter	106,5	4,19		Diametro esterno inf. Lower outer diameter	148	5,83
	Diametro foro borchia Stud hole diameter	-	-		Diametro interno Internal diameter	138	5,43
	Tipo mezzo filtrante Filter media type	Cellulosa / Cellulose			Diametro foro borchia Stud hole diameter	10	0,39
Cartuccia di sicurezza abbinata Matched security cartridge	Stile / Style	Rotondo a tenuta radiale Round radial seal		Tipo mezzo filtrante Filter media type	Tessuto poliestere / Polyester Fiber		
8001538000	Tipo / Type	Cartuccia primaria / Primary cartridge		Stile / Style	Rotondo a tenuta assiale Round axial seal		
	Note / Notes	-		Tipo / Type	Cartuccia di sicurezza / Security cartridge		
				Note / Notes	L'altezza non include la guarnizione Height not include gasket		

Codice / Code	8001696900	mm	inch	Codice / Code	8001697000	mm	inch
	Altezza / Height	538	21,18		Altezza / Height	522	20,55
	Diametro esterno Outer diameter	240	9,45		Diametro esterno sup. Upper outer diameter	136	5,35
	Diametro interno Internal diameter	144	5,67		Diametro esterno inf. Lower outer diameter	134,5	5,30
	Tipo mezzo filtrante Filter media type	Cellulosa / Cellulose			Diametro interno Internal diameter	-	-
Cartuccia di sicurezza abbinata Matched security cartridge 8001697000	Stile / Style	Rotondo a tenuta radiale Round radial seal		Cartuccia primaria abbinata Matched primary cartridge 8001696900	Stile / Style	Rotondo a tenuta radiale Round radial seal	
	Tipo / Type	Cartuccia primaria / Primary cartridge			Tipo / Type	Cartuccia di sicurezza / Security cartridge	
	Note / Notes	-			Note / Notes	Oliata per applicazioni marine Oiled for marine applications	

Codice / Code	8001697100	mm	inch	Codice / Code	8001697200	mm	inch
	Altezza / Height	588	23,15		Altezza / Height	573	22,56
	Diametro esterno Outer diameter	296	11,65		Diametro esterno sup. Upper outer diameter	195	7,68
	Diametro interno Internal diameter	200	7,87		Diametro esterno inf. Lower outer diameter	193	7,60
	Tipo mezzo filtrante Filter media type	Cellulosa / Cellulose			Diametro interno Internal diameter	-	-
Cartuccia di sicurezza abbinata Matched security cartridge 8001697200	Stile / Style	Rotondo a tenuta radiale Round radial seal		Cartuccia primaria abbinata Matched primary cartridge 8001697100	Stile / Style	Rotondo a tenuta radiale Round radial seal	
	Tipo / Type	Cartuccia primaria / Primary cartridge			Tipo / Type	Cartuccia di sicurezza / Security cartridge	

Codice / Code	8001702000	mm	inch	Codice / Code	8001706400	mm	inch
	Altezza / Height	600	23,62		Altezza / Height	280	11,02
	Diametro esterno Outer diameter	324	12,76		Diametro esterno sup. Upper outer diameter	62	2,44
	Diametro interno Internal diameter	214	8,43		Diametro esterno inf. Lower outer diameter	63	2,48
	Tipo mezzo filtrante Filter media type	Tessuto poliestere / Cloth Polyester			Diametro interno Internal diameter	-	-
	Stile / Style	Rotondo a tenuta assiale Round axial seal			Stile / Style	Rotondo a tenuta radiale Round radial seal	
	Tipo / Type	-			Tipo / Type	Cartuccia di sicurezza / Security cartridge	

Codice / Code	8001707000	mm	inch	Codice / Code	8001707500	mm	inch
	Altezza / Height	585	23,03		Altezza / Height	560	22,05
	Diametro esterno Outer diameter	447	17,60		Diametro esterno Outer diameter	303	12,99
	Diametro interno Internal diameter	309	12,17		Diametro interno Internal diameter	261	10,28
	Diametro foro borchia Stud hole diameter	22	0,87		Diametro foro borchia Stud hole diameter	22	0,87
Cartuccia di sicurezza abbinata Matched security cartridge 8001707500	Tipo mezzo filtrante Filter media type	Cellulosa / Cellulose		Tipo mezzo filtrante Filter media type	Cellulosa / Cellulose		
	Stile / Style	Rotondo a tenuta assiale Round axial seal		Stile / Style	Rotondo a tenuta assiale Round axial seal		
	Tipo / Type	Cartuccia primaria / Primary cartridge		Tipo / Type	Cartuccia di sicurezza / Security cartridge		
	Note / Notes	L'altezza non include la guarnizione Height not include gasket		Note / Notes	L'altezza non include la guarnizione Height not include gasket		

Codice / Code	8001709200	mm	inch
	Altezza / Height	272	10,71
	Diametro esterno sup. / Upper outer diameter	150	5,91
	Diametro esterno inf. / Lower outer diameter	119	4,69
	Diametro interno / Internal diameter	97	3,82
	Diametro foro borchia / Stud hole diameter	11,5	0,45
	Tipo mezzo filtrante / Filter media type	Tessuto poliestere / Polyester Fiber	
	Stile / Style	Rotondo a tenuta assiale / Round axial seal	
Tipo / Type	Cartuccia di sicurezza / Security cartridge		

Codice / Code	8001710300	mm	inch
	Altezza / Height	354	13,94
	Diametro esterno sup. / Upper outer diameter	150	5,91
	Diametro esterno inf. / Lower outer diameter	119	4,69
	Diametro interno / Internal diameter	97	3,82
	Diametro foro borchia / Stud hole diameter	11,5	0,45
	Tipo mezzo filtrante / Filter media type	Tessuto poliestere / Polyester Fiber	
	Stile / Style	Rotondo a tenuta assiale / Round axial seal	
Tipo / Type	Cartuccia di sicurezza / Security cartridge		

Codice / Code	9351711100	mm	inch
	Altezza / Height	443	17,44
	Diametro esterno / Outer diameter	316	12,44
	Diametro interno / Internal diameter	200	7,87
	Tipo mezzo filtrante / Filter media type	Cellulosa / Cellulose	
	Stile / Style	Rotondo / Round	
	Tipo / Type	ViroLite	
	Note / Notes	-	

Codice / Code	9351711400	mm	inch
	Altezza / Height	298	11,73
	Diametro esterno / Outer diameter	196	7,72
	Diametro interno / Internal diameter	150	5,91
	Tipo mezzo filtrante / Filter media type	Cellulosa / Cellulose	
	Stile / Style	Rotondo / Round	
	Tipo / Type	ViroLite	
	Note / Notes	Oliata per applicazioni marine / Oiled for marine applications	

Codice / Code	9351716300	mm	inch
	Altezza / Height	261	10,28
	Diametro esterno / Outer diameter	266	10,47
	Diametro interno / Internal diameter	101	3,98
	Diametro foro borchia / Stud hole diameter	-	-
	Tipo mezzo filtrante / Filter media type	Cellulosa / Cellulose	
	Stile / Style	Rotondo / Round	
	Tipo / Type	ViroLite	
Note / Notes	Oliata per applicazioni marine / Oiled for marine applications		











Codice / Code	8001720300	mm	inch
	Altezza / Height	480	18,90
	Diametro esterno / Outer diameter	275,5	10,85
	Diametro interno / Internal diameter	171	6,73
	Diametro foro borchia / Stud hole diameter	11	0,43
	Tipo mezzo filtrante / Filter media type	Cellulosa / Cellulose	
	Stile / Style	Rotondo a tenuta assiale / Round axial seal	
	Tipo / Type	Cartuccia primaria / Primary cartridge	
Note / Notes	L'altezza non include la guarnizione / Height not include gasket		











Codice / Code	8001723000	mm	inch
	Altezza / Height	610	24,02
	Diametro esterno / Outer diameter	374	14,72
	Diametro interno / Internal diameter	263,5	10,37
	Diametro foro borchia / Stud hole diameter	22	0,87
	Tipo mezzo filtrante / Filter media type	Cellulosa / Cellulose	
	Stile / Style	Rotondo a tenuta assiale / Round axial seal	
	Tipo / Type	Cartuccia primaria / Primary cartridge	
Note / Notes	L'altezza non include la guarnizione / Height not include gasket		











Codice / Code	8001723200	mm	inch
	Altezza / Height	559	22,01
	Diametro esterno / Outer diameter	260	10,24
	Diametro interno / Internal diameter	231	9,09
	Diametro foro borchia / Stud hole diameter	22	0,87
	Tipo mezzo filtrante / Filter media type	Cellulosa / Cellulose	
	Stile / Style	Rotondo a tenuta assiale / Round axial seal	
	Tipo / Type	Cartuccia di sicurezza / Security cartridge	
Note / Notes	L'altezza non include la guarnizione / Height not include gasket		









Cartuccia di sicurezza abbinata / Matched security cartridge
8001723200

Cartuccia primaria abbinata / Matched primary cartridge
8001723000

Codice / Code	8001726000	mm	inch	Codice / Code	8001730300	mm	inch
	Altezza / Height	240	9,45		Altezza / Height	530	20,87
	Diametro esterno sup. / Upper outer diameter	92,5	3,64		Diametro esterno / Outer diameter	308	12,13
	Diametro esterno inf. / Lower outer diameter	70	2,76		Diametro interno / Internal diameter	195	7,68
	Diametro interno / Internal diameter	62	2,44		Diametro foro borchia / Stud hole diameter	17	0,67
	Diametro foro borchia / Stud hole diameter	8,5	0,33		Tipo mezzo filtrante / Filter media type	Elemento filtrante metallico / Metallic filter element	
	Tipo mezzo filtrante / Filter media type	Tessuto poliestere / Polyester Fiber			Stile / Style	Rotondo a tenuta assiale / Round axial seal	
	Stile / Style	Rotondo a tenuta assiale / Round axial seal			Tipo / Type	-	
Tipo / Type	Cartuccia di sicurezza / Security cartridge		Note / Notes	L'altezza non include la guarnizione / Height not include gasket			
Note / Notes	L'altezza non include la guarnizione / Height not include gasket						
Codice / Code	9351971100	mm	inch	Codice / Code	9351732900	mm	inch
	Altezza / Height	149	5,87		Altezza / Height	276	10,87
	Diametro esterno / Outer diameter	114	4,49		Diametro esterno / Outer diameter	216	8,50
	Diametro interno / Internal diameter	38	1,50		Diametro interno / Internal diameter	76	2,99
	Tipo mezzo filtrante / Filter media type	Cellulosa / Cellulose			Tipo mezzo filtrante / Filter media type	Cellulosa / Cellulose	
	Stile / Style	Rotondo / Round			Stile / Style	Rotondo / Round	
	Tipo / Type	ViroLite			Tipo / Type	ViroLite	
	Note / Notes	Oliata per applicazioni marine / Oiled for marine applications			Note / Notes	-	
Note / Notes	Oiled for marine applications						
Codice / Code	9351733000	mm	inch	Codice / Code	9351733100	mm	inch
	Altezza / Height	161	6,34		Altezza / Height	199	7,83
	Diametro esterno / Outer diameter	165	6,50		Diametro esterno / Outer diameter	216	8,50
	Diametro interno / Internal diameter	57	2,24		Diametro interno / Internal diameter	64	2,52
	Tipo mezzo filtrante / Filter media type	Cellulosa / Cellulose			Tipo mezzo filtrante / Filter media type	Cellulosa / Cellulose	
	Stile / Style	Rotondo / Round			Stile / Style	Rotondo / Round	
	Tipo / Type	ViroLite			Tipo / Type	ViroLite	
	Note / Notes	-			Note / Notes	-	
Note / Notes	-						
Codice / Code	9351733200	mm	inch	Codice / Code	9351733300	mm	inch
	Altezza / Height	263	10,35		Altezza / Height	136	5,35
	Diametro esterno / Outer diameter	165	6,50		Diametro esterno / Outer diameter	216	8,50
	Diametro interno / Internal diameter	51	2,01		Diametro interno / Internal diameter	64	2,52
	Tipo mezzo filtrante / Filter media type	Cellulosa / Cellulose			Tipo mezzo filtrante / Filter media type	Cellulosa / Cellulose	
	Stile / Style	Rotondo / Round			Stile / Style	Rotondo / Round	
	Tipo / Type	ViroLite			Tipo / Type	ViroLite	
	Note / Notes	Oliata per applicazioni marine / Oiled for marine applications			Note / Notes	-	
Note / Notes	Oiled for marine applications						
Codice / Code	9351733500	mm	inch	Codice / Code	9351733600	mm	inch
	Altezza / Height	300	11,81		Altezza / Height	312	12,28
	Diametro esterno / Outer diameter	267	10,51		Diametro esterno / Outer diameter	317	12,48
	Diametro interno / Internal diameter	102	4,02		Diametro interno / Internal diameter	127	5,00
	Tipo mezzo filtrante / Filter media type	Cellulosa / Cellulose			Tipo mezzo filtrante / Filter media type	Cellulosa / Cellulose	
	Stile / Style	Rotondo / Round			Stile / Style	Rotondo / Round	
	Tipo / Type	ViroLite			Tipo / Type	ViroLite	
	Note / Notes	-			Note / Notes	-	
Note / Notes	-						

Codice / Code	8001736500	mm	inch	Codice / Code	8001736600	mm	inch
	Altezza / Height	347	13,66		Altezza / Height	340	13,39
	Diametro esterno Outer diameter	164	6,46		Diametro esterno sup. Upper outer diameter	88	3,46
	Diametro interno Internal diameter	90	3,54		Diametro esterno inf. Lower outer diameter	92	3,62
	Tipo mezzo filtrante Filter media type	Cellulosa / Cellulose			Diametro interno Internal diameter	73	2,87
	Stile / Style	Rotondo a tenuta radiale Round radial seal			Tipo mezzo filtrante Filter media type	Tessuto poliestere / Polyester Fiber	
Cartuccia di sicurezza abbinata Matched security cartridge 8001736600	Tipo / Type	Cartuccia primaria / Primary cartridge	8001736500	Stile / Style	Rotondo a tenuta radiale Round radial seal		
	Tipo / Type	Cartuccia di sicurezza / Security cartridge			Tipo / Type	Cartuccia di sicurezza / Security cartridge	
Codice / Code	8001737200	mm	inch	Codice / Code	8001740600	mm	inch
	Altezza / Height	72	2,83		Altezza / Height	70	2,76
	Diametro esterno Outer diameter	104	4,09		Diametro esterno Outer diameter	65	2,56
	Diametro interno Internal diameter	63	2,48		Diametro interno Internal diameter	38,5	1,52
	Tipo mezzo filtrante Filter media type	Cellulosa / Cellulose			Tipo mezzo filtrante Filter media type	Cellulosa / Cellulose	
	Stile / Style	Rotondo a tenuta radiale Round radial seal			Stile / Style	Rotondo / Round	
	Tipo / Type	-		Tipo / Type	-		
Codice / Code	8001747000	mm	inch	Codice / Code	8001749000	mm	inch
	Altezza / Height	610	24,02		Altezza / Height	331	13,03
	Diametro esterno sup. Upper outer diameter	209	8,23		Diametro esterno Outer diameter	138	5,43
	Diametro esterno inf. Lower outer diameter	201	7,91		Diametro interno Internal diameter	81	3,19
	Diametro interno Internal diameter	192	7,56		Diametro foro borchia Stud hole diameter	-	-
	Diametro foro borchia Stud hole diameter	17	0,67		Tipo mezzo filtrante Filter media type	Cellulosa / Cellulose	
	Tipo mezzo filtrante Filter media type	Tessuto poliestere / Polyester Fiber			Stile / Style	Rotondo a tenuta radiale Round radial seal	
	Stile / Style	Rotondo a tenuta assiale Round axial seal			Tipo / Type	Cartuccia primaria / Primary cartridge	
	Tipo / Type	Cartuccia di sicurezza / Security cartridge					
Codice / Code	8001751200	mm	inch	Codice / Code	8001753100	mm	inch
	Altezza / Height	104	4,09		Altezza / Height	600	23,62
	Diametro esterno Outer diameter	98	3,86		Diametro esterno Outer diameter	324	12,76
	Diametro interno sup. Upper internal diameter	60	2,36		Diametro interno Internal diameter	214	8,43
	Diametro interno inf. Lower internal diameter	60	2,36		Diametro foro borchia Stud hole diameter	13	0,51
	Tipo mezzo filtrante Filter media type	Cellulosa / Cellulose			Tipo mezzo filtrante Filter media type	Cellulosa / Cellulose	
	Stile / Style	Rotondo / Round			Stile / Style	Rotondo a tenuta assiale Round axial seal	
	Tipo / Type	-		Tipo / Type	Cartuccia primaria / Primary cartridge		
				Note / Notes	L'altezza non include la guarnizione Height not include gasket		
Codice / Code	8001753900	mm	inch	Codice / Code	8001754100	mm	inch
	Altezza / Height	69	2,72		Altezza / Height	79	3,11
	Diametro esterno Outer diameter	60	2,36		Diametro esterno Outer diameter	100	3,94
	Diametro interno Internal diameter	34,5	1,36		Diametro interno Internal diameter	67	2,64
	Tipo mezzo filtrante Filter media type	Cellulosa / Cellulose			Tipo mezzo filtrante Filter media type	Cellulosa / Cellulose	
	Stile / Style	Rotondo a tenuta assiale Round axial seal			Stile / Style	Rotondo a tenuta assiale Round axial seal	
	Tipo / Type	-		Tipo / Type	-		

Codice / Code	8001754200	mm	inch	Codice / Code	8001757500	mm	inch
	Altezza / Height	135	5,31		Altezza / Height	340	13,39
	Diametro esterno Outer diameter	117,5	4,63		Diametro esterno Outer diameter	164	6,46
	Diametro interno Internal diameter	67	2,64		Diametro interno Internal diameter	86	3,39
	Diametro foro borchia Stud hole diameter	-	-		Diametro foro borchia Stud hole diameter	9	0,35
	Tipo mezzo filtrante Filter media type	Cellulosa / Cellulose			Tipo mezzo filtrante Filter media type	Tela poliestere antistatica Antistatic polyester cloth	
	Stile / Style	Rotondo a tenuta assiale Round axial seal			Stile / Style	Rotondo a tenuta assiale Round axial seal	
	Tipo / Type	-			Tipo / Type	Cartuccia primaria / Primary cartridge	
Codice / Code	8001757600	mm	inch	Codice / Code	8001757700	mm	inch
	Altezza / Height	205	8,07		Altezza / Height	400	15,75
	Diametro esterno Outer diameter	164	6,46		Diametro esterno Outer diameter	234	9,21
	Diametro interno Internal diameter	86	3,39		Diametro interno Internal diameter	133	5,24
	Diametro foro borchia Stud hole diameter	9	0,35		Diametro foro borchia Stud hole diameter	16,5	0,65
	Tipo mezzo filtrante Filter media type	Tela poliestere antistatica Antistatic polyester cloth			Tipo mezzo filtrante Filter media type	Tela poliestere antistatica Antistatic polyester cloth	
	Stile / Style	Rotondo a tenuta assiale Round axial seal			Stile / Style	Rotondo a tenuta assiale Round axial seal	
	Tipo / Type	Cartuccia primaria / Primary cartridge			Tipo / Type	Cartuccia primaria / Primary cartridge	
Codice / Code	8001757800	mm	inch	Codice / Code	8001759000	mm	inch
	Altezza / Height	456	17,95		Altezza / Height	177	6,97
	Diametro esterno Outer diameter	308	12,13		Diametro esterno Outer diameter	96	3,78
	Diametro interno Internal diameter	195	7,68		Diametro interno sup. Upper internal diameter	42,5	1,67
	Diametro foro borchia Stud hole diameter	17	0,67		Diametro interno inf. Lower internal diameter	42,5	1,67
	Tipo mezzo filtrante Filter media type	Tela poliestere antistatica Antistatic polyester cloth			Tipo mezzo filtrante Filter media type	Cellulosa / Cellulose	
	Stile / Style	Rotondo a tenuta assiale Round axial seal			Stile / Style	Rotondo a tenuta radiale Round radial seal	
	Tipo / Type	Cartuccia primaria / Primary cartridge			Tipo / Type	-	
Codice / Code	8001759400	mm	inch	Codice / Code	9351760400	mm	inch
	Altezza / Height	521	20,51		Altezza / Height	123	4,84
	Diametro esterno Outer diameter	194	7,64		Diametro esterno Outer diameter	112	4,41
	Diametro interno Internal diameter	153	6,02		Diametro interno Internal diameter	62	2,44
	Diametro foro borchia Stud hole diameter	17,5	0,69		Diametro foro borchia Stud hole diameter	-	-
	Tipo mezzo filtrante Filter media type	Cellulosa / Cellulose			Tipo mezzo filtrante Filter media type	Cellulosa / Cellulose	
	Stile / Style	Rotondo a tenuta assiale Round axial seal			Stile / Style	Rotondo / Round	
	Tipo / Type	Cartuccia primaria / Primary cartridge			Tipo / Type	ViroLite	
	Note / Notes	L'altezza non include la guarnizione Height not include gasket			Note / Notes	-	
Codice / Code	9351760600	mm	inch	Codice / Code	9351771000	mm	inch
	Altezza / Height	147	5,79		Altezza / Height	136	5,35
	Diametro esterno Outer diameter	132	5,20		Diametro esterno Outer diameter	165	6,50
	Diametro interno Internal diameter	76	2,99		Diametro interno Internal diameter	51	2,01
	Tipo mezzo filtrante Filter media type	Cellulosa / Cellulose			Tipo mezzo filtrante Filter media type	Cellulosa / Cellulose	
	Stile / Style	Rotondo / Round			Stile / Style	Rotondo / Round	
	Tipo / Type	ViroLite			Tipo / Type	ViroLite	

Codice / Code	8001771200	mm	inch	Codice / Code	8001776200	mm	inch
	Altezza / Height	400	15,75		Altezza / Height	440	17,32
	Diametro esterno Outer diameter	234	9,21		Diametro esterno Outer diameter	163	6,42
	Diametro interno Internal diameter	138	5,43		Diametro interno Internal diameter	133	5,24
	Diametro foro borchia Stud hole diameter	16,5	0,65		Diametro foro borchia Stud hole diameter	17	0,67
	Tipo mezzo filtrante Filter media type	Cellulosa / Cellulose			Tipo mezzo filtrante Filter media type	Cellulosa / Cellulose	
	Stile / Style	Rotondo a tenuta assiale Round axial seal			Stile / Style	Rotondo a tenuta assiale Round axial seal	
	Tipo / Type	Cartuccia primaria / Primary cartridge			Tipo / Type	Cartuccia primaria / Primary cartridge	
	Note / Notes	L'altezza non include la guarnizione Height not include gasket			Note / Notes	L'altezza non include la guarnizione Height not include gasket	
Codice / Code	9351782300	mm	inch	Codice / Code	8001783000	mm	inch
	Altezza / Height	186	7,32		Altezza / Height	662	26,06
	Diametro esterno Outer diameter	267	10,51		Diametro esterno Outer diameter	324	12,76
	Diametro interno Internal diameter	100	3,94		Diametro interno Internal diameter	214	8,43
	Diametro foro borchia Stud hole diameter	-	-		Diametro foro borchia Stud hole diameter	13	0,51
	Tipo mezzo filtrante Filter media type	Cellulosa / Cellulose			Tipo mezzo filtrante Filter media type	Cellulosa / Cellulose	
	Stile / Style	Rotondo / Round			Stile / Style	Rotondo a tenuta assiale Round axial seal	
	Tipo / Type	ViroLite			Tipo / Type	Cartuccia primaria / Primary cartridge	
	Note / Notes	-			Note / Notes	L'altezza non include la guarnizione Height not include gasket	
Codice / Code	9351785200	mm	inch	Codice / Code	8001805600	mm	inch
	Altezza / Height	110	4,33		Altezza / Height	201	7,91
	Diametro esterno Outer diameter	216	8,50		Diagonale lunga Long diagonal	256	10,08
	Diametro interno Internal diameter	76	2,99		Diagonale corta Short diagonal	155	6,10
	Tipo mezzo filtrante Filter media type	Cellulosa / Cellulose			Tipo mezzo filtrante Filter media type	Cellulosa / Cellulose	
	Stile / Style	Rotondo / Round			Stile / Style	Ovale a tenuta assiale Oval axial seal	
	Tipo / Type	ViroLite			Tipo / Type	Filtro Jokto / Jokto Filter	
	Note / Notes	-			Note / Notes	Dimensioni delle diagonali riferite alla guarnizione / Diagonal dimensions referring to the gasket	
Codice / Code	8001809000	mm	inch	Codice / Code	8001816800	mm	inch
	Altezza / Height	87	3,43		Altezza / Height	279,5	11,00
	Diametro esterno Outer diameter	136	5,35		Diametro esterno tubo Outer pipe diameter	54	2,13
	Diametro interno Internal diameter	78	3,07		Diametro esterno inf. Lower outer diameter	124	4,88
	Tipo mezzo filtrante Filter media type	Cellulosa / Cellulose			Tipo mezzo filtrante Filter media type	Cellulosa / Cellulose	
	Stile / Style	Rotondo a tenuta radiale Round radial seal			Stile / Style	Rotondo / Round	
	Tipo / Type	-			Tipo / Type	-	
	Note / Notes	-			Note / Notes	-	











Pannello di sicurezza
abbinato
Matched security panel
8601807300

Codice / Code	8001820100	mm	inch		8001824900	mm	inch
	Altezza / Height	509	20,04		Altezza / Height	121	4,76
	Diametro esterno Outer diameter	312	12,28		Diametro esterno Outer diameter	112	4,41
	Diametro interno Internal diameter	178	7,01		Diametro interno Internal diameter	50	1,97
	Tipo mezzo filtrante Filter media type	Tela poliestere antistatica Antistatic polyester cloth			Tipo mezzo filtrante Filter media type	Cellulosa / Cellulose	
	Stile / Style	Rotondo a tenuta radiale Round radial seal			Stile / Style	-	
Cartuccia di sicurezza abbinata Matched security cartridge 8001630100	Tipo / Type	Cartuccia primaria / Primary cartridge			Tipo / Type	-	
	Note / Notes	Ritardante di fiamma / Flame retardant			Note / Notes	-	



Codice / Code	8001833400	mm	inch	Codice / Code	8001846100	mm	inch
	Altezza / Height	46	1,81		Altezza / Height	250	9,84
	Diametro esterno Outer diameter	120	4,72		Diametro esterno Outer diameter	308	12,13
	Diametro interno Internal diameter	80	3,15		Diametro interno Internal diameter	195	7,68
	Diametro foro borchia Stud hole diameter	-	-		Diametro foro borchia Stud hole diameter	17	0,67
	Tipo mezzo filtrante Filter media type	Elemento filtrante metallico Metallic filter element				Tipo mezzo filtrante Filter media type	Cellulosa / Cellulose
Stile / Style	Rotondo a tenuta assiale Round axial seal			Stile / Style	Rotondo a tenuta assiale Round axial seal		
Tipo / Type	-			Tipo / Type	Cartuccia primaria / Primary cartridge		
Note / Notes	-			Note / Notes	L'altezza non include la guarnizione Height not include gasket		

Codice / Code	8001846100	mm	inch	Codice / Code	8001867200	mm	inch
	Altezza / Height	250	9,84		Altezza / Height	270	10,63
	Diametro esterno Outer diameter	308	12,13		Diametro esterno Outer diameter	104	4,09
	Diametro interno Internal diameter	195	7,68		Diametro interno Internal diameter	63	2,48
	Diametro foro borchia Stud hole diameter	17	0,67		Tipo mezzo filtrante Filter media type	Cellulosa / Cellulose	
	Tipo mezzo filtrante Filter media type	Cellulosa / Cellulose				Stile / Style	Rotondo a tenuta radiale Round radial seal
Stile / Style	Rotondo a tenuta assiale Round axial seal			Tipo / Type	Cartuccia primaria / Primary cartridge		
Tipo / Type	Cartuccia primaria / Primary cartridge			Note / Notes	-		
Note / Notes	L'altezza non include la guarnizione Height not include gasket						

Codice / Code	8001876000	mm	inch	Codice / Code	8001876200	mm	inch
	Altezza / Height	282	11,10		Altezza / Height	290	11,42
	Diametro esterno sup. Upper outer diameter	60	2,36		Diametro esterno Outer diameter	131	5,16
	Diametro esterno inf. Lower outer diameter	64	2,52		Diametro interno Internal diameter	65	2,56
	Diametro interno Internal diameter	-	-		Tipo mezzo filtrante Filter media type	Cellulosa / Cellulose	
	Tipo mezzo filtrante Filter media type	Tessuto poliestere / Polyester Fiber				Stile / Style	Rotondo a tenuta radiale Round radial seal
Cartuccia primaria abbinata Matched primary cartridge 8001876200	Stile / Style	Rotondo a tenuta radiale Round radial seal			Tipo / Type	Cartuccia primaria / Primary cartridge	
	Tipo / Type	Cartuccia di sicurezza / Security cartridge		Cartuccia di sicurezza abbinata Matched security cartridge 8001876000	Note / Notes	-	
Note / Notes	-						

Codice / Code	8001878000	mm	inch	Codice / Code	8001878100	mm	inch
	Altezza / Height	304	11,97		Altezza / Height	229	9,02
	Diametro esterno Outer diameter	127	5,00		Diametro esterno Outer diameter	131	5,16
	Diametro interno Internal diameter	83	3,27		Diametro interno Internal diameter	71	2,80
	Diametro foro borchia Stud hole diameter	-	-		Diametro foro borchia Stud hole diameter	17	0,67
	Tipo mezzo filtrante Filter media type	Cellulosa / Cellulose			Tipo mezzo filtrante Filter media type	Cellulosa / Cellulose	
	Stile / Style	Rotondo a tenuta radiale Round radial seal			Stile / Style	Rotondo a tenuta assiale Round axial seal	
	Tipo / Type	Cartuccia primaria / Primary cartridge			Tipo / Type	Cartuccia primaria / Primary cartridge	
Note / Notes	-		Note / Notes	L'altezza non include la guarnizione Height not include gasket			
Codice / Code	8001878200	mm	inch	Codice / Code	8001878300	mm	inch
	Altezza / Height	230	9,06		Altezza / Height	342	13,46
	Diametro esterno sup. Upper outer diameter	153,5	6,04		Diametro esterno Outer diameter	236	9,29
	Diametro esterno inf. Lower outer diameter	109,5	4,31		Diametro interno Internal diameter	132	5,20
	Diametro interno Internal diameter	59	2,32		Tipo mezzo filtrante Filter media type	Cellulosa / Cellulose	
	Tipo mezzo filtrante Filter media type	Cellulosa / Cellulose			Stile / Style	Rotondo a tenuta radiale Round radial seal	
	Stile / Style	Rotondo a tenuta assiale Round axial seal			Tipo / Type	Cartuccia primaria / Primary cartridge	
	Tipo / Type	Cartuccia primaria / Primary cartridge			Note / Notes	-	
Note / Notes	L'altezza non include la guarnizione Height not include gasket		Note / Notes	-			
Codice / Code	8001878400	mm	inch	Codice / Code	8001881200	mm	inch
	Altezza / Height	544	21,42		Altezza / Height	358	14,09
	Diametro esterno Outer diameter	313	12,32		Diametro esterno Outer diameter	234	9,21
	Diametro interno Internal diameter	177	6,97		Diametro interno Internal diameter	132	5,20
	Tipo mezzo filtrante Filter media type	Cellulosa / Cellulose			Tipo mezzo filtrante Filter media type	Cellulosa / Cellulose	
	Stile / Style	Rotondo a tenuta radiale Round radial seal			Stile / Style	Rotondo a tenuta radiale Round radial seal	
	Tipo / Type	Cartuccia primaria / Primary cartridge			Tipo / Type	Cartuccia primaria / Primary cartridge	
	Note / Notes	-			Note / Notes	-	
Codice / Code	8001886800	mm	inch	Codice / Code	8001890500	mm	inch
	Altezza / Height	280	11,02		Altezza / Height	352	13,86
	Diametro esterno Outer diameter	133	5,24		Diametro esterno Outer diameter	165	6,50
	Diametro interno Internal diameter	70	2,76		Diametro interno Internal diameter	91,5	3,60
	Diametro foro borchia Stud hole diameter	17	0,67		Diametro foro borchia Stud hole diameter	-	-
	Tipo mezzo filtrante Filter media type	Cellulosa / Cellulose			Tipo mezzo filtrante Filter media type	Cellulosa / Cellulose	
	Stile / Style	Rotondo a tenuta assiale Round axial seal			Stile / Style	Rotondo / Round	
	Tipo / Type	Cartuccia primaria / Primary cartridge			Tipo / Type	Cartuccia primaria / Primary cartridge	
Note / Notes	L'altezza non include la guarnizione Height not include gasket		Note / Notes	-			
Codice / Code	9351891900	mm	inch	Codice / Code	8001904900	mm	inch
	Altezza / Height	137	5,39		Altezza / Height	176	6,93
	Diametro esterno Outer diameter	140	5,51		Diagonale lunga Long diagonal	254,5	10,02
	Diametro interno Internal diameter	45	1,77		Diagonale corta Short diagonal	154	6,06
	Tipo mezzo filtrante Filter media type	Cellulosa / Cellulose			Tipo mezzo filtrante Filter media type	Cellulosa / Cellulose	
	Stile / Style	Ovale / Oval			Stile / Style	Ovale a tenuta assiale Oval axial seal	
	Tipo / Type	ViroLite			Tipo / Type	Filtro Jokto / Jokto Filter	
	Note / Notes	-			Note / Notes	Dimensioni delle diagonali riferite alla guarnizione / Diagonal dimensions referring to the gasket	
				Pannello di sicurezza abbinato / Matched security panel 8601962000			

Codice / Code	8001915700	mm	inch	Codice / Code	8001930500	mm	inch
 <p>Pannello di sicurezza abbinato / Matched security panel</p> <p>8601915800</p>	Altezza / Height	202,5	7,97		Altezza / Height	687	27,05
	Diagonale lunga Long diagonal	300	11,81		Diametro esterno sup. Upper outer diameter	172	6,77
	Diagonale corta Short diagonal	170	6,69		Diametro esterno inf. Lower outer diameter	181	7,13
	Tipo mezzo filtrante Filter media type	Cellulosa / Cellulose			Diametro interno Internal diameter	138	5,43
	Stile / Style	Ovale / Oval			Tipo mezzo filtrante Filter media type	Cellulosa / Cellulose	
Tipo / Type	Filtro Jokto / Jokto Filter		Stile / Style	Rotondo a tenuta radiale / Round radial seal			
Note / Notes	Dimensioni delle diagonali riferite alla guarnizione / Diagonal dimensions referring to the gasket		Tipo / Type	Cartuccia di sicurezza / Security cartridge			
				Note / Notes	-		

Codice / Code	8001934500	mm	inch	Codice / Code	8001945000	mm	inch
	Altezza / Height	285	11,22		Altezza / Height	461	18,15
	Diametro esterno Outer diameter	227	8,94		Diametro esterno Outer diameter	312	12,28
	Diametro interno Internal diameter	118	4,65		Diametro interno Internal diameter	216	8,50
	Diametro foro borchia Stud hole diameter	10,5	0,41		Diametro foro borchia Stud hole diameter	-	-
	Tipo mezzo filtrante Filter media type	Cellulosa / Cellulose			Tipo mezzo filtrante Filter media type	Cellulosa / Cellulose	
Stile / Style	Rotondo a tenuta assiale Round axial seal		Stile / Style	Rotondo / Round			
Tipo / Type	Cartuccia primaria / Primary cartridge		Tipo / Type	Cartuccia primaria / Primary cartridge			
Note / Notes	L'altezza non include la guarnizione Height not include gasket		Note / Notes	-			

Codice / Code	8001981800	mm	inch
	Altezza / Height	436,5	17,19
	Diametro esterno Outer diameter	266	10,47
	Diametro interno Internal diameter	168	6,61
	Tipo mezzo filtrante Filter media type	Cellulosa / Cellulose	
	Stile / Style	Rotondo / Round	
Tipo / Type	Cartuccia primaria / Primary cartridge		
Note / Notes	-		

CARTUCCE ARIA IN ORDINE DI DIMENSIONE

Air elements listed by dimension

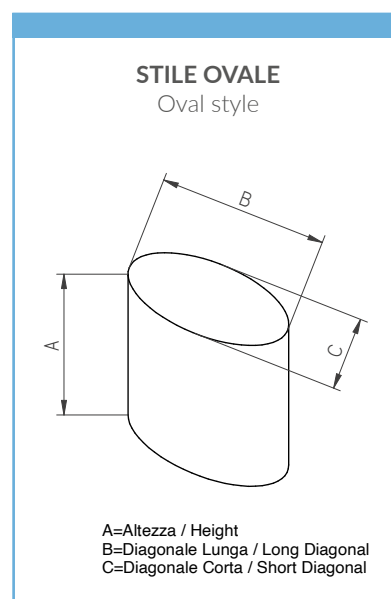
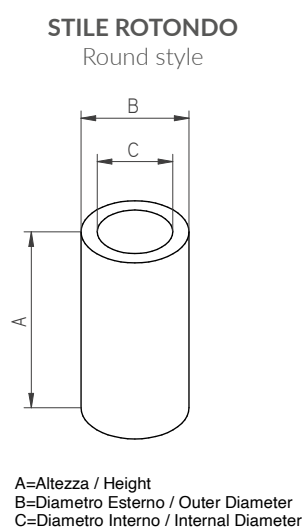
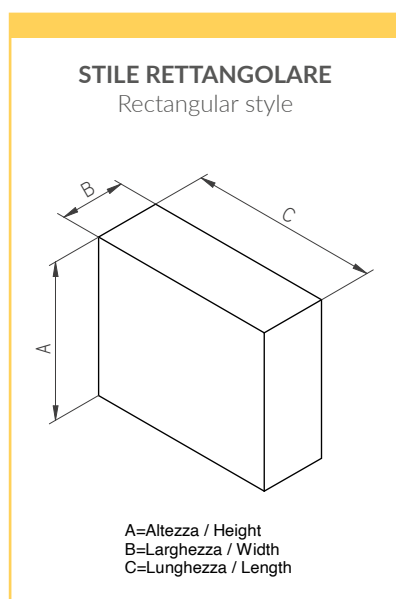

PART. N.	A		B		C	
	mm	inch	mm	inch	mm	inch
8001413300	986	38,82	324	12,76	214	8,43
8001629000	900	35,43	142,5	5,61	109	4,29
			149,5	5,89	-	-
8001377100	838	32,99	327	12,87	255	10,04
8001176400	788	31,02	392	15,43	302	11,89
8001240500	788	31,02	324	12,76	214	8,43
8001405800	788	31,02	324	12,76	214	8,43
8001495500	788	31,02	324	12,76	214	8,43
8001930500	687	27,05	172	6,77	138	5,43
			181	7,13	-	-
8001102000	662	26,06	324	12,76	214	8,43
8001783000	662	26,06	324	12,76	214	8,43
8001209300	656	25,83	335	13,19	182	7,17
			280	11,02	-	-
8001653300	640	25,20	282	11,10	171	6,73
8001567300	610	24,02	308	12,13	195	7,68
8001723000	610	24,02	374	14,72	263,5	10,37
8001747000	610	24,02	209	8,23	192	7,56
			201	7,91	-	-
8001194000	600	23,62	324	12,76	214	8,43
8001288400	600	23,62	324	12,76	214	8,43
			-	-	214	8,43
8001340000	600	23,62	324	12,76	214	8,43
8001359100	600	23,62	324	12,76	214	8,43
			-	-	214	8,43
8001388000	600	23,62	485	19,09	335	13,19
8001561400	600	23,62	327	12,87	216	8,50
8001568100	600	23,62	217	8,54	157	6,18
			185	7,28	-	-
8001702000	600	23,62	324	12,76	214	8,43
8001753100	600	23,62	324	12,76	214	8,43
8001697100	588	23,15	296	11,65	200	7,87
8001707000	585	23,03	447	17,60	309	12,17
8001652100	582	22,91	312	12,28	178	7,01
8001697200	573	22,56	195	7,68	-	-
			193	7,60	-	-
8001121100	568	22,36	265	10,43	153	6,02
8001693800	568	22,36	172	6,77	138	5,43
			148	5,83	-	-
8001652200	564	22,20	173	6,81	146	5,75
			178	7,01	-	-
8001707500	560	22,05	330	12,99	261	10,28
8001723200	559	22,01	260	10,24	231	9,09
8001878400	544	21,42	313	12,32	177	6,97
8001696900	538	21,18	240	9,45	144	5,67
8001730300	530	20,87	308	12,13	195	7,68
8001490200	526	20,71	303	11,93	168,5	6,63
8001488800	523	20,59	280	11,02	146,5	5,77
8001668900	523	20,59	280	11,02	146,5	5,77

PART. N.	A		B		C	
	mm	inch	mm	inch	mm	inch
8001629400	522	20,55	312	12,28	178	7,01
8001692200	522	20,55	312	12,28	178	7,01
8001697000	522	20,55	136	5,35	-	-
			134,5	5,30	-	-
8001759400	521	20,51	194	7,64	153	6,02
8001820100	509	20,04	312	12,28	178	7,01
8001335600	508	20,00	282	11,10	171	6,73
8001335700	508	20,00	195	7,68	134	5,28
			162,5	6,40	-	-
8001390500	508	20,00	282	11,10	171	6,73
8001518000	508	20,00	282	11,10	171	6,73
8001630100	508	20,00	173	6,81	146	5,75
			178	7,01	-	-
8001349500	497	19,57	282	11,10	171	6,73
8001379700	497	19,57	282	11,10	198	7,80
8001687300	497	19,57	242	9,53	132	5,20
			309	12,17	-	-
8001641800	494	19,45	240	9,45	123	4,84
8001223500	484	19,06	242	9,53	132	5,20
8001223800	484	19,06	242	9,53	132	5,20
8001490000	483	19,02	303	11,93	168,5	6,63
8001720300	480	18,90	275,5	10,85	171	6,73
8001352900	479	18,86	130	5,12	125	4,92
8001641900	475	18,70	119	4,69	108	4,25
			123,5	4,86	-	-
8001352800	470	18,50	155	6,10	145	5,71
8001652300	461	18,15	312	12,28	178	7,01
8001945000	461	18,15	312	12,28	216	8,50
8001227800	460	18,11	302	11,89	191	7,52
8001369200	460	18,11	282	11,10	198	7,80
8001376300	458	18,03	327	12,87	216	8,50
8001225300	456	17,95	308	12,13	195	7,68
8001278100	456	17,95	254	10,00	170	6,69
8001363200	456	17,95	234	9,21	124	4,88
8001530000	456	17,95	308	12,13	195	7,68
8001757800	456	17,95	308	12,13	195	7,68
8001576200	455	17,91	307	12,09	196	7,72
8001225200	450	17,72	217	8,54	157	6,18
			185	7,28	-	-
8001363600	450	17,72	148	5,83	88	3,46
			117	4,61	-	-
8001315000	446	17,56	230	9,06	117	4,61
			160	6,30	-	-
8001587000	446	17,56	149	5,87	105,5	4,15
			117	4,61	-	-
8001489600	445	17,52	303	11,93	168,5	6,63
9351711100	443	17,44	316	12,44	200	7,87
8001347300	440	17,32	279	10,98	135	5,31
			201	7,91	-	-

PART. N.	A		B		C	
	mm	inch	mm	inch	mm	inch
8001776200	440	17,32	163	6,42	133	5,24
8001981800	436,5	17,19	266	10,47	168	6,61
8001537100	418	16,46	206	8,11	106,5	4,19
8001692800	418	16,46	206	8,11	106,5	4,19
8001224500	408	16,06	282	11,10	171	6,73
8001431200	408	16,06	282	11,10	171	6,73
8001227300	407	16,02	307	12,09	196	7,72
8001438600	407	16,02	214	8,43	88	3,46
			198	7,80	-	-
8001130800	406	15,98	201	7,91	135	5,31
8001220300	406	15,98	236	9,29	124	4,88
8001221000	406	15,98	282	11,10	170,5	6,71
8001224400	406	15,98	174	6,85	107	4,21
8001225400	406	15,98	195	7,68	134	5,28
			162,5	6,40	-	-
8001239000	406	15,98	279	10,98	135	5,31
			201	7,91	-	-
8001279000	406	15,98	279	10,98	124	4,88
			234	9,21	-	-
8001279400	406	15,98	317,5	12,50	153	6,02
			265	10,43	-	-
8001279800	406	15,98	276,5	10,89	123	4,84
			254	10,00	-	-
8001415400	406	15,98	245,5	9,67	154	6,06
			279	10,98	135	5,31
8001445500	406	15,98	201	7,91	-	-
			102	4,02	87	3,43
8001538000	406	15,98	106	4,17	-	-
			317,5	12,50	153	6,02
8001594900	406	15,98	240	9,45	-	-
			240	9,45	-	-
8001227600	404	15,91	234	9,21	124	4,88
8001234500	404	15,91	317,5	12,50	153	6,02
			264	10,39	-	-
8001688100	403	15,87	220	8,66	124	4,88
8001173200	402	15,83	234	9,21	133	5,24
8001357700	400	15,75	234	9,21	133	5,24
8001649200	400	15,75	194	7,64	114	4,49
8001757700	400	15,75	234	9,21	133	5,24
8001771200	400	15,75	234	9,21	138	5,43
8001131700	397	15,63	145	5,71	88	3,46
			117	4,61	-	-
8001672900	387	15,24	185	7,28	106	4,17
8001687500	387	15,24	117	4,61	-	-
			114,5	4,51	-	-
8001530400	385	15,16	308	12,13	195	7,68
8001649600	385	15,16	107	4,21	-	-
			104,5	4,11	-	-
8001128800	383	15,08	155	6,10	88	3,46
8001129500	383	15,08	134	5,28	92,5	3,64

PART. N.	A		B		C	
	mm	inch	mm	inch	mm	inch
8001384800	383	15,08	155	6,10	88	3,46
8001473300	383	15,08	134	5,28	83,5	3,29
8001193500	382	15,04	214	8,43	88	3,46
			195	7,68	-	-
8001320500	382	15,04	164	6,46	98	3,86
			192	7,56	-	-
8001327000	382	15,04	214	8,43	88	3,46
			198	7,80	-	-
8001483000	382	15,04	214	8,43	88	3,46
			198	7,80	-	-
8001747700	382	15,04	106	4,17	-	-
8001226500	381	15,00	123	4,84	93	3,66
			104	4,09	-	-
8001239500	380	14,96	117	4,61	88	3,46
8001250700	380	14,96	186	7,32	119,5	4,70
			247	9,72	-	-
8001352700	380	14,96	113	4,45	105	4,13
8001673100	380	14,96	101	3,98	87,5	3,44
			107	4,21	-	-
8001194200	378	14,88	213	8,39	87	3,43
			197	7,76	-	-
8001425900	376	14,80	302	11,89	191	7,52
8001319000	375	14,76	188	7,40	160	6,30
8001556500	375	14,76	308	12,13	195	7,68
8001649100	375	14,76	159	6,26	94	3,70
8001381800	374	14,72	155	6,10	92	3,62
8001529400	374	14,72	282	11,10	171	6,73
8001315600	371	14,61	230	9,06	117	4,61
			160	6,30	-	-
8001353100	370	14,57	99	3,90	89	3,50
8001223400	369	14,53	227	8,94	117	4,61
8001224200	369	14,53	227	8,94	117	4,61
8001560400	368	14,49	217	8,54	157	6,18
			185	7,28	-	-
8001238700	365	14,37	302	11,89	191	7,52
8001238500	362	14,25	198	7,80	104	4,09
8001170200	360	14,17	190	7,48	116	4,57
8001180800	360	14,17	190	7,48	130	5,12
8001649000	360	14,17	149	5,87	84	3,31
8001649500	360	14,17	87	3,43	-	-
			84,5	3,33	-	-
8001250000	359	14,13	211	8,31	135	5,31
			230	9,06	-	-
8001285700	359	14,13	164	6,46	98	3,86
			192	7,56	-	-
8001881200	358	14,09	234	9,21	132	5,20
8001228300	356	14,02	310	12,20	200	7,87
8001410400	356	14,02	173	6,81	88	3,46
8001410700	356	14,02	242	9,53	132	5,20

PART. N.	A		B		C	
	mm	inch	mm	inch	mm	inch
8001131600	355	13,98	106	4,17	74	2,91
			85	3,35	-	-
8001146700	355	13,98	104	4,09	63	2,48
8001226900	355	13,98	264	10,39	153	6,02
8001228400	355	13,98	280	11,02	172	6,77
8001507800	355	13,98	104	4,09	63	2,48
8001519600	355	13,98	104	4,09	63	2,48
8001309000	354	13,94	196,3	7,73	128,5	5,06
			229,3	9,03	-	-
8001710300	354	13,94	150	5,91	97	3,82
			119	4,69	-	-
8001131500	352	13,86	91	3,58	74	2,91
			85	3,35	-	-
8001890500	352	13,86	165	6,50	91,5	3,60
8001736500	347	13,66	164	6,46	90	3,54
8001138800	345	13,58	234	9,21	127	5,00
8001353000	345	13,58	82	3,23	72	2,83
8001470300	345	13,58	162	6,38	90	3,54
8001649400	345	13,58	76	2,99	-	-
			74	2,91	-	-
8001111700	344	13,54	201	7,91	90	3,54
8001194100	344	13,54	170	6,69	72	2,83
			137	5,39	-	-
8001315700	344	13,54	185	7,28	92	3,62
			121	4,76	-	-
8001571100	344	13,54	201	7,91	90	3,54
8001286700	342	13,46	72	2,83	60,5	2,38
8001307500	342	13,46	180	7,09	72	2,83
			138	5,43	-	-
8001340400	342	13,46	174	6,85	72	2,83
			140	5,51	-	-
8001438700	342	13,46	154	6,06	80	3,15
8001878300	342	13,46	236	9,29	132	5,20
8001483500	341	13,43	214	8,43	88	3,46
			159	6,26	-	-
8001162100	340	13,39	170	6,69	91,5	3,60
8001165500	340	13,39	66	2,60	48	1,89
			62	2,44	-	-
8001238600	340	13,39	164	6,46	86	3,39
8001298000	340	13,39	164	6,46	86	3,39
			200,5	7,89	-	-
8001317300	340	13,39	324	12,76	214	8,43
8001356100	340	13,39	165	6,50	118	4,65
			201	7,91	-	-
8001357300	340	13,39	164	6,46	86	3,39
8001736600	340	13,39	88	3,46	73	2,87
			92	3,62	-	-
8001757500	340	13,39	164	6,46	86	3,39
			88	3,46	73	2,87
8001441300	338	13,31	92	3,62	-	-

PART. N.	A		B		C	
	mm	inch	mm	inch	mm	inch
8001227900	336	13,23	132	5,20	103	4,06
8001388900	336	13,23	188	7,40	160	6,30
8001342300	335	13,19	163	6,42	98	3,86
8001342400	335	13,19	163	6,42	98	3,86
8001314100	333	13,11	230	9,06	117	4,61
			160	6,30	-	-
8001175500	332	13,07	164	6,46	86	3,39
8001438000	332	13,07	272	10,71	123,5	4,86
			254,5	10,02	-	-
8001516600	332	13,07	164	6,46	86	3,39
8001139000	331	13,03	110	4,33	70	2,76
8001423700	331	13,03	279	10,98	124	4,88
			234	9,21	-	-
8001470800	331	13,03	88	3,46	73	2,87
			92	3,62	-	-
8001749000	331	13,03	138	5,43	81	3,19
8001123900	330	12,99	120	4,72	79	3,11
			85	3,35	-	-
8001134300	330	12,99	234	9,21	124	4,88
			275	10,83	-	-
8001138900	330	12,99	234	9,21	124	4,88
8001139100	330	12,99	145	5,71	88	3,46
			117	4,61	-	-
8001221400	330	12,99	282	11,10	170	6,69
8001341000	330	12,99	60,7	2,39	48,5	1,91
			115,5	4,55	-	-
8001347700	330	12,99	276,5	10,89	123	4,84
			234	9,21	-	-
8001453300	330	12,99	213	8,39	87	3,43
			197	7,76	-	-
8001407400	329	12,95	142	5,59	82	3,23
8001222800	328	12,91	155	6,10	88	3,46
8001648700	327	12,87	80	3,15	66	2,60
			68	2,68	-	-
8001223100	325	12,80	150	5,91	71	2,80
8001524700	325	12,80	150	5,91	71	2,80
8001687600	325	12,80	90	3,54	76	2,99
			82,5	3,25	-	-
8001393900	324	12,76	178	7,01	155	6,10
8001472200	324	12,76	189	7,44	96	3,78
			196	7,72	-	-
8001486500	322	12,68	1742	68,58	82	3,23
8001222500	321	12,64	164	6,46	86	3,39
8001260400	320	12,60	248	9,76	143,5	5,65
8001648900	320	12,60	125	4,92	74	2,91
8001220500	316	12,44	162	6,38	80,5	3,17
			149	5,87	-	-
8001394800	316	12,44	280	11,02	178	7,01
8001229000	315	12,40	162	6,38	80,5	3,17
			149	5,87	-	-

PART. N.	A		B		C	
	mm	inch	mm	inch	mm	inch
8001427000	315	12,40	78	3,07	63	2,48
			85	3,35	-	-
8001230200	314	12,36	197	7,76	176	6,93
9351655000	314	12,36	217	8,54	76	2,99
9351656000	314	12,36	217	8,54	101	3,98
9351685900	314	12,36	217	8,54	76	2,99
9351686200	314	12,36	217	8,54	101	3,98
8001249100	312	12,28	132	5,20	76	2,99
			146	5,75	-	-
8001249800	312	12,28	132	5,20	76	2,99
			135	5,31	-	-
9351733600	312	12,28	317	12,48	127	5,00
8001605000	311	12,24	128	5,04	84	3,31
8001433400	310	12,20	211	8,31	135	5,31
			230	9,06	-	-
8001224300	306	12,05	155	6,10	88	3,46
8001220800	305	12,01	234	9,21	123	4,84
8001222900	305	12,01	105	4,13	74	2,91
			85	3,35	-	-
8001649300	305	12,01	67	2,64	-	-
			65	2,56	-	-
8001100300	304	11,97	155	6,10	88	3,46
8001105600	304	11,97	134	5,28	92,5	3,64
8001125400	304	11,97	155	6,10	82,5	3,25
8001159000	304	11,97	155	6,10	88	3,46
8001878000	304	11,97	127	5,00	83	3,27
8001482900	303	11,93	106	4,17	74	2,91
			85	3,35	-	-
9351614100	300	11,81	266	10,47	101	3,98
9351686400	300	11,81	266	10,47	101	3,98
9351733500	300	11,81	267	10,51	102	4,02
8001605400	299	11,77	78	3,07	63	2,48
			82	3,23	-	-
9351711400	298	11,73	196	7,72	150	5,91
8001381100	296	11,65	155	6,10	92	3,62
8001440900	296	11,65	105	4,13	61	2,40
8001441000	296	11,65	162	6,38	90	3,54
8001280900	292	11,50	150	5,91	71	2,80
8001125200	290	11,42	90	3,54	60	2,36
8001125300	290	11,42	90	3,54	60	2,36
8001248500	290	11,42	74	2,91	48	1,89
8001307400	290	11,42	180	7,09	72	2,83
			140	5,51	-	-
8001876200	290	11,42	131	5,16	65	2,56
8001188000	289	11,38	162	6,38	72	2,83
			138	5,43	-	-
8001471500	288	11,34	112	4,41	76,5	3,01
			92	3,62	-	-
8001111000	287	11,30	85	3,35	75	2,95

PART. N.	A		B		C	
	mm	inch	mm	inch	mm	inch
8001257600	287	11,30	105	4,13	74	2,91
			85	3,35	-	-
8001282500	286	11,26	243	9,57	132	5,20
			56	2,20	41	1,61
8001440200	286	11,26	59	2,32	-	-
8001224800	285	11,22	227	8,94	117	4,61
8001265300	285	11,22	121	4,76	54	2,13
8001418300	285	11,22	95,5	3,76	74,5	2,93
			85,5	3,37	-	-
8001438800	285	11,22	166	6,54	75	2,95
8001934500	285	11,22	227	8,94	118	4,65
8001174900	284	11,18	120	4,72	70	2,76
8001223000	284	11,18	126	4,96	65	2,56
8001648800	284	11,18	69,5	2,74	56,5	2,22
			61,5	2,42	-	-
8001411300	283	11,14	50	1,97	62	2,44
			92,5	3,64	-	-
8001434000	283	11,14	132	5,20	103	4,06
8001547500	282	11,10	138	5,43	81,5	3,21
8001876000	282	11,10	60	2,36	-	-
			64	2,52	-	-
8001103800	280	11,02	134	5,28	68	2,68
8001125500	280	11,02	134	5,28	82,5	3,25
			92,5	3,64	62	2,44
8001222600	280	11,02	75	2,95	-	-
8001268800	280	11,02	134	5,28	84	3,31
8001277500	280	11,02	134	5,28	72	2,83
			180	7,09	-	-
8001706400	280	11,02	62	2,44	-	-
			63	2,48	-	-
8001886800	280	11,02	133	5,24	70	2,76
8001816800	279,5	11,00	54	2,13	124	4,88
8001275200	279	10,98	234	9,21	124	4,88
8001540000	278	10,94	75	2,95	62	2,44
9351732900	276	10,87	216	8,50	76	2,99
			213	8,39	105	4,13
8001282600	275	10,83	235	9,25	-	-
8001382400	273	10,75	134	5,28	70	2,76
8001588700	273	10,75	105	4,13	62	2,44
			150	5,91	97	3,82
8001709200	272	10,71	119	4,69	-	-
8001867200	270	10,63	104	4,09	63	2,48
8001266000	269	10,59	268	10,55	195	7,68
8001224100	268	10,55	113,5	4,47	57	2,24
			128	5,04	-	-
8001260500	268	10,55	140	5,51	107,5	4,23
9351733200	263	10,35	165	6,50	51	2,01
8001110900	262	10,31	66	2,60	56	2,20
8001124600	262	10,31	90	3,54	60	2,36
8001126900	262	10,31	90	3,54	60	2,36

PART. N.	A		B		C	
	mm	inch	mm	inch	mm	inch
8001416000	262	10,31	66	2,60	56	2,20
9351575100	262	10,31	316	12,44	127	5,00
9351659700	262	10,31	316	12,44	127	5,00
9351716300	261	10,28	266	10,47	101	3,98
8001268900	260	10,24	82	3,23	64	2,52
			56	2,20	41	1,61
8001610800	260	10,24	59	2,32	-	-
			104	4,09	64	2,52
8001362300	255	10,04	150	5,91	-	-
			77	3,03	56	2,20
8001555700	255	10,04	66	2,60	-	-
8001222100	254	10,00	155	6,10	88	3,46
8001225100	254	10,00	234,5	9,23	122,5	4,82
			150	5,91	63	2,48
8001277000	254	10,00	129	5,08	-	-
			104	4,09	63	2,48
8001404700	254	10,00	150	5,91	-	-
			79	3,11	56	2,20
8001434300	254	10,00	64,5	2,54	-	-
			104	4,09	63	2,48
8001551200	254	10,00	150	5,91	-	-
8001110600	253	9,96	104	4,09	63	2,48
			104	4,09	64,5	2,54
8001271600	253	9,96	146	5,75	-	-
8001439300	253	9,96	104	4,09	63	2,48
8001482700	253	9,96	104	4,09	63	2,48
8001687800	253	9,96	115	4,53	64	2,52
			92,5	3,64	92	3,62
8001204800	251	9,88	70	2,76	-	-
8001240300	250	9,84	485	19,09	335	13,19
			150	5,91	81	3,19
8001318500	250	9,84	174	6,85	-	-
8001846100	250	9,84	308	12,13	195	7,68
8001687200	243	9,57	62	2,44	52	2,05
8001110800	242	9,53	62	2,44	52	2,05
8001218100	240	9,45	83	3,27	54	2,13
			92,5	3,64	62	2,44
8001726000	240	9,45	70	2,76	-	-
			57	2,24	-	-
8001687700	238	9,37	54,5	2,15	-	-
8001067700	237	9,33	164	6,46	86	3,39
			83	3,27	46	1,81
8001329400	236	9,29	127	5,00	-	-
8001329600	236	9,29	83	3,27	46	1,81
8001334900	235	9,25	166	6,54	86,5	3,41
			108	4,25	67	2,64
8001351000	230	9,06	115	4,53	-	-
			153,5	6,04	59	2,32
8001878200	230	9,06	109,5	4,31	-	-
8001878100	229	9,02	131	5,16	71	2,80

PART. N.	A		B		C	
	mm	inch	mm	inch	mm	inch
8001222200	228	8,98	104	4,09	63	2,48
8001401500	228	8,98	104	4,09	63	2,48
8001228500	226	8,90	165	6,50	86,5	3,41
8001199800	225	8,86	155	6,10	88	3,46
8001228700	225	8,86	126	4,96	65	2,56
8001364400	224	8,82	126	4,96	65	2,56
8001068900	223	8,78	183	7,20	106	4,17
8001421400	220	8,66	120	4,72	70	2,76
8001687400	220	8,66	334	13,15	205	8,07
8001178900	218	8,58	150	5,91	72	2,83
8001171200	217	8,54	234	9,21	124	4,88
8001223900	217	8,54	242	9,53	132	5,20
8001239700	217	8,54	109	4,29	52	2,05
8001425700	217	8,54	234	9,21	133	5,24
8001415200	210	8,27	110	4,33	63	2,48
8001352000	209	8,23	66	2,60	41	1,61
8001498000	209	8,23	60,7	2,39	48,5	1,91
			115,5	4,55	-	-
8001357900	205	8,07	164	6,46	86	3,39
8001757600	205	8,07	164	6,46	86	3,39
8001541100	203	7,99	75	2,95	62	2,44
8001915700	202,5	7,97	300	11,81	170	6,69
8001162300	202	7,95	170	6,69	91,5	3,60
8001175200	202	7,95	164	6,46	86	3,39
8001492800	202	7,95	164	6,46	86	3,39
8001805600	201	7,91	256	10,08	155	6,10
8001173100	200	7,87	183	7,20	120	4,72
8001209100	200	7,87	164	6,46	86	3,39
8001356200	200	7,87	183	7,20	120	4,72
8001453600	200	7,87	234	9,21	133	5,24
8001473500	200	7,87	183	7,20	120	4,72
8001688000	200	7,87	80	3,15	66	2,60
			68	2,68	-	-
9351733100	199	7,83	216	8,50	64	2,52
8001406300	198	7,80	111	4,37	50	1,97
8001281700	197	7,76	150	5,91	71	2,80
8001350600	197	7,76	121	4,76	75	2,95
8001687900	191	7,52	85	3,35	8	0,31
			82,5	3,25	-	-
8001121900	190	7,48	130	5,12	63	2,48
8001220200	190	7,48	104	4,09	63	2,48
8001330000	189	7,44	155	6,10	88	3,46
8001359700	189	7,44	104	4,09	64	2,52
			150	5,91	-	-
8001421100	189	7,44	155	6,10	88	3,46
8001245900	188	7,40	85	3,35	72	2,83
8001475800	188	7,40	85	3,35	74	2,91
8001210600	186	7,32	106	4,17	74	2,91
			85	3,35	-	-
9351782300	186	7,32	267	10,51	100	3,94









PART. N.	A		B		C	
	mm	inch	mm	inch	mm	inch
8001441200	184	7,24	89	3,50	46	1,81
8001317700	180	7,09	90	3,54	60	2,36
8001514500	179	7,05	89	3,50	41	1,61
8001273900	178	7,01	128	5,04	43	1,69
			109	4,29	-	-
8001269400	177	6,97	83	3,27	46	1,81
8001526700	177	6,97	83	3,27	54	2,13
8001759000	177	6,97	96	3,78	42,5	1,67
			-	-	42,5	1,67
8001904900	176	6,93	254,5	10,02	154	6,06
8001167500	175	6,89	83	3,27	46	1,81
8001478700	175	6,89	92,5	3,64	62	2,44
			70	2,76	-	-
8001517000	173	6,81	45	1,77	35	1,38
8001411100	171	6,73	160	6,30	60,5	2,38
8001628400	169	6,65	83	3,27	46	1,81
			-	-	46	1,81
8001331000	165	6,50	85	3,35	56	2,20
8001383500	165	6,50	160	6,30	77	3,03
9351609700	165	6,50	160	6,30	77	3,03
8001287000	164	6,46	126	4,96	65	2,56
8001298500	163	6,42	93	3,66	44	1,73
8001329700	161	6,34	90,5	3,56	41,5	1,63
9351733000	161	6,34	165	6,50	57	2,24
8001288800	160	6,30	104	4,09	63	2,48
8001525500	158	6,22	51	2,01	40	1,57
			55	2,17	-	-
8001394700	156	6,14	280	11,02	138	5,43
8001311600	151	5,94	130	5,12	76	2,99
8001173000	150	5,91	155	6,10	88	3,46
8001183700	150	5,91	155	6,10	88	3,46
9351971100	149	5,87	114	4,49	38	1,50
9351760600	147	5,79	132	5,20	76	2,99
8001271300	146	5,75	204	8,03	78,8	3,10
8001155500	145	5,71	104	4,09	63	2,48
8001192900	145	5,71	120	4,72	70	2,76
8001398200	145	5,71	120	4,72	70	2,76
8001531000	143	5,63	120	4,72	80	3,15
9351891900	137	5,39	140	5,51	45	1,77
9351733300	136	5,35	216	8,50	64	2,52
9351771000	136	5,35	165	6,50	51	2,01
8001578800	135	5,31	186	7,32	133,5	5,26
8001754200	135	5,31	117,5	4,63	67	2,64
8001161800	134	5,28	62	2,44	52	2,05
8001544700	128	5,04	112	4,41	40	1,57
9351760400	123	4,84	112	4,41	62	2,44
8001284300	121	4,76	277	10,91	157	6,18
8001824900	121	4,76	112	4,41	50	1,97
8001106300	120	4,72	69	2,72	26	1,02

PART. N.	A		B		C	
	mm	inch	mm	inch	mm	inch
8001311500	120	4,72	112	4,41	50	1,97
8001271200	119	4,69	148	5,83	47,8	1,88
9351785200	110	4,33	216	8,50	76	2,99
8001751200	104	4,09	98	3,86	60	2,36
			-	-	60	2,36
8001638400	102	4,02	101	3,98	67	2,64
8001500500	101	3,98	203	7,99	98	3,86
8001160300	100	3,94	120	4,72	70	2,76
8001171600	100	3,94	120	4,72	65	2,56
8001217700	96	3,78	210	8,27	149,5	5,89
			-	-	149,5	5,89
8001442500	96	3,78	164	6,46	86	3,39
8001473800	96	3,78	164	6,46	86	3,39
8001136000	95	3,74	183	7,20	107	4,21
8001162200	95	3,74	183	7,20	106	4,17
8001229100	95	3,74	120	4,72	70	2,76
8001247400	95	3,74	140	5,51	94	3,70
8001259800	95	3,74	183	7,20	106	4,17
8001637800	95	3,74	183	7,20	107	4,21
8001175800	94	3,70	120	4,72	80	3,15
8001281800	94	3,70	183	7,20	106	4,17
8001682400	94	3,70	77	3,03	23	0,91
8001246300	92	3,62	210	8,27	165	6,50
8001253200	92	3,62	215	8,46	146	5,75
8001346700	92	3,62	215	8,46	146	5,75
8001809000	87	3,43	136	5,35	78	3,07
8001195800	79	3,11	140	5,51	94	3,70
8001754100	79	3,11	100	3,94	67	2,64
8001348900	78	3,07	207	8,15	153	6,02
8001563300	77	3,03	76	2,99	34	1,34
8001495000	76	2,99	160	6,30	120	4,72
8001284700	74	2,91	199	7,83	105	4,13
8001400600	74	2,91	207	8,15	153	6,02
8001688800	72,5	2,85	142	5,59	92	3,62
8001737200	72	2,83	104	4,09	63	2,48
8001146300	71	2,80	140	5,51	94	3,70
8001295300	70	2,76	98	3,86	60	2,36
			-	-	60	2,36
8001740600	70	2,76	65	2,56	38,5	1,52
8001753900	69	2,72	60	2,36	34,5	1,36
8001283900	67	2,64	132,5	5,22	78	3,07
8001134800	66	2,60	140	5,51	94	3,70
8001215000	66	2,60	168	6,61	108	4,25
8001213500	64	2,52	210	8,27	165	6,50
8001424500	60	2,36	120	4,72	70	2,76
8001176100	58	2,28	134	5,28	92,5	3,64
8001121000	55	2,17	140	5,51	94	3,70
8001350000	48	1,89	242	9,53	194	7,64
8001569600	46	1,81	135	5,31	54	2,13
8001833400	46	1,81	120	4,72	80	3,15

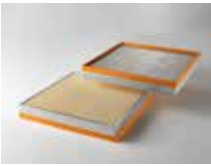

FILTRI CABINA

Cabin filters

Codice / Code	8601409000	mm	inch	Codice / Code	8601409500	mm	inch
	Altezza / Height	133	5,24		Altezza / Height	133	5,24
	Larghezza / Width	380	14,96		Larghezza / Width	380	14,96
	Lunghezza / Length	382	15,04		Lunghezza / Length	382	15,04
	Tipo mezzo filtrante Filter media type	Cellulosa / Cellulose			Tipo mezzo filtrante Filter media type	Bulpren	
	Telaio / Frame	Metallo / Metal			Telaio / Frame	Metallo / Metal	
	Stile / Style	Pannello Rettangolare / Rectangular Panel			Stile / Style	Pannello Rettangolare / Rectangular Panel	
	Tipo / Type	-			Tipo / Type	-	
	Descrizione / Description	-			Descrizione / Description	Filtro a pannello per uso marino Panel filter for marine use	
	Note / Notes	Attenzione le dimensioni non includono la guarnizione / Attention the dimensions do not include the gasket			Note / Notes	Attenzione le dimensioni non includono la guarnizione / Attention the dimensions do not include the gasket	
Codice / Code	8601491000	mm	inch	Codice / Code	8601501500	mm	inch
	Altezza / Height	150	5,91		Altezza / Height	150	5,91
	Larghezza / Width	350	13,78		Larghezza / Width	450	17,72
	Lunghezza / Length	450	17,72		Lunghezza / Length	475	18,70
	Tipo mezzo filtrante Filter media type	Cellulosa / Cellulose			Tipo mezzo filtrante Filter media type	Cellulosa / Cellulose	
	Telaio / Frame	Metallo / Metal			Telaio / Frame	Metallo / Metal	
	Stile / Style	Pannello Rettangolare / Rectangular Panel			Stile / Style	Pannello Rettangolare / Rectangular Panel	
	Tipo / Type	-			Tipo / Type	-	
	Note / Notes	Attenzione le dimensioni non includono la guarnizione / Attention the dimensions do not include the gasket			Note / Notes	Attenzione le dimensioni non includono la guarnizione / Attention the dimensions do not include the gasket	
Codice / Code	8601544100	mm	inch	Codice / Code	8601547000	mm	inch
	Altezza / Height	48	1,89		Altezza / Height	60	2,36
	Larghezza / Width	210	8,27		Larghezza / Width	497	19,57
	Lunghezza / Length	210	8,27		Lunghezza / Length	497	19,57
	Tipo mezzo filtrante Filter media type	Cellulosa / Cellulose			Tipo mezzo filtrante Filter media type	Cellulosa / Cellulose	
	Telaio / Frame	Vello -Poliuretano / Fleece - Polyuretane			Telaio / Frame	Metallo / Metal	
	Stile / Style	Pannello Rettangolare / Rectangular Panel			Stile / Style	Pannello Rettangolare / Rectangular Panel	
	Tipo / Type	-			Tipo / Type	-	
Codice / Code	8601566000	mm	inch	Codice / Code	8601567100	mm	inch
	Altezza / Height	21	0,83		Altezza / Height	57,5	2,26
	Larghezza / Width	75	2,95		Larghezza / Width	179,5	7,07
	Lunghezza / Length	75	2,95		Lunghezza / Length	278	10,94
	Tipo mezzo filtrante Filter media type	Elemento filtrante metallico Metallic filter element			Tipo mezzo filtrante Filter media type	Cellulosa / Cellulose	
	Telaio / Frame	Metallo / Metal			Telaio / Frame	Vello -Poliuretano / Fleece - Polyuretane	
	Stile / Style	Pannello Rettangolare / Rectangular Panel			Stile / Style	Pannello Rettangolare / Rectangular Panel	
	Tipo / Type	-			Tipo / Type	-	
	Note / Notes	Attenzione le dimensioni non includono la guarnizione / Attention the dimensions do not include the gasket			Note / Notes	-	
Codice / Code	8601567700	mm	inch	Codice / Code	8601568000	mm	inch
	Altezza / Height	56	2,20		Altezza / Height	30,5	1,20
	Larghezza / Width	609	23,98		Larghezza / Width	123,5	4,86
	Lunghezza / Length	609	23,98		Lunghezza / Length	323	12,72
	Tipo mezzo filtrante Filter media type	Cellulosa / Cellulose			Tipo mezzo filtrante Filter media type	Cellulosa / Cellulose	
	Telaio / Frame	Metallo / Metal			Telaio / Frame	Metallo / Metal	
	Stile / Style	Pannello Rettangolare / Rectangular Panel			Stile / Style	Pannello Rettangolare / Rectangular Panel	
	Tipo / Type	-			Tipo / Type	Filtro cabina / Cab filter	
	Note / Notes	Attenzione le dimensioni non includono la guarnizione / Attention the dimensions do not include the gasket			Note / Notes	-	

Codice / Code	8601568800	mm	inch
	Altezza / Height	55	2,17
	Larghezza / Width	110	4,33
	Lunghezza / Length	602	23,70
	Tipo mezzo filtrante Filter media type	Cellulosa / Cellulose	
	Telaio / Frame	Vello -Poliuretano / Fleece - Polyuretane	
	Stile / Style	Pannello Rettangolare / Rectangular Panel	
	Tipo / Type	-	

Codice / Code	8601569000	mm	inch
	Altezza / Height	60	2,36
	Larghezza / Width	172	6,77
	Lunghezza / Length	602	23,70
	Tipo mezzo filtrante Filter media type	Cellulosa / Cellulose	
	Telaio / Frame	Vello -Poliuretano / Fleece - Polyuretane	
	Stile / Style	Pannello Rettangolare / Rectangular Panel	
	Tipo / Type	-	

Codice / Code	8601569300	mm	inch
	Altezza / Height	80	3,15
	Larghezza / Width	172	6,77
	Lunghezza / Length	597	23,50
	Tipo mezzo filtrante Filter media type	Cellulosa / Cellulose	
	Telaio / Frame	Vello -Poliuretano / Fleece - Polyuretane	
	Stile / Style	Pannello Rettangolare / Rectangular Panel	
	Tipo / Type	-	

Codice / Code	8601569900	mm	inch
	Altezza / Height	70	2,76
	Larghezza / Width	278	10,94
	Lunghezza / Length	320	12,60
	Tipo mezzo filtrante Filter media type	Cellulosa / Cellulose	
	Telaio / Frame	Vello -Poliuretano / Fleece - Polyuretane	
	Stile / Style	Pannello Rettangolare / Rectangular Panel	
	Tipo / Type	-	

Codice / Code	8601570000	mm	inch
	Altezza / Height	80	3,15
	Larghezza / Width	278	10,94
	Lunghezza / Length	320	12,60
	Tipo mezzo filtrante Filter media type	Cellulosa / Cellulose - Bulpren	
	Telaio / Frame	Vello -Poliuretano / Fleece - Polyuretane	
	Stile / Style	Pannello Rettangolare / Rectangular Panel	
	Tipo / Type	-	
Note / Notes	-		









Codice / Code	8601570100	mm	inch
	Altezza / Height	50	1,97
	Larghezza / Width	104	4,09
	Lunghezza / Length	520	20,47
	Tipo mezzo filtrante Filter media type	Cellulosa / Cellulose	
	Telaio / Frame	Metallo / Metal	
	Stile / Style	Pannello Rettangolare / Rectangular Panel	
	Tipo / Type	-	
Note / Notes	Attenzione le dimensioni non includono la guarnizione / Attention the dimensions do not include the gasket		











Codice / Code	8601585600	mm	inch
	Altezza / Height	21	0,83
	Larghezza / Width	112	4,41
	Lunghezza / Length	131	5,16
	Tipo mezzo filtrante Filter media type	Cellulosa / Cellulose	
	Telaio / Frame	Vello -Poliuretano / Fleece - Polyuretane	
	Stile / Style	Pannello Rettangolare / Rectangular Panel	
	Tipo / Type	-	







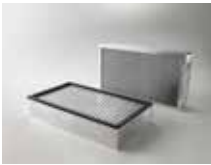
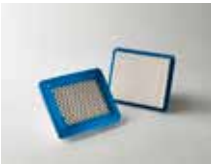

Codice / Code	8601585700	mm	inch
	Altezza / Height	47	1,85
	Larghezza / Width	88,5	3,48
	Lunghezza / Length	135	5,31
	Tipo mezzo filtrante Filter media type	Cellulosa / Cellulose	
	Telaio / Frame	Vello -Poliuretano / Fleece - Polyuretane	
	Stile / Style	Pannello Rettangolare / Rectangular Panel	
	Tipo / Type	-	

Codice / Code	8601589100	mm	inch
	Altezza / Height	61	2,40
	Larghezza / Width	135	5,31
	Lunghezza / Length	880	34,65
	Tipo mezzo filtrante Filter media type	Cellulosa / Cellulose	
	Telaio / Frame	Vello -Poliuretano / Fleece - Polyuretane	
	Stile / Style	Pannello Rettangolare / Rectangular Panel	
	Tipo / Type	-	

Codice / Code	8601618500	mm	inch
	Altezza / Height	56	2,20
	Larghezza / Width	116	4,57
	Lunghezza / Length	470	18,50
	Tipo mezzo filtrante Filter media type	Cellulosa / Cellulose	
	Telaio / Frame	Vello -Poliuretano / Fleece - Polyuretane	
	Stile / Style	Pannello Rettangolare / Rectangular Panel	
	Tipo / Type	Filtro cabina / Cab filter	

Codice / Code	8601673800	mm	inch	Codice / Code	8601680000	mm	inch
	Altezza / Height	51	2,01		Altezza / Height	51	2,01
	Larghezza / Width	179	7,05		Larghezza / Width	88	3,46
	Lunghezza / Length	183	7,20		Lunghezza / Length	89	3,50
	Tipo mezzo filtrante Filter media type	Cellulosa / Cellulose			Tipo mezzo filtrante Filter media type	Cellulosa / Cellulose	
	Telaio / Frame	Metallo / Metal			Telaio / Frame	Metallo / Metal	
	Stile / Style	Pannello Rettangolare / Rectangular Panel			Stile / Style	Pannello Rettangolare / Rectangular Panel	
	Tipo / Type	-			Tipo / Type	-	
Note / Notes	Attenzione le dimensioni non includono la guarnizione / Attention the dimensions do not include the gasket			Note / Notes	Attenzione le dimensioni non includono la guarnizione / Attention the dimensions do not include the gasket		
Codice / Code	8601680300	mm	inch	Codice / Code	8601680500	mm	inch
	Altezza / Height	51	2,01		Altezza / Height	21	0,83
	Larghezza / Width	142,5	5,61		Larghezza / Width	75	2,95
	Lunghezza / Length	142,5	5,61		Lunghezza / Length	75	2,95
	Tipo mezzo filtrante Filter media type	Cellulosa / Cellulose			Tipo mezzo filtrante Filter media type	Cellulosa / Cellulose	
	Telaio / Frame	Metallo / Metal			Telaio / Frame	Metallo / Metal	
	Stile / Style	Pannello Rettangolare / Rectangular Panel			Stile / Style	Pannello Rettangolare / Rectangular Panel	
	Tipo / Type	-			Tipo / Type	-	
Note / Notes	Attenzione le dimensioni non includono la guarnizione / Attention the dimensions do not include the gasket			Note / Notes	Attenzione le dimensioni non includono la guarnizione / Attention the dimensions do not include the gasket		
Codice / Code	8601689200	mm	inch	Codice / Code	8601701200	mm	inch
	Altezza / Height	55	2,17		Altezza / Height	48	1,89
	Larghezza / Width	110	4,33		Larghezza / Width	104	4,09
	Lunghezza / Length	602	23,70		Lunghezza / Length	520	20,47
	Tipo mezzo filtrante Filter media type	Cellulosa / Cellulose			Tipo mezzo filtrante Filter media type	Tessuto poliestere / Cloth Polyester	
	Telaio / Frame	Vello -Poliuretano / Fleece - Polyuretane			Telaio / Frame	Vello / Fleece	
	Stile / Style	Pannello Rettangolare / Rectangular Panel			Stile / Style	Pannello Rettangolare / Rectangular Panel	
	Tipo / Type	Filtro cabina / Cab filter			Tipo / Type	Filtro cabina / Cab filter	
Note / Notes	-			Note / Notes	Attenzione le dimensioni non includono la guarnizione / Attention the dimensions do not include the gasket		
Codice / Code	8601701300	mm	inch	Codice / Code	8601701400	mm	inch
	Altezza / Height	64	2,52		Altezza / Height	54	2,13
	Larghezza / Width	100	3,94		Larghezza / Width	116	4,57
	Lunghezza / Length	550	21,65		Lunghezza / Length	280	11,02
	Tipo mezzo filtrante Filter media type	Tessuto poliestere e poliuretano pre-schiurato / Cloth Polyester and pre-foam polyurethane			Tipo mezzo filtrante Filter media type	Tessuto poliestere e poliuretano pre-schiurato / Cloth Polyester and pre-foam polyurethane	
	Telaio / Frame	Vello -Poliuretano / Fleece - Polyuretane			Telaio / Frame	Vello -Poliuretano / Fleece - Polyuretane	
	Stile / Style	Pannello Rettangolare / Rectangular Panel			Stile / Style	Pannello Rettangolare / Rectangular Panel	
	Tipo / Type	Filtro cabina / Cab filter			Tipo / Type	Filtro cabina / Cab filter	
Note / Notes	Attenzione le dimensioni non includono la guarnizione / Attention the dimensions do not include the gasket			Note / Notes	Attenzione le dimensioni non includono la guarnizione / Attention the dimensions do not include the gasket		

Codice / Code	8601701600	mm	inch	Codice / Code	8601703600	mm	inch
	Altezza / Height	54	2,13		Altezza / Height	50	1,97
	Larghezza / Width	116	4,57		Larghezza / Width	130	5,12
	Lunghezza / Length	280	11,02		Lunghezza / Length	380	14,96
	Tipo mezzo filtrante Filter media type	Tessuto non tessuto sintetico attivato e poliuretano pre-schiumato Synthetic activated carbon nonwoven and pre-foam polyurethane			Tipo mezzo filtrante Filter media type	Tessuto poliestere e poliuretano pre-schiumato / Cloth Polyester and pre-foam polyurethane	
	Telaio / Frame	Vello -Poliuretano / Fleece - Polyuretane			Telaio / Frame	Vello -Poliuretano / Fleece - Polyuretane	
	Stile / Style	Pannello Rettangolare / Rectangular Panel			Stile / Style	Pannello Rettangolare / Rectangular Panel	
	Tipo / Type	Filtro cabina / Cab filter			Tipo / Type	Filtro cabina / Cab filter	
	Note / Notes	Attenzione le dimensioni non includono la guarnizione / Attention the dimensions do not include the gasket			Note / Notes	Attenzione le dimensioni non includono la guarnizione / Attention the dimensions do not include the gasket	
Codice / Code	8601705200	mm	inch	Codice / Code	8601716400	mm	inch
	Altezza / Height	50	1,97		Altezza / Height	65	2,56
	Larghezza / Width	130	5,12		Larghezza / Width	103	4,06
	Lunghezza / Length	380	14,96		Lunghezza / Length	650	25,59
	Tipo mezzo filtrante Filter media type	Tessuto non tessuto / Non-woven			Tipo mezzo filtrante Filter media type	Elemento filtrante a doppio stadio Two-stage filter element	
	Telaio / Frame	Vello -Poliuretano / Fleece - Polyuretane			Telaio / Frame	Plastica / Plastic	
	Stile / Style	Pannello Rettangolare / Rectangular Panel			Stile / Style	Pannello Rettangolare / Rectangular Panel	
	Tipo / Type	Filtro cabina / Cab filter			Tipo / Type	Filtro cabina / Cab filter	
	Note / Notes	Attenzione le dimensioni non includono la guarnizione / Attention the dimensions do not include the gasket			Note / Notes	Attenzione le dimensioni non includono la guarnizione / Attention the dimensions do not include the gasket	
Codice / Code	8601716500	mm	inch	Codice / Code	8601715900	mm	inch
	Altezza / Height	65	2,56		Altezza / Height	37	1,46
	Larghezza / Width	103	4,06		Larghezza / Width	75	2,95
	Lunghezza / Length	650	25,59		Lunghezza / Length	155	6,10
	Tipo mezzo filtrante Filter media type	Cellulosa / Cellulose			Tipo mezzo filtrante Filter media type	Tessuto non tessuto / Non-woven	
	Telaio / Frame	Plastica / Plastic			Telaio / Frame	Poliuretano / Polyuretane	
	Stile / Style	Pannello Rettangolare / Rectangular Panel			Stile / Style	Pannello Rettangolare / Rectangular Panel	
	Tipo / Type	Filtro cabina / Cab filter			Tipo / Type	Filtro cabina / Cab filter	
	Note / Notes	Attenzione le dimensioni non includono la guarnizione / Attention the dimensions do not include the gasket			Note / Notes	-	
Codice / Code	8601716600	mm	inch	Codice / Code	8601716700	mm	inch
	Altezza / Height	37	1,46		Altezza / Height	37	1,46
	Larghezza / Width	75	2,95		Larghezza / Width	75	2,95
	Lunghezza / Length	345	13,58		Lunghezza / Length	155	6,10
	Tipo mezzo filtrante Filter media type	Tessuto poliestere / Cloth Polyester			Tipo mezzo filtrante Filter media type	Tessuto poliestere / Cloth Polyester	
	Telaio / Frame	Poliuretano / Polyuretane			Telaio / Frame	Poliuretano / Polyuretane	
	Stile / Style	Pannello Rettangolare / Rectangular Panel			Stile / Style	Pannello Rettangolare / Rectangular Panel	
	Tipo / Type	Filtro cabina / Cab filter			Tipo / Type	Filtro cabina / Cab filter	
Codice / Code	8601716800	mm	inch	Codice / Code	8601717000	mm	inch
	Altezza / Height	37	1,46		Altezza / Height	65	2,56
	Larghezza / Width	75	2,95		Larghezza / Width	103	4,06
	Lunghezza / Length	345	13,58		Lunghezza / Length	650	25,59
	Tipo mezzo filtrante Filter media type	Tessuto non tessuto / Non-woven			Tipo mezzo filtrante Filter media type	Tessuto poliestere / Cloth Polyester	
	Telaio / Frame	Poliuretano / Polyuretane			Telaio / Frame	Plastica / Plastic	
	Stile / Style	Pannello Rettangolare / Rectangular Panel			Stile / Style	Pannello Rettangolare / Rectangular Panel	
	Tipo / Type	Filtro cabina / Cab filter			Tipo / Type	Filtro cabina / Cab filter	
	Note / Notes	-			Note / Notes	Attenzione le dimensioni non includono la guarnizione / Attention the dimensions do not include the gasket	

Codice / Code	8601721700	mm	inch	Codice / Code	8601725700	mm	inch
	Altezza / Height	50	1,97		Altezza / Height	26	1,02
	Larghezza / Width	70	2,76		Larghezza / Width	68,5	2,70
	Lunghezza / Length	650	25,59		Lunghezza / Length	85,5	3,37
	Tipo mezzo filtrante Filter media type	Elemento filtrante a tre stadi carbone attivo atossico / Three-stage filter element anti-toxic activated carbon			Tipo mezzo filtrante Filter media type	Cellulosa / Cellulose	
	Telaio / Frame	Metallo / Metal			Telaio / Frame	Vello -Poliuretano / Fleece - Polyuretane	
	Stile / Style	Pannello Rettangolare / Rectangular Panel			Stile / Style	Pannello Rettangolare / Rectangular Panel	
	Tipo / Type	Filtro cabina / Cab filter			Tipo / Type	-	
	Note / Notes	Attenzione le dimensioni non includono la guarnizione / Attention the dimensions do not include the gasket			Note / Notes	-	
Codice / Code	8601738300	mm	inch	Codice / Code	8601744300	mm	inch
	Altezza / Height	50	1,97		Altezza / Height	17	0,67
	Larghezza / Width	104	4,09		Larghezza / Width	84	3,31
	Lunghezza / Length	520	20,47		Lunghezza / Length	447	17,60
	Tipo mezzo filtrante Filter media type	Cellulosa / Cellulose			Tipo mezzo filtrante Filter media type	Tessuto non tessuto / Non-woven	
	Telaio / Frame	Metallo / Metal			Telaio / Frame	Plastica / Plastic	
	Stile / Style	Pannello Rettangolare / Rectangular Panel			Stile / Style	Pannello Rettangolare / Rectangular Panel	
	Tipo / Type	-			Tipo / Type	Filtro cabina / Cab filter	
	Note / Notes	Attenzione le dimensioni non includono la guarnizione / Attention the dimensions do not include the gasket			Note / Notes	Attenzione le dimensioni non includono la guarnizione / Attention the dimensions do not include the gasket	
Codice / Code	8601744400	mm	inch	Codice / Code	8601744800	mm	inch
	Altezza / Height	17	0,67		Altezza / Height	80	3,15
	Larghezza / Width	84	3,31		Larghezza / Width	119	4,69
	Lunghezza / Length	447	17,60		Lunghezza / Length	316	12,44
	Tipo mezzo filtrante Filter media type	Tessuto non tessuto / Non-woven			Tipo mezzo filtrante Filter media type	Tessuto poliestere / Cloth Polyester	
	Telaio / Frame	Plastica / Plastic			Telaio / Frame	Plastica - schiuma morbida Plastic - soft foam	
	Stile / Style	Pannello Rettangolare / Rectangular Panel			Stile / Style	Pannello Rettangolare / Rectangular Panel	
	Tipo / Type	Filtro cabina / Cab filter			Tipo / Type	Filtro cabina / Cab filter	
	Note / Notes	Attenzione le dimensioni non includono la guarnizione / Attention the dimensions do not include the gasket			Note / Notes	-	
Codice / Code	8601748000	mm	inch	Codice / Code	8601748300	mm	inch
	Altezza / Height	48	1,89		Altezza / Height	20	0,79
	Larghezza / Width	65	2,56		Larghezza / Width	80	3,15
	Lunghezza / Length	425	16,73		Lunghezza / Length	280	11,02
	Tipo mezzo filtrante Filter media type	Tessuto non tessuto / Non-woven			Tipo mezzo filtrante Filter media type	Tessuto non tessuto / Non-woven	
	Telaio / Frame	Vello / Fleece			Telaio / Frame	Vello / Fleece	
	Stile / Style	Pannello Rettangolare / Rectangular Panel			Stile / Style	Pannello Rettangolare / Rectangular Panel	
	Tipo / Type	Filtro cabina / Cab filter			Tipo / Type	Filtro cabina / Cab filter	
	Note / Notes	Attenzione le dimensioni non includono la guarnizione / Attention the dimensions do not include the gasket			Note / Notes	Attenzione le dimensioni non includono la guarnizione / Attention the dimensions do not include the gasket	
Codice / Code	8601748700	mm	inch	Codice / Code	8601776700	mm	inch
	Altezza / Height	20	0,79		Altezza / Height	40	1,57
	Larghezza / Width	100	3,94		Larghezza / Width	181,5	7,15
	Lunghezza / Length	417	16,42		Lunghezza / Length	403	15,87
	Tipo mezzo filtrante Filter media type	Fibra di poliestere / Polyester fiber			Tipo mezzo filtrante Filter media type	Tessuto non tessuto / Non-woven	
	Telaio / Frame	Vello / Fleece			Telaio / Frame	Cartone bianco / Cardboard white	
	Stile / Style	Pannello Rettangolare / Rectangular Panel			Stile / Style	Pannello Rettangolare / Rectangular Panel	
	Tipo / Type	Filtro cabina / Cab filter			Tipo / Type	Filtro cabina / Cab filter	
	Note / Notes	Attenzione le dimensioni non includono la guarnizione / Attention the dimensions do not include the gasket			Note / Notes	-	

Codice / Code	8601784200	mm	inch
	Altezza / Height	40	1,57
	Larghezza / Width	281	11,06
	Lunghezza / Length	316	12,44
	Tipo mezzo filtrante Filter media type	Tessuto non tessuto / Non-woven	
	Telaio / Frame	Plastica / Plastic	
	Stile / Style	Pannello Rettangolare / Rectangular Panel	
	Tipo / Type	-	
Note / Notes	Attenzione le dimensioni non includono la guarnizione / Attention the dimensions do not include the gasket		

Codice / Code	8601784700	mm	inch
	Altezza / Height	15	0,59
	Larghezza / Width	195	7,68
	Lunghezza / Length	300	11,81
	Tipo mezzo filtrante Filter media type	Tessuto poliestere / Cloth Polyester	
	Telaio / Frame	Cartone bianco / Cardboard white	
	Stile / Style	Pannello Rettangolare / Rectangular Panel	
	Tipo / Type	-	
Note / Notes	Attenzione le dimensioni non includono la guarnizione / Attention the dimensions do not include the gasket		

Codice / Code	8601751700	mm	inch
	Altezza / Height	51	2,01
	Larghezza / Width	249	9,80
	Lunghezza / Length	378	14,88
	Tipo mezzo filtrante Filter media type	Tessuto poliestere / Cloth Polyester	
	Telaio / Frame	Vello / Fleece	
	Stile / Style	Pannello Rettangolare / Rectangular Panel	
	Tipo / Type	Filtro cabina / Cab filter	
Note / Notes	-		







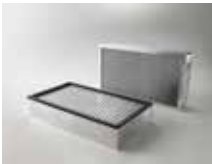

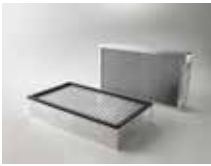

Codice / Code	8601752500	mm	inch
	Altezza / Height	40	1,57
	Larghezza / Width	275	10,83
	Lunghezza / Length	404	15,91
	Tipo mezzo filtrante Filter media type	Tessuto poliestere / Cloth Polyester	
	Telaio / Frame	Vello / Fleece	
	Stile / Style	Pannello Rettangolare / Rectangular Panel	
	Tipo / Type	Filtro cabina / Cab filter	
Note / Notes	Attenzione le dimensioni non includono la guarnizione / Attention the dimensions do not include the gasket		

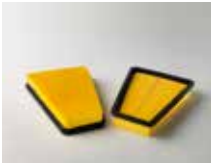









Codice / Code	8601753400	mm	inch
	Altezza / Height	50	1,97
	Larghezza / Width	104	4,09
	Lunghezza / Length	520	20,47
	Tipo mezzo filtrante Filter media type	Elemento filtrante a tre stadi carbone attivo atossico / Three-stage filter element anti-toxic activated carbon	
	Telaio / Frame	Metallo / Metal	
	Stile / Style	Pannello Rettangolare / Rectangular Panel	
	Tipo / Type	-	
Note / Notes	Attenzione le dimensioni non includono la guarnizione / Attention the dimensions do not include the gasket		











Codice / Code	8601755500	mm	inch
	Altezza / Height	17	0,67
	Larghezza / Width	165	6,50
	Lunghezza / Length	240	9,45
	Tipo mezzo filtrante Filter media type	Tessuto non tessuto / Non-woven	
	Telaio / Frame	Plastica / Plastic	
	Stile / Style	Pannello Rettangolare / Rectangular Panel	
	Tipo / Type	Filtro cabina / Cab filter	
Note / Notes	Attenzione le dimensioni non includono la guarnizione / Attention the dimensions do not include the gasket		

Codice / Code	8601756100	mm	inch
	Altezza / Height	56	2,20
	Larghezza / Width	245	9,65
	Lunghezza / Length	700	27,56
	Tipo mezzo filtrante Filter media type	Elemento filtrante a tre stadi carbone attivo atossico / Three-stage filter element anti-toxic activated carbon	
	Telaio / Frame	Metallo / Metal	
	Stile / Style	Pannello Rettangolare / Rectangular Panel	
	Tipo / Type	Filtro cabina / Cab filter	
Note / Notes	Attenzione le dimensioni non includono la guarnizione / Attention the dimensions do not include the gasket		

Codice / Code	8601756200	mm	inch
	Altezza / Height	56	2,20
	Larghezza / Width	245	9,65
	Lunghezza / Length	700	27,56
	Tipo mezzo filtrante Filter media type	Fibra di poliestere / Polyester fiber	
	Telaio / Frame	Metallo / Metal	
	Stile / Style	Pannello Rettangolare / Rectangular Panel	
	Tipo / Type	Filtro cabina / Cab filter	
Note / Notes	Attenzione le dimensioni non includono la guarnizione / Attention the dimensions do not include the gasket		

Codice / Code	8601756900	mm	inch	Codice / Code	8601757100	mm	inch
	Altezza / Height	55	2,17		Altezza / Height	51	2,01
	Larghezza / Width	80	3,15		Larghezza / Width	99	3,90
	Lunghezza / Length	425	16,73		Lunghezza / Length	399	15,71
	Tipo mezzo filtrante Filter media type	Elemento filtrante a tre stadi carbone attivo atossico / Three-stage filter element anti-toxic activated carbon			Tipo mezzo filtrante Filter media type	Cellulosa / Cellulose	
	Telaio / Frame	Metallo / Metal			Telaio / Frame	Plastica / Plastic	
	Stile / Style	Pannello Rettangolare / Rectangular Panel			Stile / Style	Pannello Rettangolare / Rectangular Panel	
	Tipo / Type	Filtro cabina / Cab filter			Tipo / Type	Filtro cabina / Cab filter	
	Note / Notes	Attenzione le dimensioni non includono la guarnizione / Attention the dimensions do not include the gasket			Note / Notes	Attenzione le dimensioni non includono la guarnizione / Attention the dimensions do not include the gasket	
Codice / Code	8601761100	mm	inch	Codice / Code	8601762900	mm	inch
	Altezza / Height	32	1,26		Altezza / Height	38	1,50
	Larghezza / Width	-	-		Larghezza / Width	100	3,94
	Lunghezza / Length	207	8,15		Lunghezza / Length	470	18,50
	Tipo mezzo filtrante Filter media type	Cellulosa / Cellulose			Tipo mezzo filtrante Filter media type	Tessuto poliestere / Cloth Polyester	
	Telaio / Frame	Vello -Poliuretano / Fleece - Polyuretane			Telaio / Frame	Plastica / Plastic	
	Stile / Style	Pannello Trapezoidale / Trapezoidal panel			Stile / Style	Pannello Rettangolare / Rectangular Panel	
	Tipo / Type	Filtro cabina / Cab filter			Tipo / Type	Filtro cabina / Cab filter	
	Note / Notes	-			Note / Notes	Attenzione le dimensioni non includono la guarnizione / Attention the dimensions do not include the gasket	
Codice / Code	8601763000	mm	inch	Codice / Code	8601763100	mm	inch
	Altezza / Height	17	0,67		Altezza / Height	17	0,67
	Larghezza / Width	157	6,18		Larghezza / Width	142	5,59
	Lunghezza / Length	343	13,50		Lunghezza / Length	461,5	18,17
	Tipo mezzo filtrante Filter media type	Tessuto non tessuto / Non-woven			Tipo mezzo filtrante Filter media type	Tessuto poliestere / Cloth Polyester	
	Telaio / Frame	Plastica / Plastic			Telaio / Frame	Plastica / Plastic	
	Stile / Style	Pannello Rettangolare / Rectangular Panel			Stile / Style	Pannello Rettangolare / Rectangular Panel	
	Tipo / Type	Filtro cabina / Cab filter			Tipo / Type	Filtro cabina / Cab filter	
	Note / Notes	Attenzione le dimensioni non includono la guarnizione / Attention the dimensions do not include the gasket			Note / Notes	Attenzione le dimensioni non includono la guarnizione / Attention the dimensions do not include the gasket	
Codice / Code	8601763200	mm	inch	Codice / Code	8601763300	mm	inch
	Altezza / Height	40	1,57		Altezza / Height	50	1,97
	Larghezza / Width	110	4,33		Larghezza / Width	119	4,69
	Lunghezza / Length	466	18,35		Lunghezza / Length	494	19,45
	Tipo mezzo filtrante Filter media type	Tessuto poliestere / Cloth Polyester			Tipo mezzo filtrante Filter media type	Tessuto poliestere / Cloth Polyester	
	Telaio / Frame	Vello / Fleece			Telaio / Frame	Vello / Fleece	
	Stile / Style	Pannello Rettangolare / Rectangular Panel			Stile / Style	Pannello Rettangolare / Rectangular Panel	
	Tipo / Type	Filtro cabina / Cab filter			Tipo / Type	Filtro cabina / Cab filter	
	Note / Notes	Attenzione le dimensioni non includono la guarnizione / Attention the dimensions do not include the gasket			Note / Notes	Attenzione le dimensioni non includono la guarnizione / Attention the dimensions do not include the gasket	
Codice / Code	8601764400	mm	inch	Codice / Code	8601775700	mm	inch
	Altezza / Height	58	2,28		Altezza / Height	50	1,97
	Larghezza / Width	142	5,59		Larghezza / Width	140	5,51
	Lunghezza / Length	275	10,83		Lunghezza / Length	420	16,54
	Tipo mezzo filtrante Filter media type	Cellulosa / Cellulose			Tipo mezzo filtrante Filter media type	Cellulosa / Cellulose	
	Telaio / Frame	Vello -Poliuretano / Fleece - Polyuretane			Telaio / Frame	Metallo / Metal	
	Stile / Style	Pannello Rettangolare / Rectangular Panel			Stile / Style	Pannello Rettangolare / Rectangular Panel	
	Tipo / Type	-			Tipo / Type	-	

Codice / Code	8601781600	mm	inch	Codice / Code	8601781700	mm	inch
	Altezza / Height	30	1,18		Altezza / Height	17	0,67
	Larghezza / Width	180	7,09		Larghezza / Width	102	4,02
	Lunghezza / Length	410	16,14		Lunghezza / Length	834	32,83
	Tipo mezzo filtrante Filter media type	Cellulosa / Cellulose			Tipo mezzo filtrante Filter media type	Tessuto poliestere / Cloth Polyester	
	Telaio / Frame	Cartone bianco / Cardboard white			Telaio / Frame	Plastica / Plastic	
	Stile / Style	Pannello Rettangolare / Rectangular Panel			Stile / Style	Pannello Rettangolare / Rectangular Panel	
	Tipo / Type	Filtro cabina / Cab filter			Tipo / Type	Filtro cabina / Cab filter	
	Note / Notes	Attenzione le dimensioni non includono la guarnizione / Attention the dimensions do not include the gasket			Note / Notes	Attenzione le dimensioni non includono la guarnizione / Attention the dimensions do not include the gasket	
Codice / Code	8601783800	mm	inch	Codice / Code	8601784400	mm	inch
	Altezza / Height	57	2,24		Altezza / Height	37,5	1,48
	Larghezza / Width	150	5,91		Larghezza / Width	174	6,85
	Lunghezza / Length	256	10,08		Lunghezza / Length	510	20,08
	Tipo mezzo filtrante Filter media type	Cellulosa / Cellulose			Tipo mezzo filtrante Filter media type	Cellulosa / Cellulose	
	Telaio / Frame	Vello -Poliuretano / Fleece - Polyuretane			Telaio / Frame	Vello -Poliuretano / Fleece - Polyuretane	
	Stile / Style	Pannello Rettangolare / Rectangular Panel			Stile / Style	Pannello Rettangolare / Rectangular Panel	
	Tipo / Type	Filtro cabina / Cab filter			Tipo / Type	-	
Codice / Code	8601784600	mm	inch	Codice / Code	8601792400	mm	inch
	Altezza / Height	27	1,06		Altezza / Height	47	1,85
	Larghezza / Width	106	4,17		Larghezza / Width	79	3,11
	Lunghezza / Length	224	8,82		Lunghezza / Length	490	19,29
	Tipo mezzo filtrante Filter media type	Cellulosa / Cellulose			Tipo mezzo filtrante Filter media type	Cellulosa / Cellulose	
	Telaio / Frame	-			Telaio / Frame	Vello -Poliuretano / Fleece - Polyuretane	
	Stile / Style	Pannello Rettangolare / Rectangular Panel			Stile / Style	Pannello Rettangolare / Rectangular Panel	
	Tipo / Type	-			Tipo / Type	Filtro cabina / Cab filter	
	Note / Notes	Attenzione le dimensioni non includono la guarnizione / Attention the dimensions do not include the gasket			Note / Notes	-	
Codice / Code	8601793300	mm	inch	Codice / Code	8601793400	mm	inch
	Altezza / Height	15	0,59		Altezza / Height	40	1,57
	Larghezza / Width	64	2,52		Larghezza / Width	60	2,36
	Lunghezza / Length	514	20,24		Lunghezza / Length	470	18,50
	Tipo mezzo filtrante Filter media type	Tessuto non tessuto / Non-woven			Tipo mezzo filtrante Filter media type	Tessuto poliestere / Cloth Polyester	
	Telaio / Frame	Metallo / Metal			Telaio / Frame	Vello / Fleece	
	Stile / Style	Pannello Rettangolare / Rectangular Panel			Stile / Style	Pannello Curvo Destro Curved Panel Right	
	Tipo / Type	Filtro cabina / Cab filter			Tipo / Type	Filtro cabina / Cab filter	
	Note / Notes	Attenzione le dimensioni non includono la guarnizione / Attention the dimensions do not include the gasket			Note / Notes	Attenzione le dimensioni non includono la guarnizione / Attention the dimensions do not include the gasket	
Codice / Code	8601793500	mm	inch	Codice / Code	8601800500	mm	inch
	Altezza / Height	40	1,57		Altezza / Height	53	2,09
	Larghezza / Width	60	2,36		Larghezza / Width	131	5,16
	Lunghezza / Length	470	18,50		Lunghezza / Length	246	9,69
	Tipo mezzo filtrante Filter media type	Tessuto poliestere / Cloth Polyester			Tipo mezzo filtrante Filter media type	Tessuto non tessuto / Non-woven	
	Telaio / Frame	Vello / Fleece			Telaio / Frame	Metallo / Metal	
	Stile / Style	Pannello Curvo Sinistro Curved Panel Left			Stile / Style	Pannello Rettangolare / Rectangular Panel	
	Tipo / Type	Filtro cabina / Cab filter			Tipo / Type	Filtro cabina / Cab filter	
	Note / Notes	Attenzione le dimensioni non includono la guarnizione / Attention the dimensions do not include the gasket			Note / Notes	-	

Codice / Code	8601802600	mm	inch	Codice / Code	8601804400	mm	inch
	Altezza / Height	48	1,89		Altezza / Height	45	1,77
	Larghezza / Width	119	4,69		Larghezza / Width	194	7,64
	Lunghezza / Length	407	16,02		Lunghezza / Length	391	15,39
	Tipo mezzo filtrante Filter media type	Tessuto non tessuto sintetico attivato Synthetic activated carbon nonwoven			Tipo mezzo filtrante Filter media type	Cellulosa / Cellulose	
	Telaio / Frame	Vello -Poliuretano / Fleece - Polyuretane			Telaio / Frame	Poliuretano / Polyuretane	
	Stile / Style	Pannello Rettangolare / Rectangular Panel			Stile / Style	Pannello Rettangolare / Rectangular Panel	
Tipo / Type	Filtro cabina / Cab filter		Tipo / Type	Filtro cabina / Cab filter			
Note / Notes	Attenzione le dimensioni non includono la guarnizione / Attention the dimensions do not include the gasket		Note / Notes	-			
Codice / Code	8601806300	mm	inch	Codice / Code	8601806400	mm	inch
	Altezza / Height	55	2,17		Altezza / Height	56	2,20
	Larghezza / Width	158	6,22		Larghezza / Width	230	9,06
	Lunghezza / Length	700	27,56		Lunghezza / Length	700	27,56
	Tipo mezzo filtrante Filter media type	Carbone attivo / Activated carbon			Tipo mezzo filtrante Filter media type	Carbone attivo / Activated carbon	
	Telaio / Frame	Metallo / Metal			Telaio / Frame	Metallo / Metal	
	Stile / Style	Pannello Rettangolare / Rectangular Panel			Stile / Style	Pannello Rettangolare / Rectangular Panel	
Tipo / Type	Filtro cabina / Cab filter		Tipo / Type	Filtro cabina / Cab filter			
Note / Notes	Attenzione le dimensioni non includono la guarnizione / Attention the dimensions do not include the gasket		Note / Notes	Attenzione le dimensioni non includono la guarnizione / Attention the dimensions do not include the gasket			
Codice / Code	8601807300	mm	inch	Codice / Code	8601808400	mm	inch
	Altezza / Height	52	2,05		Altezza / Height	41	1,61
	Larghezza / Width	127,5	5,02		Larghezza / Width	230	9,06
	Lunghezza / Length	228,5	9,00		Lunghezza / Length	270	10,63
	Tipo mezzo filtrante Filter media type	Cellulosa / Cellulose			Tipo mezzo filtrante Filter media type	Cellulosa / Cellulose	
	Telaio / Frame	Poliuretano - Plastica Polyurethane - Plastic			Telaio / Frame	Poliuretano - Plastica Polyurethane - Plastic	
	Stile / Style	Pannello ovale / Oval Panel			Stile / Style	Pannello Rettangolare / Rectangular Panel	
Tipo / Type	Filtro Jokto / Jokto Filter		Tipo / Type	Filtro cabina / Cab filter			
Note / Notes	Maniglia inclusa sulla dimensione altezza Handle included on the height dimension		Note / Notes	-			
Codice / Code	8601810100	mm	inch	Codice / Code	8601810600	mm	inch
	Altezza / Height	31	1,22		Altezza / Height	80	3,15
	Larghezza / Width	335	13,19		Larghezza / Width	515	20,28
	Lunghezza / Length	365	14,37		Lunghezza / Length	760	29,92
	Tipo mezzo filtrante Filter media type	Tessuto non tessuto / Non-woven			Tipo mezzo filtrante Filter media type	Cellulosa / Cellulose	
	Telaio / Frame	Vello -Poliuretano / Fleece - Polyuretane			Telaio / Frame	Metallo / Metal	
	Stile / Style	Pannello Rettangolare / Rectangular Panel			Stile / Style	Pannello Rettangolare / Rectangular Panel	
Tipo / Type	Filtro cabina / Cab filter		Tipo / Type	Filtro cabina / Cab filter			
Note / Notes	Attenzione le dimensioni non includono la guarnizione / Attention the dimensions do not include the gasket		Note / Notes	Attenzione le dimensioni non includono la guarnizione / Attention the dimensions do not include the gasket			
Codice / Code	8601811500	mm	inch	Codice / Code	8601811600	mm	inch
	Altezza / Height	56	2,20		Altezza / Height	66	2,60
	Larghezza / Width	158	6,22		Larghezza / Width	128	5,04
	Lunghezza / Length	700	27,56		Lunghezza / Length	740	29,13
	Tipo mezzo filtrante Filter media type	Fibra di poliestere / Polyesther fiber			Tipo mezzo filtrante Filter media type	Cellulosa / Cellulose	
	Telaio / Frame	Metallo / Metal			Telaio / Frame	Metallo / Metal	
	Stile / Style	Pannello Rettangolare / Rectangular Panel			Stile / Style	Pannello Rettangolare / Rectangular Panel	
Tipo / Type	Filtro cabina / Cab filter		Tipo / Type	Filtro cabina / Cab filter			
Note / Notes	Attenzione le dimensioni non includono la guarnizione / Attention the dimensions do not include the gasket		Note / Notes	Attenzione le dimensioni non includono la guarnizione / Attention the dimensions do not include the gasket			

Codice / Code	8601812100	mm	inch
	Altezza / Height	51	2,01
	Larghezza / Width	142	5,59
	Lunghezza / Length	437	17,20
	Tipo mezzo filtrante Filter media type	Cellulosa / Cellulose	
	Telaio / Frame	Metallo / Metal	
Stile / Style	Pannello Rettangolare / Rectangular Panel		
Tipo / Type	Filtro cabina / Cab filter		
Note / Notes	Attenzione le dimensioni non includono la guarnizione / Attention the dimensions do not include the gasket		

Codice / Code	8601813500	mm	inch
	Altezza / Height	50	1,97
	Larghezza / Width	70	2,76
	Lunghezza / Length	662	26,06
	Tipo mezzo filtrante Filter media type	Cellulosa / Cellulose	
	Telaio / Frame	Metallo / Metal	
Stile / Style	Pannello Rettangolare / Rectangular Panel		
Tipo / Type	Filtro cabina / Cab filter		
Note / Notes	Attenzione le dimensioni non includono la guarnizione / Attention the dimensions do not include the gasket		

Codice / Code	8601817300	mm	inch
	Altezza / Height	58	2,28
	Larghezza / Width	123	4,84
	Lunghezza / Length	472	18,58
	Tipo mezzo filtrante Filter media type	Cellulosa / Cellulose	
	Telaio / Frame	Vello -Poliuretano / Fleece - Polyuretane	
Stile / Style	Pannello Rettangolare / Rectangular Panel		
Tipo / Type	Filtro cabina / Cab filter		

Codice / Code	8601817400	mm	inch
	Altezza / Height	63,5	2,50
	Larghezza / Width	263	10,35
	Lunghezza / Length	360	14,17
	Tipo mezzo filtrante Filter media type	Cellulosa / Cellulose	
	Telaio / Frame	Vello -Poliuretano / Fleece - Polyuretane	
Stile / Style	Pannello Rettangolare / Rectangular Panel		
Tipo / Type	-		

Codice / Code	8601820300	mm	inch
	Altezza / Height	20	0,79
	Larghezza / Width	110	4,33
	Lunghezza / Length	429	16,89
	Tipo mezzo filtrante Filter media type	Tessuto poliestere / Cloth Polyester	
	Telaio / Frame	Vello / Fleece	
Stile / Style	Pannello Rettangolare / Rectangular Panel		
Tipo / Type	Filtro cabina / Cab filter		
Note / Notes	Attenzione le dimensioni non includono la guarnizione / Attention the dimensions do not include the gasket		

Codice / Code	8601823500	mm	inch
	Altezza / Height	87	3,43
	Larghezza / Width	103	4,06
	Lunghezza / Length	610	24,02
	Tipo mezzo filtrante Filter media type	Cellulosa / Cellulose	
	Telaio / Frame	Vello -Poliuretano / Fleece - Polyuretane	
Stile / Style	Pannello Rettangolare / Rectangular Panel		
Tipo / Type	-		
Note / Notes	-		

Codice / Code	8601832700	mm	inch
	Altezza / Height	51	2,01
	Larghezza / Width	99	3,90
	Lunghezza / Length	399	15,71
	Tipo mezzo filtrante Filter media type	Tessuto poliestere / Carbone attivo Cloth Polyester / Actived carbon	
	Telaio / Frame	Plastica / Plastic	
Stile / Style	Pannello Rettangolare / Rectangular Panel		
Tipo / Type	Filtro cabina / Cab filter		
Note / Notes	Attenzione le dimensioni non includono la guarnizione / Attention the dimensions do not include the gasket		

Codice / Code	8601834100	mm	inch
	Altezza / Height	38	1,50
	Larghezza / Width	157	6,18
	Lunghezza / Length	280	11,02
	Tipo mezzo filtrante Filter media type	Tessuto poliestere / Cloth Polyester	
	Telaio / Frame	Vello / Fleece	
Stile / Style	Pannello Rettangolare / Rectangular Panel		
Tipo / Type	Filtro cabina / Cab filter		
Note / Notes	Attenzione le dimensioni non includono la guarnizione / Attention the dimensions do not include the gasket		

Codice / Code	8601834700	mm	inch
	Altezza / Height	51	2,01
	Larghezza / Width	99	3,90
	Lunghezza / Length	399	15,71
	Tipo mezzo filtrante Filter media type	Tessuto non tessuto / Non-woven	
	Telaio / Frame	Plastica / Plastic	
Stile / Style	Pannello Rettangolare / Rectangular Panel		
Tipo / Type	Filtro cabina / Cab filter		
Note / Notes	Attenzione le dimensioni non includono la guarnizione / Attention the dimensions do not include the gasket		

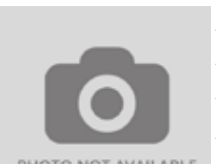
Codice / Code	8601835000	mm	inch
	Altezza / Height	20	0,79
	Larghezza / Width	149	5,87
	Lunghezza / Length	440	17,32
	Tipo mezzo filtrante Filter media type	Fibra di poliestere / Polyester fiber	
	Telaio / Frame	Vello / Fleece	
Stile / Style	Pannello Rettangolare / Rectangular Panel		
Tipo / Type	Filtro cabina / Cab filter		
Note / Notes	Attenzione le dimensioni non includono la guarnizione / Attention the dimensions do not include the gasket		

Codice / Code	8601835300	mm	inch
	Altezza / Height	29	1,14
	Larghezza / Width	238	9,37
	Lunghezza / Length	437	17,20
	Tipo mezzo filtrante Filter media type	Fibra di poliestere / Polyester fiber	
	Telaio / Frame	Vello / Fleece	
	Stile / Style	Pannello Rettangolare / Rectangular Panel	
	Tipo / Type	Filtro cabina / Cab filter	
Note / Notes	-		

Codice / Code	8601835500	mm	inch
	Altezza / Height	20	0,79
	Larghezza / Width	100	3,94
	Lunghezza / Length	417	16,42
	Tipo mezzo filtrante Filter media type	Tessuto non tessuto / Non-woven	
	Telaio / Frame	Vello / Fleece	
	Stile / Style	Pannello Rettangolare / Rectangular Panel	
	Tipo / Type	Filtro cabina / Cab filter	
Note / Notes	Attenzione le dimensioni non includono la guarnizione / Attention the dimensions do not include the gasket		

Codice / Code	8601835700	mm	inch
	Altezza / Height	20	0,79
	Larghezza / Width	179	7,05
	Lunghezza / Length	441	17,36
	Tipo mezzo filtrante Filter media type	Tessuto poliestere / Cloth Polyester	
	Telaio / Frame	Vello / Fleece	
	Stile / Style	Pannello Rettangolare / Rectangular Panel	
	Tipo / Type	Filtro cabina / Cab filter	
Note / Notes	Attenzione le dimensioni non includono la guarnizione / Attention the dimensions do not include the gasket		

Codice / Code	8601835800	mm	inch
	Altezza / Height	20	0,79
	Larghezza / Width	96	3,78
	Lunghezza / Length	413	16,26
	Tipo mezzo filtrante Filter media type	Tessuto non tessuto sintetico attivato Synthetic activated carbon nonwoven	
	Telaio / Frame	Vello / Fleece	
	Stile / Style	Pannello Rettangolare / Rectangular Panel	
	Tipo / Type	Filtro cabina / Cab filter	
Note / Notes	Attenzione le dimensioni non includono la guarnizione / Attention the dimensions do not include the gasket		

Codice / Code	8601836000	mm	inch
	Altezza / Height	56	2,20
	Larghezza / Width	140	5,51
	Lunghezza / Length	240	9,45
	Tipo mezzo filtrante Filter media type	Fibra di poliestere / Polyester fiber	
	Telaio / Frame	Vello -Poliuretano / Fleece - Polyuretane	
	Stile / Style	Pannello Rettangolare / Rectangular Panel	
	Tipo / Type	Filtro cabina / Cab filter	











Codice / Code	8601836400	mm	inch
	Altezza / Height	53	2,09
	Larghezza / Width	131	5,16
	Lunghezza / Length	246	9,69
	Tipo mezzo filtrante Filter media type	Cellulosa / Cellulose	
	Telaio / Frame	Vello -Poliuretano / Fleece - Polyuretane	
	Stile / Style	Pannello Rettangolare / Rectangular Panel	
	Tipo / Type	Filtro cabina / Cab filter	











Codice / Code	8601836800	mm	inch
	Altezza / Height	22	0,87
	Larghezza / Width	111	4,37
	Lunghezza / Length	120,5	4,74
	Tipo mezzo filtrante Filter media type	Fibra di poliestere / Polyester fiber	
	Telaio / Frame	Metallo / Metal	
	Stile / Style	Pannello Rettangolare / Rectangular Panel	
	Tipo / Type	-	
Note / Notes	Attenzione le dimensioni non includono la guarnizione / Attention the dimensions do not include the gasket		







Codice / Code	8601836900	mm	inch
	Altezza / Height	22	0,87
	Larghezza / Width	177,8	7,00
	Lunghezza / Length	273	10,75
	Tipo mezzo filtrante Filter media type	Tessuto poliestere / Cloth Polyester	
	Telaio / Frame	Metallo / Metal	
	Stile / Style	Pannello Rettangolare / Rectangular Panel	
	Tipo / Type	-	
Note / Notes	-		







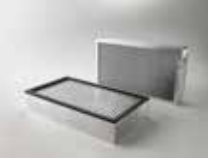
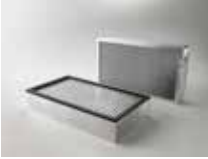
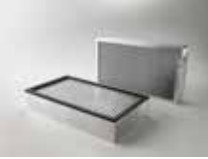



Codice / Code	8601838700	mm	inch
	Altezza / Height	20	0,79
	Larghezza / Width	250	9,84
	Lunghezza / Length	410	16,14
	Tipo mezzo filtrante Filter media type	Tessuto poliestere / Cloth Polyester	
	Telaio / Frame	Metallo / Metal	
	Stile / Style	Pannello Rettangolare / Rectangular Panel	
	Tipo / Type	-	
Note / Notes	Attenzione le dimensioni non includono la guarnizione / Attention the dimensions do not include the gasket		









Codice / Code	8601837700	mm	inch
	Altezza / Height	40	1,57
	Larghezza / Width	303	11,93
	Lunghezza / Length	376	14,80
	Tipo mezzo filtrante Filter media type	Tessuto non tessuto / Non-woven	
	Telaio / Frame	Plastica / Plastic	
	Stile / Style	Pannello Rettangolare / Rectangular Panel	
	Tipo / Type	Filtro cabina / Cab filter	
Note / Notes	Attenzione le dimensioni non includono la guarnizione / Attention the dimensions do not include the gasket		

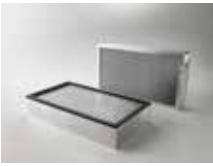

Codice / Code	8601839200	mm	inch	Codice / Code	8601839300	mm	inch
	Altezza / Height	30	1,18		Altezza / Height	18	0,71
	Larghezza / Width	180	7,09		Larghezza / Width	237	9,33
	Lunghezza / Length	408	16,06		Lunghezza / Length	300	11,81
	Tipo mezzo filtrante Filter media type	Fibra di poliestere / Polyester fiber			Tipo mezzo filtrante Filter media type	Feltro sintetico / Synthetic felt	
	Telaio / Frame	Vello / Fleece			Telaio / Frame	-	
	Stile / Style	Pannello Rettangolare / Rectangular Panel			Stile / Style	Pannello Rettangolare / Rectangular Panel	
	Tipo / Type	Filtro cabina / Cab filter			Tipo / Type	-	
	Note / Notes	Attenzione le dimensioni non includono la guarnizione / Attention the dimensions do not include the gasket			Note / Notes	-	
Codice / Code	8601839400	mm	inch	Codice / Code	8601839500	mm	inch
	Altezza / Height	13	0,51		Altezza / Height	42	1,65
	Larghezza / Width	88	3,46		Larghezza / Width	93	3,66
	Lunghezza / Length	628	24,72		Lunghezza / Length	174	6,85
	Tipo mezzo filtrante Filter media type	Bulpren (Colore nero) / (Black color)			Tipo mezzo filtrante Filter media type	Tessuto non tessuto / Non-woven	
	Telaio / Frame	-			Telaio / Frame	Vello / Fleece	
	Stile / Style	Pannello Rettangolare / Rectangular Panel			Stile / Style	Pannello Rettangolare / Rectangular Panel	
	Tipo / Type	-			Tipo / Type	Filtro cabina / Cab filter	
	Note / Notes	Attenzione le dimensioni non includono la guarnizione / Attention the dimensions do not include the gasket			Note / Notes	Attenzione le dimensioni non includono la guarnizione / Attention the dimensions do not include the gasket	
Codice / Code	8601839600	mm	inch	Codice / Code	8601839700	mm	inch
	Altezza / Height	15	0,59		Altezza / Height	12	0,47
	Larghezza / Width	181	7,13		Larghezza / Width	195	7,68
	Lunghezza / Length	356	14,02		Lunghezza / Length	451	17,76
	Tipo mezzo filtrante Filter media type	Feltro sintetico / Synthetic felt			Tipo mezzo filtrante Filter media type	Feltro sintetico / Synthetic felt	
	Telaio / Frame	-			Telaio / Frame	-	
	Stile / Style	Pannello Rettangolare / Rectangular Panel			Stile / Style	Pannello Rettangolare / Rectangular Panel	
	Tipo / Type	-			Tipo / Type	-	
Codice / Code	8601839800	mm	inch	Codice / Code	8601839900	mm	inch
	Altezza / Height	16	0,63		Altezza / Height	40	1,57
	Larghezza / Width	238	9,37		Larghezza / Width	194,5	7,66
	Lunghezza / Length	206	8,11		Lunghezza / Length	394,5	15,53
	Tipo mezzo filtrante Filter media type	Feltro sintetico / Synthetic felt			Tipo mezzo filtrante Filter media type	Tessuto non tessuto / Non-woven	
	Telaio / Frame	-			Telaio / Frame	Plastica / Plastic	
	Stile / Style	Pannello Rettangolare / Rectangular Panel			Stile / Style	Pannello Rettangolare / Rectangular Panel	
	Tipo / Type	-			Tipo / Type	Filtro cabina / Cab filter	
	Note / Notes	-			Note / Notes	Attenzione le dimensioni non includono la guarnizione / Attention the dimensions do not include the gasket	
Codice / Code	8601840800	mm	inch	Codice / Code	8601840900	mm	inch
	Altezza / Height	17	0,67		Altezza / Height	17	0,67
	Larghezza / Width	214	8,43		Larghezza / Width	78	3,07
	Lunghezza / Length	214	8,43		Lunghezza / Length	383	15,08
	Tipo mezzo filtrante Filter media type	Fibra di poliestere / Polyester fiber			Tipo mezzo filtrante Filter media type	Fibra di poliestere / Polyester fiber	
	Telaio / Frame	Vello / Fleece			Telaio / Frame	Cartone bianco / Cardboard white	
	Stile / Style	Pannello Rettangolare / Rectangular Panel			Stile / Style	Pannello Rettangolare / Rectangular Panel	
	Note / Notes	Attenzione le dimensioni non includono la guarnizione / Attention the dimensions do not include the gasket			Note / Notes	Attenzione le dimensioni non includono la guarnizione / Attention the dimensions do not include the gasket	

Codice / Code	8601841000	mm	inch	Codice / Code	8601841600	mm	inch
 PHOTO NOT AVAILABLE	Altezza / Height	17	0,67	 PHOTO NOT AVAILABLE	Altezza / Height	17	0,67
	Larghezza / Width	220	8,66		Larghezza / Width	132	5,20
	Lunghezza / Length	375	14,76		Lunghezza / Length	385	15,16
	Tipo mezzo filtrante Filter media type	Fibra di poliestere / Polyester fiber			Tipo mezzo filtrante Filter media type	Tessuto poliestere / Cloth Polyester	
	Telaio / Frame	Metallo / Metal			Telaio / Frame	Cartone bianco / Cardboard white	
	Stile / Style	Pannello Rettangolare / Rectangular Panel			Stile / Style	Pannello Rettangolare / Rectangular Panel	
Tipo / Type	-		Tipo / Type	-			
Note / Notes	Attenzione le dimensioni non includono la guarnizione / Attention the dimensions do not include the gasket			Note / Notes	Attenzione le dimensioni non includono la guarnizione / Attention the dimensions do not include the gasket		
Codice / Code	8601841800	mm	inch	Codice / Code	8601845000	mm	inch
	Altezza / Height	47	1,85		Altezza / Height	40	1,57
	Larghezza / Width	118	4,65		Larghezza / Width	150	5,91
	Lunghezza / Length	309	12,17		Lunghezza / Length	430	16,93
	Tipo mezzo filtrante Filter media type	Fibra di poliestere / Polyester fiber			Tipo mezzo filtrante Filter media type	Tessuto non tessuto / Non-woven	
	Telaio / Frame	Poliuretano / Polyuretane			Telaio / Frame	Plastica / Plastic	
	Stile / Style	Pannello Rettangolare / Rectangular Panel			Stile / Style	Pannello Rettangolare / Rectangular Panel	
Tipo / Type	-		Tipo / Type	Filtro cabina / Cab filter			
Note / Notes	-			Note / Notes	Attenzione le dimensioni non includono la guarnizione / Attention the dimensions do not include the gasket		
Codice / Code	8601847400	mm	inch	Codice / Code	8601848800	mm	inch
	Altezza / Height	56	2,20	 PHOTO NOT AVAILABLE	Altezza / Height	84	3,31
	Larghezza / Width	115	4,53		Larghezza / Width	369	14,53
	Lunghezza / Length	740	29,13		Lunghezza / Length	779	30,67
	Tipo mezzo filtrante Filter media type	Tessuto poliestere / Cloth Polyester			Tipo mezzo filtrante Filter media type	Tessuto poliestere / Cloth Polyester	
	Telaio / Frame	Metallo / Metal			Telaio / Frame	Metallo / Metal	
	Stile / Style	Pannello Rettangolare / Rectangular Panel			Stile / Style	Pannello Rettangolare / Rectangular Panel	
Tipo / Type	-		Tipo / Type	-			
Note / Notes	Attenzione le dimensioni non includono la guarnizione / Attention the dimensions do not include the gasket			Note / Notes	Attenzione le dimensioni non includono la guarnizione / Attention the dimensions do not include the gasket		
Codice / Code	8601849800	mm	inch	Codice / Code	8601849900	mm	inch
	Altezza / Height	51	2,01	 PHOTO NOT AVAILABLE	Altezza / Height	37	1,46
	Larghezza / Width	99	3,90		Larghezza / Width	171	6,73
	Lunghezza / Length	399	15,71		Lunghezza / Length	342,5	13,48
	Tipo mezzo filtrante Filter media type	Tessuto non tessuto / Non-woven			Tipo mezzo filtrante Filter media type	Tessuto non tessuto / Non-woven	
	Telaio / Frame	Plastica / Plastic			Telaio / Frame	Cartone bianco / Cardboard white	
	Stile / Style	Pannello Rettangolare / Rectangular Panel			Stile / Style	Pannello Rettangolare / Rectangular Panel	
Tipo / Type	Filtro cabina / Cab filter		Tipo / Type	Filtro cabina / Cab filter			
Note / Notes	Attenzione le dimensioni non includono la guarnizione / Attention the dimensions do not include the gasket			Note / Notes	-		
Codice / Code	8601853600	mm	inch	Codice / Code	8601853700	mm	inch
	Altezza / Height	40	1,57		Altezza / Height	40	1,57
	Larghezza / Width	60	2,36		Larghezza / Width	60	2,36
	Lunghezza / Length	470	18,50		Lunghezza / Length	470	18,50
	Tipo mezzo filtrante Filter media type	Tessuto poliestere / Cloth Polyester			Tipo mezzo filtrante Filter media type	Tessuto poliestere / Cloth Polyester	
	Telaio / Frame	Vello / Fleece			Telaio / Frame	Vello / Fleece	
	Stile / Style	Pannello Curvo Destro Curved Panel Right			Stile / Style	Pannello Curvo Sinistro Curved Panel Left	
Tipo / Type	Filtro cabina / Cab filter		Tipo / Type	Filtro cabina / Cab filter			
Note / Notes	Attenzione le dimensioni non includono la guarnizione / Attention the dimensions do not include the gasket			Note / Notes	Attenzione le dimensioni non includono la guarnizione / Attention the dimensions do not include the gasket		

Codice / Code	8601855800	mm	inch	Codice / Code	8601856300	mm	inch
	Altezza / Height	20	0,79		Altezza / Height	37,5	1,48
	Larghezza / Width	180	7,09		Larghezza / Width	168	6,61
	Lunghezza / Length	218	8,58		Lunghezza / Length	400	15,75
	Tipo mezzo filtrante Filter media type	Tessuto non tessuto / Non-woven			Tipo mezzo filtrante Filter media type	Cellulosa / Cellulose	
	Telaio / Frame	Vello / Fleece			Telaio / Frame	Vello -Poliuretano / Fleece - Polyuretane	
	Stile / Style	Pannello Rettangolare / Rectangular Panel			Stile / Style	Pannello Rettangolare / Rectangular Panel	
	Tipo / Type	-			Tipo / Type	-	
	Note / Notes	Attenzione le dimensioni non includono la guarnizione / Attention the dimensions do not include the gasket			Note / Notes	-	
Codice / Code	8601856800	mm	inch	Codice / Code	8601856900	mm	inch
	Altezza / Height	17	0,67		Altezza / Height	50	1,97
	Larghezza / Width	110	4,33		Larghezza / Width	195	7,68
	Lunghezza / Length	309	12,17		Lunghezza / Length	420	16,54
	Tipo mezzo filtrante Filter media type	Fibra di poliestere / Polyester fiber			Tipo mezzo filtrante Filter media type	Tessuto poliestere / Cloth Polyester	
	Telaio / Frame	Metallo / Metal			Telaio / Frame	Cartone bianco / Cardboard white	
	Stile / Style	Pannello Rettangolare / Rectangular Panel			Stile / Style	Pannello Rettangolare / Rectangular Panel	
	Tipo / Type	Filtro cabina / Cab filter			Tipo / Type	Filtro cabina / Cab filter	
	Note / Notes	Attenzione le dimensioni non includono la guarnizione / Attention the dimensions do not include the gasket			Note / Notes	Attenzione le dimensioni non includono la guarnizione / Attention the dimensions do not include the gasket	
Codice / Code	8601857000	mm	inch	Codice / Code	8601857200	mm	inch
	Altezza / Height	55	2,17		Altezza / Height	50	1,97
	Larghezza / Width	100	3,94		Larghezza / Width	170	6,69
	Lunghezza / Length	590	23,23		Lunghezza / Length	300	11,81
	Tipo mezzo filtrante Filter media type	Tessuto non tessuto / Non-woven			Tipo mezzo filtrante Filter media type	Cellulosa / Cellulose	
	Telaio / Frame	Metallo / Metal			Telaio / Frame	Metallo / Metal	
	Stile / Style	Pannello Rettangolare / Rectangular Panel			Stile / Style	Pannello Rettangolare / Rectangular Panel	
	Tipo / Type	Filtro cabina / Cab filter			Tipo / Type	Filtro cabina / Cab filter	
	Note / Notes	-			Note / Notes	Attenzione le dimensioni non includono la guarnizione / Attention the dimensions do not include the gasket	
Codice / Code	8601857300	mm	inch	Codice / Code	8601857400	mm	inch
	Altezza / Height	50	1,97		Altezza / Height	56	2,20
	Larghezza / Width	170	6,69		Larghezza / Width	355	13,98
	Lunghezza / Length	300	11,81		Lunghezza / Length	400	15,75
	Tipo mezzo filtrante Filter media type	Elemento filtrante a doppio stadio Two-stage filter element			Tipo mezzo filtrante Filter media type	Cellulosa / Cellulose	
	Telaio / Frame	Metallo / Metal			Telaio / Frame	Metallo / Metal	
	Stile / Style	Pannello Rettangolare / Rectangular Panel			Stile / Style	Pannello Rettangolare / Rectangular Panel	
	Tipo / Type	Filtro cabina / Cab filter			Tipo / Type	Filtro cabina / Cab filter	
	Note / Notes	Attenzione le dimensioni non includono la guarnizione / Attention the dimensions do not include the gasket			Note / Notes	Attenzione le dimensioni non includono la guarnizione / Attention the dimensions do not include the gasket	
Codice / Code	8601857500	mm	inch	Codice / Code	8601857600	mm	inch
	Altezza / Height	56	2,20		Altezza / Height	82	3,23
	Larghezza / Width	130	5,12		Larghezza / Width	405	15,94
	Lunghezza / Length	500	19,69		Lunghezza / Length	610	24,02
	Tipo mezzo filtrante Filter media type	Cellulosa / Cellulose			Tipo mezzo filtrante Filter media type	Cellulosa / Cellulose	
	Telaio / Frame	Metallo / Metal			Telaio / Frame	Metallo / Metal	
	Stile / Style	Pannello Rettangolare / Rectangular Panel			Stile / Style	Pannello Rettangolare / Rectangular Panel	
	Tipo / Type	Filtro cabina / Cab filter			Tipo / Type	Filtro cabina / Cab filter	
	Note / Notes	Attenzione le dimensioni non includono la guarnizione / Attention the dimensions do not include the gasket			Note / Notes	Attenzione le dimensioni non includono la guarnizione / Attention the dimensions do not include the gasket	

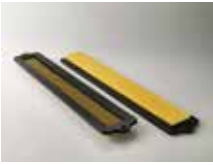

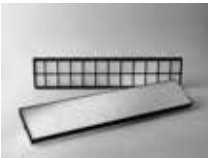
Codice / Code	8601855900	mm	inch	Codice / Code	8601857100	mm	inch
	Altezza / Height	37,5	1,48		Altezza / Height	58	2,28
	Larghezza / Width	174	6,85		Larghezza / Width	169	6,65
	Lunghezza / Length	500	19,69		Lunghezza / Length	343	13,50
	Tipo mezzo filtrante Filter media type	Cellulosa / Cellulose			Tipo mezzo filtrante Filter media type	Cellulosa / Cellulose	
	Telaio / Frame	Vello -Poliuretano / Fleece - Polyuretane			Telaio / Frame	Vello -Poliuretano / Fleece - Polyuretane	
	Stile / Style	Pannello Rettangolare / Rectangular Panel			Stile / Style	Pannello Rettangolare / Rectangular Panel	
Tipo / Type	-		Tipo / Type	-			
Codice / Code	8601858300	mm	inch	Codice / Code	8601858400	mm	inch
	Altezza / Height	56	2,20		Altezza / Height	56	2,20
	Larghezza / Width	130	5,12		Larghezza / Width	130	5,12
	Lunghezza / Length	400	15,75		Lunghezza / Length	400	15,75
	Tipo mezzo filtrante Filter media type	Cellulosa / Cellulose			Tipo mezzo filtrante Filter media type	Elemento filtrante a due stadi carbone attivo atossico / Two-stage filter element anti-toxic activated carbon	
	Telaio / Frame	Metallo / Metal			Telaio / Frame	Metallo / Metal	
	Stile / Style	Pannello Rettangolare / Rectangular Panel			Stile / Style	Pannello Rettangolare / Rectangular Panel	
Tipo / Type	Filtro cabina / Cab filter		Tipo / Type	Filtro cabina / Cab filter			
Note / Notes	Attenzione le dimensioni non includono la guarnizione / Attention the dimensions do not include the gasket		Note / Notes	Attenzione le dimensioni non includono la guarnizione / Attention the dimensions do not include the gasket			
Codice / Code	8601858500	mm	inch	Codice / Code	8601858700	mm	inch
	Altezza / Height	55	2,17		Altezza / Height	70	2,76
	Larghezza / Width	100	3,94		Larghezza / Width	240	9,45
	Lunghezza / Length	590	23,23		Lunghezza / Length	375	14,76
	Tipo mezzo filtrante Filter media type	Elemento filtrante a due stadi carbone attivo atossico / Two-stage filter element anti-toxic activated carbon			Tipo mezzo filtrante Filter media type	Cellulosa / Cellulose	
	Telaio / Frame	Metallo / Metal			Telaio / Frame	Vello -Poliuretano / Fleece - Polyuretane	
	Stile / Style	Pannello Rettangolare / Rectangular Panel			Stile / Style	Pannello Rettangolare / Rectangular Panel	
Tipo / Type	Filtro cabina / Cab filter		Tipo / Type	-			
Codice / Code	8601859200	mm	inch	Codice / Code	8601859400	mm	inch
	Altezza / Height	55	2,17		Altezza / Height	56	2,20
	Larghezza / Width	150	5,91		Larghezza / Width	100	3,94
	Lunghezza / Length	580	22,83		Lunghezza / Length	500	19,69
	Tipo mezzo filtrante Filter media type	Tessuto non tessuto / Non-woven			Tipo mezzo filtrante Filter media type	Cellulosa / Cellulose	
	Telaio / Frame	Metallo / Metal			Telaio / Frame	Metallo / Metal	
	Stile / Style	Pannello Rettangolare / Rectangular Panel			Stile / Style	Pannello Rettangolare / Rectangular Panel	
Tipo / Type	Filtro cabina / Cab filter		Tipo / Type	Filtro cabina / Cab filter			
Note / Notes	-		Note / Notes	Attenzione le dimensioni non includono la guarnizione / Attention the dimensions do not include the gasket			
Codice / Code	8601859500	mm	inch	Codice / Code	8601860000	mm	inch
	Altezza / Height	56	2,20		Altezza / Height	56	2,20
	Larghezza / Width	150	5,91		Larghezza / Width	355	13,98
	Lunghezza / Length	580	22,83		Lunghezza / Length	400	15,75
	Tipo mezzo filtrante Filter media type	Elemento filtrante a tre stadi carbone attivo atossico / Three-stage filter element anti-toxic activated carbon			Tipo mezzo filtrante Filter media type	Elemento filtrante a tre stadi carbone attivo atossico / Three-stage filter element anti-toxic activated carbon	
	Telaio / Frame	Metallo / Metal			Telaio / Frame	Metallo / Metal	
	Stile / Style	Pannello Rettangolare / Rectangular Panel			Stile / Style	Pannello Rettangolare / Rectangular Panel	
Tipo / Type	Filtro cabina / Cab filter		Tipo / Type	Filtro cabina / Cab filter			
Note / Notes	Attenzione le dimensioni non includono la guarnizione / Attention the dimensions do not include the gasket		Note / Notes	Attenzione le dimensioni non includono la guarnizione / Attention the dimensions do not include the gasket			

Codice / Code	8601860100	mm	inch	Codice / Code	8601860200	mm	inch
	Altezza / Height	56	2,20		Altezza / Height	56	2,20
	Larghezza / Width	130	5,12		Larghezza / Width	100	3,94
	Lunghezza / Length	500	19,69		Lunghezza / Length	500	19,69
	Tipo mezzo filtrante Filter media type	Elemento filtrante a tre stadi carbone attivo atossico / Three-stage filter element anti-toxic activated carbon			Tipo mezzo filtrante Filter media type	Elemento filtrante a tre stadi carbone attivo atossico / Three-stage filter element anti-toxic activated carbon	
	Telaio / Frame	Metallo / Metal			Telaio / Frame	Metallo / Metal	
	Stile / Style	Pannello Rettangolare / Rectangular Panel			Stile / Style	Pannello Rettangolare / Rectangular Panel	
	Tipo / Type	Filtro cabina / Cab filter			Tipo / Type	Filtro cabina / Cab filter	
	Note / Notes	Attenzione le dimensioni non includono la guarnizione / Attention the dimensions do not include the gasket			Note / Notes	Attenzione le dimensioni non includono la guarnizione / Attention the dimensions do not include the gasket	
Codice / Code	8601862100	mm	inch	Codice / Code	8601862400	mm	inch
	Altezza / Height	15	0,59		Altezza / Height	85	3,35
	Larghezza / Width	64	2,52		Larghezza / Width	100	3,94
	Lunghezza / Length	514	20,24		Lunghezza / Length	500	19,69
	Tipo mezzo filtrante Filter media type	Tessuto non tessuto / Non-woven			Tipo mezzo filtrante Filter media type	Cellulosa / Cellulose	
	Telaio / Frame	Metallo / Metal			Telaio / Frame	Metallo / Metal	
	Stile / Style	Pannello Rettangolare / Rectangular Panel			Stile / Style	Pannello Rettangolare / Rectangular Panel	
	Tipo / Type	Filtro cabina / Cab filter			Tipo / Type	Filtro cabina / Cab filter	
	Note / Notes	Attenzione le dimensioni non includono la guarnizione / Attention the dimensions do not include the gasket			Note / Notes	Attenzione le dimensioni non includono la guarnizione / Attention the dimensions do not include the gasket	
Codice / Code	8601863000	mm	inch	Codice / Code	8601864700	mm	inch
	Altezza / Height	42	1,65		Altezza / Height	20	0,79
	Larghezza / Width	109	4,29		Larghezza / Width	105	4,13
	Lunghezza / Length	190	7,48		Lunghezza / Length	262	10,31
	Tipo mezzo filtrante Filter media type	Tessuto poliestere / Cloth Polyester			Tipo mezzo filtrante Filter media type	Tessuto poliestere / Cloth Polyester	
	Telaio / Frame	Vello / Fleece			Telaio / Frame	Vello / Fleece	
	Stile / Style	Pannello Rettangolare / Rectangular Panel			Stile / Style	Pannello Rettangolare / Rectangular Panel	
	Tipo / Type	Filtro cabina / Cab filter			Tipo / Type	Filtro cabina / Cab filter	
	Note / Notes	Attenzione le dimensioni non includono la guarnizione / Attention the dimensions do not include the gasket			Note / Notes	Attenzione le dimensioni non includono la guarnizione / Attention the dimensions do not include the gasket	
Codice / Code	8601864800	mm	inch	Codice / Code	8601864900	mm	inch
	Altezza / Height	55	2,17		Altezza / Height	56	2,20
	Larghezza / Width	150	5,91		Larghezza / Width	158	6,22
	Lunghezza / Length	400	15,75		Lunghezza / Length	372	14,65
	Tipo mezzo filtrante Filter media type	Cellulosa / Cellulose			Tipo mezzo filtrante Filter media type	Cellulosa / Cellulose	
	Telaio / Frame	Metallo / Metal			Telaio / Frame	Vello -Poliuretano / Fleece - Polyuretane	
	Stile / Style	Pannello Rettangolare / Rectangular Panel			Stile / Style	Pannello Rettangolare / Rectangular Panel	
	Tipo / Type	-			Tipo / Type	-	
	Note / Notes	-			Note / Notes	-	
Codice / Code	8601865700	mm	inch	Codice / Code	8601865800	mm	inch
	Altezza / Height	22	0,87		Altezza / Height	25	0,98
	Larghezza / Width	124	4,88		Larghezza / Width	104	4,09
	Lunghezza / Length	357	14,06		Lunghezza / Length	556	21,89
	Tipo mezzo filtrante Filter media type	Cellulosa / Cellulose			Tipo mezzo filtrante Filter media type	Cellulosa / Cellulose	
	Telaio / Frame	Vello -Poliuretano / Fleece - Polyuretane			Telaio / Frame	Vello -Poliuretano / Fleece - Polyuretane	
	Stile / Style	Pannello Rettangolare / Rectangular Panel			Stile / Style	Pannello Rettangolare / Rectangular Panel	
	Tipo / Type	Filtro cabina / Cab filter			Tipo / Type	Filtro cabina / Cab filter	

Codice / Code	8601866600	mm	inch	Codice / Code	8601866900	mm	inch
	Altezza / Height	24	0,94		Altezza / Height	85	3,35
	Larghezza / Width	122,5	4,82		Larghezza / Width	100	3,94
	Lunghezza / Length	600	23,62		Lunghezza / Length	500	19,69
	Tipo mezzo filtrante Filter media type	Fibra di poliestere / Polyester fiber			Tipo mezzo filtrante Filter media type	Fibra di poliestere / Polyester fiber	
	Telaio / Frame	Plastica / Plastic			Telaio / Frame	Metallo / Metal	
	Stile / Style	Pannello Rettangolare / Rectangular Panel			Stile / Style	Pannello Rettangolare / Rectangular Panel	
	Tipo / Type	Filtro cabina / Cab filter			Tipo / Type	Filtro cabina / Cab filter	
Note / Notes	-		Note / Notes	Attenzione le dimensioni non includono la guarnizione / Attention the dimensions do not include the gasket			

Codice / Code	8601867100	mm	inch	Codice / Code	8601867800	mm	inch
	Altezza / Height	95	3,74		Altezza / Height	28	1,10
	Larghezza / Width	170	6,69		Larghezza / Width	347	13,66
	Lunghezza / Length	300	11,81		Lunghezza / Length	545	21,46
	Tipo mezzo filtrante Filter media type	Fibra di poliestere / Polyester fiber			Tipo mezzo filtrante Filter media type	Fibra di poliestere / Polyester fiber	
	Telaio / Frame	Metallo / Metal			Telaio / Frame	Metallo / Metal	
	Stile / Style	Pannello Rettangolare / Rectangular Panel			Stile / Style	Pannello Rettangolare / Rectangular Panel	
	Tipo / Type	Filtro cabina / Cab filter			Tipo / Type	Filtro cabina / Cab filter	
Note / Notes	Attenzione le dimensioni non includono la guarnizione / Attention the dimensions do not include the gasket		Note / Notes	Attenzione le dimensioni non includono la guarnizione / Attention the dimensions do not include the gasket			

Codice / Code	8601867900	mm	inch	Codice / Code	8601868000	mm	inch
	Altezza / Height	28	1,10		Altezza / Height	28	1,10
	Larghezza / Width	277	10,91		Larghezza / Width	231	9,09
	Lunghezza / Length	353	13,90		Lunghezza / Length	390	15,35
	Tipo mezzo filtrante Filter media type	Fibra di poliestere / Polyester fiber			Tipo mezzo filtrante Filter media type	Fibra di poliestere / Polyester fiber	
	Telaio / Frame	Metallo / Metal			Telaio / Frame	Metallo / Metal	
	Stile / Style	Pannello Rettangolare / Rectangular Panel			Stile / Style	Pannello Rettangolare / Rectangular Panel	
	Tipo / Type	Filtro cabina / Cab filter			Tipo / Type	Filtro cabina / Cab filter	
Note / Notes	Attenzione le dimensioni non includono la guarnizione / Attention the dimensions do not include the gasket		Note / Notes	Attenzione le dimensioni non includono la guarnizione / Attention the dimensions do not include the gasket			



Codice / Code	8601868100	mm	inch	Codice / Code	8601870300	mm	inch
	Altezza / Height	28	1,10		Altezza / Height	56	2,20
	Larghezza / Width	120	4,72		Larghezza / Width	140	5,51
	Lunghezza / Length	342	13,46		Lunghezza / Length	240	9,45
	Tipo mezzo filtrante Filter media type	Fibra di poliestere / Polyester fiber			Tipo mezzo filtrante Filter media type	Fibra di poliestere / Polyester fiber	
	Telaio / Frame	Metallo / Metal			Telaio / Frame	Poliuretano / Polyuretane	
	Stile / Style	Pannello Rettangolare / Rectangular Panel			Stile / Style	Pannello Rettangolare / Rectangular Panel	
	Tipo / Type	Filtro cabina / Cab filter			Tipo / Type	Filtro cabina / Cab filter	
Note / Notes	Attenzione le dimensioni non includono la guarnizione / Attention the dimensions do not include the gasket		Note / Notes	-			



Codice / Code	8601871200	mm	inch	Codice / Code	8601871300	mm	inch
	Altezza / Height	40	1,57		Altezza / Height	13	0,51
	Larghezza / Width	194,5	7,66		Larghezza / Width	102	4,02
	Lunghezza / Length	394,5	15,53		Lunghezza / Length	432	17,01
	Tipo mezzo filtrante Filter media type	Elemento filtrante a due stadi carbone attivo / Two-stage filter element activated carbon			Tipo mezzo filtrante Filter media type	Fibra di poliestere / Polyester fiber	
	Telaio / Frame	Metallo / Metal			Telaio / Frame	Vello -Poliuretano / Fleece - Polyuretane	
	Stile / Style	Pannello Rettangolare / Rectangular Panel			Stile / Style	Pannello Rettangolare / Rectangular Panel	
	Tipo / Type	Filtro cabina / Cab filter			Tipo / Type	Filtro cabina / Cab filter	
Note / Notes	Attenzione le dimensioni non includono la guarnizione / Attention the dimensions do not include the gasket		Note / Notes	Attenzione le dimensioni non includono la guarnizione / Attention the dimensions do not include the gasket			

Codice / Code	8601871400	mm	inch	Codice / Code	8601871500	mm	inch
	Altezza / Height	56	2,20		Altezza / Height	56	2,20
	Larghezza / Width	280	11,02		Larghezza / Width	140	5,51
	Lunghezza / Length	280	11,02		Lunghezza / Length	240	9,45
	Tipo mezzo filtrante Filter media type	Fibra di poliestere / Polyester fiber			Tipo mezzo filtrante Filter media type	Cellulosa / Cellulose	
	Telaio / Frame	Plastica / Plastic			Telaio / Frame	Vello -Poliuretano / Fleece - Polyuretane	
Stile / Style	Pannello Rettangolare / Rectangular Panel		Stile / Style	Pannello Rettangolare / Rectangular Panel			
Tipo / Type	Filtro cabina / Cab filter		Tipo / Type	Filtro cabina / Cab filter			
Note / Notes	Attenzione le dimensioni non includono la guarnizione / Attention the dimensions do not include the gasket		Note / Notes	-			



Codice / Code	8601871600	mm	inch	Codice / Code	8601871700	mm	inch
	Altezza / Height	40	1,57		Altezza / Height	40	1,57
	Larghezza / Width	100	3,94		Larghezza / Width	100	3,94
	Lunghezza / Length	249	9,80		Lunghezza / Length	249	9,80
	Tipo mezzo filtrante Filter media type	Cellulosa / Cellulose			Tipo mezzo filtrante Filter media type	Elemento filtrante a due stadi carbone attivo atossico / Two-stage filter element anti-toxic activated carbon	
	Telaio / Frame	Metallo / Metal			Telaio / Frame	Metallo / Metal	
Stile / Style	Pannello Rettangolare / Rectangular Panel		Stile / Style	Pannello Rettangolare / Rectangular Panel			
Tipo / Type	Filtro cabina / Cab filter		Tipo / Type	Filtro cabina / Cab filter			
Note / Notes	Attenzione le dimensioni non includono la guarnizione / Attention the dimensions do not include the gasket		Note / Notes	Attenzione le dimensioni non includono la guarnizione / Attention the dimensions do not include the gasket			

Codice / Code	8601871900	mm	inch	Codice / Code	8601872400	mm	inch
	Altezza / Height	55	2,17		Altezza / Height	110	4,33
	Larghezza / Width	70	2,76		Larghezza / Width	100	3,94
	Lunghezza / Length	635	25,00		Lunghezza / Length	501	19,72
	Tipo mezzo filtrante Filter media type	Elemento filtrante a due stadi carbone attivo atossico / Two-stage filter element anti-toxic activated carbon			Tipo mezzo filtrante Filter media type	Elemento filtrante a due stadi carbone attivo atossico / Two-stage filter element anti-toxic activated carbon	
	Telaio / Frame	Metallo / Metal			Telaio / Frame	Metallo / Metal	
Stile / Style	Pannello Rettangolare / Rectangular Panel		Stile / Style	Pannello Rettangolare / Rectangular Panel			
Tipo / Type	Filtro cabina / Cab filter		Tipo / Type	Filtro cabina / Cab filter			
Note / Notes	Attenzione le dimensioni non includono la guarnizione / Attention the dimensions do not include the gasket		Note / Notes	Attenzione le dimensioni non includono la guarnizione / Attention the dimensions do not include the gasket			











Codice / Code	8601872600	mm	inch	Codice / Code	8601873200	mm	inch
	Altezza / Height	55	2,17		Altezza / Height	41	1,61
	Larghezza / Width	70	2,76		Larghezza / Width	134	5,28
	Lunghezza / Length	635	25,00		Lunghezza / Length	340	13,39
	Tipo mezzo filtrante Filter media type	Fibra di poliestere / Polyester fiber			Tipo mezzo filtrante Filter media type	Fibra di poliestere / Polyester fiber	
	Telaio / Frame	Metallo / Metal			Telaio / Frame	Vello -Poliuretano / Fleece - Polyuretane	
Stile / Style	Pannello Rettangolare / Rectangular Panel		Stile / Style	Pannello Rettangolare / Rectangular Panel			
Tipo / Type	Filtro cabina / Cab filter		Tipo / Type	-			
Note / Notes	Attenzione le dimensioni non includono la guarnizione / Attention the dimensions do not include the gasket		Note / Notes	Filtro ignifugo secondo la norma DIN 53438-PARTE 3 F1 / Flame retardant filter according with standard DIN 53438-PART 3 F1			

Codice / Code	8601873300	mm	inch	Codice / Code	8601873800	mm	inch
 PHOTO NOT AVAILABLE	Altezza / Height	30	1,18		Altezza / Height	85	3,35
	Larghezza / Width	125	4,92		Larghezza / Width	150	5,91
	Lunghezza / Length	390	15,35		Lunghezza / Length	440	17,32
	Tipo mezzo filtrante Filter media type	Fibra di poliestere / Polyester fiber			Tipo mezzo filtrante Filter media type	Elemento filtrante a due stadi carbone attivo atossico / Two-stage filter element anti-toxic activated carbon	
	Telaio / Frame	Vello -Poliuretano / Fleece - Polyuretane			Telaio / Frame	Metallo / Metal	
	Stile / Style	Pannello Rettangolare / Rectangular Panel			Stile / Style	Pannello Rettangolare / Rectangular Panel	
	Tipo / Type	-			Tipo / Type	Filtro cabina / Cab filter	
Note / Notes	Filtro ignifugo secondo la norma DIN 53438-PARTE 3 F1 / Flame retardant filter according with standard DIN 53438-PART 3 F1		Note / Notes	Attenzione le dimensioni non includono la guarnizione / Attention the dimensions do not include the gasket			

Codice / Code	8601873900	mm	inch	Codice / Code	8601874500	mm	inch
	Altezza / Height	110	4,33		Altezza / Height	64	2,52
	Larghezza / Width	100	3,94		Larghezza / Width	100	3,94
	Lunghezza / Length	500	19,69		Lunghezza / Length	550	21,65
	Tipo mezzo filtrante Filter media type	Elemento filtrante a due stadi carbone attivo atossico / Two-stage filter element anti-toxic activated carbon			Tipo mezzo filtrante Filter media type	Elemento filtrante a doppio stadio Two-stage filter element	
	Telaio / Frame	Metallo / Metal			Telaio / Frame	Metallo / Metal	
	Stile / Style	Pannello Rettangolare / Rectangular Panel			Stile / Style	Pannello Rettangolare / Rectangular Panel	
	Tipo / Type	Filtro cabina / Cab filter			Tipo / Type	Filtro cabina / Cab filter	
Note / Notes	Attenzione le dimensioni non includono la guarnizione / Attention the dimensions do not include the gasket		Note / Notes	-			

Codice / Code	8601876100	mm	inch	Codice / Code	8601876900	mm	inch
	Altezza / Height	17	0,67		Altezza / Height	48	1,89
	Larghezza / Width	142	5,59		Larghezza / Width	280	11,02
	Lunghezza / Length	461,5	18,17		Lunghezza / Length	120	4,72
	Tipo mezzo filtrante Filter media type	Fibra di poliestere / Polyester fiber			Tipo mezzo filtrante Filter media type	Cellulosa / Cellulose	
	Telaio / Frame	Vello -Poliuretano / Fleece - Polyuretane			Telaio / Frame	Metallo / Metal	
	Stile / Style	Pannello Rettangolare / Rectangular Panel			Stile / Style	Pannello Rettangolare / Rectangular Panel	
	Tipo / Type	Filtro cabina / Cab filter			Tipo / Type	Filtro cabina / Cab filter	
Note / Notes	Attenzione le dimensioni non includono la guarnizione / Attention the dimensions do not include the gasket		Note / Notes	Attenzione le dimensioni non includono la guarnizione / Attention the dimensions do not include the gasket			

Codice / Code	8601877400	mm	inch	Codice / Code	8601877500	mm	inch
	Altezza / Height	18	0,71		Altezza / Height	15	0,59
	Larghezza / Width	155	6,10		Larghezza / Width	170	6,69
	Lunghezza / Length	215	8,46		Lunghezza / Length	207	8,15
	Tipo mezzo filtrante Filter media type	Fibra di poliestere / Polyester fiber			Tipo mezzo filtrante Filter media type	Fibra di poliestere / Polyester fiber	
	Telaio / Frame	Metallo / Metal			Telaio / Frame	Metallo / Metal	
	Stile / Style	Pannello Rettangolare / Rectangular Panel			Stile / Style	Pannello Rettangolare / Rectangular Panel	
	Tipo / Type	Filtro cabina / Cab filter			Tipo / Type	Filtro cabina / Cab filter	
Note / Notes	Attenzione le dimensioni non includono la guarnizione / Attention the dimensions do not include the gasket		Note / Notes	Attenzione le dimensioni non includono la guarnizione / Attention the dimensions do not include the gasket			

Codice / Code	8601877600	mm	inch	Codice / Code	8601879500	mm	inch
	Altezza / Height	10	0,39		Altezza / Height	177	6,97
	Larghezza / Width	72	2,83		Larghezza / Width	250	9,84
	Lunghezza / Length	96	3,78		Lunghezza / Length	297	11,69
	Tipo mezzo filtrante Filter media type	Cotone nero non incollato Black non glue cotton			Tipo mezzo filtrante Filter media type	Elemento filtrante a triplo stadio Triple-stage filter element	
	Telaio / Frame	Poliuretano / Polyuretane			Telaio / Frame	Metallo / Metal	
	Stile / Style	Pannello Rettangolare / Rectangular Panel			Stile / Style	Pannello Rettangolare / Rectangular Panel	
	Tipo / Type	Filtro cabina / Cab filter			Tipo / Type	Filtro cabina / Cab filter	
	Note / Notes	-			Note / Notes	Attenzione le dimensioni non includono la guarnizione / Attention the dimensions do not include the gasket	
Codice / Code	8601880700	mm	inch	Codice / Code	8601880800	mm	inch
	Altezza / Height	177	6,97		Altezza / Height	177	6,97
	Larghezza / Width	250	9,84		Larghezza / Width	250	9,84
	Lunghezza / Length	297	11,69		Lunghezza / Length	297	11,69
	Tipo mezzo filtrante Filter media type	Elemento filtrante a triplo stadio Triple-stage filter element			Tipo mezzo filtrante Filter media type	Elemento filtrante a triplo stadio Triple-stage filter element	
	Telaio / Frame	Metallo / Metal			Telaio / Frame	Metallo / Metal	
	Stile / Style	Pannello Rettangolare / Rectangular Panel			Stile / Style	Pannello Rettangolare / Rectangular Panel	
	Tipo / Type	Filtro cabina / Cab filter			Tipo / Type	Filtro cabina / Cab filter	
	Note / Notes	Attenzione le dimensioni non includono la guarnizione / Attention the dimensions do not include the gasket			Note / Notes	Attenzione le dimensioni non includono la guarnizione / Attention the dimensions do not include the gasket	
Codice / Code	8601880900	mm	inch	Codice / Code	8601881100	mm	inch
	Altezza / Height	177	6,97		Altezza / Height	177	6,97
	Larghezza / Width	250	9,84		Larghezza / Width	250	9,84
	Lunghezza / Length	297	11,69		Lunghezza / Length	297	11,69
	Tipo mezzo filtrante Filter media type	Elemento filtrante a triplo stadio Triple-stage filter element			Tipo mezzo filtrante Filter media type	Elemento filtrante a doppio stadio Two-stage filter element	
	Telaio / Frame	Metallo / Metal			Telaio / Frame	Metallo / Metal	
	Stile / Style	Pannello Rettangolare / Rectangular Panel			Stile / Style	Pannello Rettangolare / Rectangular Panel	
	Tipo / Type	Filtro cabina / Cab filter			Tipo / Type	Filtro cabina / Cab filter	
	Note / Notes	Attenzione le dimensioni non includono la guarnizione / Attention the dimensions do not include the gasket			Note / Notes	Attenzione le dimensioni non includono la guarnizione / Attention the dimensions do not include the gasket	
Codice / Code	8601884600	mm	inch	Codice / Code	8601884700	mm	inch
	Altezza / Height	21	0,83		Altezza / Height	48	1,89
	Larghezza / Width	154	6,06		Larghezza / Width	65	2,56
	Lunghezza / Length	320	12,60		Lunghezza / Length	425	16,73
	Tipo mezzo filtrante Filter media type	Fibra di poliestere / Polyester fiber			Tipo mezzo filtrante Filter media type	Fibra di poliestere / Polyester fiber	
	Telaio / Frame	Vello / Fleece			Telaio / Frame	Vello / Fleece	
	Stile / Style	Pannello Rettangolare / Rectangular Panel			Stile / Style	Pannello Rettangolare / Rectangular Panel	
	Tipo / Type	Filtro cabina / Cab filter			Tipo / Type	Filtro cabina / Cab filter	
	Note / Notes	Attenzione le dimensioni non includono la guarnizione / Attention the dimensions do not include the gasket			Note / Notes	Attenzione le dimensioni non includono la guarnizione / Attention the dimensions do not include the gasket	
Codice / Code	8601884800	mm	inch	Codice / Code	8601885000	mm	inch
	Altezza / Height	26,5	1,04		Altezza / Height	48	1,89
	Larghezza / Width	60	2,36		Larghezza / Width	193	7,60
	Lunghezza / Length	382	15,04		Lunghezza / Length	346	13,62
	Tipo mezzo filtrante Filter media type	Bulpren (Colore nero) Bulpren (Black color)			Tipo mezzo filtrante Filter media type	Elemento filtrante a due stadi carbone attivo / Two-stage filter element activated carbon	
	Telaio / Frame	Metallo / Metal			Telaio / Frame	Metallo / Metal	
	Stile / Style	Pannello Rettangolare / Rectangular Panel			Stile / Style	Pannello Rettangolare / Rectangular Panel	
	Tipo / Type	Filtro cabina / Cab filter			Tipo / Type	Filtro cabina / Cab filter	

Codice / Code	8601885800	mm	inch
 PHOTO NOT AVAILABLE	Altezza / Height	25	0,98
	Larghezza / Width	94	3,70
	Lunghezza / Length	356	14,02
	Tipo mezzo filtrante Filter media type	Tessuto non tessuto / Non-woven	
	Telaio / Frame	Cartone bianco / Cardboard white	
	Stile / Style	Pannello Rettangolare / Rectangular Panel	
	Tipo / Type	Filtro cabina / Cab filter	
	Note / Notes	Attenzione le dimensioni non includono la guarnizione / Attention the dimensions do not include the gasket	

Codice / Code	8601885900	mm	inch
 PHOTO NOT AVAILABLE	Altezza / Height	25	0,98
	Larghezza / Width	94	3,70
	Lunghezza / Length	356	14,02
	Tipo mezzo filtrante Filter media type	Fibra di poliestere / Polyester fiber	
	Telaio / Frame	Cartone bianco / Cardboard white	
	Stile / Style	Pannello Rettangolare / Rectangular Panel	
	Tipo / Type	Filtro cabina / Cab filter	
	Note / Notes	Attenzione le dimensioni non includono la guarnizione / Attention the dimensions do not include the gasket	

Codice / Code	8601886000	mm	inch
 PHOTO NOT AVAILABLE	Altezza / Height	30	1,18
	Larghezza / Width	59	2,32
	Lunghezza / Length	322	12,68
	Tipo mezzo filtrante Filter media type	Fibra di poliestere / Polyester fiber	
	Telaio / Frame	Cartone bianco / Cardboard white	
	Stile / Style	Pannello Rettangolare / Rectangular Panel	
	Tipo / Type	Filtro cabina / Cab filter	
	Note / Notes	Attenzione le dimensioni non includono la guarnizione / Attention the dimensions do not include the gasket	

Codice / Code	8601886100	mm	inch
 PHOTO NOT AVAILABLE	Altezza / Height	23	0,91
	Larghezza / Width	105	4,13
	Lunghezza / Length	305	12,01
	Tipo mezzo filtrante Filter media type	Fibra di poliestere / Polyester fiber	
	Telaio / Frame	Vello -Poliuretano / Fleece - Polyuretane	
	Stile / Style	Pannello Rettangolare / Rectangular Panel	
	Tipo / Type	Filtro cabina / Cab filter	
	Note / Notes	-	

Codice / Code	8601886200	mm	inch
	Altezza / Height	30	1,18
	Larghezza / Width	84	3,31
	Lunghezza / Length	484	19,06
	Tipo mezzo filtrante Filter media type	Fibra di poliestere / Polyester fiber	
	Telaio / Frame	Vello / Fleece	
	Stile / Style	Pannello Rettangolare / Rectangular Panel	
	Tipo / Type	Filtro cabina / Cab filter	
	Note / Notes	Attenzione le dimensioni non includono la guarnizione / Attention the dimensions do not include the gasket	

Codice / Code	8601886500	mm	inch
 PHOTO NOT AVAILABLE	Altezza / Height	23	0,91
	Larghezza / Width	105	4,13
	Lunghezza / Length	305	12,01
	Tipo mezzo filtrante Filter media type	Tessuto non tessuto / Non-woven	
	Telaio / Frame	Vello -Poliuretano / Fleece - Polyuretane	
	Stile / Style	Pannello Rettangolare / Rectangular Panel	
	Tipo / Type	Filtro cabina / Cab filter	
	Note / Notes	-	

Codice / Code	8601886600	mm	inch
	Altezza / Height	48	1,89
	Larghezza / Width	260	10,24
	Lunghezza / Length	285	11,22
	Tipo mezzo filtrante Filter media type	Fibra di poliestere / Polyester fiber	
	Telaio / Frame	Vello / Fleece	
	Stile / Style	Pannello Rettangolare / Rectangular Panel	
	Tipo / Type	Filtro cabina / Cab filter	
	Note / Notes	Attenzione le dimensioni non includono la guarnizione / Attention the dimensions do not include the gasket	

Codice / Code	8601886700	mm	inch
	Altezza / Height	10	0,39
	Larghezza / Width	232	9,13
	Lunghezza / Length	349	13,74
	Tipo mezzo filtrante Filter media type	Bulpren (Colore nero) Bulpren (Black color)	
	Telaio / Frame	-	
	Stile / Style	Pannello Rettangolare / Rectangular Panel	
	Tipo / Type	Filtro cabina / Cab filter	
	Note / Notes	-	

Codice / Code	8601886900	mm	inch
	Altezza / Height	30	1,18
	Larghezza / Width	186	7,32
	Lunghezza / Length	243	9,57
	Tipo mezzo filtrante Filter media type	Fibra di poliestere / Polyester fiber	
	Telaio / Frame	Vello -Poliuretano / Fleece - Polyuretane	
	Stile / Style	Pannello Rettangolare / Rectangular Panel	
	Tipo / Type	Filtro cabina / Cab filter	
Note / Notes	-		

Codice / Code	8601887100	mm	inch
	Altezza / Height	20	0,79
	Larghezza / Width	109	4,29
	Lunghezza / Length	376	14,80
	Tipo mezzo filtrante Filter media type	Fibra di poliestere / Polyester fiber	
	Telaio / Frame	Vello / Fleece	
	Stile / Style	Pannello Rettangolare / Rectangular Panel	
	Tipo / Type	Filtro cabina / Cab filter	
Note / Notes	Attenzione le dimensioni non includono la guarnizione / Attention the dimensions do not include the gasket		

Codice / Code	8601887200	mm	inch
	Altezza / Height	20	0,79
	Larghezza / Width	109	4,29
	Lunghezza / Length	376	14,80
	Tipo mezzo filtrante Filter media type	Fibra di poliestere / Polyester fiber	
	Telaio / Frame	Vello / Fleece	
	Stile / Style	Pannello Rettangolare / Rectangular Panel	
	Tipo / Type	Filtro cabina / Cab filter	
Note / Notes	Attenzione le dimensioni non includono la guarnizione / Attention the dimensions do not include the gasket		



Codice / Code	8601887300	mm	inch
	Altezza / Height	20	0,79
	Larghezza / Width	221	8,70
	Lunghezza / Length	390	15,35
	Tipo mezzo filtrante Filter media type	Fibra di poliestere / Polyester fiber	
	Telaio / Frame	Vello / Fleece	
	Stile / Style	Pannello Rettangolare / Rectangular Panel	
	Tipo / Type	Filtro cabina / Cab filter	
Note / Notes	Attenzione le dimensioni non includono la guarnizione / Attention the dimensions do not include the gasket		











Codice / Code	8601887900	mm	inch
	Altezza / Height	25	0,98
	Larghezza / Width	75	2,95
	Lunghezza / Length	230	9,06
	Tipo mezzo filtrante Filter media type	Tessuto non tessuto sintetico attivato Synthetic activated carbon nonwoven	
	Telaio / Frame	Vello / Fleece	
	Stile / Style	Pannello Rettangolare / Rectangular Panel	
	Tipo / Type	Filtro cabina / Cab filter	
Note / Notes	-		









Codice / Code	8601889700	mm	inch
	Altezza / Height	20	0,79
	Larghezza / Width	162	6,38
	Lunghezza / Length	382	15,04
	Tipo mezzo filtrante Filter media type	Fibra di poliestere / Polyester fiber	
	Telaio / Frame	Vello / Fleece	
	Stile / Style	Pannello Rettangolare / Rectangular Panel	
	Tipo / Type	Filtro cabina / Cab filter	
Note / Notes	Attenzione le dimensioni non includono la guarnizione / Attention the dimensions do not include the gasket		

Codice / Code	8601889900	mm	inch
	Altezza / Height	42	1,65
	Larghezza / Width	96	3,78
	Lunghezza / Length	143	5,63
	Tipo mezzo filtrante Filter media type	Fibra di poliestere / Polyester fiber	
	Telaio / Frame	Vello / Fleece	
	Stile / Style	Pannello Rettangolare / Rectangular Panel	
	Tipo / Type	Filtro cabina / Cab filter	
Note / Notes	Attenzione le dimensioni non includono la guarnizione / Attention the dimensions do not include the gasket		

Codice / Code	8601890800	mm	inch
	Altezza / Height	25	0,98
	Larghezza / Width	100	3,94
	Lunghezza / Length	381	15,00
	Tipo mezzo filtrante Filter media type	Fibra di poliestere / Polyester fiber	
	Telaio / Frame	Metallo / Metal	
	Stile / Style	Pannello Rettangolare / Rectangular Panel	
	Tipo / Type	Filtro cabina / Cab filter	
Note / Notes	Attenzione le dimensioni non includono la guarnizione / Attention the dimensions do not include the gasket		



Codice / Code	8601890900	mm	inch	Codice / Code	8601891000	mm	inch
	Altezza / Height	25	0,98		Altezza / Height	30	1,18
	Larghezza / Width	100	3,94		Larghezza / Width	64	2,52
	Lunghezza / Length	180	7,09		Lunghezza / Length	239	9,41
	Tipo mezzo filtrante Filter media type	Fibra di poliestere / Polyester fiber			Tipo mezzo filtrante Filter media type	Elemento filtrante a doppio stadio Two-stage filter element	
	Telaio / Frame	Metallo / Metal			Telaio / Frame	Metallo / Metal	
	Stile / Style	Pannello Rettangolare / Rectangular Panel			Stile / Style	Pannello Rettangolare / Rectangular Panel	
	Tipo / Type	Filtro cabina / Cab filter			Tipo / Type	Filtro cabina / Cab filter	
	Note / Notes	Attenzione le dimensioni non includono la guarnizione / Attention the dimensions do not include the gasket			Note / Notes	Attenzione le dimensioni non includono la guarnizione / Attention the dimensions do not include the gasket	
Codice / Code	8601891100	mm	inch	Codice / Code	8601891200	mm	inch
	Altezza / Height	110	4,33		Altezza / Height	10	0,39
	Larghezza / Width	100	3,94		Larghezza / Width	290	11,42
	Lunghezza / Length	500	19,69		Lunghezza / Length	478	18,82
	Tipo mezzo filtrante Filter media type	Elemento filtrante a tre stadi carbone attivo atossico / Three-stage filter element anti-toxic activated carbon			Tipo mezzo filtrante Filter media type	Feltro sintetico / Synthetic felt	
	Telaio / Frame	Metallo / Metal			Telaio / Frame	-	
	Stile / Style	Pannello Rettangolare / Rectangular Panel			Stile / Style	Pannello Rettangolare / Rectangular Panel	
	Tipo / Type	Filtro cabina / Cab filter			Tipo / Type	-	
	Note / Notes	Attenzione le dimensioni non includono la guarnizione / Attention the dimensions do not include the gasket			Note / Notes	-	
Codice / Code	8601891700	mm	inch	Codice / Code	8601893200	mm	inch
	Altezza / Height	35	1,38		Altezza / Height	34	1,34
	Larghezza / Width	150	5,91		Larghezza / Width	145	5,71
	Lunghezza / Length	261	10,28		Lunghezza / Length	391	15,39
	Tipo mezzo filtrante Filter media type	Tessuto non tessuto sintetico attivato / Synthetic activated carbon nonwoven			Tipo mezzo filtrante Filter media type	Fibra di poliestere / Polyester fiber	
	Telaio / Frame	Vello / Fleece			Telaio / Frame	Vello / Fleece	
	Stile / Style	Pannello Rettangolare / Rectangular Panel			Stile / Style	Pannello Rettangolare / Rectangular Panel	
	Tipo / Type	Filtro cabina / Cab filter			Tipo / Type	Filtro cabina / Cab filter	
Codice / Code	8601893500	mm	inch	Codice / Code	8601893600	mm	inch
	Altezza / Height	30	1,18		Altezza / Height	30	1,18
	Larghezza / Width	120	4,72		Larghezza / Width	120	4,72
	Lunghezza / Length	636	25,04		Lunghezza / Length	636	25,04
	Tipo mezzo filtrante Filter media type	Fibra di poliestere / Polyester fiber			Tipo mezzo filtrante Filter media type	Fibra di poliestere / Polyester fiber	
	Telaio / Frame	Vello -Poliuretano / Fleece - Polyuretane			Telaio / Frame	Vello -Poliuretano / Fleece - Polyuretane	
	Stile / Style	Pannello Rettangolare / Rectangular Panel			Stile / Style	Pannello Rettangolare / Rectangular Panel	
	Tipo / Type	Filtro cabina / Cab filter			Tipo / Type	Filtro cabina / Cab filter	
Codice / Code	8601893700	mm	inch	Codice / Code	8601893800	mm	inch
	Altezza / Height	22,5	0,89		Altezza / Height	22,5	0,89
	Larghezza / Width	57	2,24		Larghezza / Width	57	2,24
	Lunghezza / Length	680	26,77		Lunghezza / Length	680	26,77
	Tipo mezzo filtrante Filter media type	Fibra di poliestere / Polyester fiber			Tipo mezzo filtrante Filter media type	Fibra di poliestere / Polyester fiber	
	Telaio / Frame	Metallo / Metal			Telaio / Frame	Metallo / Metal	
	Stile / Style	Pannello Rettangolare / Rectangular Panel			Stile / Style	Pannello Rettangolare / Rectangular Panel	
	Tipo / Type	Filtro cabina / Cab filter			Tipo / Type	Filtro cabina / Cab filter	
	Note / Notes	Attenzione le dimensioni non includono la guarnizione / Attention the dimensions do not include the gasket			Note / Notes	Attenzione le dimensioni non includono la guarnizione / Attention the dimensions do not include the gasket	



Codice / Code	8601893900	mm	inch	Codice / Code	8601894000	mm	inch
	Altezza / Height	15	0,59		Altezza / Height	15	0,59
	Larghezza / Width	95	3,74		Larghezza / Width	150	5,91
	Lunghezza / Length	192	7,56		Lunghezza / Length	314	12,36
	Tipo mezzo filtrante Filter media type	Fibra di poliestere / Polyester fiber			Tipo mezzo filtrante Filter media type	Fibra di poliestere / Polyester fiber	
	Telaio / Frame	Vello -Poliuretano / Fleece - Polyuretane			Telaio / Frame	Vello -Poliuretano / Fleece - Polyuretane	
	Stile / Style	Pannello Rettangolare / Rectangular Panel			Stile / Style	Pannello Rettangolare / Rectangular Panel	
	Tipo / Type	Filtro cabina / Cab filter			Tipo / Type	Filtro cabina / Cab filter	
Codice / Code	8601894100	mm	inch	Codice / Code	8601894200	mm	inch
	Altezza / Height	10	0,39		Altezza / Height	38	1,50
	Larghezza / Width	175,5	6,91		Larghezza / Width	148	5,83
	Lunghezza / Length	391,5	15,41		Lunghezza / Length	348	13,70
	Tipo mezzo filtrante Filter media type	Bulpren (Colore nero) Bulpren (Black color)			Tipo mezzo filtrante Filter media type	Fibra di poliestere / Polyester fiber	
	Telaio / Frame	-			Telaio / Frame	Vello -Poliuretano / Fleece - Polyuretane	
	Stile / Style	Pannello Rettangolare / Rectangular Panel			Stile / Style	Pannello Rettangolare / Rectangular Panel	
	Tipo / Type	Filtro cabina / Cab filter			Tipo / Type	Filtro cabina / Cab filter	
Codice / Code	8601894300	mm	inch	Codice / Code	8601896100	mm	inch
	Altezza / Height	51	2,01		Altezza / Height	27	1,06
	Larghezza / Width	148	5,83		Larghezza / Width	126	4,96
	Lunghezza / Length	348	13,70		Lunghezza / Length	415	16,34
	Tipo mezzo filtrante Filter media type	Elemento filtrante a due stadi carbone attivo atossico / Two-stage filter element anti-toxic activated carbon			Tipo mezzo filtrante Filter media type	Tessuto non tessuto / Non-woven	
	Telaio / Frame	Metallo / Metal			Telaio / Frame	Metallo / Metal	
	Stile / Style	Pannello Rettangolare / Rectangular Panel			Stile / Style	Pannello Rettangolare / Rectangular Panel	
	Tipo / Type	Filtro cabina / Cab filter			Tipo / Type	Filtro cabina / Cab filter	
	Note / Notes	-			Note / Notes	Attenzione le dimensioni non includono la guarnizione / Attention the dimensions do not include the gasket	
Codice / Code	8601896200	mm	inch	Codice / Code	8601896300	mm	inch
	Altezza / Height	30,5	1,20		Altezza / Height	25	0,98
	Larghezza / Width	140	5,51		Larghezza / Width	147	5,79
	Lunghezza / Length	600	23,62		Lunghezza / Length	600	23,62
	Tipo mezzo filtrante Filter media type	Tessuto non tessuto / Non-woven			Tipo mezzo filtrante Filter media type	Carbone attivo / Activated carbon	
	Telaio / Frame	Metallo / Metal			Telaio / Frame	Metallo / Metal	
	Stile / Style	Pannello Rettangolare / Rectangular Panel			Stile / Style	Pannello Rettangolare / Rectangular Panel	
	Tipo / Type	Filtro cabina / Cab filter			Tipo / Type	Filtro cabina / Cab filter	
	Note / Notes	Attenzione le dimensioni non includono la guarnizione / Attention the dimensions do not include the gasket			Note / Notes	Attenzione le dimensioni non includono la guarnizione / Attention the dimensions do not include the gasket	
Codice / Code	8601896400	mm	inch	Codice / Code	8601896500	mm	inch
	Altezza / Height	107	4,21		Altezza / Height	100	3,94
	Larghezza / Width	129	5,08		Larghezza / Width	285	11,22
	Lunghezza / Length	690	27,17		Lunghezza / Length	480	18,90
	Tipo mezzo filtrante Filter media type	Elemento filtrante a doppio stadio Two-stage filter element			Tipo mezzo filtrante Filter media type	Elemento filtrante a doppio stadio Two-stage filter element	
	Telaio / Frame	Metallo / Metal			Telaio / Frame	Metallo / Metal	
	Stile / Style	Pannello Rettangolare / Rectangular Panel			Stile / Style	Pannello Rettangolare / Rectangular Panel	
	Tipo / Type	Filtro cabina / Cab filter			Tipo / Type	Filtro cabina / Cab filter	
	Note / Notes	Attenzione le dimensioni non includono la guarnizione / Attention the dimensions do not include the gasket			Note / Notes	Attenzione le dimensioni non includono la guarnizione / Attention the dimensions do not include the gasket	

Codice / Code	8601897900	mm	inch	Codice / Code	8601898200	mm	inch
	Altezza / Height	110	4,33		Altezza / Height	110	4,33
	Larghezza / Width	100	3,94		Larghezza / Width	100	3,94
	Lunghezza / Length	500	19,69		Lunghezza / Length	500	19,69
	Tipo mezzo filtrante Filter media type	Elemento filtrante a tre stadi carbone attivo atossico / Three-stage filter element anti-toxic activated carbon					
	Telaio / Frame	Metallo / Metal					
	Stile / Style	Pannello Rettangolare / Rectangular Panel					
	Tipo / Type	Filtro cabina / Cab filter					
	Note / Notes	Attenzione le dimensioni non includono la guarnizione / Attention the dimensions do not include the gasket					
Codice / Code	8601899900	mm	inch	Codice / Code	8601900000	mm	inch
	Altezza / Height	22	0,87		Altezza / Height	30	1,18
	Larghezza / Width	130	5,12		Larghezza / Width	150	5,91
	Lunghezza / Length	136,5	5,37		Lunghezza / Length	190	7,48
	Tipo mezzo filtrante Filter media type	Fibra di poliestere / Polyester fiber					
	Telaio / Frame	Vello / Fleece					
	Stile / Style	Pannello Rettangolare / Rectangular Panel					
	Tipo / Type	Filtro cabina / Cab filter					
	Note / Notes	Attenzione le dimensioni non includono la guarnizione / Attention the dimensions do not include the gasket					
Codice / Code	8601902000	mm	inch	Codice / Code	8601905600	mm	inch
	Altezza / Height	25	0,98		Altezza / Height	47	1,85
	Larghezza / Width	178	7,01		Larghezza / Width	79	3,11
	Lunghezza / Length	248	9,76		Lunghezza / Length	490	19,29
	Tipo mezzo filtrante Filter media type	Fibra di poliestere / Polyester fiber					
	Telaio / Frame	Vello / Fleece					
	Stile / Style	Pannello Rettangolare / Rectangular Panel					
	Tipo / Type	Filtro cabina / Cab filter					
	Note / Notes	Attenzione le dimensioni non includono la guarnizione / Attention the dimensions do not include the gasket					
Codice / Code	8601906800	mm	inch	Codice / Code	8601907100	mm	inch
	Altezza / Height	12	0,47		Altezza / Height	50	1,97
	Larghezza / Width	155	6,10		Larghezza / Width	104	4,09
	Lunghezza / Length	326	12,83		Lunghezza / Length	520	20,47
	Tipo mezzo filtrante Filter media type	Bulpren (Colore nero) Bulpren (Black color)					
	Telaio / Frame	-					
	Stile / Style	Pannello Rettangolare / Rectangular Panel					
	Tipo / Type	Filtro cabina / Cab filter					
	Note / Notes	-					
					Tipo mezzo filtrante Filter media type	Elemento filtrante a doppio stadio Two-stage filter element	
					Telaio / Frame	Metallo / Metal	
					Stile / Style	Pannello Rettangolare / Rectangular Panel	
					Tipo / Type	Filtro cabina / Cab filter	
					Note / Notes	Attenzione le dimensioni non includono la guarnizione / Attention the dimensions do not include the gasket	



Codice / Code	8601909200	mm	inch	Codice / Code	8601911600	mm	inch
	Altezza / Height	55	2,17		Altezza / Height	13	0,51
	Larghezza / Width	138	5,43		Larghezza / Width	108	4,25
	Lunghezza / Length	338	13,31		Lunghezza / Length	205	8,07
	Tipo mezzo filtrante Filter media type	Elemento filtrante a doppio stadio Two-stage filter element			Tipo mezzo filtrante Filter media type	Bulpren (Colore nero) Bulpren (Black color)	
	Telaio / Frame	Metallo / Metal			Telaio / Frame	-	
	Stile / Style	Pannello Rettangolare / Rectangular Panel			Stile / Style	Pannello Rettangolare / Rectangular Panel	
	Tipo / Type	Filtro cabina / Cab filter			Tipo / Type	Filtro cabina / Cab filter	



Codice / Code	8601911700	mm	inch	Codice / Code	8601911800	mm	inch
	Altezza / Height	8	0,31		Altezza / Height	10	0,39
	Larghezza / Width	117	4,61		Larghezza / Width	118	4,65
	Lunghezza / Length	303	11,93		Lunghezza / Length	209,5	8,25
	Tipo mezzo filtrante Filter media type	Bulpren (Colore nero) Bulpren (Black color)			Tipo mezzo filtrante Filter media type	Fibra di poliestere / Polyester fiber	
	Telaio / Frame	-			Telaio / Frame	Plastica / Plastic	
	Stile / Style	Pannello Rettangolare / Rectangular Panel			Stile / Style	Pannello Rettangolare / Rectangular Panel	
	Tipo / Type	Filtro cabina / Cab filter			Tipo / Type	Filtro cabina / Cab filter	
Note / Notes	-		Note / Notes	Attenzione le dimensioni non includono la guarnizione / Attention the dimensions do not include the gasket			



Codice / Code	8601912200	mm	inch	Codice / Code	8601913700	mm	inch
	Altezza / Height	25	0,98		Altezza / Height	15	0,59
	Larghezza / Width	100	3,94		Larghezza / Width	98	3,86
	Lunghezza / Length	287	11,30		Lunghezza / Length	344	13,54
	Tipo mezzo filtrante Filter media type	Fibra di poliestere / Polyester fiber			Tipo mezzo filtrante Filter media type	Fibra di poliestere / Polyester fiber	
	Telaio / Frame	Vello / Fleece			Telaio / Frame	Vello / Fleece	
	Stile / Style	Pannello Rettangolare / Rectangular Panel			Stile / Style	Pannello Rettangolare / Rectangular Panel	
	Tipo / Type	Filtro cabina / Cab filter			Tipo / Type	Filtro cabina / Cab filter	
Note / Notes	Attenzione le dimensioni non includono la guarnizione / Attention the dimensions do not include the gasket		Note / Notes	Attenzione le dimensioni non includono la guarnizione / Attention the dimensions do not include the gasket			

Codice / Code	8601914700	mm	inch	Codice / Code	8601915800	mm	inch
	Altezza / Height	13	0,51		Altezza / Height	20,5	0,81
	Larghezza / Width	93	3,66		Larghezza / Width	131,5	5,18
	Lunghezza / Length	448	17,64		Lunghezza / Length	260,5	10,26
	Tipo mezzo filtrante Filter media type	Fibra di poliestere / Polyester fiber			Tipo mezzo filtrante Filter media type	Fibra di poliestere / Polyester fiber	
	Telaio / Frame	Metallo / Metal			Telaio / Frame	Poliuretano - Plastica Polyurethane - Plastic	
	Stile / Style	Pannello Rettangolare / Rectangular Panel			Stile / Style	Pannello ovale / Oval Panel	
	Tipo / Type	Filtro cabina / Cab filter			Tipo / Type	Filtro Jokto / Jokto Filter	
Note / Notes	Attenzione le dimensioni non includono la guarnizione / Attention the dimensions do not include the gasket		Note / Notes	-			



Codice / Code	8601920700	mm	inch	Codice / Code	8601929000	mm	inch
	Altezza / Height	188	7,40		Altezza / Height	25	0,98
	Larghezza / Width	145	5,71		Larghezza / Width	400	15,75
	Lunghezza / Length	846	33,31		Lunghezza / Length	600	23,62
	Tipo mezzo filtrante Filter media type	Elemento filtrante a triplo stadio Triple-stage filter element			Tipo mezzo filtrante Filter media type	Bulpren (Colore nero) Bulpren (Black color)	
	Telaio / Frame	Plastica / Plastic			Telaio / Frame	-	
	Stile / Style	Pannello Rettangolare / Rectangular Panel			Stile / Style	Pannello Rettangolare / Rectangular Panel	
	Tipo / Type	Filtro cabina / Cab filter			Tipo / Type	Filtro cabina / Cab filter	











Codice / Code	8601924400	mm	inch	Codice / Code	8601924800	mm	inch
	Altezza / Height	21,5	0,85		Altezza / Height	56	2,20
	Larghezza / Width	145	5,71		Larghezza / Width	130	5,12
	Lunghezza / Length	366	14,41		Lunghezza / Length	450	17,72
	Tipo mezzo filtrante Filter media type	Fibra di poliestere / Polyester fiber			Tipo mezzo filtrante Filter media type	Tessuto non tessuto / Non-woven	
	Telaio / Frame	Poliuretano / Polyurethane			Telaio / Frame	Metallo / Metal	
	Stile / Style	Pannello Rettangolare / Rectangular Panel			Stile / Style	Pannello Rettangolare / Rectangular Panel	
Tipo / Type	Filtro cabina / Cab filter		Tipo / Type	Filtro cabina / Cab filter			

Codice / Code	8601925700	mm	inch	Codice / Code	8601926800	mm	inch
	Altezza / Height	40	1,57		Altezza / Height	44	1,73
	Larghezza / Width	195	7,68		Larghezza / Width	114	4,49
	Lunghezza / Length	475	18,70		Lunghezza / Length	195	7,68
	Tipo mezzo filtrante Filter media type	Fibra di poliestere / Polyester fiber			Tipo mezzo filtrante Filter media type	Fibra di poliestere / Polyester fiber	
	Telaio / Frame	Poliuretano / Polyurethane			Telaio / Frame	Vello / Fleece	
	Stile / Style	Pannello Rettangolare / Rectangular Panel			Stile / Style	Pannello Rettangolare / Rectangular Panel	
Tipo / Type	Filtro cabina / Cab filter		Tipo / Type	Filtro cabina / Cab filter			
Note / Notes	-		Note / Notes	Attenzione le dimensioni non includono la guarnizione / Attention the dimensions do not include the gasket			

Codice / Code	8601928700	mm	inch	Codice / Code	8601929300	mm	inch
	Altezza / Height	30	1,18		Altezza / Height	58	2,28
	Larghezza / Width	367	14,45		Larghezza / Width	135	5,31
	Lunghezza / Length	440	17,32		Lunghezza / Length	625	24,61
	Tipo mezzo filtrante Filter media type	Fibra di poliestere / Polyester fiber			Tipo mezzo filtrante Filter media type	Fibra di poliestere / Polyester fiber	
	Telaio / Frame	Poliuretano / Polyuretane			Telaio / Frame	Metallo / Metal	
	Stile / Style	Pannello Trapezioidale / Trapezoidal panel			Stile / Style	Pannello Rettangolare / Rectangular Panel	
Tipo / Type	Filtro cabina / Cab filter		Tipo / Type	Filtro cabina / Cab filter			
Note / Notes	-		Note / Notes	Attenzione le dimensioni non includono la guarnizione / Attention the dimensions do not include the gasket			

Codice / Code	8601932600	mm	inch	Codice / Code	8601938200	mm	inch
	Altezza / Height	80	3,15		Altezza / Height	45	1,77
	Larghezza / Width	191	7,52		Larghezza / Width	281	11,06
	Lunghezza / Length	316	12,44		Lunghezza / Length	476	18,74
	Tipo mezzo filtrante Filter media type	Tessuto poliestere / Cloth Polyester			Tipo mezzo filtrante Filter media type	Fibra di poliestere / Polyester fiber	
	Telaio / Frame	Plastica - schiuma morbida Plastic - soft foam			Telaio / Frame	Metallo / Metal	
	Stile / Style	Pannello Rettangolare / Rectangular Panel			Stile / Style	Pannello Rettangolare / Rectangular Panel	
Tipo / Type	Filtro cabina / Cab filter		Tipo / Type	Filtro cabina / Cab filter			

Codice / Code	8601941900	mm	inch	Codice / Code	8601942400	mm	inch
	Altezza / Height	25	0,98		Altezza / Height	20	0,79
	Larghezza / Width	162	6,38		Larghezza / Width	150	5,91
	Lunghezza / Length	198	7,80		Lunghezza / Length	330	12,99
	Tipo mezzo filtrante Filter media type	Fibra di poliestere / Polyester fiber			Tipo mezzo filtrante Filter media type	Fibra di poliestere / Polyester fiber	
	Telaio / Frame	Vello / Fleece			Telaio / Frame	Vello / Fleece	
	Stile / Style	Pannello Rettangolare / Rectangular Panel			Stile / Style	Pannello Rettangolare / Rectangular Panel	
Tipo / Type	Filtro cabina / Cab filter		Tipo / Type	Filtro cabina / Cab filter			
Note / Notes	Attenzione le dimensioni non includono la guarnizione / Attention the dimensions do not include the gasket		Note / Notes	Attenzione le dimensioni non includono la guarnizione / Attention the dimensions do not include the gasket			

Codice / Code	8601945900	mm	inch	Codice / Code	8601956400	mm	inch
	Altezza / Height	25,5	1,00		Altezza / Height	20	0,79
	Larghezza / Width	60	2,36		Larghezza / Width	74	2,91
	Lunghezza / Length	385	15,16		Lunghezza / Length	114	4,49
	Tipo mezzo filtrante Filter media type	Fibra di poliestere / Polyester fiber			Tipo mezzo filtrante Filter media type	Fibra di poliestere / Polyester fiber	
	Telaio / Frame	Vello / Fleece			Telaio / Frame	Vello / Fleece	
	Stile / Style	Pannello Rettangolare / Rectangular Panel			Stile / Style	Pannello Rettangolare / Rectangular Panel	
Tipo / Type	Filtro cabina / Cab filter		Tipo / Type	Filtro cabina / Cab filter			
Note / Notes	-		Note / Notes	Attenzione le dimensioni non includono la guarnizione / Attention the dimensions do not include the gasket			
Codice / Code	8601956900	mm	inch	Codice / Code	8601961600	mm	inch
	Altezza / Height	25	0,98		Altezza / Height	17	0,67
	Larghezza / Width	199	7,83		Larghezza / Width	79	3,11
	Lunghezza / Length	267	10,51		Lunghezza / Length	335	13,19
	Tipo mezzo filtrante Filter media type	Fibra di poliestere / Polyester fiber			Tipo mezzo filtrante Filter media type	Fibra di poliestere / Polyester fiber	
	Telaio / Frame	Vello / Fleece			Telaio / Frame	Vello / Fleece	
	Stile / Style	Pannello Rettangolare / Rectangular Panel			Stile / Style	Pannello Rettangolare / Rectangular Panel	
Tipo / Type	Filtro cabina / Cab filter		Tipo / Type	Filtro cabina / Cab filter			
Note / Notes	Attenzione le dimensioni non includono la guarnizione / Attention the dimensions do not include the gasket		Note / Notes	-			
Codice / Code	8601962000	mm	inch	Codice / Code	8601966200	mm	inch
	Altezza / Height	51	2,01		Altezza / Height	60	2,36
	Larghezza / Width	127	5,00		Larghezza / Width	114	4,49
	Lunghezza / Length	228	8,98		Lunghezza / Length	450	17,72
	Tipo mezzo filtrante Filter media type	Tessuto non tessuto / Non-woven			Tipo mezzo filtrante Filter media type	Fibra di poliestere / Polyester fiber	
	Telaio / Frame	Poliuretano - Plastica Polyurethane - Plastic			Telaio / Frame	Vello / Fleece	
	Stile / Style	Pannello ovale / Oval Panel			Stile / Style	Pannello Rettangolare / Rectangular Panel	
Tipo / Type	Filtro Jokto / Jokto Filter		Tipo / Type	Filtro cabina / Cab filter			
Note / Notes	Maniglia inclusa sulla dimensione altezza / Handle included on the height dimension		Note / Notes	-			
Cartuccia primaria abbinata Matched primary cartridge 8001904900							
Codice / Code	8601966700	mm	inch	Codice / Code	8601981000	mm	inch
	Altezza / Height	25	0,98		Altezza / Height	55	2,17
	Larghezza / Width	293	11,54		Larghezza / Width	214	8,43
	Lunghezza / Length	293	11,54		Lunghezza / Length	270	10,63
	Tipo mezzo filtrante Filter media type	Carbone attivo / Activated carbon			Tipo mezzo filtrante Filter media type	Carbone attivo / Activated carbon	
	Telaio / Frame	Metallo / Metal			Telaio / Frame	Metallo / Metal	
	Stile / Style	Pannello Rettangolare / Rectangular Panel			Stile / Style	Pannello Rettangolare / Rectangular Panel	
Tipo / Type	Filtro cabina / Cab filter		Tipo / Type	Filtro cabina / Cab filter			
Codice / Code	8601982500	mm	inch	Codice / Code	8601984500	mm	inch
	Altezza / Height	75	2,95		Altezza / Height	72	2,83
	Larghezza / Width	120	4,72		Larghezza / Width	137	5,39
	Lunghezza / Length	520	20,47		Lunghezza / Length	760	29,92
	Tipo mezzo filtrante Filter media type	Elemento filtrante a doppio stadio Two-stage filter element			Tipo mezzo filtrante Filter media type	Elemento filtrante a doppio stadio Two-stage filter element	
	Telaio / Frame	Metallo / Metal			Telaio / Frame	Metallo / Metal	
	Stile / Style	Pannello Rettangolare / Rectangular Panel			Stile / Style	Pannello Rettangolare / Rectangular Panel	
Tipo / Type	Filtro cabina / Cab filter		Tipo / Type	Filtro cabina / Cab filter			

Codice / Code	8601985400	mm	inch	Codice / Code	8601986400	mm	inch
 PHOTO NOT AVAILABLE	Altezza / Height	50	1,97		Altezza / Height	72	2,83
	Larghezza / Width	260	10,24		Larghezza / Width	135	5,31
	Lunghezza / Length	430	16,93		Lunghezza / Length	760	29,92
	Tipo mezzo filtrante Filter media type	Elemento filtrante a doppio stadio Two-stage filter element			Tipo mezzo filtrante Filter media type	Fibra di poliestere / Polyester fiber	
	Telaio / Frame	Metallo / Metal			Telaio / Frame	Metallo / Metal	
	Stile / Style	Pannello Rettangolare / Rectangular Panel			Stile / Style	Pannello Rettangolare / Rectangular Panel	
	Tipo / Type	Filtro cabina / Cab filter			Tipo / Type	Filtro cabina / Cab filter	
Note / Notes	Attenzione le dimensioni non includono la guarnizione / Attention the dimensions do not include the gasket			Note / Notes	-		

Codice / Code	8601990400	mm	inch
 PHOTO NOT AVAILABLE	Altezza / Height	50	1,97
	Larghezza / Width	178	7,01
	Lunghezza / Length	585	23,03
	Tipo mezzo filtrante Filter media type	Elemento filtrante a doppio stadio Two-stage filter element	
	Telaio / Frame	Metallo / Metal	
	Stile / Style	Pannello Rettangolare / Rectangular Panel	
	Tipo / Type	Filtro cabina / Cab filter	
Note / Notes	Attenzione le dimensioni non includono la guarnizione / Attention the dimensions do not include the gasket		

FILTRI CABINA IN ORDINE DI DIMENSIONE

Cabin filters listed by dimension

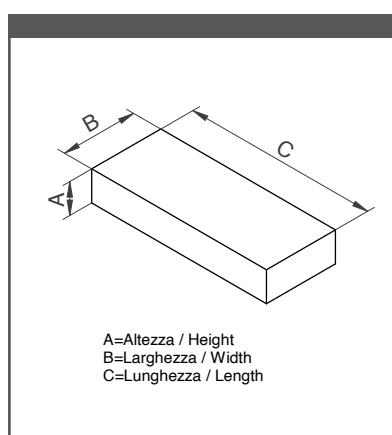

PART. N.	A		B		C	
	mm	inch	mm	inch	mm	inch
8601920700	188	7,40	145	5,71	846	33,31
8601879500	177	6,97	250	9,84	297	11,69
8601880700	177	6,97	250	9,84	297	11,69
8601880800	177	6,97	250	9,84	297	11,69
8601880900	177	6,97	250	9,84	297	11,69
8601881100	177	6,97	250	9,84	297	11,69
8601491000	150	5,91	350	13,78	450	17,72
8601501500	150	5,91	450	17,72	475	18,70
8601409000	133	5,24	380	14,96	382	15,04
8601409500	133	5,24	380	14,96	382	15,04
8601872400	110	4,33	100	3,94	501	19,72
8601873900	110	4,33	100	3,94	500	19,69
8601891100	110	4,33	100	3,94	500	19,69
8601897900	110	4,33	100	3,94	500	19,69
8601898200	110	4,33	100	3,94	500	19,69
8601896400	107	4,21	129	5,08	690	27,17
8601896500	100	3,94	285	11,22	480	18,90
8601867100	95	3,74	170	6,69	300	11,81
8601823500	87	3,43	103	4,06	610	24,02
8601862400	85	3,35	100	3,94	500	19,69
8601866900	85	3,35	100	3,94	500	19,69
8601873800	85	3,35	150	5,91	440	17,32
8601848800	84	3,31	369	14,53	779	30,67
8601857600	82	3,23	405	15,94	610	24,02
8601569300	80	3,15	172	6,77	597	23,50
8601570000	80	3,15	278	10,94	320	12,60
8601744800	80	3,15	119	4,69	316	12,44
8601810600	80	3,15	515	20,28	760	29,92
8601932600	80	3,15	191	7,52	316	12,44
8601982500	75	2,95	120	4,72	520	20,47
8601984500	72	2,83	137	5,39	760	29,92
8601986400	72	2,83	135	5,31	760	29,92
8601569900	70	2,76	278	10,94	320	12,60
8601858700	70	2,76	240	9,45	375	14,76
8601811600	66	2,60	128	5,04	740	29,13
8601716400	65	2,56	103	4,06	650	25,59
8601716500	65	2,56	103	4,06	650	25,59
8601717000	65	2,56	103	4,06	650	25,59
8601701300	64	2,52	100	3,94	550	21,65
8601874500	64	2,52	100	3,94	550	21,65
8601817400	63,5	2,50	263	10,35	360	14,17
8601589100	61	2,40	135	5,31	880	34,65
8601547000	60	2,36	497	19,57	497	19,57
8601569000	60	2,36	172	6,77	602	23,70
8601966200	60	2,36	114	4,49	450	17,72
8601764400	58	2,28	142	5,59	275	10,83
8601817300	58	2,28	123	4,84	472	18,58
8601857100	58	2,28	169	6,65	343	13,50

PART. N.	A		B		C	
	mm	inch	mm	inch	mm	inch
8601929300	58	2,28	135	5,31	625	24,61
8601567100	57,5	2,26	179,5	7,07	278	10,94
8601783800	57	2,24	150	5,91	256	10,08
8601567700	56	2,20	609	23,98	609	23,98
8601618500	56	2,20	116	4,57	470	18,50
8601756100	56	2,20	245	9,65	700	27,56
8601756200	56	2,20	245	9,65	700	27,56
8601806400	56	2,20	230	9,06	700	27,56
8601811500	56	2,20	158	6,22	700	27,56
8601836000	56	2,20	140	5,51	240	9,45
8601847400	56	2,20	115	4,53	740	29,13
8601857400	56	2,20	355	13,98	400	15,75
8601857500	56	2,20	130	5,12	500	19,69
8601858300	56	2,20	130	5,12	400	15,75
8601858400	56	2,20	130	5,12	400	15,75
8601859400	56	2,20	100	3,94	500	19,69
8601859500	56	2,20	150	5,91	580	22,83
8601860000	56	2,20	355	13,98	400	15,75
8601860100	56	2,20	130	5,12	500	19,69
8601860200	56	2,20	100	3,94	500	19,69
8601864900	56	2,20	158	6,22	372	14,65
8601870300	56	2,20	140	5,51	240	9,45
8601871400	56	2,20	280	11,02	280	11,02
8601871500	56	2,20	140	5,51	240	9,45
8601924800	56	2,20	130	5,12	450	17,72
8601568800	55	2,17	110	4,33	602	23,70
8601689200	55	2,17	110	4,33	602	23,70
8601756900	55	2,17	80	3,15	425	16,73
8601806300	55	2,17	158	6,22	700	27,56
8601857000	55	2,17	100	3,94	590	23,23
8601858500	55	2,17	100	3,94	590	23,23
8601859200	55	2,17	150	5,91	580	22,83
8601864800	55	2,17	150	5,91	400	15,75
8601871900	55	2,17	70	2,76	635	25,00
8601872600	55	2,17	70	2,76	635	25,00
8601909200	55	2,17	138	5,43	338	13,31
8601981000	55	2,17	214	8,43	270	10,63
8601701400	54	2,13	116	4,57	280	11,02
8601701600	54	2,13	116	4,57	280	11,02
8601800500	53	2,09	131	5,16	246	9,69
8601836400	53	2,09	131	5,16	246	9,69
8601807300	52	2,05	127,5	5,02	228,5	9,00
8601673800	51	2,01	179	7,05	183	7,20
8601680000	51	2,01	88	3,46	89	3,50
8601680300	51	2,01	142,5	5,61	142,5	5,61
8601751700	51	2,01	249	9,80	378	14,88
8601757100	51	2,01	99	3,90	399	15,71
8601812100	51	2,01	142	5,59	437	17,20

PART. N.	A		B		C	
	mm	inch	mm	inch	mm	inch
8601832700	51	2,01	99	3,90	399	15,71
8601834700	51	2,01	99	3,90	399	15,71
8601849800	51	2,01	99	3,90	399	15,71
8601894300	51	2,01	148	5,83	348	13,70
8601962000	51	2,01	127	5,00	228	8,98
8601570100	50	1,97	104	4,09	520	20,47
8601703600	50	1,97	130	5,12	380	14,96
8601705200	50	1,97	130	5,12	380	14,96
8601721700	50	1,97	70	2,76	650	25,59
8601738300	50	1,97	104	4,09	520	20,47
8601753400	50	1,97	104	4,09	520	20,47
8601763300	50	1,97	119	4,69	494	19,45
8601775700	50	1,97	140	5,51	420	16,54
8601813500	50	1,97	70	2,76	662	26,06
8601856900	50	1,97	195	7,68	420	16,54
8601857200	50	1,97	170	6,69	300	11,81
8601857300	50	1,97	170	6,69	300	11,81
8601907100	50	1,97	104	4,09	520	20,47
8601985400	50	1,97	260	10,24	430	16,93
8601990400	50	1,97	178	7,01	585	23,03
8601544100	48	1,89	210	8,27	210	8,27
8601701200	48	1,89	104	4,09	520	20,47
8601748000	48	1,89	65	2,56	425	16,73
8601802600	48	1,89	119	4,69	407	16,02
8601876900	48	1,89	280	11,02	120	4,72
8601884700	48	1,89	65	2,56	425	16,73
8601885000	48	1,89	193	7,60	346	13,62
8601886600	48	1,89	260	10,24	285	11,22
8601585700	47	1,85	88,5	3,48	135	5,31
8601792400	47	1,85	79	3,11	490	19,29
8601841800	47	1,85	118	4,65	309	12,17
8601905600	47	1,85	79	3,11	490	19,29
8601804400	45	1,77	194	7,64	391	15,39
8601938200	45	1,77	281	11,06	476	18,74
8601926800	44	1,73	114	4,49	195	7,68
8601839500	42	1,65	93	3,66	174	6,85
8601863000	42	1,65	109	4,29	190	7,48
8601889900	42	1,65	96	3,78	143	5,63
8601808400	41	1,61	230	9,06	270	10,63
8601873200	41	1,61	134	5,28	340	13,39
8601752500	40	1,57	275	10,83	404	15,91
8601763200	40	1,57	110	4,33	466	18,35
8601776700	40	1,57	181,5	7,15	403	15,87
8601784200	40	1,57	281	11,06	316	12,44
8601793400	40	1,57	60	2,36	470	18,50
8601793500	40	1,57	60	2,36	470	18,50
8601837700	40	1,57	303	11,93	376	14,80
8601839900	40	1,57	194,5	7,66	394,5	15,53

PART. N.	A		B		C	
	mm	inch	mm	inch	mm	inch
8601845000	40	1,57	150	5,91	430	16,93
8601853600	40	1,57	60	2,36	470	18,50
8601853700	40	1,57	60	2,36	470	18,50
8601871200	40	1,57	194,5	7,66	394,5	15,53
8601871600	40	1,57	100	3,94	249	9,80
8601871700	40	1,57	100	3,94	249	9,80
8601925700	40	1,57	195	7,68	475	18,70
8601928400	40	1,57	322	12,68	216	8,50
8601762900	38	1,50	100	3,94	470	18,50
8601834100	38	1,50	157	6,18	280	11,02
8601894200	38	1,50	148	5,83	348	13,70
8601784400	37,5	1,48	174	6,85	510	20,08
8601855900	37,5	1,48	174	6,85	500	19,69
8601856300	37,5	1,48	168	6,61	400	15,75
8601715900	37	1,46	75	2,95	155	6,10
8601716600	37	1,46	75	2,95	345	13,58
8601716700	37	1,46	75	2,95	155	6,10
8601716800	37	1,46	75	2,95	345	13,58
8601849900	37	1,46	171	6,73	342,5	13,48
8601891700	35	1,38	150	5,91	261	10,28
8601893200	34	1,34	145	5,71	391	15,39
8601761100	32	1,26	-	-	207	8,15
8601810100	31	1,22	335	13,19	365	14,37
8601568000	30,5	1,20	123,5	4,86	323	12,72
8601896200	30,5	1,20	140	5,51	600	23,62
8601781600	30	1,18	180	7,09	410	16,14
8601839200	30	1,18	180	7,09	408	16,06
8601873300	30	1,18	125	4,92	390	15,35
8601886000	30	1,18	59	2,32	322	12,68
8601886200	30	1,18	84	3,31	484	19,06
8601886900	30	1,18	186	7,32	243	9,57
8601891000	30	1,18	64	2,52	239	9,41
8601893500	30	1,18	120	4,72	636	25,04
8601893600	30	1,18	120	4,72	636	25,04
8601900000	30	1,18	150	5,91	190	7,48
8601928700	30	1,18	367	14,45	440	17,32
8601835300	29	1,14	238	9,37	437	17,20
8601867800	28	1,10	347	13,66	545	21,46
8601867900	28	1,10	277	10,91	353	13,90
8601868000	28	1,10	231	9,09	390	15,35
8601868100	28	1,10	120	4,72	342	13,46
8601784600	27	1,06	106	4,17	224	8,82
8601896100	27	1,06	126	4,96	415	16,34
8601884800	26,5	1,04	60	2,36	382	15,04
8601725700	26	1,02	68,5	2,70	85,5	3,37
8601945900	25,5	1,00	60	2,36	385	15,16
8601966700	25	0,98	293	11,54	293	11,54
8601929000	25	0,98	400	15,75	600	23,62

PART. N.	A		B		C	
	mm	inch	mm	inch	mm	inch
8601865800	25	0,98	104	4,09	556	21,89
8601885800	25	0,98	94	3,70	356	14,02
8601885900	25	0,98	94	3,70	356	14,02
8601887900	25	0,98	75	2,95	230	9,06
8601890800	25	0,98	100	3,94	381	15,00
8601890900	25	0,98	100	3,94	180	7,09
8601896300	25	0,98	147	5,79	600	23,62
8601902000	25	0,98	178	7,01	248	9,76
8601912200	25	0,98	100	3,94	287	11,30
8601941900	25	0,98	162	6,38	198	7,80
8601956900	25	0,98	199	7,83	267	10,51
8601866600	24	0,94	122,5	4,82	600	23,62
8601886100	23	0,91	105	4,13	305	12,01
8601886500	23	0,91	105	4,13	305	12,01
8601893700	22,5	0,89	57	2,24	680	26,77
8601893800	22,5	0,89	57	2,24	680	26,77
8601836800	22	0,87	111	4,37	120,5	4,74
8601836900	22	0,87	177,8	7,00	273	10,75
8601865700	22	0,87	124	4,88	357	14,06
8601899900	22	0,87	130	5,12	136,5	5,37
8601924400	21,5	0,85	145	5,71	366	14,41
8601566000	21	0,83	75	2,95	75	2,95
8601585600	21	0,83	112	4,41	131	5,16
8601680500	21	0,83	75	2,95	75	2,95
8601884600	21	0,83	154	6,06	320	12,60
8601915800	20,5	0,81	131,5	5,18	260,5	10,26
8601748300	20	0,79	80	3,15	280	11,02
8601748700	20	0,79	100	3,94	417	16,42
8601820300	20	0,79	110	4,33	429	16,89
8601835000	20	0,79	149	5,87	440	17,32
8601835500	20	0,79	100	3,94	417	16,42
8601835600	20	0,79	201	7,91	263	10,35
8601835700	20	0,79	179	7,05	441	17,36
8601835800	20	0,79	96	3,78	413	16,26
8601838700	20	0,79	250	9,84	410	16,14
8601855800	20	0,79	180	7,09	218	8,58
8601864700	20	0,79	105	4,13	262	10,31
8601887100	20	0,79	109	4,29	376	14,80
8601887200	20	0,79	109	4,29	376	14,80
8601887300	20	0,79	221	8,70	390	15,35
8601889700	20	0,79	162	6,38	382	15,04
8601942400	20	0,79	150	5,91	330	12,99
8601956400	20	0,79	74	2,91	114	4,49
8601839300	18	0,71	237	9,33	300	11,81
8601877400	18	0,71	155	6,10	215	8,46
8601744300	17	0,67	84	3,31	447	17,60
8601744400	17	0,67	84	3,31	447	17,60
8601755500	17	0,67	165	6,50	240	9,45

PART. N.	A		B		C	
	mm	inch	mm	inch	mm	inch
8601763000	17	0,67	157	6,18	343	13,50
8601763100	17	0,67	142	5,59	461,5	18,17
8601781700	17	0,67	102	4,02	834	32,83
8601840800	17	0,67	214	8,43	214	8,43
8601840900	17	0,67	78	3,07	383	15,08
8601841000	17	0,67	220	8,66	375	14,76
8601841600	17	0,67	132	5,20	385	15,16
8601856800	17	0,67	110	4,33	309	12,17
8601876100	17	0,67	142	5,59	461,5	18,17
8601961600	17	0,67	79	3,11	335	13,19
8601839800	16	0,63	238	9,37	206	8,11
8601784700	15	0,59	195	7,68	300	11,81
8601793300	15	0,59	64	2,52	514	20,24
8601839600	15	0,59	181	7,13	356	14,02
8601862100	15	0,59	64	2,52	514	20,24
8601877500	15	0,59	170	6,69	207	8,15
8601893900	15	0,59	95	3,74	192	7,56
8601894000	15	0,59	150	5,91	314	12,36
8601913700	15	0,59	98	3,86	344	13,54
8601911600	13	0,51	108	4,25	205	8,07
8601871300	13	0,51	102	4,02	432	17,01
8601914700	13	0,51	93	3,66	448	17,64
8601839400	13	0,51	88	3,46	628	24,72
8601839700	12	0,47	195	7,68	451	17,76
8601906800	12	0,47	155	6,10	326	12,83
8601877600	10	0,39	72	2,83	96	3,78
8601886700	10	0,39	232	9,13	349	13,74
8601891200	10	0,39	290	11,42	478	18,82
8601894100	10	0,39	175,5	6,91	391,5	15,41
8601911800	10	0,39	118	4,65	209,5	8,25
8601911700	8	0,31	117	4,61	303	11,93

virgis.com
CREATIVE FILTRATION

Le informazioni contenute in questo catalogo, sono state inserite con la massima attenzione. La Virgis Filter si riserva il diritto di modificare le specifiche tecniche ed altri dati senza alcun preavviso.

The informations, contained in this catalog, are insert with maximun attention. Virgis Filter reserves the right to make any changes without prior notification. Therefore technical data are subject to modifications.



VIRGIS FILTER S.p.A.
35010 - ARSEGO (PD) Italy
Via Piovego 113 - Z. I.
T. +39 049 5742099 r.a.
F. +39 049 5742420

virgis@virgis.com
www.virgis.com