



## AMCO DIFFUSER TYPE FLUORESCENT BASE

AVAILABLE IN OPAL WHITE & PRISMATIC ACRYLIC

### DIFFUSER TYPE FLUORESCENT BASE

Without tube, ballast, starter and lamp holder with acrylic diffuser.  
Available in white and prismatic.



MODEL NO.	WATTS	L	W	H
<b>AP 2252</b>	<b>2 / 20</b>	<b>24" (610mm)</b>	<b>7 1/2" (190.5mm)</b>	<b>3 3/8" (86mm)</b>
<b>AP 2255</b>	<b>2 / 40</b>	<b>48" (1.2192m)</b>	<b>7 1/2" (190.5mm)</b>	<b>3 3/8" (86mm)</b>

### DIFFUSER TYPE FLUORESCENT BASE

Without tube, ballast, starter and lamp holder with acrylic diffuser.  
Available in white and prismatic.

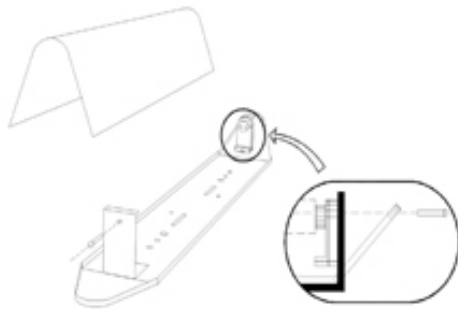

MODEL NO.	WATTS	L	W	H
<b>AP 2250</b>	<b>1 / 20</b>	<b>24" (610mm)</b>	<b>4 1/2" (114mm)</b>	<b>4 1/4" (108mm)</b>
<b>AP 2251</b>	<b>1 / 40</b>	<b>48" (1.2192m)</b>	<b>4 1/2" (114mm)</b>	<b>4 1/4" (108mm)</b>

## AMCO GRACE TYPE FLUORESCENT BASE

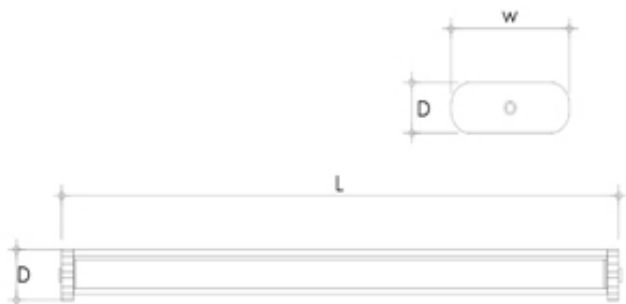

MODEL NO.	WATTS	L	W	D
<b>AP 1201</b>	<b>2 / 20</b>	<b>24" (610mm)</b>	<b>8" (203.2mm)</b>	<b>3 1/2" (88.9mm)</b>
<b>AP 1202</b>	<b>2 / 40</b>	<b>48" (1219.2mm)</b>	<b>8" (203.2mm)</b>	<b>3 1/2" (88.9mm)</b>

## AMCO SURFACE TYPE FLUORESCENT BASE

MIRRORIZED ALUMINUM or WHITE POWDER COATED REFLECTOR



Mirrorized Aluminum Reflector

MODEL NO. 1242 AD /20W  
1244 AD /40W



White Powder Coated Reflector

MODEL NO. 1242 D /20W  
1244 D /40W



SPRING LOADED  
LAMP HOLDER

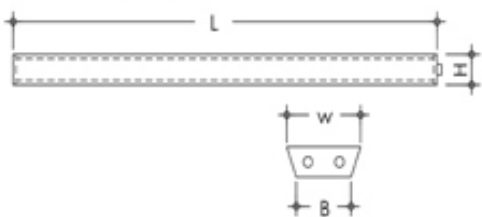

(BASE ONLY w/ Spring Loaded Lamp Holder)

MODEL NO.	WATTS	L	W	H	B
1242 D	20W	24" (610mm)	12" (305mm)	2 1/4" (57mm)	10" (254mm)
1242 AD	20W	24" (610mm)	12" (305mm)	2 1/4" (57mm)	10" (254mm)
1244 D	40W	48" (1219mm)	12" (305mm)	2 1/4" (57mm)	10" (254mm)
1244 AD	40W	48" (1219mm)	12" (305mm)	2 1/4" (57mm)	10" (254mm)



Mirrorized Aluminum Reflector

MODEL NO. 1242 A /20W  
1244 A /40W



White Powder Coated Reflector

MODEL NO. 1242 /20W  
1244 /40W



SPRING LOADED  
LAMP HOLDER

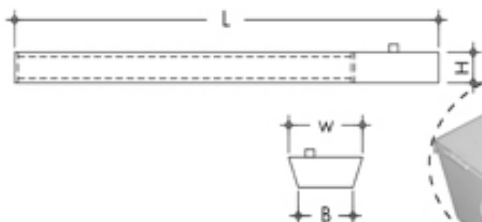

(BASE ONLY w/ Spring Loaded Lamp Holder)

MODEL NO.	WATTS	L	W	H	B
1242	20W	30" (762mm)	5 5/8" (143mm)	2" (51mm)	3 5/8" (92mm)
1242 A	20W	30" (762mm)	5 5/8" (143mm)	2" (51mm)	3 5/8" (92mm)
1244	40W	54" (1372mm)	5 5/8" (143mm)	2" (51mm)	3 5/8" (92mm)
1244 A	40W	54" (1372mm)	5 5/8" (143mm)	2" (51mm)	3 5/8" (92mm)

## AMCO BUTTERFLY TYPE FLUORESCENT BASE



SPRING LOADED  
LAMP HOLDER

WHITE POWDER COATED REFLECTOR  
MODEL NO.: 1252 / 20W  
1255 / 40W



Also Available: MIRRORIZED ALUMINUM REFLECTOR  
MODEL NO.: 1252 A / 20W  
1255 A / 40W

MODEL NO.	WATTS	L	W	H	B
1252	20w	24" (610mm)	12" (305mm)	4" (102mm)	3" (76mm)
1252 A	20w	24" (610mm)	12" (305mm)	4" (102mm)	3" (76mm)
1255	40w	48" (1219mm)	12" (305mm)	4" (102mm)	3" (76mm)
1255 A	40w	48" (1219mm)	12" (305mm)	4" (102mm)	3" (76mm)

## AMCO CONVEX TYPE FLUORESCENT BASE



WHITE POWDER COATED  
REFLECTOR



MODEL NO.	FLUO. / WATTS	L	W	H
AP 1092-D	2 / 20w	25 1/2" (647.7mm)	8" (203.2mm)	3 1/2" (88.9mm)
AP 1092	4 / 40w	29 1/2" (749.3mm)	8" (203.2mm)	3 1/2" (88.9mm)

## AMCO BOX TYPE FLUORESCENT BASE WITH WELDED WIRE GUARD



AMCO BOX TYPE FLUORESCENT BASE  
WITH WELDED WIRE GUARD

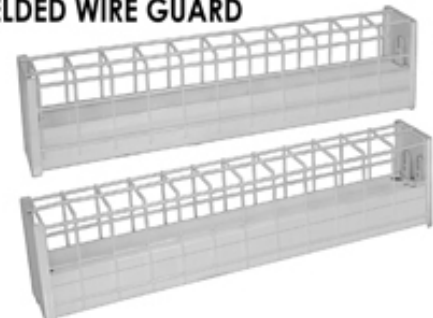

MODEL NO.	FLUO. / WATTS	L	W	H
AP-2250-W	1 / 20w	24" (610mm)	3 1/4" (83mm)	5" (127mm)
AP-2252-W	2 / 20w	24" (610mm)	4" (102mm)	5" (127mm)
AP-2251-W	1 / 40w	48" (1219mm)	3 1/4" (83mm)	5" (127mm)
AP-2255-W	2 / 40w	48" (1219mm)	4" (102mm)	5" (127mm)

## AMCO SILICON FLUORESCENT BASE

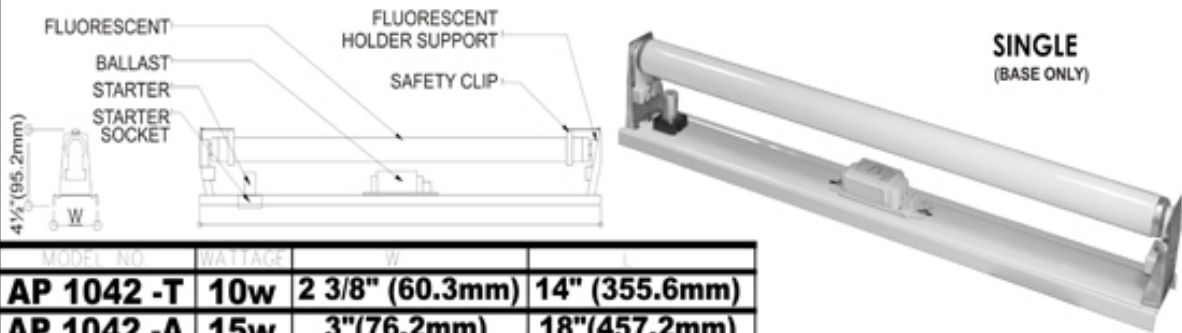

MODEL NO	WATTAGE	W	L
<b>AP 1042 -T</b>	<b>10w</b>	<b>2 3/8" (60.3mm)</b>	<b>14" (355.6mm)</b>
<b>AP 1042 -A</b>	<b>15w</b>	<b>3" (76.2mm)</b>	<b>18" (457.2mm)</b>
<b>AP 1042 -B</b>	<b>20w</b>	<b>3" (76.2mm)</b>	<b>24" (609.6mm)</b>
<b>AP 1043</b>	<b>30w</b>	<b>3" (76.2mm)</b>	<b>36" (914.4mm)</b>
<b>AP 1044</b>	<b>40w</b>	<b>3" (76.2mm)</b>	<b>48" (1219.2mm)</b>

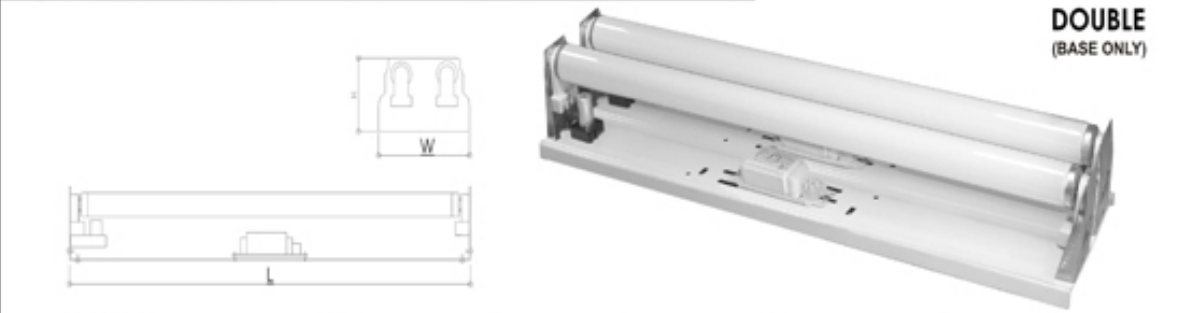

MODEL NO	WATTAGE	D	W	L
<b>AP 1042 -C</b>	<b>20w</b>	<b>4 1/4" (107.95mm)</b>	<b>6 1/4" (158.75mm)</b>	<b>24" (609.6mm)</b>
<b>AP 1043 -B</b>	<b>30w</b>	<b>4 1/4" (107.95mm)</b>	<b>6 1/4" (158.75mm)</b>	<b>36" (914.4mm)</b>
<b>AP 1044 -B</b>	<b>40w</b>	<b>4 1/4" (107.95mm)</b>	<b>6 1/4" (158.75mm)</b>	<b>48" (1219.2mm)</b>

### AMCO REFLECTOR (BASE ONLY)

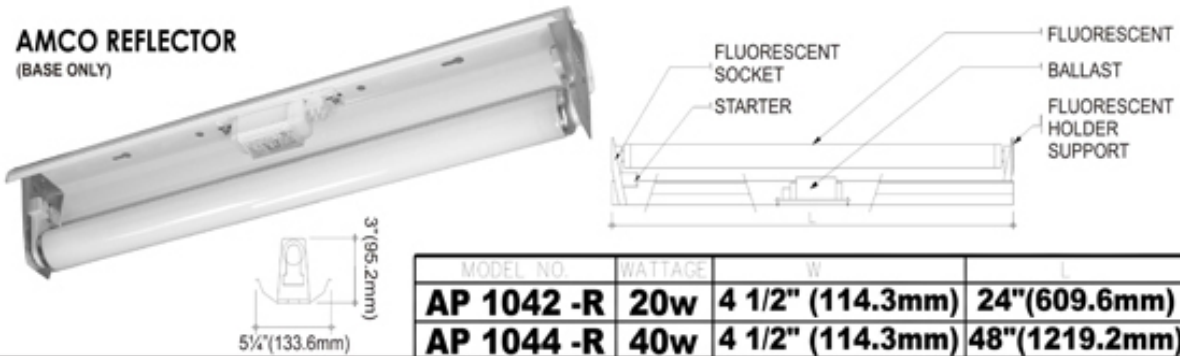

### AMCO CEILING TYPE FLUORESCENT BASE (BASE ONLY)

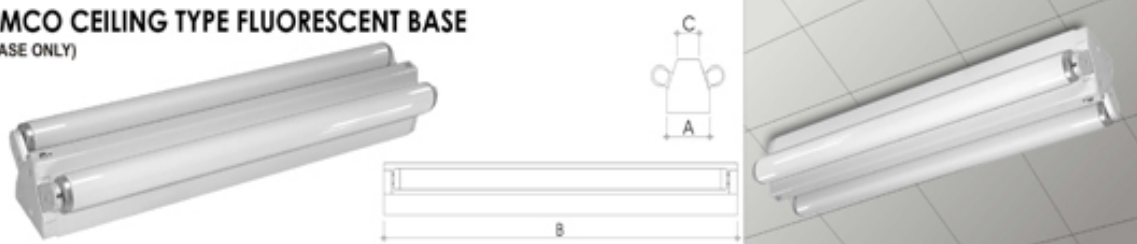

MODEL NO	WATTAGE	A	L	C	D
<b>AP 1091 -D</b>	<b>2-20w</b>	<b>5 1/8" (130.1mm)</b>	<b>24" (609.6mm)</b>	<b>3 1/4" (82.5mm)</b>	<b>3" (76.2mm)</b>
<b>AP 1091</b>	<b>2-40w</b>	<b>5 1/8" (130.1mm)</b>	<b>48" (1219.2mm)</b>	<b>3 1/4" (82.5mm)</b>	<b>3" (76.2mm)</b>

## AMCO STRIP TYPE FLUORESCENT BASE

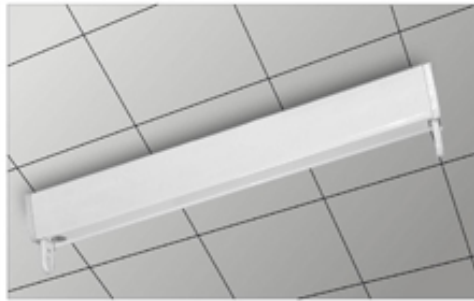

**SINGLE STRIP TYPE FLUORESCENT BASE**  
(CLOSE TYPE)



(BASE ONLY)

MODEL NO.	WATTAGE	A	B	C	D
<b>AP 1045</b>	<b>15w</b>	<b>3"(76.2mm)</b>	<b>18"(457.2mm)</b>	<b>2 1/2"(63.5mm)</b>	<b>4"(101.6mm)</b>
<b>AP 1046</b>	<b>20w</b>	<b>3"(76.2mm)</b>	<b>24"(609.6mm)</b>	<b>2 1/2"(63.5mm)</b>	<b>4"(101.6mm)</b>
<b>AP 1047 B</b>	<b>30w</b>	<b>3"(76.2mm)</b>	<b>36"(914.4mm)</b>	<b>2 1/2"(63.5mm)</b>	<b>4"(101.6mm)</b>
<b>AP 1047</b>	<b>40w</b>	<b>3"(76.2mm)</b>	<b>48"(1219.2mm)</b>	<b>2 1/2"(63.5mm)</b>	<b>4"(101.6mm)</b>

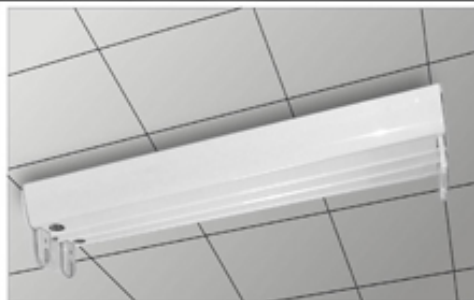

**DOUBLE STRIP TYPE FLUORESCENT BASE**  
(CLOSE TYPE)

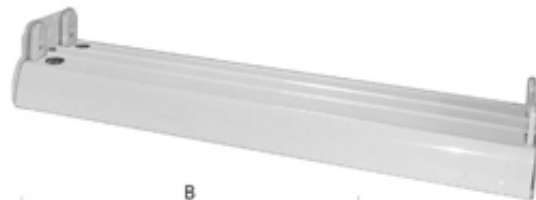

(BASE ONLY)

MODEL NO.	WATTAGE	A	B	C	D
<b>AP 1048</b>	<b>20w</b>	<b>6"(152.4mm)</b>	<b>24"(609.6mm)</b>	<b>2 1/4"(57.15mm)</b>	<b>3 3/4"(95.25mm)</b>
<b>AP 1048 A</b>	<b>30w</b>	<b>6"(152.4mm)</b>	<b>36"(914.4mm)</b>	<b>2 1/4"(57.15mm)</b>	<b>3 3/4"(95.25mm)</b>
<b>AP 1049</b>	<b>40w</b>	<b>6"(152.4mm)</b>	<b>48"(1219.2mm)</b>	<b>2 1/4"(57.15mm)</b>	<b>3 3/4"(95.25mm)</b>

**AMCO STRIP TYPE FLUORESCENT BASE**  
(CLOSE TYPE)

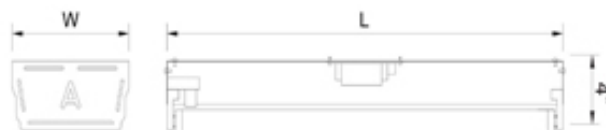

(BASE ONLY)

MODEL NO.	WATTAGE	W	L
<b>AP 1048-B</b>	<b>20w</b>	<b>8"(203.2mm)</b>	<b>24"(609.6mm)</b>
<b>AP 1049-B</b>	<b>40w</b>	<b>8"(203.2mm)</b>	<b>48"(1219.2mm)</b>

## AMCO BOX TYPE FLUORESCENT BASE

<p>(BASE ONLY)</p>				
	MODEL NO.	WATTAGE	W	L
	<b>AP 1058-A</b>	<b>1-15w</b>	<b>2 3/4" (69.85mm)</b>	<b>18"(457.2mm)</b>
	<b>AP 1058</b>	<b>1-20w</b>	<b>2 3/4" (69.85mm)</b>	<b>24"(609.6mm)</b>
	<b>AP 1062-A</b>	<b>1-30w</b>	<b>2 3/4" (69.85mm)</b>	<b>36"(914.4mm)</b>
	<b>AP 1062</b>	<b>1-40w</b>	<b>2 3/4" (69.85mm)</b>	<b>48"(1219.2mm)</b>
<p>(BASE ONLY)</p>				
	MODEL NO.	WATTAGE	W	L
	<b>AP 1059-A</b>	<b>2-15w</b>	<b>3 1/2" (88.9mm)</b>	<b>18"(457.2mm)</b>
	<b>AP 1059</b>	<b>2-20w</b>	<b>3 1/2" (88.9mm)</b>	<b>24"(609.6mm)</b>
	<b>AP 1063-A</b>	<b>2-30w</b>	<b>3 1/2" (88.9mm)</b>	<b>36"(914.4mm)</b>
	<b>AP 1063</b>	<b>2-40w</b>	<b>3 1/2" (88.9mm)</b>	<b>48"(1219.2mm)</b>
<p>(BASE ONLY)</p>				
	MODEL NO.	WATTAGE	W	L
	<b>AP 1060-A</b>	<b>3-15w</b>	<b>6" (152.4mm)</b>	<b>18"(457.2mm)</b>
	<b>AP 1060</b>	<b>3-20w</b>	<b>6" (152.4mm)</b>	<b>24"(609.6mm)</b>
	<b>AP 1064-A</b>	<b>3-30w</b>	<b>6" (152.4mm)</b>	<b>36"(914.4mm)</b>
	<b>AP 1064</b>	<b>3-40w</b>	<b>6" (152.4mm)</b>	<b>48"(1219.2mm)</b>
<p>(BASE ONLY)</p>				
	MODEL NO.	WATTAGE	W	L
	<b>AP 1061-A</b>	<b>4-15w</b>	<b>7" (177.8mm)</b>	<b>18"(457.2mm)</b>
	<b>AP 1061</b>	<b>4-20w</b>	<b>7" (177.8mm)</b>	<b>24"(609.6mm)</b>
	<b>AP 1065-A</b>	<b>4-30w</b>	<b>7" (177.8mm)</b>	<b>36"(914.4mm)</b>
	<b>AP 1065</b>	<b>4-40w</b>	<b>7" (177.8mm)</b>	<b>48"(1219.2mm)</b>
<b>AMCO STRIPLITE FLUORESCENT BASE</b> (Slim Box type)				
<p>(BASE ONLY)</p>				
	MODEL NO.	WATTAGE	W	L
	<b>AP 1066-A</b>	<b>15w</b>	<b>2 1/4" (157.1mm)</b>	<b>18"(457.2mm)</b>
	<b>AP 1066-B</b>	<b>20w</b>	<b>2 1/4" (157.1mm)</b>	<b>24"(609.6mm)</b>
	<b>AP 1066-C</b>	<b>40w</b>	<b>2 1/4" (157.1mm)</b>	<b>48"(1219.2mm)</b>
	<b>AP 1066-D</b>	<b>10w</b>	<b>2 1/4" (157.1mm)</b>	<b>14"(355.6mm)</b>

## AMCO BOX TYPE FLUORESCENT BASE (For T-Runner)



(BASE ONLY)

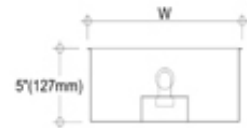

MODEL NO.	WATTAGE	W	L
<b>AP 1202-1</b>	<b>1-20w</b>	<b>12½" (317mm)</b>	<b>24½" (622mm)</b>
<b>AP 1203-1</b>	<b>1-40w</b>	<b>12½" (317mm)</b>	<b>48½" (1232mm)</b>



(BASE ONLY)

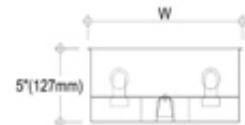

MODEL NO.	WATTAGE	W	L
<b>AP 1206-2</b>	<b>2-20w</b>	<b>12½" (317mm)</b>	<b>24½" (622mm)</b>
<b>AP 1203-2</b>	<b>2-40w</b>	<b>12½" (317mm)</b>	<b>48½" (1232mm)</b>



(BASE ONLY)



MODEL NO.	WATTAGE	W	L
<b>AP 1205-2</b>	<b>2-20w</b>	<b>24½" (622mm)</b>	<b>24½" (622mm)</b>
<b>AP 1204-2</b>	<b>2-40w</b>	<b>24½" (622mm)</b>	<b>48½" (1232mm)</b>



(BASE ONLY)

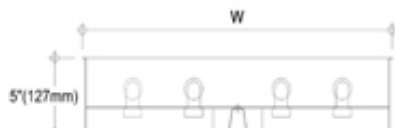

MODEL NO.	WATTAGE	W	L
<b>AP 1205-4</b>	<b>4-20w</b>	<b>24½" (622mm)</b>	<b>24½" (622mm)</b>
<b>AP 1204-4</b>	<b>4-40w</b>	<b>24½" (622mm)</b>	<b>48½" (1232mm)</b>

## AMCO INDUSTRIAL TYPE FLUORESCENT BASE

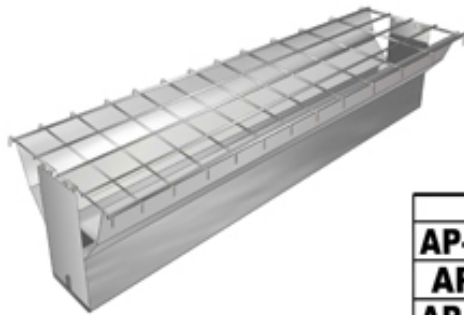

(BASE ONLY w/ WELDED WIRE GUARD)

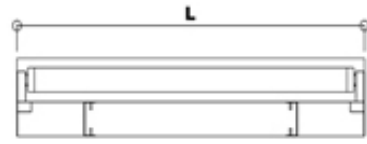
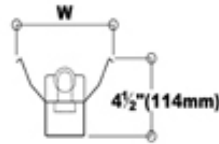

MODEL NO.	WATTAGE	W	L
<b>AP-1050-WBG</b>	<b>1-15w</b>	<b>7"(177.8mm)</b>	<b>18"(457.2mm)</b>
<b>AP-1050-WG</b>	<b>1-20w</b>	<b>7"(177.8mm)</b>	<b>24"(609.6mm)</b>
<b>AP-1051-WBG</b>	<b>1-30w</b>	<b>7"(177.8mm)</b>	<b>36"(914.4mm)</b>
<b>AP-1051-WG</b>	<b>1-40w</b>	<b>7"(177.8mm)</b>	<b>48"(1219.2mm)</b>

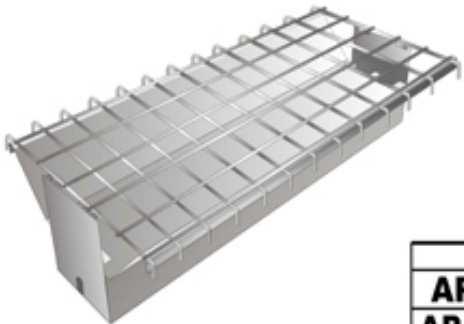

(BASE ONLY w/ WELDED WIRE GUARD)

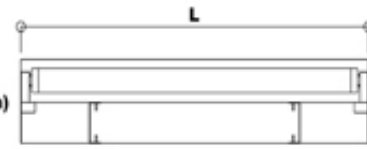
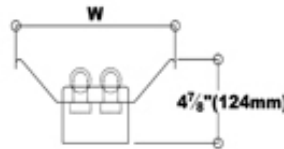

MODEL NO.	WATTAGE	W	L
<b>AP-1052-WG</b>	<b>2-20w</b>	<b>11"(279.4mm)</b>	<b>24"(609.6mm)</b>
<b>AP-1055-WBG</b>	<b>2-30w</b>	<b>11"(279.4mm)</b>	<b>36"(914.4mm)</b>
<b>AP-1055-WG</b>	<b>2-40w</b>	<b>11"(279.4mm)</b>	<b>48"(1219.2mm)</b>

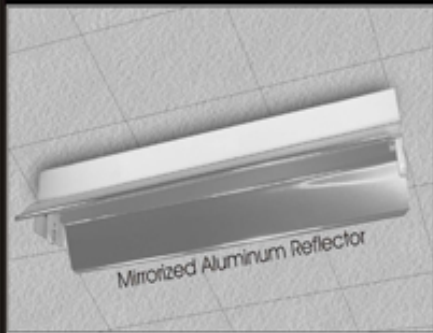

(BASE ONLY w/ SPRING LOADED LAMP HOLDER)

### MIRRORIZED ALUMINUM REFLECTOR



SPRING LOADED LAMP HOLDER

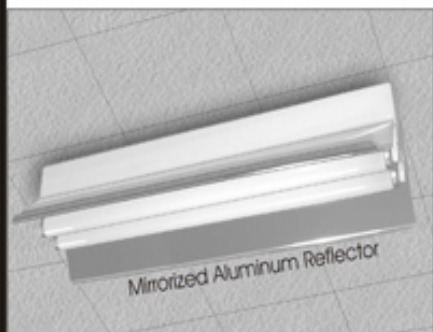
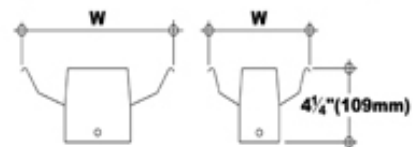
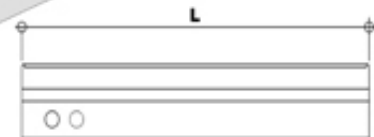

(BASE ONLY w/ SPRING LOADED LAMP HOLDER)

MODEL NO.	WATTAGE	W	L
<b>AP-1050-S-A</b>	<b>1-20w</b>	<b>7"(177.8mm)</b>	<b>24 1/4"(616mm)</b>
<b>AP-1051-S-A</b>	<b>1-40w</b>	<b>7"(177.8mm)</b>	<b>48 1/4"(1226mm)</b>
<b>AP-1052-S-A</b>	<b>2-20w</b>	<b>10 1/2"(266mm)</b>	<b>24 1/4"(616mm)</b>
<b>AP-1055-S-A</b>	<b>2-40w</b>	<b>10 1/2"(266mm)</b>	<b>48 1/4"(1226mm)</b>



## AMCO INDUSTRIAL TYPE FLUORESCENT BASE WITH MIRRORIZED ALUMINUM REFLECTOR

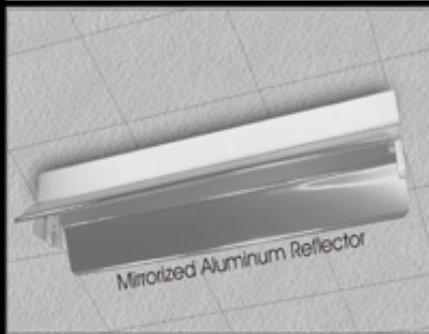

(BASE ONLY)

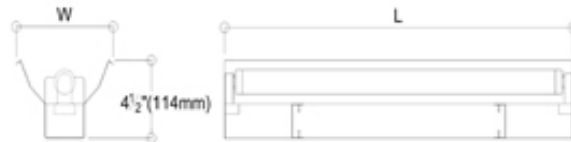

MODEL NO.	WATTAGE	W	L
<b>AP-1050-BA</b>	<b>1-15w</b>	<b>7"(177.8mm)</b>	<b>18"(457.2mm)</b>
<b>AP-1050-A</b>	<b>1-20w</b>	<b>7"(177.8mm)</b>	<b>24"(609.6mm)</b>
<b>AP-1051-BA</b>	<b>1-30w</b>	<b>7"(177.8mm)</b>	<b>36"(914.4mm)</b>
<b>AP-1051-A</b>	<b>1-40w</b>	<b>7"(177.8mm)</b>	<b>48"(1219.2mm)</b>

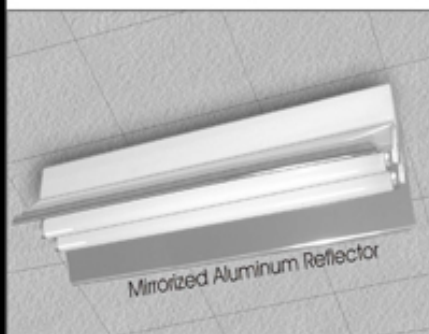

(BASE ONLY)



MODEL NO.	WATTAGE	W	L
<b>AP-1052-A</b>	<b>2-20w</b>	<b>11"(279.4mm)</b>	<b>24"(609.6mm)</b>
<b>AP-1055-CA</b>	<b>2-30w</b>	<b>11"(279.4mm)</b>	<b>36"(914.4mm)</b>
<b>AP-1055-A</b>	<b>2-40w</b>	<b>11"(279.4mm)</b>	<b>48"(1219.2mm)</b>

## AMCO BOX TYPE FLUORESCENT BASE

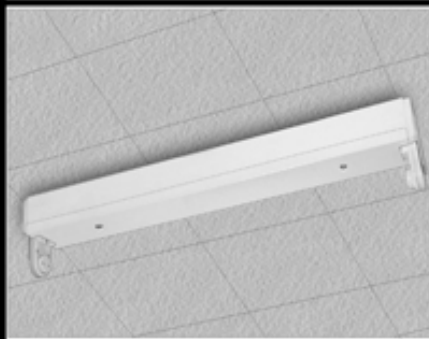

BASE ONLY W/ SPRING LOADED LAMP HOLDER



MODEL NO.	WATTAGE	W	L
<b>AP 1058-S</b>	<b>1-15w</b>	<b>2 3/4" (69.85mm)</b>	<b>19"(483mm)</b>
<b>AP 1058-S</b>	<b>1-20w</b>	<b>2 3/4" (69.85mm)</b>	<b>25"(635mm)</b>
<b>AP 1062-S</b>	<b>1-30w</b>	<b>2 3/4" (69.85mm)</b>	<b>37"(940mm)</b>
<b>AP 1062-S</b>	<b>1-40w</b>	<b>2 3/4" (69.85mm)</b>	<b>49"(1245mm)</b>

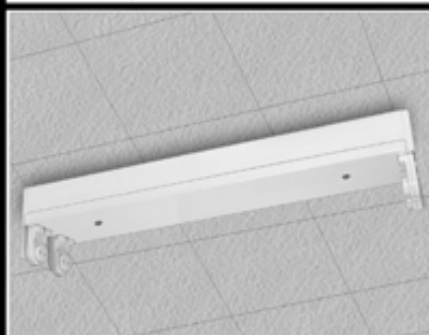

BASE ONLY W/ SPRING LOADED LAMP HOLDER



MODEL NO.	WATTAGE	W	L
<b>AP 1059-S</b>	<b>2-15w</b>	<b>3 1/2" (88.9mm)</b>	<b>19"(483mm)</b>
<b>AP 1059-S</b>	<b>2-20w</b>	<b>3 1/2" (88.9mm)</b>	<b>25"(635mm)</b>
<b>AP 1063-S</b>	<b>2-30w</b>	<b>3 1/2" (88.9mm)</b>	<b>37"(940mm)</b>
<b>AP 1063-S</b>	<b>2-40w</b>	<b>3 1/2" (88.9mm)</b>	<b>49"(1245mm)</b>

## AMCO INDUSTRIAL TYPE FLUORESCENT BASE w/ WHITE POWDER COATED REFLECTOR



(BASE ONLY)

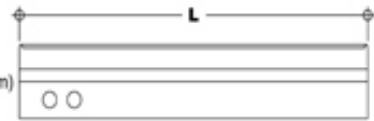
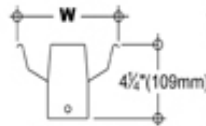

MODEL NO.	WATTAGE	W	L
<b>AP-1050-B</b>	<b>1-15w</b>	<b>7"(177.8mm)</b>	<b>18"(457.2mm)</b>
<b>AP-1050</b>	<b>1-20w</b>	<b>7"(177.8mm)</b>	<b>24"(609.6mm)</b>
<b>AP-1051-B</b>	<b>1-30w</b>	<b>7"(177.8mm)</b>	<b>36"(914.4mm)</b>
<b>AP-1051</b>	<b>1-40w</b>	<b>7"(177.8mm)</b>	<b>48"(1219.2mm)</b>



(BASE ONLY)

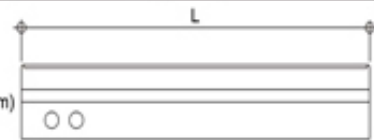
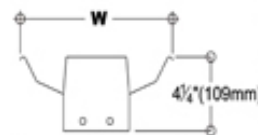

MODEL NO.	WATTAGE	W	L
<b>AP-1052</b>	<b>2-20w</b>	<b>11"(279.4mm)</b>	<b>24"(609.6mm)</b>
<b>AP-1055-C</b>	<b>2-30w</b>	<b>11"(279.4mm)</b>	<b>36"(914.4mm)</b>
<b>AP-1055</b>	<b>2-40w</b>	<b>11"(279.4mm)</b>	<b>48"(1219.2mm)</b>



(BASE ONLY)

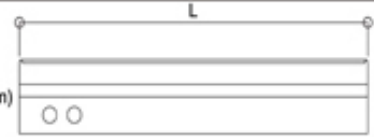
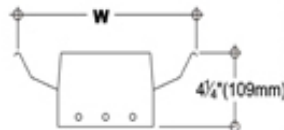

MODEL NO.	WATTAGE	W	L
<b>AP-1053</b>	<b>3-20w</b>	<b>12 1/2"(317.5mm)</b>	<b>24"(609.6mm)</b>
<b>AP-1056</b>	<b>3-40w</b>	<b>12 1/2"(317.5mm)</b>	<b>48"(1219.2mm)</b>



(BASE ONLY)



MODEL NO.	WATTAGE	W	L
<b>AP-1054</b>	<b>4-20w</b>	<b>14 3/4"(374.6mm)</b>	<b>24"(609.6mm)</b>
<b>AP-1057</b>	<b>4-40w</b>	<b>14 3/4"(374.6mm)</b>	<b>48"(1219.2mm)</b>



(BASE ONLY w/ SPRING LOADED LAMP HOLDER)

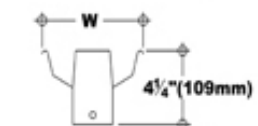
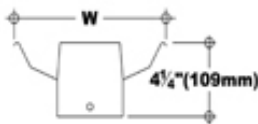

MODEL NO.	WATTAGE	W	L
<b>AP-1050-S</b>	<b>1-20w</b>	<b>7"(177.8mm)</b>	<b>24 1/4"(616mm)</b>
<b>AP-1051-S</b>	<b>1-40w</b>	<b>7"(177.8mm)</b>	<b>48 1/4"(1226mm)</b>
<b>AP-1052-S</b>	<b>2-20w</b>	<b>10 1/2"(266mm)</b>	<b>24 1/4"(616mm)</b>
<b>AP-1055-S</b>	<b>2-40w</b>	<b>10 1/2"(266mm)</b>	<b>48 1/4"(1226mm)</b>