

AMCO ALUMINUM DIE CAST FLOODLIGHT (FOR MERCURY, METAL HALIDE & SODIUM BULB)



- ALUMINUM DIE-CAST HOUSING
- TEMPERED GLASS
- ALUMINUM REFLECTOR
- BULB MEDIUM SOCKET
- BALLAST COMPARTMENT

MODEL NO.	ACCOMMODATE
C-80-AL	W/ BALLAST: 50-125W W/O BALLAST: 160W



FRONT VIEW

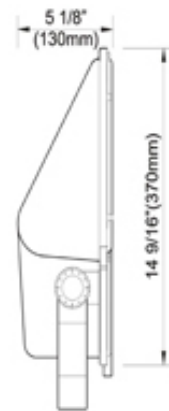

SIDE VIEW



- ALUMINUM DIE-CAST HOUSING
- BULB MOGUL SOCKET
- TEMPERED GLASS
- ALUMINUM REFLECTOR
- BALLAST COMPARTMENT

MODEL NO.	ACCOMMODATE
C-85-AL	W/ BALLAST: 150-400W W/O BALLAST: 250-500W



FRONT VIEW



SIDE VIEW



- ALUMINUM DIE-CAST HOUSING
- TEMPERED GLASS
- BULB MOGUL SOCKET
- ALUMINUM REFLECTOR
- BALLAST COMPARTMENT
- ADAPTER FOR 2" PIPE

MODEL NO.	ACCOMMODATE
C-85-BL	W/ BALLAST: 250-400W

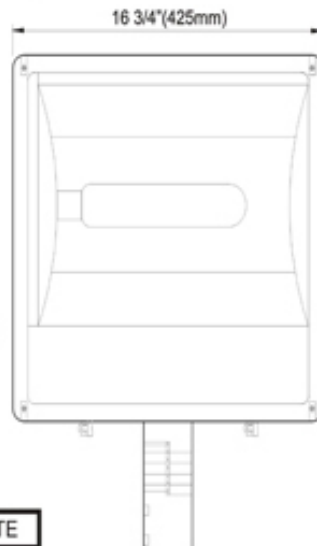

FRONT VIEW



SIDE VIEW

AMCO ALUMINUM DIE-CAST FLOODLIGHT

(FOR MERCURY, METAL HALIDE & SODIUM BULB)



FRONT VIEW

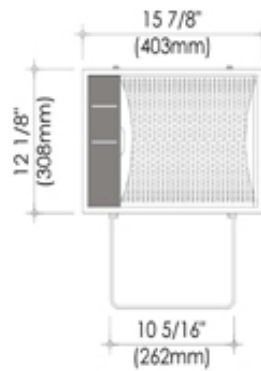

SIDE VIEW

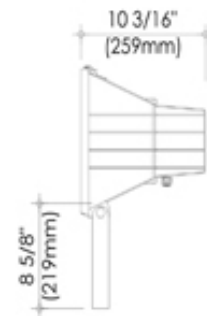

MODEL NO.	ACCOMMODATE
C-85-BB	W/ BALLAST TYPE: 400W BALLASTLESS TYPE: 500W



FRONT VIEW

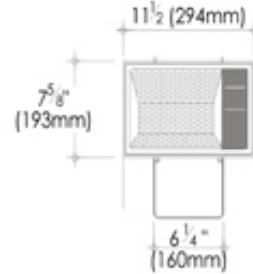

SIDE VIEW

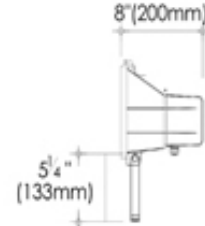

MODEL NO.	ACCOMMODATE
C-80-SS	125W-160W



FRONT VIEW

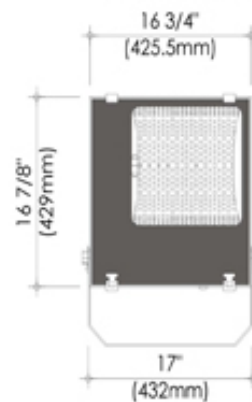

SIDE VIEW

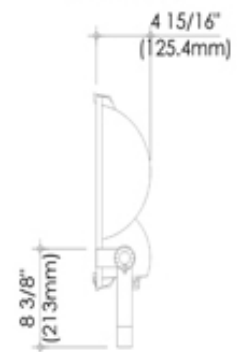

MODEL NO.	ACCOMMODATE
C-85-FB	W/ BALLAST TYPE: 400W BALLAST LESS TYPE: 500W

AMCO ALUMINUM DIE-CAST MERCURY FLOODLIGHT

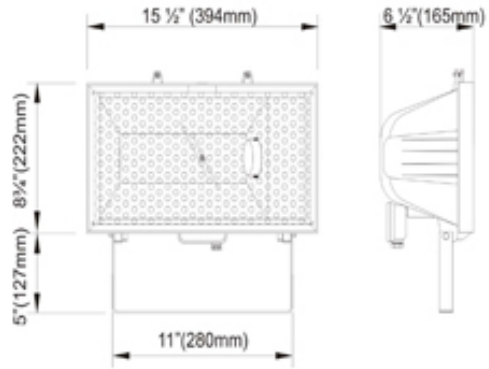
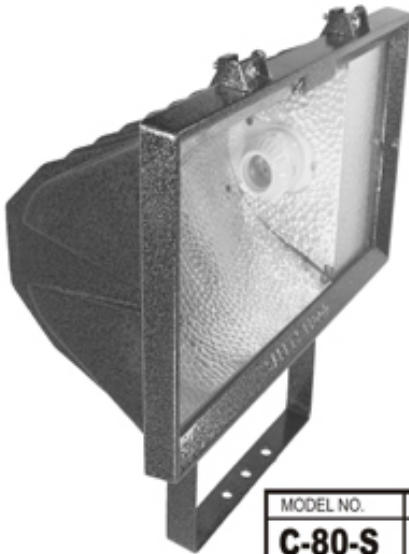

MODEL NO.	ACCOMMODATE
C-80-S	W/ BALLAST: 70-125W W/O BALLAST: 160-250W

FRONT VIEW

SIDE VIEW

AMCO ALUMINUM DIE CAST FLOODLIGHT



- ALUMINUM DIE-CAST HOUSING
- BULB MOGUL SOCKET
- TEMPERED GLASS
- ALUMINUM REFLECTOR
- BALLAST COMPARTMENT

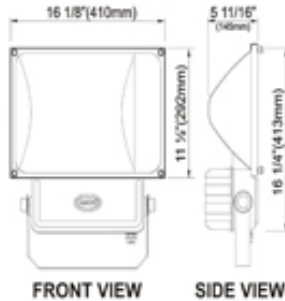

MODEL NO.	ACCOMMODATE
C-85-AL	W/ BALLAST: 150-400W W/O BALLAST: 250-500W

FRONT VIEW

SIDE VIEW

APPROXIMATE HEIGHT OF POST: 20' TO 30'

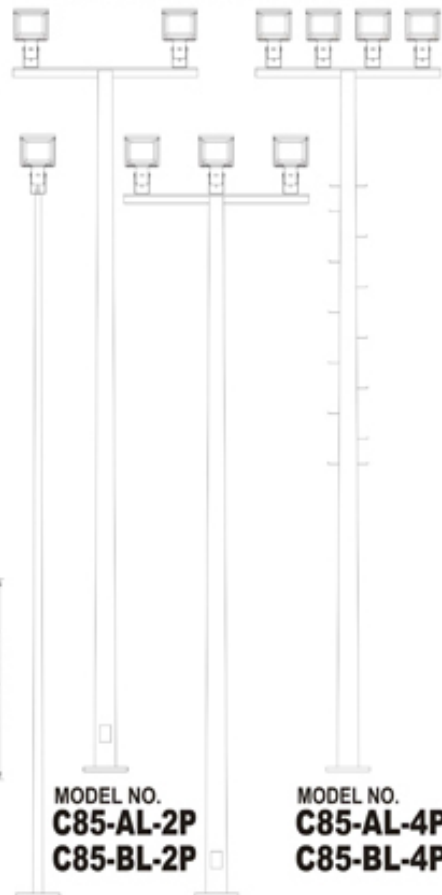

- ALUMINUM DIE-CAST HOUSING
- TEMPERED GLASS
- BULB MOGUL SOCKET
- ALUMINUM REFLECTOR
- BALLAST COMPARTMENT
- ADAPTER FOR 2" PIPE

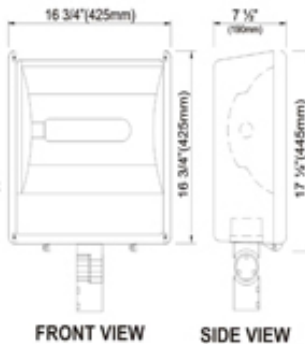

MODEL NO.	ACCOMMODATE
C-85-BL	W/ BALLAST: 250-400W

MODEL NO.
C85-AL-1P
C85-BL-1P

MODEL NO.
C85-AL-3P
C85-BL-3P

MODEL NO.
C85-AL-2P
C85-BL-2P

MODEL NO.
C85-AL-4P
C85-BL-4P

AMCO ALUMINUM DIE-CAST HALOGEN FLOODLIGHT



MODEL NO.
C-90-01-X
(100, 150 & 200 WATTS)



MODEL NO.
C-90-02-X
(250, 300 & 500 WATTS)

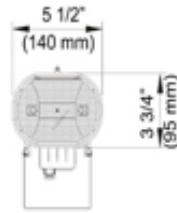

FRONT VIEW



SIDE VIEW

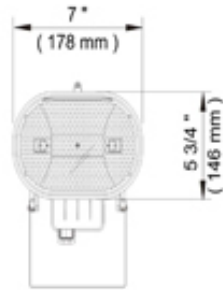

FRONT VIEW



SIDE VIEW



MODEL NO.
C-90-02-BB
(250-500 WATTS)

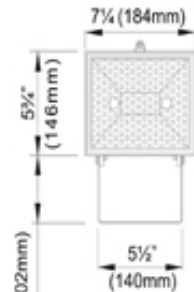

FRONT VIEW

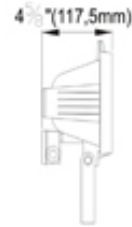

SIDE VIEW



MODEL NO.
C-90-05-BB
(1000-1500 WATTS)

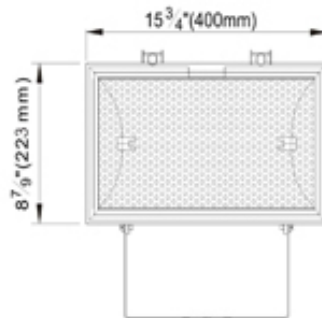

FRONT VIEW



SIDE VIEW

AMCO ALUMINUM DIE-CAST HALOGEN FLOODLIGHT WITH STEEL TAPERED LAMP POST

MODEL NO. C-90-02
(250-500 WATTS)

MODEL NO. C-90-05
(1000-1500 WATTS)

MODEL NO. C-90-1P

MODEL NO. C-90-2P

MODEL NO. C-90-4P

MODEL NO. C-90-6P

MODEL NO. C-90-WP

7" (178mm)
5" (127mm)
5 3/4" (146mm)
3 1/2" (89mm)

FRONT VIEW SIDE VIEW

15 1/2" (394mm)
8 1/2" (216mm)
4 1/2" (115mm)
10 3/4" (273mm)
6 1/4" (159mm)

FRONT VIEW SIDE VIEW

Suggested height of post:
250W to 500W - 15ft. to 20ft.
1000W to 1500W - 25ft. To 35ft.

MODEL NO. C-90/02-B
(250-500 WATTS)

8 7/8" (225.42mm)
6" (152.4mm)
6 3/8" (161.92mm)

FRONT VIEW SIDE VIEW

AMCO ALUMINUM DIE-CAST FLOODLIGHT (WITH STEEL TAPERED LAMP POST)

