

AMCO Highbay Lamphade

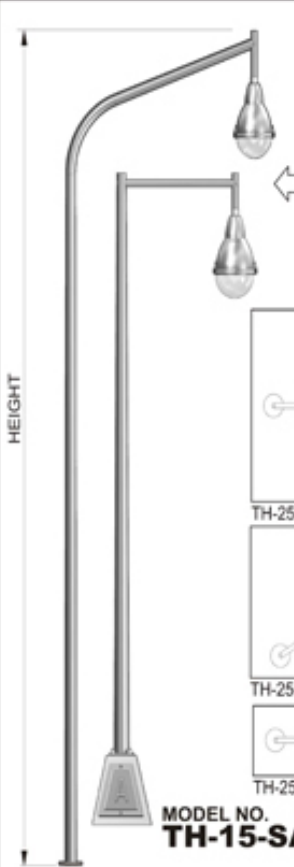

MODEL NO.	POST DIA.	HEIGHT	LAMP MODEL
TH-25-SA	5"(127mm)	25'(7.62M)	TH-14
TH-25-DA	-do-	-do-	-do-
TH-25-TA	-do-	-do-	-do-
TH-25-FA	-do-	-do-	-do-
TH-15-SA	4"(101.6mm)	15'(4.57M)	TH-10
TH-15-DA	-do-	-do-	-do-
TH-15-TA	-do-	-do-	-do-
TH-15-FA	-do-	-do-	-do-

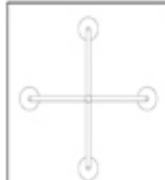
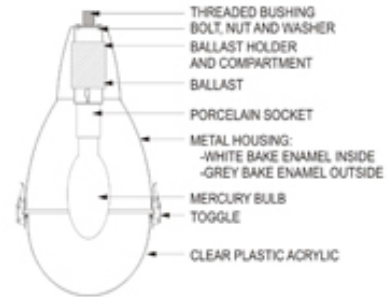

MODEL NO.	WATTAGE
TH-10	80W - 160W



MODEL NO.	WATTAGE
TH-14	160W - 250W

MODEL NO. **TH-25-SA**

MODEL NO. **TH-15-SA**

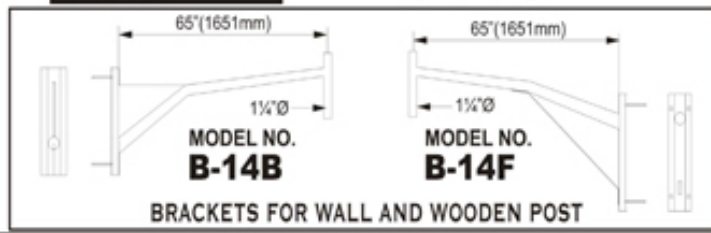

AMCO SALAKOT AMCRYLIC LAMP

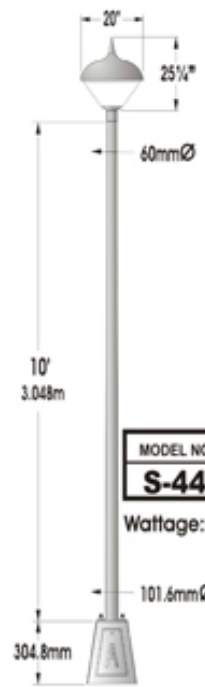

MODEL NO. **S-44P1**
Wattage: 50-160W

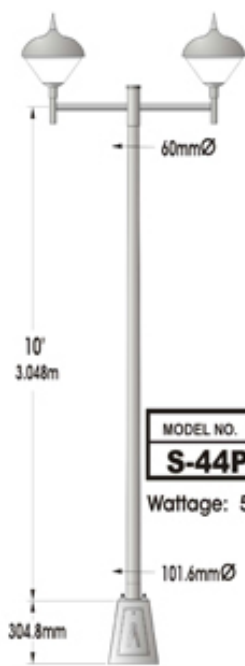

MODEL NO. **S-44P2**
Wattage: 50-160W



MODEL NO. **S-44P3**
Wattage: 50-160W

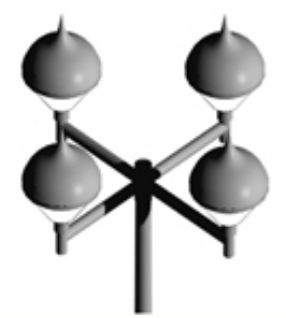

MODEL NO. **S-44P4**
Wattage: 50-160W

AMCO CASTLE LANTERN

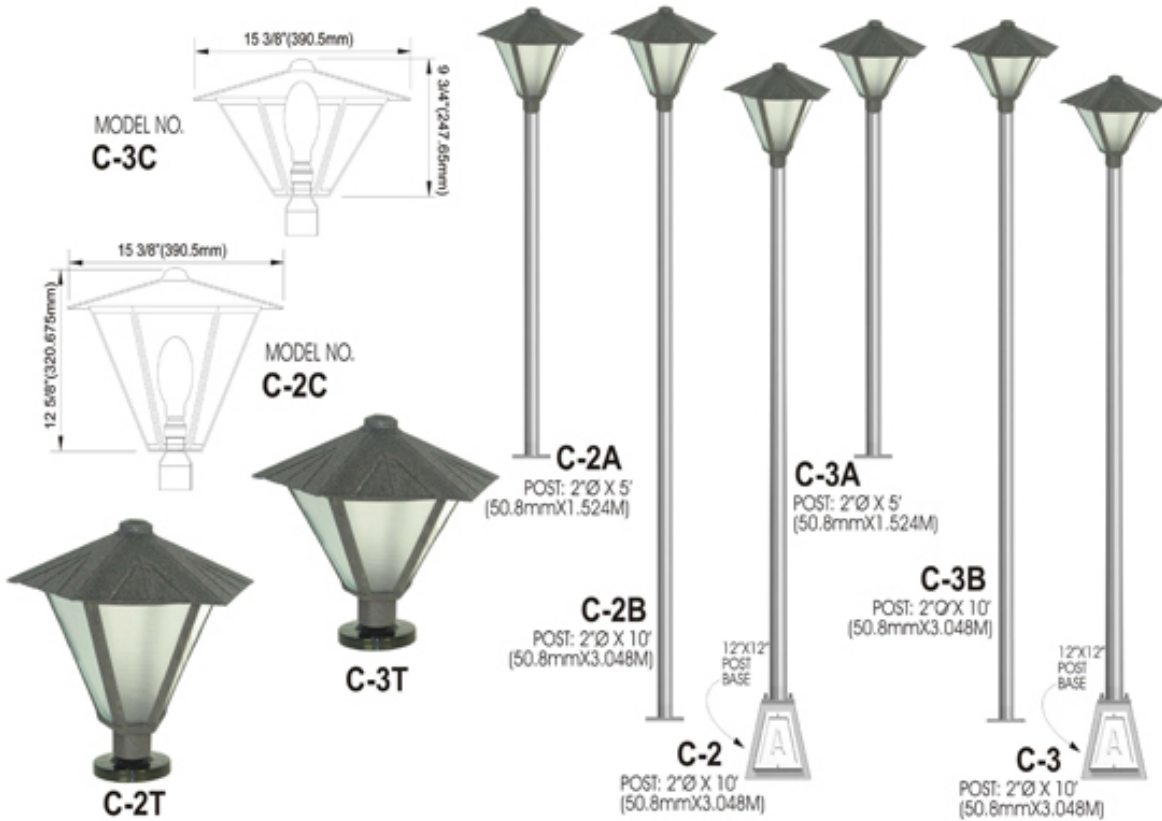

AMCO URBAN LAMP SHADE TYPE

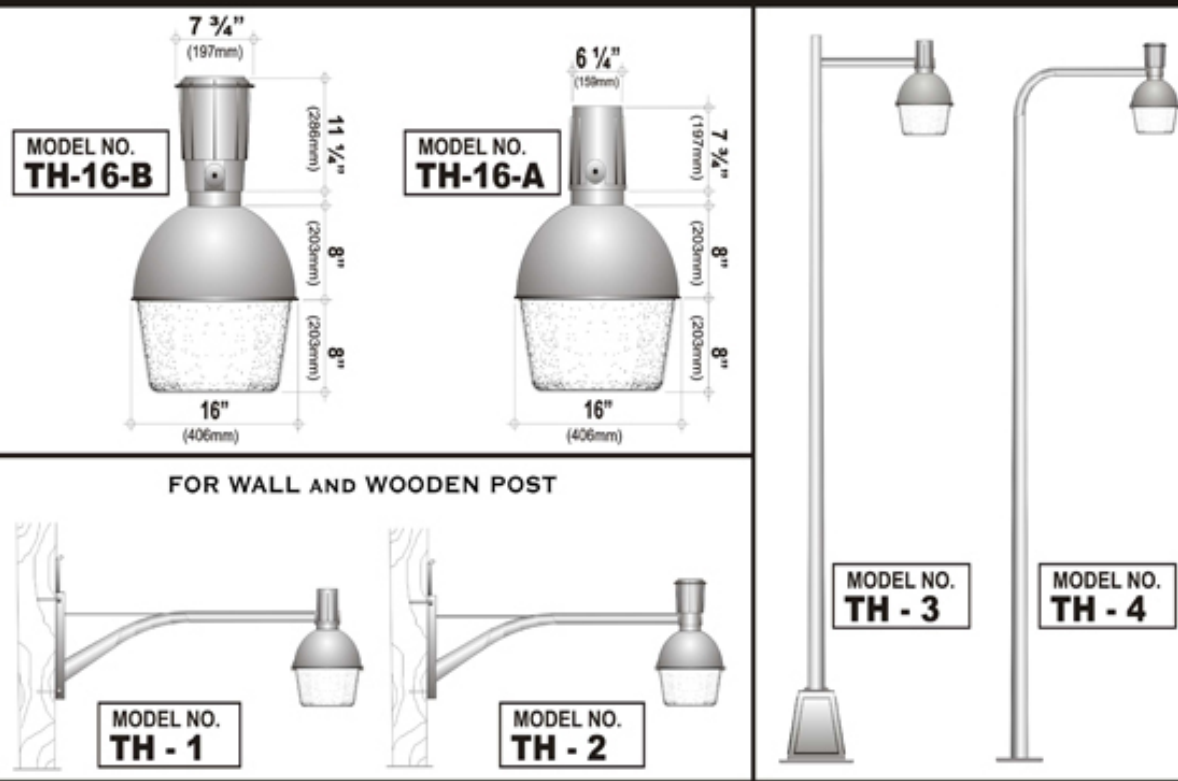

AMCO ALUMINUM DIE CAST URBAN REFLECTOR

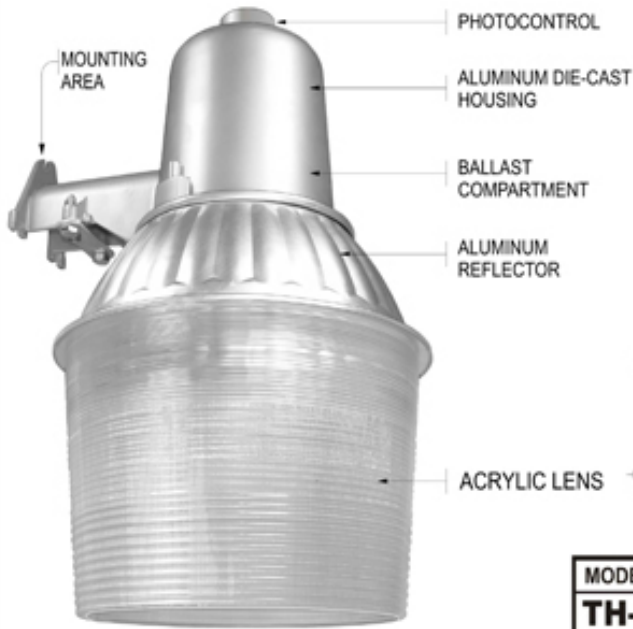

WITH HIGH PRESSURE SODIUM LAMP

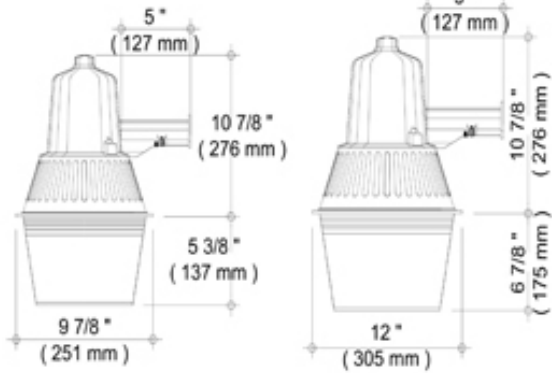

MODEL NO.	Wattage
TH-70	70 WATTS

MODEL NO.	Wattage
TH-150	150 WATTS

MODEL NO. **TH-150-B**
(HOUSING ONLY w/o BALLAST & BULB)

(PHOTO CONTROL, BALLAST & BULB are INCLUDED)

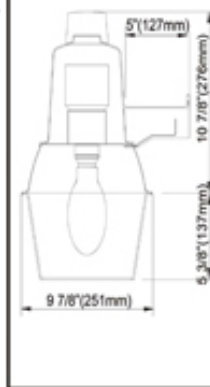

BRACKET FOR WALL
& WOODEN POST

MODEL NO.

B-3F

(PHOTO CONTROL, BALLAST and
MERCURY BULB are INCLUDED)

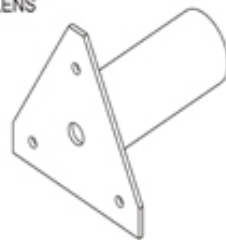

ADAPTER FOR
1"Ø ROUND PIPE

MODEL NO.	Wattage
TH-175	175 WATTS

URBAN REFLECTOR w/ LAMP POST

AMCO ALUMINUM HIGH BAY REFLECTOR

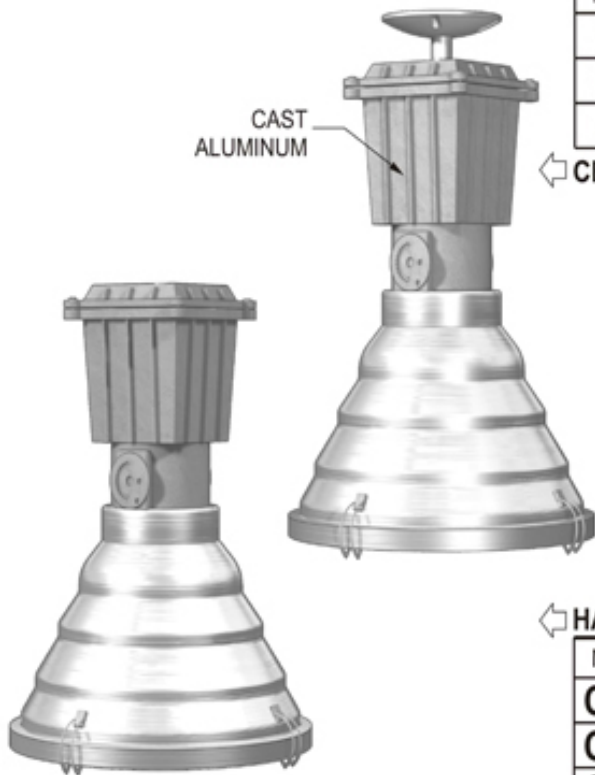

MODEL NO.	DIAMETER	HEIGHT	WATTAGE
C94-A	14½"(368mm)	9½"(241mm)	70-250W
C95-A	19"(482mm)	12¼"(311mm)	250-500W
C96-A	23"(584mm)	15"(381mm)	500-1000W

← CEILING TYPE

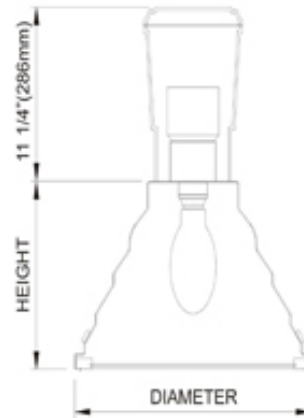

← HANGING TYPE

MODEL NO.	DIAMETER	HEIGHT	WATTAGE
C94-HA	14½"(368mm)	9½"(241mm)	70-250W
C95-HA	19"(482mm)	12¼"(311mm)	250-500W
C96-HA	23"(584mm)	15"(381mm)	500-1000W

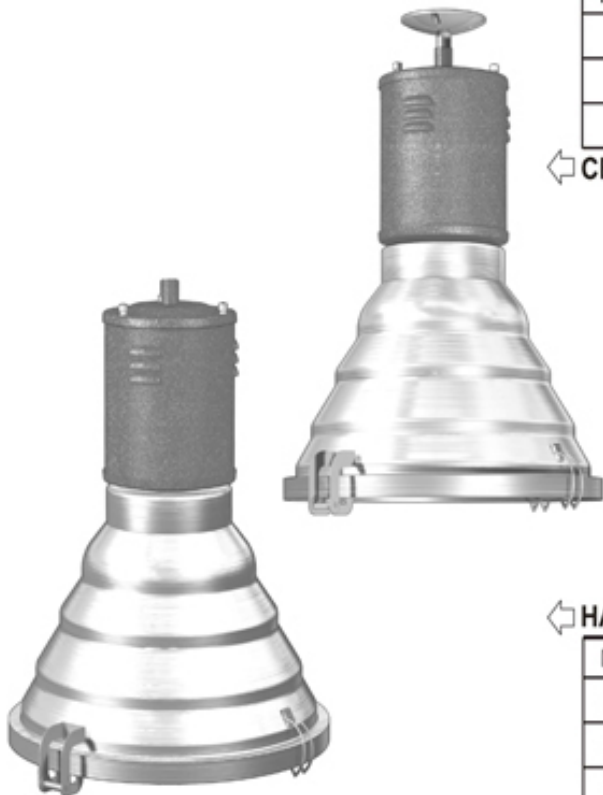

MODEL NO.	DIAMETER	HEIGHT	WATTAGE
C-94	14½"(368mm)	9½"(241mm)	70-250W
C-95	19"(482mm)	12¼"(311mm)	250-500W
C-96	23"(584mm)	15"(381mm)	500-1000W

← CEILING TYPE

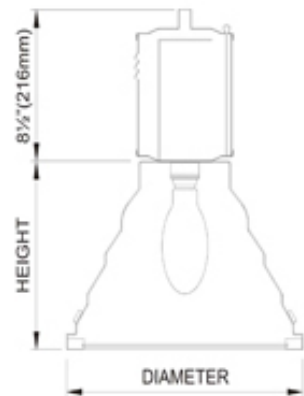

← HANGING TYPE

MODEL NO.	DIAMETER	HEIGHT	WATTAGE
C94-H	14½"(368mm)	9½"(241mm)	70-250W
C95-H	19"(482mm)	12¼"(311mm)	250-500W
C96-H	23"(584mm)	15"(381mm)	500-1000W

AMCO ANODIZED ALUMINUM HIGHBAY REFLECTOR



MODEL NO.
TH-100A



MODEL NO.
TH-100PA

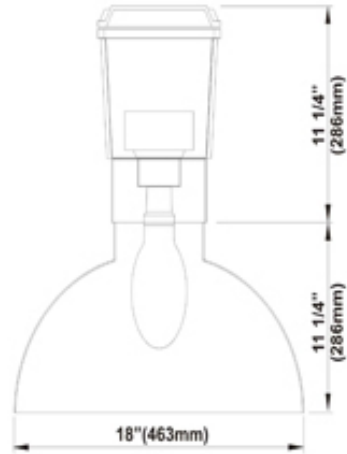

MODEL NO.
TH-100



MODEL NO.
TH-100P

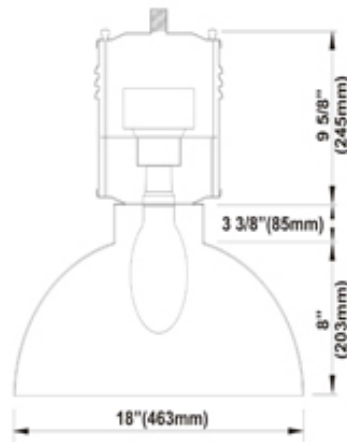

MAXIMUM WATTAGE: 500W



MODEL NO.	A	B	C	D
AP-110-AH	66mm	100mm	155mm	10" (254mm)
AP-112-AH	66mm	100mm	180mm	12" (305mm)
AP-114-AH	66mm	140mm	203mm	14" (356mm)

POWDER COATING: GREEN OUTSIDE, WHITE INSIDE

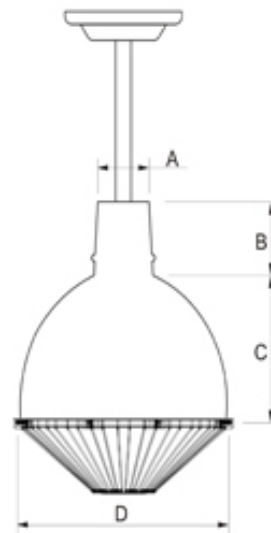
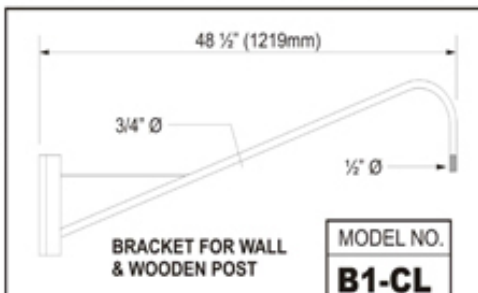

AMCO FLOODLIGHT REFLECTOR

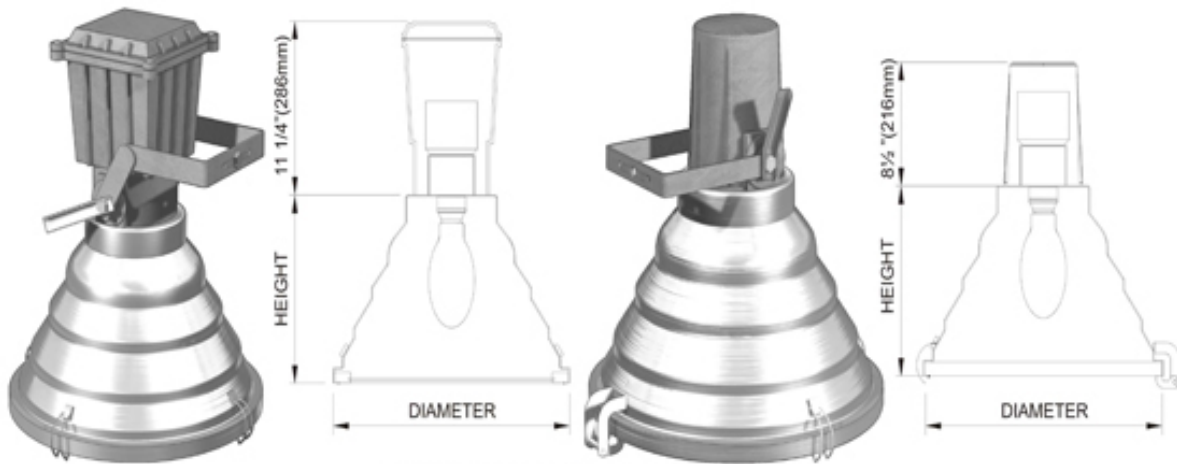

FORMED ALUMINUM REFLECTOR, ANODIZED FINISH

MODEL NO.	DIAMETER	HEIGHT	WATTAGE	MODEL NO.	DIAMETER	HEIGHT	WATTAGE
C-91-A	14½"(368mm)	9½"(241mm)	70-250W	C-91	14½"(368mm)	9½"(241mm)	70-250W
C-92-A	19"(482mm)	12¼"(311mm)	250-500W	C-92	19"(482mm)	12¼"(311mm)	250-500W
C-93-A	23"(584mm)	15"(381mm)	500-1000W	C-93	23"(584mm)	15"(381mm)	500-1000W

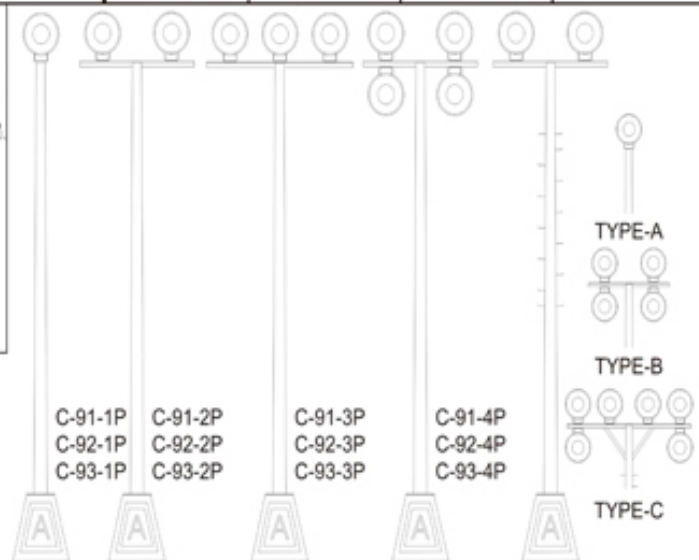
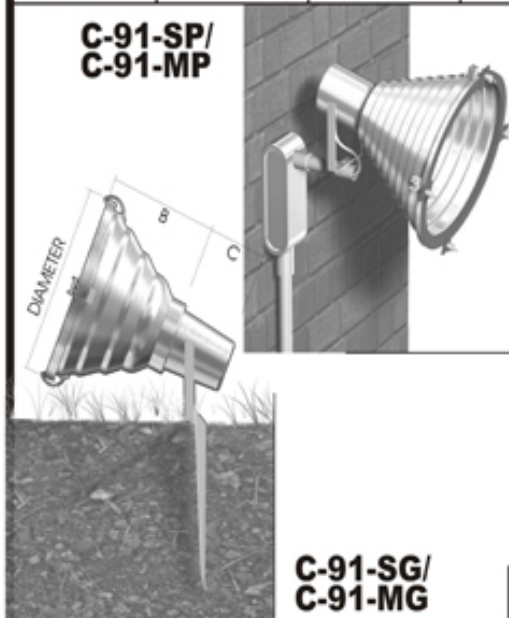

MEDIUM REFLECTOR				MAXIMUM WATTAGE 200W
MODEL NO.	DIAMETER	B	C	WATTAGE
C91-MG	11"(280.7mm)	11¼"(285.7mm)	4"(102mm)	200W
C91-MP	11"(280.7mm)	11¼"(285.7mm)	4"(102mm)	200W
C91-MWC	10½"(268mm)	10⅝"(270mm)	4"(102mm)	200W
SMALL REFLECTOR				MAXIMUM WATTAGE 150W
MODEL NO.	DIAMETER	B	C	WATTAGE
C91-SG	7⅞"(181mm)	9⅜"(238.7mm)	3"(76mm)	150W
C91-SP	7⅞"(181mm)	9⅜"(238.7mm)	3"(76mm)	150W
C91-SWC	6¾"(172mm)	7¼"(185mm)	3"(76mm)	150W

MIRRORIZED AND ANODIZED ALUMINUM HIGH BAY REFLECTOR AND ACCESSORIES



MODEL NO.
TH-120



MODEL NO.
TH-123



MODEL NO.
TH-122



MODEL NO.
TH-121



MODEL NO.
TH-120-B



MODEL NO.
TH-123-B



MODEL NO.
TH-122-B



MODEL NO.
TH-121-B



BH



Medium Socket



Mogul Socket

TH-S

TH-M



MODEL NO.
TH-100-CA

MIRRORIZED and ANODIZED ALUMINUM REFLECTOR can be use in various places such as recreation centers, industrial facilities, commercial spaces and other indoor buildings.



AMCO MIRRORIZED ALUMINUM Highbay REFLECTOR AND ACCESSORIES



MODEL NO.
TH - 112



MODEL NO.: BH



MODEL NO.
TH - 112 - B



MODEL NO.
TH - 113



MODEL NO.: BM



MODEL NO.: TH-S



MODEL NO.
TH - 113 - B



MODEL NO.
TH - 114



MODEL NO.
TH - 114 - B











MODEL NO.
TH - 128



MODEL NO.
TH - 128 - B

AMCO MIRRORIZED AND ANODIZED ALUMINUM HIGHBAY REFLECTOR

	 <p>MODEL NO.: TH-S</p>	 <p>7 1/2" (191mm) 1 1/2" (38mm) 8" (203mm) 10 1/2" (267mm) 16" (406mm)</p>	
<p>MODEL NO. TH - 124</p>		<p>MODEL NO. TH - 124 - B</p>	
		 <p>7 1/2" (191mm) 1 1/2" (38mm) 8" (203mm) 13" (330mm) 19" (483mm)</p>	
<p>MODEL NO. TH - 125</p>		<p>MODEL NO. TH - 125 - B</p>	
		 <p>7 1/2" (191mm) 1 1/2" (38mm) 8" (203mm) 13 5/8" (346mm) 19" (483mm)</p>	
<p>MODEL NO. TH - 126</p>		<p>MODEL NO. TH - 126 - B</p>	

AMCO ANODIZED ALUMINUM Highbay REFLECTOR WITH GLASS COVER



MODEL NO.
C94 - G



MODEL NO.: BH



MODEL NO.
C94 - GB

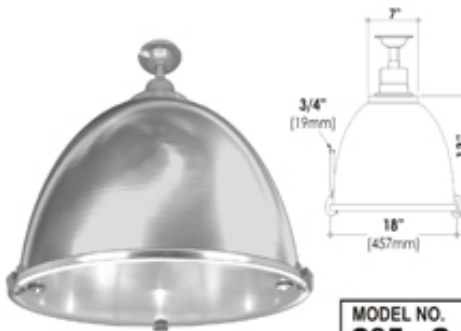

MODEL NO.
C95 - G



MODEL NO.: BM



MODEL NO.: TH-S



MODEL NO.
C95 - GB

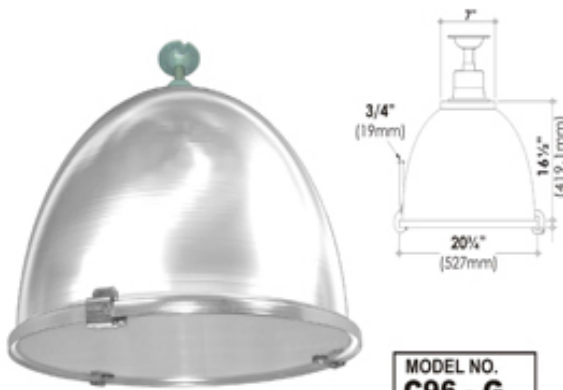

MODEL NO.
C96 - G



MODEL NO.
C96 - GB

WITHOUT GLASS COVER

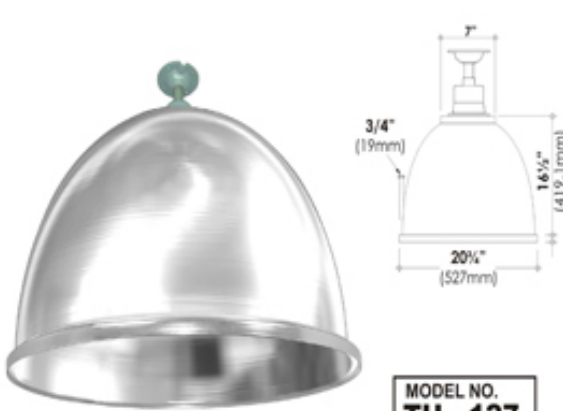

MODEL NO.
TH - 127



MODEL NO.
TH-127-B

AMCO ACRYLIC PRISMATIC Highbay Reflector

(FOR MERCURY, METAL HALIDE & SODIUM BULB)



MODEL NO.
THP-12-H

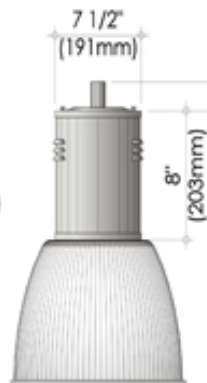

MODEL NO.
THP-12-B

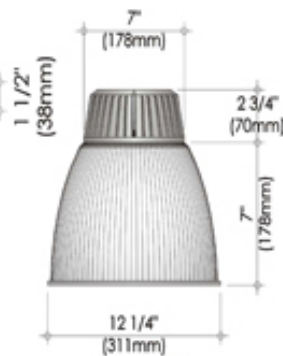

MODEL NO.
THP-12

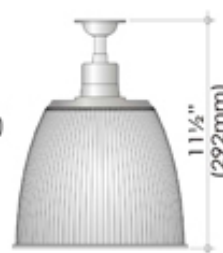

MODEL NO.
THP-12-F

MAX. 160W

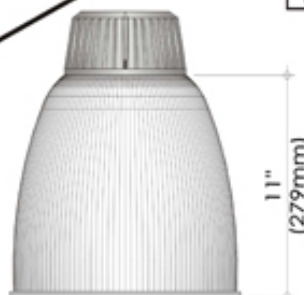

MODEL NO.
THP-16

MAX. 250W



MODEL NO.
THP-16-B



MODEL NO.
THP-16-F



MODEL NO.
THP-16-H



MODEL NO.
THP-14-H

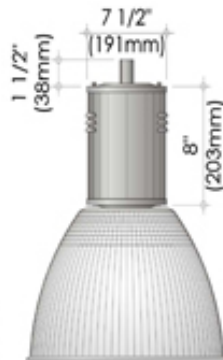

MODEL NO.
THP-14-B

MAX. 160W

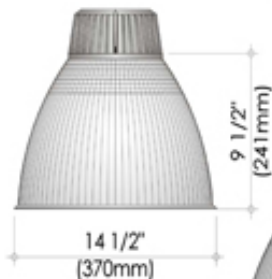

MODEL NO.
THP-14

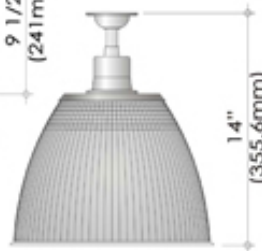

MODEL NO.
THP-14-F