

## AMCO ALUMINUM DIE-CAST MERCURY REFLECTOR

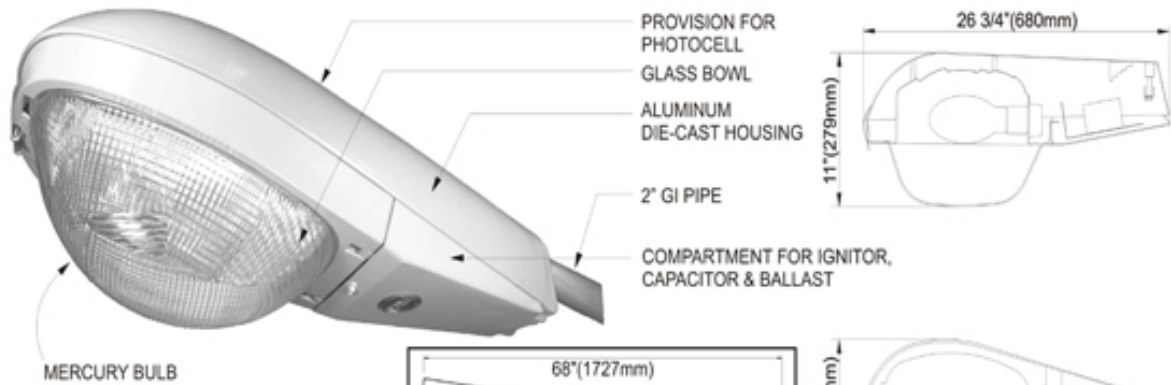

MODEL NO.	ACCOMMODATE
<b>D7-AL</b>	Max. 250W - w/ Ballast Max. 250W - w/o Ballast

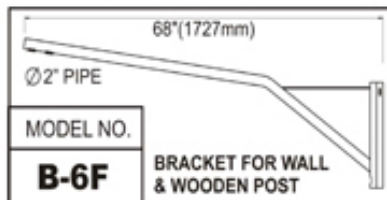

MODEL NO.	BRACKET FOR WALL & WOODEN POST
<b>B-6F</b>	

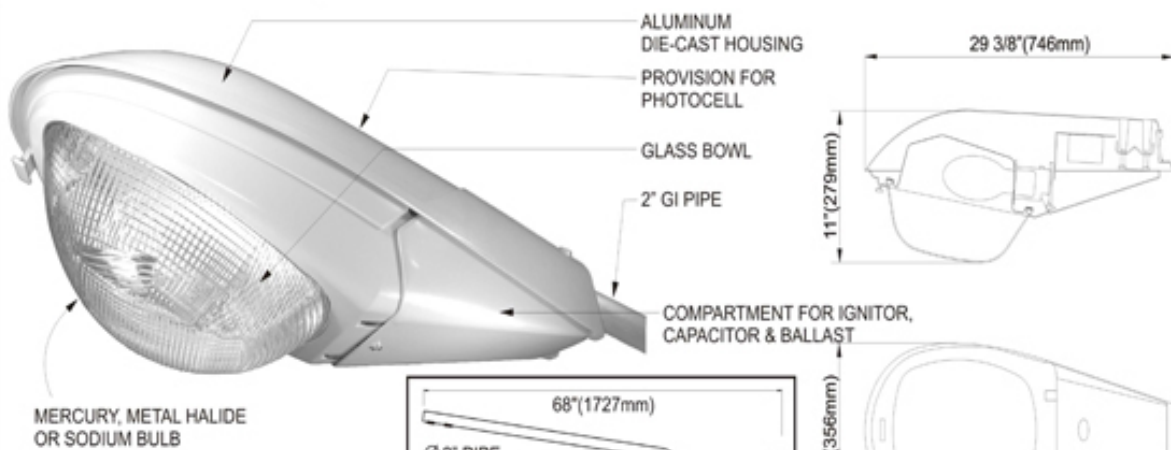

MODEL NO.	ACCOMMODATE
<b>D7-BL</b>	Max. 400W - w/ Ballast Max. 500W - w/o Ballast

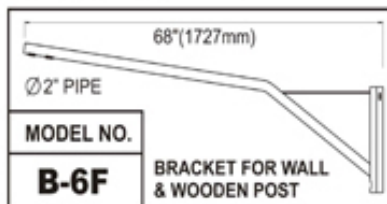

MODEL NO.	BRACKET FOR WALL & WOODEN POST
<b>B-6F</b>	

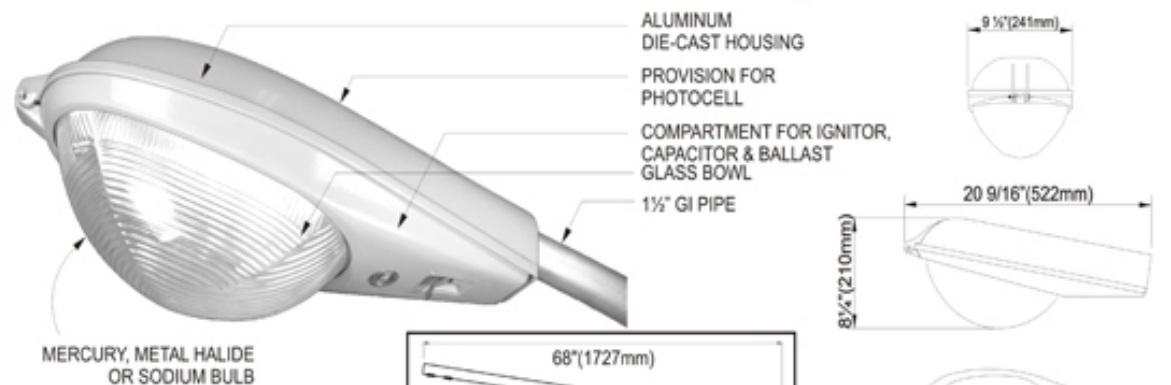

MODEL NO.	ACCOMMODATE
<b>D3-AL</b>	Max. 125W - w/ Ballast Max. 250W - w/o Ballast

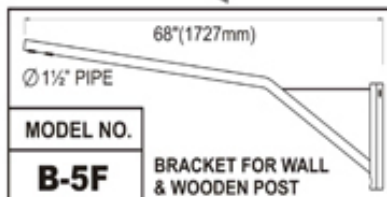

MODEL NO.	BRACKET FOR WALL & WOODEN POST
<b>B-5F</b>	

## AMCO ALUMINUM DIE-CAST MERCURY REFLECTOR

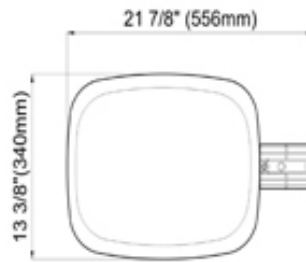

MODEL NO.	ACCOMMODATE
<b>D4-AL</b>	Max. 500W - w/o Ballast

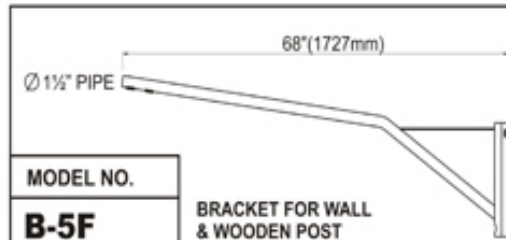
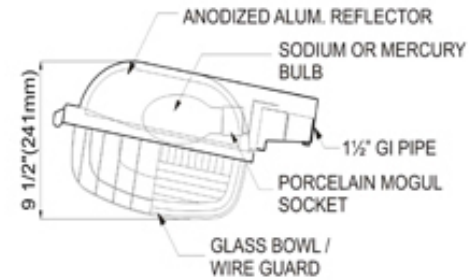

MODEL NO.	ACCOMMODATE
<b>D4-AL-W</b>	Max. 500W - w/o Ballast

MODEL NO.	BRACKET FOR WALL & WOODEN POST
<b>B-5F</b>	

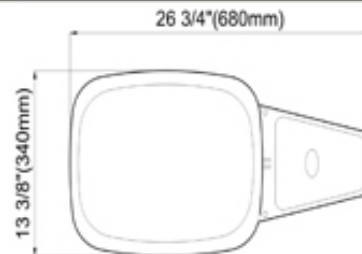

MODEL NO.	ACCOMMODATE
<b>D4-BL</b>	Max. 250W - w/ Ballast Max. 500W - w/o Ballast

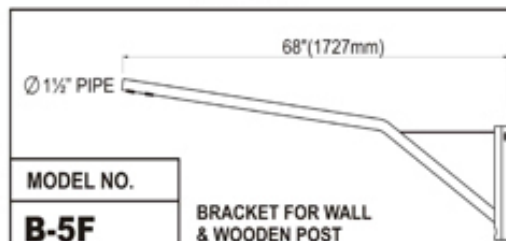
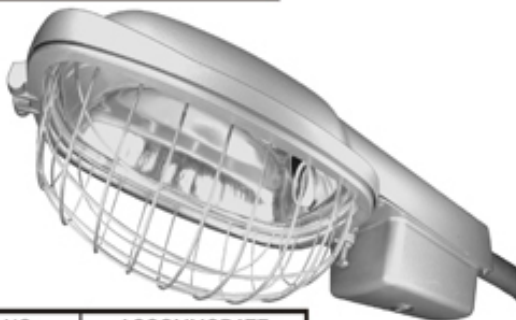
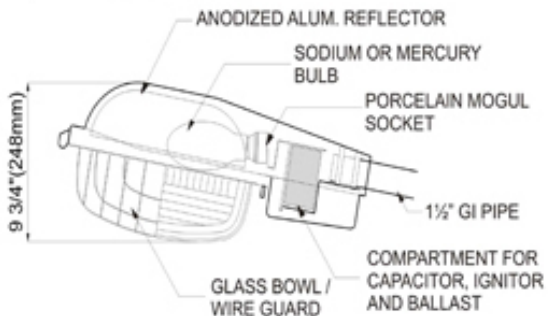

MODEL NO.	ACCOMMODATE
<b>D4-BL-W</b>	Max. 250W - w/ Ballast Max. 500W - w/o Ballast

MODEL NO.	BRACKET FOR WALL & WOODEN POST
<b>B-5F</b>	

## AMCO RECTANGULAR TYPE MERCURY REFLECTOR

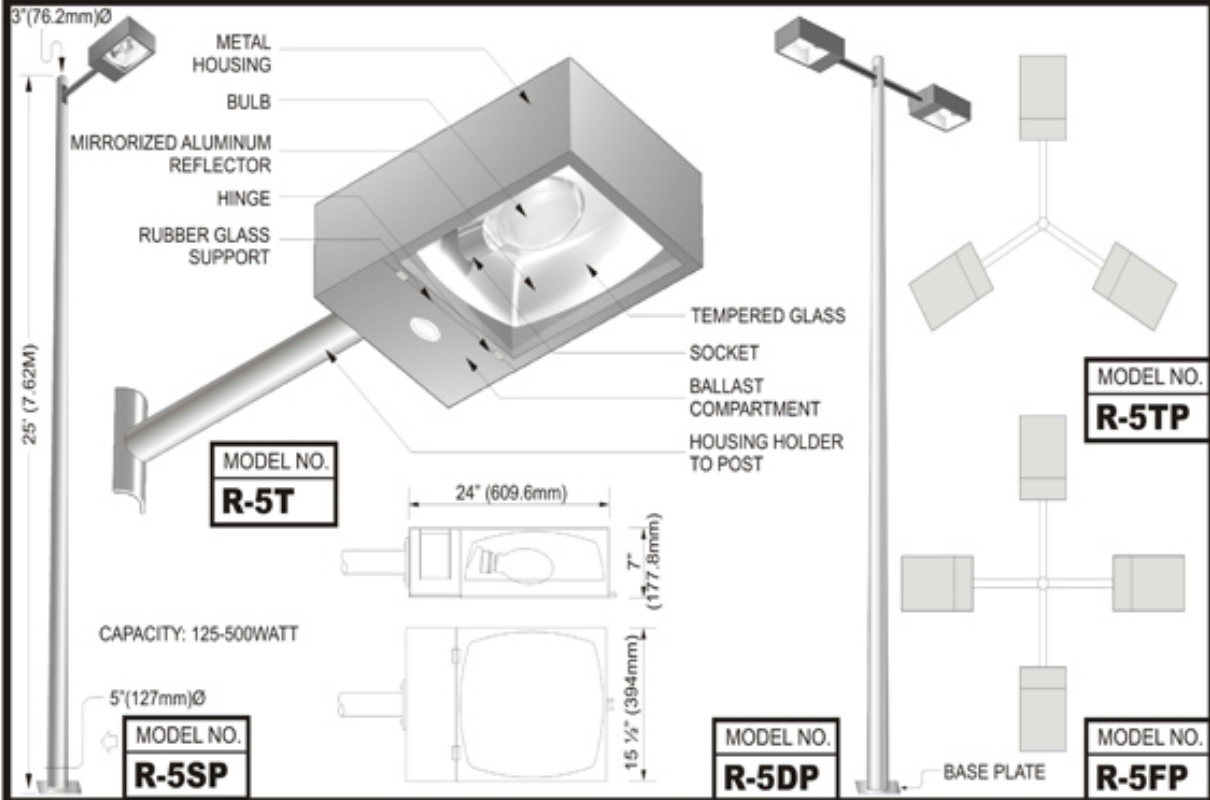

## AMCO ALUMINUM DIE-CAST MERCURY REFLECTOR WITH PHOTOCELL



MODEL NO. **D4-BL-P**  
(MAX. 250W w/ BALLAST)  
(MAX. 500W w/o BALLAST)

MODEL NO. **D7-AL-P**  
(MAX. 250W w/ BALLAST)  
(MAX. 250W w/o BALLAST)



MODEL NO. **D3-AL-P**  
(MAX. 125W w/ BALLAST)  
(MAX. 250W w/o BALLAST)

### PHOTOCELL

AVAILABLE (3, 6, OR 10 AMPERES)

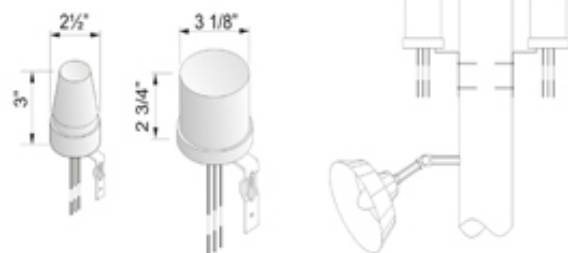

## AMCO MERCURY REFLECTOR (METAL HOUSING)

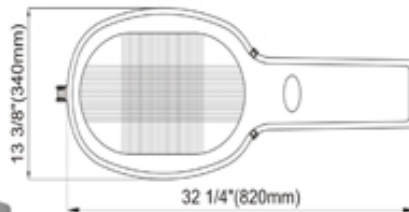

MODEL NO.
<b>D5-T</b> (METAL HOUSING w/ GLASS BOWL)
<b>D5-F</b> (FIBERGLASS HOUSING w/ GLASS BOWL)

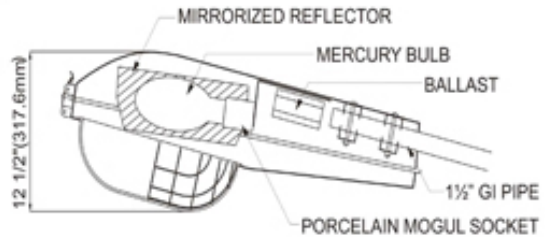

ACCOMMODATE:  
250W TO 400W - W/ BALLAST  
250W TO 500W - W/O BALLAST

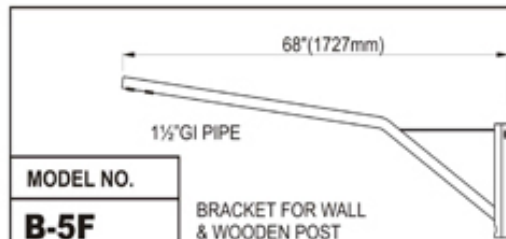

MODEL NO.
<b>D5-TW</b> (METAL HOUSING w/ WIRE GUARD)
<b>D5-TWF</b> (FIBERGLASS HOUSING w/ WIRE GUARD)

MODEL NO.	<b>B-5F</b>
BRACKET FOR WALL & WOODEN POST	

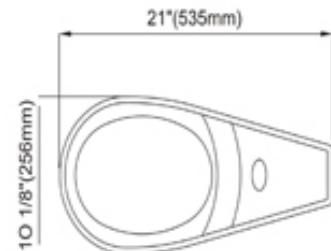

MODEL NO.
<b>D-3T</b> (METAL HOUSING w/ GLASS BOWL)
<b>D-3TF</b> (FIBERGLASS HOUSING w/ GLASS BOWL)

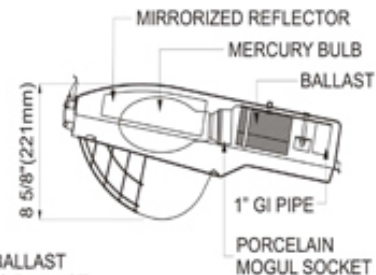

ACCOMMODATE:  
50W TO 125W - W/ BALLAST  
160W TO 250W - W/O BALLAST

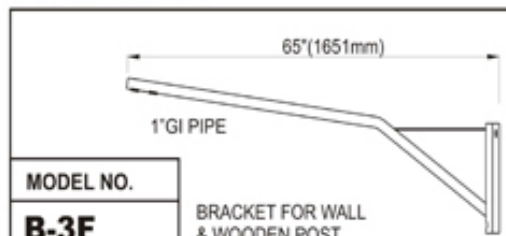
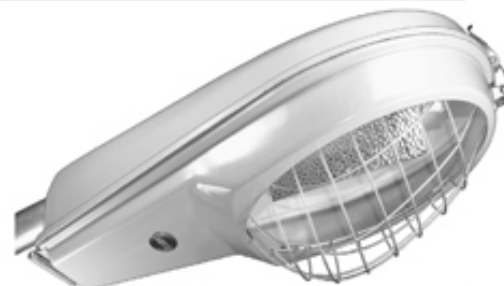

MODEL NO.
<b>D-3TW</b> (METAL HOUSING w/ WIRE GUARD)
<b>D-3TWF</b> (FIBERGLASS HOUSING w/ WIRE GUARD)

MODEL NO.	<b>B-3F</b>
BRACKET FOR WALL & WOODEN POST	

## AMCO MERCURY REFLECTOR W/ WIRE GUARD (METAL HOUSING)

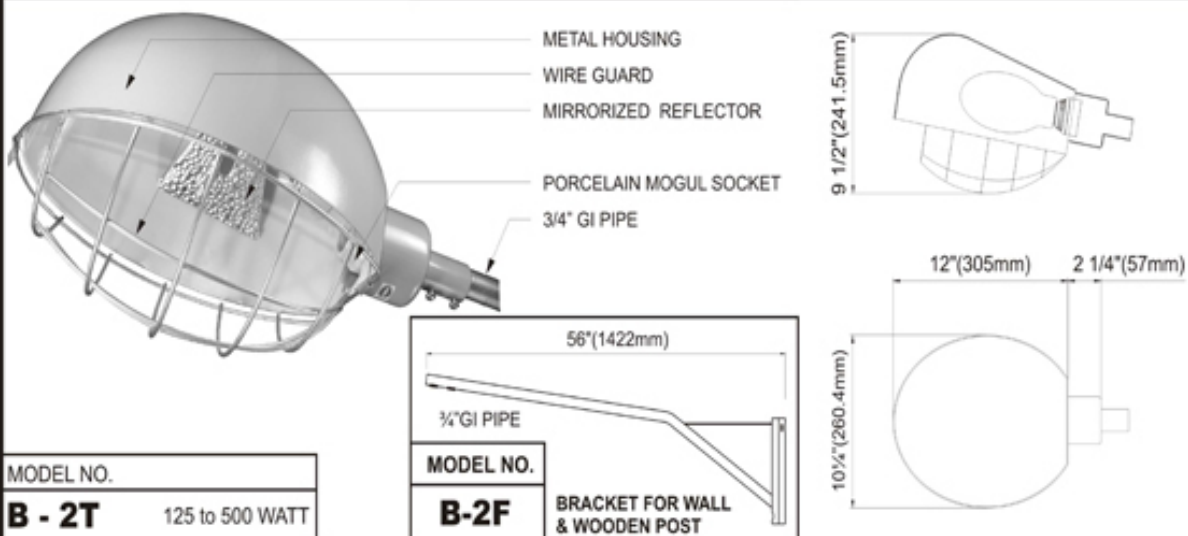
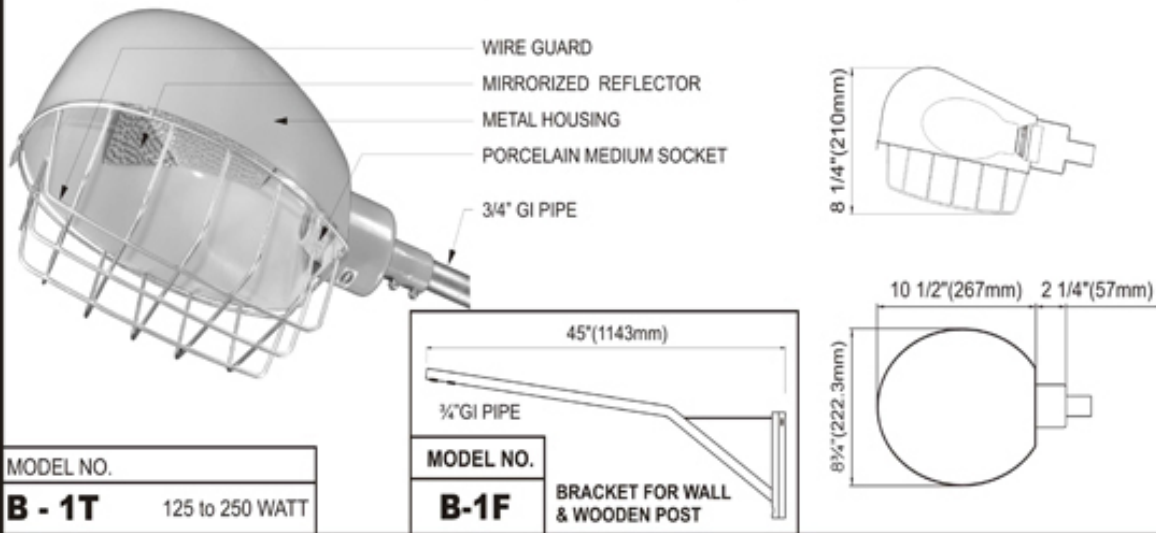

## AMCO MERCURY REFLECTOR WITH ACRYLIC COVER

