



AMCO DIE-CAST ALUMINUM CASTLE LANTERN (WALL TYPE)

AVAILABLE COLOR : **BLACK**

 <p>9 1/2" (241.30mm)</p> <p>17 1/4" (438.15mm)</p> <p>8 1/2" (215.9mm)</p>	 <p>8 3/4" (222.2mm)</p> <p>15" (381.0mm)</p> <p>6 3/4" (171.45mm)</p>	 <p>6 3/4" (171.45mm)</p> <p>14" (355.6mm)</p> <p>7 1/2" (190.5mm)</p>
<p>MODEL NO. AP-4811</p>	<p>MODEL NO. AP-4814</p>	<p>MODEL NO. AP-4813</p>

AMCO DIE-CAST ALUMINUM CASTLE LANTERN

AVAILABLE COLOR : **BLACK**

 <p>6" (431.8mm)</p> <p>17" (431.8mm)</p> <p>MODEL NO. AP-5174</p>	 <p>7" (177.8mm)</p> <p>22 3/4" (577.85mm)</p> <p>MODEL NO. AP-5204</p>
--	--

AMCO DIE-CAST ALUMINUM CASTLE LANTERN

AVAILABLE COLOR : BLACK



MODEL NO.
AP-5134L



MODEL NO.
AP-5131L



MODEL NO.
AP-5134S



MODEL NO.
AP-5154



MODEL NO.
AP-5151



MODEL NO.
AP-5184

AMCO DIE-CAST ALUMINUM CASTLE LANTERN

AVAILABLE COLORS: WHITE, BLACK, ANTIQUE & BEIGE



MAX. 160W

MODEL NO.

C8-CL



MAX. 160W

MODEL NO.

C8-CW



MAX. 160W

MODEL NO.

C8-C



MAX. 100W

MODEL NO.

C8-CES



MAX. 100W

MODEL NO.

C8-CLW



MAX. 100W

MODEL NO.

C8-CC

AMCO DIE-CAST ALUMINUM CASTLE LANTERN

AVAILABLE IN WHITE, BLACK, ANTIQUE AND BEIGE COLOR, WITH SOCKET WITHOUT BULB



MAX. 100W
MODEL NO. **C7-BC**



MAX. 100W
MODEL NO. **C7-CC**



MAX. 100W
MODEL NO. **1103-CC**



MAX. 100W
MODEL NO. **1103-BC**



MODEL NO. **C7-CD**



MODEL NO. **C7-D**



MODEL NO. **1103-D**



MODEL NO. **1103-CD**



MODEL NO. **C7-CDW**



MODEL NO. **C7-DW**











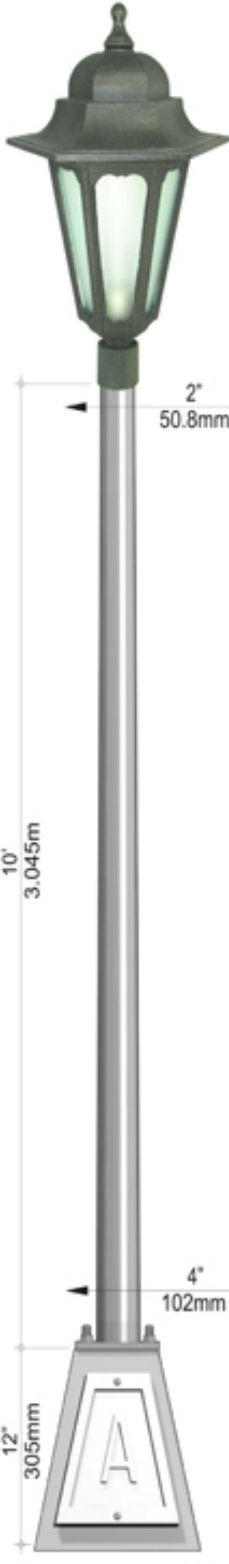

MODEL NO. **1106-D**











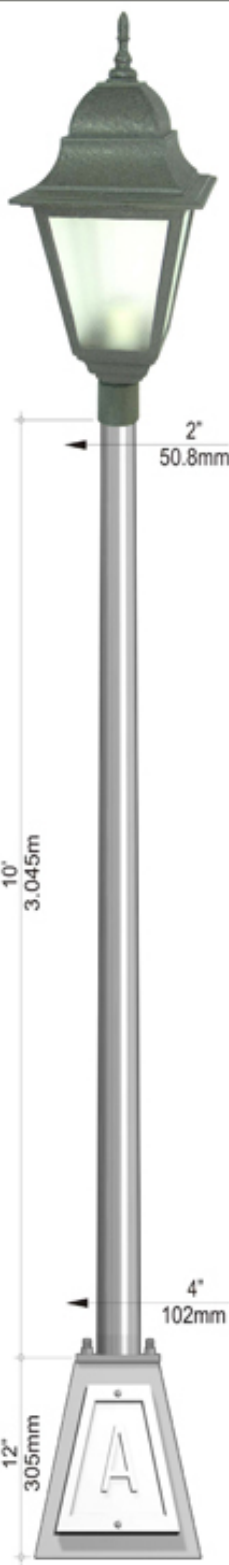



MODEL NO. **1106-CD**

**AMCO DIE-CAST ALUMINUM CASTLE LANTERN
AND ACCESSORIES, WITH SOCKET WITHOUT BULB**

 <p>10' 3.045m</p> <p>2" 50.8mm</p> <p>4" 102mm</p> <p>12" 305mm</p>	 <p>MODEL NO. C7CM-P2</p>	 <p>MODEL NO. C7CM-P3</p>	 <p>12" 305mm</p> <p>11 1/4" 286mm</p> <p>8 1/4" 210mm</p> <p>MODEL NO. 1-B</p>	
	 <p>MODEL NO. C7CM-P4</p>	 <p>MODEL NO. C7CM-P5</p>	 <p>12" 305mm</p> <p>8 1/4" 210mm</p> <p>MODEL NO. 1-BP</p>	 <p>15" 381mm</p> <p>7 1/2" 190mm</p> <p>12" 305mm</p> <p>4" 102mm</p> <p>MAX 160W</p> <p>MODEL NO. C7DM</p>
	<p>AVAILABLE IN COLORS OF WHITE, BLACK, ANTIQUE & BEIGE</p>			 <p>MODEL NO. C7DM-W</p>
	 <p>3 1/2" 89mm</p> <p>MODEL NO. C7DW</p>	 <p>7" 178mm</p> <p>2 1/2" 64mm</p> <p>6" 152mm</p> <p>3" 76mm</p> <p>MODEL NO. C7D</p>		
	<p>MODEL NO. C7CM-P1</p>	<p>MODEL NO. C7DW</p>	<p>MODEL NO. C7D</p>	<p>MODEL NO. C7DM-W</p>

**AMCO DIE-CAST ALUMINUM CASTLE LANTERN
AND ACCESSORIES, WITH SOCKET WITHOUT BULB**

 <p>10" 3.045m</p> <p>2" 50.8mm</p> <p>4" 102mm</p> <p>12" 305mm</p>	 <p>MODEL NO. 1103CM-P2</p>	 <p>MODEL NO. 1103CM-P3</p>	 <p>12" 305mm</p> <p>11 1/2" 286mm</p> <p>8 1/4" 210mm</p> <p>MODEL NO. 1-B</p>	
	 <p>MODEL NO. 1103CM-P4</p>	 <p>MODEL NO. 1103CM-P5</p>	 <p>12" 305mm</p> <p>8 1/4" 210mm</p> <p>MODEL NO. 1-BP</p>	 <p>MAX 160W</p> <p>7 1/2" 190mm</p> <p>8 1/2" 216mm</p> <p>7 3/8" 187mm</p> <p>4" 102mm</p> <p>MODEL NO. 1103DM</p>
	<p>AVAILABLE IN COLORS OF WHITE, BLACK, ANTIQUE & BEIGE</p>			 <p>MODEL NO. 1106DM</p>
	 <p>5 1/2" 140mm</p> <p>5 1/4" 133mm</p> <p>MODEL NO. 1106D</p>	 <p>3 1/2" 89mm</p> <p>5" 127mm</p> <p>6" 152mm</p> <p>3" 76mm</p> <p>MODEL NO. 1103D</p>	 <p>MODEL NO. 1106DM</p>	 <p>MODEL NO. 1106DM</p>
	<p>MODEL NO. 1103CM-P1</p>	<p>MODEL NO. 1106D</p>	<p>MODEL NO. 1103D</p>	<p>MODEL NO. 1106DM</p>

AMCO ANTIQUE LAMP POST WITH CASTLE LANTERN AND ACCESSORIES

<p>MODEL NO. 1 - B</p>			
<p>MODEL NO. 1 - BP</p>	<p>MODEL NO. C7CM-C</p>	<p>MODEL NO. C7DM-W</p>	<p>MODEL NO. C7DM</p>

CASTLE LANTERN WITH DECORATIVE POST AND BASE

<p>MODEL NO. C-207DM</p>	<p>MODEL NO. C-107DM</p>	<p>MODEL NO. C-307DM</p>	<p>MODEL NO. C-407DM</p>	<p>MODEL NO. C-107DMX</p>	<p>MODEL NO. C-507DM</p>



AMCO ANTIQUE LAMP POST WITH CASTLE LANTERN AND ACCESSORIES

<p>MODEL NO. 1 - B</p>			
	<p>MODEL NO. 1103CM</p>	<p>MODEL NO. 1106DM</p>	<p>MODEL NO. 1103DM</p>



CASTLE LANTERN WITH DECORATIVE POST AND BASE

<p>MODEL NO. C-112DM</p>	<p>MODEL NO. C-111DM</p>	<p>MODEL NO. C-113DM</p>	<p>MODEL NO. C-114DM</p>	<p>MODEL NO. C-111DMX</p>	<p>MODEL NO. C-115DM</p>

AMCO ANTIQUE LAMP POST WITH CASTLE LANTERN AND ACCESSORIES

 <p>BASE TYPE MAX. 250W</p>	 <p>COUPLING TYPE 2" MAX. 250W</p>
<p>MODEL NO. AP - C - 14</p>	<p>MODEL NO. AP - C - 14 - C</p>

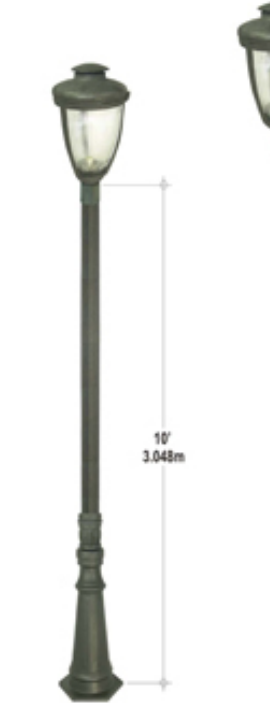
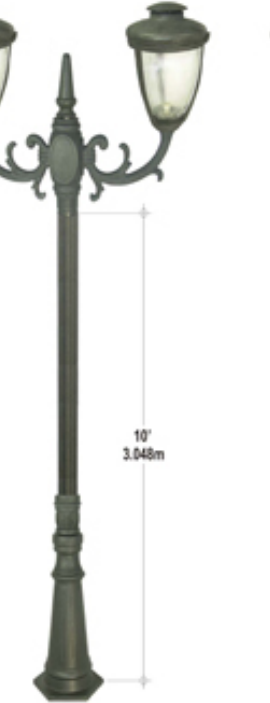
CASTLE LANTERN WITH DECORATIVE POST AND BASE STAND

 <p>10' 3.048m</p>	 <p>10' 3.048m</p>	 <p>10' 3.048m</p>	 <p>10' 3.048m</p>
<p>MODEL NO. AP-C-14-1P</p>	<p>MODEL NO. AP-C-14-1PM</p>	<p>MODEL NO. AP-C-14-2PM</p>	<p>MODEL NO. AP-C-14-2PB</p>

AMCO DIE-CAST ALUMINUM PAKWAN LANTERN

AVAILABLE COLOR: **BLACK (WHITE, ANTIQUE & BEIGE UPON REQUEST)**



Clear Glass

MODEL NO.

P - 8



MODEL NO.

P - 7



1 1/2" or 2" COUPLING

MODEL NO.

P - 8 - C

(MAX. 160W)

P - 7 - C

(MAX. 100W)

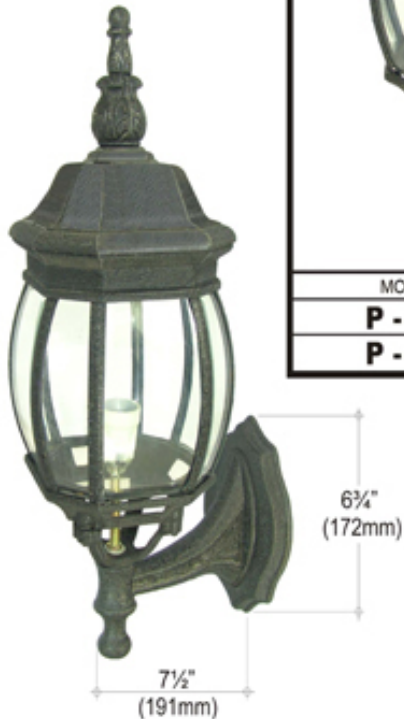

MODEL NO.

P - 8 - W



MODEL NO.

P - 7 - W

AMCO DIE-CAST ALUMINUM CASTLE LANTERN & ACCESSORIES
(WITHOUT POST) AVAILABLE COLOR: **BLACK (WHITE, ANTIQUE & BEIGE UPON REQUEST)**



MODEL NO.
C88 - L



MODEL NO.
C88 - S



MODEL NO.
C88 - SW

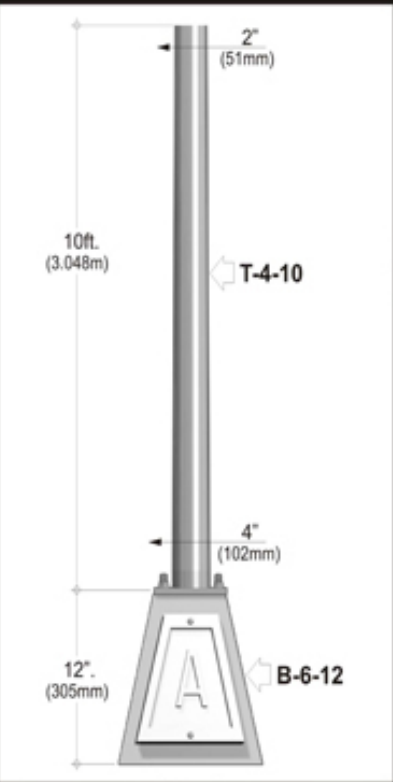

MODEL NO.
T - 4 - 10 - B - 6 - 12



MODEL NO.
C88 - S - 2



MODEL NO.
C88 - S - 3



MODEL NO.
C88 - S - 4



MODEL NO.
C88 - S - 5

AMCO DECORATIVE DIE-CAST ALUMINUM TAPERED & STRAIGHT POST, BASE STAND & PAKWAN LANTERN



MODEL NO.
PK - 8



MAX. 250W

MODEL NO.
PK - 8 - 2K

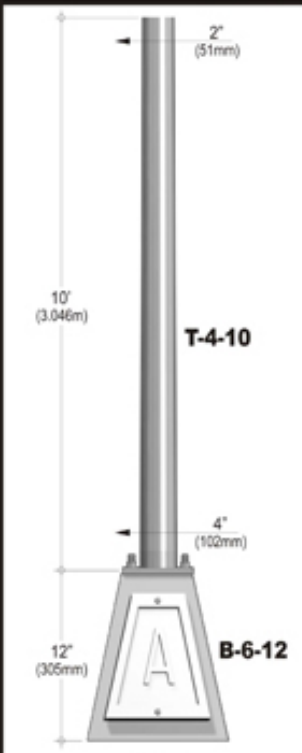

MODEL NO.
T-4-10-B-6-12

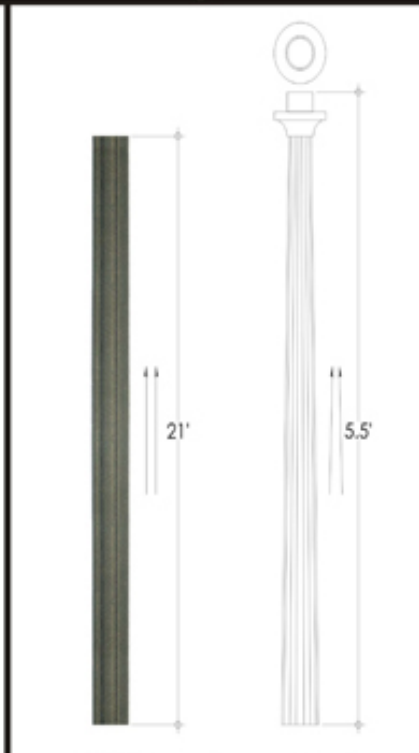

MODEL NO.
DS - 3

MODEL NO.
DT - 55



MODEL NO.
B - 42

MODEL NO.
B - 27







AMCO ANTIQUE LAMP POST WITH CASTLE LANTERN

	<p>MAX. 160W</p> <p>AVAILABLE COUPLING SIZE: 1 1/2" & 2"</p>	<p>Clear Glass</p>
<p>MODEL NO. C7 - BD</p>	<p>MODEL NO. C7 - BDC</p>	<p>MODEL NO. C7 - BDW</p>





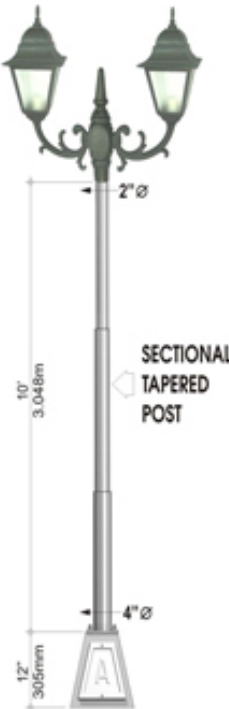
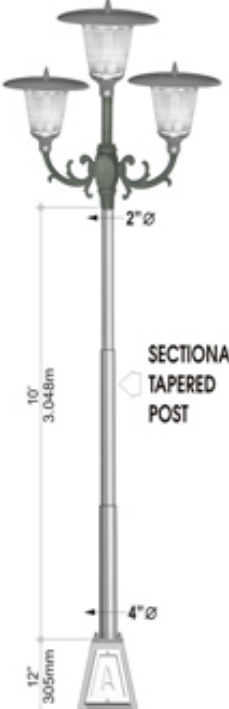
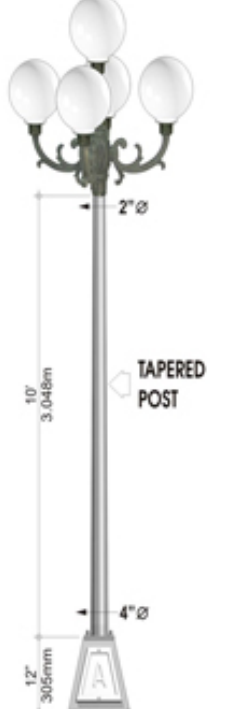

AMCO CASTLE LANTERN (METAL HOUSING)

<p>WATTAGE: 125w to 250w(Ballast Type) 3" 76mm 160w to 250w(Non Ballast)</p>				
<p>DETAILS & DIMENSION</p>				
<p>MODEL NO. C - 35 - B</p>	<p>MODEL NO. C - 40 - 2L</p>	<p>MODEL NO. C40 - SP5</p>	<p>MODEL NO. C40 - SP10</p>	<p>MODEL NO. C40 - TP10 - 3L</p>

AMCO PARK LAMP

		
<p>MODEL NO. 2 - AX</p>	<p>MODEL NO. 3 - AX</p>	<p>MODEL NO. 5 - AX</p>
		
<p>MODEL NO. 2 - AU</p>	<p>MODEL NO. 3 - A</p>	<p>MODEL NO. 5 - AU</p>
		
<p>MODEL NO. 2 - AP</p>	<p>MODEL NO. 3 - AP</p>	<p>MODEL NO. 5 - AP</p>

AMCO PARK LAMP

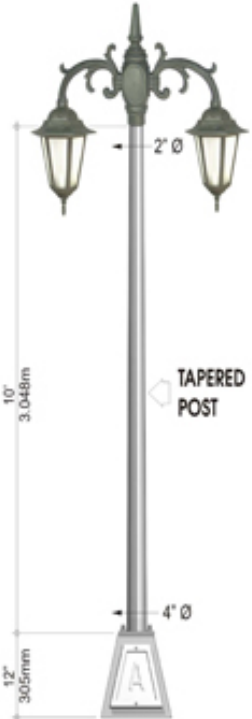
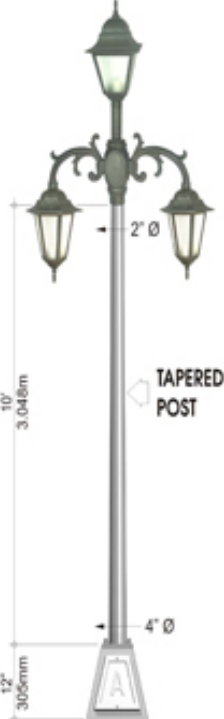
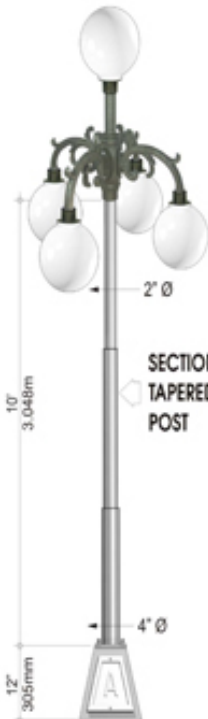
		
<p>MODEL NO. 2 - DX</p>	<p>MODEL NO. 3 - ADX</p>	<p>MODEL NO. 5 - ADX</p>
 <p>Die-Cast Aluminum Bracket</p>	 <p>9"</p> <p>12"</p>	 <p>Die-Cast Aluminum Bracket</p>
<p>MODEL NO. 2 - D</p>	<p>MODEL NO. 3 - AD</p>	<p>MODEL NO. 5 - AD</p>
 <p>10' 3,048mm</p> <p>12" 305mm</p> <p>4" Ø</p> <p>2' Ø</p> <p>TAPERED POST</p>	 <p>10' 3,048mm</p> <p>12" 305mm</p> <p>4" Ø</p> <p>2' Ø</p> <p>TAPERED POST</p>	 <p>10' 3,048mm</p> <p>12" 305mm</p> <p>4" Ø</p> <p>2' Ø</p> <p>SECTIONAL TAPERED POST</p>
<p>MODEL NO. 2 - DP</p>	<p>MODEL NO. 3 - ADP</p>	<p>MODEL NO. 5 - ADP</p>