

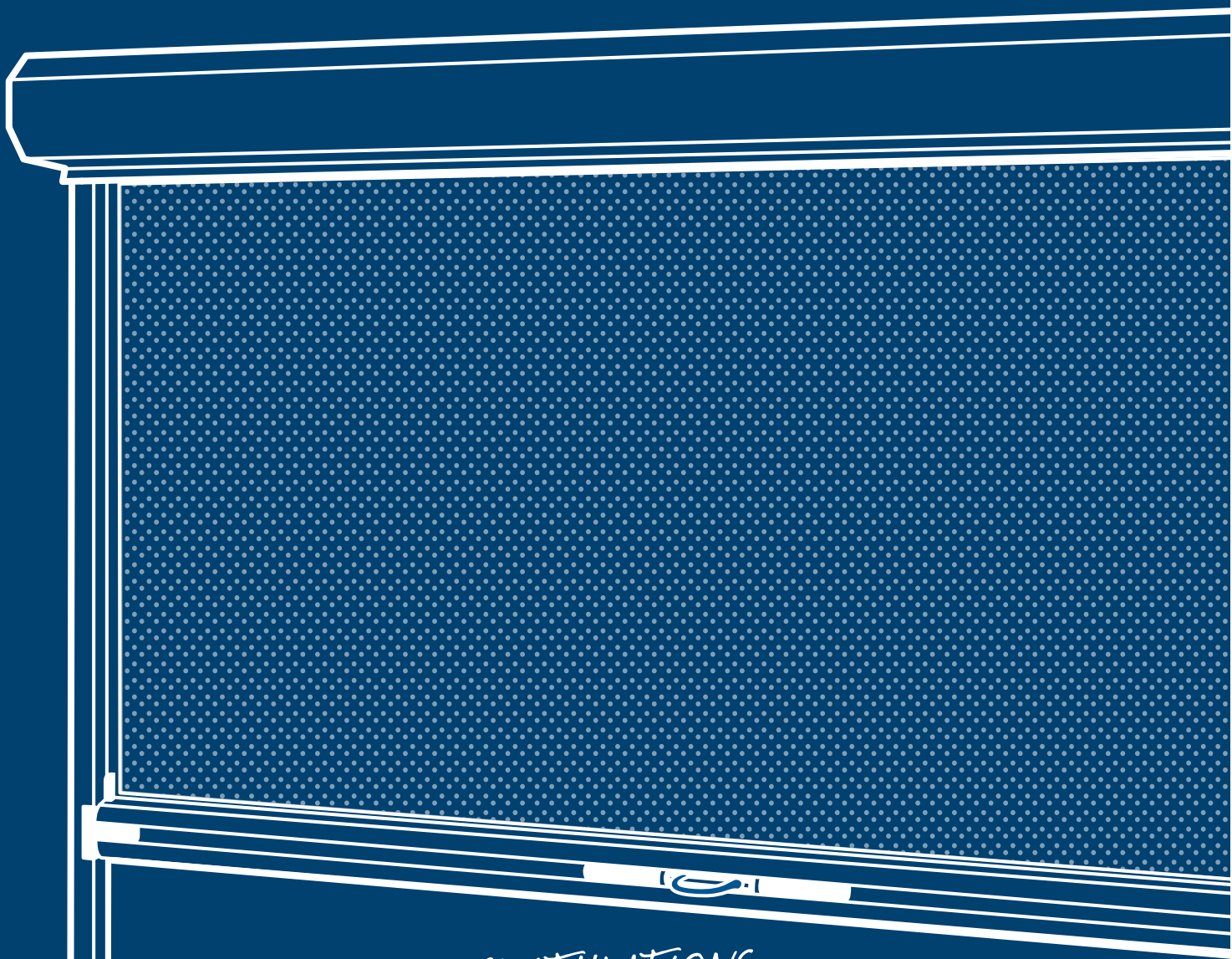

# User Guide

AUSTRALIA'S FAVOURITE TRACK-GUIDED BLIND SYSTEM



CONGRATULATIONS  
on your investment in genuine  
Ziptrak® outdoor blinds.

## AFTER INSTALLATION

PVC and Sunscreen Mesh blinds have been rolled up for transportation. You may need to leave the blinds down for several days to allow the material to settle.

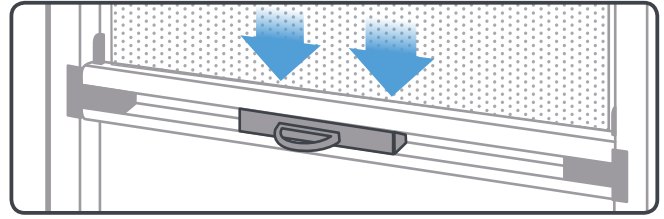

## OPERATION

Ziptrak® blinds are easy and simple to use, providing a smooth glide for years of care-free operation. If it is difficult to raise or lower your blind for no obvious reason, please contact your Ziptrak® retailer.

### Spring-balanced

Spring-balanced blinds allow you to easily lower or raise the blind, with a sophisticated spring that supports the weight of the blind. The blind should be hand-operated from the centre of the bottom bar. This ensures the material rolls evenly onto the top tube. The blind should always glide smoothly and easily along the track.

### Motorised

Motorised blinds are operated by utilising the remote control provided and must be supervised while moving. Refer to the remote control instructions for operating guidance. Motorised blinds can not be hand-operated and doing so may damage the blind. Unless your motorised blinds are solar powered, they will not operate during a power outage.

### How to unlock the blind

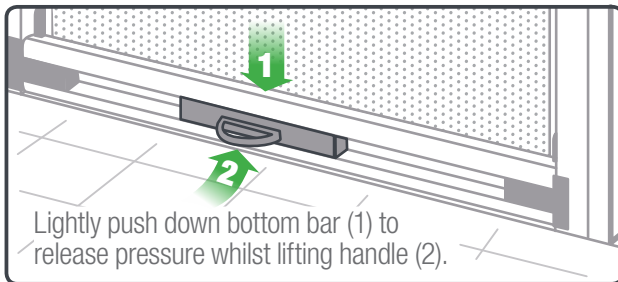

### How to use the pull stick

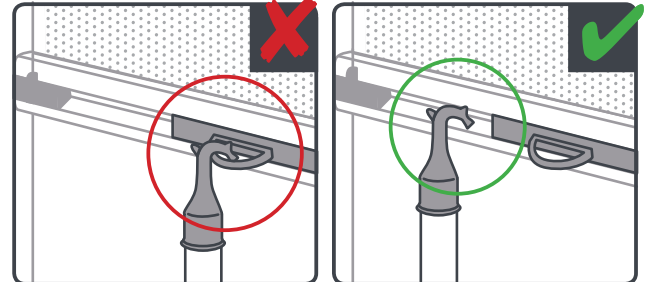

## Ziptrak® blinds can be left at any height

### 1 Unlock the blind



### 2 Retract the blind

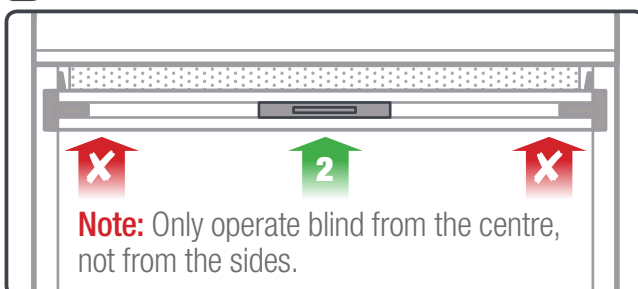

We recommend retracting the blind, then lowering.

To achieve the best appearance of your Sunscreen Mesh or Clear PVC blinds, it is important that the blind is partially retracted and then lowered to your final desired height.

### 3 Lower to the preferred height

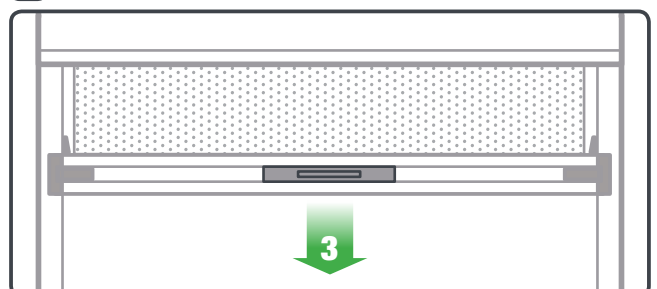

## Avoid rolling up the blind when it is wet

Moisture within the rolled up blind material may cause mould to form.

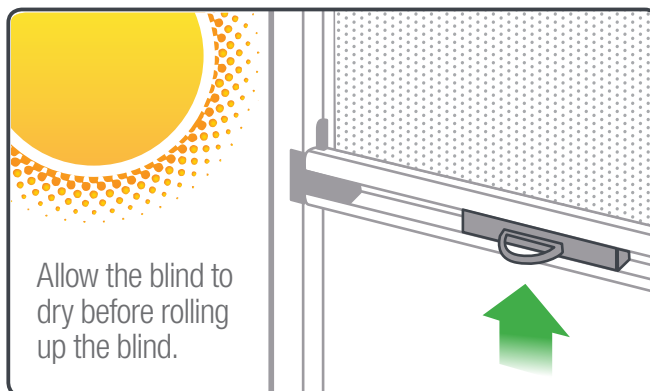
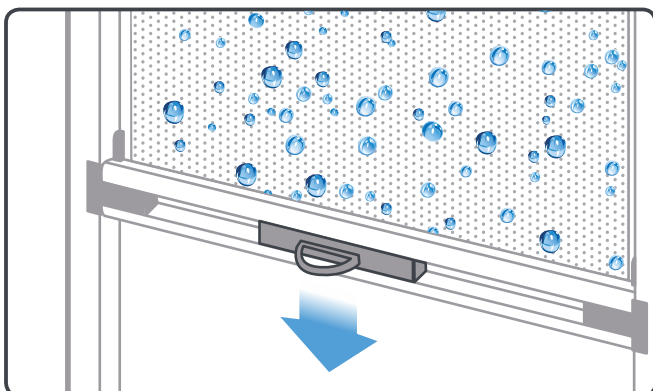

## WINDY CONDITIONS

Ziptrak® blinds are trusted by thousands of Australian homes and businesses to provide an enjoyable outdoor living space. The strong and robust system is commonly installed throughout coastal regions and locations prone to high winds.

You may find Ziptrak® spring-balanced blinds are a little tricky to operate during windy conditions due to the pressure of the wind on the blind material. Use your hand to push against the blind material to reduce this pressure and then operate the blind.

Care must be taken when operating motorised Ziptrak® blinds in windy conditions. They must be supervised whilst raising and lowering at all times.

In windy conditions, blinds should be left down and locked, or fully retracted – half way is the most vulnerable position. When expecting or experiencing very strong winds, a storm or a severe weather event, your blinds should be fully retracted.

Installation is crucial to determining the performance of your blind in wind. For further information, please speak with your retailer, or visit the Ziptrak® website.

## CLEANING

With correct cleaning and maintenance, Ziptrak® blinds will look great and function properly for years. Mesh and PVC blind materials are not Ziptrak® products. Please speak with your retailer to receive complete care instructions from the relevant Mesh or PVC manufacturer.

### Sunscreen Mesh Blinds:

- Clean the blind with Swiftee® outdoor blind cleaner. Swiftee® is compatible with both SunScreen Mesh and Clear PVC outdoor blinds. Sparkling outdoor blinds are quick and easy to achieve with Swiftee®! For more information visit: [www.ziptrak.com.au/swiftee-outdoor-blind-cleaner/](http://www.ziptrak.com.au/swiftee-outdoor-blind-cleaner/)
- **Do not** use bore water or allow bore water springer systems to wet the blind. Never allow petrochemicals or solvents to touch the blind.
- **Do not** use a high pressure hose to clean the blind.



### PVC Blinds:

- **Do not** use window cleaning detergents to clean the PVC.
- Clean the blind with Swiftee® outdoor blind cleaner.
- Never allow bird droppings, dirt or stains to remain on the PVC for long periods of time.
- The PVC surface is highly sensitive to scratching and marks. Always be cautious when cleaning, operating or moving items around PVC blinds.
- Ideally, use a soft, clean cloth to polish and dry the PVC after cleaning and prior to rolling up the blind.
- Do not use a high pressure hose to clean the blind.

## MAINTENANCE

In general, Ziptrak® blinds should not require additional lubrication by the owner. However, in dusty and seafront locations, approximately once a year you may wish to add lubricant to assist in the continued smooth operation of the blind. **You must use silicone spray, such as food grade Helmar H4000.**

To apply, lower the blind all the way; evenly apply the spray in the groove between the spline and the track. Do this for the front of the blind only, on both the left and right sides. After lubrication, open and close the blind several times to evenly distribute the silicone spray within the track.

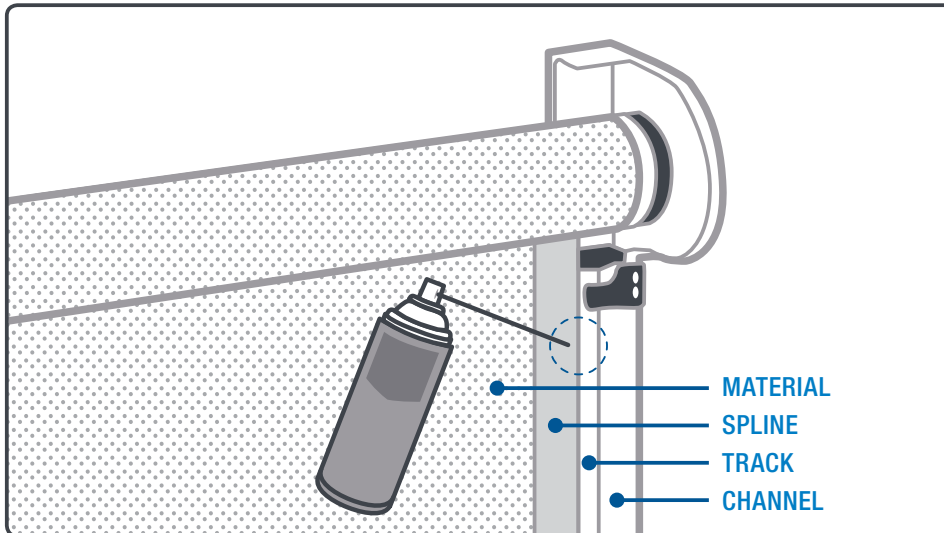

It is very important that you do not use any oil based lubricants such as WD40, as they will damage the spline tape and clog the dust that may be within the track.

## WARRANTY

Please contact your retailer to discuss their warranty period and inclusions. Ziptrak® provides retailers with a 24-month warranty of all the components on the Ziptrak® outdoor system. If you have any questions or concerns regarding the performance, operation or maintenance of your blind system, or require replacement parts, please contact your retailer. Alternatively, contact Ziptrak® customer support.

Your local Ziptrak® expert

# Sunset Canvas

**341 Taylor Street, Toowoomba, Qld, 4350.**

**Phone: 07 46331600**

**Email: [admin@sunsetcanvas.com.au](mailto:admin@sunsetcanvas.com.au)**

**Website: [www.sunsetcanvas.com.au](http://www.sunsetcanvas.com.au)**

[www.ziptrak.com.au](http://www.ziptrak.com.au) | Phone 1300 77 00 65 | [enquiry@ziptrak.com.au](mailto:enquiry@ziptrak.com.au)