



WORLD ACCESS

Security | Automation | Home Theatre

System Integration Expert In Electronic Security,
Home Automation, Home Theatre, and complete
Audio-Video Solutions.

Core Value & Beliefs

We are **technology enthusiast** System Integrator, who provides solutions through **latest** technology products in the field of **Electronic Security, Home Automation and Home Theatre**. We deal in products which has best **Value for Money** in its segment.

Purpose

To be the **leading link** between the latest **technologies** and its **daily usability** and thereby **implementing** that in Everyone's day to day life.

Electronic Security – CCTV (Surveillance)



- ▶ Wireless Solution from 4KM upto 40KM.
- ▶ IP CCTV with Video analytics.

❖ *Honeywell, Dahua, Hikvision.*

Electronic Security

➔ Intruder Alarm System



PIR Motion Sensor | Magnetic Door Sensor | Shutter Sensor | Panic Switch | Siren / Hooter
Smart Switch PIR Sensor | Outdoor PIR Sensor | Wired Control Panels | Wireless Security System

❖ *Texecom, AJAX*

Audio - Video Door Phone

➔ B / W & Color Door Phones



Bungalow / Single Apartment VDP System | Multi Apartment VDP System
VDP with Intercom | VDP with Access Control | VDP with Electronic Door Lock

Electronic Security – IP Video Door Phone

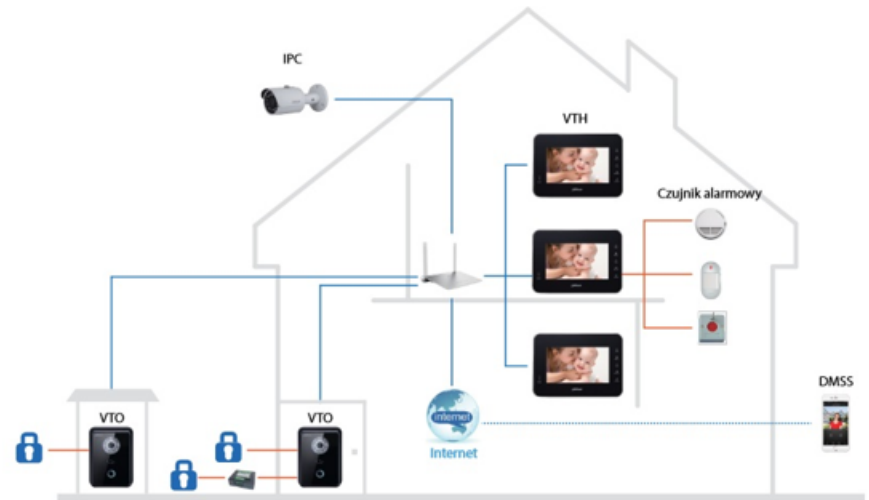

Electronic Security

A promotional graphic for the Panasonic electronic security system. The background is a solid blue color. At the top, the camera unit, the main receiver unit, and a cordless handset are displayed. The receiver unit's screen shows a family sitting on a couch. Below the products are four circular icons, each with a white background and a blue border, representing key features:

- VOICE CHANGE FACILITY**: An icon of a woman's face with a speech bubble saying "Hi, thank you".
- CORDLESS AND WIFI**: An icon of the receiver unit and a cordless handset.
- EASY INSTALLATION (2 WIRE)**: An icon of a hand using a screwdriver to install a device on a wall.
- PICTURE RECORDING FUNCTION**: An icon of a hand holding a USB drive next to a computer monitor.

Electronic Security



Electronic Security

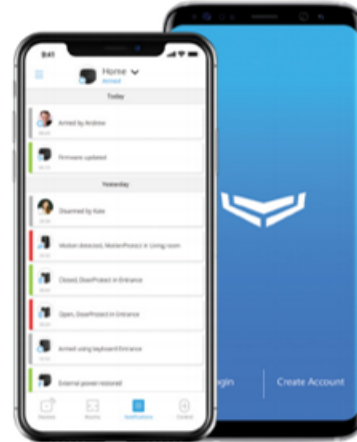
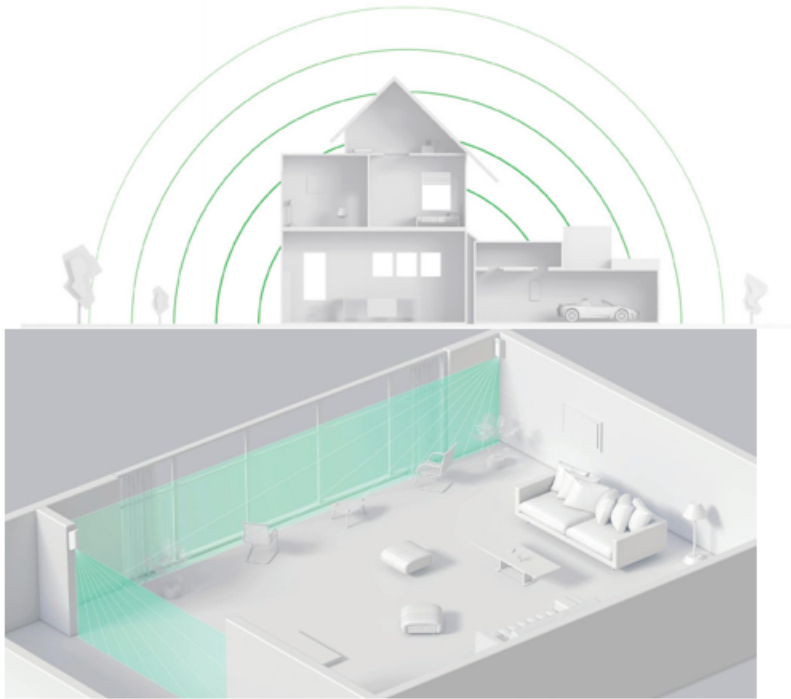

StreetSiren

Wireless outdoor siren
with vandalism resistance

Wireless outdoor siren that notifies of danger using sound and light. The device is installed outside the room to raise an alarm for everyone to hear.



Electronic Security

➡ Card and Fingerprint Machines



Proximity Card Based Machines | Smart Card Based Machines
Biometric Finger Print Based Machines

➡ Access Control System



Proximity Card Based Readers | Smart Card Based Readers | Fingerprint Based Readers
Multidoor Controllers | EM Lock | Exit Switch | Access Control Software



Electronic Security – Gate Automation



Gate / Door Automation



Sliding and Swing Gate Automation | Sensor Sliding Door | Shutter Automation
Remote Control operation | Flap Barriers | Turns Tiles | Automatic Boom Barriers

❖ *RAVEL, ZKT,
ESSL*

Home / Office Automation

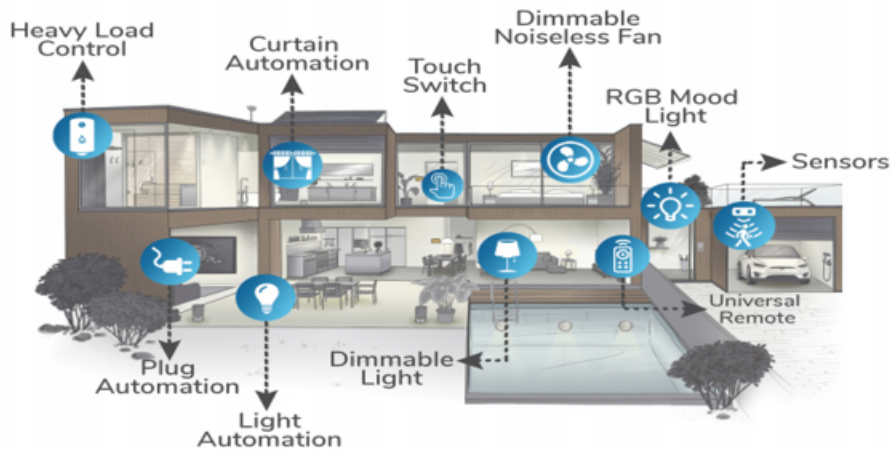

- Control via Mobile or Automatic with sensors and Voice Prompt (Google, Alexa)
- Saves power when using on Dim Mode.
- Control your appliances remotely.

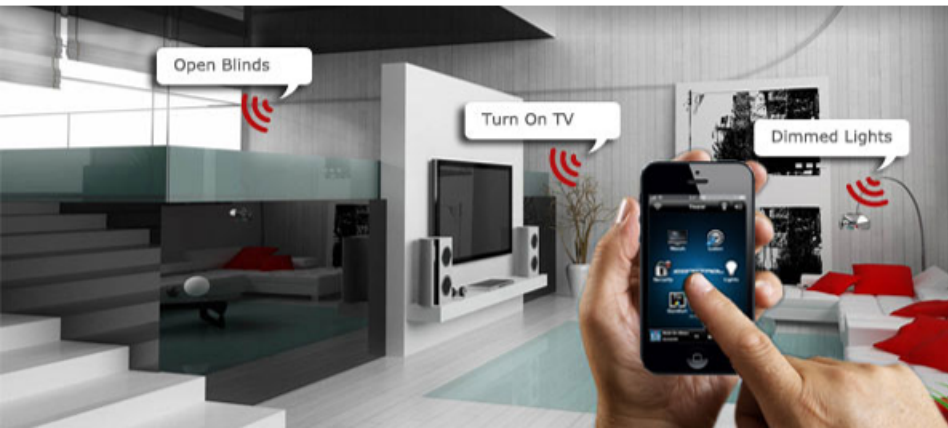

Complete home automation solution

Now, Convert your home into smart home in just 30 minutes

No renovation + Easy to install + Budget friendly



Scheduling

Automatically control your appliances and have a tension-free schedule for it



Child Lock

User can lock the physical access to their appliances like A.C, T.V. etc. in any state they wish



Geo Fencing

Automatic scenes can be executed as per our entering or exiting a specific location



Custom Scene

Create a romantic atmosphere or party mood on a single click

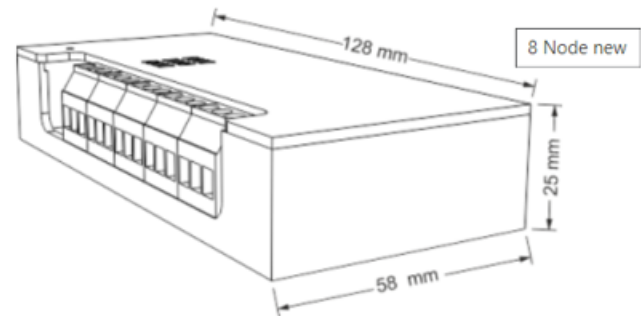

Get Started with Smart Device



Smart Device



SD

Touch Switch +Remote +Wi-Fi



TSRW

Touch Switch +Remote



TSR

Touch Panel +Remote +Wi-Fi



TPRW

Touch Panel +Remote



TPR



BT Blaster

BT Blaster Emitter



Works with Roman shades, Projector screens, Single/Double panel curtains and many more

Door Lock Controller

With Smart Node Door Lock Controller, secure and protect your family, home and valuables by controlling your Digital or Electromagnetic locks.



RGB Controller

Smart Node RGB Controller is designed for mood lighting. Enhance and control the ambience of your home from anywhere anytime.



Touch Switches

Smart Node 'Touch Switch' will replace your traditional switches with modular Touch Switches and gives you complete control from your Smartphone, Voice Assistants and Remote.

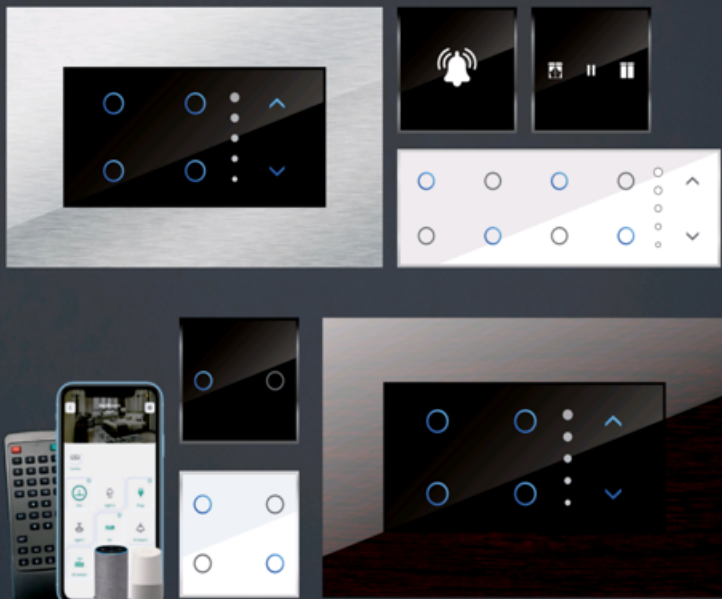

Supported Brand Accessories

Schneider Legrand Larsen & Toubro
Goldmedal Norisys Hager

Switch Customization



Touch Panel

Similar to Touch Switches, you can control the the 'Touch Panel' with Smartphone, Voice Assistants and Remote, but in Touch Panel you won't require any additional electrical plates.

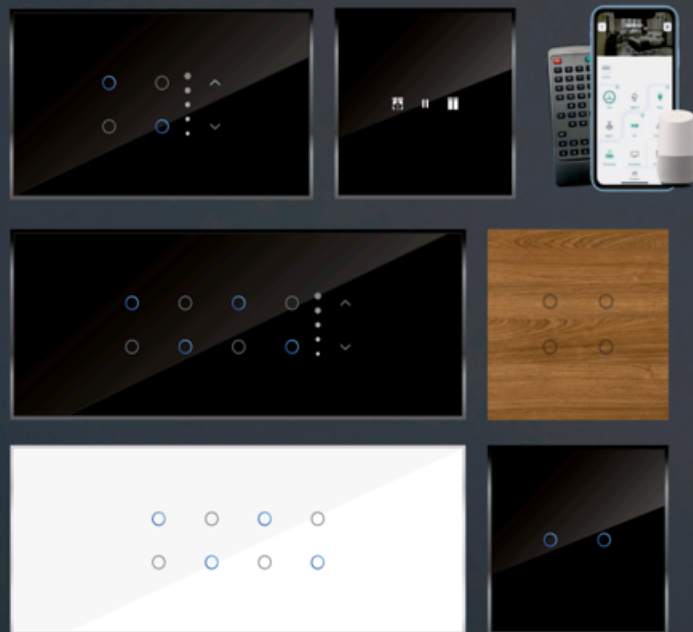

Panel Customization





A floor plan diagram of a home theatre room. The room is rectangular with a large screen on the right wall. In the center, there are two rows of seats facing the screen. A large curved sofa is on the left wall. There are two potted plants in the corners of the room. The text 'Home Theatres' is centered in the room, with a list of specifications below it.

Home Theatres

- Dolby Atmos – 7.1.2
- Dolby - 5.1
- 100 – 200 Inch Diagonal Screen

Room Size & Calculations

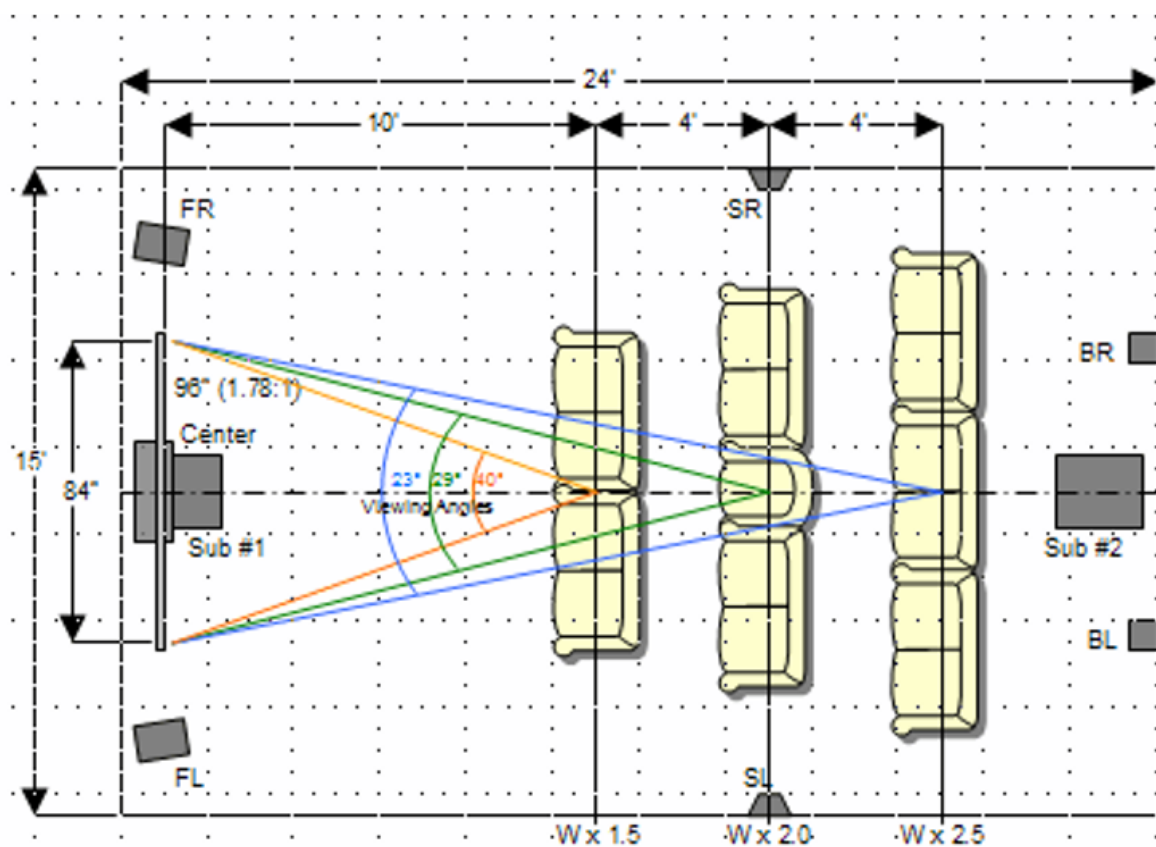

Viewing Distance & Eye Angle

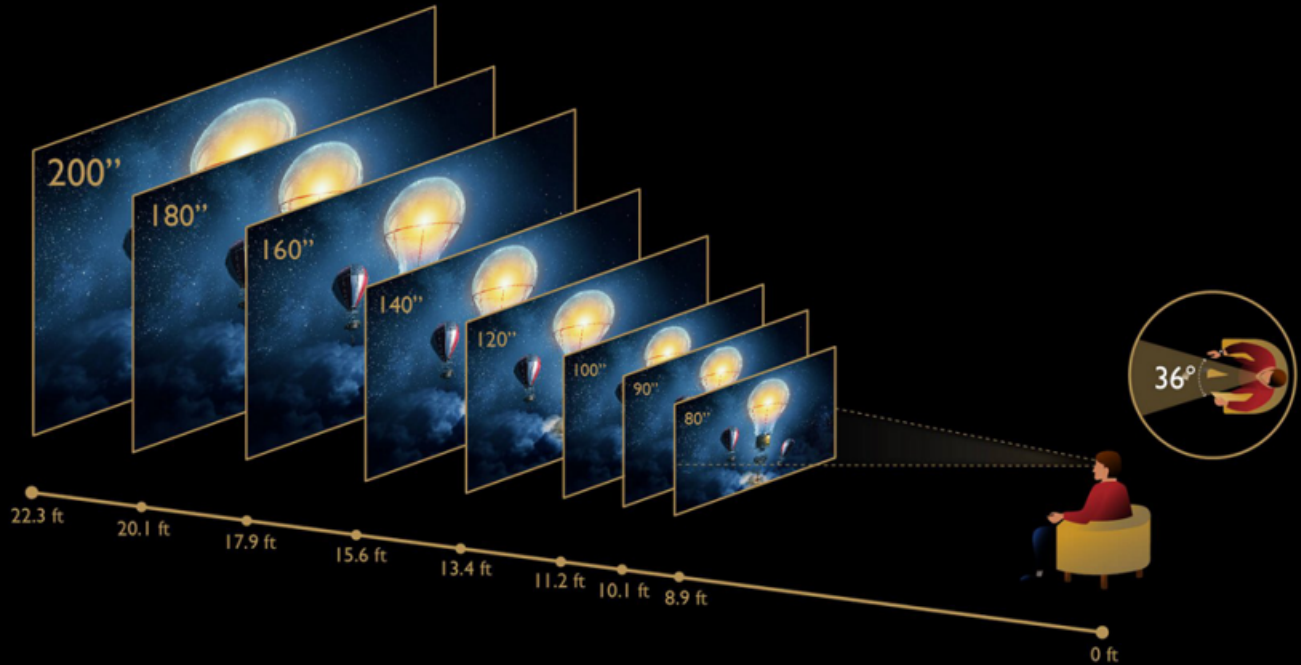

Optimal viewing distance by the size of the television and the resolution

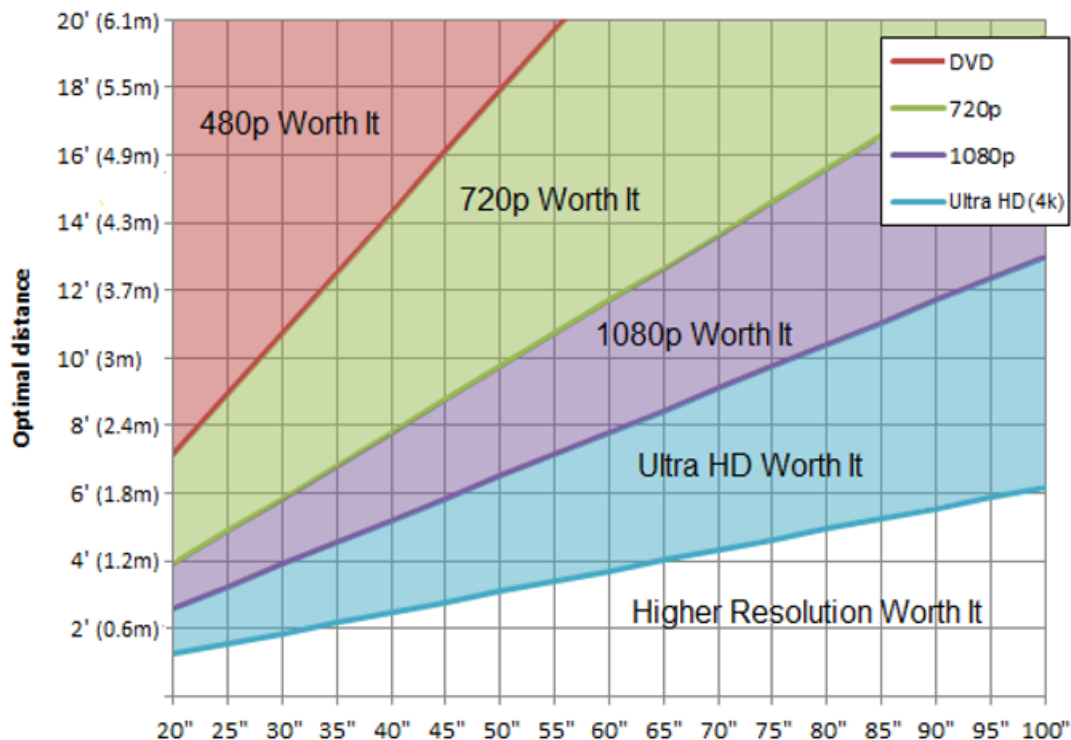

Home Theatre



- Latest Dolby ATMOS
- Complete Acoustic treatment
- Direct Satellite Movie Release



❖ *Klipsch,
Jamo, JBL,
Epson,
Vivitek
and many*

Home Theatre



AV Solutions – Multi Room Audio & Video



- TATA Sky , Blu-ray player, DVD player etc from central location all TV
- Audio/Video/Picture from central storage to all TV, Mobiles, Laptops. (2 way Viewing and Editing)

Public Address System (AV Solution)

Speakers



Ceiling Mount Speakers | Wall / Column Mount Speakers

Outdoor Speakers (Horn Speakers, Garden Speakers) | Special Application Speakers

Amplifiers



Power Amplifiers | Two Zone Amplifiers | Mixer Amplifiers | Amplifier with built in DVD / MP3 / USB

Other Public Address Products



Microphones | Volume Controls | Conference Room Solutions | Cordless Microphone

- Weather Proof Outdoor Rock Speakers
- IP PA System
- DVAMBS
- Amphitheatres
- Fire Detection with PA integration.
- Solutions Upto 30 KMs

AV – Solutions

EPABX / KTS System

Analog and Digital EPABX System



Analog EPABX from 4 lines / 24 Extensions | Digital EPABX from 16 lines / 3000 Extensions
IP Telephony | PRI / BRI Connectivity | Digital Key Phones | Operator Console

Multimedia Projectors



DLP Projectors | LCD Projectors | Wireless Projectors | Document Projectors | Projector Screens

An ISO 9001:2015 certified company



WORLD ACCESS

Security | Automation | Home Theatre

Siddharth Chovatia

Mobile – 9898161231

siddharth@worldaccess.in
www.worldaccess.in

