

U_p-value of
up to approx.
0.47
W/(m²·K)



As standard for
ThermoCarbon
and ThermoSafe
entrance doors



Entrance Doors

ThermoCarbon, ThermoSafe, Thermo65, TopComfort

HÖRMANN



CONTENT

4	Good reasons to try Hörmann
10	Hörmann brand quality
12	Programme overview
14	Safety equipment
16	ThermoCarbon
28	ThermoSafe
54	Thermo65
66	TopComfort
72	Special equipment
86	Lock variants ThermoCarbon / ThermoSafe
90	Hörmann product range

The colours and surface finishes shown are subject to the limitations of the printing process and cannot be regarded as binding.

Some of the products and equipment details described and illustrated in this catalogue are not standard, but available for a surcharge depending on the equipment option. Please contact your Hörmann Partner with reference to the current price list for specific door equipment.

Descriptions and pictures, information about the scope of delivery, equipment and colour correspond to the time of printing.
Subject to changes and errors.

All rights reserved. No part may be reproduced without our prior permission.

◀ **ThermoCarbon style 305** in preferred Hörmann colour CH 703 Anthracite, textured, aluminium embellishment in preferred colour White aluminium RAL 9006, silk-gloss, handle in stainless steel, recessed grip in door colour, on-site glazing elements

“A good reputation must be earned.”

August Hörmann

In keeping with the tradition started by the company's founder, the name Hörmann delivers brand name quality with extensive product expertise. The family business has over 80 years of experience as a construction component specialist and sees itself as your partner from the very beginning of building and renovation projects. It's no surprise that Hörmann is one of Europe's most successful entrance door providers. All of this gives you a good feeling when you purchase a Hörmann entrance door.



1 Quality products from Germany

The entrance door construction is developed and manufactured by Hörmann. Our highly qualified employees work intensively on new products, continual further developments and improvements to details. Patents and unique products on the market are the result of this. Endurance tests under real conditions **ensure mature series products with Hörmann quality.**

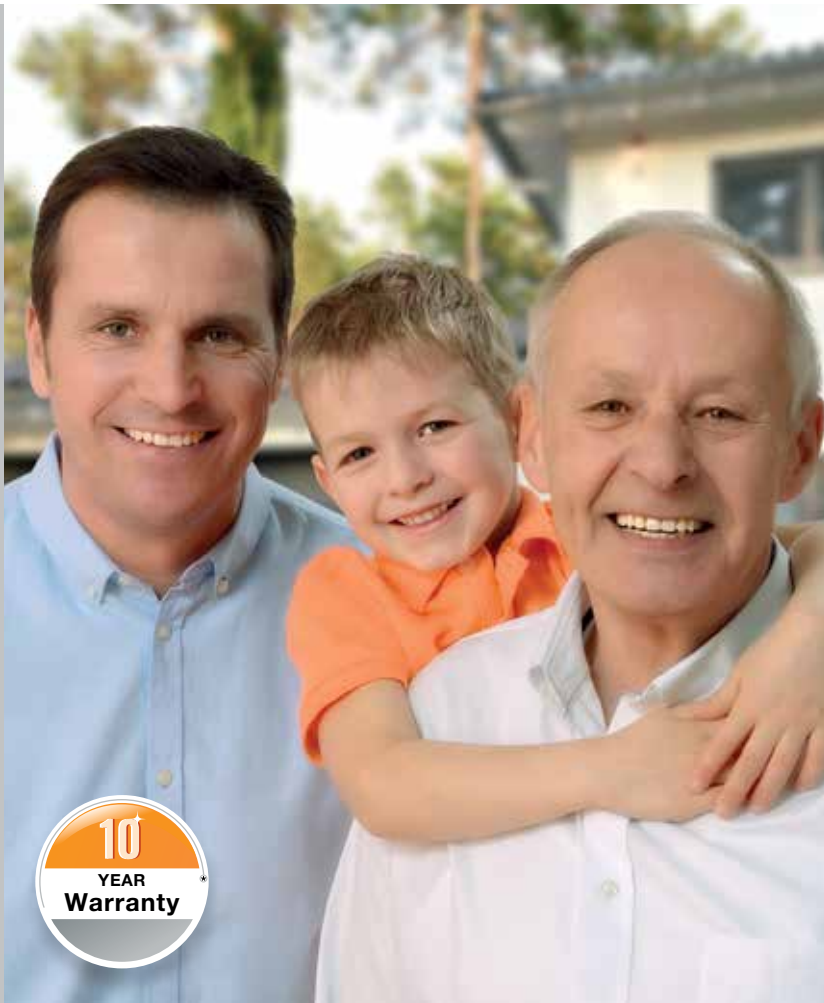

2 Entrance doors for generations

We are convinced of our products and our uncompromising quality assurance. That is why we issue a **5-year guarantee*** on Thermo65 entrance doors and even a **10-year guarantee*** on ThermoCarbon, ThermoSafe and TopComfort entrance doors.

3 An eye on the future

Hörmann is setting a good example. That is why the company obtains **100 % of its required energy from green sources**. At the same time, many tonnes of CO₂ are saved each year thanks to the introduction of an intelligent and certified energy management system. And last but not least, Hörmann offers products for sustainable construction. Find out more about Hörmann's environmental activities in the "We Think Green" brochure.

* The complete warranty conditions can be found at: www.hoermann.com



External view



Interior view

4 Door leaf without visible leaf profile

Our ThermoCarbon, ThermoSafe and Thermo65 entrance doors give you an exquisite and elegant reception. The shapely door leaf with its **solid interior and exterior and leaf profile** on the inside fulfils the highest design requirements. The interior view harmonises perfectly with your residential internal doors and looks particularly elegant with concealed hinges, which come as standard for ThermoCarbon and are optional for ThermoSafe entrance doors.



External view of entrance doors from other manufacturers with visible leaf profile



Interior view of entrance doors from other manufacturers with visible leaf profile and glazing beads

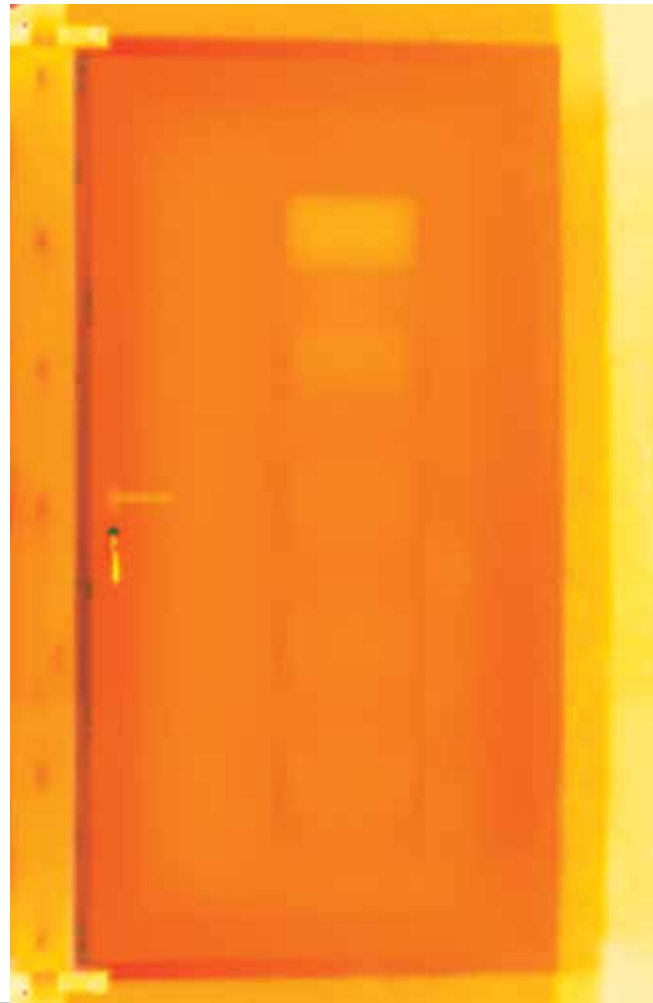

5 Excellent thermal insulation

ThermoCarbon aluminium entrance doors with a U_D -value of up to approx. $0.47 \text{ W}/(\text{m}^2\cdot\text{K})^*$

Our doors are the new generation of high-insulation entrance doors. With U_D -values up to approx. $0.87 \text{ W}/(\text{m}^2\cdot\text{K})$, Thermo65 doors have excellent thermal insulation values. ThermoSafe entrance doors are also distinguished by their U_D -values of up to approx. $0.87 \text{ W}/(\text{m}^2\cdot\text{K})$. Both door systems comply with all the requirements of the energy saving regulation. Our ThermoCarbon entrance doors are clearly the **world champions** when it comes to thermal insulation: They feature unparalleled U_D -values up to $0.47 \text{ W}/(\text{m}^2\cdot\text{K})$ and are also certified for low-energy houses by the ift Rosenheim.



Only from Hörmann

No thermal bridges for glazings

For ThermoSafe and ThermoCarbon entrance doors with glazing, the door leaf is foamed together with the glazing and not beforehand, as is usually the case. **This patented solution means that we can achieve even better thermal insulation**, as the foam is combined with the glazing in an optimal way that prevents thermal bridges.

* Dependent on door size. Specified values for RAM 1250 x 2200 mm.



6 Break-in-resistant security equipment



Only from Hörmann

RC 4 security equipment for ThermoCarbon entrance doors

Our entrance doors set new standards for security. **All ThermoSafe and ThermoCarbon entrance doors are available as standard with the break-in-resistant security class RC 3.** ThermoCarbon entrance doors are at the top of their class with optional security equipment RC 4. Thermo65 and TopComfort entrance doors are optionally available with RC 2 equipment.

7 Safe glazing



Only from Hörmann

As standard with laminated safety glass on the interior and exterior

When it comes to industrial safety and burglar protection, Hörmann entrance doors fulfil the highest demands. The laminated safety glass on the interior and exterior of the insulated glazing provides **maximum security**. In case of breakage, the glass splinters are bound and stay adhered to the plastic film on the inside, virtually eliminating any danger of being injured by the shards. Furthermore, the laminated safety glass offers better protection against burglars as it makes reaching through more difficult.



8 Convenient opening aids

Fascinating and innovative technology that offers you more comfort: the Hörmann door operator ECturn automatically opens your ThermoSafe and ThermoCarbon entrance doors. You can conveniently use the operator with Hörmann BiSecur hand transmitters or radio buttons. With the BiSecur app, you can query the status of your door at any time and from anywhere in the world. The ECturn operator is also **ideally suited for barrier-free construction**. For further information, please see page 89.

9 Room-high entrance doors

ThermoSafe and ThermoCarbon entrance doors in XXL versions offer you **generously proportioned entrance designs** and increased comfort. ThermoSafe styles are available up to a height of 2500 mm, and ThermoCarbon even up to 3000 mm.

Home begins at your door

We can feel at ease in many different places and in many different ways. In the city or in the country, surrounded by nature or by good friends. But there is a unique and unmistakable feeling that everybody experiences in their own way: the feeling of being at home, the moment they open the front door.

A Hörmann entrance door contributes its part to all the things that make a home, creating a sense of well-being, content and security. Take your time to browse our comprehensive programme – we're sure you will find the entrance door that best suits your taste and your home's architecture.





Which door fulfils your requirements?

Discover the four entrance door versions from Europe's no. 1. Each one of them fulfils your personal requirements for an entrance door in its own way. However, they all have one thing in common: genuine Hörmann brand quality!

Aluminium and steel entrance doors are superior to plastic or timber doors in many ways. The advantages:

- High thermal insulation
- High security
- High acoustic insulation
- High stability
- No follow-up painting necessary

Aluminium and steel entrance doors look new even after many years, and also offer you a large variety of options with regard to technical equipment and design.



ThermoCarbon

U_D -value up to approx.
0.47 W/(m²·K)*

Approved by the ift Rosenheim

Premium class:
ThermoCarbon



As standard

Our thermal insulation world champion, best-in-class for security for aluminium entrance doors, is distinguished by U_D -values of up to approx. 0.47 W/(m²·K). It is also characterised by outstanding **standard RC 3 security equipment** with 9-point locking and a high-tech leaf profile made of carbon glass-fibre hybrid material. See the unique ThermoCarbon entrance doors for yourself, starting on page 16.

* Dependent on door size. Specified values for RAM 1250 × 2200 mm.

** Dependent on door size. Specified values for RAM 1230 × 2180 mm.

***Dependent on door size. Specified values with special equipment thermal insulation kit for RAM 1230 × 2180 mm



ThermoSafe

U_D -value up to approx.
0.87 W/(m²·K)**

Approved by the ift Rosenheim



Thermo65

U_D -value up to approx.
0.87 W/(m²·K)**

Approved by the ift Rosenheim



TopComfort

U_D -value up to approx.
1.3 W/(m²·K)***

Approved by the ift Rosenheim

Top class:
ThermoSafe



As standard

Especially high thermal insulation thanks to a 80-mm aluminium frame with thermal break, **standard RC 3 security equipment** with a 5-point security lock and a choice of over 70 styles – these are only a few of the convincing arguments our ThermoSafe entrance door has to offer. For more details and to find your favourite style, see from page 28.

Mid-range:
Thermo65

The Thermo65 entrance door with steel door leaf and aluminium frame offers good thermal insulation values and **high break-in-resistance** with a 5-point security lock. Last but not least, Thermo65 has an excellent price-performance ratio. For more information on Thermo65 and all styles and equipment options, see from page 54.

Comfort category:
TopComfort

Are you looking for an **entrance area bathed in sunlight** with a glass entrance door that is well equipped in terms of thermal insulation and security? Then our TopComfort entrance door is just right for you. Choose your favourite from 9 glazing designs and a variety of ornamental glazings. For more information on TopComfort, see from page 66.



We protect you from unwanted visitors

Over the past few years, the number of burglaries has greatly increased, making it even more important to equip your entrance door with a high security standard. If a burglar is not successful within approx. 3 – 5 minutes, they generally give up their break-in attempt. For this reason, nearly half of all break-in attempts fail if the entrance door is break-in-resistant.

As standard for all ThermoCarbon and ThermoSafe entrance doors, optionally for side elements and transom lights

Burglar description according to DIN EN 1627:

The burglar attempts to break open the door using two screwdrivers, pliers, wedges, a crowbar as well as with a simple drilling tool.

Resistance time: 5 minutes



Optionally for all Thermo65 and TopComfort entrance doors, side elements and transom lights

Burglar description according to DIN EN 1627:

The opportunist burglar attempts to break open the locked door with a screw driver, pliers and wedges.

Resistance time: 3 minutes



Optionally for all ThermoCarbon entrance doors

Burglar description according to DIN EN 1627:

In addition to screw drivers, pliers, wedges, a crowbar and a simple drilling tool, experienced burglars also use saws and striking tools such as axes, chisels, hammers and bits as well as cordless drills.

Resistance time: 10 minutes





Thermal insulation world champion and best-in-class for security

Our aim was to create an entrance door that exceeds your requirements for security, thermal insulation, technical equipment and design. We have succeeded with the premium ThermoCarbon entrance door. With U_D -values up to approx. $0.47 \text{ W}/(\text{m}^2 \cdot \text{K})$, ThermoCarbon has earned its title as thermal insulation world champion, and with the optional RC 4 equipment, it is at the top of its class in terms of security for aluminium entrance doors. With its high-tech leaf profile made of carbon glass-fibre hybrid material, our premium entrance door is exceptionally impressive, offering a high degree of rigidity and impact resistance as well as improved acoustic insulation like none other.

The ThermoCarbon entrance door is available in a choice of 15 modern door styles and 18 preferred colours, and optionally in two colours on request. Of course, you can customise your entrance door even further with many other equipment options such as handles, glazings and lock variants.

Design

- 1 100 mm aluminium door leaf with PU rigid foam infill and internal leaf profile
- 2 Thermal break and high stability thanks to carbon glass-fibre reinforced composite leaf profile
- 3 111 mm aluminium door frame with thermal break
- 4 Triple sealing with two all-round seals

Fulfills all requirements of the energy saving regulation and is certified for low-energy houses by the ift Rosenheim*

Suitable for fitting without thermal bridges

U_D -value up to approx. $0.47 \text{ W}/(\text{m}^2\cdot\text{K})$

U_D -value of up to approx. **0.47**
 $\text{W}/(\text{m}^2\cdot\text{K})$

Equipment

- 5 Solid door view from the inside, same as room doors
- 6 Concealed hinges
- 7 Stainless steel lever handle
- 8 Tamper-proof profile cylinder
- 9 **RC 3 security equipment** with 9-point security lock

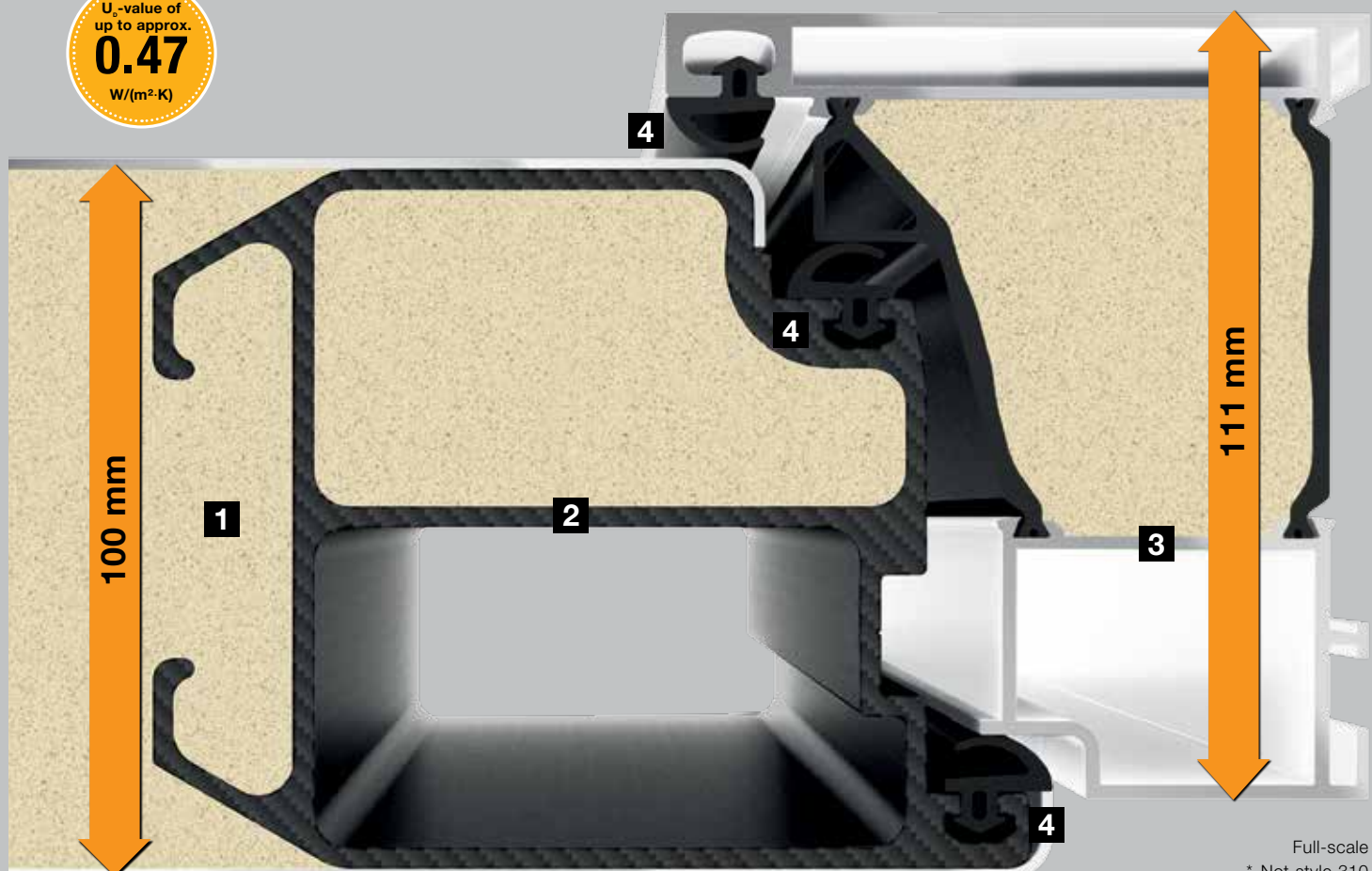

Interior view





Style 300

Handle bar as standard in White aluminium RAL 9006, silk-gloss, recessed grip in door colour as standard, certified low-energy house door, U_D -value up to approx. $0.50 \text{ W}/(\text{m}^2\cdot\text{K})^*$



Style 301

Handle bar as standard in White aluminium RAL 9006, silk-gloss, recessed grip in door colour as standard, certified low-energy house door, U_D -value up to approx. $0.50 \text{ W}/(\text{m}^2\cdot\text{K})^*$



Style 302

Flush-fitting handle bar as standard in White aluminium RAL 9006, silk-gloss, recessed grip in door colour as standard, stainless steel embellishments, matt float design glass with one clear stripe, quadruple thermal insulation glass, certified low-energy house door, U_D -value up to approx. $0.57 \text{ W}/(\text{m}^2\cdot\text{K})^*$



Style 312

Flush-fitting handle bar as standard in White aluminium RAL 9006, silk-gloss, recessed grip in door colour as standard, matt float design glass with one clear stripe, quadruple thermal insulation glass, certified low-energy house door, U_D -value up to approx. $0.57 \text{ W}/(\text{m}^2\cdot\text{K})^*$



Style 308

Flush-fitting handle bar as standard in White aluminium RAL 9006, silk-gloss, recessed grip in door colour as standard, certified low-energy house door, U_D -value up to approx. $0.51 \text{ W}/(\text{m}^2\cdot\text{K})^*$



Style 309

Flush-fitting handle bar as standard in White aluminium RAL 9006, silk-gloss, recessed grip in door colour as standard, certified low-energy house door, U_D -value up to approx. $0.51 \text{ W}/(\text{m}^2\cdot\text{K})^*$





Style 304
Flush-fitting stainless steel handle, recessed grip in door colour as standard, certified low-energy house door, U_D -value up to approx. $0.50 \text{ W}/(\text{m}^2\cdot\text{K})^*$



Style 305
Flush-fitting stainless steel handle, recessed grip in door colour as standard, flush-fitting aluminium embellishment, certified low-energy house door, U_D -value up to $0.50 \text{ W}/(\text{m}^2\cdot\text{K})^*$



Style 306
Flush-fitting stainless steel handle, recessed grip in door colour as standard, stainless steel embellishments, matt float ornamental glass, quadruple thermal insulation glass, certified low-energy house door, U_D -value up to approx. $0.57 \text{ W}/(\text{m}^2\cdot\text{K})^*$



Style 314
Flush-fitting stainless steel handle as standard, recessed grip in door colour as standard, matt float ornamental glass, quadruple thermal insulation glass, certified low-energy house door, U_D -value up to approx. $0.57 \text{ W}/(\text{m}^2\cdot\text{K})^*$



Style 310
Flush-fitting stainless steel handle, recessed glazing cut-out, matt float ornamental glass, triple thermal insulation glass, U_D -value up to approx. $0.63 \text{ W}/(\text{m}^2\cdot\text{K})^*$



Style 565
DesignPlus handle G 760, handle embellishment in anodised aluminium E6 / EV 1, U_D -value up to approx. $0.50 \text{ W}/(\text{m}^2\cdot\text{K})^*$



Style 568

Design handle G 750 in anodised aluminium E6 / EV 1, U_D -value up to approx. $0.50 \text{ W}/(\text{m}^2\cdot\text{K})^*$



Style 650

Stainless steel handle HOE 700, ornamental glass Pave white, triple thermal insulation glass, certified low-energy house door, U_D -value up to approx. $0.57 \text{ W}/(\text{m}^2\cdot\text{K})^*$



Style 680

Stainless steel handle HOE 700, stainless steel embellishments, ornamental glass Pave white, quadruple thermal insulation glass, certified low-energy house door, U_D -value up to approx. $0.57 \text{ W}/(\text{m}^2\cdot\text{K})^*$



Style 686

Stainless steel handle HOE 600, stainless steel embellishment, matt float design glass with 7 clear stripes, quadruple thermal insulation glass, certified low-energy house door, U_D -value up to approx. $0.55 \text{ W}/(\text{m}^2\cdot\text{K})^*$



Style 860

Stainless steel handle HOE 700, certified low-energy house door, U_D -value up to approx. $0.50 \text{ W}/(\text{m}^2\cdot\text{K})^*$

Find your favourite colour

Whether you prefer anthracite or white, red or green, smooth or textured – Hörmann offers you custom design possibilities for colour and surface finish. As standard, entrance doors are delivered in inexpensive matt Traffic white, RAL 9016. In addition to our 19 preferred colours, you will certainly find something to suit your taste in our selection of over 200 RAL colours. Would you like different colours on the inside and outside? That's no problem either. Simply contact your local Hörmann dealer to receive an individual consultation.

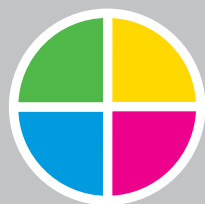

Please note:

All colours based on RAL.

The colours and surfaces shown are subject to the limitations of the printing process and cannot be regarded as binding. Please seek the expert advice of your Hörmann specialist dealer.

Matt, silk-gloss and high-gloss surfaces



- 1 RAL 9016 Traffic white, high-gloss
- 2 RAL 9006 White aluminium, silk-gloss
- 3 RAL 8028 Terra brown, matt
- 4 RAL 7040 Window grey, matt
- 5 RAL 7035 Light grey, matt ■ **NEW**
- 6 RAL 7030 Stone grey, matt
- 7 RAL 7016 Anthracite grey, matt
- 8 RAL 7015 Slate grey, matt
- 9 RAL 6009 Fir green, matt
- 10 RAL 6005 Moss green, matt
- 11 RAL 3003 Ruby red, matt

Textured surfaces

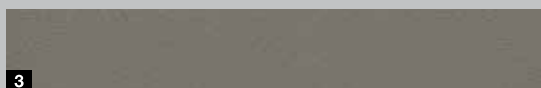
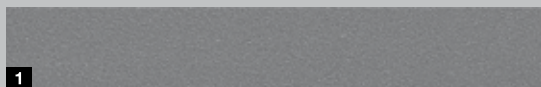

- 1 RAL 9007 Grey aluminium, fine structure matt
- 2 RAL 9001 Cream, fine structure matt
- 3 RAL 7039 Quartz grey, fine structure matt
- 4 RAL 7030 Stone grey, fine structure matt
- 5 RAL 7016 Anthracite grey, fine structure matt
- 6 RAL 7015 Slate grey, fine structure matt
- 7 Hörmann colour CH 703 Anthracite, fine structure matt
- 8 Hörmann colour CH 607 Chestnut, fine structure matt

Design your door colour exactly as you wish, inside and outside

Exterior and interior white

All Hörmann entrance doors in standard Traffic white, RAL 9016, are matt powder-coated on the inside and outside.

Exterior coloured, interior white

The Hörmann entrance doors in 18 preferred colours (see left) are powder-coated in the preferred colour on the exterior and in matt Traffic white RAL 9016 on the interior as standard.

Exterior and interior in a colour of your choice

On request you can have your new entrance door colour-coated on both sides; different combinations are also possible, e.g. Ruby red on the exterior and Slate grey on the interior.

Premium down to the last detail

1 Concealed hinges

The hinges of the ThermoCarbon entrance door are concealed between the door frame and leaf, i.e. they are not visible either from inside or outside: a visually elegant solution for your home. The door leaves can be simply and easily adjusted. This way, you can close your entrance door comfortably and securely at all times.

2 Tamper-proof profile cylinder

The tamper-proof profile cylinder, certified in accordance with DIN 18252/DIN EN 1303, features premium fittings: an anti-picking system, drill protection and an emergency and hazard function. This means that the door lock can still be operated when a key is inserted on the inside. 5 reversible keys are delivered with the door.

Flush-mounted security rose escutcheon on exterior

The stainless steel security rose escutcheon fits into the door leaf particularly elegantly, and also protects the profile cylinder against being drilled open.

3 Stainless steel interior lever

The elegant Caro stainless steel interior lever is standard for ThermoCarbon entrance doors.

4 Continuous stainless steel closing strip

The high-quality stainless steel closing strip is elegantly integrated into the door frame. This enables optimum adjustment of the door and allows for secure locking at all times.



5 9-point security lock H9 and concealed hinges that cannot be forced open

The ThermoCarbon comes with 9-point security. When locking, 5 steel swing bolts and 4 bolt locks pivot into the stainless steel lock plates. This top security protects your door with just one turn of a key. Doors in XXL version are supplied with the automatic lock S7 with 7-point locking.

Optional: break-in-resistant RC 4 security equipment

The ThermoCarbon entrance doors quipped with RC 3 as standard are optionally available with excellent RC 4 security equipment for improved security. For further information, please see page 15.

Flush-fitting exterior handles for exclusive door designs

6 Stainless steel handle with recessed grip

Doors with a stainless steel handle come as standard with a recessed grip in the colour of the door.

7 Continuous aluminium handle bar

As standard, the complete handle bar is supplied in White aluminium, RAL 9006, silk-gloss, with a recessed grip in the colour of the door.

8 Aluminium handle bar with recessed grip

As standard, this handle bar comes in White aluminium, RAL 9006, silk-gloss, with a recessed grip in the colour of the door.

Custom handle colours

All flush-fitting exterior handles (except for stainless steel handles) are also available in several colour variants. For further information, please see page 84.





The perfect balance between comfort and security

Our ThermoSafe entrance door will convince you with its security and thermal insulation. Thanks to the solid 73-mm-thick aluminium door leaf with PU rigid foam infill and an aluminium leaf profile with thermal break on the inside, ThermoSafe entrance doors feature a U_D -value up to approx. 0.87 W/(m²·K). The standard RC 3 security equipment with 5-point security lock gives you a comforting feeling of safety when you go to bed at night.

The appearance of the ThermoSafe also leaves nothing to be desired. With over 70 door designs, from classic to modern, in 18 preferred colours, you are sure to find the door of your dreams. With optional equipment such as handles, glazings or innovative door operators, you can customise your door even further.



Design

- 1 Solid 73 mm aluminium door leaf with PU rigid foam infill and internal leaf profile
- 2 Aluminium leaf profile with thermal break
- 3 80 mm aluminium door frame with thermal break
- 4 Triple sealing with an all-round seal

Fulfils all requirements of the energy saving regulation

Suitable for fitting without thermal bridges

U_D -value up to approx. $0.87 \text{ W}/(\text{m}^2\cdot\text{K})$

Equipment

- 5 Solid door view from the inside, same as room doors
- 6 3-way adjustable hinges
- 7 Aluminium interior lever
- 8 Tamper-proof profile cylinder
- 9 **RC 3 security equipment** with 5-point security lock
- 10 Security bolts

U_D -value of up to approx. **0.87**
 $\text{W}/(\text{m}^2\cdot\text{K})$

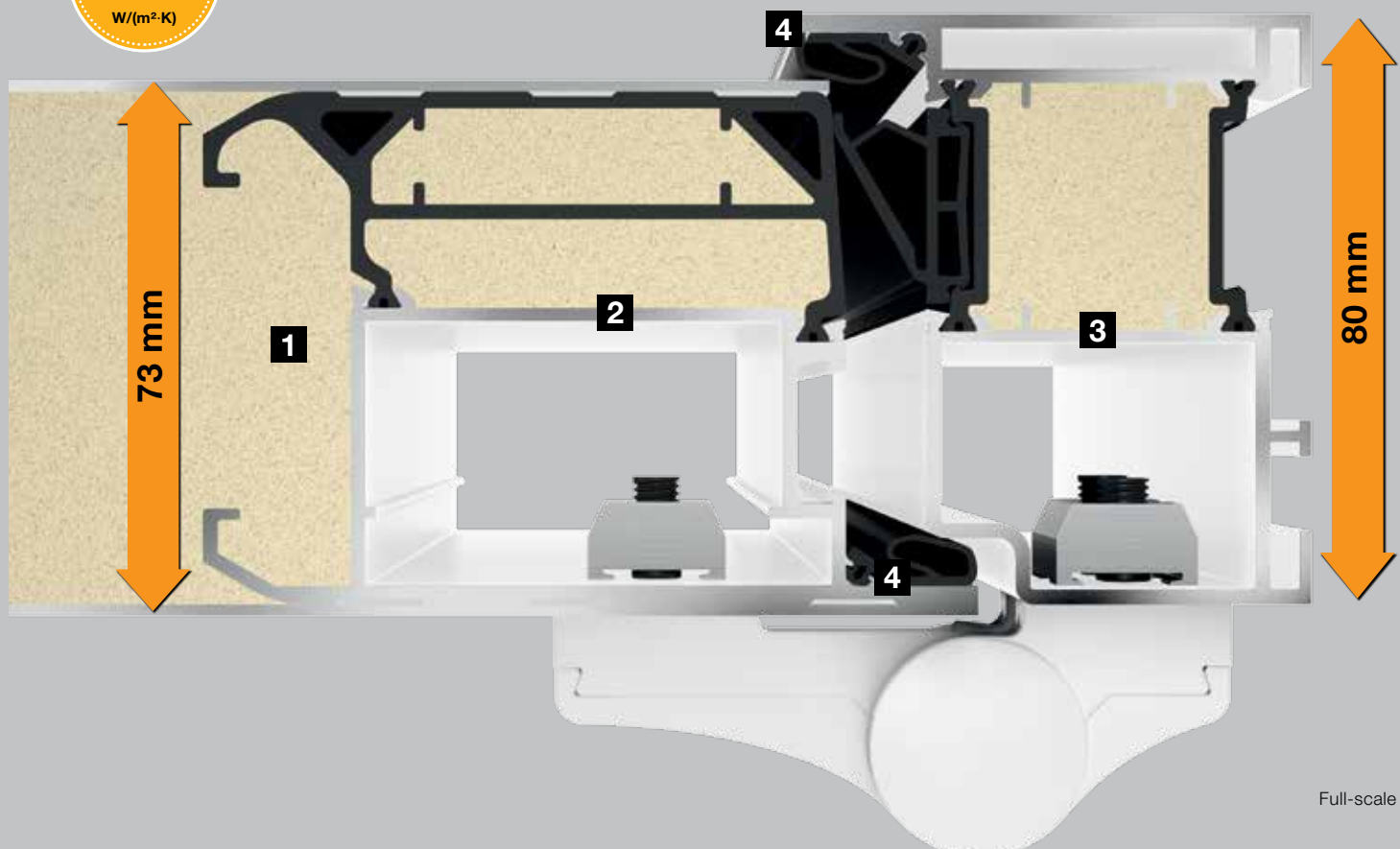

Interior view





Style 40
Stainless steel handle HOE 550, exterior design glass, laminated safety glass partially matt, in the top section with stripes, centre clear float with partially matt stripes offset from the exterior pane, triple thermal insulation glass, U_D -value up to approx. $1.1 \text{ W}/(\text{m}^2\cdot\text{K})^*$



Style 45
Stainless steel handle HOE 200, stainless steel embellishment, matt Parsol grey design glass (single-pane safety glass) with 4 clear stripes, triple thermal insulation glass, U_D -value up to approx. $0.9 \text{ W}/(\text{m}^2\cdot\text{K})^*$



Style 65
Stainless steel handle HOE 600, stainless steel embellishment, matt float design glass with 7 clear stripes, triple thermal insulation glass, U_D -value up to approx. $0.9 \text{ W}/(\text{m}^2\cdot\text{K})^*$



Style 75
Stainless steel handle 38-1, stainless steel embellishment, ornamental glass Mastercarré, triple thermal insulation glass, U_D -value up to approx. $0.9 \text{ W}/(\text{m}^2\cdot\text{K})^*$



Style 110
Stainless steel handle 38-1, Pave white ornamental glass, triple thermal insulation glass, U_D -value up to approx. $0.9 \text{ W}/(\text{m}^2\cdot\text{K})^*$



Style 136
Stainless steel handle 38-1, Satinato design glass with 7 matt stripes, triple thermal insulation glass, U_D -value up to approx. $1.1 \text{ W}/(\text{m}^2\cdot\text{K})^*$



Style 140

Stainless steel handle 38-1, stainless steel embellishment, Pave white ornamental glass, triple thermal insulation glass, U_D -value up to approx. $0.9 \text{ W}/(\text{m}^2\cdot\text{K})^*$



Style 166

Stainless steel handle 38-1, stainless steel embellishment, Satinato design glass with 7 matt stripes, triple thermal insulation glass, U_D -value up to approx. $1.1 \text{ W}/(\text{m}^2\cdot\text{K})^*$



Style 173

Stainless steel handle HOE 300, stainless steel embellishment, Pave white ornamental glass, triple thermal insulation glass, U_D -value up to approx. $0.9 \text{ W}/(\text{m}^2\cdot\text{K})^*$



Style 176

Stainless steel handle HOE 735, Satinato ornamental glass, triple thermal insulation glass, U_D -value up to approx. $0.9 \text{ W}/(\text{m}^2\cdot\text{K})^*$



Style 177

Stainless steel handle HOE 700, Pave white ornamental glass, triple thermal insulation glass, U_D -value up to approx. $0.9 \text{ W}/(\text{m}^2\cdot\text{K})^*$



Style 185

Stainless steel handle 38-2, ornamental glass Mastercarré white, triple thermal insulation glass, U_D -value up to approx. $0.9 \text{ W}/(\text{m}^2\cdot\text{K})^*$



Style 188
Stainless steel handle HOE 100, stainless steel embellishment, matt Stopsol grey design glass (single-pane safety glass) with 3 clear stripes, triple thermal insulation glass, U_D -value up to approx. $0.9 \text{ W}/(\text{m}^2\text{-K})^*$



Style 189
Stainless steel handle HOE 615, matt float design glass with 7 clear stripes, triple thermal insulation glass, U_D -value up to approx. $0.9 \text{ W}/(\text{m}^2\text{-K})^*$



Style 402
Stainless steel handle 14-2, Reflo design glass, partially matt with genuine fluted glass, triple thermal insulation glass, U_D -value up to approx. $0.9 \text{ W}/(\text{m}^2\text{-K})^*$



Style 413
Stainless steel handle 14-2, Silk ornamental glass, triple thermal insulation glass, U_D -value up to approx. $0.9 \text{ W}/(\text{m}^2\text{-K})^*$



Style 449
Stainless steel handle 38-1, Reflo design glass with genuine fluted glass squares, triple thermal insulation glass, U_D -value up to approx. $1.0 \text{ W}/(\text{m}^2\text{-K})^*$



Style 501
Stainless steel handle HOE 500, Satinato ornamental glass, triple thermal insulation glass, U_D -value up to approx. $0.9 \text{ W}/(\text{m}^2\text{-K})^*$



▲ ThermoSafe style 189 in preferred Hörmann colour CH 703 Anthracite, fine structure matt, with side elements



Style 502
Stainless steel handle HOE 500, Satinato ornamental glass, triple thermal insulation glass, U_D -value up to approx. $0.9 \text{ W}/(\text{m}^2\cdot\text{K})^*$



Style 503
Stainless steel handle HOE 500, matt float design glass with 7 clear horizontal stripes, triple thermal insulation glass, U_D -value up to approx. $0.9 \text{ W}/(\text{m}^2\cdot\text{K})^*$



Style 504
Stainless steel handle HOE 500, matt float design glass with 5 clear horizontal stripes, triple thermal insulation glass, U_D -value up to approx. $0.9 \text{ W}/(\text{m}^2\cdot\text{K})^*$



Style 505
Stainless steel handle HOE 500, matt float design glass with 4 clear stripes, triple thermal insulation glass, U_D -value up to approx. $0.9 \text{ W}/(\text{m}^2\cdot\text{K})^*$



Style 514
Design handle G 750 in White aluminium RAL 9006, silk-gloss, embellishment in White aluminium RAL 9006, silk-gloss, clear float ornamental glass, triple thermal insulation glass, U_D -value up to approx. $0.9 \text{ W}/(\text{m}^2\cdot\text{K})^*$



Style 515
Design handle G 710 in White aluminium RAL 9006, silk-gloss, clear float ornamental glass, triple thermal insulation glass, U_D -value up to approx. $0.9 \text{ W}/(\text{m}^2\cdot\text{K})^*$



Style 524

Design handle G 750 in White aluminium RAL 9006, silk-gloss, embellishment in White aluminium RAL 9006, silk-gloss, clear float ornamental glass, triple thermal insulation glass, U_D -value up to approx. $0.9 \text{ W}/(\text{m}^2\cdot\text{K})^*$



Style 525

Design handle G 750 in White aluminium RAL 9006, silk-gloss, clear float ornamental glass, triple thermal insulation glass, U_D -value up to approx. $0.9 \text{ W}/(\text{m}^2\cdot\text{K})^*$



Style 551

Stainless steel handle HOE 150, U_D -value up to approx. $0.87 \text{ W}/(\text{m}^2\cdot\text{K})^*$



Style 552

Stainless steel handle HOE 150, stainless steel embellishment, matt float design glass with clear stripes and red coloured plastic film, triple thermal insulation glass, U_D -value up to approx. $0.9 \text{ W}/(\text{m}^2\cdot\text{K})^*$



Style 553

Aluminium handle 753 in silver, matt Reflo design glass with genuine fluted glass, triple thermal insulation glass, U_D -value up to approx. $0.9 \text{ W}/(\text{m}^2\cdot\text{K})^*$



Style 554

Stainless steel handle HOE 730, stainless steel embellishment, ornamental glass 553, triple thermal insulation glass, U_D -value up to approx. $0.9 \text{ W}/(\text{m}^2\cdot\text{K})^*$



Style 555
Stainless steel handle HOE 910, stainless steel embellishment, Reflo design glass with sand-blasted design, triple thermal insulation glass, U_D -value up to approx. $0.9 \text{ W}/(\text{m}^2\cdot\text{K})^*$



Style 556
Stainless steel handle HOE 550, U_D -value up to approx. $0.87 \text{ W}/(\text{m}^2\cdot\text{K})^*$



Style 557
Stainless steel handle HOE 600, U_D -value up to approx. $0.87 \text{ W}/(\text{m}^2\cdot\text{K})^*$



Style 558
Stainless steel handle HOE 910, stainless steel embellishment, Reflo design glass with genuine horizontal fluted glass, interior matt laminated safety glass, U_D -value up to approx. $1.1 \text{ W}/(\text{m}^2\cdot\text{K})^*$



Style 559
Stainless steel handle HOE 200, stainless steel embellishment, exterior clear matt laminated safety glass with 11 clear stripes, centre Satinato, interior clear laminated safety glass, triple thermal insulation glass, U_D -value up to approx. $0.9 \text{ W}/(\text{m}^2\cdot\text{K})^*$



Style 560
Stainless steel handle HOE 600, stainless steel embellishment, matt design glass with 11 clear stripes, triple thermal insulation glass, U_D -value up to approx. $0.9 \text{ W}/(\text{m}^2\cdot\text{K})^*$



Style 565

DesignPlus handle G 760, handle embellishment in anodised aluminium E6 / EV 1, U_D -value up to approx. $0.87 \text{ W}/(\text{m}^2\cdot\text{K})^*$



Style 568

Design handle G 750 in anodised aluminium E6 / EV 1, U_D -value up to approx. $0.87 \text{ W}/(\text{m}^2\cdot\text{K})^*$



Style 581

Stainless steel handle HOE 600, stainless steel embellishment, matt float design glass with clear stripes and a red colour stripe, U_D -value up to approx. $0.9 \text{ W}/(\text{m}^2\cdot\text{K})^*$



Style 583

Aluminium handle G 755 in anodised aluminium E6 / EV 1, matt Reflo design glass with clear edge, triple thermal insulation glass, U_D -value up to approx. $0.9 \text{ W}/(\text{m}^2\cdot\text{K})^*$



Style 585

Stainless steel handle HOE 950, aluminium embellishment, U_D -value up to approx. $0.87 \text{ W}/(\text{m}^2\cdot\text{K})^*$



Style 590

Design handle G 750 in anodised aluminium E6 / EV 1, Reflo design glass with sand-blasted design and genuine fluted glass, triple thermal insulation glass, U_D -value up to approx. $0.9 \text{ W}/(\text{m}^2\cdot\text{K})^*$





Style 596

Stainless steel handle HOE 735, Satinato ornamental glass, triple thermal insulation glass, U_D -value up to approx. $0.9 \text{ W}/(\text{m}^2\cdot\text{K})^*$



Style 650

Stainless steel handle HOE 700, Pave white ornamental glass, triple thermal insulation glass, U_D -value up to approx. $0.9 \text{ W}/(\text{m}^2\cdot\text{K})^*$



Style 659

Stainless steel handle 38-2, stainless steel embellishment, matt Parsol grey design glass (single-pane safety glass) with 7 clear stripes, triple thermal insulation glass, U_D -value up to approx. $0.9 \text{ W}/(\text{m}^2\cdot\text{K})^*$



Style 667

Stainless steel handle HOE 910, matt Parsol grey design glass (single-pane safety glass) with 7 clear stripes, triple thermal insulation glass, U_D -value up to approx. $0.9 \text{ W}/(\text{m}^2\cdot\text{K})^*$



Style 675

Stainless steel handle 38-1, Reflo design glass with genuine fluted glass, triple thermal insulation glass, U_D -value up to approx. $1.0 \text{ W}/(\text{m}^2\cdot\text{K})^*$



Style 680

Stainless steel handle HOE 700, stainless steel embellishments, Pave white ornamental glass, triple thermal insulation glass, U_D -value up to approx. $0.9 \text{ W}/(\text{m}^2\cdot\text{K})^*$

◀ **ThermoSafe style 568** in preferred Hörmann colour CH 703 Anthracite, textured, with side element

* Dependent on door size. Specified values for RAM 1230 × 2180 mm.



Style 686
Stainless steel handle HOE 600, stainless steel embellishment, matt float design glass with 7 clear stripes, triple thermal insulation glass, U_D -value up to approx. $0.9 \text{ W}/(\text{m}^2\cdot\text{K})^*$



Style 689
Stainless steel handle 38-2, matt Parsol grey design glass (single-pane safety glass) with 7 clear stripes, triple thermal insulation glass, U_D -value up to approx. $0.9 \text{ W}/(\text{m}^2\cdot\text{K})^*$



Style 693
Stainless steel handle HOE 300, U_D -value up to approx. $0.87 \text{ W}/(\text{m}^2\cdot\text{K})^*$



Style 694
Stainless steel handle HOE 700, Reflo design glass with genuine fluted glass, triple thermal insulation glass, U_D -value up to approx. $1.0 \text{ W}/(\text{m}^2\cdot\text{K})^*$



Style 697
Stainless steel handle HOE 910, stainless steel embellishments, matt Parsol grey design glass (single-pane safety glass) with 7 clear stripes, triple thermal insulation glass, U_D -value up to approx. $0.9 \text{ W}/(\text{m}^2\cdot\text{K})^*$



Style 723 ■ NEW
Handle profile in White aluminium RAL 9006, fixing profiles in door colour, clear float ornamental glass, triple thermal insulation glass, U_D -value up to approx. $0.87 \text{ W}/(\text{m}^2\cdot\text{K})^*$



Style 757

Stainless steel handle HOE 797, matt float design glass with clear stripes, triple thermal insulation glass, U_D -value up to approx. $0.9 \text{ W}/(\text{m}^2\cdot\text{K})^*$



Style 759

Design handle G 750 in anodised aluminium E6 / EV 1, matt float design glass with clear stripes, triple thermal insulation glass, U_D -value up to approx. $0.9 \text{ W}/(\text{m}^2\cdot\text{K})^*$



Style 762

Stainless steel handle HOE 735, flush-fitting aluminium embellishments, U_D -value up to approx. $0.87 \text{ W}/(\text{m}^2\cdot\text{K})^*$



Style 771

Stainless steel handle HOE 735, flush-fitting aluminium embellishments, U_D -value up to approx. $0.87 \text{ W}/(\text{m}^2\cdot\text{K})^*$



Style 777

Stainless steel handle HOE 610, matt float ornamental glass, triple thermal insulation glass, U_D -value up to approx. $0.9 \text{ W}/(\text{m}^2\cdot\text{K})^*$



Style 779

Design handle G 750 in anodised aluminium E6 / EV 1, matt float ornamental glass, triple thermal insulation glass, U_D -value up to approx. $0.9 \text{ W}/(\text{m}^2\cdot\text{K})^*$



Style 797
Stainless steel handle HOE 797, matt float ornamental glass, triple thermal insulation glass, U_D -value up to approx. $0.9 \text{ W}/(\text{m}^2\cdot\text{K})^*$



Style 799
Design handle G 750 in anodised aluminium E6 / EV 1, matt float ornamental glass, triple thermal insulation glass, U_D -value up to $0.9 \text{ W}/(\text{m}^2\cdot\text{K})^*$



Style 823 ■ NEW
Handle profile in White aluminium RAL 9006, fixing profiles in door colour, fascia frame with 3D effect and closing using handle profile, optionally with LED Spotlight in the handle, U_D -value up to approx. $0.87 \text{ W}/(\text{m}^2\cdot\text{K})^*$



Style 823 ■ NEW
Handle profile in White aluminium RAL 9006, fixing profiles in door colour, optionally with LED Spotlight in the handle, U_D -value up to approx. $0.87 \text{ W}/(\text{m}^2\cdot\text{K})^*$



Style 832 ■ NEW
Stainless steel handle HOE 820, embellishment in Slate grey RAL 7015, with horizontal and vertical stainless steel pilaster strips, U_D -value up to approx. $0.87 \text{ W}/(\text{m}^2\cdot\text{K})^*$



Style 836 ■ NEW
Stainless steel handle HOE 820, flush-fitting embellishment in Slate grey RAL 7015, U_D -value up to approx. $0.87 \text{ W}/(\text{m}^2\cdot\text{K})^*$



Style 860
Stainless steel handle HOE 700,
 U_D -value up to approx. $0.87 \text{ W}/(\text{m}^2\cdot\text{K})^*$



Style 861
Stainless steel handle HOE 700,
 U_D -value up to approx. $0.87 \text{ W}/(\text{m}^2\cdot\text{K})^*$



Style 862
Stainless steel handle HOE 620,
 U_D -value up to approx. $0.87 \text{ W}/(\text{m}^2\cdot\text{K})^*$



Style 867
Stainless steel handle HOE 620, matt float
design glass with 7 clear stripes, triple
thermal insulation glass, U_D -value up to
approx. $0.9 \text{ W}/(\text{m}^2\cdot\text{K})^*$



Style 871
Stainless steel handle HOE 620,
 U_D -value up to approx. $0.87 \text{ W}/(\text{m}^2\cdot\text{K})^*$



Style 872
Stainless steel handle HOE 620,
 U_D -value up to approx. $0.87 \text{ W}/(\text{m}^2\cdot\text{K})^*$



Style 877

Stainless steel handle HOE 610, matt float design glass with 3 clear stripes, triple thermal insulation glass, U_D -value up to approx. $0.9 \text{ W}/(\text{m}^2\cdot\text{K})^*$



Style 878

Stainless steel handle HOE 740, flush-fitting stainless steel embellishment, U_D -value up to approx. $0.87 \text{ W}/(\text{m}^2\cdot\text{K})^*$



Style 879

Design handle G 750 in anodised aluminium E6 / EV 1, matt float design glass with 3 clear stripes, U_D -value up to approx. $0.9 \text{ W}/(\text{m}^2\cdot\text{K})^*$





▲ **ThermoSafe style 693** in preferred colour Anthracite grey RAL 7016, matt, with side element, L-ribbed sectional garage door Silkgrain in Anthracite grey RAL 7016



Entrance door and garage door perfectly match each other

The large matching Hörmann programme provides you with aligned entrance door and garage door ribbing options for a matching appearance. The result: No optical offset from the base line. You will see: the beauty of your home is reflected in these small but crucial details.



Perfectly matched: entrance door styles and sectional garage doors, M or L-ribbed



ThermoSafe entrance doors:

- Style 825
- Style 845
- Style 855



Sectional garage doors, M-ribbed:

- with a door height of 2000 mm
- with a door height of 2125 mm
- with a door height of 2250 mm



ThermoSafe entrance doors:

- Style 875
- Style 895
- Style 898

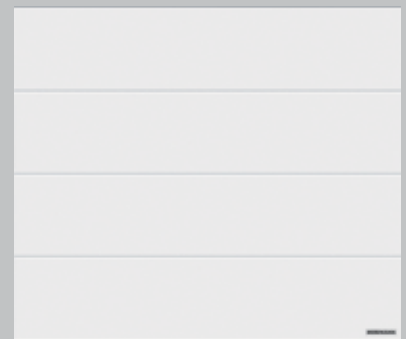

Sectional garage doors, L-ribbed:

- with a door height of 2000 mm
- with a door height of 2125 mm
- with a door height of 2250 mm



▲ ThermoSafe style 895 in the preferred colour Anthracite RAL 7016, matt, L-ribbed sectional garage door in Silkgrain, Anthracite RAL 7016

Matched entrance and garage doors

The cross-section of the entrance and garage door clearly shows the ribbed look of the entrance door is a result of the grooves in the infill. In the garage door, it comes from the ribbing of the individual sections and the section transitions.

After exact on-site measurement, your Hörmann specialist dealer will offer expert advice in choosing the perfect overall look from these entrance door styles.



ThermoSafe entrance door cross-section

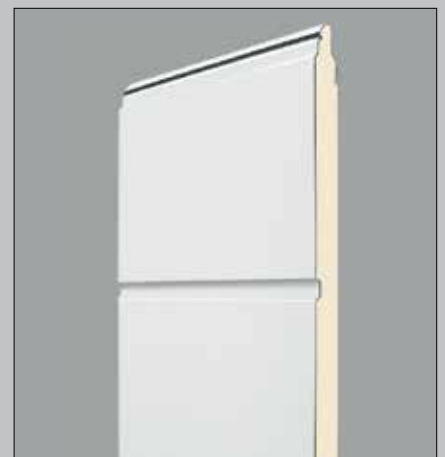

Sectional garage door cross-section

Find your favourite colour

At Hörmann, we value individuality and variety. That's why we offer entrance doors in the colour of your choice as a matter of course. For example, you can select your favourite colour from the inexpensive matt Traffic white RAL 9016 and 18 additional preferred colours. Of course, you can also select from over 200 further RAL colours and many neon and pearl-effect colours on request. Your Hörmann dealer is happy to assist you.



Please note:

All colours based on RAL.

The colours and surfaces shown are subject to the limitations of the printing process and cannot be regarded as binding. Please seek the expert advice of your Hörmann specialist dealer.

Matt, silk-gloss and high-gloss surfaces



- | | | |
|----|----------|-------------------------------|
| 1 | RAL 9016 | Traffic white, high-gloss |
| 2 | RAL 9006 | White aluminium, silk-gloss |
| 3 | RAL 8028 | Terra brown, matt |
| 4 | RAL 7040 | Window grey, matt |
| 5 | RAL 7035 | Light grey, matt ■ NEW |
| 6 | RAL 7030 | Stone grey, matt |
| 7 | RAL 7016 | Anthracite grey, matt |
| 8 | RAL 7015 | Slate grey, matt |
| 9 | RAL 6009 | Fir green, matt |
| 10 | RAL 6005 | Moss green, matt |
| 11 | RAL 3003 | Ruby red, matt |

Textured surfaces

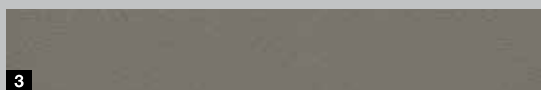
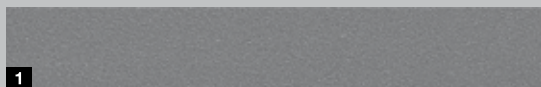

- 1 RAL 9007 Grey aluminium, fine structure matt
- 2 RAL 9001 Cream, fine structure matt
- 3 RAL 7039 Quartz grey, fine structure matt
- 4 RAL 7030 Stone grey, fine structure matt
- 5 RAL 7016 Anthracite grey, fine structure matt
- 6 RAL 7015 Slate grey, fine structure matt
- 7 Hörmann colour CH 703 Anthracite, fine structure matt
- 8 Hörmann colour CH 607 Chestnut, fine structure matt

Design your door colour exactly as you wish, inside and outside

Exterior and interior white

All Hörmann entrance doors in standard Traffic white, RAL 9016, are matt powder-coated on the inside and outside.

Exterior coloured, interior white

The Hörmann entrance doors in 18 preferred colours (see left) are powder-coated in the preferred colour on the exterior and in matt Traffic white RAL 9016 on the interior as standard.

Exterior and interior in a colour of your choice

On request you can have your new entrance door colour-coated on both sides; different combinations are also possible, e.g. Ruby red on the exterior and Slate grey on the interior.

High quality all-round

1 3-way adjustable hinges

The beautifully designed three-way hinges allow the ThermoSafe entrance door to be variably adjusted. This way, your entrance door is optimally sealed and falls smoothly and securely into its lock.

Optional concealed hinges (not shown)

Concealed hinges make for an elegant door appearance on the interior. The hinges are leverage-proof so that the security bolts on the hinge side can be omitted.

2 Tamper-proof profile cylinder

The profile cylinder is equipped with an anti-picking system and drill protection. In addition, it offers an emergency and hazard function, i.e. the door lock can still be operated when a key is inserted on the inside. The tamper-proof locking cylinder is certified according to DIN 18252 / DIN EN 1303 and is delivered with 5 reversible keys.

Exterior surface-mounted security rose escutcheon

The patented exterior rose escutcheon also protects the profile cylinder against being drilled open and twisted off. Delivered as standard in Traffic white RAL 9016, or in stainless steel for coloured doors.

3 Aluminium interior lever

ThermoSafe entrance doors are equipped as standard with the attractive Rondo interior lever, stove-enamelled in white. Optionally, it is also available in stainless steel or your choice of RAL as well as the versions Caro or Okto, also in stainless steel.

4 Stainless steel lock plates

The lock plates ensure a convenient adjustment of the door, so that your door falls shut optimally and can be closed securely.



As standard

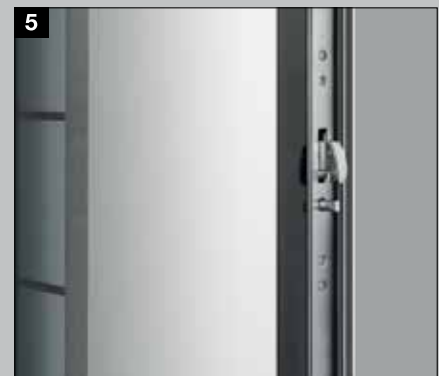
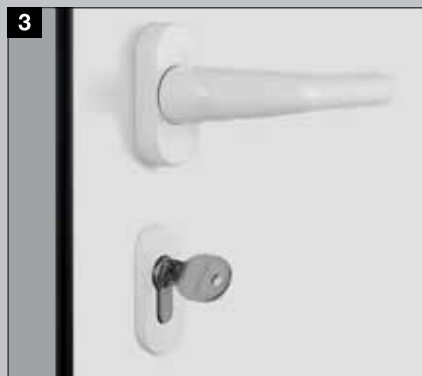

5 5-point security lock H5 and security bolts on the hinge side

When locking, 3 steel swing bolts with 2 additional bolt locks pivot into the stainless steel lock plates. The swing bolts make it more difficult for the door to be pulled apart or forced open (S5 Automatic for oversizes).

6 Electronic spyhole ■ NEW
(optional)

Your entrance area is monitored with a wide angle camera. The spyhole is ideal for small children and persons who depend on a wheelchair.

Integrated overhead door closer ■ NEW
(optional, not shown)

The integrated overhead door closer closes the door and gives your door an elegant interior view – especially in combination with concealed hinges.

Opening limiter ■ NEW
(optional, not shown)

The high-quality opening limiter in the metal version restricts the door opening to an opening angle of 105°. It is individually adjustable and features the convenient soft stop function.

Retractable bottom seal ■ NEW
(optional, not shown)

This optional equipment is the best solution for sealing ThermoSafe entrance doors without threshold rail used for barrier-free entrances.



Optional frame variants for an individual look

7 Broader door frames

On request, door frames are also available in a width of 110 mm, for a more convenient and attractive connection to full thermal insulation, for example.

8 Fascia frame Rondo 70

The rounded frame profile adds a stylish touch to your entrance door, providing it with a particularly harmonious look with its rounded edges.

9 Fascia frame Caro 70

This version has an attractive and distinguished look that upgrades the appearance of your door through the frame's depth effect.





The entrance door that makes you feel welcome

The Thermo65 offers you everything that makes for an excellent entrance door. The solid 65-mm-thick steel door leaf with PU rigid foam infill and the leaf profile on the inside made of composite material as well as the aluminium frame with thermal break keep the cold out. With a U_D -value up to approx. $0.87 \text{ W}/(\text{m}^2 \cdot \text{K})$, Thermo65 doors feature good thermal insulation. As standard, the doors are equipped with a 5-point security lock, allowing you to feel safe and secure in your home. Most Thermo65 styles are optionally available with RC 2 safety equipment to make you feel even more secure in your own four walls.

Choose your favourite of 14 attractive styles and customise it with one of our 16 preferred colours and 5 Decograin decors.



Design

- 1** Solid, 65-mm-thick steel door leaf with leaf profile on the inside and thick rebate
- 2** Thermal break and higher stability through the leaf profile made of composite material
- 3** 80 mm aluminium frame with thermal break
- 4** Triple sealing

Fulfils all requirements of the energy saving regulation

Suitable for fitting without thermal bridges

U_D -value up to approx. $0.87 \text{ W}/(\text{m}^2\cdot\text{K})$

Equipment

- 5** Solid door view from the inside, same as room doors
- 6** 3-way adjustable guide rollers
- 7** Stainless steel interior lever
- 8** Profile cylinder with emergency and hazard function
- 9** 5-point security lock

Optional RC 2 safety equipment

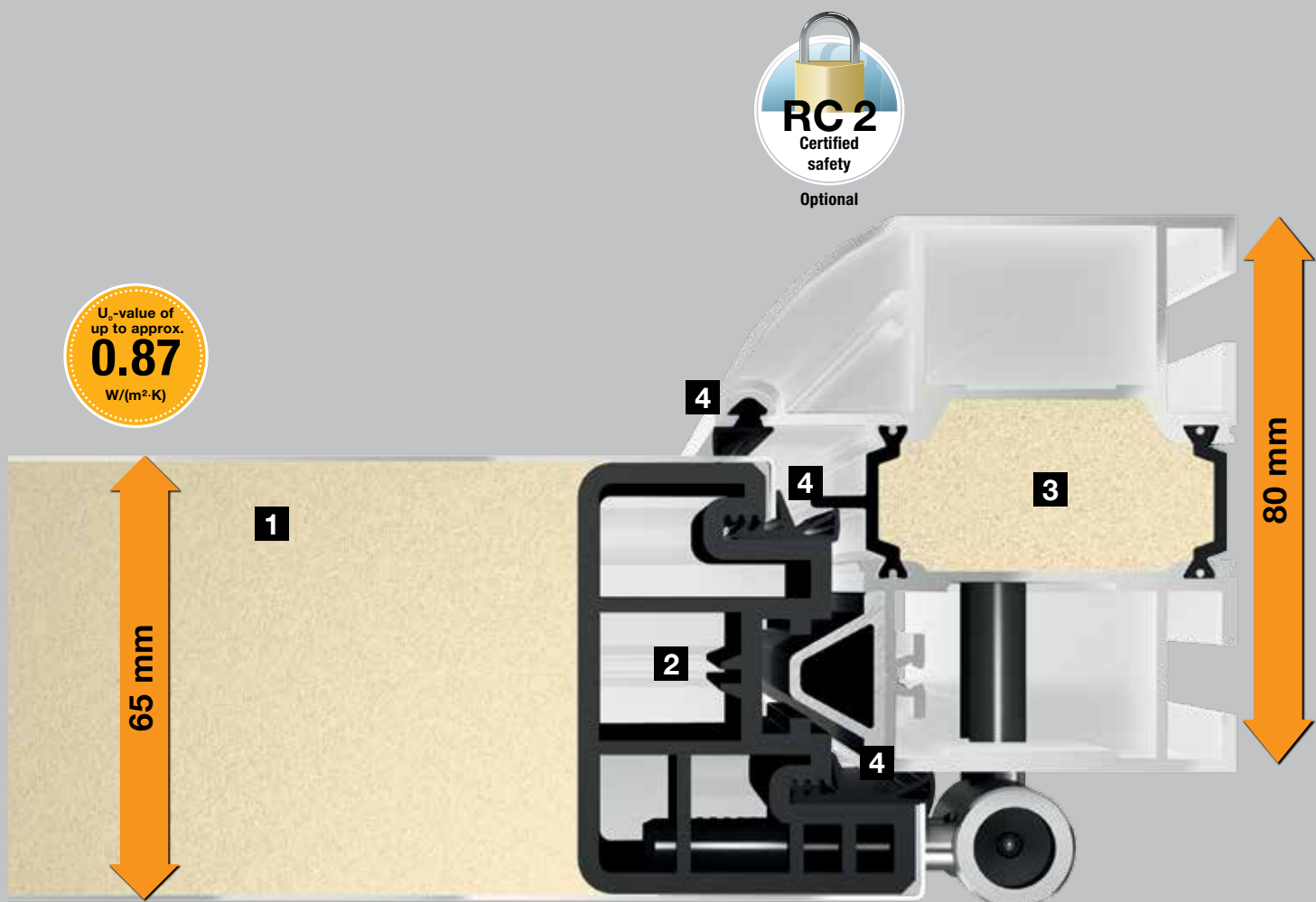

Interior view







Style 100
Stainless steel handle HB 14-2 on steel infill, with 6 panels, U_D -value up to approx. $0.87 \text{ W}/(\text{m}^2\cdot\text{K})^*$



Style 410
Stainless steel handle HB 14-2 on steel infill, triple-pane insulated glass, exterior laminated safety glass, centre sand-blasted float, interior clear laminated safety glass, U_D -value up to approx. $1.0 \text{ W}/(\text{m}^2\cdot\text{K})^*$



Style 430
Stainless steel handle HB 14-2 on steel infill, triple-pane insulated glass, exterior laminated safety glass, centre sand-blasted float with clear stripes, interior clear laminated safety glass, U_D -value up to approx. $1.0 \text{ W}/(\text{m}^2\cdot\text{K})^*$



Style 450
Stainless steel handle HB 14-2 on steel infill, triple-pane insulated glass, exterior laminated safety glass, centre sand-blasted float with clear stripes, interior clear laminated safety glass, U_D -value up to approx. $1.0 \text{ W}/(\text{m}^2\cdot\text{K})^*$



Style 010
Stainless steel handle HB 14-2 on steel infill, U_D -value up to approx. $0.87 \text{ W}/(\text{m}^2\cdot\text{K})^*$



Style 015
Stainless steel handle HB 14-2 on steel infill with 7 ribs, optionally with embellishments in stainless steel look, U_D -value up to approx. $0.87 \text{ W}/(\text{m}^2\cdot\text{K})^*$



Style 515
Stainless steel handle HB 14-2 on steel infill with 3 ribs, optionally with embellishments in stainless steel look, U_D -value up to approx. $0.87 \text{ W}/(\text{m}^2\cdot\text{K})^*$



Style 600 ■ NEW from 1.7.2017
Stainless steel handle HB 38-2 on steel infill, with surface-mounted glazing: triple-pane insulated glass, exterior laminated safety glass, centre sand-blasted float, interior clear single-pane safety glass



Style 700

Stainless steel handle HB 38-2 on steel infill, full glazing: triple-pane insulated glass, exterior laminated safety glass, centre sand-blasted float with clear stripes, interior clear single-pane safety glass, U_D -value up to approx. $0.98 \text{ W}/(\text{m}^2\cdot\text{K})^*$



Style 750

Stainless steel handle HB 38-2 on steel infill, full glazing: triple-pane insulated glass, exterior laminated safety glass, centre sand-blasted float with clear stripes, interior clear single-pane safety glass, U_D -value up to approx. $0.95 \text{ W}/(\text{m}^2\cdot\text{K})^*$



Style 800

Stainless steel handle HB 38-2 on steel infill, 4 rectangular glazings with stainless steel frame: triple-pane insulated glass, exterior laminated safety glass, centre sand-blasted float, interior clear laminated safety glass, U_D -value up to approx. $0.93 \text{ W}/(\text{m}^2\cdot\text{K})^*$



Style 810

Stainless steel handle HB 38-2 on steel infill, 3 rectangular glazings with clear all-round stripe and stainless steel frame: triple-pane insulated glass, exterior laminated safety glass, centre sand-blasted float, interior clear single-pane safety glass, U_D -value up to $0.99 \text{ W}/(\text{m}^2\cdot\text{K})^*$



Style 850

Stainless steel handle HB 38-2 on steel infill, with rounded glazing: triple-pane insulated glass, exterior laminated safety glass, centre sand-blasted float with clear stripes, interior clear laminated safety glass, U_D -value up to approx. $0.96 \text{ W}/(\text{m}^2\cdot\text{K})^*$



Style 900

Stainless steel handle HB 38-2 on steel infill, with rounded glazing: triple-pane insulated glass, exterior laminated safety glass, centre sand-blasted float with clear stripes, interior clear single-pane safety glass, U_D -value up to approx. $0.96 \text{ W}/(\text{m}^2\cdot\text{K})^*$

* Dependent on door size. Specified values for RAM 1230 × 2180 mm.

Find your favourite colour

Do you prefer a subtle Window grey or would you like to show your true colours with Ruby red? When choosing a colour for your new Hörmann entrance door, we let your creativity run wild.

Optionally you can order the door leaf and frame in different colours to fit your own individual taste. You can choose between the particularly inexpensive Traffic white RAL 9016 and 16 additional preferred colours. Simply contact your Hörmann dealer.

In low-cost Traffic white as standard



16 preferred colours

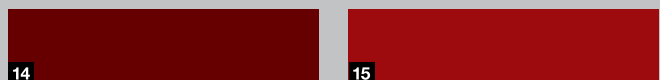
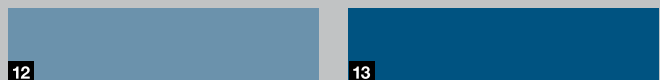

- | | | |
|----|----------|-----------------|
| 1 | RAL 9016 | Traffic white |
| 2 | RAL 9007 | Grey aluminium |
| 3 | RAL 9006 | White aluminium |
| 4 | RAL 9002 | Grey white |
| 5 | RAL 9001 | Cream |
| 6 | RAL 8028 | Terra brown |
| 7 | RAL 8003 | Clay brown |
| 8 | RAL 7040 | Window grey |
| 9 | RAL 7035 | Light grey |
| 10 | RAL 7016 | Anthracite grey |
| 11 | RAL 6005 | Moss green |
| 12 | RAL 5014 | Pigeon blue |
| 13 | RAL 5010 | Gentian blue |
| 14 | RAL 3004 | Purple red |
| 15 | RAL 3003 | Ruby red |
| 16 | RAL 3000 | Flame red |
| 17 | RAL 1015 | Light ivory |

Elegance and detailed accuracy

Decograin is available in four natural-looking timber designs and with an anthracite metallic effect. An embossed wood grain gives it an authentic timber character.

Optionally you can design the inside of your entrance door in Decograin Golden Oak, Dark Oak or Titan Metallic CH 703 to also match your internal doors. All door styles are available with rounded frames in the Decograin decors listed, on the inside in Traffic white RAL 9016 – on request with side elements in the same colour combination. This way, you can enjoy your perfectly matching entrance door and internal doors.

5 Decograin decors

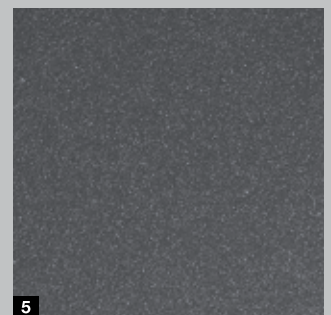
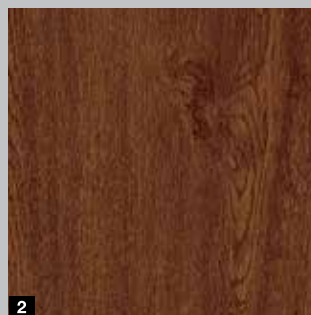

- 1 Decograin Golden Oak: medium brown, golden yellow oak design
- 2 Decograin Dark Oak: walnut-coloured oak decor
- 3 Decograin Night Oak: dark, intense oak design
- 4 Decograin Winchester Oak: natural-coloured knotty oak design
- 5 Titan Metallic CH 703: Anthracite with a metallic effect

Please note

The colours and surface finishes shown are subject to the limitations of the printing process and cannot be regarded as binding. Dark colours should not be used for doors that are exposed to the sun, as an increased material expansion may impair the door's function.

Harmony in every detail

1 Perfectly hung with 3-way adjustable guide rollers

Sturdy, two-part 3-way adjustable hinges with safety pins and stainless steel decorative covers guarantee smooth door function.

2 Securing the hinge side

Being able to rest easy in your own home is important. On the Thermo65 door, a continuous aluminium security strip additionally secures the hinge side, making forced opening of the door practically impossible.

3 Interior lever

Each door comes with a beautifully shaped stainless steel interior lever and rose escutcheon on the exterior as standard.

4 Profile cylinder

Delivered with 5 keys as standard. With emergency and hazard function, i.e. the door lock can still be operated when the key is inserted on the inside.

5 5-point security lock

You will feel safe at home: 2 conical swing bolts engage with 2 additional security bolts and 1 lock bolt in the frame's lock plates and pull the door tightly shut. The lock plate on Thermo65 doors is adjustable for an optimal door setting. With a soft-lock latch to quietly close the door. An automatic lock with mechanical self-locking is optionally available for the Thermo65.

When the door falls shut, the bolts automatically extend and securely lock the entrance door

Optional: break-in-resistant security equipment

Depending on your requirements, you can select this increased security for entrance doors, side elements and transom lights with RC 2 features. For further information, please see page 15.

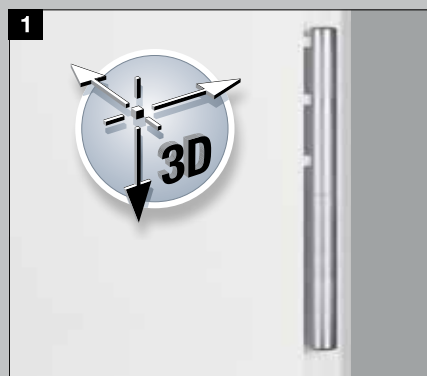

Automatic lock with mechanical self-locking ■ NEW from 1.7.2017

When the door falls shut, the bolts automatically extend and securely lock the entrance door

Automatic lock with electric motor

Open your entrance door easily and conveniently via multiple-point locking using a hand transmitter, radio finger-scan or transponder. There's no longer any danger of forgetting your keys.

6 Frame

The 80 mm aluminium frame with thermal break and PU foam infill is available in a round-style **6a** or rectangular profile **6b**.



7 Opening via a transponder

For opening via a transponder, the entrance door is equipped with an electromechanical profile cylinder. Hold the transponder in front of the cylinder to unlock and open your door using the knob.

8 Opening via a radio finger-scan or a hand transmitter

When operating the entrance door via a radio finger-scan or hand transmitter, it automatically unlocks via an electric motor. You can then push the door open.

Electric strike (optional, not shown)

With the electric strike catch, you can conveniently open your door via a switch inside the house. Alternatively, e.g. during the day, you can also toggle the locking lever so that the entrance door can be opened by a slight push from the outside.

Door drip (optional, not shown)

Attractive protection: The door drip in Traffic white RAL 9016 diverts driving rain and is easy to retrofit.

Retractable bottom seal (optional, not shown)

■ **NEW** This optional equipment is the best solution for sealing Thermo65 entrance doors without threshold rail used for barrier-free entrances.



Hand transmitter HSE 4 BS textured surface black with black plastic caps



Glass entrance doors for well-lit entrance areas

Our TopComfort glass entrance doors create a bright and cheerful entrance area with solid equipment. The doors are characterised by a 80-mm-thick aluminium door profile and 80 mm aluminium door frame with thermal break and feature good thermal insulation with a U_D -value up to $1.3 \text{ W}/(\text{m}^2 \cdot \text{K})$. The standard 5-point security lock provides the security you expect of an entrance door. This way, you can design an entrance area that is not only tasteful, but also secure.

You can choose between 9 exclusive glass door styles that let in a maximum of natural light. We can supply the frame in one of 18 preferred colours according to your taste. You can personalise the door of your choice with stylish exterior and interior handles and glazings.

Design

- 1 Aluminium leaf profile with thermal break
- 2 80 mm aluminium door frame with thermal break
- 3 Double sealing
- 4 Triple thermal insulation glass with 8 mm safety glass on interior and exterior

Fulfils all requirements of the energy saving regulation

Suitable for fitting without thermal bridges

U_D -value up to approx. $1.3 \text{ W}/(\text{m}^2\cdot\text{K})$



Equipment

- 5 Square glazing beads, with butt joints
- 6 3-way adjustable hinges
- 7 Aluminium interior lever
- 8 Tamper-proof profile cylinder
- 9 5-point security lock

Optional RC 2 safety equipment

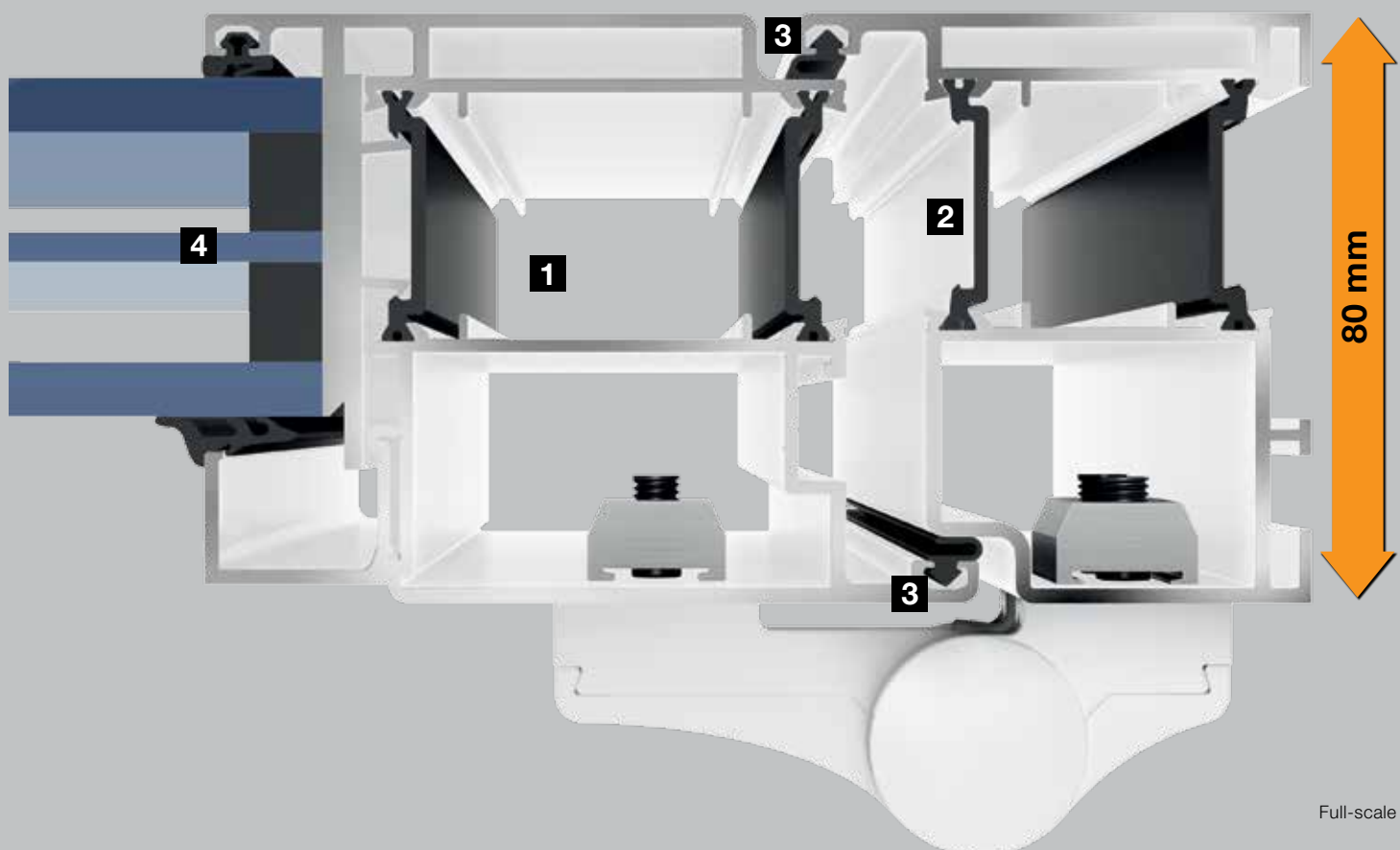

Interior view





Style 100
Stainless steel handle 38-1, Mastercarré ornamental glass, triple thermal insulation glass, U_D -value up to approx. $1.3 \text{ W}/(\text{m}^2\cdot\text{K})^*$



Style 101
Stainless steel handle 38-1, Mastercarré ornamental glass, triple thermal insulation glass, U_D -value up to approx. $1.3 \text{ W}/(\text{m}^2\cdot\text{K})^*$

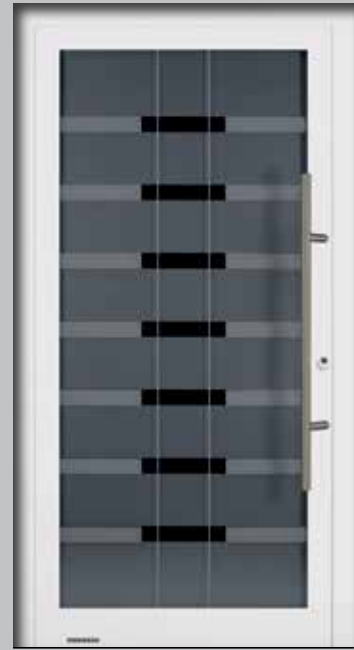

Style 100 / MG 111
Stainless steel handle 38-1, design glass, exterior: laminated safety glass with matt stripes, centre: single-pane safety glass, matt Parsol grey, with 7 continuous clear stripes, interior: clear laminated safety glass, U_D -value up to approx. $1.6 \text{ W}/(\text{m}^2\cdot\text{K})^*$



Style 100 / MG 112
Stainless steel handle 38-1, design glass, exterior: matt laminated safety glass with clear rectangle, centre: Micrograin, interior: clear laminated safety glass, U_D -value up to approx. $1.6 \text{ W}/(\text{m}^2\cdot\text{K})^*$



Style 100 / MG 113
Standard handle knob 54, design glass, exterior: laminated safety glass with 25 matt stripes, centre: Stopsol grey single-pane safety glass with 26 matt stripes, interior: clear laminated safety glass, U_D -value up to approx. $1.6 \text{ W}/(\text{m}^2\cdot\text{K})^*$



Style 100 / MG 114
Stainless steel handle 38-1, design glass, exterior: matt laminated safety glass with 4 clear circles and 8 clear stripes, 6 mm, centre: single-pane safety glass, Stopsol grey, with 4 matt semi-circles, interior: clear laminated safety glass, U_D -value up to approx. $1.6 \text{ W}/(\text{m}^2\cdot\text{K})^*$

* Dependent on door size. Specified values for RAM $1230 \times 2180 \text{ mm}$.

► **TopComfort style 100 / MG 113** in preferred colour Ruby red RAL 3003, matt, with side elements



Style 100 / MG 115

Stainless steel handle 38-1, design glass, exterior: matt laminated safety glass with clear rectangle, centre: matt Ornament 553 with 5 clear rectangles and 6 half-matt rectangles, interior: clear laminated safety glass, U_D -value up to approx. $1.6 \text{ W}/(\text{m}^2\cdot\text{K})^*$



Style 100 / MG 116

Stainless steel handle 38-1, design glass, exterior: laminated safety glass with matt rectangles, centre: Reflo with matt crescent and 8 matt stripes, interior: laminated safety glass, U_D -value up to approx. $1.6 \text{ W}/(\text{m}^2\cdot\text{K})^*$

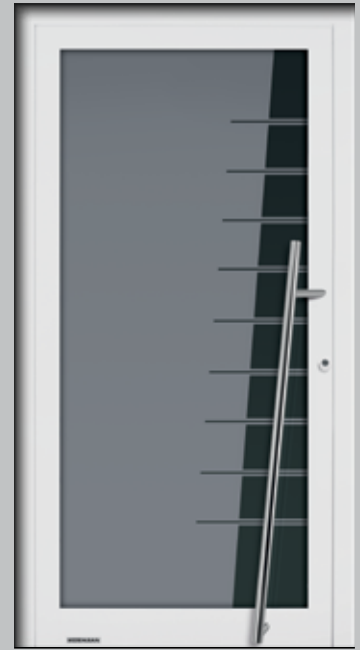

Style 100 / MG 117

Stainless steel handle 020, design glass, exterior: matt laminated safety glass with 9 clear stripes, centre: matt Parsol grey single-pane safety glass with 9 clear stripes, interior: clear laminated safety glass, U_D -value up to approx. $1.6 \text{ W}/(\text{m}^2\cdot\text{K})^*$





Doors that make your wishes for well-being at home come true

Our optional extras offer you a variety of possibilities to design the door of your dreams according to your individual preferences. For example, you can combine colours, handles and glazings according to your taste. We also offer you a choice with regard to security: You can choose between various automatic lock variants and convenient operating options that fulfil your needs. Whatever you decide on – at Hörmann, you will find an entrance door to suit both your taste and your home.

Designing entrances with side elements and transom lights

To create an impressive entrance to your home, you can individually combine each of the illustrated ThermoSafe, Thermo65 and TopComfort entrance doors with side elements and transom lights, or combine each ThermoCarbon entrance door with side elements. An elegant and attractive overall look will please you for a long time to come.

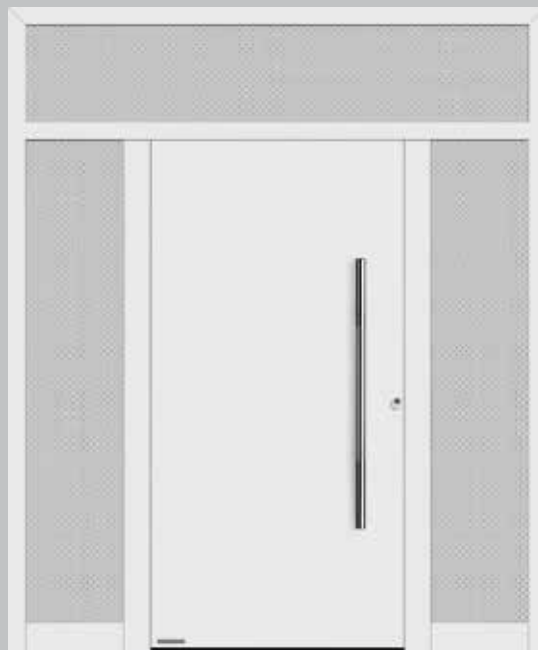

Entrance door with two side elements and transom light



Entrance door with one side element



Entrance door with two side elements, style infills in the side elements (ThermoSafe)
■ NEW



Entrance door with transom light

The figures show ThermoSafe entrance doors with side elements and transom lights in vertical/horizontal profile construction

Side elements with practical letter box systems

Hörmann can furnish you with the letter box system to suit your taste and the number of flats. Letter box systems and letter drops are available with bell buttons, light switches and intercom mesh, all with high-grade stainless steel covers and with a thermally insulated aluminium panel infill plate for simple mounting without extensive brickworks.

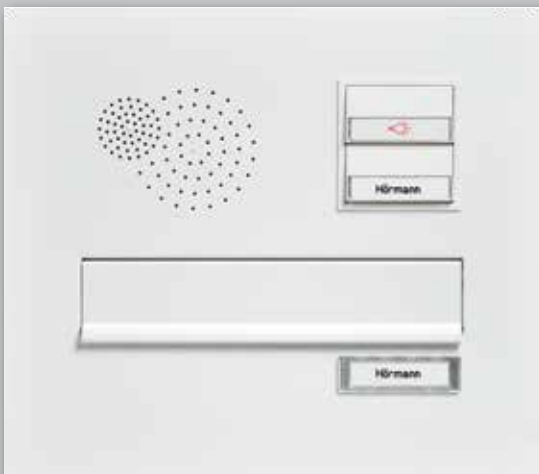

Classic letter box system for 1 flat



Letter box system RSA 2, insulated, for 5 flats

Door version	ThermoCarbon	ThermoSafe	Thermo65	TopComfort
Side elements	●	●	●	●
Side elements with style infills		●		
Transom lights		●	●	●
Letter box systems		●		●

Custom glazings for side elements and transom lights

Each glass type has a different look depending on colour, structure and finish. That's why Hörmann offers you a wide range of glazings to equip your new entrance door with.

You can match side elements and transom lights to your entrance door according to your wishes with custom glazings or design glass.

Door version	ThermoCarbon	ThermoSafe	Thermo65	TopComfort
1 Float, clear	●	●	●	●
2 Float, matt/sand-blasted	●	●		●
3 Satinato	●	●		●
4 Pave white	●	●		●
5 Parsol grey	●	●		●
6 Parsol grey, matt	●	●		●
7 Ornament 504	●	●		●
8 Ornament 553	●	●		●
9 Stopsol grey	●	●		●
10 Stopsol grey, matt	●	●		●
11 Chinchilla	●	●		●
12 Micrograin (Madras basic)	●	●		●
13 Reflo, clear	●	●		●
14 Reflo, matt	●	●		●
15 Silk	●	●		●
16 Mastercarré	●	●		●



Tangibly beautiful design

Each Hörmann entrance door is delivered as standard with the handle shown on the product photos. However, on request, you can equip many of our doors with a customised handle.

Please consult your specialist dealer for more information on the various options, as well as delivery times and prices.

Handle	Description	ThermoCarbon	ThermoSafe	Thermo65	TopComfort
1	HOE 200	Brushed stainless steel	●	●	
2	HOE 300	Brushed stainless steel	●	●	
3	HOE 500	Brushed stainless steel	●	●	
4	HOE 501	Brushed stainless steel	●	●	
5	HOE 600	Brushed stainless steel	●	●	
6	HOE 605	Brushed stainless steel, prepared to hold a finger-scan or code switch		●	
7	HOE 700	Stainless steel with decorative centre part	●	●	
8	HOE 701	Stainless steel with decorative centre part	●	●	
9	HOE 710	Brushed stainless steel	●	●	● (G 710)
10	HOE 740	Brushed stainless steel	●	●	● (G 740)
11	HOE 795	Brushed stainless steel	●	●	
12	HOE 796	Brushed stainless steel	●	●	
13	HOE 800	Stainless steel with decorative centre part		●	
14	14-1	Polished stainless steel with decorative centre part		●	●
15	14-2	Brushed stainless steel		●	●
16	38-1	Polished stainless steel with decorative centre part		●	●
17	38-2	Brushed stainless steel		●	●
18	38-3	Brushed stainless steel			
19	81-1	Polished brass			●
20	92-2	Brushed stainless steel		●	●
21	94-2	Brushed stainless steel		●	●
22	ES 0	Brushed stainless steel		●	
23	ES 1	Brushed stainless steel		●	

+ mm += axis dimension
┌ mm ─= handle length

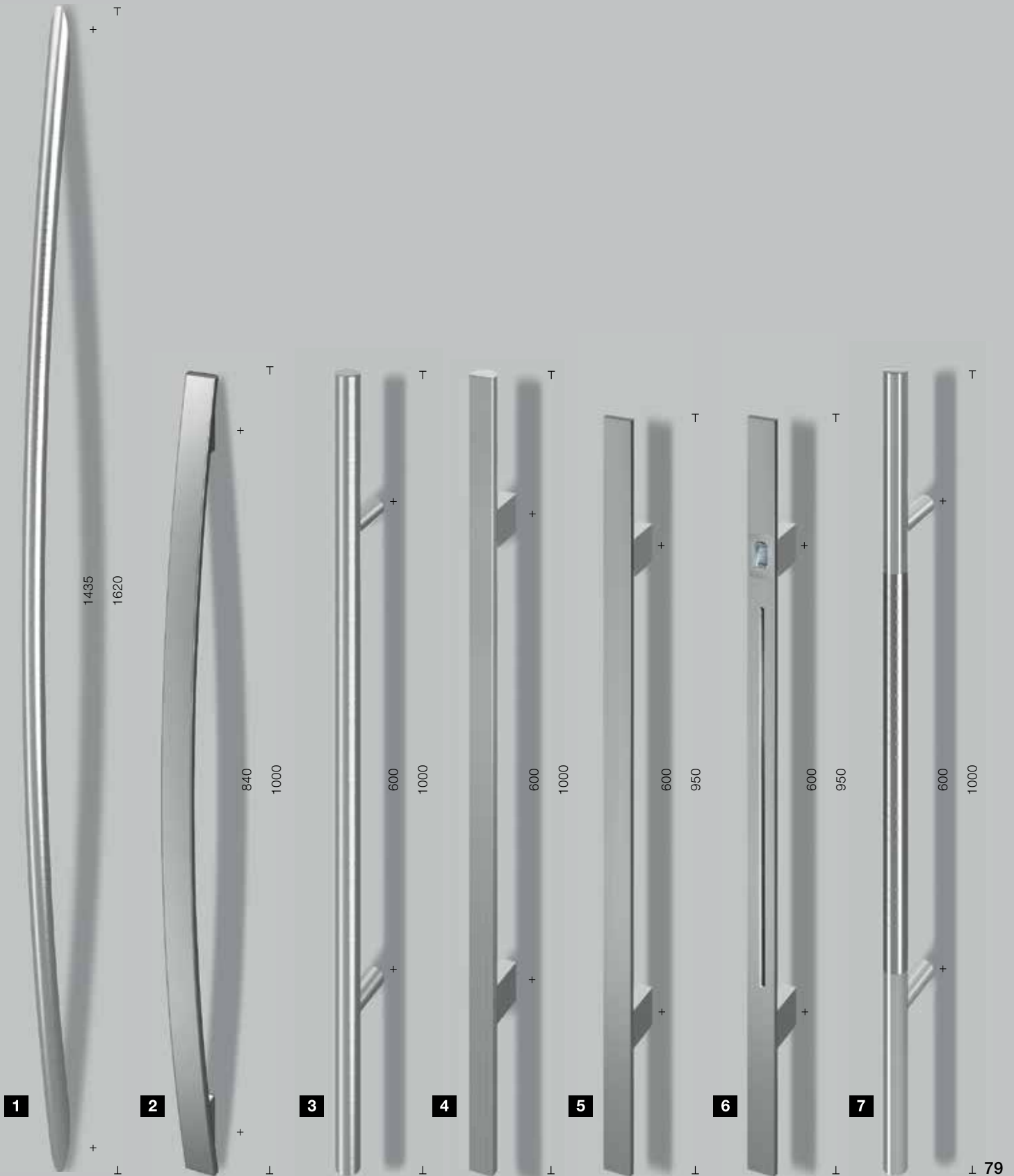

All dimensions in mm

8

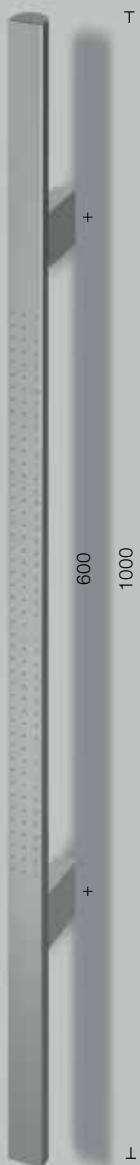

9



10



11



12



13



14

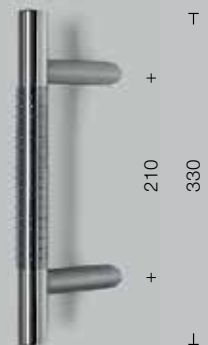

15

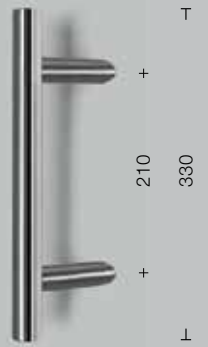

+ mm += axis dimension
└ mm ─= handle length

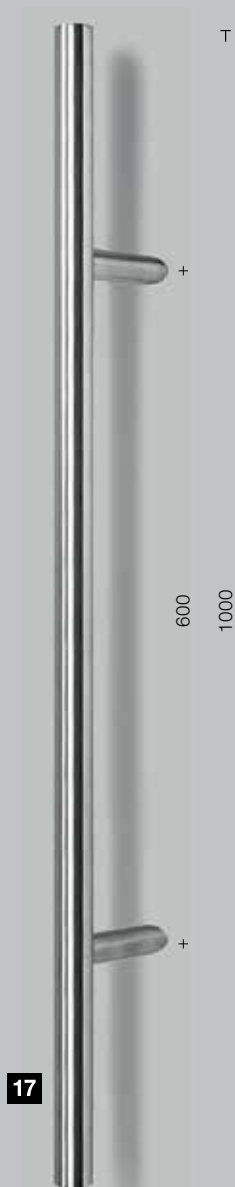
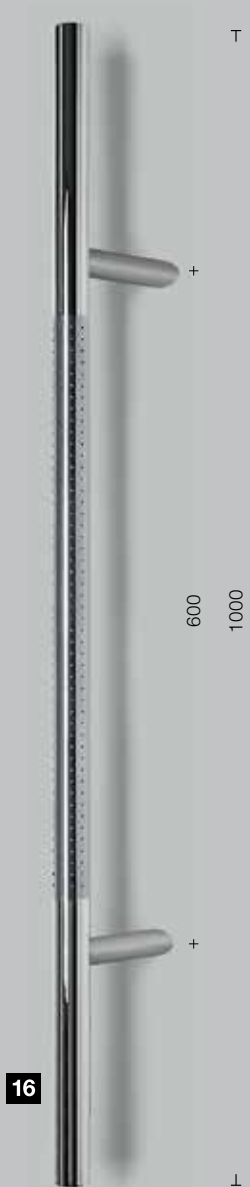

Our designer handles

A continuous design handle not only rounds off the exclusive appearance of your entrance door, it is also extremely comfortable to operate. As a result, small children can also open the door using this handle. DesignPlus handles offer you elegant embellishments to create a customised door. This lets you adjust both the handle and handle embellishment to match the colour of the door and the rest of your home.

Persuasive elegance in 3 colours and in RAL to choose: the design handle G 750 for ThermoSafe



Handle in Traffic white, RAL 9016, matt



Handle in RAL to choose (shown in matt Ruby red, RAL 3003)



Handle in White aluminium, RAL 9006, silk-gloss



Handle in Hörmann colour CH 703 Anthracite, matt textured

Effective illumination with LED light strip

■ **NEW** The design handle G 750 and the DesignPlus handle G 760 are also optionally available with a light strip integrated into the handle. This particularly emphasizes your ThermoSafe entrance door at night.



**Exclusive design to suit your taste:
DesignPlus handle G 760 for ThermoSafe**



Handle in Hörmann colour CH 703, matt textured Anthracite, handle embellishment in Hörmann colour CH 703, matt textured Anthracite



Handle in anodised aluminium E6 / EV 1, handle embellishment in Hörmann colour CH 703, matt textured Anthracite



Handle in RAL to choose (shown in matt Ruby red, RAL 3003), handle embellishment in Hörmann colour CH 703, matt textured Anthracite



Handle embellishment in anodised aluminium E6 / EV 1, handle in anodised aluminium E6 / EV 1



Handle embellishment in matt Traffic white, RAL 9016, handle in anodised aluminium E6 / EV 1



Handle embellishment in matt Ruby red, RAL 3003, handle in anodised aluminium E6 / EV 1



Handle embellishment in Decograin Golden Oak, handle in anodised aluminium E6 / EV 1

Handle embellishments are also available in Decograin timber designs



Decograin Light Oak:
Light, warm oak design

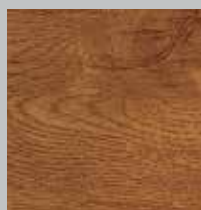

Decograin Golden Oak:
Medium-brown, golden yellow oak design

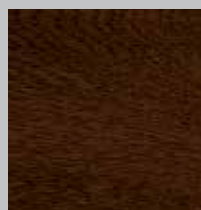

Decograin Dark Oak:
Walnut-coloured oak design



Decograin Night Oak:
Dark, intense oak design

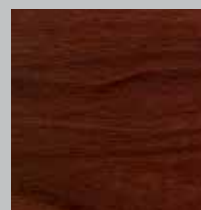

Decograin Rosewood:
Mahogany-coloured timber design

Custom colour combinations for ThermoCarbon entrance door styles 300, 301, 302, 304, 305, 308 and 312.

For these exclusive ThermoCarbon entrance door styles, you have the option to individually coordinate the flush-fitting handle bar and recessed grip with the colour of your entrance door or embellishment.



Style 300
In Traffic white, RAL 9016, matt, handle bar in Traffic white, RAL 9016, matt, recessed grip in door colour



Style 300
In the preferred colour Slate grey, RAL 7015, matt, handle bar in White aluminium RAL 9006, silk-gloss, recessed grip in the preferred colour White aluminium RAL 9006, silk-gloss



Style 301
In Hörmann preferred colour CH 703 Anthracite, fine structure matt, aluminium embellishment in preferred colour Ruby red RAL 3003, matt, handle bar in preferred colour Ruby red RAL 3003, matt, and recessed grip in door colour

Optional colour combinations for styles 304, 305, 306, 314



Style 304
In Traffic white, RAL 9016, matt, stainless steel handle, recessed grip in preferred colour White aluminium RAL 9006, silk-gloss



Style 305
In the preferred colour Slate grey, RAL 7015, matt, aluminium embellishment in the preferred colour White aluminium RAL 9006, silk-gloss, stainless steel handle, recessed grip in the preferred colour White aluminium RAL 9006, silk-gloss



Style 305
In Hörmann preferred colour CH 703, Anthracite, fine structure matt, aluminium embellishment in preferred colour White aluminium RAL 9006, silk-gloss, stainless steel handle, recessed grip in door colour

Optional colour combinations for style 308



Style 308
In Traffic white, RAL 9016, matt, handle bar and recessed grip in Traffic white RAL 9016, matt



Style 308
In preferred colour Slate grey, RAL 7015, matt, handle bar in White aluminium RAL 9006, silk-gloss, recessed grip in door colour



Style 308
In Hörmann preferred colour CH 703, Anthracite, fine structure matt, handle bar and recessed grip in preferred colour Ruby red RAL 3003, matt

Elegant interior levers

To create a harmonious indoor appearance, you can select from various interior levers for your new entrance door.

ThermoSafe and TopComfort doors are equipped with the aluminium interior lever Rondo as standard. This lever is also available in stainless steel or a RAL colour of your choice to match the stainless steel interior levers on your internal doors. In addition, the stylish lever handles Caro and Okto are available as stainless steel variants.

ThermoCarbon doors are equipped with the stainless steel Caro lever handle as standard.

Thermo65 entrance doors are available with a stainless steel lever handle D-110 as standard.



Aluminium lever handle Rondo in matt Traffic white, RAL 9016, for ThermoSafe and TopComfort



Stainless steel lever handle Caro for ThermoSafe and ThermoCarbon



Stainless steel lever handle Okto for ThermoSafe



Stainless steel lever handle D-110 for Thermo65

Securing excellent properties

Fingerprint, code or radio – Hörmann offers automatic lock variants for more security and convenient operation.

ThermoSafe entrance doors are optionally available at no surcharge with the automatic lock S5 that automatically and securely locks your entrance door at four different points as soon as the door falls shut. You can also equip your ThermoCarbon entrance door with the 7-point automatic lock S7 at no surcharge.

You may, of course, also continue to use a key to lock and unlock your door.

Tip:

The S5 / S7 automatic locks have been tested and certified by the VDS (German Property Insurance Association). This means that the self-locking doors are considered locked/bolted in case of a break-in, maintaining your claims towards your property insurance.



ThermoCarbon

Automatic lock S7 Automatic with 7-point locking

All ThermoCarbon entrance doors can be **optionally** equipped with a latch catch lock with 6 bolts, which automatically extend when the door is closed **(free-of-charge)**. In addition, the door can also be secured via the lock with another bolt.

Automatic lock S7 Comfort Connect

The automatic lock S7 Comfort Connect also automatically closes your door via a latch catch lock. Thanks to an integrated electric motor, you can also operate your ThermoCarbon entrance door conveniently via finger-scan, code switch or radio. You can see the various options on the following pages. Data transmission is wireless thanks to the innovative **HOE Connect** contact strip. If your building has a house intercom, you can connect the S7 Comfort Connect to it and equip the lock with a button.

ThermoSafe

Automatic lock S5 Automatic with 5-point locking

The latch catch lock with mechanical self-locking is **optionally available at no surcharge** for your ThermoSafe entrance door: if the door falls shut, the 4 bolts automatically extend and reliably lock the entrance door. In addition, the door can also be secured via the lock with another bolt.

Automatic lock S5 Comfort

The automatic lock S5 Comfort locks your entrance door automatically with latch catches. An additional electric motor enables unlocking of the door via external control elements, such as a finger-scan, code switch or hand transmitter (see following pages). In this process, the power and data signals are transmitted from door frame to door leaf via a cable in the door rebate. S5 Comfort is prepared for connection to a button or an existing house intercom and is ideally suited for blocks of flats. This way, you can conveniently open your entrance door at the press of a button, for example from an upper storey.



S5/S7 Comfort – open the door at the push of a button



Extremely practical: wireless data transfer with HOE Connect

Convenient operation for young and old alike

S5 / S7 Scan automatic lock

Open your entrance door with your fingerprint. The finger scanner recognises up to 100 fingerprints and can be taught in without a computer.

S5 / S7 Code automatic lock

Simply entering your personal security code opens your entrance door from outside.



S5 / S7 Scan – door is opened by fingerprint – fitted in the door leaf



S5 / S7 Code – door is opened by entering a code – fitted in the door leaf



Finger-scan in the door handle



Elegant code switch with touch-sensitive touch surface (optional for ThermoSafe entrance doors)



Code switch – fitted in the door handle

BiSecur

Automatic lock S5 / S7 Smart

You can conveniently open your entrance door with an optional hand transmitter or a radio switch. The extremely safe radio system ensures that no unauthorised person can copy your radio signal. Another advantage is that you can use the same hand transmitter to operate your Hörmann garage door or entrance gate. The S5 / S7 Smart remote control can also be installed in the S5 / S7 Scan and S5 Code convenience packages. Starting now, you can also operate and control ThermoSafe and ThermoCarbon entrance doors with the practical BiSecur app. This allows you to query the status of your door at any time and any place.



S5 / S7 Smart 22 – open the door using BiSecur radio

Door operator ECTurn for barrier-free entrances

As of now, ThermoSafe and ThermoCarbon entrance doors can optionally be equipped with the door operator ECTurn. The operator is available elegantly integrated into the door leaf and frame or as a surface-mounted variant. With the automatic lock and ECTurn, you can automatically open and close your door. You can control the operator easily via radio or the BiSecur app, which also allows you to query whether your door is open or closed from anywhere in the world.



Convenient opening with the entrance door operator ECTurn. The operator is also available elegantly integrated into the door leaf and frame.



Select your hand transmitter or radio switch from our broad accessories programme. More information can be found in the Garage Door and Entrance Gate Operators brochure.



With the BiSecur app, you can check whether your entrance door is open or closed.



Experience Hörmann quality in new construction and modernisation

Hörmann provides an excellent basis for comprehensive planning. Carefully matched solutions offer you the very best in perfectly designed products for every area.

- **Garage doors**

Optimally match your personal architectural style: up-and-over or sectional doors made of steel or timber.

- **Door operators**

Enjoy extra convenience and break-in-resistant security with Hörmann operators for garage doors and entrance gates. You can profit from the convenience of Hörmann door operators in your residential space as well.

- **Entrance doors**

Our comprehensive entrance door ranges include models that fit almost every need and requirement.

- **Steel doors**

Sturdy doors for your entire home, from basement to roof.

- **Frames**

Choose from our comprehensive range of products for new construction, expansion and modernisation.



Garage doors and entrance gate operators



ThermoPro entrance door



Steel doors

Hörmann: Quality without Compromise



Hörmann KG Amshausen, Germany



Hörmann KG Antriebstechnik, Germany



Hörmann KG Brandis, Germany



Hörmann KG Brockhagen, Germany



Hörmann KG Dissen, Germany



Hörmann KG Eckelhausen, Germany



Hörmann KG Freisen, Germany



Hörmann KG Ichtershausen, Germany



Hörmann KG Werne, Germany



Hörmann Alkmaar B.V., Netherlands



Hörmann Legnica Sp. z o.o., Poland



Hörmann Beijing, China



Hörmann Tianjin, China



Hörmann LLC, Montgomery IL, USA



Hörmann Flexon LLC, Burgettstown PA, USA



Shakti Hörmann Ltd., India

Hörmann is the only manufacturer worldwide that offers you a complete range of all major building products from one source. We manufacture in highly-specialised factories using the latest production technologies. The close-meshed network of sales and service companies throughout Europe, and activities in the USA and Asia, make Hörmann your strong partner for first-class building products, offering "Quality without Compromise".

GARAGE DOORS
 OPERATORS
 INDUSTRIAL DOORS
 LOADING EQUIPMENT
 HINGED DOORS
 DOOR FRAMES