



Engineered Slate

Installation Guide



Table of Contents

Contact Information.....	Page 2
General Product Details.....	Page 3
Code Compliance.....	Page 3
Adhesives and Sealants.....	Page 3
General Design Details.....	Page 3
Slopes.....	Page 3
Specialty Roof Decks.....	Page 3
Underlayment.....	Page 4
Fastening.....	Page 4
General Application Details.....	Page 4
Application of Ply Gem Engineered Slate.....	Page 5
Typical Eaves Detail.....	Page 6
Hip and Ridge Details.....	Page 7
Roof Details.....	Page 8
Valley Flashing Details.....	Page 9
Valley Installation.....	Page 9
Wall Flashing Details.....	Page 10
Ventilation Details.....	Page 11
Plumbing Pipes & Other Projections.....	Page 11
Eaves Protection.....	Page 12
Cold Weather Roof Systems.....	Page 12
Reference Drawings / Installation Diagrams.....	Beginning on Page 14

PLYGEM ROOFING ENGINEERED SLATE INSTALLATION GUIDE

Technical Department Rapid Response

- Email - rooftech@plygem.com
- Toll Free Phone - 1-844-679-3745
- Website - <http://www.plygemroofing.com>

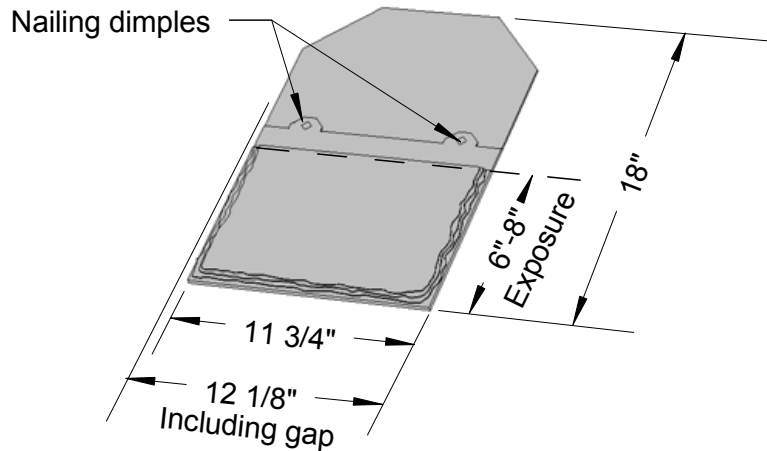

Roof tiles must be cut using a circular saw with a carbide tipped blade. Stationary or hand held saw may be used. Always wear eye protection.

IMPORTANT NOTE:

Unless this is a custom job, thanks to factory quality control collation of roof tiles, the contractor DOES NOT NEED to manually collate tiles from various pallets on the job site. It is recommended that visual inspection is routinely performed from a distance to achieve a desired result.

Provide a minimum of 3/8" spacing gap between tiles. Additional spacing may be required to ensure tiles are vertically parallel and to achieve equal rakes.

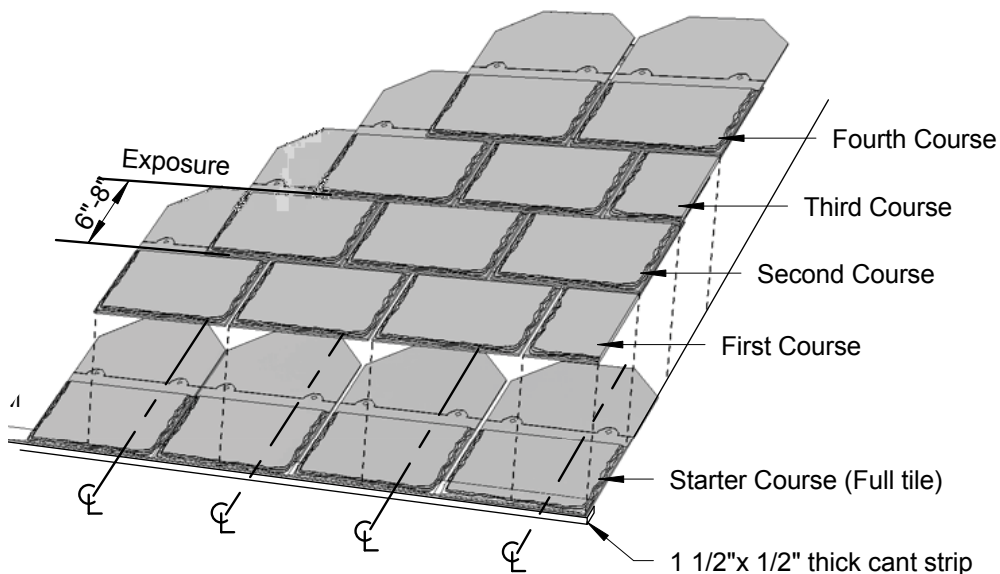

Figure 1: TYPICAL SHINGLE LAYOUT

GENERAL PRODUCT DETAILS

- Tile should be left on pallets until installation and pallets should be stored on a FLAT level surface.
- DO NOT DOUBLE STACK PALLETS
- Tiles should not be stored on the roof in any way that would over-stress the framing or create a safety hazard.
- Minimum Installation Temperature is 30 degrees Fahrenheit.
- Acclimate tiles to at least 30 degrees Fahrenheit for 24 hours prior to installation.

CODE COMPLIANCE

- Fire Resistance - CLASS A - ASTM E84 using 30 lb. felt for 6" exposure. Beyond 6" exposure, fire-rated underlayment is required.
- Wind Resistance - TAS 100 maximum exposure 8" & TAS 107 maximum exposure 6".
- Impact Resistance - UL2218, Class 4.
- Contact your local Building Code Enforcement Officer. Identify, verify and comply with all local building codes.
- BE SAFE - follow all OSHA and Roofing Trade Safety Guidelines and Best Practices.

ADHESIVES AND SEALANTS

- When the use of a sealant is required, Ply Gem Roofing recommends polyurethane based type sealants.
- In all locations where shingles cannot be nailed use the Ply Gem Roofing Hidden Fastening Adhesive Kit. For detailed application guidelines please refer to the Ply Gem Roofing Hidden Fastening Adhesive Kit application instructions found in the kit and at our website. www.plygemroofing.com

GENERAL DESIGN DETAILS

DECKING

Ply Gem Roofing Engineered Slate should be applied over solid sheathing only. Sheathing may consist of composite board panels, such as 7/16" oriented strand board or plywood at a minimum 1/2" thickness 1/2" on center 16" on center rafter and 5/8" on 24" on center rafters. In reroofing applications the existing roof must be completely removed down to the deck. The deck must be solidly fastened to structural supports in accordance with applicable building codes and provide a smooth base for the roofing tiles.

SLOPES

The Ply Gem Roofing Engineered Slate can be applied on any roof with a slope of 4/12 (18.5%) or more. For roofs with slopes less than 4/12, consult Ply Gem for instructions.

SPECIALTY ROOF DECKS

Wood decks form an ideal base over which to apply Tiles, since they can be attached in the conventional manner.

Where a layer of insulation, normally one of the rigid types, or insulated nail board is to be used, consult Ply Gem for special application requirements and instructions.

UNDERLAYMENT

36" of ice and water shield at perimeters. One layer of underlayment, consisting of No.30 non-perforated plain felt or equivalent synthetic underlayment must be installed to the deck prior to the application of the Ply Gem Roofing Engineered Slate Tiles. Install one ply over the entire roof area.

Lay underlayment parallel to the eaves with a minimum head lap of 4" (102mm) , side lap 8" (204 mm).

Nail or staple the underlayment sufficiently to hold in place, until the tiles are installed. (see Drawings 1.1 and 1.2)

FASTENING

Each Ply Gem Roofing Engineered Slate Tile should be applied with two fasteners properly placed in the nail guide holes. Use corrosion-resistant fasteners, such as stainless steel (type 304 or 316), hot-dipped zinc coated, or copper. Nails should have a nominal shank diameter of 1/8" (3mm) and a head diameter of 3/8" (9.5mm). Nails can be hand or power driven with a proper pressure and depth setting pneumatic nailer. Fastener length should be 1 1/2" minimum or sufficient to penetrate 25/32" (20mm) into the roof deck. Where the deck is less than 25/32" (20mm) thick, the fastener should be long enough to penetrate the full thickness and through the deck.

Where fastening may be marginal, such as in areas around chimneys, valleys, and soil stacks, use a recommended construction adhesive in addition to nailing to ensure securement of the tiles. Approved adhesive (sealant) to be exterior construction grade.

GENERAL APPLICATION DETAILS

Regardless of style, the following basic application details must be observed:

- Ply Gem Roofing Engineered Slate Tiles must be doubled at all eaves.
- Butts of first course of Ply Gem Roofing Engineered Slate Tiles should project 1" (19mm) beyond the fascia at all rakes and eaves.
- Spacer lines are provided to maintain a minimum distance of 3/8" between tiles. Additional spacing is required to ensure tiles are vertically parallel and to achieve equal rakes. Vertical and horizontal chalk lines are recommended.
- Install a minimum of two (2) nails per tile. Use the nail guide openings wherever possible for the required exposure in the succeeding tile courses.
- Joints in any one course should be separated 6" (153mm) from joints in adjacent courses; and in succeeding courses, no two joints should be in direct alignment.
- The starter course must be elevated at the eave line to create the proper angle to match the angle of the field tiles. This is achieved by installing a cant strip or shim strip under the bottom edge of the starter course. Cant strips can be made from wood or a long lasting synthetic substrate and should be 1 1/2" x 1/2" in dimension.

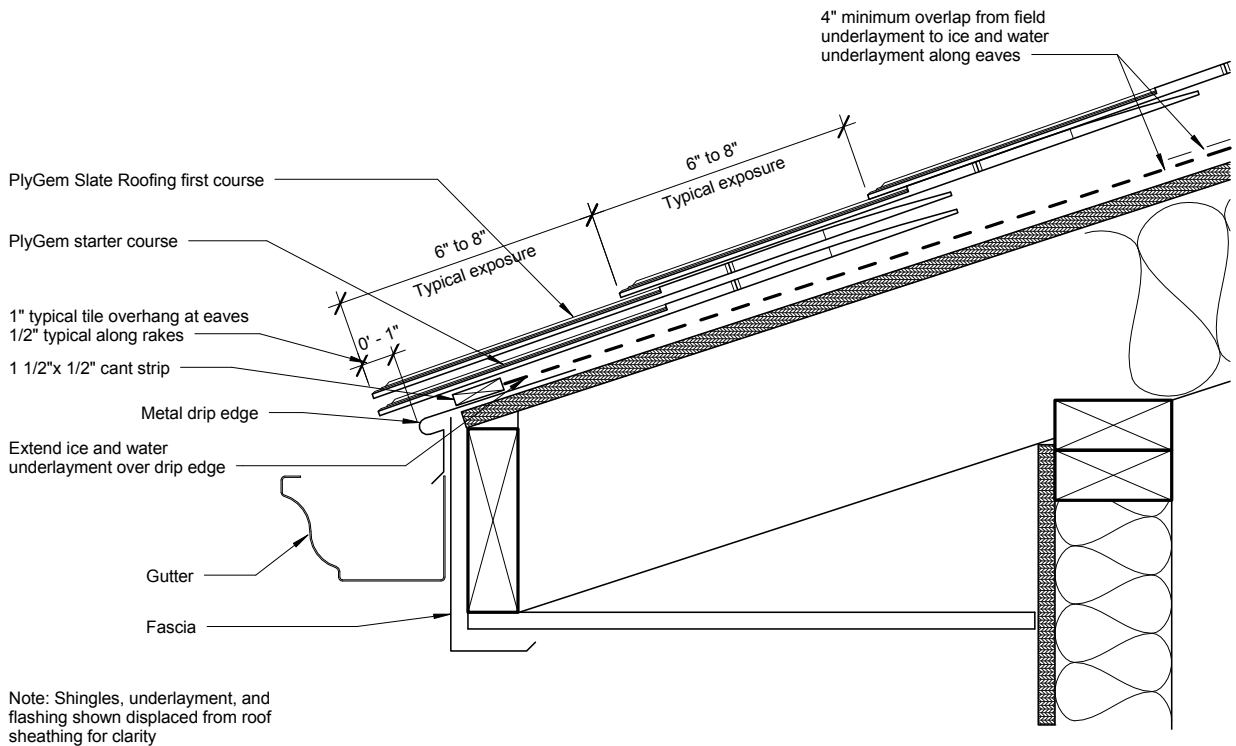

Figure 2: EAVE AND RAKE EDGES

APPLICATION OF THE PLY GEM ROOFING ENGINEERED SLATE

The starter course consists of full size Ply Gem Roofing Engineered Slate Tiles being used as the roof covering (see Figure 1 and 4). No roof slate should be less than 3" wide when installed. Spacer lines are provided to maintain a minimum distance of 3/8" between tiles. Additional spacing may be required to ensure tiles are vertically parallel or to achieve equal rakes. Vertical and horizontal chalk lines are recommended. Do not use red chalk as it may permanently stain the tiles.

Install a starter course at the eaves and extend 1" (19mm) beyond eaves and rake edges. Nails should be installed in a parallel line to the base of the roof, in the locations indicated on the individual tiles. Use a chalk line when working on larger roof surfaces to provide for an even application. Install 2 nails per tile in the nail guide openings, for the required exposure in the succeeding tile courses.

Nails should be arranged so as not to be left exposed by the openings between tiles. Install the starter course so that the individual finished eaves tile shall lap each starter tile by approximately 6" (153mm).

The starter course must be elevated at the eave line to create the proper angle to match the angle of the field tiles. This is achieved by installing a cant strip or shim strip under the bottom edge of the starter course. Cant strips can be made from wood or a long lasting synthetic substrate and should be 1 1/2" x 1/2" in dimension.

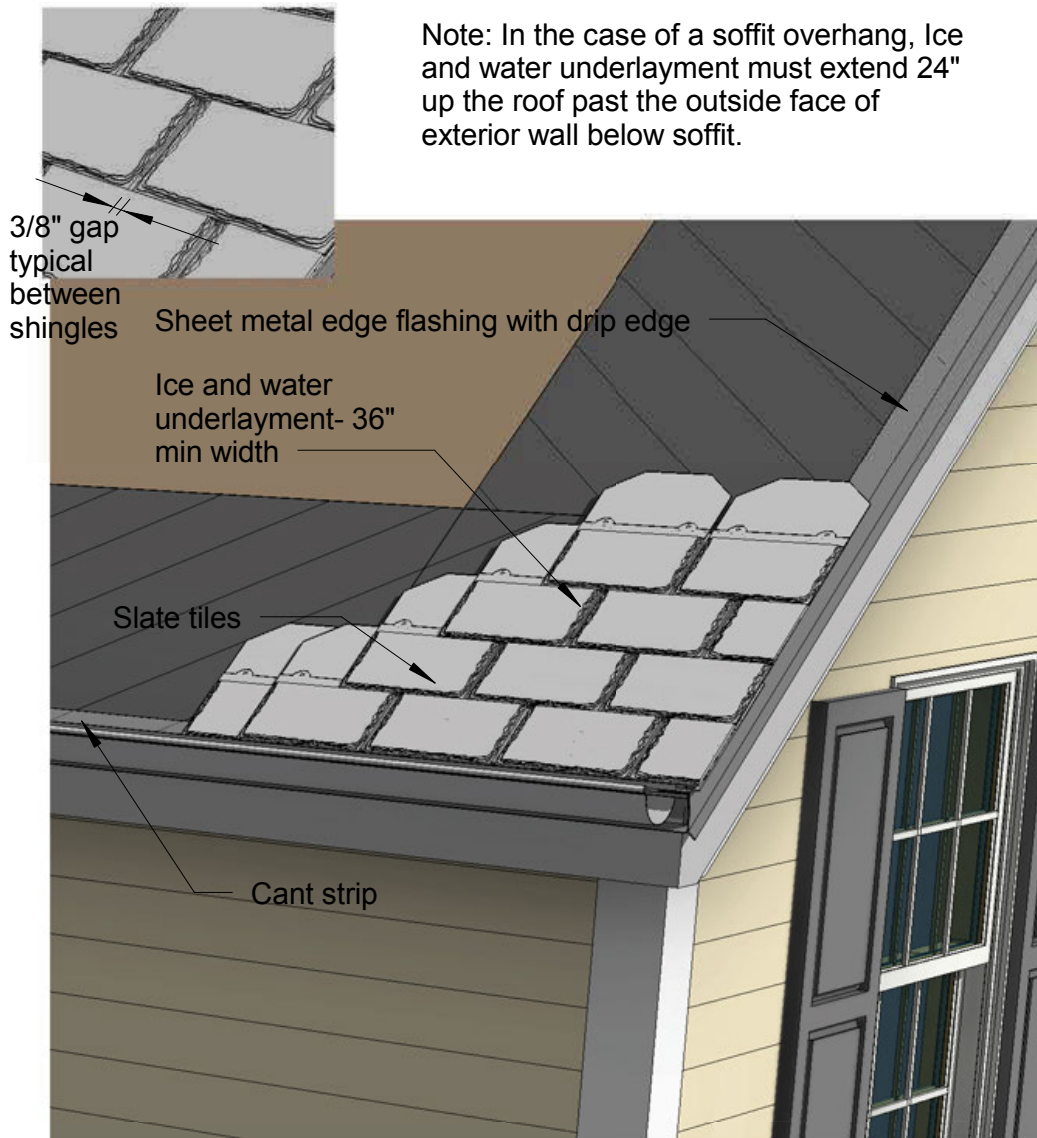
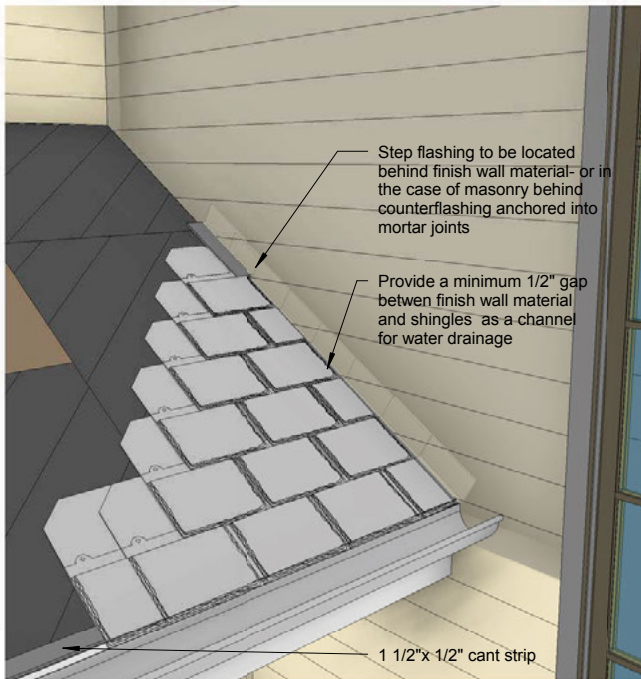

Figure 3: TYPICAL EAVES DETAIL

Install the first course of tiles starting with a full tile overhanging the eaves and rake edges by 1" (19mm).

Install the second course of tiles by cutting a full Ply Gem Engineered Slate tile in half. Then alternate this with a full tile for the succeeding course. Center the succeeding course over the joints in the underlying tile. The joints between tiles in succeeding courses shall be off-set by 6" (153mm).

Install the tiles with a 6" (153mm) exposure on roof slopes of 4/12 to 6/12. On slopes of 7/12 or greater the tile exposure may be increased to 7" (179mm). Note: The markings on the tile, allow the exposure to be defined by the tile below. For installation on slopes of less than 4/12 consult Ply Gem.



Finished View

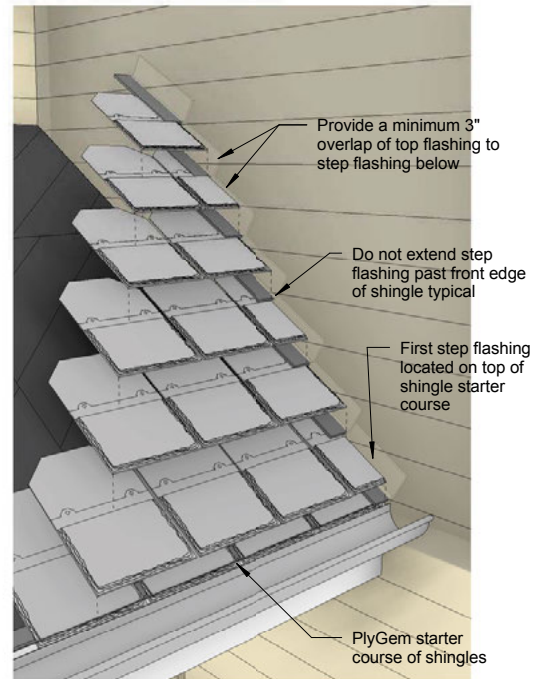

Displaced View

Figure 4: WALL FLASHING SIDE STEP

HIP AND RIDGE DETAILS

Intersecting roof surfaces at hips and ridges must be capped to ensure a weather tight joint. Factory made hip and ridge tiles must have alternate overlaps and concealed nailing (Figure 4.1 and Drawing 4.2). Weather exposures should be at a 6" exposure as marked on the hip & ridge tile. Nails must be longer than those used on the field of the roof and of sufficient length to penetrate 3/4" (20mm) into or completely through the sheathing.

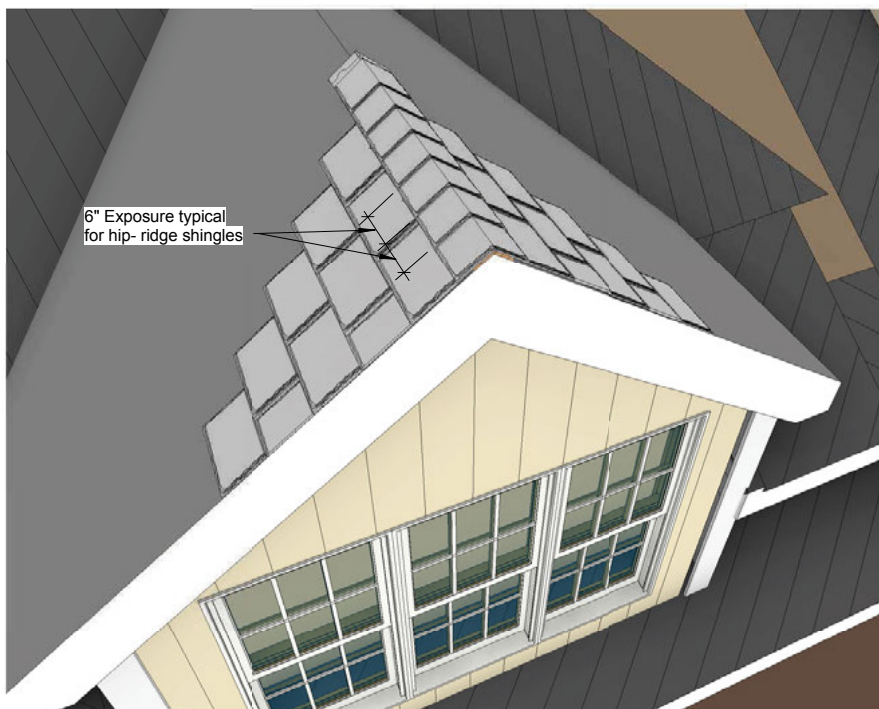

Notes:
 1. Two nails minimum should be used for each hip-ridge tile, one tile goes on each side of the ridge. All nails should have a minimum 3/4" embedment into roof sheathing. In all locations where shingles cannot be nailed use Ply Gem Roofing "Hidden Fastening Adhesive Kit."

2. If ridge vent is to be installed below ridge tile, nails should be continuous through ridge vent into roof sheathing below.

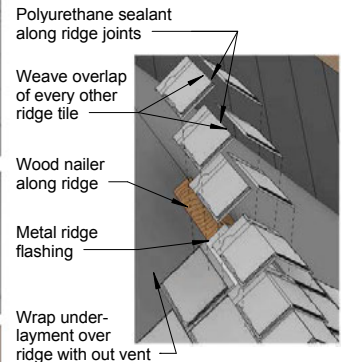

LEGEND

 HATCHED LINES INDICATE RECOMMENDED ICE AND WATER UNDERLAYMENT LOCATIONS

Figure 6: HIP DETAIL

Before installing hips and ridges, place two chalk lines, 6" (153mm) on each side of the center of the ridge and parallel to each other along the entire length (Drawings 4.1 and 4.2). The exposed edges of the tile should be aligned with these chalk lines.

There are markings on the hip and ridge tiles for ease of installation..

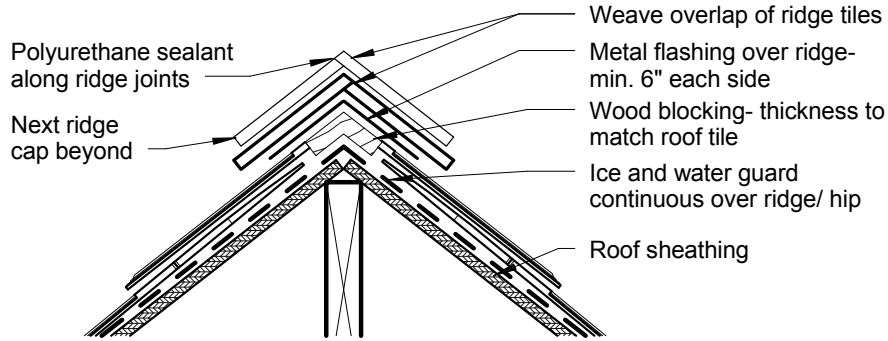

Figure 7: HIP DETAIL

Prior to the application of the hip and ridge tiles a strip of 26 gauge (0.55mm) galvanized metal, .032 gauge aluminum or 16 oz. copper, bent to the proper angle must be applied over the ridge. The flanges of the metal, on each side of the ridge, must extend down onto the Ply Gem Roofing Engineered Slate Tile a minimum of 2.5" (63mm).

ROOF DETAILS

Correct construction of roof transitions is vital to ensure weather tightness. In the following cases, where metal flashing is employed, it should be no less than 26 gauge (0.55mm) galvanized steel, 16 oz. (0.8mm) copper or .032 gauge aluminum. Steel should be painted on both sides with a good metal or bituminous paint. Flashing materials may require painting after bending to maintain the integrity of the coating.

VALLEY FLASHING DETAILS

Most roof leaks occur where water is channeled off the roof or where the roof abuts a vertical wall or chimney. At these points, metal valleys, saddles, and flashings are used in conjunction with Ply Gem Roofing Engineered Slate Tiles in keeping the structure dry.

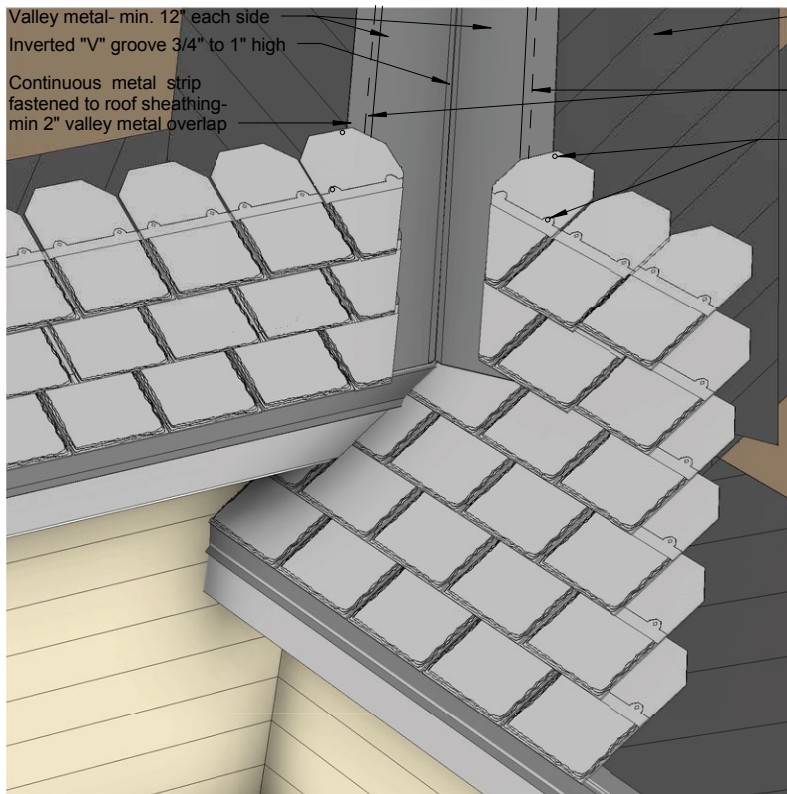

Ice and Water underlayment minimum 36" each side of valley

Provide continuous bead of sealant each side

Provide a minimum of (2) nails per shingle that do not penetrate valley metal below

General Notes:

1. All roofing tiles should extend a minimum of 4" over the outer edge of the valley metal.
2. PlyGem would recommend valley metal to be anchored to roof sheathing with metal clips to allow for expansion and contraction.
3. Whenever possible valley should be covered with a single piece of continuous valley metal. When necessary a minimum of 12" overlap with a continuous bead of sealant under seam may be used.
4. Ice and water underlayment is recommended under all valley metal.
5. Recommended total width of metal valley flashing is 24". 12" minimum on each side of crease.
6. The open distance from the center of the valley crease to the shingle should taper 1/8" wider for every 8 feet from top of valley to bottom

Figure 8: OPEN VALLEY

Ply Gem DOES NOT recommend the use of closed valleys. Protrusions through a roof should also be flashed at all intersecting angles to prevent leakage. Step flashing should extend under the Ply Gem Roofing Engineered Slate Tiles and up the vertical surface and should be covered by a second layer of flashing (counter flashing).

Flashing should be galvanized steel, pre-painted steel with a baked-on enamel finish, copper or aluminum. Different flashing metals are available in different areas depending on climatic variations. It is good practice to use metals that have proven their reliability under the specific conditions to be encountered. It is important that metal flashings have the same longevity as the Ply Gem Roofing Engineered Slate Tiles.

Valley Installation

Install one ply of ice and water shield material at all valleys. Extend the membrane 36" (914mm) up the slope from the centerline of the valley.

Install the sheet metal valley flashing over the self-adhering membrane where applied. The metal should extend not less than 12" (308mm) on each side of the valley centerline (verify current code). Check your local building code for exceptions.

Cut and fit the tiles to provide a slight taper in the exposure of the sheet metal flashing towards the head of the valley.

Overlap the sheet metal sections a minimum of 12" (308mm). Valley flashing should be center-crimped, painted, galvanized steel, copper, or aluminum.

WALL FLASHING DETAILS

Counter Flashings

For recommended construction details for applying metal flashings around typical roof projections such as chimneys and vent pipes refer to Figures 10 and Drawings 8.1 and 9.1. Install one ply of self-adhering membrane at all transitions and chimneys. Extend one ply of the ice and water shield 6" (153mm) up all vertical transitions. Lap the membrane over the top portion of the tile.

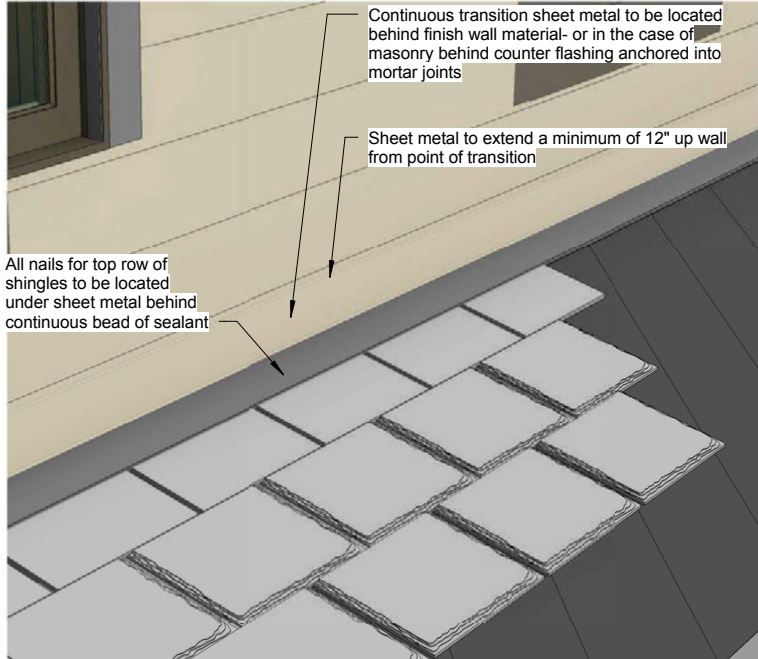

LEGEND

HATCHED LINES INDICATE RECOMMENDED ICE AND WATER UNDERLAYMENT LOCATIONS

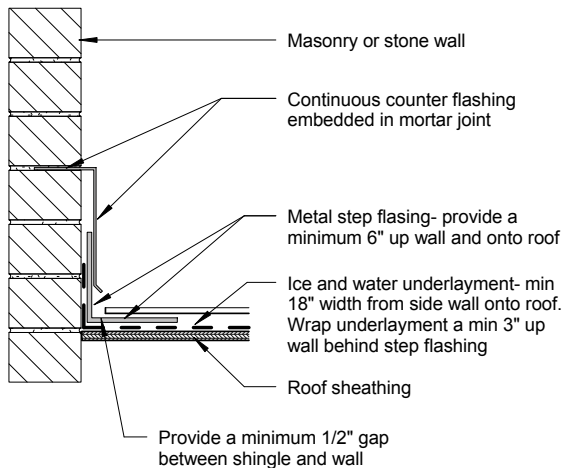
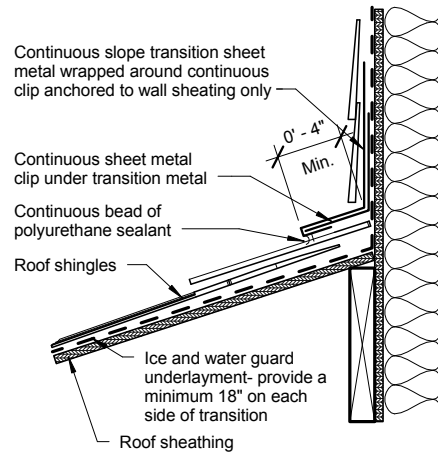

Note: Shingles and flashing shown displaced from roof and wall sheathing for clarity

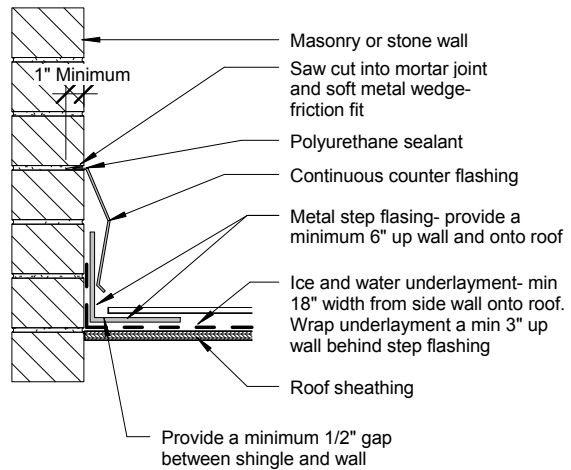

Optional saw cut

Counterflashing detail

Figure 9: COUNTER FLASHING AT MASONRY (Also Drawing 10.1)

Install metal step flashings extending a minimum of 6" (153mm) up the vertical face and 4" (102mm) onto the deck. Provide a minimum headlap of 3" (76mm) for each step flashing. Install Ply Gem Roofing Engineered Slate Tiles over the flange of the step flashings. Ensure that there is a .5" (12mm) space between the tile and the vertical face being flashed.

Install metal counter flashings over the tiles and step flashings. Extend the counter flashing 12" (305mm) up the vertical face and 3" (76mm) out onto the tile surface. Generally, chimney saddles should be installed where the upper side of a chimney on a sloping roof exceeds 30" (762mm).

VENTILATION DETAILS

The importance of good attic ventilation beneath the roof cannot be overstated. Such movement of air will prevent or inhibit condensation of moisture on the undersurface of the Ply Gem Roofing Engineered Slate Tiles, or on the roof decks. Vents should be provided at the soffits (eaves) as well as at gable ends (screened to prevent ingress of insects).

Roof vents may consist of mushroom type or ridge vents. Roof vents should be placed as close to the peak of the roof as possible to obtain the cross-ventilation desirable. A rule of thumb for adequate ventilation is that the ratio of the total net free ventilation area to the area of the attic should be not less than 1:300 of the attic floor when a vapor retarder is in place and 1:150 of the floor area when there is no vapor retarder and for cathedral type roofs, with compensation made for screens over vent apertures. When roofs are of the mansard type, ensure that there is adequate ventilation between the mansard deck and the wall. Attic fans may be beneficial in supplying additional movement of air within attic spaces.

PLUMBING PIPES & OTHER PROJECTIONS

Vent stack and pipe flashings shall consist of friction fit neoprene boots with an integral neoprene flange. Ensure that the flanges of the flashings extend a minimum of 6" (153mm) onto the surface of the tiles and are nailed sufficiently to be secured in place. Trim Ply Gem Roofing Engineered Slate Tiles neatly around base of pipe flange, leaving a .5" (12mm) space for movement.

Ply Gem Roofing Hidden Fastening Adhesive Kit must be used in all tile applications when the use of a nail would create water penetration hazard. For Detailed application guidelines please refer to the Ply Gem roofing Hidden Fastening Adhesive Kit Application Guidelines which can be found in the kit and at www.plygemroofing.com.

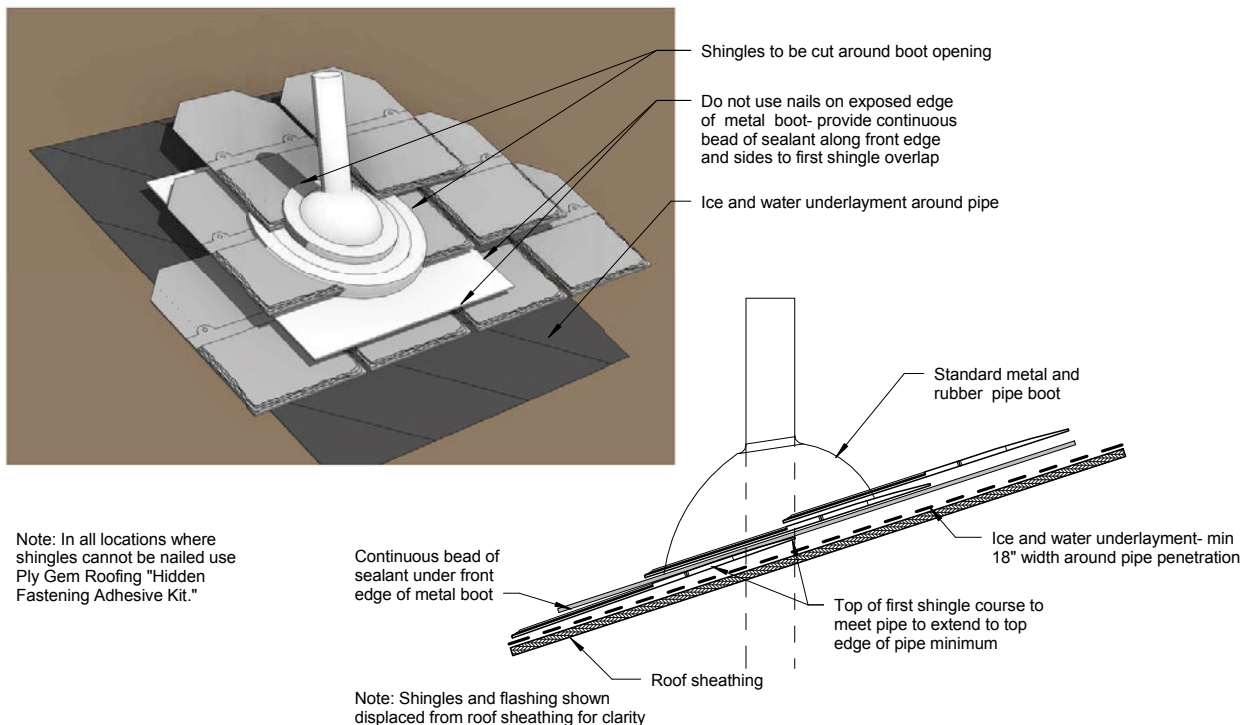

Figure 10: VENT STACK

EAVES PROTECTION

At all eaves over heated buildings, install one ply of self-adhering waterproofing membrane. Start the application at the edge of the eave and extend the membrane a minimum of 36" (914mm) up the slope to a line of 24" (610mm), inside the inner face of the exterior wall. Ensure that the membrane overlaps a minimum of 3" (76mm) at all sides and 6" (153mm) at ends.

COLD WEATHER ROOF SYSTEMS

Once installed, Ply Gem Roofing Engineered Slate Tiles are an excellent roofing material for cold weather areas that experience heavy snowfall and severe temperature extremes. Being made from composite materials, they offer the advantages of durability, superior wind resistance and good weathering properties. As with any other roofing material, however, their best performance depends upon proper design, sound construction practice and correct installation.

Snow guards are necessary accessories for roofs in some sections of the country where masses of snow and ice accumulate on the roof that can slide from the roof onto lower roof areas, or pedestrian or vehicle traffic ways below. Snow guards are manufactured in various styles, and some types require different methods of application.

Reference Drawings

Installation Diagrams - Table of Contents

Number	Sheet Name
0.1	Installation Diagrams Table of Contents
0.2	General Notes & Information
1.1	Membrane Underlayment & Key Diagram- 1
1.2	Membrane Underlayment & Key Diagram- 2
2.1	Eave and Rake Edges- 3D
2.2	Eave and Rake Edges- 2D
3.1	Open Valley Detail - 3D
3.2	Open Valley Detail- 2D
4.1	Ridge & Hip Details- 3D
4.2	Ridge & Hip Details- 2D
5.1	Valley Roof Transition Details
6.1	Hip Roof Transition Details
7.1	Wall Flashing - Side/Step Flashing- 3D
7.2	Wall Flashing - Side/ Step Flashing- 2D
8.1	Wall Flashing - Top/ Counter Flashing Details
9.1	Roof Pipe Penetration Details
10.1	Counterflashing at Masonry
11.1	Pad Style Snow Guards

Engineered Slate Roofing

Installation Diagrams Table of Contents



ESR
0.1

GENERAL NOTES

1. THE FOLLOWING DRAWINGS AND DETAILS REPRESENT GENERIC CONDITIONS FOR THE LAYOUT AND INSTALLATION OF THE PLYGEM ENGINEERED SLATE TILE. FOR CLARITY ONLY PORTIONS OF THE ROOF THAT RELATE TO SPECIFIC INSTALLATION CONDITIONS ARE SHOWN.
2. WHILE THE DIMENSIONS SHOWN ON THESE DETAILS ARE ACCURATE, THESE DRAWINGS ARE NOT INTENDED TO BE SCALED. IT IS THE RESPONSIBILITY OF THE ROOFING CONTRACTOR TO FIELD VERIFY ALL DIMENSIONS AND QUANTITIES AS THIS PRODUCT RELATES TO A SPECIFIC INSTALLATION.
3. IT IS THE RESPONSIBILITY OF THE ROOFING INSTALLER TO EVALUATE THE EXISTING CONDITIONS AND CONTACT PLYGEM FOR RECOMMENDATIONS RELATED TO UNIQUE CONDITIONS THAT ARE NOT REPRESENTED IN THESE DETAILS.
4. PLYGEM DOES NOT RECOMMEND INSTALLATION OF THIS PRODUCT FOR ROOFING SLOPES LESS THAN 4:12.
5. FOR ROOF SLOPES IN EXCESS OF 12:12 THE INSTALLER SHOULD CONTACT PLYGEM TECHNICAL SUPPORT FOR RECOMMENDATIONS ON INSTALLATION.
6. IT IS THE RESPONSIBILITY OF THE ROOFING INSTALLER TO EXAMINE THE EXISTING DECK FOR COMPLIANCE WITH PLYGEM RECOMMENDATIONS. FOR CONDITIONS THAT REQUIRE LONG OR UNUSUAL SHINGLE FASTENERS THE INSTALLER SHOULD CONTACT PLYGEM TECHNICAL STAFF.
7. PLYGEM DOES NOT RECOMMEND INSTALLATION OF THIS PRODUCT OVER EXISTING ROOF SHINGLES OF ANY TYPE. ROOFING DECK SHOULD BE CLEAN AND FLAT RELATIVE TO THE ROOF PITCH PRIOR TO INSTALLATION OF UNDERLAYMENT AND ROOFING PRODUCT. ANY DEFICIENCIES OR UNACCEPTABLE CONDITIONS SHOULD BE REPORTED TO PLYGEM.
8. INSTALLER SHOULD CONSULT UNDERLAYMENT MANUFACTURER FOR RECOMMENDATIONS REGARDING INSTALLATION OF UNDERLAYMENT.
9. IT IS THE RESPONSIBILITY OF THE INSTALLER TO COORDINATE THE WORK OF THE ROOFING INSTALLATION WITH ALL OTHER BUILDING TRADES INCLUDING, BUT NOT LIMITED TO, MECHANICAL ROOF PENETRATIONS.
 10. REFER TO NRCA HANDBOOK (LATEST EDITION) FOR RECOMMENDATIONS RELATED TO FLASHING, DRIP EDGES, SHEET METAL DETAILING, AND GUTTER SIZING, AS WELL AS COORDINATION WITH FASCIA AND GUTTER INSTALLATION. THE FOLLOWING ARE MINIMUM RECOMMENDATIONS FOR METAL TYPE AND THICKNESS:
 - 24 GAUGE PRE FINISHED GALVANIZED STEEL
 - 0.032 INCH THICK PRE FINISHED ALUMINUM
 - 24 GAUGE STAINLESS STEEL
 - 16 OUNCE COPPER
 - 4 POUND LEAD
 11. IN ALL LOCATIONS WHERE SHINGLES CANNOT BE NAILED USE PLY GEM ROOFING "HIDDEN FASTENING ADHESIVE KIT."

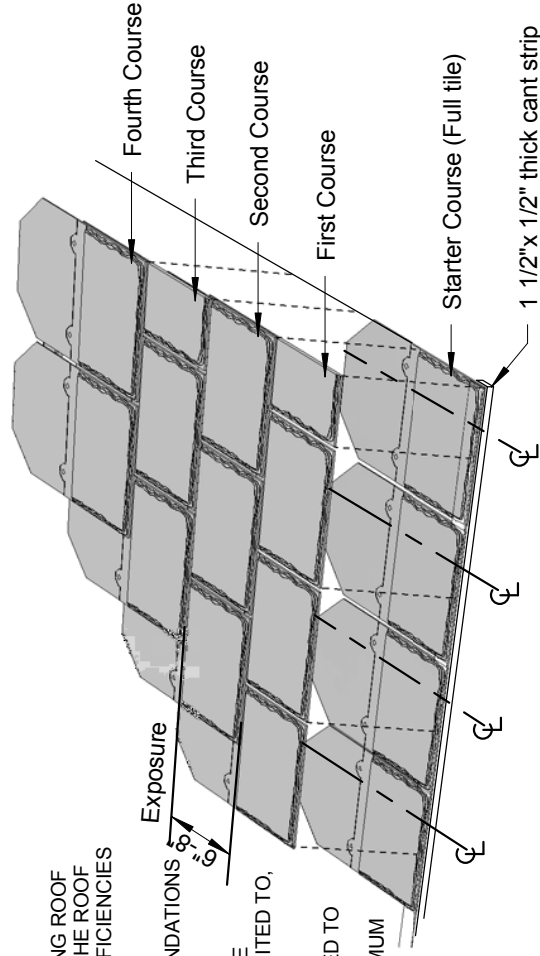
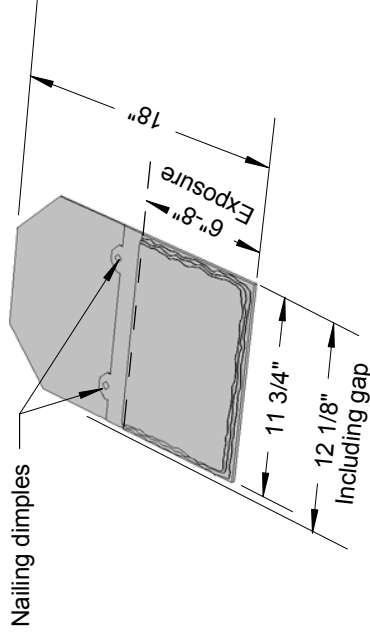

Engineered Slate Roofing

General Notes & Information

PLYGEM
ROOFING

ESR
0.2

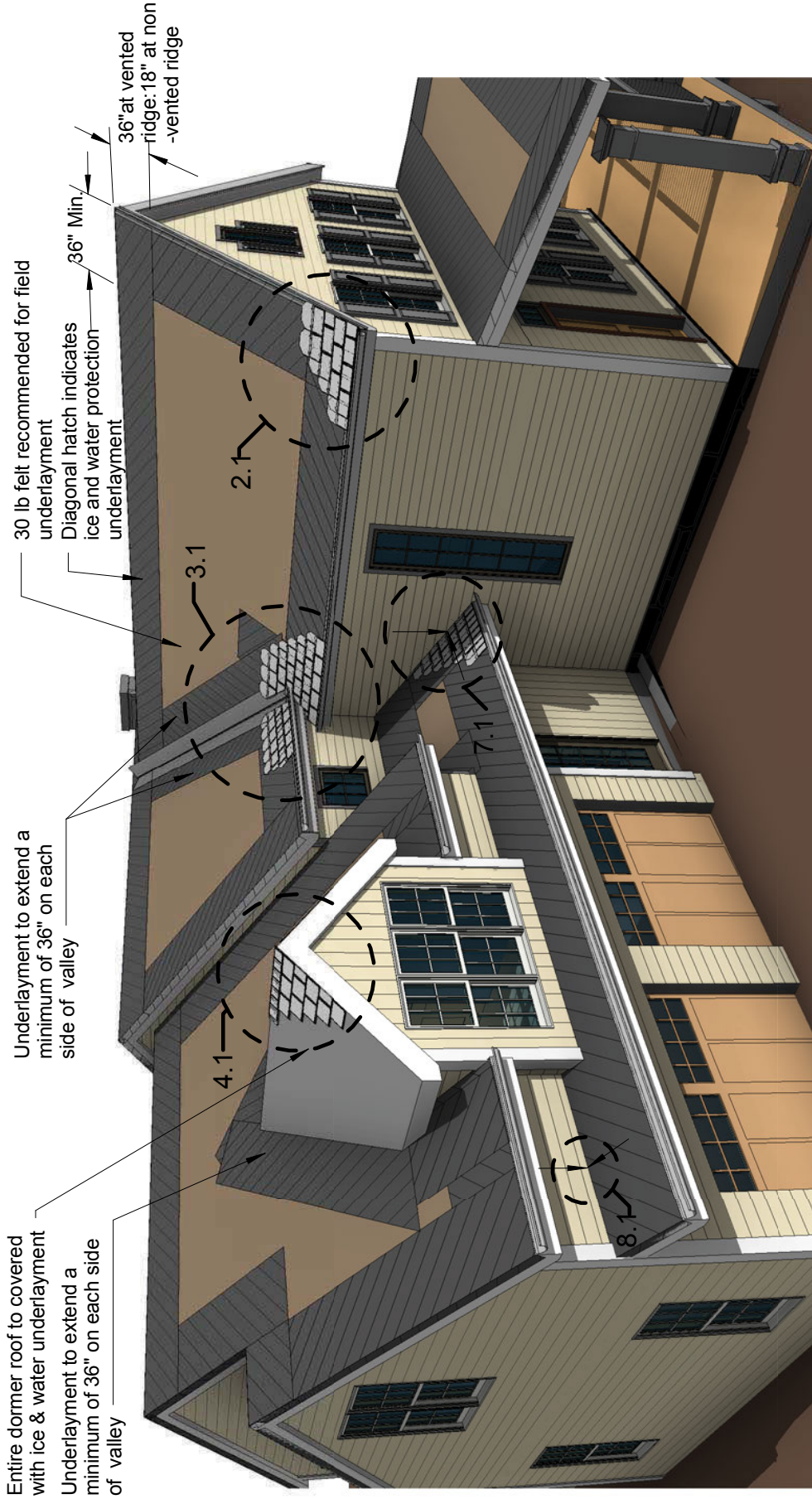

**Engineered Slate Roofing
Membrane Underlayment
& Key Diagram- 1**



ESR
1.1

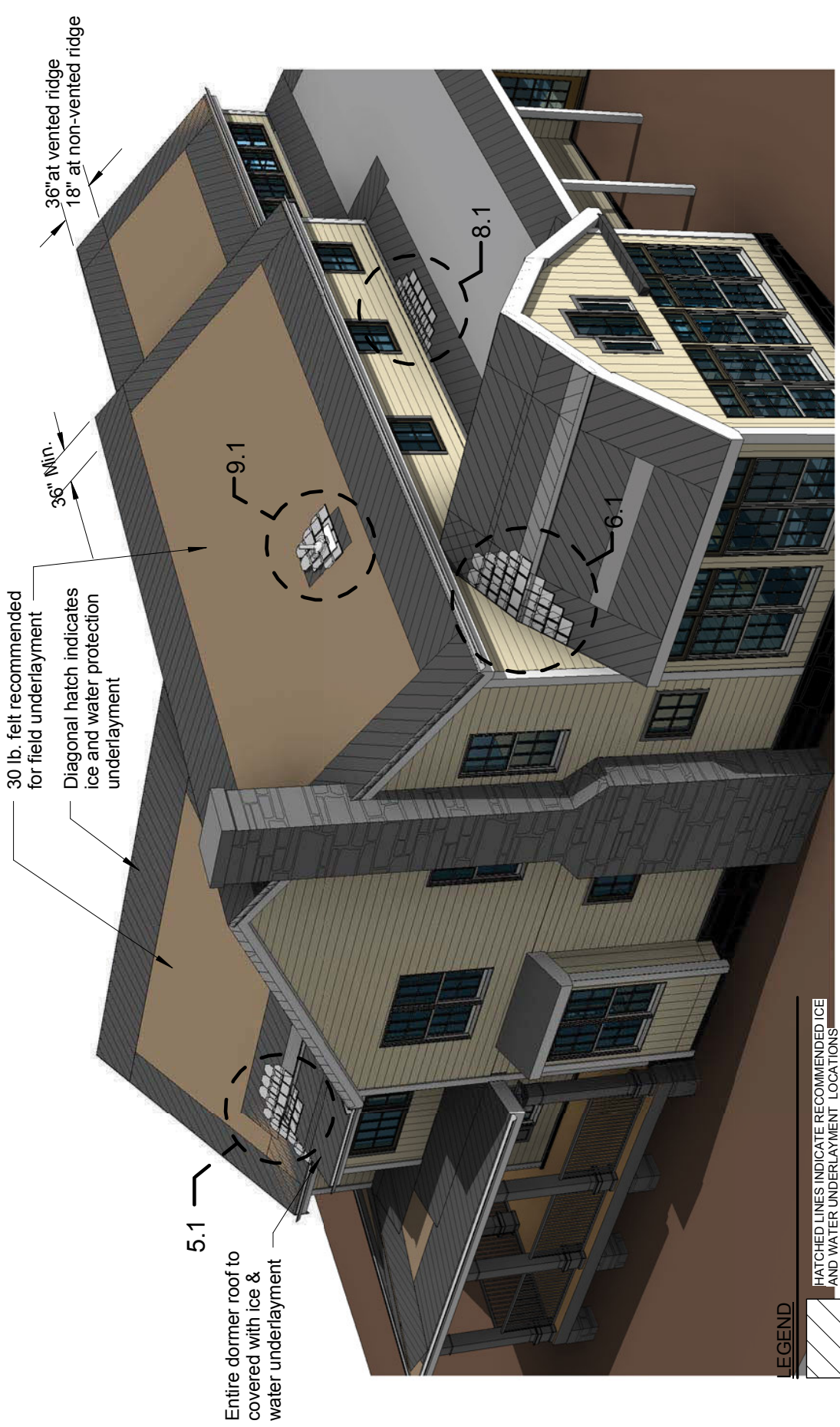

Engineered Slate Roofing
Membrane Underlayment
& Key Diagram- 2

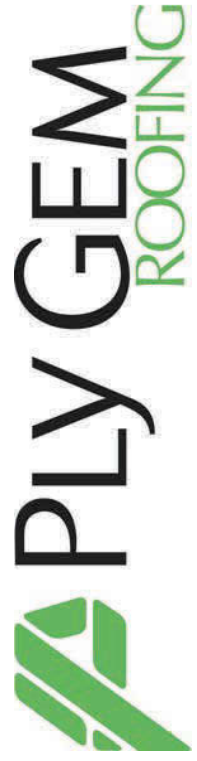

ESR
1.2

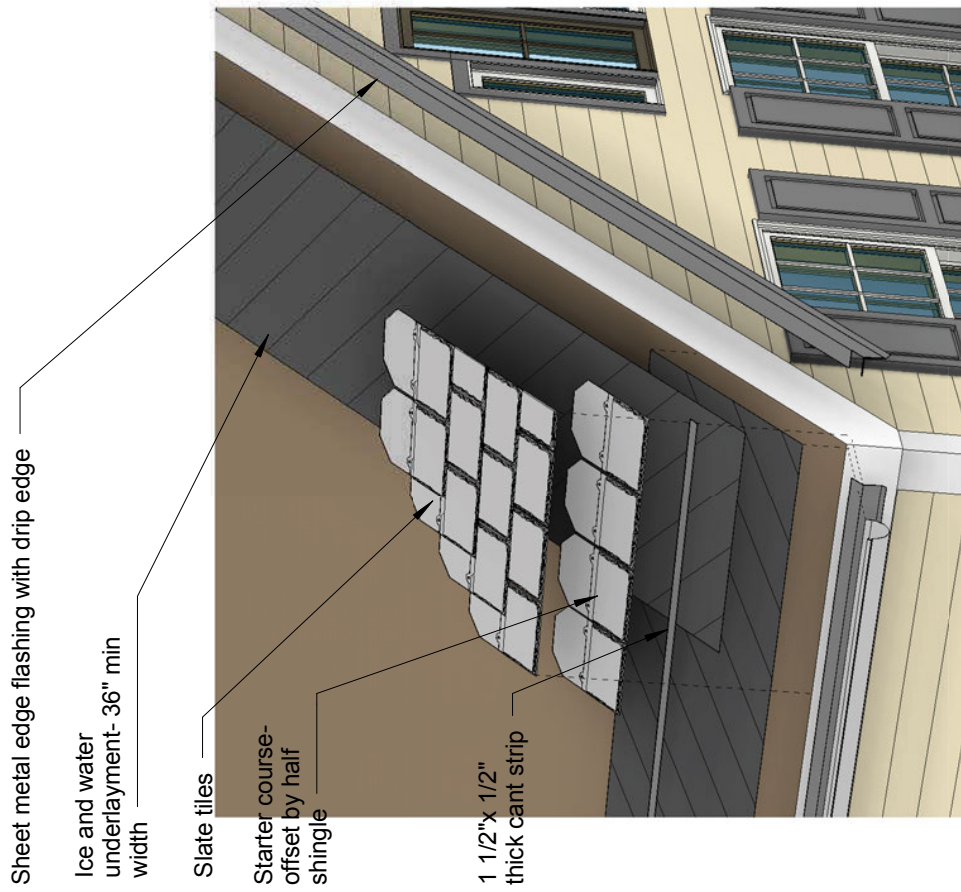

Displaced View

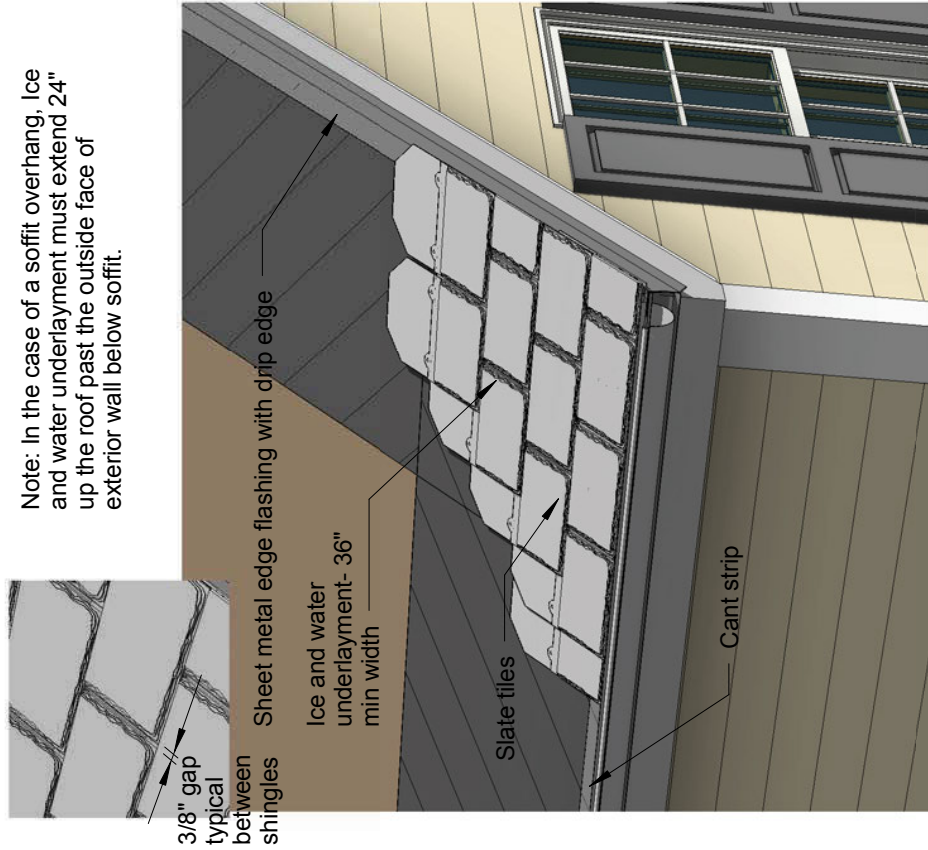

Finished View

Engineered Slate Roofing
Eave and Rake Edges- 3D

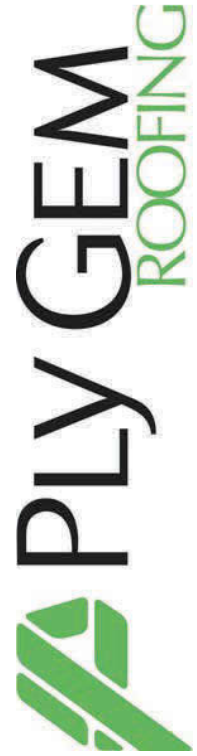

ESR
2.1



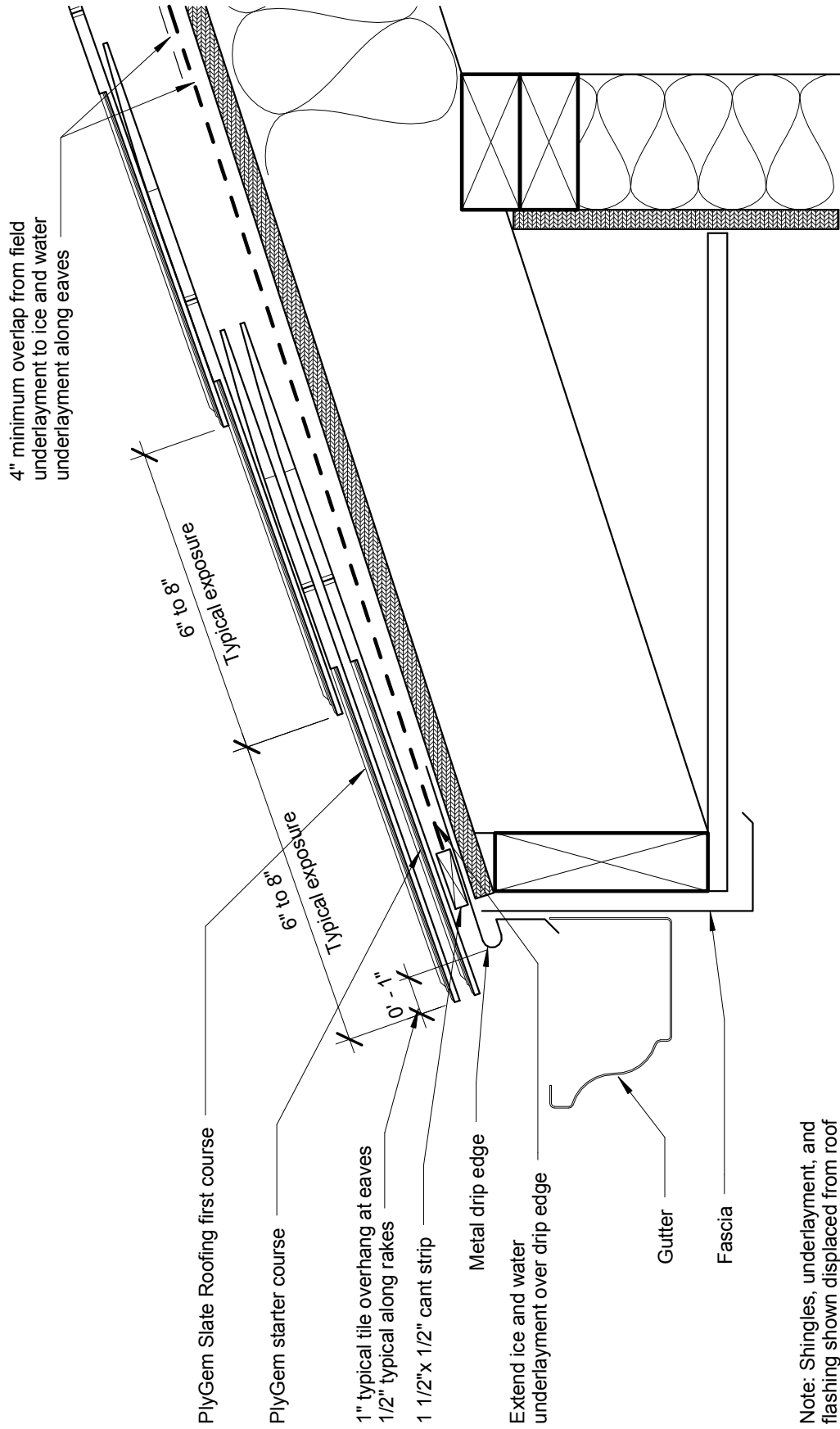

Note: Shingles, underlayment, and flashing shown displaced from roof sheathing for clarity

Engineered Slate Roofing Eave and Rake Edges- 2D

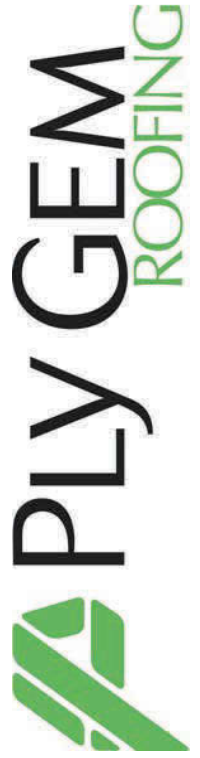

ESR
2.2

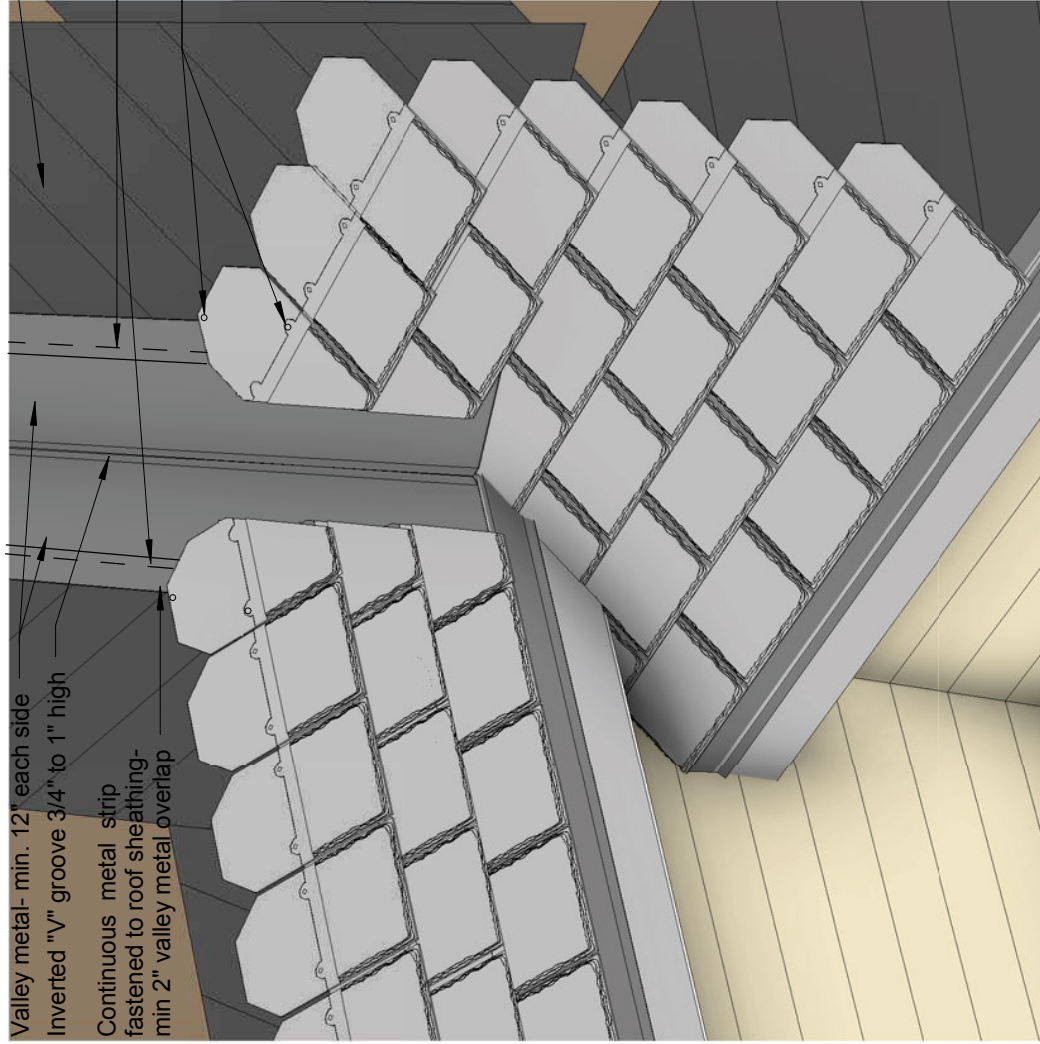

Valley metal- min. 12" each side
 Inverted "V" groove 3/4" to 1" high

Continuous metal strip
 fastened to roof sheathing-
 min 2" valley metal overlap

Ice and Water
 underlayment minimum
 36" each side of valley

Provide continuous bead
 of sealant each side

Provide a minimum of
 (2) nails per shingle
 that do not penetrate
 valley metal below

General Notes:

1. All roofing tiles should extend a minimum of 4" over the outer edge of the valley metal.
2. PlyGem would recommend valley metal to be anchored to roof sheathing with metal clips to allow for expansion and contraction.
3. Whenever possible valley should be covered with a single piece of continuous valley metal. When necessary a minimum of 12" overlap with a continuous bead of sealant under seam may be used.
4. Ice and water underlayment is recommended under all valley metal.
5. Recommended total width of metal valley flashing is 24". 12" minimum on each side of crease.
6. The open distance from the center of the valley crease to the shingle should taper 1/8" wider for every 8 feet from top of valley to bottom

Engineered Slate Roofing
Open Valley Detail - 3D



ESR
3.1

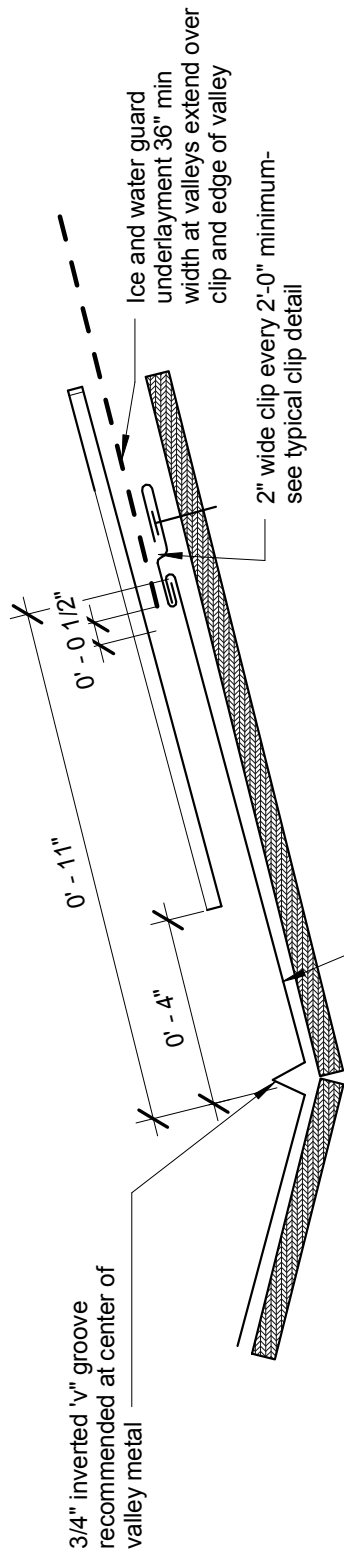

Cross-Section

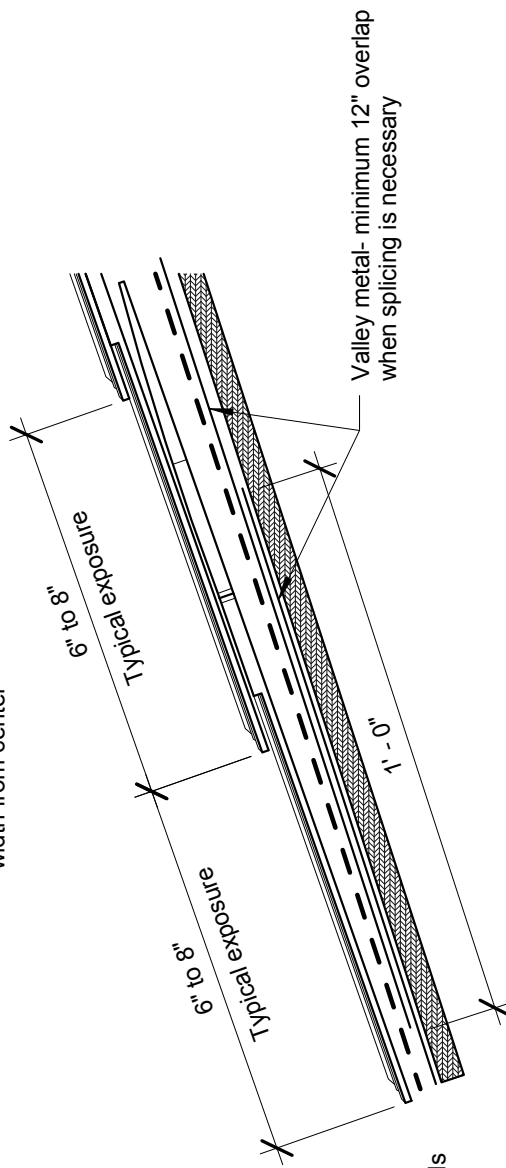

Typical Clip Detail

Section

Note: Shingles, underlayment, and flashing shown displaced from roof sheathing for clarity

Engineered Slate Roofing

Open Valley Detail- 2D

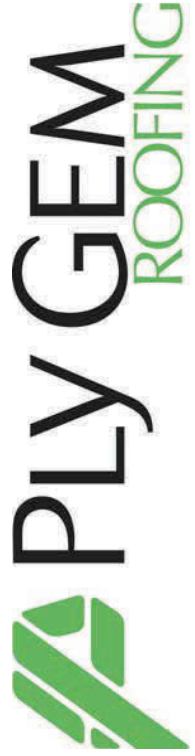

ESR

3.2

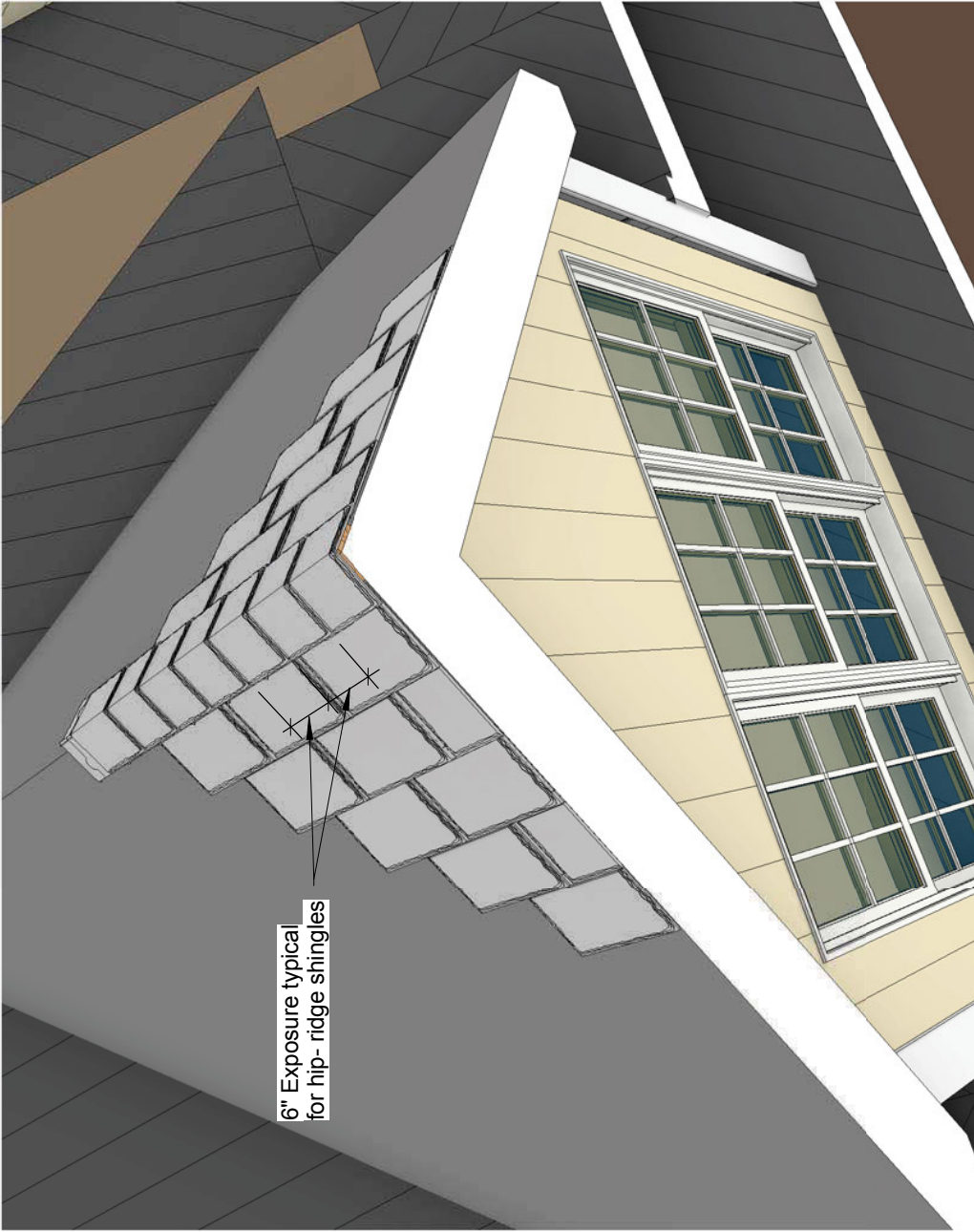

Notes:

1. Two nails minimum should be used for each hip-ridge tile, one tile goes on each side of the ridge. All nails should have a minimum 3/4" embedment into roof sheathing. In all locations where shingles cannot be nailed use Ply Gem Roofing "Hidden Fastening Adhesive Kit."

2. If ridge vent is to be installed below ridge tile, nails should be continuous through ridge vent into roof sheathing below.

Polyurethane sealant along ridge joints

Weave overlap of every other ridge tile

Wood nailer along ridge

Metal ridge flashing

Wrap underlayment over ridge with out vent

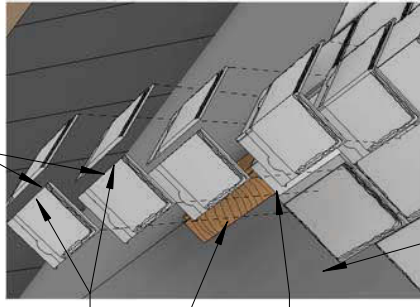

LEGEND



HATCHED LINES INDICATE RECOMMENDED ICE AND WATER UNDERLAYMENT LOCATIONS

**Engineered Slate Roofing
Ridge & Hip Details- 3D**



**ESR
4.1**

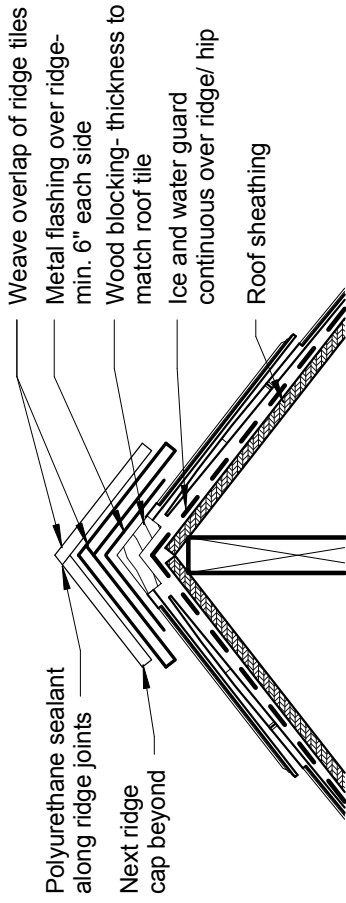

Hip detail

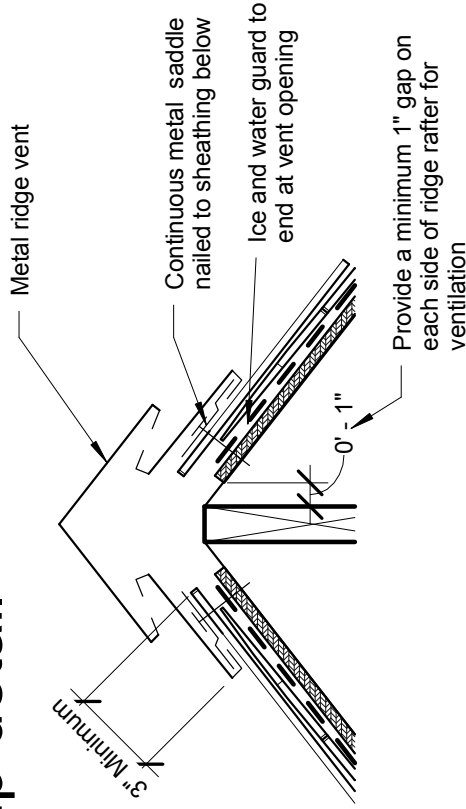

Note: Shingles, underlayment, and flashing shown displaced from roof sheathing for clarity

Note: In all locations where shingles cannot be nailed use Ply Gem Roofing "Hidden Fastening Adhesive Kit."

With metal ridge vent cap

Engineered Slate Roofing
Ridge & Hip Details- 2D



ESR
4.2

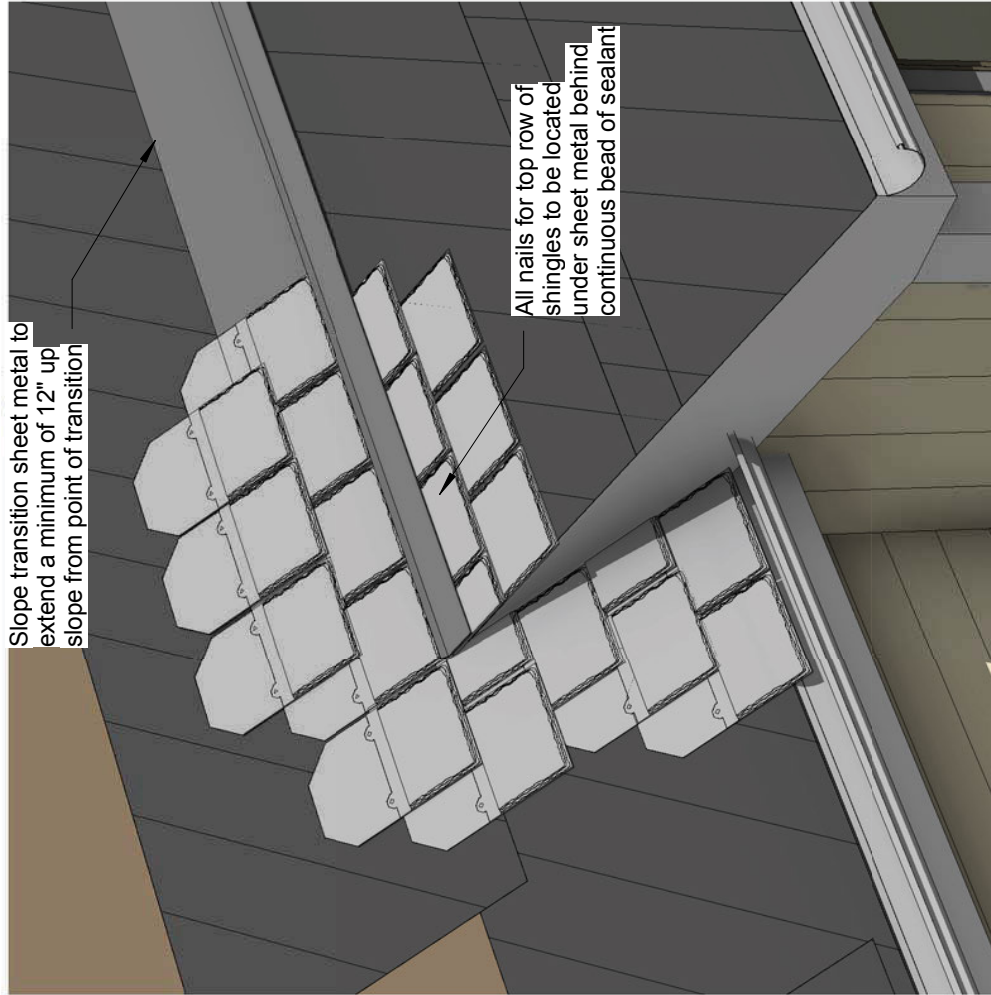

LEGEND

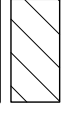

HATCHED LINES INDICATE RECOMMENDED ICE AND WATER UNDERLAYMENT LOCATIONS

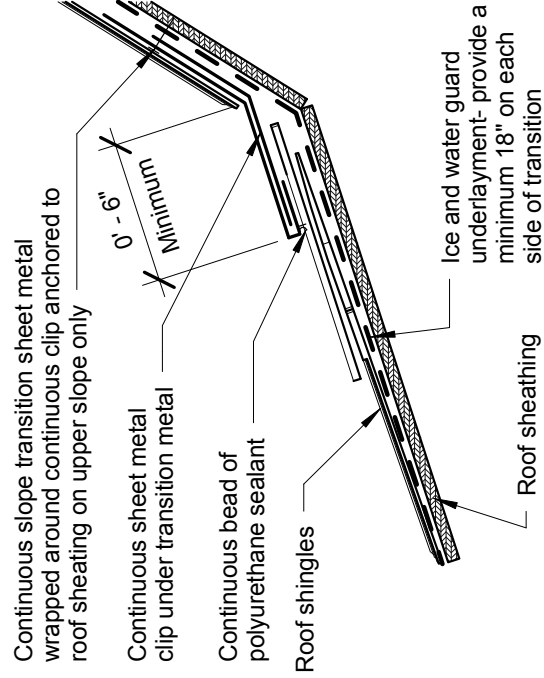

**Engineered Slate Roofing
Valley Roof Transition
Details**



ESR
5.1

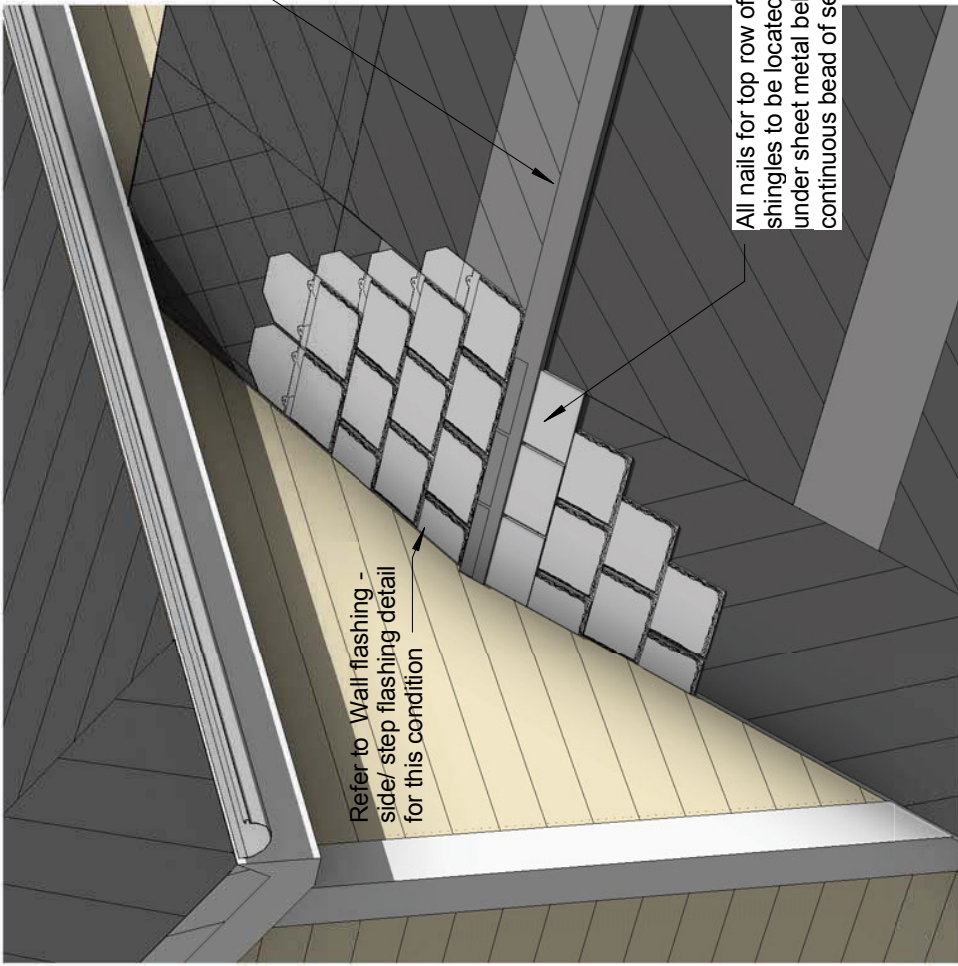

LEGEND

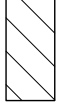

HATCHED LINES INDICATE RECOMMENDED ICE AND WATER UNDERLAYMENT LOCATIONS

Slope transition sheet metal to extend a minimum of 12" up slope from point of transition

Continuous slope transition sheet metal wrapped around continuous clip anchored to roof sheathing on upper slope only

Continuous sheet metal clip under transition metal

Continuous bead of sealant

Roof shingles

All nails for top row of shingles to be located under sheet metal behind continuous bead of sealant

Ice and water guard underlayment- provide a minimum 18" on each side of transition

Roof sheathing

0'-4"

**Engineered Slate Roofing
Hip Roof Transition Details**



ESR
6.1

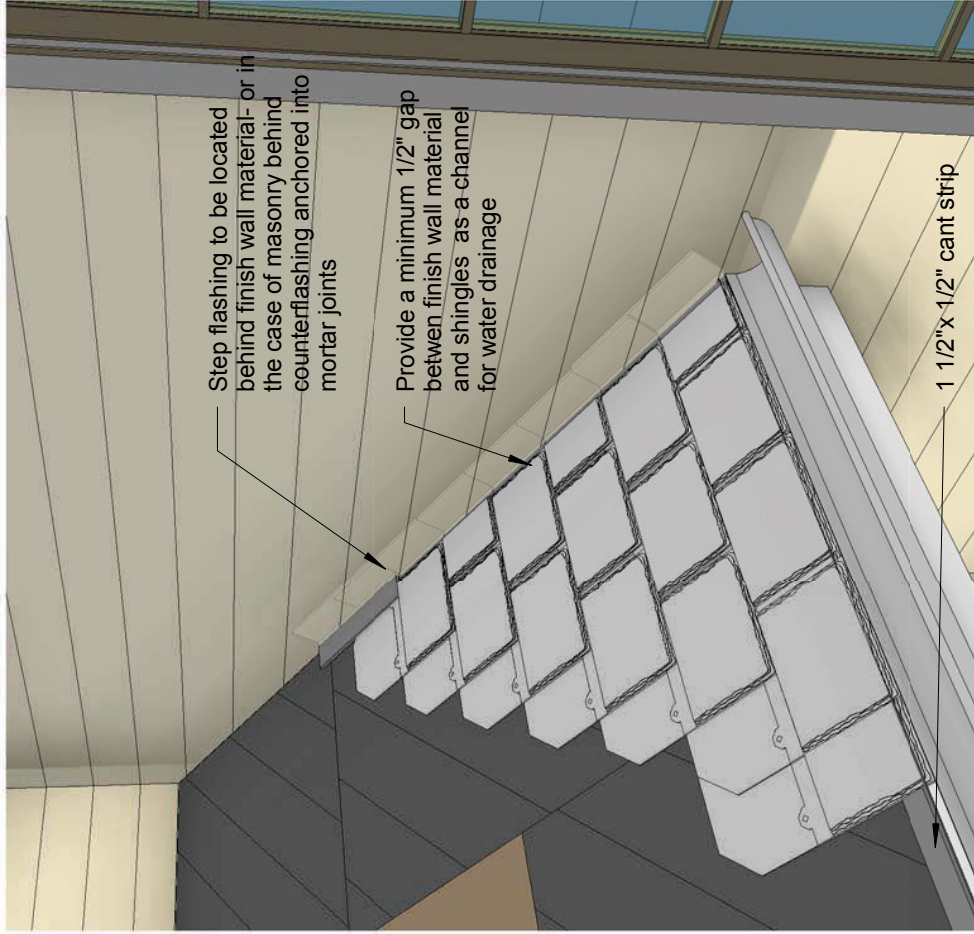

Finished View

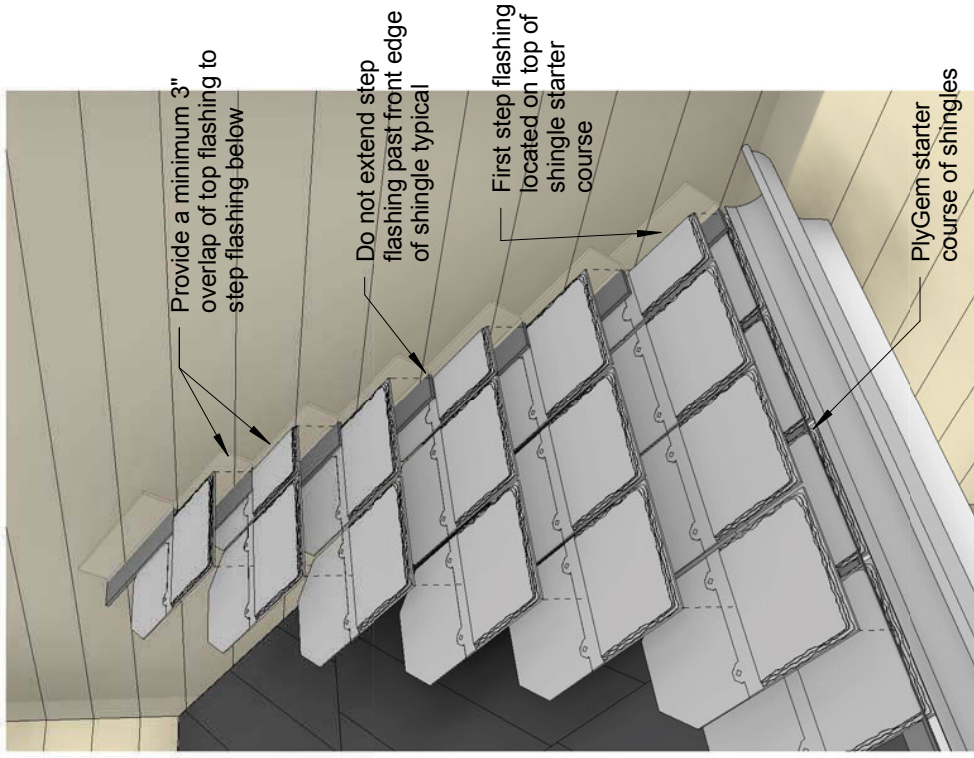

Displaced View

Engineered Slate Roofing
 Wall Flashing - Side/Step
 Flashing- 3D



ESR
 7.1

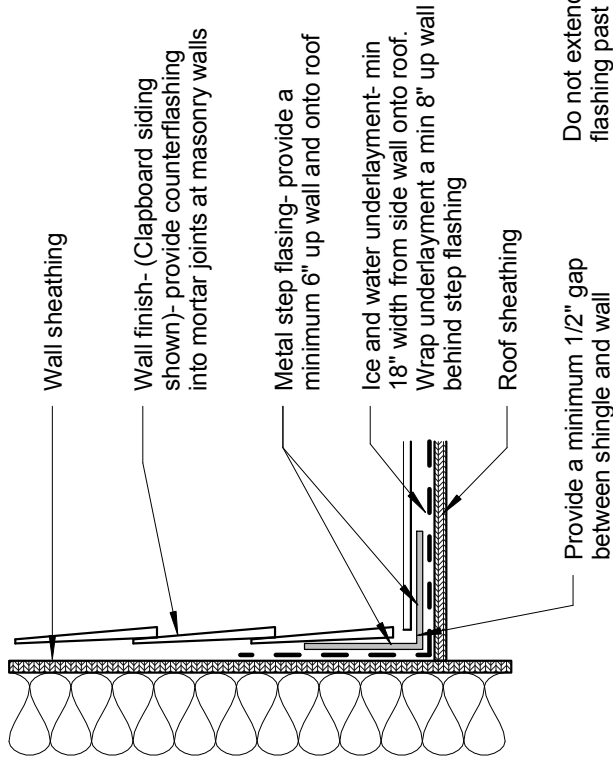

Note: Shingles and flashing shown displaced from roof and wall sheathing for clarity

Metal step flashing- provide a minimum 3" overlap of top flashing to bottom flashing

Do not extend flashing past bottom edge of shingle

Ice and water underlayment- min 18" width from side wall onto roof. Wrap underlayment a min 8" up wall behind step flashing

Roof sheathing

Note: Shingles and flashing shown displaced from roof sheathing for clarity

Engineered Slate Roofing

Wall Flashing - Side/ Step Flashing- 2D



ESR
7.2

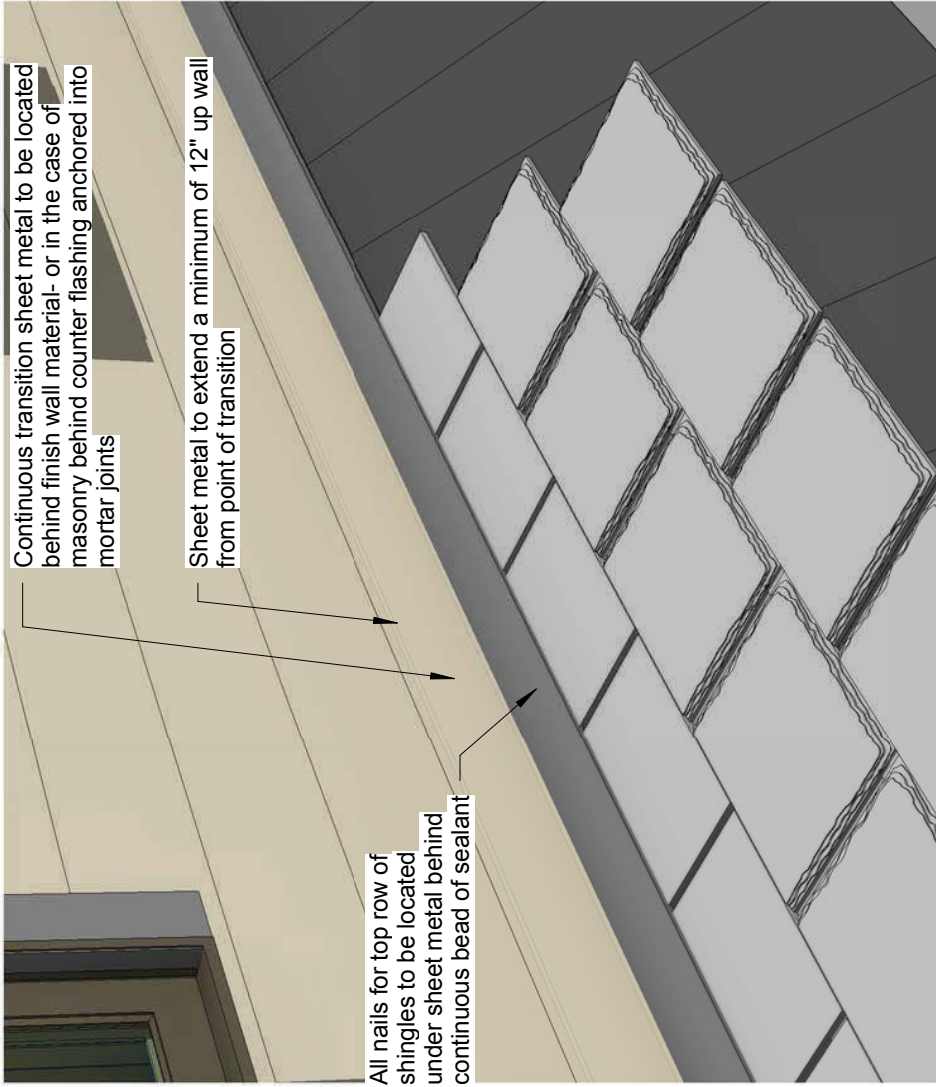

LEGEND

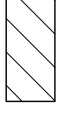

HATCHED LINES INDICATE RECOMMENDED ICE AND WATER UNDERLAYMENT LOCATIONS

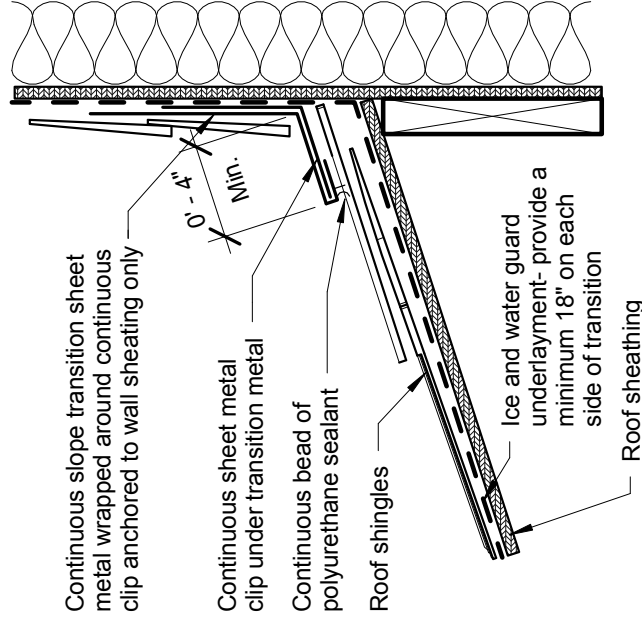

Engineered Slate Roofing
Wall Flashing - Top/
Counter Flashing Details



ESR
8.1

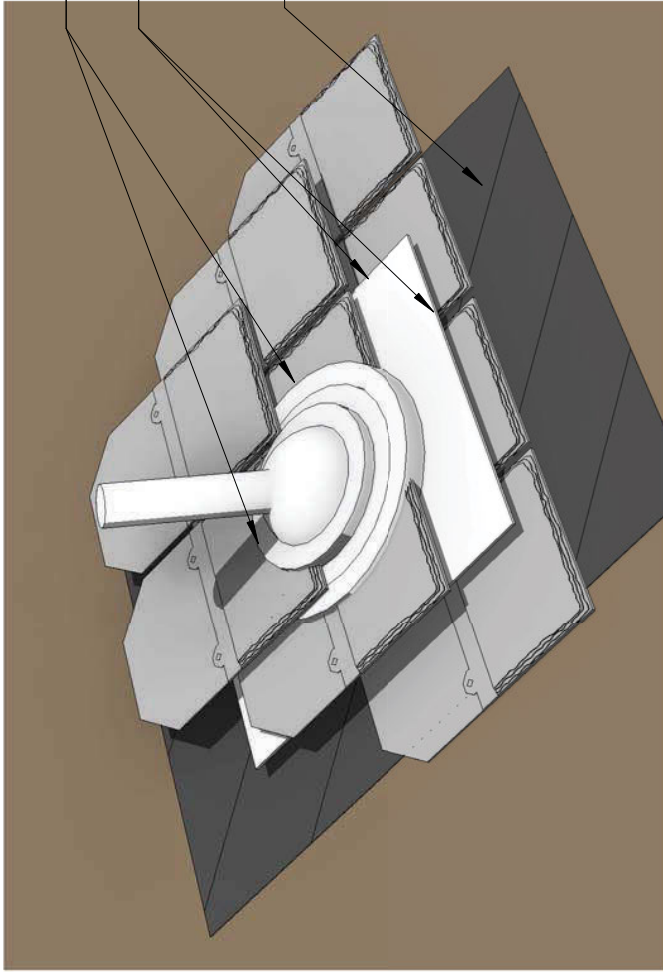

Note: In all locations where shingles cannot be nailed use Ply Gem Roofing "Hidden Fastening Adhesive Kit."

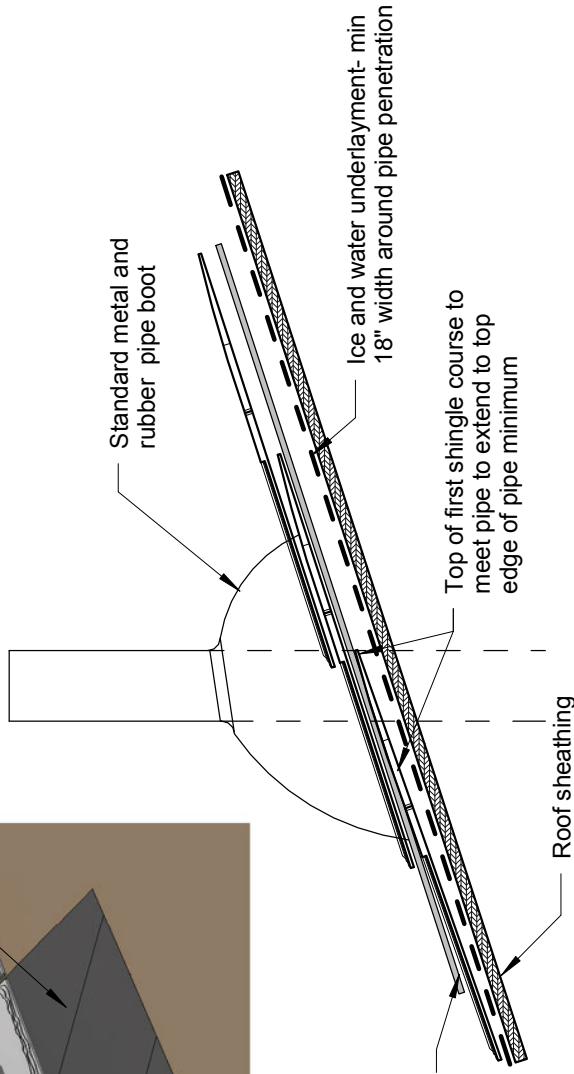

Note: Shingles and flashing shown displaced from roof sheathing for clarity

Engineered Slate Roofing

Roof Pipe Penetration Details



ESR
9.1

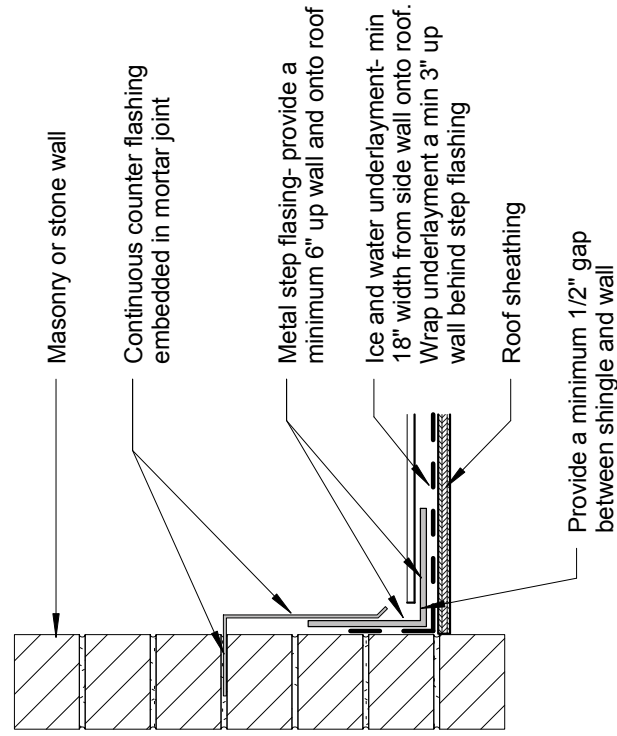

Note: Shingles and flashing shown displaced from roof and wall sheathing for clarity

Counterflashing detail

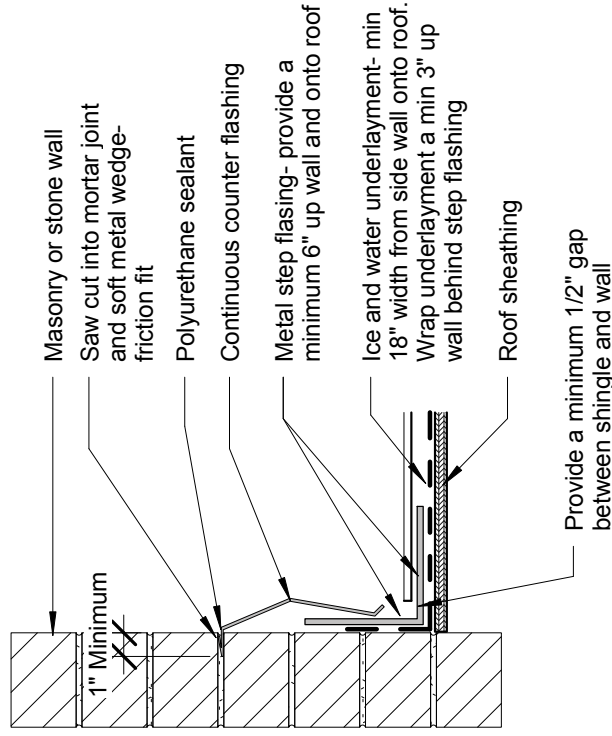

Optional saw cut

Engineered Slate Roofing
Counterflashing at
Masonry



ESR
10.1

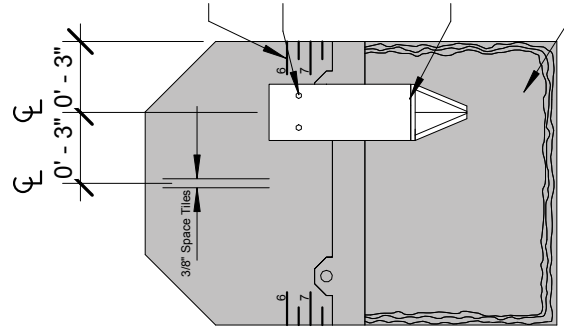
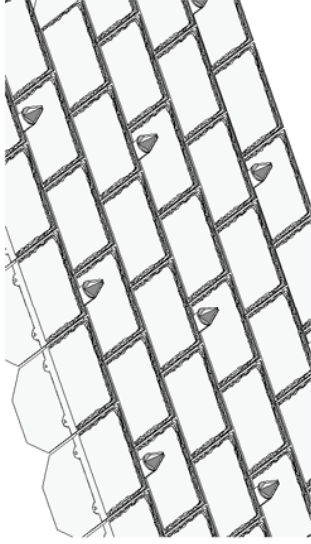
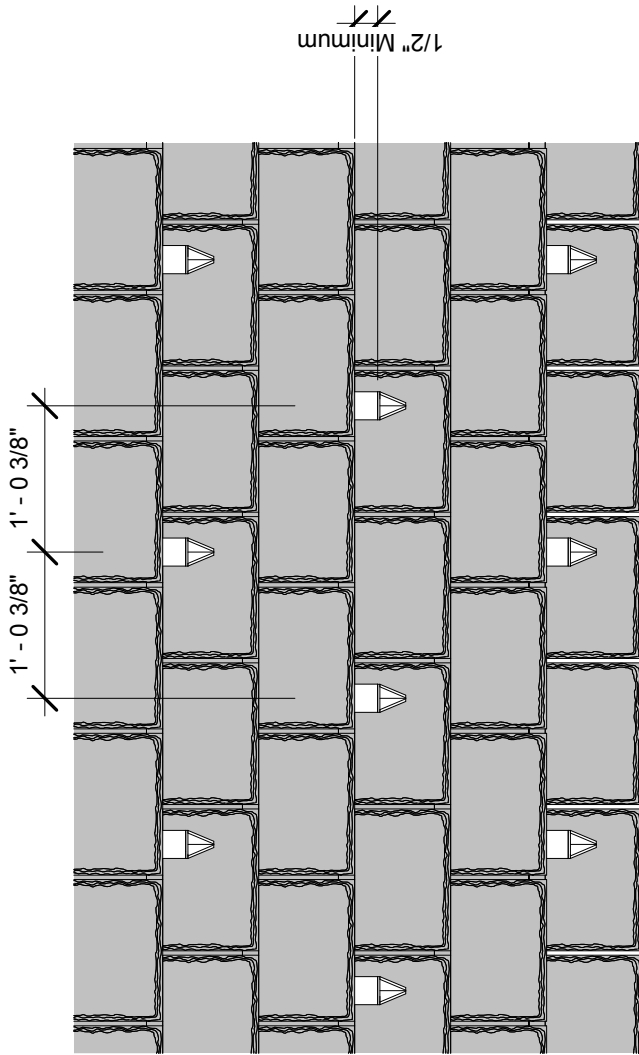

Locate snow guard fasteners between 6" and 7" tile markers

Fasten snow guard with (2) 2" nails. Head of nail must be flush with top of snow guard to avoid protrusion under tile

Vertical surface of bracket to be a minimum distance of 1/2" from next row of roof tiles

PlyGem roof tile

Guard position on roof tile

Typical guard layout

- Notes:
1. Provide snow guard fasteners in accordance with snow guard manufacturer's recommendations. Refer to manufacturer's attachment recommendations for coastal regions.
 2. Vertical bracket surface must be a minimum of 1/2" below bottom edge of the next row of roof tiles, while the guard attachment must be made between the 6" and 7" tile markers. Snow guards must be long enough to accommodate this requirement.
 3. Each row of snow guards to be offset 1' - 0 3/8" from previous row of guards.
 4. Location and number of snow guards per guard manufacturer's recommendations.

Engineered Slate Roofing
Pad Style Snow Guards



ESR
11.1

Notes



Notes





The Ply Gem Difference

When you choose building products for your home, you want them to last. Just as important, you want the company that stands behind those products to be there when you need them. As North America's leader in low maintenance exteriors, you can choose Ply Gem with confidence. Every product we make meets strict quality standards and is backed by a comprehensive warranty. Builders, remodelers and homeowners have put their trust in us for over 70 years. Experience the Ply Gem difference. Build peace of mind with us.

MADE IN THE USA | 1.844.679.3745 | PLYGEMROOFING.COM

Ply Gem Roofing, the Ply Gem Roofing logo, Ply Gem, the Ply Gem logo, the "Building Products. Building Success." slogan, are all trademarks of Ply Gem Industries, Inc. ("Ply Gem") or an affiliated company of Ply Gem.
 © 2014 Ply Gem Industries, Inc. BT/CG/0414