

COMPANION[®]

LIQUID OXYGEN SYSTEMS

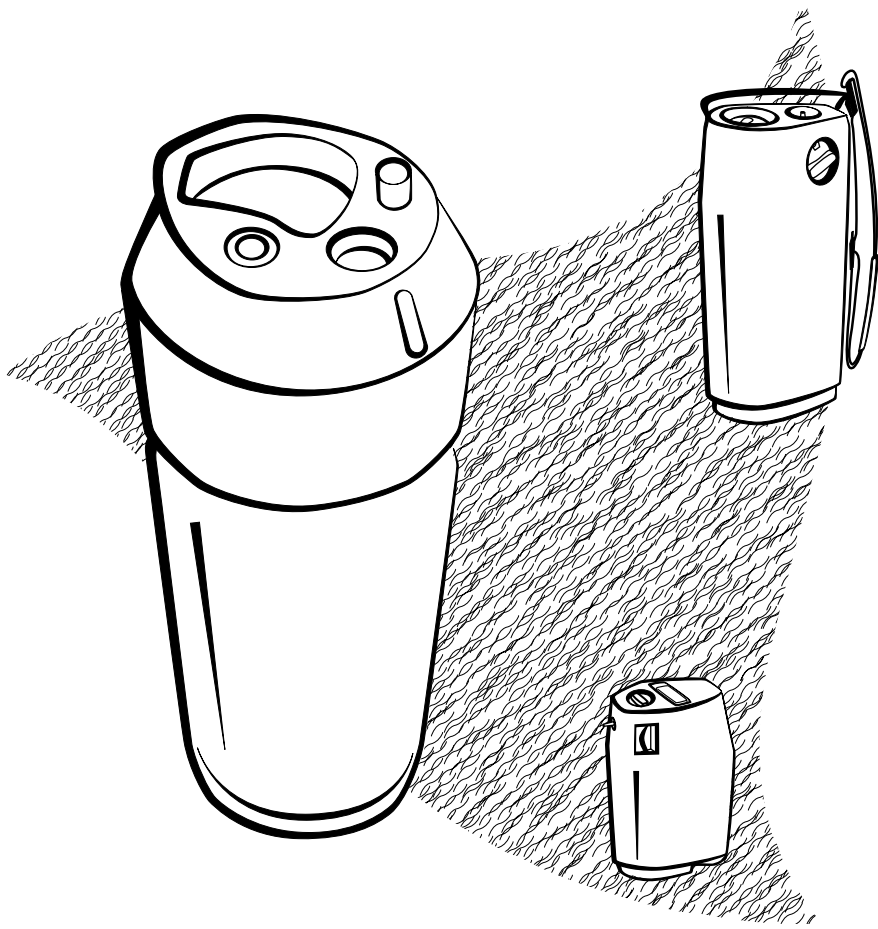

Federal (U.S.) law restricts these devices to sale by or on the order of a physician.

Companion Liquid Oxygen Systems

TABLE OF CONTENTS

General Safety Precautions	1
Companion Liquid Oxygen Systems	4
Stationary Units	4
Portable Units	5
Companion Stationary Units.....	6
Stationary Unit Components.....	6
Using the Stationary Units.....	8
Companion Portable Units.....	11
Companion 1000/1000 Transport Unit Components.....	11
Companion 500/550 Unit Components	13
Companion 550 Portable Unit Components ONLY	14
Filling the Portable Units.....	15
For Companion 550 Only.....	21
Using the Portable Units.....	22
Cleaning and Maintenance.....	23

IMPORTANT NOTICE

Be sure to read and understand this instruction manual completely before attempting to operate your Companion[®] Liquid Oxygen system. Do not permit anyone who has not read these instructions to handle or operate this equipment.

The Companion Liquid Oxygen systems are intended only for the delivery of medical grade oxygen as prescribed by your physician.

WARNING



Oxygen supplied from this equipment is for supplemental use and is not intended to be life supporting or life sustaining. This equipment is not intended for use by patients who would suffer immediate, permanent, or serious health consequences as a result of an interruption in their oxygen supply.

This manual is provided to assist in the safe operation of the Companion Liquid Oxygen system and to ensure maximum benefit from its use. If you have any questions about the operation of the equipment, please consult your liquid oxygen supplier.

Companion is a registered trademark of CAIRE Inc.
Velco is a registered trademark of Crown Packaging.

©2009 CAIRE Inc. All rights reserved.
Printed in the U.S.A.

General Safety Precautions

Throughout this manual you will see three kinds of special information: warnings, cautions, and notes. Make sure you carefully read and understand this information. Each is important and related to the surrounding text.

WARNING



A warning identifies a hazard and is boxed in and accompanied by a symbol. Warnings describe conditions that concern your personal safety and the safety of others. They are followed by the actions required to prevent injury. Ignoring warnings can lead to injury or death.

CAUTION



A caution informs you about possible damage to the equipment or other property. Ignoring cautions may cause damage to the equipment or make it unusable.



Note: *Notes are italicized and provide important information about using the equipment properly.*

WARNING



Do not smoke near this equipment. Keep cigarettes or burning tobacco away from the area where equipment is operated.



Keep flammable materials away from this equipment. Oils and grease, including facial creams and petroleum jelly, ignite easily and may burn rapidly in the presence of oxygen. Never lubricate any part of this equipment.



Do not touch liquid oxygen or parts that have been in contact with liquid oxygen. Liquid oxygen is extremely cold (-297°F / -183°C). When touched, liquid oxygen, or parts of the equipment that have been carrying liquid oxygen, can freeze skin and body tissue.



Increased fire risk. High concentrations of oxygen can cause rapid burning of other substances.



Keep and use this equipment in an upright position at all times. If the Stationary or Portable unit is turned over, gaseous or liquid oxygen will escape. Should a liquid spill occur, ventilate the area by opening doors and windows and call your liquid oxygen supplier immediately. Restore your Portable to the upright position, avoiding contact with cold parts. Do not attempt to upright an overturned Stationary unit.

WARNING



Keep this equipment away from electrical appliances. Use and store Stationary and Portable units at least five feet from electrical appliances that may cause heat or sparks.



Keep oxygen equipment away from open flames. Equipment such as furnaces, water heaters, and stoves may contain open flames.



Keep equipment in a well-ventilated area at all times. These units periodically release small amounts of oxygen gas that must be ventilated to prevent buildup. Do not store liquid oxygen equipment in a closet, car trunk, or other confined area. Do not place blankets, draperies, or other fabrics over equipment.



Do not carry the Portable unit under your clothing. These units normally vent oxygen. Wearing a Portable unit under clothing may saturate fabrics with oxygen and cause them to burn rapidly if exposed to sparks or flame. It may take several hours for oxygen levels in fabric to return to normal.



Never tamper with the equipment. Doing so could create a hazardous condition and possibly cause the equipment to work improperly.



Name and address of manufacturer



Authorized representative in the European Community

COMPANION LIQUID OXYGEN SYSTEMS

The Companion Liquid Oxygen System is designed to store and deliver oxygen at a prescribed rate. The system consists of two units: the Stationary and the Portable.

Stationary Units

Each Stationary is a liquid oxygen reservoir you may use to fill your Portable unit. There are two basic types of Stationary units: a standard unit that you may use to supply breathing oxygen in the home (including Companion 21, Companion 31, and Companion 41); and a Low Loss unit (Companion 31LL) that allows liquid oxygen to be held for much longer periods of time than a standard Stationary unit but does **NOT** provide a direct source of oxygen for breathing purposes.

Your liquid oxygen supplier must periodically refill your Stationary unit. The frequency of refill will depend upon your rate of oxygen use.

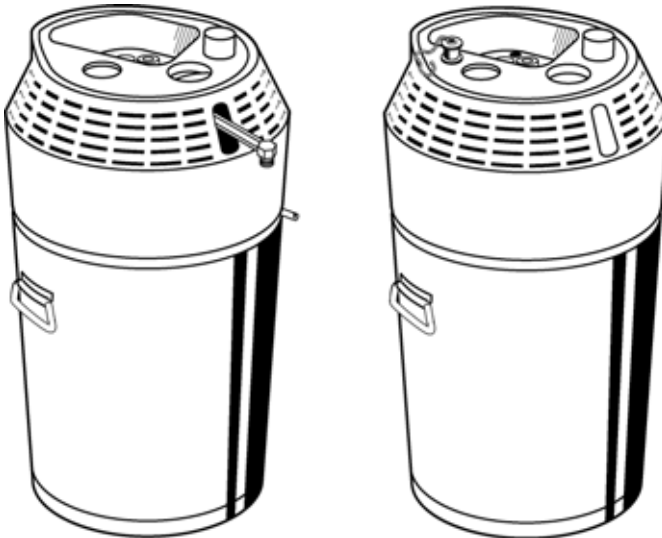

Standard Unit

Low Loss Unit

Figure 1: Companion Stationary

Portable Units:

The Companion Portable is a compact, lightweight device that provides you with a portable supply of oxygen. You will fill the Portable from the Companion Stationary unit.

Portable units include the Companion 1000 (a one-liter model with a maximum flow rate of 6 liters per minute [L/min]) and the Companion 1000 Transport (a one-liter model with a maximum flow rate of 15 L/min).

Smaller portable units include the Companion 500 (a half-liter model) and the Companion 550 (a half-liter model with a pneumatic demand valve that can roughly double your available use time by allowing oxygen to flow only when you breathe in).

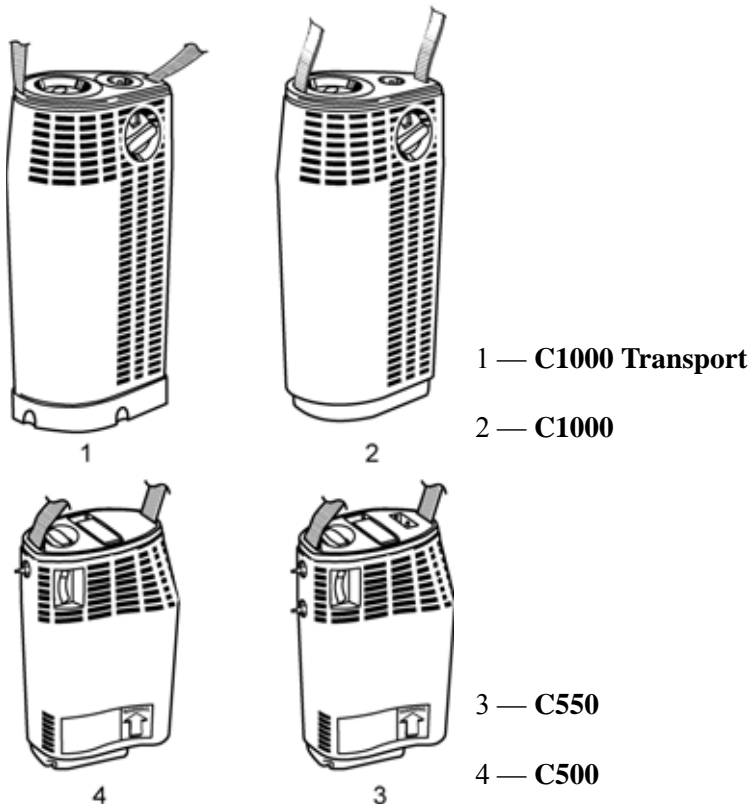

Figure 2: Companion Portable Units

COMPANION STATIONARY UNIT

Stationary Unit Components

Become familiar with the various parts of the Stationary unit shown in Figure 3, Figure 4, and Figure 5.

- **Contents Indicator:** (optional) displays the amount of liquid oxygen remaining in the Stationary unit. The contents indicator is visible through the top of the unit.
- **Pressure Gauge:** (optional) indicates the status of the pressure inside the Stationary unit. The Stationary is at an acceptable pressure when the needle is in the shaded region.
- **Flow Control Knob:** (except Low Loss) adjusts oxygen flow from the breathing oxygen supply. Set the flow control knob to the oxygen flow rate prescribed by your physician.



Note: Set the flow control to “0” to turn the unit off.

- **Breathing Oxygen Supply:** (except Low Loss) this is where you attach a cannula or other type of breathing device for breathing directly from the Stationary unit. You may also attach a bubble-type humidifier to this connection before connecting the supply tubing.

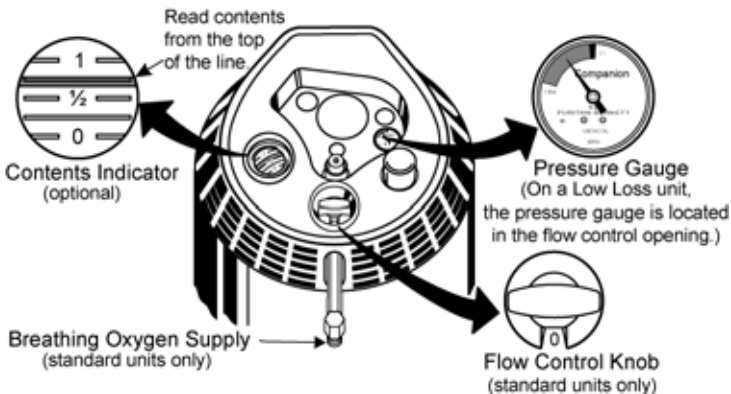

Figure 3: Stationary Unit Components

- **Fill Connector:** located in the top center of the Stationary unit. When filling a Portable, attach the female fill connector in the bottom of the Portable (Figure 8 and Figure 10) to the male fill connector on the Stationary.



Note: *On Dual-Fill Stationary units, a second connector on the side of the unit allows you to fill a side-fill type Portable unit. Follow the Portable unit manufacturer's instructions for filling this type of equipment.*

- **Fill Connector Cover:** (optional on standard units) protects the top fill connector when not in use. Always replace the fill connector cover, if present, after filling your Portable unit.

WARNING



Extreme cold hazard. Do not press or disturb the fill connector poppet (Figure 4). This can cause a release of liquid oxygen from the fill connector.



- **Portable Release Button:** used to remove bottom-fill type Portable units from a Stationary unit after completing a fill.

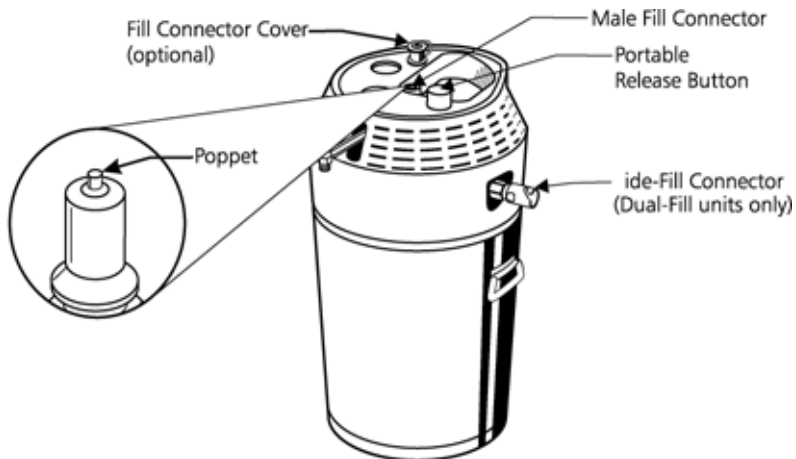

Figure 4: Stationary Components

Using the Stationary Unit

Your liquid oxygen supplier will deliver a filled Stationary unit to you and then refill or exchange your unit as required by your individual usage. You may then use the Stationary unit to fill your Portable oxygen unit. For filling procedures, see “Filling the Portable” (page 15).

You can use the Companion Stationary directly as a source of breathing oxygen (except for Companion Low Loss units). For this application, connect a humidifier (optional) and a nasal cannula or other breathing device directly to the Stationary’s breathing oxygen supply outlet as follows:

1. If a humidifier is used, fill it with distilled water to the level indicated in the humidifier’s instructions. Attach the humidifier to the breathing oxygen supply fitting on the Stationary unit (Figure 5).

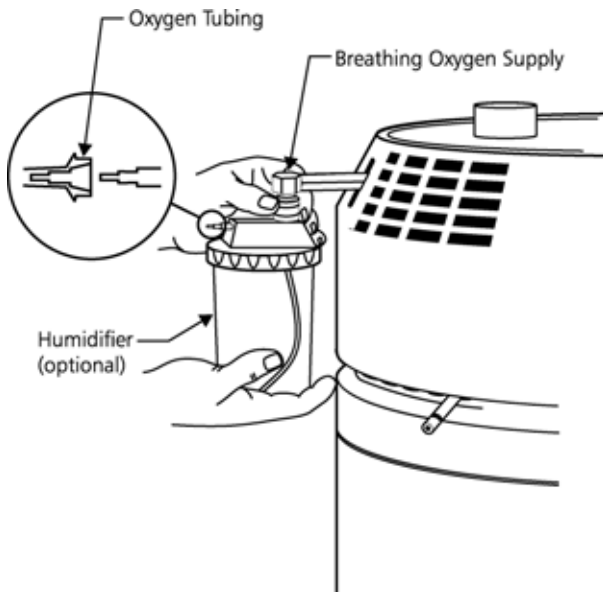
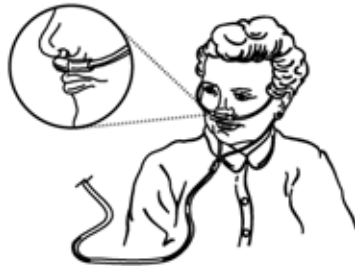

Figure 5: Preparing the Stationary Unit for Breathing

2. Attach the oxygen tubing from the cannula to the breathing oxygen supply connection or to the humidifier connection, as appropriate. Adjust the cannula to your face (Figure 6).



Standard Cannula Position
(Front View)



Standard Cannula Position
(Side View)



Alternate Cannula Position
(Side View)

Figure 6: Attaching a Nasal Cannula

3. Turn the flow control knob on the top of the Stationary to the setting prescribed by your physician.



Note: Use only marked settings; oxygen will not flow if the control is set between flow settings. If you use a humidifier, check for a steady stream of bubbles. This indicates that oxygen is flowing.

4. The contents indicator will show approximately how much liquid oxygen remains in the unit. To ensure you have enough oxygen to meet your needs, check the indicator periodically.
5. During use, moisture will condense on the internal parts of the unit. There are two styles of drain bottles designed to collect this moisture (Figure 7). As needed, remove the drain bottle from the spout, discard the water, and reattach the bottle to the side of your Stationary unit.

This style of drain bottle hangs directly from the drip tube. Gently lift and remove the bottle from the drip tube.

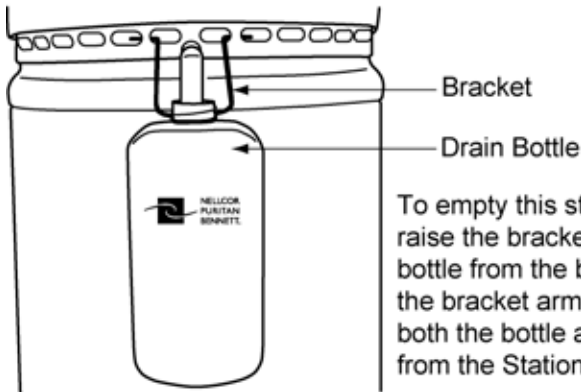
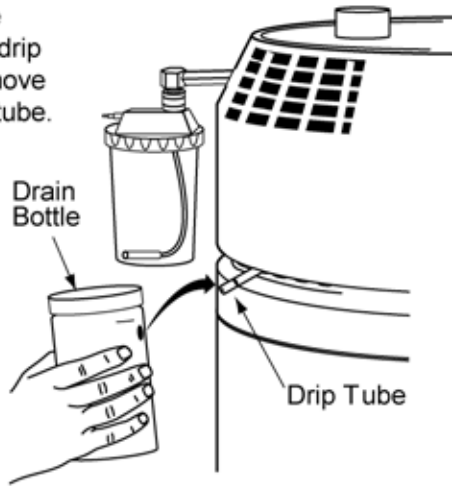

To empty this style of drain bottle, raise the bracket and remove the bottle from the bracket or pinch the bracket arms together to pull both the bottle and bracket away from the Stationary unit

Figure 7: Drain Bottle Attachment

COMPANION PORTABLE UNITS

C1000/C1000 Transport Unit Components

Become familiar with the various parts of the unit described below and shown in Figure 8 and Figure 9.

- **Vent Valve:** used to fill the unit. Pull down the vent valve lever to fill the Portable when it is connected to a Stationary unit. Return the vent valve lever to its original position to stop the fill.
- **Fill Connector:** used to connect to a Stationary unit. The female fill connector is located on the bottom of the Portable.

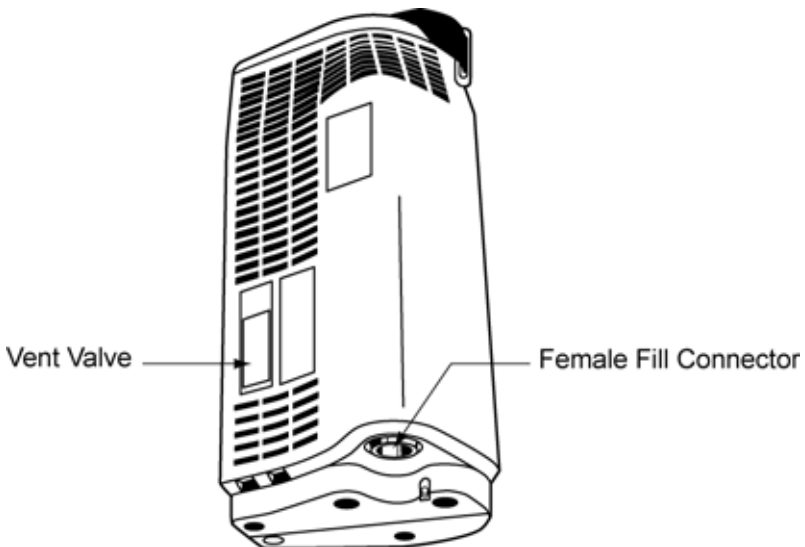

Figure 8: C1000/C1000 Transport Portable Unit Components

See Figure 9 for the following items:

- **Flow Control Knob:** used to set the correct oxygen flow to your prescribed rate.

- **Contents Indicator:** located on top of the Portable. Unsnap the plastic buckle and lift the unit by the end of the carrying strap that is closest to the indicator. The pointer indicates approximately how much oxygen remains in the unit.
- **Oxygen Outlet:** the connection point for the cannula that delivers oxygen for breathing.
- **Moisture Cup and Pad:** (Companion 1000 Transport only) helps contain moisture that forms when liquid oxygen is warmed to a gaseous state.
- **Carrying Strap:** an adjustable strap that enables you to wear the unit over the shoulder. You may also engage the plastic buckle in the carrying strap to create a short carrying handle. Use the strap to measure the contents of the Companion 1000/1000 Transport (see contents indicator).

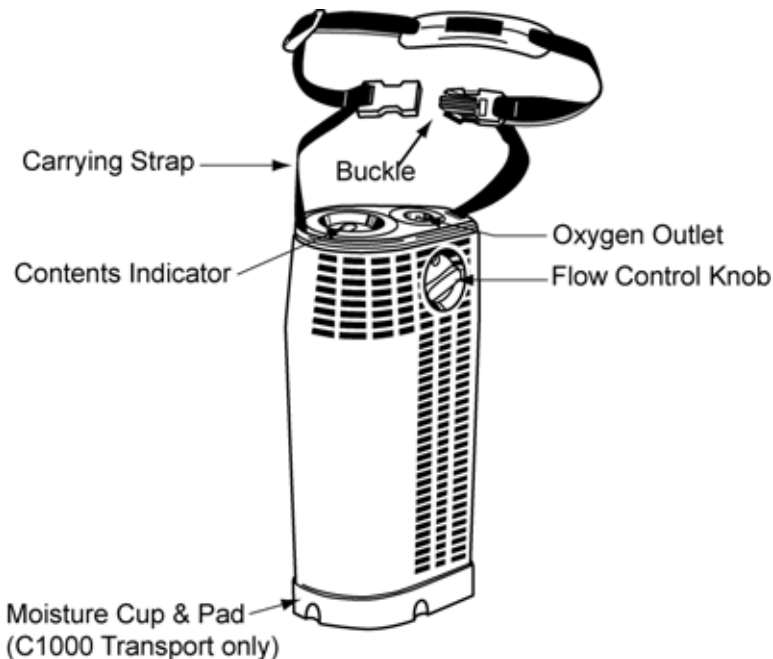

Figure 9: C1000/C1000 Transport Portable Unit Components

Companion 500/550 Unit Components

Become familiar with the various parts of the Portable described below and shown in Figure 10.

- **Vent Valve:** a lever-operated valve used to fill the unit. Upon connecting the Companion 500/550 to the Stationary, begin the filling sequence by opening the vent valve and end the fill by closing the valve.
- **Flow Control Knob:** an adjustable, rotary valve that controls the oxygen flow rate from the unit. Set the flow control knob to the oxygen flow rate prescribed by your physician.
- **Oxygen Outlet Connector:** the point where you attach the oxygen supply tube to receive oxygen flow from the Portable unit.
- **Contents Indicator:** an internal, weight scale mechanism that measures the amount of liquid oxygen in the unit. Unsnap the plastic buckle and lift the unit from the end of the carrying strap closest to the contents indicator. The pointer indicates approximately how much oxygen remains in the unit.
- **Fill Connector:** allows transfer of liquid oxygen from the Stationary unit to the Companion 500/550.
- **Carrying Strap:** an adjustable strap that enables you to wear the unit over your shoulder. You may also engage the plastic buckle in the carrying strap to create a short carrying handle. Use the strap to measure the oxygen contents of the Companion 500/550 (see contents indicator).

Companion 550 Portable Unit Components ONLY

- **Continuous/Demand Flow Switch:** a toggle switch that sets the Portable for either continuous flow or flow only when you inhale.
- **Sensor Connector:** used to sense your inhalation effort. Attach either tube of the dual-lumen cannula to this connector.
- **Dual-Lumen Cannula:** a special cannula with two connecting tubes for use with the Companion 550. One cannula tube connects to the unit's oxygen outlet connector and delivers oxygen to you. The second tube connects to the unit's sensor connector and monitors your breathing pattern. You may attach either of the cannula tubes to either connector.

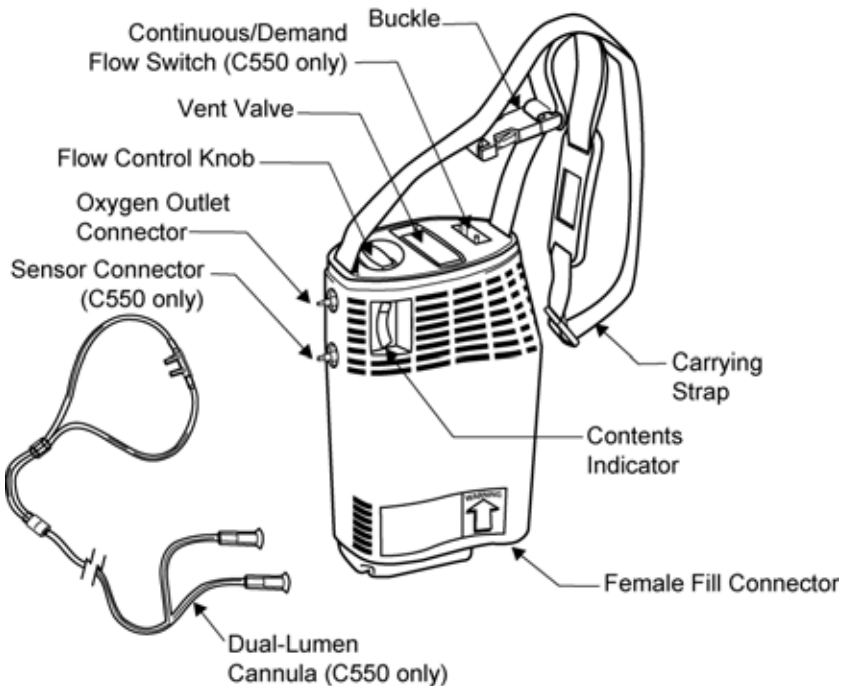

Figure 10: C500/C550 Portable Unit Components

Filling the Portable Unit

Fill the Companion Portable unit from the Stationary as follows:

CAUTION



Clean and dry the fill connectors on both the Stationary and Portable units to prevent freezing and possible equipment failure.

1. Check the contents indicator on the Stationary to ensure there is enough liquid oxygen for filling purposes.

For Companion 1000 Transport only: Remove the moisture cup by rotating the thumb nut (located on the bottom of the moisture cup) a quarter turn counterclockwise. The moisture pad is held in place with Velcro. Remove the pad, wring it out, and replace.

2. Using a clean, dry, lint-free cloth, dry the male fill connector (Figure 4) and female fill connector (Figure 8 and Figure 10).
3. Hold the Companion Portable with both hands and position the contoured case over the matching recessed area in the top of the Stationary (Figure 11).

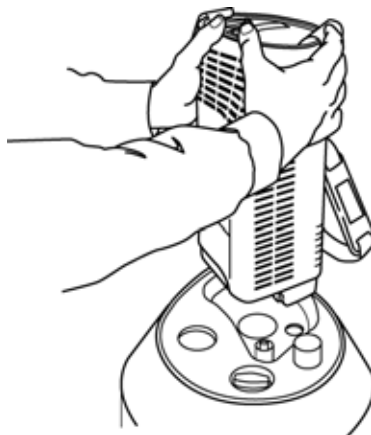

Figure 11: Positioning the Portable Unit for Filling

- Carefully lower the Portable into place, ensuring that the fill connectors are properly engaged.
- Place one hand on top of the Portable directly over the fill connector and press straight down. This will lower the Portable unit approximately 3/8 inch (10 mm) and ensure the fill connectors engage correctly.
- While holding the Portable unit in the fill position (Figure 12), move the vent valve lever to the open position (90° from the normal “off” position). This will result in a loud hissing noise.

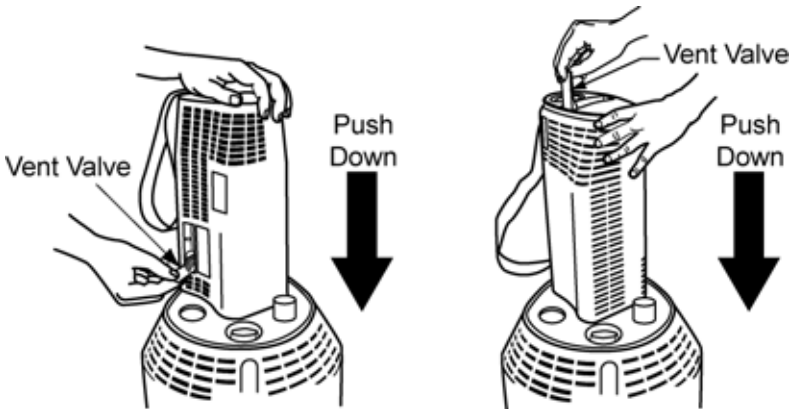

Figure 12: Filling the Portable Unit

WARNING



Do not leave the Companion Portable unattended during the filling operation.



Note: *During filling, maintain a slight downward pressure on the unit with one hand to keep the unit steady and maintain proper filling position. About 20 to 30 seconds into the filling procedure, close and reopen the vent valve one or more times to break up any ice that may begin to form around the valve stem. This will help prevent the vent valve from freezing open.*

- When you notice a change in the sound of venting gas followed by a dense, white vapor coming from the Stationary cover, close the vent valve. Fill times may vary according to the temperature of the container being filled.



Note: *If the vent valve fails to close and the hissing continues, remove the Portable unit by depressing the Portable release button (Figure 12 and Figure 13) on the Stationary unit. The Portable will stop venting in a few minutes. Allow the unit to warm until you can close the vent valve. The Portable may require two to three hours at no flow to restore adequate pressure for accurate oxygen flow.*

- Disengage the Portable from the Stationary unit by holding the carrying strap above the unit and depressing the release button (Figure 13). Always hold the Portable unit with at least one hand when attempting to disengage it.

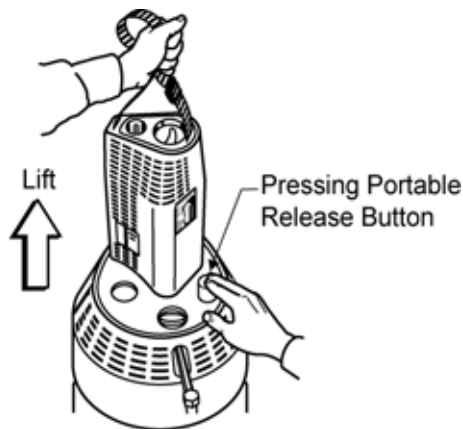

Figure 13: Disengaging the Portable Unit

If the units will not disengage easily, they may have become frozen. **DO NOT USE FORCE.** Simply allow a few moments for the frozen parts to warm, then disengage the Portable when the ice has melted.

WARNING



If a minor liquid oxygen leak occurs when you disengage the Portable, re-engage and disengage the unit to help dislodge any ice or other obstruction. If the liquid leak persists, re-engage the unit and notify your liquid oxygen supplier.

If a major liquid oxygen leak occurs when you disengage the Portable unit (that is, a steady stream of liquid oxygen), stay away from the unit and immediately notify your liquid oxygen supplier.

9. Check the liquid oxygen contents indicator (Figure 14) to make sure the Portable unit is filled to the desired level. The amount of liquid contained in the Portable is measured by an internal scale that is built into the unit.

The scale is actuated by lifting the Companion Portable unit by the strap nearest the indicator. The liquid contents level is indicated on the color-coded gauge.



Note: *You must disengage the plastic buckle in the carrying strap to check liquid oxygen contents.*

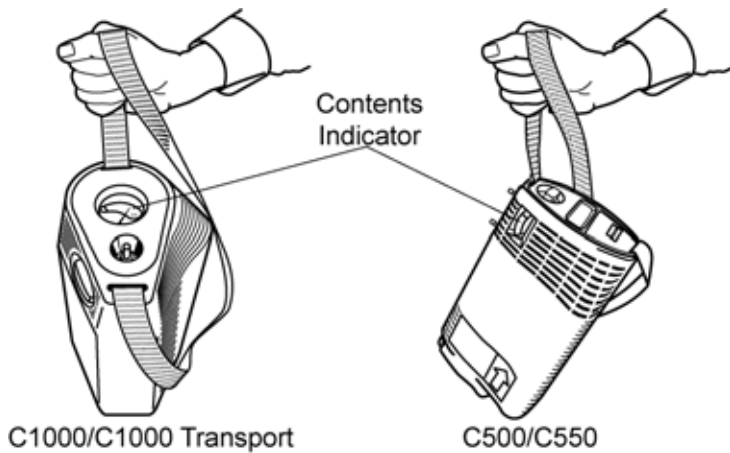

Figure 14: Checking Contents Indicator



Note: For shorter planned use times, you can partially fill the Portable by closing the vent valve sooner than normal. The Portable will then be lighter and you will waste less oxygen.

For Companion 1000 Transport only: Attach the moisture cup by inserting the fastener and rotating the thumb nut clockwise until it snaps into position.

10. Place the oxygen tube on the Portable oxygen outlet connector and adjust the cannula or other breathing device to comfortably fit your face (Figure 15). When the cannula is in place, turn the flow control knob to the prescribed rate.

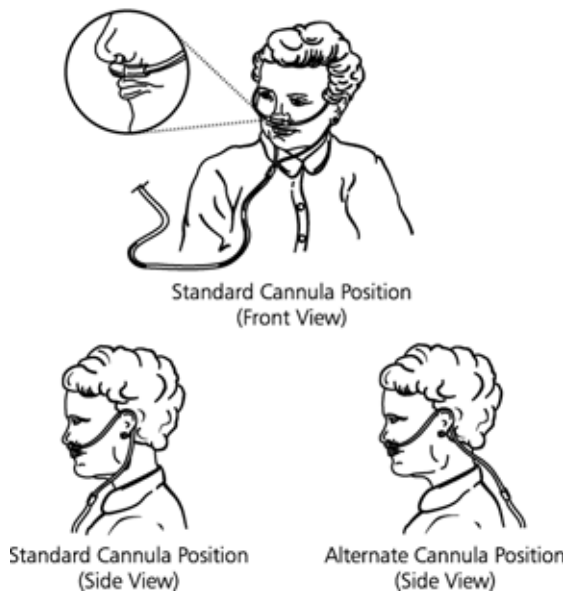

Figure 15: Adjusting the Nasal Cannula

For Companion 550 only: (See Figure 10) Place one of the tubes from the dual-lumen oxygen cannula on the Companion 550 oxygen outlet connector (upper connector). Place the other tube on the unit's sensor connector (lower connector). Adjust the cannula to comfortably fit your face.



Note: *You may attach the dual-lumen cannula tubes to either Companion 550 connector.*

11. Turn the Companion Portable unit flow control knob to the prescribed rate (Figure 16).

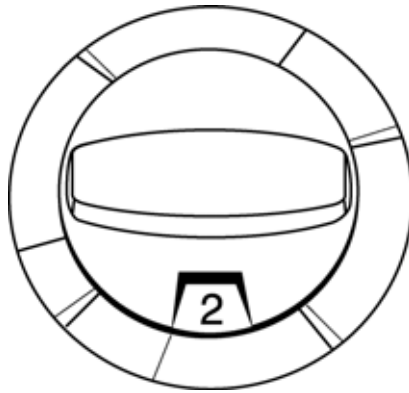

Figure 16: Flow Control Knob Set for 2 L/min



Note: Do not set the flow above the flow rate prescribed by your physician. Do not attempt to set the flow control between settings. Oxygen will flow from the unit only when the flow control is set to one of its marked settings.

For Companion 550 Only

Set the continuous/demand flow switch for the desired oxygen delivery — continuous oxygen flow or flow only during the inhalation part of each breath (Figure 17).



Figure 17: Continuous/Demand Flow Switch

When using the Companion 550 in the demand flow mode, oxygen delivery occurs when the unit senses your inhalation effort. You may notice an initial “puff” of oxygen followed by oxygen flow during the remainder of the inhalation. No oxygen flow occurs when you exhale.

When the unit is set for the continuous flow mode, oxygen flows during the entire breathing cycle.

At flow settings of 1 to 6 L/min, the demand flow mode can significantly increase the planned use time while reducing the drying effect that continuous flow oxygen has on the nasal passages.



Note: Use the demand flow mode at flow settings of **1 to 6 L/min only**. At flow settings below 1 L/min, you should use the continuous flow mode to extend your use time.



Note: With the Companion 550 in the demand flow mode, you may experience continuous flow from the oxygen outlet when using the unit immediately after filling. If this is the case, you should notice normal demand flow operation within about 10 minutes.

Using the Portable Unit

You may wear the Companion Portable on your right or left side, either over your shoulder or across your body. An adjustable shoulder strap and pad provide maximum comfort. In addition, you may engage the plastic buckle in the shoulder strap to create a short carrying handle.

CLEANING AND MAINTENANCE

Do NOT use alcohol, solvents, polishes, or any oily substance on oxygen equipment. If cleaning is necessary, use only warm water and a mild dish washing detergent. Dampen a cloth in the detergent and water solution and wipe the outside surface of the equipment until clean.

WARNING



Do not allow water into any of the controls, the fill connector, or the oxygen supply connector.

WARNING



Never attempt to repair or disassemble this equipment. You could create a hazardous condition or cause equipment failure. If you have problems, questions, or are unsure if equipment is operating properly, call your liquid oxygen system supplier.

CAUTION



Never apply cleaning agents or disinfectants to the contents indicator. These agents attack the plastic, which can result in leaking or cracking of the indicator. Use only a cloth dampened with water to clean the indicator as needed.

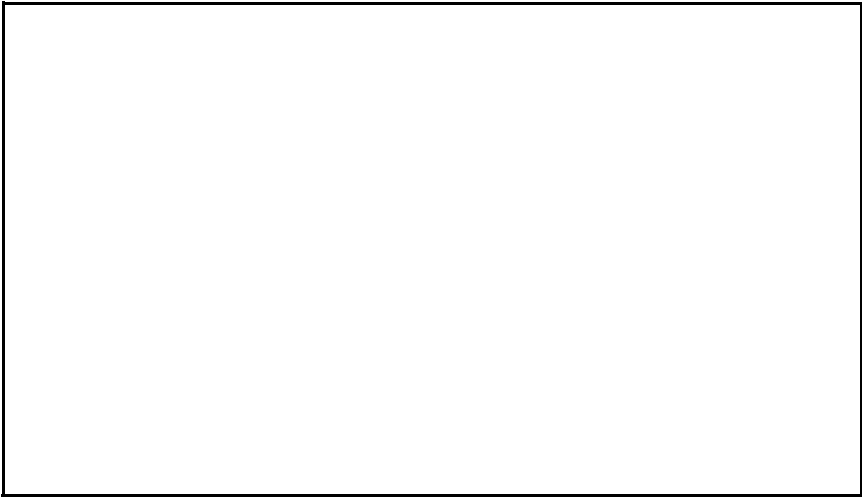

CAIRE Inc.

2200 Airport Industrial Dr., Ste. 500
Ball Ground, GA 30107

EC REP

M.D.D. Representative:
Medical Product Services GmbH
Borngasse, 20
35619 Braunfels, Germany