



Respironics Inc.  
1001 Murry Ridge Lane  
Murrysville, PA 15668 USA



**REF** 1105933

1105957 R01  
JJB 01/01/2013



**AMERICA'S**  
**A HEALTHCARE AT HOME**

**(800) 545-6026**

BiPAP AVAPS

USER MANUAL

**PHILIPS**  
RESPIRONICS

# Table of Contents

Chapter 1. Introduction.....	1
Package Contents .....	1
Intended Use .....	2
Warnings and Cautions.....	2
Warnings.....	2
Cautions .....	5
Notes .....	6
Contraindications.....	6
Patient Precautions.....	7
System Overview.....	7
Control Buttons .....	9
Available Therapy Modes.....	10
Available Therapy Features.....	11
Symbols .....	12
How to Contact Philips Respironics.....	13
Chapter 2. Device Setup .....	15
Installing the Air Filter .....	15
Where to Place the Device .....	15
Connecting the Breathing Circuit .....	16
Supplying AC Power to the Device.....	17
Display Symbols .....	18

Navigating the Device Screens .....	21
Starting and Stopping the Device .....	21
Monitor Pressure Screen .....	22
Changing the Comfort Settings.....	23
Setup Screen.....	25
Viewing the Information Screen.....	27
Viewing the Monitor Parameter Screen.....	28
Viewing Measured Parameters .....	28
Chapter 3. Device Alarms .....	29
Audible and Visual Alarm Indicators .....	29
Alarm LED Indicators .....	30
Alert Audible Indicators.....	30
Silencing an Alarm.....	31
Alarm Message Screens.....	31
Alarm Summary Table .....	32
Troubleshooting .....	37
Chapter 4. Accessories.....	41
Adding a Humidifier with or without Heated Tubing.....	41
SD Card .....	41
Supplemental Oxygen .....	41
Shielded DC Cord.....	42
Carrying Case.....	42
Airline Travel .....	42
Chapter 5. Cleaning the Device.....	43
Cleaning or Replacing the Filters.....	43
Cleaning the Tubing.....	44
Service.....	44
Chapter 6. Specifications .....	45
Chapter 7. EMC Information.....	49
Limited Warranty .....	53

# BiPAP AVAPS

user manual

## 1. Introduction

This chapter provides an overview of the device.

### Package Contents

The BiPAP AVAPS system may include the following components. Some components (e.g., humidifier) are optional accessories that may not be packaged with the device.

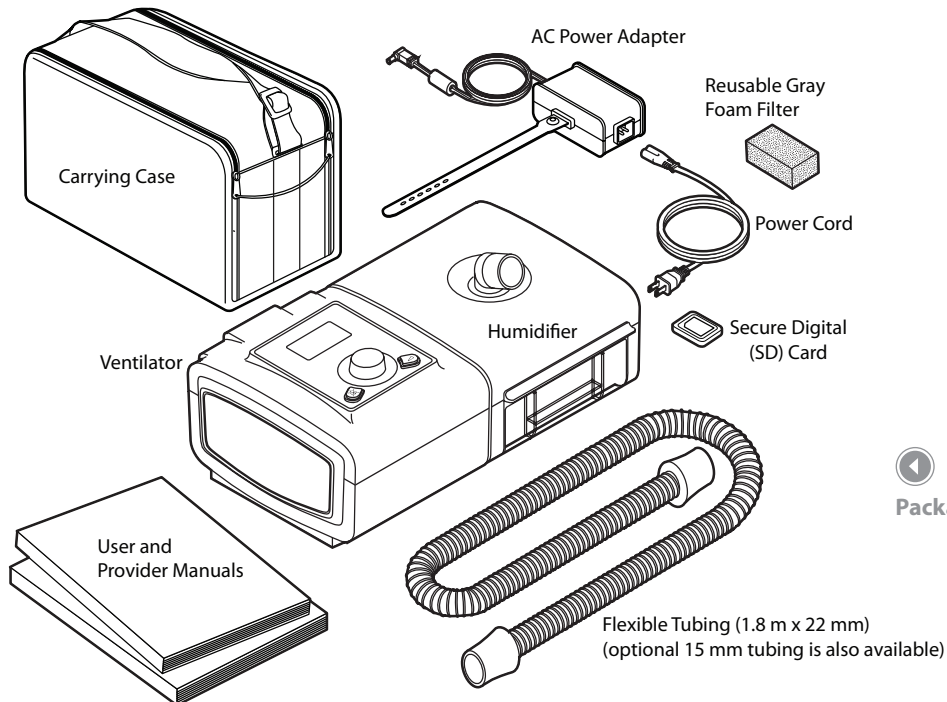

## Intended Use

The BiPAP AVAPS device is intended to provide non-invasive ventilatory support to treat adult patients weighing over 66 lbs (30 kg) and pediatric patients 7 years or older and weighing over 40 lbs (18 kg) with Obstructive Sleep Apnea (OSA) and Respiratory Insufficiency. This device may be used in the hospital or home.

## Warnings and Cautions

**Caution:** US federal law restricts this device to sale by or on the order of a physician.



### Warnings

*A warning indicates the possibility of injury to the user or operator.*

<b>Device Usage</b>	This device is not intended for life support. The device provides Positive Pressure Ventilation and is indicated for assisted ventilation. The device does not provide ventilation with guaranteed $V_T$ delivery. Patients requiring ventilation at a predetermined $V_T$ are not candidates for Pressure Support ventilation.
<b>Personnel Qualifications</b>	This manual serves as a reference. The instructions in this manual are not intended to supersede your health care professional's instructions regarding the use of the device.
	The prescription and other device settings should only be changed on the order of the supervising physician.
	The operator should read and understand this entire manual before using the device.
<b>Patient Circuits</b>	<p>The device should be used only with masks and connectors recommended by Philips Respironics or with those recommended by the health care professional or respiratory therapist. A mask should not be used unless the device is turned on and operating properly. The exhalation port(s) associated with the mask should never be blocked.</p> <p><b>Explanation of Warning:</b> The device is intended to be used with special masks or connectors that have exhalation ports to allow continuous flow of air out of the mask. When the device is turned on and functioning properly, new air from the device flushes the exhaled air out through the mask exhalation port. However, when the device is not operating, enough fresh air will not be provided through the mask, and exhaled air may be rebreathed.</p>

<b>Patient Circuits</b>	In the event of a power or device failure, audible and visual alarm signals will activate. The device must be disconnected from the patient immediately. As is the case with most ventilators with passive exhalation ports, when power is lost, sufficient air will not be provided through the circuit, and exhaled air may be rebreathed.
	At low EPAP pressures, the flow through the exhalation port may be inadequate to clear all exhaled gas from the tubing. Some rebreathing may occur.
	The device does not have an alarm to detect occlusion of the exhalation port. Before each use, inspect the patient circuit to verify that the port is not occluded. Occlusion or partial occlusion can reduce airflow and result in rebreathing of exhaled air.
	Verify the operation of the Patient Disconnect alarm with any changes in the patient circuit.
<b>Oxygen</b>	When using oxygen with this system, the oxygen supply must comply with local regulations for medical oxygen.
	When using oxygen with this system, turn the device on before turning on the oxygen. Turn the oxygen off before turning the device off. This will prevent oxygen accumulation in the device. <b>Explanation of the Warning:</b> When the device is not in operation and the oxygen flow is left on, oxygen delivered into the tubing may accumulate within the device's enclosure. Oxygen accumulated in the device enclosure will create a risk of fire.
	When using oxygen with this system, a Philips Respironics Pressure Valve (REF 302418) must be placed at the air outlet port. Failure to use the pressure valve could result in a fire hazard. Refer to the pressure valve instructions for use for proper use.
	Supplemental oxygen cannot be used with the heated tube accessory. The safety pressure valve is not compatible with this set-up, and could result in a fire hazard.
	If administering fixed-flow supplemental oxygen, the oxygen concentration may not be constant. The inspired oxygen concentration will vary depending on the pressure setting, patient breathing pattern, and leak rate. Substantial leaks around the mask may reduce the inspired oxygen concentration to less than the expected concentrations. Appropriate patient monitoring should be implemented.
	Oxygen supports combustion. Oxygen should not be used while smoking or in the presence of an open flame.
	Do not connect the device to an unregulated or high pressure oxygen source.
	Do not use the device near a source of toxic or harmful vapors.

<b>Operating Temperatures</b>	Do not use this device if the room temperature is warmer than 95° F (35° C). If the device is used at room temperatures warmer than 95° F, the temperature of the airflow may exceed 109° F (43° C). This could cause irritation or injury to your airway.
	Do not operate the device in direct sunlight or near a heating appliance because these conditions can increase the temperature of the air coming out of the device.
<b>Bacteria Filter</b>	If the device is used by multiple persons (such as rental devices), Philips Respironics recommends that a low-resistance, main flow bacteria filter (Part Number 342077) be installed in-line between the device and the circuit tubing to prevent device contamination.
<b>Improperly Functioning Ventilator</b>	If you notice any unexplained changes in the performance of the device, if it is making unusual sounds, if it has been dropped or mishandled, if water is spilled into the enclosure, or if the enclosure is cracked or broken, disconnect the power cord and discontinue use. Contact your home care provider.
	The use of accessories, transducers and cables other than those specified, with the exception of transducers and cables sold by Philips Respironics as replacement parts for internal components, may result in increased Emissions or decreased Immunity.
	This device should not be used adjacent to or stacked with other equipment and that if adjacent or stacked use is necessary, the device should be observed to verify normal operation in the configuration in which it will be used.
	Operation of the device may be adversely affected by: <ul style="list-style-type: none"> <li>– Electromagnetic fields exceeding the level of 3 V/m in the test conditions of EN 60601-1-2</li> <li>– Operation of high frequency (diathermy) equipment</li> <li>– Defibrillators, or short wave therapy equipment</li> <li>– Radiation (e.g., x-ray, CT scan)</li> <li>– Magnetic fields (e.g., MRI)</li> <li>– Mobile RF communication equipment</li> <li>– The use of accessories, transducers and cables other than those specified, with the exception of transducers and cables sold by Philips Respironics</li> </ul>
<b>Power Cord</b>	Be sure to route the power cord to the outlet in a way that will prevent the cord from being tripped over or interfered with by chairs or other furniture.
	This device is activated when the power cord is connected.

<b>Maintenance</b>	Never operate the device if any of the parts are damaged or if it is not working properly. Have any damaged parts replaced before continuing use.
	Electrical cords, cables, and the power supply device should be periodically inspected for damage or signs of wear. Replace any damaged parts before using.
	Repairs and adjustments must be performed by Philips Respironics-authorized service personnel only. Unauthorized service could cause injury, invalidate the warranty, or result in costly device damage.
<b>Cleaning</b>	To avoid electric shock, unplug the device before cleaning it.
	Do not immerse the device in any fluids or spray the device with water or cleaners. Clean the device with a cloth dampened with an approved cleaner.
<b>Humidifier</b>	For safe operation, the humidifier must always be positioned below the breathing circuit connection at the mask and the air outlet on the device. The humidifier must be level for proper operation.

## Cautions

*A caution indicates the possibility of damage to the device.*

<b>Electrostatic Discharge (ESD)</b>	Pins of connectors should not be touched. Connections should not be made to these connectors unless ESD precautionary procedures are used. Precautionary procedures include methods to prevent build-up of electrostatic charge (e.g., air conditioning, humidification, conductive floor coverings, non-synthetic clothing), discharging one's body to the frame of the equipment or system or to earth or a large metal object, and bonding oneself by means of a wrist strap to the equipment or system or to earth.
	Before operating the device, ensure that the SD card cover is replaced whenever any of the accessories such as the Link Module or modem are not installed. Refer to the instructions that came with your accessory.
	Do not use antistatic or conductive hoses or conductive patient tubing with the device.
<b>EMC Information</b>	All Medical Electrical Equipment needs special precautions regarding EMC and needs to be installed and put into service according to the EMC information provided in Chapter 7: EMC Information.
<b>Condensation</b>	Condensation may damage the device. If the device has been exposed to either very hot or very cold temperatures, allow it to adjust to room temperature (operating temperature) before starting therapy.
	Do not operate the device outside of the operating temperature range shown in the Specifications chapter.



<b>Extension Cords</b>	Do not use extension cords with this device.
<b>Device Placement</b>	Do not place the device in or on any container that can collect or hold water.
	Do not place the device directly onto carpet, fabric, or other flammable materials.
	Do not plug the device into an outlet controlled by a wall switch.
<b>Air Filter</b>	A properly installed, undamaged reusable foam inlet filter is required for proper operation.
	Operating the device with a dirty filter may keep the system from working properly and may damage the device.
	A dirty inlet filter may cause high operating temperatures that may affect device performance. Regularly examine the inlet filter as needed for integrity and cleanliness.
	Never install a wet filter into the device. You must ensure sufficient drying time for the cleaned filter.
<b>Cleaning</b>	Do not immerse the device in liquid or allow any liquid to enter the enclosure or inlet filter.

## Notes

- Additional warnings, cautions and notes are located throughout this manual.
- Please see the “Limited Warranty” section of this manual for information on warranty coverage.

## Contraindications

The device is contraindicated on patients without a spontaneous respiratory drive. If any of the following conditions apply to you, consult your physician before using the device:

- Inability to maintain a patent airway or adequately clear secretions
- At risk for aspiration of gastric contents
- Diagnosed with acute sinusitis or otitis media
- Allergy or hypersensitivity to the mask materials where the risk from allergic reaction outweighs the benefit of ventilatory assistance
- Epistaxis, causing pulmonary aspiration of blood
- Hypotension

When assessing the relative risks and benefits of using this equipment, the health care professional should understand that this device can deliver the pressure ranges indicated in the Control Accuracy table in chapter 6. In the event of certain fault conditions, a maximum pressure of 40 cm H<sub>2</sub>O is possible.

## Patient Precautions

- Immediately report any unusual chest discomfort, shortness of breath, or severe headache.
- If skin irritation or breakdown develops from the use of the mask, refer to the mask instructions for appropriate action.
- The following are potential side effects of noninvasive positive pressure therapy:
  - Ear discomfort
  - Conjunctivitis
  - Skin abrasions due to noninvasive interfaces
  - Gastric distention (aerophagia)

## System Overview

The BiPAP AVAPS device is intended to augment patient breathing by supplying pressurized air through a patient circuit. It senses the patient's breathing effort by monitoring airflow in the patient circuit and adjusts its output to assist in inhalation and exhalation. This therapy is known as Bi-level ventilation. Bi-level ventilation provides a higher pressure, known as IPAP (Inspiratory Positive Airway Pressure), when you inhale, and a lower pressure, known as EPAP (Expiratory Positive Airway Pressure), when you exhale. The higher pressure makes it easier for you to inhale, and the lower pressure makes it easier for you to exhale. The device can also provide a single pressure level, known as CPAP (Continuous Positive Airway Pressure).

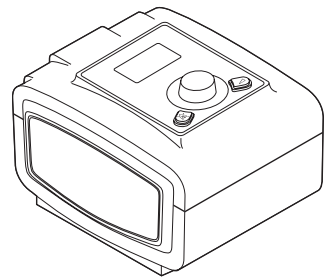

When prescribed, the device can also provide features to help make your therapy more comfortable. The ramp function allows you to lower the pressure when trying to fall asleep. The air pressure will gradually increase until the prescription pressure is reached. Additionally, the Flex comfort feature provides increased pressure relief during the expiratory phase of breathing, and the AVAPS feature helps you maintain a target  $V_T$ .

Several accessories are also available for use with the device. Contact your home care provider to purchase any accessories not included with your system.

The figure below illustrates some of the device features, described in the table below.

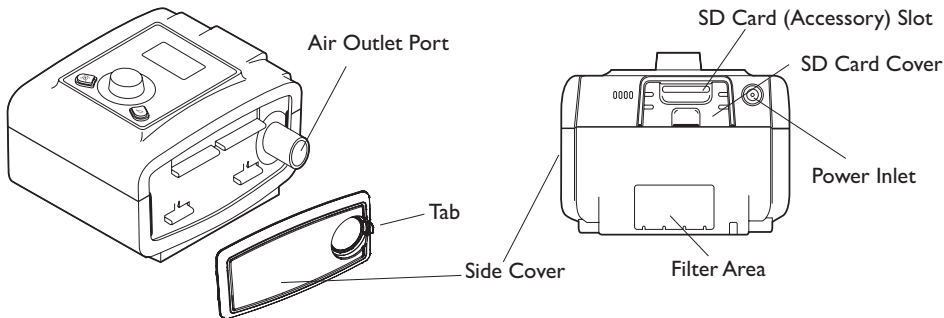

Feature	Description
Air Outlet Port	Connect the flexible tubing here. <b>Note:</b> Heated Tubing should only be connected to the Air Outlet Port of the compatible System One Heated Humidifier and not to the Air Outlet Port of the therapy device.
SD Card (Accessory) Slot	If applicable, insert the optional SD card here.
SD Card Cover	If applicable, the optional accessories such as a Link Module or Modem can be installed here. Refer to the instructions supplied with your accessory. When not using an accessory, this cover must be in place on the device.
Power Inlet	Connect the power supply cord here.
Filter Area	A reusable, gray foam filter must be placed in the filter area to screen out normal household dust and pollen.
Side Cover	If using a humidifier with the device, this side cover can be easily removed with the release tab before attaching the humidifier. Refer to the Humidifier Manual for more information.

## Control Buttons

The figure below shows the display screen and primary control buttons on the device.

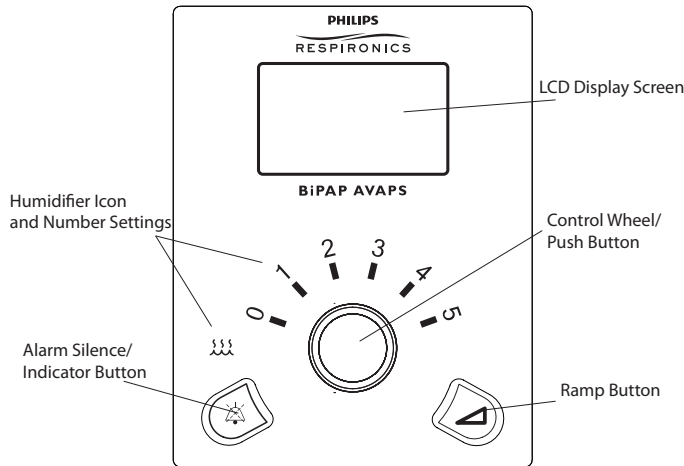

Feature	Description
Display Screen	Shows therapy settings, patient data, and other messages. The startup screen is shown temporarily when the device is first powered.
Humidifier Icon	This icon lights up (different colors) when the optional humidifier and/or heated tube is attached and heat is being applied. White means classic humidification is selected. Blue means System One humidification is selected. Orange means the heated tube is attached. Please refer to the humidifier user manual for more information.
Humidifier Numbers	The humidifier number settings are only visible when the humidifier is attached and therapy is active. You can use the control wheel to change the number settings for the humidifier. When the heated tube is being used with the humidifier, these numbers will control the heated tube temperature setting.
Control Wheel/ Push Button	Turn the Wheel to toggle between options on the screen. Press the Wheel to choose an option. Primary function is to turn airflow on/off. Pressing the Wheel also resets alarms.
Ramp Button	When the airflow is on, this button allows you to activate or restart the ramp function. This button lights up when therapy is active or during specific alerts.
Alarm Silence/ Indicator Button	Silences the audible portion of the alarm for a period of time and indicates an alarm condition.

## Available Therapy Modes

The table below describes the therapy modes available on the device:

Therapy Modes	Description
CPAP	Continuous Positive Airway Pressure; CPAP maintains a constant level of pressure throughout the breathing cycle.
S	Spontaneous Pressure Support; A Bi-level therapy mode where breaths are patient-triggered and patient-cycled. The device triggers to IPAP (Inspiratory Positive Airway Pressure) in response to spontaneous inspiratory effort and cycles to EPAP (Expiratory Positive Airway Pressure) during exhalation. The device also cycles a patient-triggered breath if no patient exhalation effort is detected for 3 seconds. The level of Pressure Support delivered is determined by the difference between the IPAP and EPAP settings ( $PS = IPAP - EPAP$ )
S/T	Spontaneous/Timed Pressure Support; A Bi-level therapy mode where each breath is patient-triggered and patient-cycled or machine-triggered and machine-cycled. S/T mode is similar to S mode, except that the device also triggers machine-triggered breaths based on a set breath rate and cycles machine-cycled breaths based on a set inspiratory time if the patient does not spontaneously breathe within a set time.
T	Timed Pressure Support; A Bi-level therapy mode where breaths are machine-triggered and machine-cycled. T mode provides mandatory pressure assist with bi-level pressures. The patient's breathing rate has no effect on the machine rate or pressure levels. The trigger to IPAP is determined by the breath rate setting, and the cycle time is determined by the inspiratory time setting.
PC	Pressure Control Pressure Support; A Bi-level therapy mode where each breath is patient or machine-triggered and machine-cycled. PC mode is similar to S/T mode, except that all breaths are machine-cycled. This is a pressure-limited, machine or patient-triggered, time-cycled mode. Therefore, the inspiratory time may be triggered by the patient or by the device, but IPAP will be pressure-limited with a set cycle time determined by the Inspiratory Time setting.

## Available Therapy Features

If prescribed for you, the device provides the following therapy features.

### AVAPS

If enabled, Average Volume Assured Pressure Support (AVAPS) is a feature available in the S, S/T, PC, and T modes. It helps patients maintain a tidal volume ( $V_T$ ) equal to or greater than the target tidal volume (Tidal Volume setting in the AVAPS) by automatically controlling the pressure support (PS) provided to the patient. The AVAPS feature adjusts PS by varying the IPAP level between the minimum (IPAP Min) and maximum (IPAP Max) settings. AVAPS averages  $V_T$  and changes the PS value gradually. This occurs over several minutes. The rate of change is slow, so that the patient is not aware of breath to breath pressure changes.

As patient effort decreases, AVAPS automatically increases PS to maintain the target tidal volume. The IPAP level will not rise above IPAP Max, even if the target tidal volume is not reached. Conversely, as patient effort increases, AVAPS will reduce PS. IPAP will not fall below IPAP Min, even if the target tidal volume is exceeded. If IPAP Max is reached and the target tidal volume is not achieved, the Low Tidal Volume alarm activates.

### Bi-Flex Comfort Feature

If enabled, the device provides a comfort feature called Bi-Flex in S mode only. The Bi-Flex attribute adjusts therapy by inserting a small amount of pressure relief during the latter stages of inspiration and during active exhalation (the beginning part of exhalation). Bi-Flex levels of 1, 2, or 3 progressively reflect increased pressure relief that will take place at the end of inspiration and at the beginning of expiration.

### Ramp











If enabled, the device is equipped with a linear ramp function. The Ramp feature will reduce the pressure and then gradually increase (ramp) the pressure to the prescription pressure setting so patients can fall asleep more comfortably.



## Rise Time

If enabled, the device provides a feature called Rise Time in S, S/T, T, and PC modes. Rise time is the amount of time it takes the device to change from the expiratory pressure setting to the inspiratory pressure setting. Rise time levels of 1, 2, 3, 4, 5, or 6 progressively reflect slowed response of the pressure increase that will take place at the beginning of inspiration. A setting of 1 is the fastest rise time while a setting of 6 is the slowest. Providers should adjust the rise time to find the most comfortable setting for the patient. Rise time cannot be adjusted when Bi-Flex is enabled.

## Symbols

The following symbols appear on the device and power supply.

Symbol	Description
	Consult accompanying instructions for use.
	AC Power
	DC Power
<b>IP22</b>	Drip Proof Equipment
	Caution, consult accompanying documents.
	ESD Warning Symbol
	Class II (Double Insulated)
	Type BF Applied Part
	For indoor use only
	Do not disassemble
	For Airline Use. Complies with RTCA DO-160F section 21, category M.

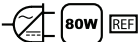
	<p>Caution: U.S. federal law restricts this device to sale by or on the order of a physician.</p>
	<p>Use only with the standard 60W power supply 1091398. (not for use with Heated Tubing)</p>
	<p>Use only with the Heated Tubing compatible 80W power supply 1091399. (can also be used when Heated Tubing is not in use)</p>

## How to Contact Philips Respironics

To have your device serviced, contact your home care provider. If you need to contact Philips Respironics directly, call the Customer Service department at 1-724-387-4000 or 1-800-345-6443.

You can also use the following addresses:

Respironics Inc.  
1001 Murry Ridge Lane  
Murrysville, PA 15668





## 2. Device Setup

### Installing the Air Filter

The device uses a gray foam filter that is washable and reusable. The reusable filter screens out normal household dust and pollen. It must be in place at all times when the device is operating. One reusable gray foam filter is supplied with your device. If your filter is not already installed when you receive the device, you must install it before using the device. To install the gray foam filter, insert it into the filter area.

### Where to Place the Device

Place the device upright on a firm, flat surface somewhere within easy reach of where you will use it, at a level lower than your sleeping position. Make sure the filter area on the back of the device is not blocked by bedding, curtains, or other items. Air must flow freely around the device for the system to work properly. Make sure the device is away from any heating or cooling equipment (e.g., forced air vents, radiators, or air conditioners).

## Connecting the Breathing Circuit

To use the system, you will need the following accessories in order to assemble the recommended circuit:

- Philips Respironics interface (nasal mask or full face mask) with integrated exhalation port, or Philips Respironics interface with a separate exhalation device (such as the Whisper Swivel II)
- Philips Respironics 1.83 m (6 ft.) 22 mm flexible tubing or the optional 15 mm flexible tubing
- Philips Respironics headgear (for the mask)

Complete the following steps to connect your breathing circuit to the device:

1. Connect the flexible tubing to the air outlet on the side of the device.

**Note:** If required, connect a bacteria filter to the device air outlet, and then connect the flexible tubing to the outlet of the bacteria filter.

**Note:** When using the bacteria filter, the device performance may be affected. However, the device will remain functional and deliver therapy.

**Note:** When using the optional heated tubing, attach the heated tubing to the humidifier's modified air outlet port, with the bacteria filter installed in-line, but at the opposing end of the tubing.

2. Connect the tubing to the mask. Refer to the instructions that came with your mask.
3. Attach the headgear to the mask if necessary. Refer to the instructions that came with your headgear.



**Warning:** The exhalation device (Whisper Swivel II) or exhalation port (on masks with an integrated exhalation port) is designed to exhaust CO<sub>2</sub> from the patient circuit. Do not block or seal the ports on the exhalation device.



**Warning:** If you are using a full face mask (a mask covering both your mouth and your nose), the mask must be equipped with a safety (enainment) valve. You must ensure that the enainment valve is functioning properly.

## Supplying AC Power to the Device

Complete the following steps to supply AC power to the device:

1. Plug the socket end of the power cord (included) into the power supply (also included).

**Important!** When you are using Heated Tubing with the compatible System One Heated Humidifier, you must use the 80W power supply.





















2. Plug the pronged end of the power cord into an electrical outlet that is not controlled by a wall switch.
3. Plug the power supply cord's connector into the power inlet on the back of the ventilator.
4. Ensure that all connections are secure.



















**Important!** To remove AC power, disconnect the power supply cord from the electrical outlet.



















**Note:** See Chapter 4 for instructions on using DC Power.

## Display Symbols

The following symbols may display on the device in place of text if the display language selected by your home care provider is "Icon."

Symbol	Description
 PAP	Activate Mode
	Alarm
	Alarm Silence
	Apnea
<b>AVAPS</b>	AVAPS therapy feature
	Back
	Backlight
<b>FLEX</b>	Flex therapy feature
<b>FLEX</b> 	Flex Lock
	Blower Hours
<b>BPM</b>	Breaths Per Minute
// 	Clear Patient Data (in progress)
//  	Clear Patient Data Failed
//  	Clear Patient Data Successfully
	Comfort Setting
 hPa cmH <sub>2</sub> O	hPa/cmH <sub>2</sub> O
	Humidifier, Humidity Level
	Information
<b>IPAP</b> 	IPAP Max
<b>IPAP</b> 	IPAP Min
	Language

Symbol	Description
	Leak
	Machine Hours
<b>Min Vent</b>	Minute Ventilation
	Mode
	No
	No Settings Available
	Off (disabled)
	On (enabled)
	Patient Disconnect
	Provider Mode
	Ramp Start Pressure
	Ramp Time
	Reinsert SD Card
	Reset Therapy Hours
	Reset Blower Hours
<b>RR</b>	Respiratory Rate
	Rise Time
	Rise Time Lock
	SD Card Corrupted
	SD Card Full
	SD Card Inserted

Symbol	Description
	SD Card Inserted: Writing in Progress
	SD Card Inserted: Writing Successful
	SD Card Inserted: Prescription Accepted
	SD Card Inserted: Prescription Rejected
	SD Card is Write-Protected
	SD Card Removed
	Setup
	Setup Parameter Display
	System One Humidification
	System One Resistance
	System One Resistance Lock
	Therapy (Blower Off)
	Therapy (Blower On)
	Therapy Hours
$T_i$	Timed Inspiration
	Ventilator Inoperative
$V_T$	Tidal Volume
$V_{TE}$	Exhaled Tidal Volume
	Tubing Type
	Tubing Type Lock
	Tube Temperature
	Yes (Selection Confirmed)

## Navigating the Device Screens

Turn the Wheel to toggle between options and settings on the screen. Press the Wheel to choose an option or setting that is highlighted. If you choose “Back” or the ← icon on any screen, it will take you back to the previous screen.

**Note:** The screens shown in this manual are examples only. Information on your device screens may be different depending on your prescription settings.

**Note:** Your device will either display in icon mode or text mode. Examples will be shown in both modes.

### Starting and Stopping the Device

1. Supply power to the device.

The first screen to display will be the Philips Respironics logo, followed by the screen showing the current software version number. The Blower hours screen (⊕⊖ in icon mode) will then appear, which shows the total blower hours for the device in hours and minutes.

2. The Main Menu screen appears, shown below.

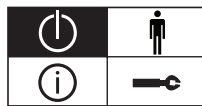

Icon View - Blower Off



Text View



Icon View - Blower On

3. Put on your mask assembly.

**Note:** If you are having trouble with your mask, refer to the instructions supplied with the mask.

4. Turn the Wheel to toggle between the four options. Highlight Therapy or the Ⓜ icon. Press the Wheel to turn on the airflow and begin therapy. The Monitor Pressure screen will appear, described in detail in the next section.
5. Verify that the device beeps and the alarm and ramp LEDs light up each time therapy is started. If the device does not operate accordingly, contact your home care provider, as the alarm system may not be fully functional.
6. Make sure that no air is leaking from your mask into your eyes. If necessary, adjust the mask and headgear until the air leak stops. See the instructions provided with your mask for more information.

**Note:** A small amount of leak is normal and acceptable. Correct large mask leaks or eye irritation from an air leak as soon as possible.



7. If you are using the device in a bed with a headboard, try placing the tubing over the headboard. This may reduce tension on the mask.
8. Press and hold the Wheel for approximately 2 seconds to turn off therapy and return to the Main Menu.
9. Verify that the device beeps when therapy is stopped. If the device does not operate accordingly, contact your home care provider, as the alarm system may not be fully functional.

## Monitor Pressure Screen

From the Main Menu, if you select Therapy and then press the Wheel, the following Monitor Pressure screen appears.

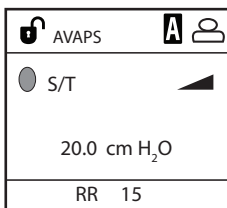



The Monitor Pressure screen displays the following items:

- Pressure
- Therapy Mode (CPAP, S, S/T, T, or PC)
- Timed Breath Indicator (●)
- Icon Bar
- Measured Parameters

**Note:** The Ramp symbol will also appear on the display if Ramp is active.

**Note:** If an accessory is attached to the therapy device, additional symbols may appear on the Monitor Pressure screen. Refer to the instructions provided with the accessory for more information.

The top of the display shows a group of status symbols. The symbols will only appear if the conditions described in the following table exist.

Symbol	Description
	The Provider Access symbol indicates the device is in Provider mode.
AVAPS	The AVAPS symbol displays only when the AVAPS therapy feature is enabled by the provider.
FLEX	The Flex symbol displays only when the Bi-Flex therapy feature is enabled by the provider.
	The Apnea alarm symbol displays only when the Apnea alarm is enabled by the provider.
	The Patient Disconnect symbol displays only when the Patient Disconnect alarm is enabled by the provider.

The bottom section of the display shows additional measured parameters which may include:

- Respiratory Rate (RR)
- Tidal Volume in milliliters (ml)
- Minute Ventilation (Min Vent) in liters per minute (lpm)
- Leak in lpm

*Note: The measured parameters display one at a time on-screen.*

## Changing the Comfort Settings

Your device is equipped with optional Flex, Ramp Time, and Rise Time features that your health care professional may prescribe for you. From the Main Menu, when you highlight the Comfort option and press the Wheel, the Comfort Settings screen below appears.

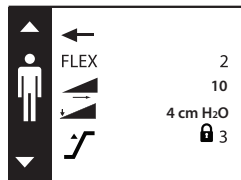

Icon View

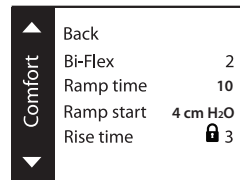

Text View

*Note: If no comfort settings are available, the Comfort Settings screen displays "No Settings Available."*

*Note: If your home care provider has locked a comfort setting, a lock symbol () appears next to the value. You cannot adjust any settings that are locked.*

## Flex Setting

The Flex comfort setting allows you to adjust the level of pressure relief that you feel during therapy. Your home care provider can enable, lock, or disable this feature. When your provider enables Flex, a level will already be set for you on the device. If this is not comfortable, you can increase or decrease the setting from 1 to 3. A setting of 1 provides a small amount of pressure relief, with higher numbers providing additional relief.

## Ramp Time Setting

This enables you to modify the Ramp time setting in 5 minute increments. The range for this setting is 0 to 45 minutes.

## Ramp Start Setting

The device is equipped with an optional ramp feature that your home care provider can enable or disable. This feature reduces the air pressure when you are trying to fall asleep and then gradually increases (ramps) the pressure until your prescription setting is reached, allowing you to fall asleep more comfortably.

*Note: If the ramp feature is disabled, nothing will happen when you press the Ramp button.*

If ramp is enabled on your device, after you turn on the airflow, you can press the Ramp button on the top of the device. Use the Ramp button as often as you like during the night. When Ramp is enabled, the Ramp icon () appears on the Monitor Pressure screen.

The Ramp Start pressure setting can be increased or decreased from 4 in increments of 1 to the CPAP setting (if in CPAP therapy mode) or the EPAP setting (for all other therapy modes).

## Rise Time Setting

Rise time is the time it takes for the device to change from EPAP to IPAP. If rise time is prescribed for you, you can adjust the rise time from 1 to 6 to find the setting that provides you with the most comfort. A setting of 1 is the fastest rise time, while 6 is the slowest.

*Note: If Flex is enabled, the rise time setting will be fixed at 3.*









## Language

This feature allows you to choose which language to display on the interface when in “Text mode”. You can also turn off (0) text mode which means the device will display the “Icon Mode” on the interface.

*Note: Both “Icon Mode” and English “Text Mode” are shown throughout this guide for your reference.*

## Setup Screen ( )

From the Main Menu, highlight “Setup” or the  icon and press the wheel. The following Setup screen will appear. The user can change settings in the Setup menu.

▲	←		
		off	
		4	
		3	
		on	
		3	
		15	
		X1	
		on	
		cmH <sub>2</sub> O	
▼	←		

Icon View

▲	Back	
	Heated Tube Humi	off
	Humidity Level	4
	Tube Temperature	3
	System One humidi	on
	Humidifier	3
	Tubing Type	15
	System One Resist	X1
	Back light	on
	hPa/cmH <sub>2</sub> O	cmH <sub>2</sub> O
▼	Back	

Text View

**Note:** The screen will only show a few lines at a time. As you rotate the wheel to toggle over different options the screen will slide up and down accordingly. If the text is too long to completely fit on the screen, it will scroll horizontally across the screen when highlighted.

The following options appear on the Setup screen:

### Heated Tube Humidification

This setting will only display if you are using the heated tube. You can enable (1) or disable (0) this feature.

### Humidity Level

This setting will only display if you are using the heated tube. This setting allows you to choose the desired humidity setting for the humidifier: 1, 2 or 3. This setting can only be changed from the Setup screen.

### Tube Temperature

This setting will only display if you are using the heated tube. This setting allows you to choose the desired temperature for the heated tube: 0, 1, 2, 3, 4 or 5. If you choose zero (0), this will turn off both the humidifier and the heated tube.

**Note:** When using Heated Tubing, the control wheel can also be used to change this setting.

## SYSTEM ONE Humidification

System One humidity control maintains a consistent mask humidity by monitoring and adjusting for changes in room temperature and room humidity. You can enable (1) or disable (0) this feature. If the System One humidity control has been disabled, the classic style of basic temperature controlled heated humidification will be used. This will only display if the humidifier is attached.

**Note:** *The System One Humidification option is only available if the Heated Tubing is removed or has been disabled.*

### Humidifier

This setting allows you to view and choose the desired humidity setting. This will only display if the humidifier is attached. Please refer to the humidifier manual if using a humidifier.

**Note:** *The Humidifier option is only available if the Heated Tubing is removed or has been disabled.*

### Tubing Type Setting

This setting allows you to select the correct size diameter tubing that you are using with the device. You can choose either (22) for the Philips Respironics 22 mm tubing, or (15) for the optional Philips Respironics 15 mm tubing. When using Heated Tubing, the device will automatically change this setting to the appropriate tubing type (15H) and you will not be able to change it..

**Note:** *If the Heated Tubing is removed, the device will default back to the previous tubing type setting.*

 **Warning:** *If you are using the optional Respironics 15 mm tubing, the device tubing type setting must be set to 15. If your device does not have the tubing type setting, you must use the Respironics 22 mm tubing selection.*

## SYSTEM ONE Resistance

This setting allows you to adjust the level of air pressure relief based on the specific Respironics mask. Each Respironics mask may have a “System One” resistance control setting. Contact your home care provider if you cannot find this resistance setting for your mask. If your provider has locked the resistance setting into place, you can view the setting but cannot change it, and the screen will display a lock symbol (  ) next to the setting. If your provider has disabled resistance, you will not see this setting.

### Backlight



You can enable or disable the button LED backlight on the device.

### hPa/cmH<sub>2</sub>O

You can select either hPa or cmH<sub>2</sub>O as the default unit of measure on the device.

## Humidifier Preheat

When using a humidifier, the device can preheat the water tank for up to 30 minutes prior to starting therapy.





In order to activate the preheat mode, the blower must be “off” and a humidifier must be attached. From the device Home screen, highlight “Therapy” or the  icon, then press and hold down the control wheel for 5 seconds. You will hear a single beep and the device will now be in preheat mode. The humidifier icon () will illuminate during this time.

During the 30 minute preheat, you will still be able to use the control wheel to select other menu options from the Home screen. If you press the wheel while “Therapy” or the  icon is highlighted on the Home screen, preheat mode will end and the blower will turn “on” to begin therapy. The humidifier number selected in the setup menu (0, 1, 2, 3, 4, or 5) will now take effect.

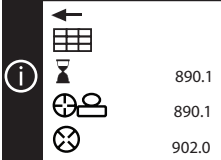
## Viewing the Information Screen

From the Main Menu, when you highlight the Info option and press the Wheel, the Information screen below appears. You cannot change settings on the Information screen.



	890.1
	890.1
	890.1
	902.0

Icon View

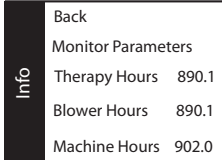

Back	
Monitor Parameters	
Therapy Hours	890.1
Blower Hours	890.1
Machine Hours	902.0

Text View

**Note:** The Information screen is only for reference. Your home care provider may periodically ask you for this information.

**Note:** If an accessory is attached to the therapy device, additional items may appear on the Information screen. Refer to the instructions provided with the accessory for more information.

The following items appear on the Information screen:

- Monitor Parameters - Displays the available parameters.
- Therapy Hours - The device displays the total number of hours that the blower has been on and patient breathing has been detected.
- Blower Hours - Displays the total number of hours that the blower has been on. It can be reset by your home care provider. This setting allows the provider to track device usage between patients.
- Machine Hours - Displays the total number of hours that the blower has been on. This cannot be reset by the home care provider.

## Viewing the Monitor Parameters Screen

There are two ways to access the Monitor Parameters screen:

- From the Monitor Pressure screen, press the Alarm Silence and Ramp keys simultaneously for two seconds.
- From the Information screen, select the Monitor Parameters setting.

The parameters displayed in this screen are described in the following table. A sample screen is shown below.

cmH <sub>2</sub> O 4.0	 6	MinVent 6
Vte 200	RR 10	

Press the Wheel to exit the Monitor Parameters screen and return to the previous screen.

**Note:** The information displayed in the last box shown on the sample screen will vary depending on what accessory is attached to the therapy device. This box will be empty (as shown here) if no accessory is attached. Please refer to the instructions included with your accessory for more information.

## Viewing Measured Parameters

Several measured parameters can be viewed on-screen. The following table describes each measured parameter. The measured parameters that display on the Monitor Pressure screen only appear one at a time. The Setup Parameter Display setting on the Setup screen allows you to choose which measured parameters you want displayed. The parameters below appear on both the Monitor Pressure and Monitor Parameters screens.

Parameter	Description
Pressure	Displays the current patient pressure.
Leak 	The estimated leak is the average leak value for the last 6 breaths. The display is updated at the end of each breath.
Respiratory Rate (RR)	This is the average of the previous 6 breaths. If the mode supports machine-triggered breaths, this display will be the total breathing rate (spontaneous breaths + machine breaths). The display is updated at the end of each breath.
Minute Ventilation (MinVent)	The estimated Exhaled Minute Ventilation is based on the average of the last 6 breaths. The display is updated at the end of each breath.
Exhaled Tidal Volume (Vte)	The estimated Exhaled Tidal Volume is obtained by the integration of patient flow. The display is updated at the end of each breath.

**Note:** If an accessory is attached to the therapy device, additional parameters may appear on-screen. Please refer to the instructions included with your accessory for more information.

## 3. Device Alarms

This chapter describes the ventilator alarms and what you should do if an alarm occurs.

There are three types of alarms:

- High Priority – Require immediate response by the operator
- Medium Priority – Require prompt response by the operator
- Low Priority – Require operator awareness. These alarms alert you to a change in the ventilator status.

Additionally, the ventilator also displays informational messages and confirmation alerts that notify you of conditions that need attention but are not alarm conditions.

### Audible and Visual Alarm Indicators

When an alarm condition occurs:

- The alarm LED indicator on the Alarm Silence/Indicator button lights
- The audible alarm sounds
- A message appears on the screen describing the type of alarm

**Note:** *If multiple alarms occur at the same time, only the highest priority alarm will be active. The precedence is in the following order: high priority, medium priority, then low priority. When multiple priority alarms are active, the highest priority LED light displays and the highest priority audible indicator sounds. On the display screen, the last highest priority alarm displays.*

**Note:** *Informational messages are a lower precedence than alarms and will not display on the screen if any alarm is active.*



## Alarm LED Indicators

The Alarm Silence/Indicator button lights up as follows whenever an alarm is detected:

- Red Flashing Indicator – High priority alarm is detected.
- Yellow Flashing Indicator – Medium priority alarm is detected.
- Yellow Solid Indicator – Low priority alarm is detected.

The Alarm Silence/Indicator button does not light up when informational messages display.

## Alert Audible Indicators

An audible indicator sounds whenever a power failure or a high, medium, or low priority alarm is detected. Additionally, an audible indicator sounds for informational messages and to confirm that certain actions have occurred (for example, when an SD card is inserted or removed from the device).

- Ventilator Inoperative – When a ventilator inoperative alarm occurs, a continuous audible indicator sounds. The alarm descriptions later in this chapter display this indicator as: ██████████
- Power Failure – When a power failure occurs, a series of beeps sounds in a 1 beep pattern, repeating one second on, then one second off. The alarm descriptions later in this chapter display this indicator as: • •
- High Priority – When a high priority alarm is active, a series of beeps sounds in the following pattern, which is repeated twice: 3 beeps, a pause, and then 2 more beeps. This indicator continues until the cause of the alarm is corrected or the audible alarm is silenced. The alarm descriptions later in this chapter display this indicator as: ••• •• ••• ••
- Medium Priority – When a medium priority alarm is active, a series of beeps sounds in a 3-beep pattern. This pattern repeats until the cause of the alarm is corrected or the audible alarm is silenced. The alarm descriptions later in this chapter display this indicator as: •••
- Low Priority – When a low priority alarm is active, a series of beeps sounds in a 2-beep pattern. This pattern repeats until the cause of the alarm is corrected or the audible alarm is silenced. The alarm descriptions later in this chapter display this indicator as: ••
- Informational Messages and Confirmation Audible Indicators – When an informational message appears on screen, a brief, 1-beep audible indicator sounds. Additionally, when the device detects that a certain action has been completed (for example, when an SD card is inserted or removed from the device) a brief, 1-beep audible indicator sounds. The descriptions later in this chapter display this indicator as: •

## Silencing an Alarm

You can silence an alarm by pressing the Alarm Silence/Indicator button. This will silence the alarm for one minute. An icon will appear on the screen when the alarm is silenced (  ). If another alarm occurs while the silence period is active, the audible alarm portion of the new alarm will not sound until the silence period expires. When the silence period expires, the alarm's audible alarm is reactivated. Touching the Alarm Silence/Indicator button while the silence period is active will restart the silence period.

## Alarm Message Screens

When an alarm message is activated, an alarm screen is displayed, showing the text or icon specific to the most recent, highest priority alarm.







Pressing the Control Wheel will reset the alarm and remove the alarm screen from the display. Resetting the alarm allows you to return to the previous screen. If multiple alarms occur during the same period of time, the alarm screen will display the higher priority alarm (higher priority alarms take precedence over lower priority alarms).







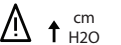

**Note:** *Pressing the Control Wheel resets all alarms.*





**Note:** *If the alarm pop-up is present, you cannot see the Monitor Pressure screen.*





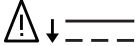

## Alarm Summary Table





The following table summarizes all of the high, medium, and low priority alarms and informational messages.

Alarm	Priority	Audible Indicator	Visual Indicators	Device Action	User Action
Loss of Power	High	• •	Red flashing button; Blank screen	Shuts down	Remove your mask. Check your power connections. Make sure there is power at the outlet or power source. Restore power to the device. If the alarm continues, contact your home care provider for service.
Ventilator Inoperative	High	■	Red solid button;  Ventilator Inoperative - or - (if Icon option is selected) 	Shuts down	Remove your mask. Press the Alarm Silence/Indicator button to silence the alarm. Contact your home care provider for service.
Low Pressure Alarm	High	• • • •	Red flashing button;  Low Pressure - or - (if Icon option is selected)  hPa  cm H <sub>2</sub> O	Operates	This could be caused by an excessive leak or blockage or a device malfunction. Press the Alarm Silence/Indicator button to silence the alarm. Remove your mask. Check for the following: dirty inlet filters, blocked air intake, excessive leak in the patient circuit. If the alarm continues, contact your home care provider.
High Pressure	High	• • • •	Red flashing button  High Pressure - or - (if Icon option is selected)  hPa  cm H <sub>2</sub> O	Operates; If the alarm continues for 10 seconds, the alarm escalates to a Ventilator Inoperative alarm	This may be caused by a malfunctioning device. Press the Alarm Silence/Indicator button to silence the alarm. Remove your mask. Remove power from the device. Restore power. If the alarm continues, contact your home care provider for service.

Alarm	Priority	Audible Indicator	Visual Indicators	Device Action	User Action
Apnea	High	• • • • •	Red flashing button  Apnea  - or - (if Icon option is selected)  	Operates	This alarm is generated when an apnea event occurs during therapy. Press the Alarm Silence/Indicator button to silence the alarm. Report the alarm to your home care provider. Continue using your device.
Low Minute Ventilation	High	• • • • •	Red flashing button  Low Minute Vent  - or - (if Icon option is selected)  	Operates	This alarm occurs when the calculated minute ventilation is less than or equal to the alarm setting. Press the Alarm Silence/Indicator button to silence the alarm. Report the alarm to your home care provider. Continue using your device.
Low Tidal Volume	High	• • • • •	Red flashing button  Low Tidal Volume  - or - (if Icon option is selected)  	Operates	Only enabled if AVAPS therapy feature is enabled; This alarm occurs when the device is unable to reach the target tidal volume setting. Press the Alarm Silence/Indicator button to silence the alarm. Report the alarm to your home care provider. Continue using your device.
Patient Disconnect	High	• • • • •	Red flashing button  Patient Disconnect  - or - (if Icon option is selected)  	Operates	This alarm occurs when the patient circuit is disconnected or has a large leak. Press the Alarm Silence/Indicator button to silence the alarm. Reconnect the patient circuit or fix the leak. If the alarm continues, contact your home care provider for service.

Alarm	Priority	Audible Indicator	Visual Indicators	Device Action	User Action
Low Input Voltage	Medium	• • •	<p>Yellow flashing button</p>  <p>Low Voltage</p> <p>- or - (if Icon option is selected)</p> 	Ventilator Operates; Humidifier shuts down	<p>The alarm is caused when input power at the device, either from an AC outlet or battery, falls below the acceptable limit for 10 seconds.</p> <p>Press the Alarm Silence/Indicator button to silence the alarm. If the device is plugged into a wall outlet, unplug the device and then plug it back in. If the alarm continues to occur, contact your home care provider for service.</p> <p>If you are using a battery, replace the battery or plug the device into an AC outlet. If the alarm continues, contact your home care provider for service.</p>
SD Card Corrupted	Low	• •	<p>Solid yellow button</p>  <p>SD card corrupted</p> <p>- or - (if Icon option is selected)</p> 	Operates	<p>This alarm occurs when a problem exists with the SD card. The data may be corrupted. Press the Alarm Silence/Indicator button to silence the alarm. Contact your home care provider with any questions.</p>
SD Card Full	Low	• •	<p>Solid yellow button</p>  <p>SD card full</p> <p>- or - (if Icon option is selected)</p> 	Operates	<p>This alarm occurs when the SD card is full. Press the Alarm Silence/Indicator button to silence the alarm. Remove the SD card and replace it.</p>

Alarm	Priority	Audible Indicator	Visual Indicators	Device Action	User Action
SD Card: Remove and Reinsert	Low	• •	 Reinsert SD Card  - or - (if Icon option is selected) 	Operates	This alarm occurs when the device cannot read the SD card. The card may be inserted incorrectly. Remove the SD card and reinsert. If the alert continues to occur, replace the SD card or contact your home care provider.
SD Card: Prescription Accepted	Info	•	SD card inserted: prescription accepted  - or - (if Icon option is selected)  	Operates	This info message will be present for 30 seconds or until the user acknowledges it. No action needed.
SD Card: Prescription Rejected	Info	•	SD card inserted: prescription rejected  - or - (if Icon option is selected)  	Operates	This message occurs when the prescription is missing or incorrect. It is present for 30 seconds or until the user acknowledges it. Contact your home care provider for the correct prescription.
SD Card Inserted	Info	•	SD card inserted  - or - (if Icon option is selected)  	Operates	This message occurs when the SD card is inserted into the device. It is present for 30 seconds or until the user acknowledges. No action is needed.
SD Card Removed	Info	•	SD card removed  - or - (if Icon option is selected)  	Operates	This message occurs when the SD card is removed from the device. It is present for 30 seconds or until the user acknowledges it. No action is needed.

Alarm	Priority	Audible Indicator	Visual Indicators	Device Action	User Action
Check Power Alert	Info	None	The following symbol 	Shuts down	The power supply voltage is incorrect. Make sure that you are using the correct power supply with your device. If the alert continues to occur, contact your home care provider.
Humidifier Alert	Info	None	Humidifier LED icon will flash on the device. 	Only displayed when both the humidifier and therapy is on.	Humidifier failure. Alert is present for 12 minutes or until the condition is fixed. Turn off airflow and reconnect the humidifier to the device according to the humidifier instructions. If the alert continues to occur, contact your home care provider.
Power Supply Alert	Info	None	Humidifier LED icon will flash for 30 seconds. 	Only displayed when incorrect power supply is used with the heated tube.	Using wrong power supply. Alert is present for 30 seconds or until the condition is fixed. You must use the 80W power supply when using the heated tube. If the alert continues to occur, contact your home care provider.
Heated Tube Error Alert	Info	None	Humidifier LED icon will slowly flash for 30 seconds. 	Alert present for 30 seconds or until condition is fixed.	Tubing may be overheating or malfunctioning. Alert is present for 30 seconds or until the condition is fixed. Turn off airflow and reconnect the heated tubing to the humidifier according to the humidifier instructions. If the alert continues to occur, contact your home care provider.
Humidifier Failure	Info	None	Flashing humidifier LED icon 	Device operate; Humidifier shuts down	Alert is present for 12 minutes or until the condition is fixed. Turn off airflow and reconnect the humidifier to the device according to the humidifier instructions. If the alert continues to occur, contact your home care provider.

## Troubleshooting

The table below lists some of the problems you may experience with your device and possible solutions to those problems.

Problem	Why It Happened	What To Do
<p>Nothing happens when you apply power to the device. The backlight on the buttons does not light.</p>	<p>There is no power at the outlet or the device is unplugged.</p>	<p>If you are using AC power, check the outlet and verify that the device is properly plugged in. Make sure there is power available at the outlet. Make sure the AC power cord is connected correctly to the power supply and the power supply cord is securely connected to the device's power inlet. If the problem continues to occur, contact your home care provider. Return both the device and power supply to your provider so they can determine if the problem is with the device or power supply.</p> <p>If you are using DC power, make sure your DC power cord and battery adapter cable connections are secure. Check your battery. It may need recharged or replaced. If the problem persists, check the DC cord's fuse following the instructions supplied with your DC cord. The fuse may need to be replaced. If the problem still occurs, contact your home care provider.</p>
<p>The airflow does not turn on.</p>	<p>There may be a problem with the blower.</p>	<p>Make sure the device is powered correctly. Make sure "Therapy" or  is highlighted when pressing the control Wheel to start airflow. If the airflow does not turn on, there may be a problem with your device. Contact your home care provider for assistance.</p>
<p>The device display is erratic.</p>	<p>The device has been dropped or mishandled, or the device is in an area with high Electromagnetic Interference (EMI) emissions.</p>	<p>Unplug the device. Reapply power to the device. If the problem continues, relocate the device to an area with lower EMI emissions (away from electronic equipment such as cellular phones, cordless phones, computers, TVs, electronic games, hair dryers, etc.). If the problem still occurs, contact your home care provider for assistance.</p>



Problem	Why It Happened	What To Do
The Device will not turn off.	The correct blower off sequence was not followed.	Select Therapy to go back to the Monitor Pressure screen. Push and hold the knob for 2 seconds.
The Ramp feature does not work when you press the Ramp button.	Your home care provider did not prescribe Ramp for you, or your pressure is already set to the minimum setting.	If Ramp has not been prescribed for you, the Ramp feature will not work. If your provider has enabled Ramp but the feature still does not work, check the pressure setting on your Monitor Pressure screen. If the pressure is set to the minimum setting, or the starting pressure is the same as the prescribed pressure, the Ramp feature will not work.
The airflow is much warmer than usual.	The air filters may be dirty.  The device may be operating in direct sunlight or near a heater.	Clean or replace the air filters.  The temperature of the air may vary somewhat based on your room temperature. Make sure the device is properly ventilated. Keep it away from bedding or curtains that could block the flow of air around the device. Make sure the device is away from direct sunlight and heating equipment.  If using the humidifier with the device, check the humidifier settings. Refer to the humidifier instructions to make sure the humidifier is working properly.
The airflow pressure feels too high or too low.	The Tubing type setting may be incorrect.	Make sure the Tubing type setting (22 or 15) matches the tubing that you are using (Philips Respironics 22 or 15 mm tubing). If you are using the Heated Tubing, this setting will be 15H and you cannot change it.

Problem	Why It Happened	What To Do
<p>Tube Temperature is turned on in "Setup" screen but Heated Tubing is not warm.</p> <p>Tube Temperature is turned on in "Setup" screen but Humidifier LED does not stay orange.</p>	<p>Incorrect power supply is being used (60W is used instead of 80W).</p> <p>Heated Tubing is attached incorrectly or damaged.</p>	<p>Make sure the 80W power supply is being used. This can be confirmed by looking at the power supply for the 60W or 80W symbols. This can also be checked by looking at the "Humidifier" settings under the "Setup" screen.</p> <p>Inspect Heated Tubing for damage and reconnect. If the problem continues, contact your home care provider.</p>
<p>The mask feels uncomfortable to wear, there is significant air leakage around the mask, or you experiences other mask-related issues.</p>	<p>This could be due to improper headgear adjustment or improper mask fitting.</p>	<p>Make sure you are properly fitted with the correct size mask. If the problem continues, contact your home care provider to be fitted with a different mask.</p>
<p>You have a runny nose.</p>	<p>This may be caused by a nasal reaction to the airflow.</p>	<p>Contact your home care provider.</p>



## 4. Accessories

There are several accessories available for your BiPAP AVAPS system, such as a humidifier. Contact your home care provider for additional information on the available accessories. When using the optional accessories, always follow the instructions enclosed with the accessories.

### Adding a Humidifier with or without Heated Tubing

You can use the heated humidifier and the heated tube with your device. They are available from your home care provider. A humidifier and heated tube may reduce nasal dryness and irritation by adding moisture to the airflow.

**Note:** Refer to the humidifier's instructions for complete setup information.

### SD Card

The system comes with an SD card inserted in the SD card slot on the back of the device to record information for the home care provider. Your home care provider may ask you to periodically remove the SD card and send it to them for evaluation.

**Note:** The SD card does not need to be installed for the device to work properly. The SD card records device usage information for your home care provider. You can refer to the Device Alarms chapter of this manual for more information on the SD card. Contact your home care provider if you have any questions about the SD card.

### Supplemental Oxygen

Oxygen may be added anywhere in the patient circuit provided that a pressure valve is used. Please note the warnings in Chapter 1 when using oxygen with the device.

## Shielded DC Cord

The Philips Respironics Shielded DC Cord can be used to operate this device in a stationary recreational vehicle, boat, or motor home. The Philips Respironics DC Battery Adapter Cable, when used with the Shielded DC Cord, enables the device to be operated from a 12 VDC free-standing battery. Refer to the instructions supplied with the Shielded DC Cord and adapter cable for information on how to operate the device using DC power.



**Caution:** When DC power is obtained from a vehicle battery, the device should not be used while the vehicle's engine is running. The device may not work properly if connected while the vehicle's engine is running.



**Caution:** Only use a Philips Respironics Shielded DC Cord and Battery Adapter Cable. Use of any other system may cause damage to the device or vehicle.

## Carrying Case

When traveling, the carrying case is for carry-on luggage only. The carrying case will not protect this system if it is put through checked baggage.

For your convenience at security stations, there is a note on the bottom of the device stating that it is medical equipment. It may be helpful to bring this manual along with you to help security personnel understand the BiPAP AVAPS device.

If you are traveling to a country with a line voltage different than the one you are currently using, a different power cord or an international plug adapter may be required to make your power cord compatible with the power outlets of the country to which you are traveling. Contact your home care provider for additional information.

**Note:** If you are using a humidifier with the device, the humidifier should be emptied before traveling.

## Airline Travel

The device is suitable for use on airlines when it is operating from an AC or DC power source.

**Note:** The device is not suitable for airline use with any modems or humidifiers installed.

## 5. Cleaning the Device

Follow the instructions below to clean the device. If you are using the device on multiple users, complete the following steps before each new user.



**Warning:** *If you are using the device on multiple users, discard and replace the bacteria filter each time the device is used on a different person.*

1. Unplug the device before cleaning.
2. Clean the outside of the device only. Use a cloth with one of the following cleaning agents to clean the exterior of the device.
  - Mild detergent
  - 70% Isopropyl Alcohol
  - DisCide Towelettes
  - 10% Chlorine bleach solution
3. Allow the device to dry completely before plugging in the power cord.
4. Inspect the device and all circuit parts for damage after cleaning. Replace any damaged parts.

### Cleaning or Replacing the Filters

Under normal usage, you should clean the gray foam filter at least once every two weeks and replace it with a new one every six months.

1. If the device is operating, stop the airflow. Disconnect the device from the power source.
2. Remove the filter from the enclosure by gently squeezing the filter in the center and pulling it away from the device.
3. Examine the filter for cleanliness and integrity.

4. Wash the gray foam filter in warm water with a mild detergent. Rinse thoroughly to remove all detergent residue. Allow the filter to air dry completely before reinstalling it. If the foam filter is torn, replace it. (Only Philips Respironics-supplied filters should be used as replacement filters.)
5. Reinstall the filter.

## Cleaning the Tubing

Clean the flexible tubing before first use and daily. Disconnect the flexible tubing from the device. For the 15 or 22 mm flexible tubing, gently wash the tubing in a solution of warm water and a mild detergent. Rinse thoroughly. Air dry.

*Note: Refer to the humidifier manual for the instructions on how to clean the heated tube.*

## Service

The device does not require routine servicing.

## 6. Specifications

### Environmental

	Operating	Storage
<b>Temperature</b>	41° F to 95° F (5° C to 35° C)	-4° F to 140° F (-20° C to 60° C)
<b>Relative Humidity</b>	15 to 95% (non-condensing)	15 to 95% (non-condensing)
<b>Atmospheric Pressure</b>	101 kPa to 77 kPa (0-7500 ft / 0-2286 m)	N/A

### Physical

Dimensions: 7" L x 5.5" W x 4" H (18 cm x 14 cm x 10 cm)

Weight: Approximately 3 lbs (1.36 kg)

### Standards Compliance

This device is designed to conform to the following standards:

- IEC 60601-1: Medical Electrical Equipment – Part 1: General Requirements for Basic Safety and Essential Performance
- IEC 60601-1-2: Medical Electrical Equipment – Part 1-2: General Requirements for Basic Safety and Essential Performance – Collateral standard: Electromagnetic compatibility - Requirements and tests
- IEC 60601-1-8: Medical Electrical Equipment – Part 1-8: General Requirements for Basic Safety and Essential Performance – Collateral standard: General Requirements, tests and guidance for alarm systems in medical electrical equipment and medical electrical systems
- IEC 60601-1-11: Medical Electrical Equipment – Part 1-11: General Requirements for Basic Safety and Essential Performance – Collateral standard: Requirements for medical electrical equipment and medical electrical systems used in the home healthcare environment
- ISO 10651-6: Lung Ventilators for Medical Use – Particular Requirements for Basic Safety and Essential Performance, Part 6. Home care ventilatory support devices
- RTCA DO-160F Section 21, Category M; Emission of Radio Frequency Energy



## Electrical

AC Power Consumption (with 60W power supply): 100 to 240 VAC, 50/60 Hz, 2.1 A

AC Power Consumption (with 80W power supply): 100 to 240 VAC, 50/60 Hz, 2.0 A

DC Power Consumption: 12 VDC, 5.0 - 6.67 A

Fuses: There are no user-replaceable fuses.

Type of Protection Against Electric Shock: Class II

Degree of Protection Against Electric Shock: Type BF Applied Part

Degree of Ingress Protection: Device Drip Proof  
(Device and AC power supply): IP22

Mode of Operation: Continuous

## Pressure

Pressure Increments: 4.0 to 30.0 cm H<sub>2</sub>O (in 1.0 cm H<sub>2</sub>O increments)

Flex Therapy Feature: Off, 1, 2, 3

## Control Accuracy

Parameter	Range	Accuracy
IPAP	4 – 30 cm H <sub>2</sub> O	± 2.5 cm H <sub>2</sub> O*
EPAP	4 – 30 cm H <sub>2</sub> O	± 2.5 cm H <sub>2</sub> O*
CPAP	4 – 20 cm H <sub>2</sub> O	± 2.5 cm H <sub>2</sub> O*
Breath rate	0 to 30 BPM	greater of ± 1 BPM or ±10% of setting
Inspiration time	0.5 to 3 seconds	± (10% of setting + 0.1 second).

\*Pressure measured at the patient connection port with or without the humidifier (no patient flow, with Whisper Swivel II).

## Displayed Parameter Accuracy

Parameter	Accuracy	Resolution	Range
Estimated Leak Rate	$\pm(5+15\%$ of reading) LPM	1 LPM	0 to 200 LPM
Exhaled Tidal Volume	$\pm(25+15\%$ of reading) ml	5 ml	0 to 2000 ml
Respiratory Rate	Greater of $\pm 1$ BPM or $\pm 10\%$ of reading	1 BPM	0 to 60 BPM
Exhaled Minute Ventilation	$\pm(1+15\%$ of reading) LPM	1 LPM	0 to 99 LPM

## Spontaneous Breathing During Power Failure Conditions

Patient Flow (LPM)	Expiratory Resistance (cm H <sub>2</sub> O) Passive Circuit	Inspiratory Resistance (cm H <sub>2</sub> O) Passive Circuit
30	<1.0	<1.0
60	<2.8	<2.8

## Noise

Minimum Alarm Sound Level: 45 dB(A)

## Disposal

Dispose of the device in accordance with local regulations.



# BiPAP AVAPS

user manual

## 7. EMC Information

Guidance and Manufacturer's Declaration - Electromagnetic Emissions – This device is intended for use in the electromagnetic environment specified below. The user of this device should make sure it is used in such an environment.

Emissions Test	Compliance	Electromagnetic Environment - Guidance
RF emissions CISPR 11	Group 1	The device uses RF energy only for its internal function. Therefore, its RF emissions are very low and are not likely to cause any interference in nearby electronic equipment.
RF emissions CISPR 11	Class B	The device is suitable for use in all establishments, including domestic establishments and those directly connected to the public low-voltage power supply network.
Harmonic emissions IEC 61000-3-2	Class A	
Voltage fluctuations/Flicker emissions IEC 61000-3-3	Complies	

Guidance and Manufacturer's Declaration - Electromagnetic Immunity – This device is intended for use in the electromagnetic environment specified below. The user of this device should make sure it is used in such an environment.

Immunity Test	IEC 60601 Test Level	Compliance Level	Electromagnetic Environment - Guidance
Electrostatic Discharge (ESD) IEC 61000-4-2	±6 kV contact  ±8 kV air	±6 kV contact  ±8 kV air	Floors should be wood, concrete or ceramic tile. If floors are covered with synthetic material, the relative humidity should be at least 30%.
Electrical fast Transient/burst IEC 61000-4-4	±2 kV for power supply lines  ±1 kV for input-output lines	±2 kV for supply mains  ±1 kV for input/output lines	Mains power quality should be that of a typical home or hospital environment.
Surge IEC 61000-4-5	±1 kV differential mode  ±2 kV common mode	±1 kV differential mode  ±2 kV for common mode	Mains power quality should be that of a typical home or hospital environment.
Voltage dips, short interruptions and voltage variations on power supply input lines IEC 61000-4-11	<5% $U_T$ (>95% dip in $U_T$ ) for 0.5 cycle 40% $U_T$ (60% dip in $U_T$ ) for 5 cycles 70% $U_T$ (30% dip in $U_T$ ) for 25 cycles <5% $U_T$ (>95% dip in $U_T$ ) for 5 sec	<5% $U_T$ (>95% dip in $U_T$ ) for 0.5 cycle 40% $U_T$ (60% dip in $U_T$ ) for 5 cycles 70% $U_T$ (30% dip in $U_T$ ) for 25 cycles <5% $U_T$ (>95% dip in $U_T$ ) for 5 sec	Mains power quality should be that of a typical home or hospital environment.  If the user of the device requires continued operation during power mains interruptions, it is recommended that the device be powered from an uninterruptible power supply or a battery.
Power frequency (50/60 Hz) magnetic field IEC 61000-4-8	3 A/m	3 A/m	Power frequency magnetic fields should be at levels characteristic of a typical location in a typical hospital or home environment.
NOTE: $U_T$ is the a.c. mains voltage prior to application of the test level.			

Guidance and Manufacturer's Declaration - Electromagnetic Immunity – This device is intended for use in the electromagnetic environment specified below. The user of this device should make sure it is used in such an environment.

Immunity Test	IEC 60601 Test Level	Compliance Level	Electromagnetic Environment -Guidance
Conducted RF IEC 61000-4-6	3 Vrms 150 kHz to 80 MHz	3 Vrms	<p>Portable and mobile RF communications equipment should be used no closer to any part of the device, including cables, than the recommended separation distance calculated from the equation applicable to the frequency of the transmitter.</p> <p>Recommended separation distance</p> $d = 1.2 \sqrt{P}$ <p><math>d = 1.2 \sqrt{P}</math>      80 MHz to 800 MHz</p> <p><math>d = 2.3 \sqrt{P}</math>      800 MHz to 2.5 GHz</p> <p>where P is the maximum output power rating of the transmitter in watts (W) according to the transmitter manufacturer and d is the recommended separation distance in meters (m).</p> <p>Field strengths from fixed RF transmitters, as determined by an electromagnetic site survey<sup>a</sup>, should be less than the compliance level in each frequency range.<sup>b</sup></p> <p>Interference may occur in the vicinity of equipment marked with the following symbol: </p>
Radiated RF IEC 61000-4-3	3 V/m 80 MHz to 2.5 GHz	3 V/m	
<p>NOTE 1 At 80 MHz and 800 MHz, the higher frequency range applies.</p> <p>NOTE 2 These guidelines may not apply in all situations. Electromagnetic propagation is affected by absorption and reflection from structures, objects, and people.</p> <p>a Field strengths from fixed transmitters, such as base stations for radio (cellular/cordless) telephones and land mobile radios, amateur radio, AM and FM radio broadcast and TV broadcast cannot be predicted theoretically with accuracy. To assess the electromagnetic environment due to fixed RF transmitters, an electromagnetic site survey should be considered. If the measured field strength in the location in which the device is used exceeds the applicable RF compliance level above, the device should be observed to verify normal operation. If abnormal performance is observed, additional measures may be necessary, such as re-orienting or relocating the device.</p> <p>b Over the frequency range 150 kHz to 80 MHz, the field strengths should be less than 3 V/m.</p>			

Recommended Separation Distances between Portable and Mobile RF Communications Equipment and This Device: The device is intended for use in an electromagnetic environment in which radiated RF disturbances are controlled. The customer or the user of this device can help prevent electromagnetic interference by maintaining a minimum distance between portable and mobile RF communications equipment (transmitters) and this device as recommended below, according to the maximum output power of the communications equipment.

Rated Maximum Power		Separation Distance According to Frequency of Transmitter		
Output of Transmitter		m		
W	150 kHz to 80 MHz $d = 1.2 \sqrt{P}$	80 MHz to 800 MHz $d = 1.2 \sqrt{P}$	800 MHz to 2.5 GHz $d = 2.3 \sqrt{P}$	
0.01	0.12	0.12	0.23	
0.1	0.38	0.38	0.73	
1	1.2	1.2	2.3	
10	3.8	3.8	7.3	
100	12	12	23	

For transmitters rated at a maximum output power not listed above, the recommended separation distance  $d$  in meters (m) can be estimated using the equation applicable to the frequency of the transmitter, where  $P$  is the maximum output power rating of the transmitter in watts (W) according to the transmitter manufacturer.

Note 1: At 80 MHz and 800 MHz, the separation distance for the higher frequency range applies.

Note 2: These guidelines may not apply in all situations. Electromagnetic propagation is affected by absorption and reflection from structures, objects, and people.

# BiPAP AVAPS

## user manual

# Limited Warranty

Respironics, Inc. warrants that the system shall be free from defects of workmanship and materials and will perform in accordance with the product specifications for a period of two (2) years from the date of sale by Respironics, Inc. to the dealer. If the product fails to perform in accordance with the product specifications, Respironics, Inc. will repair or replace – at its option – the defective material or part. Respironics, Inc. will pay customary freight charges from Respironics, Inc. to the dealer location only. This warranty does not cover damage caused by accident, misuse, abuse, alteration, water ingress, and other defects not related to material or workmanship. The Respironics, Inc. Service department shall examine any devices returned for service, and Respironics, Inc. reserves the right to charge an evaluation fee for any returned device as to which no problem is found after investigation by Respironics, Inc. Service.

This warranty is non-transferable by unauthorized distributors of Respironics, Inc. products and reserves the right to charge dealers for warranty service of failed product not purchased directly from Respironics or authorized distributors.

Respironics, Inc. disclaims all liability for economic loss, loss of profits, overhead, or consequential damages which may be claimed to arise from any sale or use of this product. Some states do not allow the exclusion or limitation of incidental or consequential damages, so the above limitation or exclusion may not apply to you.

This warranty is given in lieu of all other express warranties. In addition, any implied warranties – including any warranty of merchantability or fitness for the particular purpose – are limited to two years. Some states do not allow limitations on how long an implied warranty lasts, so the above limitation may not apply to you. This warranty gives you specific legal rights, and you may also have other rights which vary from state to state.

To exercise your rights under this warranty, contact your local authorized Respironics, Inc. dealer or contact Respironics, Inc. at:

1001 Murry Ridge Lane  
Murrysville, Pennsylvania 15668-8550  
1-724-387-4000



