



# 2024

Corona Chrome  
Cadillac Catalog



PRICES ARE SUBJECT TO CHANGE  
2024 v1

CORONACHROME.com 619-251-9089   @coronachrome



### How to read this catalog.

Due to the potential age of some items, original equipment and new equipment items are designated with one or two asterisks below the photo of the category.

\* = Original Equipment

\*\* = New Equipment

Certain items qualify for an optional core exchange. Core value is deducted from total cost when received. If you see this symbol inquire to receive a core exchange discount value.

{CE\$} = Qualifies for Core Exchange

Don't see something you're looking for? Contact us with questions/comments.

Call or Text 619-251-9089

Email: [sixonebubble@gmail.com](mailto:sixonebubble@gmail.com)

### Gift Cards Available



Corona Chrome Gift Cards - Any denomination \$25 minimum. Contact us today to purchase your gift certificate today.

### Pricing

Every attempt is made to keep our prices as close to the current catalog list price as possible. However, because of price fluctuations from our suppliers, equipment sourcing and volume buying, the price of some items may increase or decrease accordingly.

### Returns

Before returning any part(s), a return authorization number is required. Returns without an RA number will delay the credit or exchange and in some cases, they will be returned to you. Some items are not returnable depending on application and condition of item(s). However, we may consider purchasing them from you depending on condition and application. All



returns are subject to up to a 20% restocking fee. Shipping is subjective on each individual issue.

## TABLE OF CONTENTS

**STEERING LINKAGE SETS ----- 2**

**STEERING COMPONENTS ----- 3**

**SUSPENSION ----- 4-6**

**HOOD HINGES & WIPERS ----- 7**

**ENGINE COMPARTMENT ----- 8-9**

**UNDERBELLY CHROME -----10**

**BRAKE DRUMS & COMPONENTS ----- 11**

**HARDWARE ----- 12-13**

**BUSHING AND BOOT SETS ----- 14-15**

**BODY MOUNT BUSHING SETS ----- 16**

**DUST SHIELDS AND SEALS ----- 17**

**ALL PRICES SUBJECT TO CHANGE WITHOUT NOTICE. ANY INSTALLED PART IS NOT RETURNABLE**

## STEERING LINKAGE



**77-96 Cadillac With Damper Shock Steering Linkage v1.a**

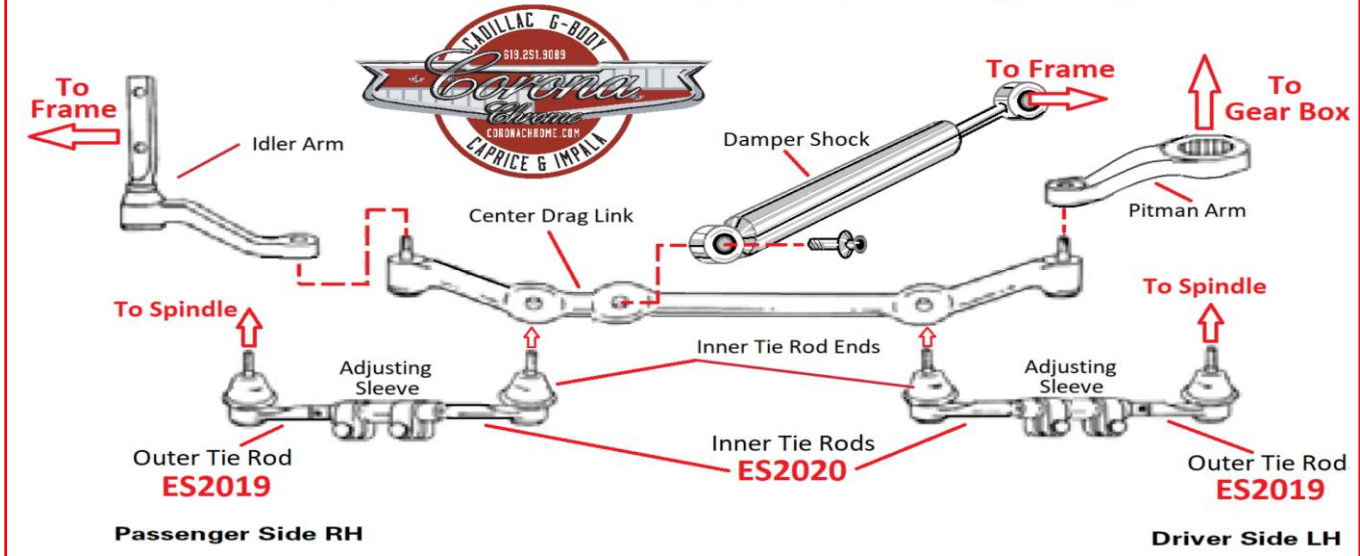

**1977-1996 Cadillac**

**With Damper Shock**

- 1977-1984 Cadillac DeVille RWD
- 1977-1992 Cadillac Brougham RWD
- 1993-1996 Cadillac Fleetwood



**\*\*New-In-Box Equipment**

**PITMAN ARM SOLD SEPARATELY**

Includes Centerlink, Idler Arm, Damper Shock, Inner & Outer Tie Rods w/Sleeves, Black Boots, Zerks, Nuts & Cotter Pins

- \*\*SL7796-CAD (Black Boots) ----- \$750**
- Add Color Boots ----- \$50 Extra**
- Add HEX Sleeves (Billet) ----- \$50 Extra**
- Heavy Duty Centerlink ----- \$75 Extra**
- Heavy Duty Tie Rods ----- \$100 Extra**
- Heavy Duty Idler Arm ----- \$50 Extra**

**\*\*Individual Components**

- CL7796-CAD (Center Link) ----- \$225**
- PC7796-CAD (Damper Shock) ----- \$200**
- IA7796-ICG (Idler Arm) ----- \$150**
- TR7796-ICC (x4 Tie Rods) ----- \$300**
- AS7196-ICC (Adj. Sleeves) ----- \$125 pr**
- \*PA7796-CAD (Pitman Arm) ----- \$175**

**1977-1996 Impala/Caprice**

**1977-1984 Cadillac**

**Deville/Fleetwood**

**Without Damper Shock**



**\*\*New-In-Box Equipment**

**PITMAN ARM SOLD SEPARATELY**

Set includes Centerlink, Idler Arm, Inner & Outer Tie Rods w/Sleeves, Black Boots, Zerks, Nuts & Cotter Pins

- \*\*SL7796-IMP (Set) ----- \$650**
- Add Color Boots ----- \$50 Extra**
- Add HEX Sleeves (Billet) ----- \$50 Extra**
- Heavy Duty Centerlink ----- \$75 Extra**
- Heavy Duty Tie Rods ----- \$100 Extra**
- Heavy Duty Idler Arm ----- \$50 Extra**

**\*\*Individual Components**

- CL7796-IMP (Centerlink) ----- \$225**
- IA7796-ICG (Idler Arm) ----- \$150**
- TR7796-ICC (x4 Tie Rods) ----- \$300**
- AS7196-ICC (Adj. Sleeves) ----- \$125 pr**
- \*PA7796-CAD (Pitman Arm) ----- \$175**

**STEERING LINKAGE COMPONENTS**



3

**1977-1996  
Cadillac/Caprice/Impala**



\*\*New Equipment

**TR7796-XXX(Tie Rods w/Sleeves) -- \$350  
Options**

**Color Boots ----- \$50 Extra  
Add HEX Sleeves (Billet) ----- \$50 Extra  
Heavy Duty Tie Rods ----- \$100 Extra**

**TIE ROD DUST BOOTS**



**Universal Color Boots**

Available for Tie Rods, Idler Arm,  
Pitman Arm, and Centerlink

-BLK (Black)	
BRN (Brown)	RED (Red)
-LBL (Light Blue)	-DRD (Dark Red)
-BLU (Blue)	-LGN(Light Green)
-DBL (Dark Blue)	-GRN (Green)
-ORG (Orange)	-DGN(Dark Green)
-PPL (Purple)	-PNK (Pink)
-TEA (Teal)	-YLW (Yellow)
-WHT (White)	-GLD (Gold)

**CENTERLINK**



\*\*New Equipment

**1977-1996 Cadillac**

With Damper Shock Mounting Hole  
**CL7796-CAD ----- \$225  
CL7796-HDC (Heavy Duty) ----- \$300**



\*\*New Equipment

**1977-1996 Cadillac/Impala/Caprice**

WITHOUT Damper Shock Mounting Hole  
**CL7796-ICC ----- \$225  
CL7796-HDI (Heavy Duty) ----- \$300**

**DAMPER SHOCK**



\*\*New Equipment

**1977-1996 Cadillac**

**PC7784-CAD(Dia=1-5/8",L=15-1/2") - \$200  
PC8795-CAD(Dia=1-7/8",L=15-5/8") - \$200  
PC1996-CAD (Dia=1-5/8",L=17") --- \$200**

**IDLER ARM**



\*\*New Equipment

**1977-1996 Cadillac/Impala/Caprice**

**IA7796-ICG-----\$150  
IA7796-HD (Heavy Duty) ----- \$200  
ADD \$15 for Color Boot**

**PITMAN ARM**



\*Original Equipment

\*\*New Equipment

**1977-1996 Cadillac/Caprice**

**\*PA7796-ICC ----- \$200  
\*\*PA7796-HDC (Heavy Duty) ---- \$250**

**COUPLER (RAG JOINT)**



\*\*New-In-Box Equipment

Photo shows front and back  
Includes Coupler and Hardware.

**1977-1996 Cadillac/Impala/Caprice  
RJ205-26 3/4" 26 Spline 3/4"OD-\$100  
1977-1996 Cadillac RWD  
SS7796-CAD-----\$350**



# SUSPENSION

## FRONT SWAYBAR



\*Original Equipment/{CES}

1977-1996 Cadillac/Caprice/Impala  
SB7796-FRT-----\$450

## REAR SWAYBAR



\*Original Equipment/{CES}

1977-1996 Cadillac/Caprice/Impala  
SB7796-RTK (Thick) ----- \$450  
SB7796-RTN (Thin) ----- \$400

## FRONT SWAYBAR BRACKETS



\*New & \*\*Original Equipment/{CES}

1977-1996 Cadillac

SB7796-BKT (Brackets Only) ----- \$100  
SBBU30-XXX(Color Bushings ONLY)- \$30  
HW7196-BKT (x4 Polished SS Bolts) -\$30

### AVAILABLE BUSHING COLORS

-XXX= COLOR

-BLK (Black)	NGY (Nardo Gray)
BRN (Brown)	RED (Red)
-LBL (Light Blue)	-DRD (Dark Red)
-BLU (Blue)	-LGN(Light Green)
-DBL (Dark Blue)	-GRN (Green)
-ORG (Orange)	-DGN(Dark Green)
-PPL (Purple)	-PNK (Pink)
-TEA (Teal)	-YLW (Yellow)
-WHT (White)	-GLD (Gold)

## UPPER CONTROL ARM SHAFTS

"Dogbones"



\*\*New Equipment

Includes Control Shafts, Bushings,  
Washers and Nuts

1977-1996 Cadillac/Caprice

\*\*DB7796-ICC ----- \$350pr  
\*\*DB7796-HDC (Heavy Duty) --- \$425pr

## SPINDLES



\*Original Equipment/{CES}

1977-1996 Cadillac/Caprice

SPIN77-96C ----- \$700pr

## REAR SHOCKS



\*New Equipment

77-96 Cadillac (RWD)

RSHKCA-STD (Stock Length) ---- \$300

77-96 Cadillac (RWD)

RSHKGC-EXT (Extended Length) -- \$350

## SWAYBAR LINKS



\*\*New Equipment

Includes Bolts, washers, bushings and sleeves

1977-1996 Cadillac RWD Fleetwood

LK5252-BLK (Black)-----\$80  
LK5252-XXX (Color)-----\$95  
LK5252-BEG (Beige)-----\$95



Black



Pink



Red



Blue



# SUSPENSION Cont.

ALL BALL JOINTS are NEW EQUIPMENT and INCLUDE: Ball Joints, Dust Boots, Hardware, Zerk Fittings & Cotter Pins

## STANDARD DUTY

### 4 BOLT UPPER BALL JOINTS



1977-1996 Cadillac/Impala/Caprice  
BJ5208-BLK (Black) ----- \$175  
BJ5208-XXX (Includes Color Boots)-\$200

### AVAILABLE BOOT COLORS

-XXX= COLOR

-BLK (Black)	
BRN (Brown)	RED (Red)
-LBL (Light Blue)	-DRD (Dark Red)
-BLU (Blue)	-LGN(Light Green)
-DBL (Dark Blue)	-GRN (Green)
-ORG (Orange)	-DGN(Dark Green)
-PPL (Purple)	-PNK (Pink)
-TEA (Teal)	-YLW (Yellow)
-WHT (White)	-GLD (Gold)

## HEAVY DUTY (UNBREAKABLE)

### 4 BOLT UPPER BALL JOINTS



1977-1996 Cadillac/Impala/Caprice  
HD5208-BLK (Black) ----- \$225  
HD5208-XXX (Includes Color Boots)- \$250

## LOWER BALL JOINTS

### Standard and Heavy Duty



1977-1996 Cadillac/Impala/Caprice

BJ6145-BLK (Black) ----- \$175  
BJ6145-XXX (Includes Color Boots)- \$200  
HD6145-BLK (Heavy Duty Black) -- \$225  
HD6145-XXX (Heavy Duty Color) --- \$250



# SUSPENSION Cont.

## CONTROL ARM BUSHINGS



## BUSHINGS



\*\*New Equipment

**1980-1996 Cadillac/Impala/Caprice**  
BK6198-FUC (Front Upr Set of 4)-\$100

**1980-1996 Cadillac**  
BK6109-FLC (Front Lwr Set of 4) -\$100

**1977-1996 Cadillac**  
BK6111-RUC (Rear Upr Set of 4) -\$100  
BK6116-RLC (Rear Lwr Set of 4) - \$100

## 1977-1996 Cadillac



\*\*New Equipment

**BK8096-FRD (Front Set of 8 Cadi) --\$250**

## A-ARM BUSHING COVERS

Set Includes covers for 4 Bushings  
\*A-Arms and Bushings sold separately

### \*Orange Bushings



### Orange Bushing Covers



**BCVGCU-XXX (GBody/Cadillac)----- \$60**

**BCVGCL-XXX (GBody/Cadillac)----- \$60**



# HOOD HINGES & WIPERS

## 1978-1992 CADILLAC



\*Original Equipment/{CE\$}

Includes Hinges and Springs

**HH7892-CAD-----\$350**

## 1993-1996 CADILLAC/CAPRICE



\*Original Equipment/{CE\$}

**HH9396-ICC-----\$250**

## HOOD LIFT SUPPORTS



\*\*New Equipment

1993-1996 Cadillac Fleetwood

**HS9396-CAD-----\$160**

## WIPER ARMS



\*\*Original Equipment/{CE\$}

1977-1992 Cadillac/Caprice

**WA7792-CC-----\$175**



\*Original Equipment/{CE\$}

1977-1996 Cadillac

**WA7792-CAD -----\$175**

**WA9396-CAD -----\$175**





# ENGINE COMPARTMENT

## HOOD LATCH SET



\*Original Equipment/{CE\$}  
Includes Hood Latch, Hook and Spring  
1977-1992 Cadillac RWD  
HL7792-CAD-----\$300

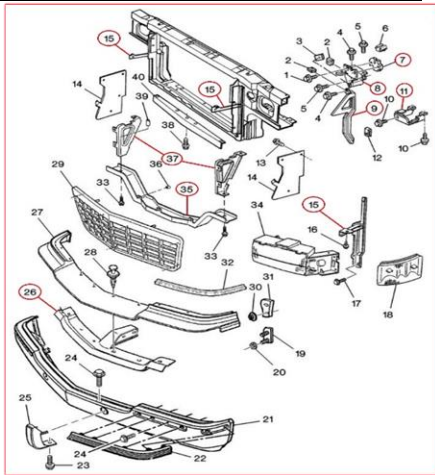

## GRILL BRACKET & LATCH SET



\*Original Equipment/{CE\$}  
Includes Hood Latch, Hook, Spring,  
Grill Brackets & Vertical Support  
1993-1996 Cadillac Fleetwood  
HL9396-CAD-----\$1000

## GRILL SUPPORT BRACKETS



\*Original Equipment/{CE\$}  
Includes Grill Support Brackets ONLY  
1993-1996 Cadillac Fleetwood  
GS9396-3PC-----\$450

## FRONT VALANCE BRACKET



\*Original Equipment  
1993-1996 Cadillac Fleetwood  
VB9396-CAD-----\$200

## VERTICAL SUPPORT BRACKET



\*Original Equipment/{CE\$}  
Includes Support Bracket ONLY  
1993-1996 Cadillac Fleetwood  
VS9396-1PC-----\$200

## DUST GUARD BRACKETS



\*Original Equipment/{CE\$}  
Includes 2 Rods and 4 Bolts  
1993-1996 Cadillac Fleetwood  
DG9396-BKT-----\$200

## ENGINE SUPPORT BARS



\*Original Equipment/{CE\$}  
1977-1992 Cadillac Brougham  
EB7792-4BR (4 Bars)-----\$400  
EB7792-6BR (6 bars)-----\$500

## FENDER TO COWL BARS



\*Original Equipment/{CE\$}  
1993-1996 Cadillac Brougham  
FC9396-BAR-----\$200

## RADIATOR COVER



\*Original Equipment/{CE\$}  
1978-1987 G Body  
RC7887-G-----\$300  
1977-1992 Cadillac Fleetwood  
RC7792-CAD-----\$300

## RADIATOR SUPPORT RODS



\*Original Equipment  
Includes 2 Rods and 4 Bolts  
1977-1996 Cadillac Fleetwood  
RR7796-CAD-----\$150

## AC ACCUMULATOR TANK



\*\*New & Original Equipment/{CE\$}  
1977-1992 Cadillac/Caprice  
DC7792-----\$150  
1993-1996 Cadillac/Caprice  
DC9396-----\$150



## ENGINE COMPARTMENT Cont.

### AC BLOWER MOTOR



**\*\*New Equipment**

**1977-1992 Cadillac RWD**

**1977-1985 Impala**

**1977-1990 Caprice**

**BM105-ICG (with AC)-----\$175**



**1993-1996 Cadillac Fleetwood**

**BM131-CAD -----\$175**

**MM15RD-234 -----\$200**

**MM18RD-350 -----\$200**



# UNDERBELLY CHROME

## GAS TANK COVERS



\*\*New Equipment

1977-1992 Cadillac/Caprice

GT7792-CVR-----\$550

## DIFFERENTIAL COVERS



\*Original & New (w/Gasket) Equipment

1978-1996 Cadillac

DCGC7-5NP (w/7.50" or 7.625") - \$100

GSKT10-7 (w/7.50" or 7.625") ----- \$15



\*\*New Equipment w/Gasket

1964-1996 Cadillac

DCGC8-5NP (8.50"/8.625", No Plug) - \$100

DCIGC-85P (8.50"/8.625"W/Plug) - \$100

GSKT10-8 (w/7.50" or 7.625") ----- \$15

## DRIVE SHAFT SAFETY SUPPORT



\*Original Equipment

Includes 4 Bolts & Washers

1977-1996 Cadillac/Impala/Caprice

DS7796-SAF (With Out Bolts) ----\$150

Bolts Also Sold Separately See Pg 23

## DRIVE SHAFT



\*Original Equipment

1977-1996 Cadillac/Caprice

DS7796-CAD-----\$350

## U-JOINT STRAPS



\*\*New Equipment

77-96 Cadillac

US5596-ICG-----\$60

## GAS TANK STRAPS



\*\*New Equipment

1977-1992 Cadillac/Impala/Caprice

ST7792-ICC-----\$175



\*Original and New Equipment/{CES}

1993-1996 Cadillac/Impala/Caprice

ST9396-ICC-----\$250



# BRAKE DRUMS & COMPONENTS

## REAR DRUMS



\*\*New Equipment

**1977-1984 Cadillac Fleetwood  
DeVille (RWD)**

**RD8870-ICF-(11"x3.25" w/ Fins)- \$350**

**RD8870-ICS(11"x3.25" Smooth)--\$400**

**RD8504-CFN-(12" w/ Fins) ----- \$350**

**RD8504-CSM-(12" Smooth) ----- \$400**

## REAR DRUMS



\*\*New Equipment

**1991-1996 Cadillac Fleetwood**

**RD8873-ICF-(11"x4" w/ Fins)---- \$350**

**RD8873-ICS-(11x4" Smooth)----- \$400**

## FRONT DUST SHIELDS



\*Original Equipment

**1993-1996 Cadillac Fleetwood**

**FP7796-CAD ----- \$250**

## REAR BACKING PLATES



\*\*New & \*Original Equipment/(CES)

**1977-1996 Cadillac**

**BP7796-COE (Original Equip) ----\$225**

**BP7796-CNE (Original Equip) ----\$300**

## BRAKE CALIPERS

**Cadillac/Caprice**



\*\*New Equipment

Stock NOT SHAVED will not fit 13" rims

**1977-1996 CADILLAC**

**BC7796-CE2-----\$350**

**BC7796-CE3-----\$350**



## HARDWARE

### CASTLE NUTS



\*Original Equipment

Includes 2 Castle Nuts

**CSTL02-716 (7/16-20 Fine) ----- \$20 pr**

**CSTL02-012 (1/2-20 Fine) ----- \$20 pr**

**CSTL02-916 (9/16-18 Fine) ----- \$25 pr**

**CSTL02-M10 (M10x1.25) ----- \$25 pr**

**CSTL02-M12 (M12x1.25) ----- \$25 pr**

### WHEEL WELL BOLTS & WASHERS



\*\*New Equipment

Includes Polished Stainless Steel Bolts with 2" Washers

**1977-1996 Cadillac/Caprice/Impala**

**WWBLT2-CGP (Polished Qty 2)-\$40 pr**

**WWBLT4-CGP (Polished Qty 4)-\$75 set**

### DOOR STRIKERS



\*Original Equipment

Includes 2 Bolts and 2 Washers

**1971-1992 Cadillac/Impala/Caprice**

**DSBOLT-ICG-----\$50 pr**



\*Original Equipment/{CE\$}

Includes 4 Strikers, 4 Washers, 8 Bolts

**1993-1996 Cadillac/Impala/Caprice**

**DRSTKR-CAD-----\$250 set**

### BALL JOINT BOLTS



\*\*New Equipment- Polished Stainless Steel

Includes Bolts, Washer, Lock Nuts

**1977-1996 Cadillac/Impala/Caprice**

**BJGPU8-BLT (Polished SS)-----\$50 Set**

### PITMAN ARM WASHER & NUT



\*Original Equipment

**71-96 Cadillac/Caprice/Impala**

**PAWNUT-ICG-----\$40**

### SAFETY SUPPORT BRACKET BOLTS



\*\*New Equipment - Polished Stainless Steel

**1977-1996 Cadillac**

**SSBK4-BLT (Polished)-\$40 Set**

### GEAR BOX MOUNTING BOLTS



\*\*New (Polished SS) & \*Original Equipment

**71-96 Cadillac/Caprice/Impala**

**\*GB7796-BLT (Chrome) -----\$90**

### IDLER ARM BOLTS



\*\*New Equipment – Polished Stainless Steel

**77-96 Cadillac/Impala/Caprice**

**IA7796-BLT (Polished) ----- \$40**



\*\*New Equipment

**1977-1996 Cadillac**

**TAGP04-BLT (Polished SS x4) -----\$110**

### CONTROL ARM

### SHAFT "Dogbone"

### NUT & WASHER SET



\*\*New Equipment Includes Front Upper Washers & Nuts

**1977-1996 Cadillac/Impala/Caprice**

**DBNWGC-SET (Polished SS) ----- \$65**

### TRAILING ARM BOLT SET



\*\*New Equipment

**1977-1996 Cadillac**

**TASTCC-BLT (Chrome) ----- \$150**

### SWAYBAR BRACKET BOLTS



**\*\*New Equipment**  
**1977-1996 Cadillac**

**HW7196-BKT (Polished SS) ----- \$30**

**BLOWER MOTOR SCREW SET**

**<<<INSERT PHOTO>>>**

**<<<INSERT PHOTO>>>**

**\*\*New Equipment**  
Set Includes 5 Screws

**1962-1996 Cadillac**  
**BM6296-BLT (Non-Chrome) ----- \$20**

**HARDWARE Cont.**

**ALIGNMENT SHIMS**



**CHROME Upper A-Arm Shims**  
**\*\*New Equipment**  
Set Includes 8 Shims  
**1977-1996 Cadillac/Impala/Caprice**  
**AASHMG-SET (Chrome) ----- \$50**

**BODY MOUNT BOLT SETS**



**77-96 Cadillac**  
**Bolt, Washers & Sleeves**  
**\*\*New Equipment**  
**Nickel Plated – Not Chrome Bolts**  
**BMBS-SET (Cadillac)----- \$125**

**DUST SHIELD BOLTS**



**\*\*New Equipment**  
**1977-1996 Cadillac/Impala/Caprice**  
**DSBOLT-SET (Polished SS) ----- \$30**



## BUSHING AND BOOT SETS

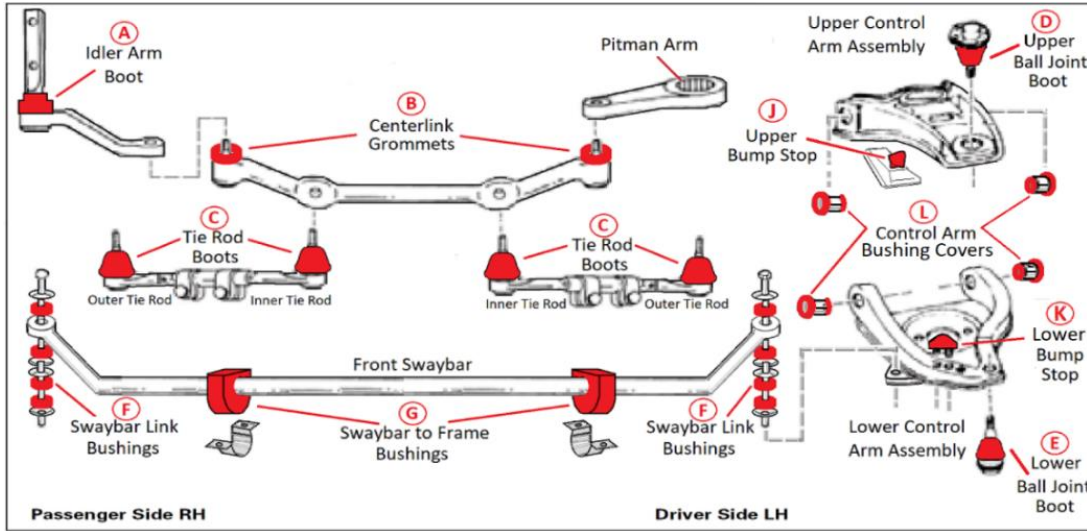

**AVAILABLE COLORS**  
 -XXX= COLOR  
 -BLK (Black)

-BRN (Brown)	-GLD (Gold)
-BLU (Blue)	-NGY (Nardo Gray)
-LBL (Light Blue)	-ORG (Orange)
-DBL (Dark Blue)	-PNK (Pink)
-RED (Red)	-PPL (Purple)
-DRD (Dark Red)	-TEA (Teal)
-GRN (Green)	-WHT (White)
-DGN (Dark Green)	-YLW (Yellow)



**D - Upper Ball Joint Boots**  
**E - Lower Ball Joint Boots**



**BJBTU2-XXX** (x2 Upper Any Color Boots) - \$25  
**BJBTL2-XXX** (x2 Lower Any Color Boots) - \$25

**A - Idler Arm Boot**



**IABT01-XXX** (x1 Any Color Boot) ----- \$15

**B - Centerlink Grommets**



**CLGMT2-XXX** (x2 Any Color Grommets) \$15

**C - Tie Rod Boots**



**TRBT04-BLK** (x4 Black Boots) ----- \$20  
**TRBT04-XXX** (x4 Color Boots) ----- \$50

**F - Swaybar Link Bushings**



**LKBUSH-BLK** (x8 Black Bushings) ----- \$20  
**LKBUSH-XXX** (x8 Bushings) ----- \$40

**G - Swaybar to Frame Bushings**





15

SBBU17-XXX (55-64 BelAir/Impala x2) - \$30  
 SBBU30-XXX (Gbody/Cadi x2) ----- \$30

**L - Bushing Covers**



Set will do 4 bushings  
**77-96 Cadillac**

BCCFU-XXX (Front Upper) ----- \$60

BCCFL-XXX (Front Lower) ----- \$60  
 BCCRU-XXX (Rear Upper & Lower) ---- \$110

**FRONT END BOOT AND BUSHING SETS**

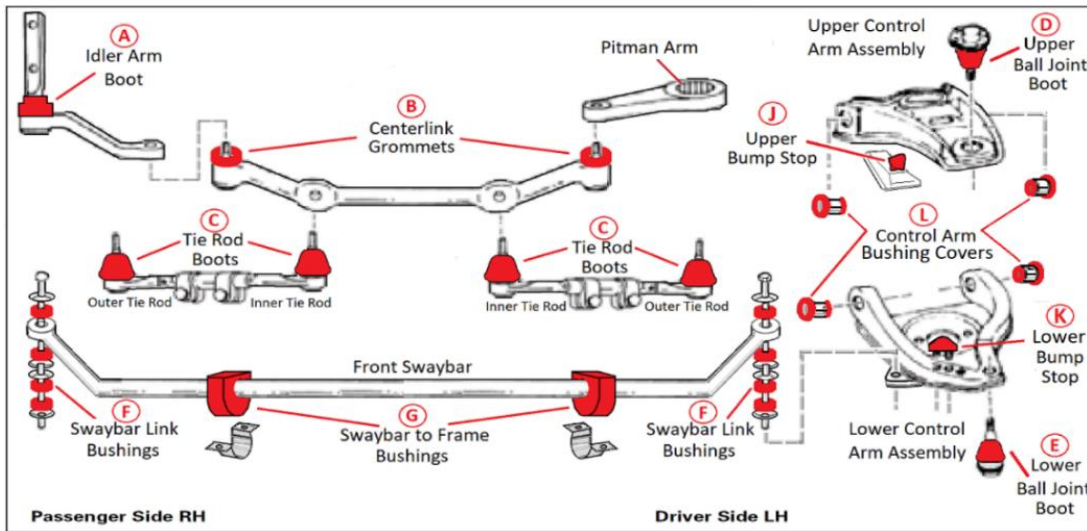

**AVAILABLE COLORS**

-XXX= COLOR

-BLK (Black)	
-BRN (Brown)	-GLD (Gold)
-BLU (Blue)	-NGY (Nardo Gray)
-LBL (Light Blue)	-ORG (Orange)
-DBL (Dark Blue)	-PNK (Pink)
-RED (Red)	-PPL (Purple)
-DRD (Dark Red)	-TEA (Teal)
-GRN (Green)	-WHT (White)
-DGN (Dark Green)	-YLW (Yellow)



**FRONT END BOOT & BUSHING KITS**

**71-96 Cadillac/Impala/Caprice**

Boots: Tie Rods, Idler Arm, Ball Joints  
 Bushings: Centerlink Grommets, Links,  
 30mm Swaybar to Frame

BTSTGC-XXX ----- \$200





### Rear Suspension Bump Stops Impala/Caprice/Gbody/Cadillac

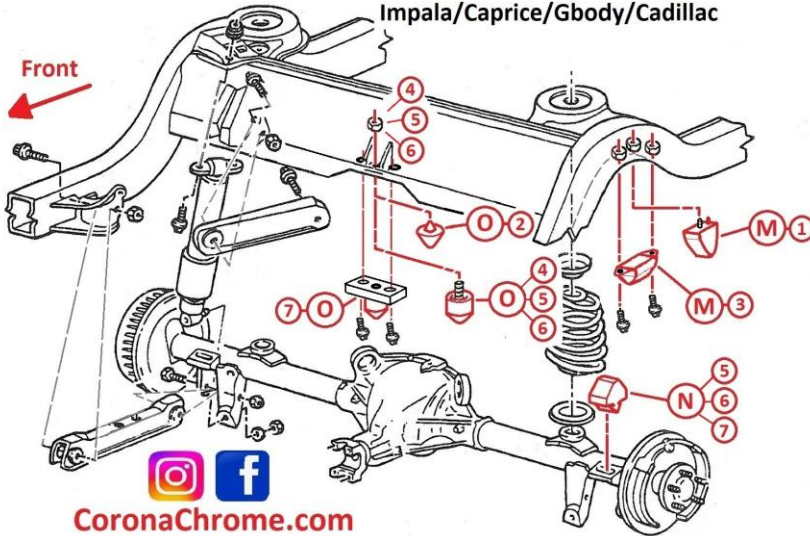

CoronaChrome.com



- Designed to Manufacturer Specification  
- For custom applications (hydraulics, air bags, etc...) trim as needed.

- (M)** Rear Frame Bump Stop
- (N)** Rear Axle Bump Stop
- (O)** Rear Axle Center Pinion Bumper
  - ① Fits 58-64 Impala
  - ② Fits 65-66 Impala/Caprice
  - ③ Fits 65-70 Impala/Caprice
  - ④ Fits 68-70 Impala/Caprice
  - ⑤ Fits 71-76 Impala/Caprice
  - ⑥ Fits Cadillac
  - ⑦ Fits GBody

#### AVAILABLE COLORS

-XXX= COLOR

-BLK (Black)

-BRN (Brown)	-GLD (Gold)
-BLU (Blue)	-NGY (Nardo Gray)
-LBL (Light Blue)	-ORG (Orange)
-DBL (Dark Blue)	-PNK (Pink)
-RED (Red)	-PPL (Purple)
-DRD (Dark Red)	-TEA (Teal)
-GRN (Green)	-WHT (White)
-DGN (Dark Green)	-YLW (Yellow)

#### REAR AXLE BUMP STOPS

Rear Axle Bump Stops



GBody, Cadillac

78-87 GBody

71-96 Cadillac/Impala/Caprice

RABSGC-XXX (N5, N6, N7) ----- \$70

#### Y-BONE BUSHINGS

Includes 6 Halves (3 Bushings)

Bolts sold separately

Diameter = 1.50"

YBB150-XXX----- \$80

Diameter = 1.75"

YBB175-XXX----- \$80



Y-Bone Bushings

Part# YBBUSH-xxx



SMALL

LARGE

1.50

1.75

1.25

1.25

1.50

1.61



Light Blue

Teal

Green

Dark Green

Y-Bone Bushings

Part# YBBUSH-XXX



Light Blue

Blue

Dark Blue

Purple

Y-Bone Bushings

Part# YBBUSH-xxx

Includes 2 Bushings and 1 Boot

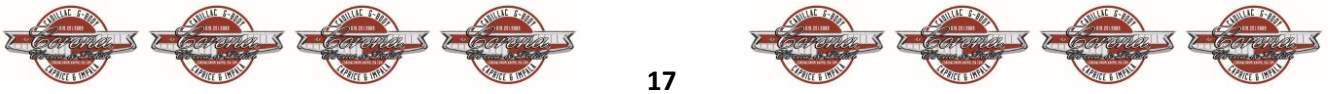

### A-ARM BUSHING COVERS

Set Includes covers for 4 Bushings  
 \*A-Arms and Bushings sold separately



BCVGCU-XXX (GBody/Cadillac)----- \$60  
 BCVGCL-XXX (GBody/Cadillac)----- \$60

## BODY MOUNT BUSHING SETS

ALL BODY MOUNT BUSHINGS CAN BE SOLD SEPARATELY

**REMOVAL**  
 Spray all nuts to be removed with rust removal lubricant.  
 Bushings are designed to work with original body mount sleeves or aftermarket sleeves and washers.  
**Note:** When disassembling, note the quantity and positions of any shims that may have been inserted for body alignment. These shims will have to be reused to insure proper body alignment.

**Installation:** Only raise body high enough to remove and replace mounts. Install mounts one side at a time with bolts on opposite side loosened only.

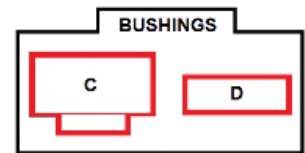
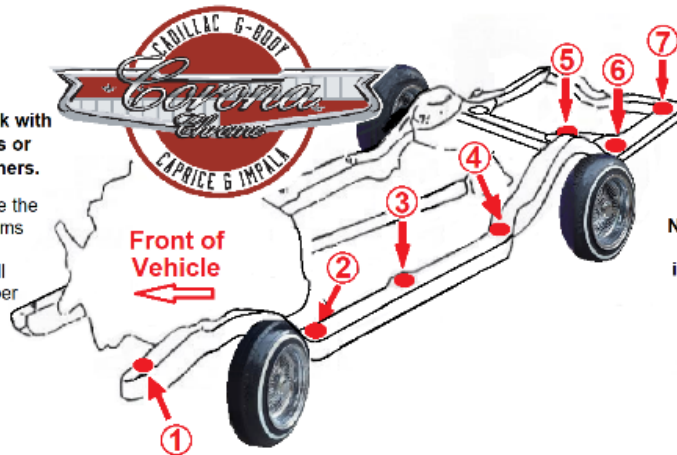

**POSITION # 5**

**Note:** Some vehicles did not come with this bushing. It's located in a hole in front of the upper rear spring perch. No sleeves, bolts or washers are used in this location.

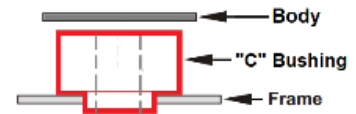

**POSITION # 1**

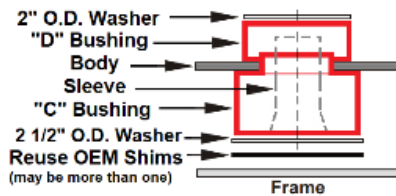

**POSITION #2, 4, 6 & 7**

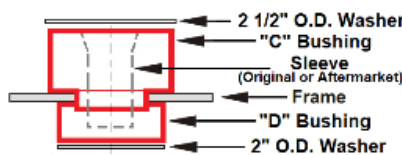

**POSITION # 3**

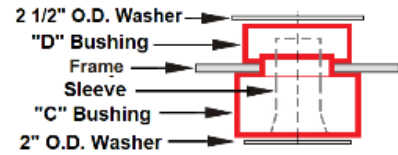

**AVAILABLE COLORS**

-XXX= COLOR

-BLK (Black)	-BRN (Brown)	-BLU (Blue)	-LBL (Light Blue)	-DBL (Dark Blue/Purplish)	-ORG (Orange)
-RED (Red)	-DRD (Dark Red)	-GRN (Green)	-DGN (Dark Green)	-GLD (Gold)	-NGY (Nardo Gray)
-PNK (Pink)	-PPL (Purple)	-TEA (Teal)	-WHT (White)	-YLW (Yellow)	

**77-96 Cadillac/Caprice**

- BMBSHC-XXX (Cadillac/Caprice) --- \$300
- BMGxx-SLV (Sleeves & Washers) --- \$50
- BMGxx-WSH (Sleeves & Washers) ---\$40
- BMBSHG-BLT (Bolts) ----- \$40



## A-Arm Dust Shields and Seals

AVAILABLE COLORS = -XXX

-BLK (Black)	-BRN (Brown)	-BLU (Blue)	-LBL (Light Blue)	-DBL (Dark Blue/Purplish)	-ORG (Orange)
-RED (Red)	-DRD (Dark Red)	-GRN (Green)	-DGN (Dark Green)	-GLD (Gold)	-NGY (Nardo Gray)
-PNK (Pink)	-PPL (Purple)	-TEA (Teal)	-WHT (White)	-YLW (Yellow)	

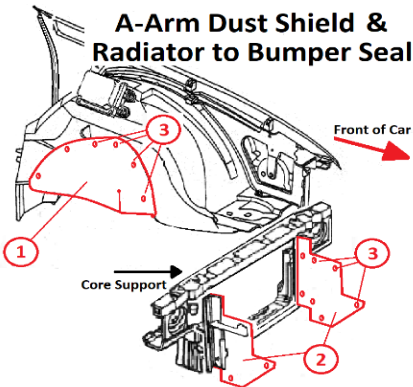

**77-92 Cadillac**  
 DS7792-XXX (A-Arm Dust Shield) -- \$120  
 RS8296-XXX (A-Arm Dust Shield) -- \$120

**93-96 Cadillac Fleetwood**  
 DS9396-XXX (A-Arm Dust Shield) -- \$100  
 RS9396-XXX (Radiator Seal) ----- \$100

**Plastic Push Retainers**  
 DSPRTR-XXX (Clear) ----- \$10

DSPRTR-CRM (Painted Chrome) ----- \$20



### Push In Retainers







20



2024 v1