



Nothing but **HEAVY DUTY.**



25453 State Road 2 • South Bend, IN 46619

(574) 233-4300

Fax: (574) 233-4301

sales@SummitContractorSupply.com

ULTIMATE PRODUCTIVITY. SUPERIOR PERFORMANCE.

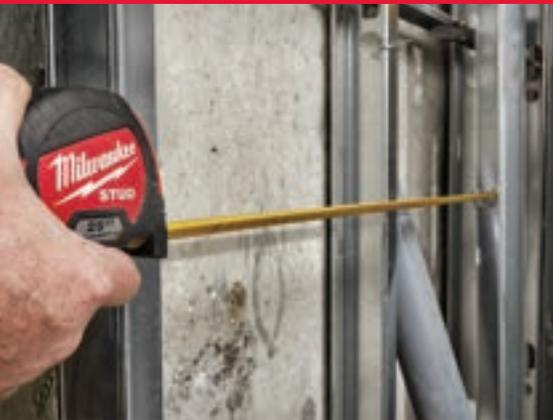

HAND TOOLS | STORAGE | PPE

FALL 2021

STUD™

STUD™ TAPE MEASURES

INDUSTRY'S MOST DURABLE TAPE MEASURE

17' REACH*



Rip & Wear Resistant Blade

Model #	Description
48-22-9716	16ft STUD™ Tape Measure w/ 16' Reach*
48-22-9725	25ft STUD™ Tape Measure w/ 17' Reach*
48-22-9735	35ft STUD™ Tape Measure w/ 17' Reach*

Model #	Description
48-22-9717	5m/16ft STUD™ Tape Measure w/ 16' Reach*
48-22-9726	8m/26ft STUD™ Tape Measure w/ 17' Reach*
48-22-9725M	25ft STUD™ Magnetic Tape Measure w/ 17' Reach*

WIDE BLADE TAPE MEASURES

LONGEST REACH STRAIGHTEST STANDOUT†

17' REACH*

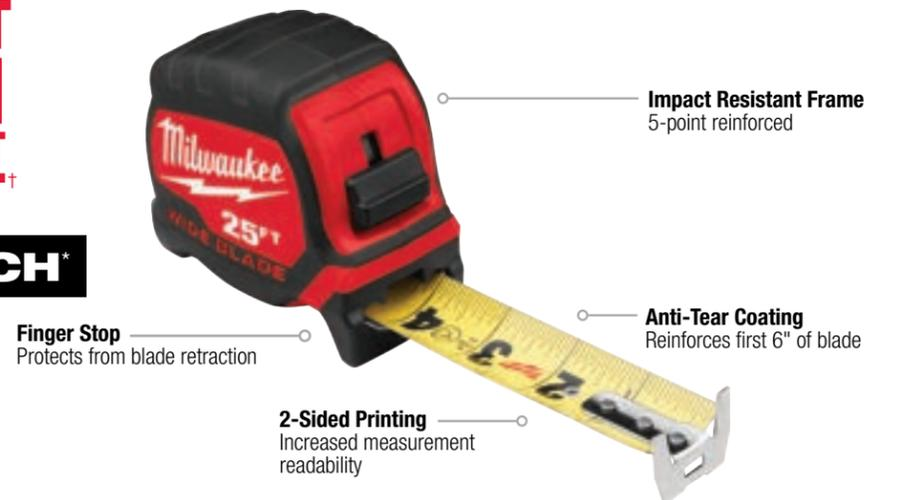

Long Reach for Efficient Measuring

Model #	Description
48-22-0216	16ft Wide Blade Tape Measure w/ 16' Reach*
48-22-0225	25ft Wide Blade Tape Measure w/ 17' Reach*
48-22-0230	30ft Wide Blade Tape Measure w/ 17' Reach*
48-22-0235	35ft Wide Blade Tape Measure w/ 17' Reach*
48-22-0240	40ft Wide Blade Tape Measure w/ 17' Reach*

Model #	Description
48-22-0217	5m/16ft Wide Blade Tape Measure w/ 16' Reach*
48-22-0226	8m/26ft Wide Blade Tape Measure w/ 17' Reach*
48-22-0216M	16ft Wide Blade Magnetic Tape Measure w/ 16' Reach*
48-22-0225M	25ft Wide Blade Magnetic Tape Measure w/ 17' Reach*

COMPACT WIDE BLADE TAPE MEASURES

15' REACH*

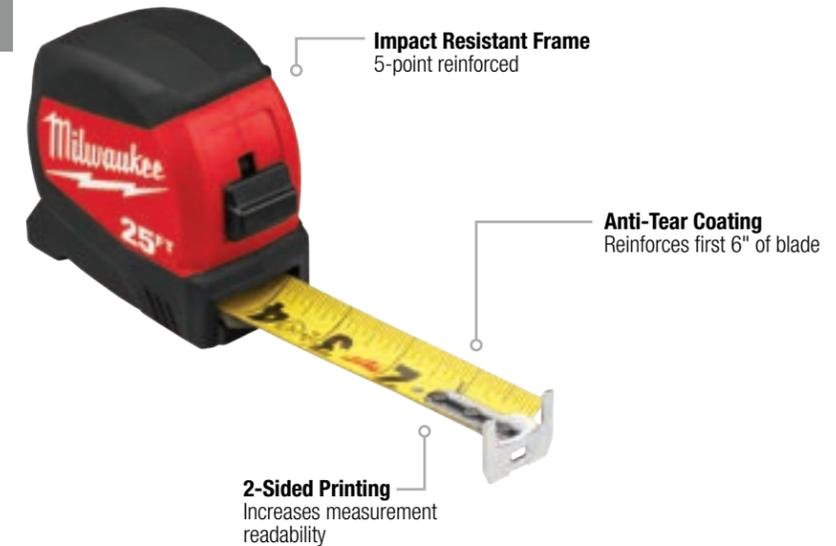

2-Sided Printing

Model #	Description
48-22-0416	16ft Compact Wide Blade Tape Measure w/ 15' Reach*
48-22-0425	25ft Compact Wide Blade Tape Measure w/ 15' Reach*
48-22-0430	30ft Compact Wide Blade Tape Measure w/ 15' Reach*
48-22-0417	5m/16ft Compact Wide Blade Tape Measure w/ 15' Reach*
48-22-0426	8m/26ft Compact Wide Blade Tape Measure w/ 15' Reach*
48-22-0316	16ft Compact Wide Blade Magnetic Tape Measure w/ 15' Reach*

Model #	Description
48-22-0325	25ft Compact Wide Blade Magnetic Tape Measure w/ 15' Reach*
48-22-0335	35ft Compact Wide Blade Magnetic Tape Measure w/ 15' Reach*
48-22-0317	5m/16ft Compact Wide Blade Magnetic Tape Measure w/ 15' Reach*
48-22-0326	8m/26ft Compact Wide Blade Magnetic Tape Measure w/ 15' Reach*

COMPACT TAPE MEASURES

12' REACH*

Impact Resistant Frame
5-point reinforced

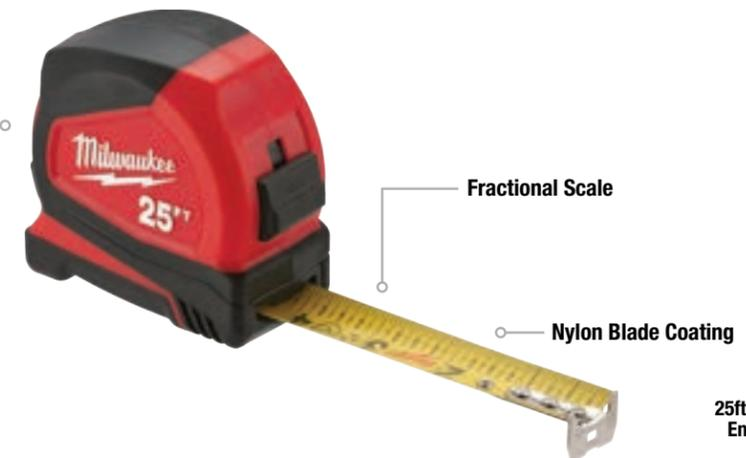

Nylon Blade Coating

Model #	Description
48-22-6612	12ft Compact Tape Measure w/ 12' Reach*
48-22-6616	16ft Compact Tape Measure w/ 12' Reach*
48-22-6625	25ft Compact Tape Measure w/ 12' Reach*
48-22-6630	30ft Compact Tape Measure w/ 12' Reach*
48-22-6613	3m/12ft Compact Tape Measure w/ 12' Reach*
48-22-6617	5m/16ft Compact Tape Measure w/ 12' Reach*
48-22-6626	8m/26ft Compact Tape Measure w/ 12' Reach*

Model #	Description
48-22-6816	16ft Compact Auto-Lock Tape Measure w/ 12' Reach*
48-22-6825	25ft Compact Auto-Lock Tape Measure w/ 12' Reach*
48-22-6817	5m/16ft Compact Auto-Lock Tape Measure w/ 12' Reach*
48-22-6826	8m/26ft Compact Auto-Lock Tape Measure w/ 12' Reach*
48-22-5506	2m/6ft Keychain Tape Measure
48-22-6601	10ft/3m Keychain Tape Measure w/ LED

OPEN REEL STEEL LONG TAPES

50% LESS STRETCH



Model #	Description
48-22-5201	100ft Open Reel Steel Long Tape
48-22-5203	30m/100ft Open Reel Steel Long Tape
48-22-5230	300ft Open Reel Steel Long Tape

FIBERGLASS LONG TAPES

SMOOTHEST RETRACTION



Model #	Description
48-22-5301	100ft Fiberglass Open Reel Long Tape
48-22-5302	200ft Fiberglass Open Reel Long Tape
48-22-5303	300ft Fiberglass Open Reel Long Tape
48-22-5310	100m/330ft Fiberglass Open Reel Long Tape
48-22-5330	30m/100ft Fiberglass Open Reel Long Tape
48-22-5360	60m/200ft Fiberglass Open Reel Long Tape

CLOSED REEL LONG TAPE

LONGEST LIFE

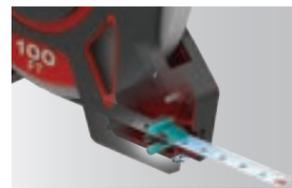

GRIME GUARD™
Industry's First Blade Wiper



Model #	Description
48-22-5101	100ft Closed Reel Long Tape

MEASURING WHEELS

**MOST EFFICIENT.
ONE-HANDED CONTROL.**



IP54 Rated Backlit LCD Screen

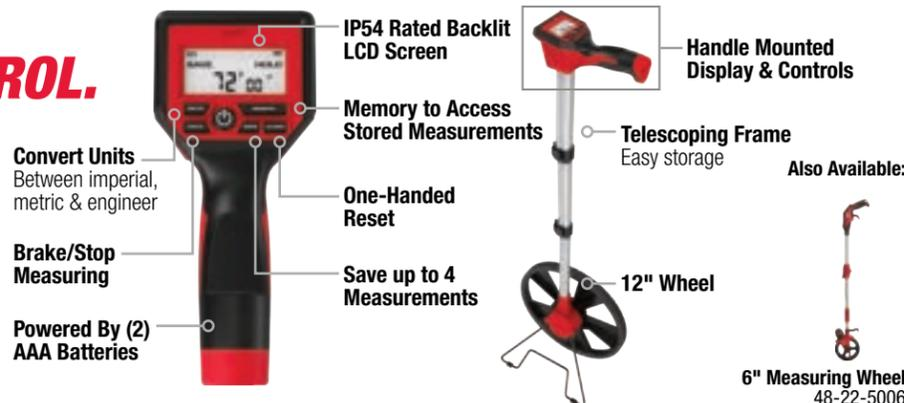

Model #	Description
48-22-5112	12" Digital Measuring Wheel
48-22-5012	12" Measuring Wheel

Model #	Description
48-22-5013	12" Engineer's Measuring Wheel
48-22-5006	6" Measuring Wheel

REDSTICK™

REDSTICK™ DIGITAL LEVELS

**SUPERIOR ACCURACY.
DYNAMIC READOUT.**



PINPOINT™ Measurement Technology

Model #	Description
MLDIG14	14" REDSTICK™ Digital Level w/ PINPOINT™ Measurement Technology
MLDIG24	24" REDSTICK™ Digital Level w/ PINPOINT™ Measurement Technology
MLDIG48	48" REDSTICK™ Digital Level w/ PINPOINT™ Measurement Technology
MLDIG72	72" REDSTICK™ Digital Level w/ PINPOINT™ Measurement Technology

REDSTICK™ BOX LEVELS

**MOST DURABLE.
GUARANTEED ACCURACY.**

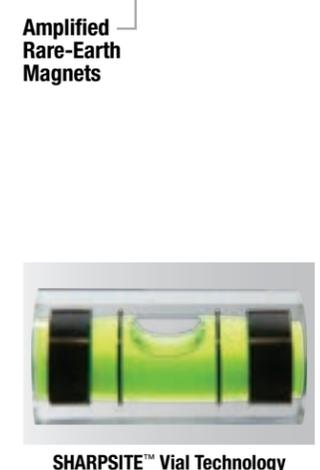
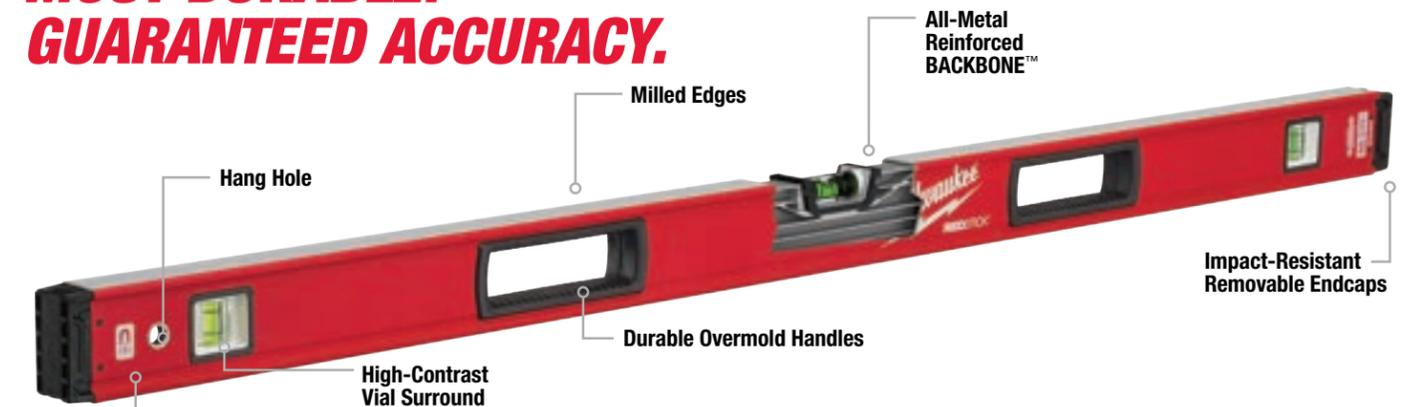

SHARPSITE™ Vial Technology

Model #	Description
MLBX16	16" REDSTICK™ Box Level
MLBXM16	16" REDSTICK™ Magnetic Box Level
MLBX24	24" REDSTICK™ Box Level
MLBXM24	24" REDSTICK™ Magnetic Box Level
MLBX32	32" REDSTICK™ Box Level
MLBXM32	32" REDSTICK™ Magnetic Box Level
MLBX36	36" REDSTICK™ Box Level
MLBXM36	36" REDSTICK™ Magnetic Box Level
MLBX48	48" REDSTICK™ Box Level
MLBXM48	48" REDSTICK™ Magnetic Box Level
MLBX59	59" REDSTICK™ Box Level
MLBXM59	59" REDSTICK™ Magnetic Box Level
MLBX72	72" REDSTICK™ Box Level
MLBXM72	72" REDSTICK™ Magnetic Box Level

Model #	Description
MLBX78	78" REDSTICK™ Box Level
MLBXM78	78" REDSTICK™ Magnetic Box Level
MLBX96	96" REDSTICK™ Box Level
MLBXM96	96" REDSTICK™ Magnetic Box Level
MLBXS1648	16" / 48" REDSTICK™ Box Level Set
MLBXS48	24" / 48" REDSTICK™ Box Level Set
MLBXS48M	24" / 48" REDSTICK™ Magnetic Box Level Set
MLBXJB	78" / 32" REDSTICK™ Box Level Jamb Set
MLBXJBM	78" / 32" REDSTICK™ Magnetic Box Level Jamb Set
MLSB48	48" Level Bag
MLSB78	78" Level Bag
MLBXC48	4 Pc REDSTICK™ Starter Set
MLBXC78	5 Pc REDSTICK™ Master Set

REDSTICK™ COMPACT BOX LEVELS

COMPACT DURABILITY

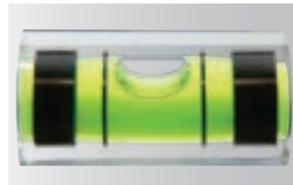
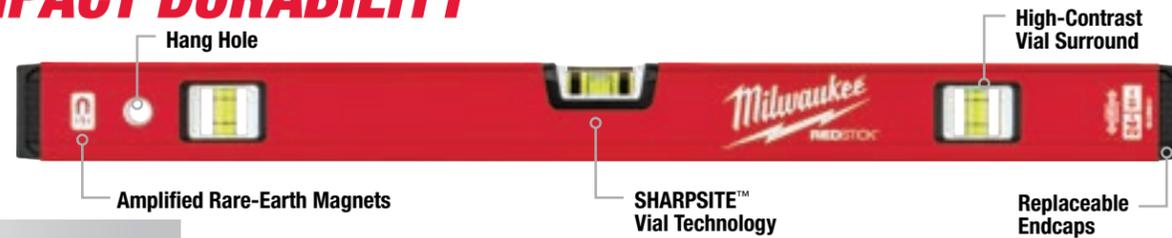

SHARPSITE™ Vial Technology

Model #	Description
MLCM24	24" REDSTICK™ Compact Box Level
MLCMM24	24" REDSTICK™ Magnetic Compact Box Level
MLCM48	48" REDSTICK™ Compact Box Level
MLCMM48	48" REDSTICK™ Magnetic Compact Box Level

Model #	Description
MLCM72	72" REDSTICK™ Compact Box Level
MLCMM72	72" REDSTICK™ Magnetic Compact Box Level
MLCMS48	24" / 48" REDSTICK™ Compact Box Level Set
MLCMSM48	24" / 48" REDSTICK™ Magnetic Compact Box Level Set

REDSTICK™ EXPANDABLE LEVELS

FRAME MORE. NO MAINTENANCE.

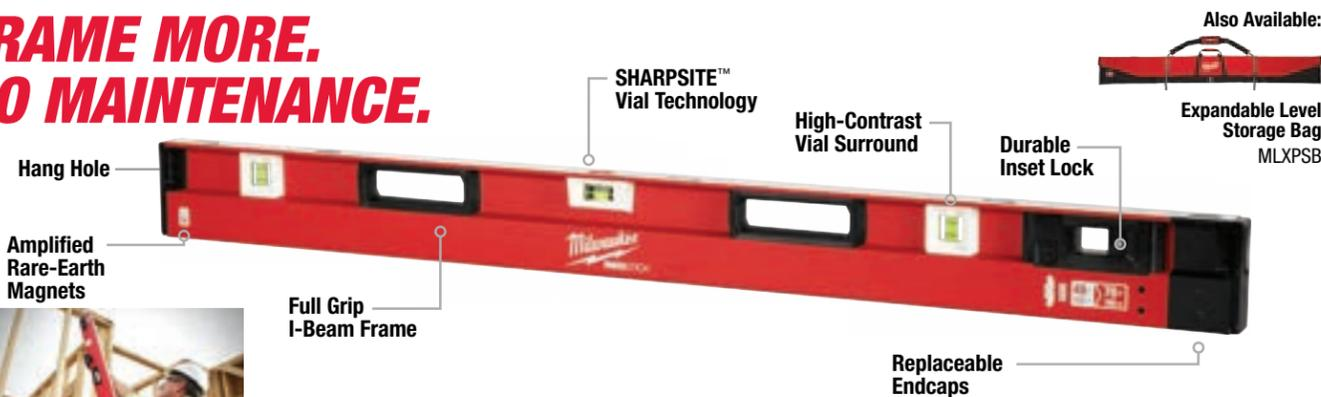

Reinforced Components & Durable Lock

Model #	Description
MLXPM78	48" – 78" REDSTICK™ Magnetic Expandable Level
MLXP712	6-1/2' – 12' REDSTICK™ Expandable Level

REDSTICK™ CONCRETE LEVELS

BUILT FOR CONCRETE



Screed



Smooth



Clean

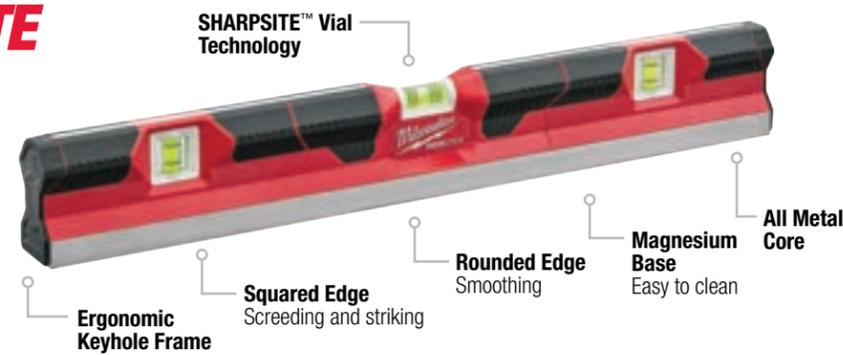

Model #	Description
MLCON24	24" REDSTICK™ Concrete Level
MLCON48	48" REDSTICK™ Concrete Level
MLCON72	72" REDSTICK™ Concrete Level

MAGNETIC I-BEAM LEVELS

STRONGEST FRAME. SETS PITCH.

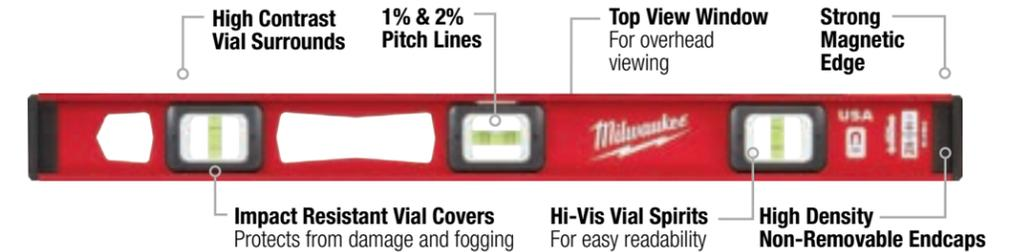

Strong Magnetic Edge

Model #	Description
MLIBM24	24" Magnetic I-Beam Level
MLIBM48	48" Magnetic I-Beam Level
MLIBM78	78" Magnetic I-Beam Level

BILLET TORPEDO LEVELS

STRONGEST MAGNETS. EASIEST PITCH SET.

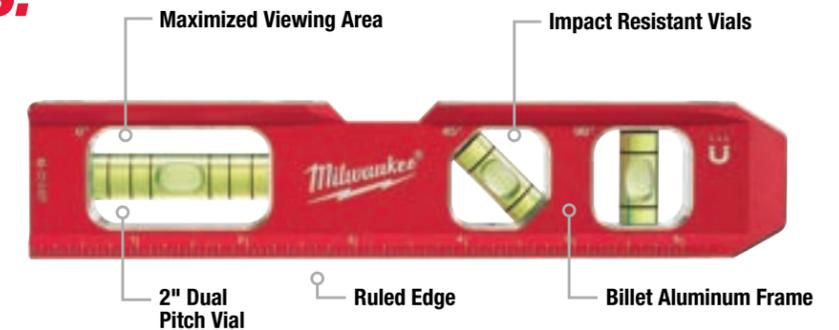

4 Amplified Rare-Earth Magnets

Model #	Description
48-22-5107	Billet Torpedo Level
48-22-5207	Metric Billet Torpedo Level

BLOCK TORPEDO LEVELS

STRONGEST MAGNETS. 360° ACCURACY.

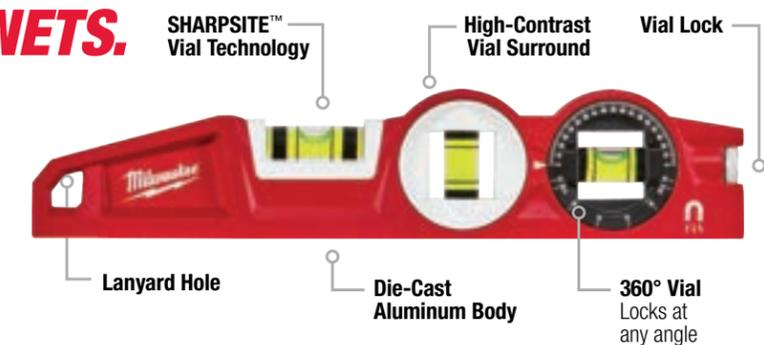

Amplified Rare-Earth Magnets

Model #	Description	Model #	Description
48-22-5210	Block Torpedo Level	48-22-5603	Pocket Level
48-22-5102	360° Pocket Level	48-22-5001	Pipe Lock Level

RAFTER SQUARES

**STRONGER FRAME.
MOST VERSATILE.**

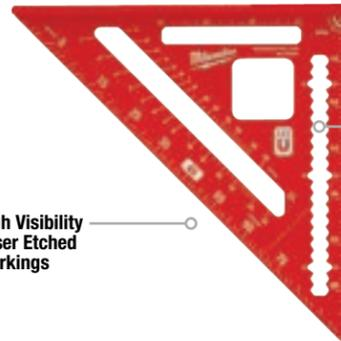

High Visibility Laser Etched Markings

Scribe Notches



1" Cutout Prop Pipe

Model #	Description
MLSQM070	7" Magnetic Rafter Square
MLSQ170	180mm Rafter Square

TRIM SQUARE

**MOST COMPACT.
MOST VERSATILE.**



High Visibility Laser Etched Markings

Precision Scribe Notches at 1/8" Increments



Dual Reference Heel

Model #	Description
MLSQ040	4-1/2" Trim Square

FRAMING SQUARES

**STRONGER THAN STEEL.
MOST VERSATILE.**

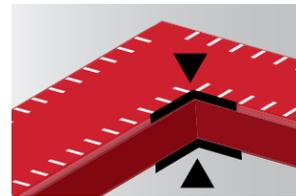

Thicker Frame

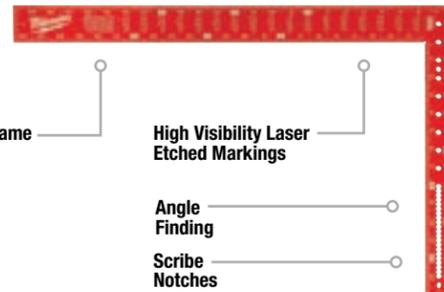

Reinforced Frame

High Visibility Laser Etched Markings

Angle Finding

Scribe Notches

Model #	Description
MLSQ024	16" x 24" Framing Square
MLSQ124	400mm x 600mm Framing Square

LASER DISTANCE METERS

EASIEST MEASUREMENTS



Simplified User Interface

2" Backlit Color Screen

Continuous Real-Time Measurements

2-Position Auto-Detecting Lever



Impact-Resistant Overmolding

Side-Shot Button
Allows for one-handed measurement in all situations

Also Available:



65ft Laser Distance Meter
48-22-9801

Model #	Description
48-22-9801	65ft Laser Distance Meter
48-22-9802	150ft Laser Distance Meter

Model #	Description
48-22-9803	330ft Laser Distance Meter

FOLDING RULES

MOST DURABLE MARKINGS & BLADES

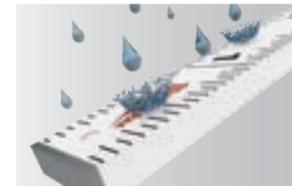

Water & Scratch Resistant Laminate

Quick Reference Bend Angles
22.5°, 30°, 45° & 60°

Heat-Stamped Markings
Won't wear

Corrosion-Free Embedded Joints
Locks at 0°, 90° & 180°



Model #	Description
48-22-3801	6-1/2ft Composite Folding Rule
48-22-3802	6-1/2ft Engineer's Composite Folding Rule

CHALK REELS

**LONGEST GEAR LIFE.
BEST PERFORMANCE.**



StripGuard™ Clutch & Planetary Gears



Bold Line

1.5mm High-Strength Braided Line

6X Faster Retraction



Fine Line

0.9mm High-Strength Braided Line

Aluminum Body
Fine line model only

Model #	Description
48-22-3980	100ft Bold Line Chalk Reel
48-22-3982	100ft Bold Line Chalk Reel & Blue Chalk Refill
48-22-3986	100ft Bold Line Chalk Reel & Red Chalk Refill
48-22-3989	Bold Replacement Line

Model #	Description
48-22-3990	100ft Fine Line Chalk Reel
48-22-3992	100ft Fine Line Chalk Reel & Blue Chalk Refill
48-22-3993	100ft Chalk Reel Kit w/ Blue Chalk Refill
48-22-3999	Fine Replacement Line

EXTRA BOLD LARGE CAPACITY CHALK REELS

**LONGEST GEAR LIFE.
BEST PERFORMANCE.**



Planetary Gears Prevent Stripping

24oz Chalk Capacity

4:1 Retraction Speed

Refillable Base



Easy Grip Metal Handle

Quick Turn Opening

Model #	Description
48-22-3910	100ft Extra Bold Large Capacity Chalk Reel
48-22-3900	100ft Extra Bold Replacement Line

Model #	Description
48-22-3915	150ft Extra Bold Large Capacity Chalk Reel
48-22-3905	150ft Extra Bold Replacement Line



INKZALL™ JOBSITE MARKERS

INKZALL™

INKZALL™ JOBSITE MARKERS

**WRITES ON
DUST
WET
OILY
SURFACES**



Clog Resistant



Model #	Description
48-22-3150	12 Pc INKZALL™ Ultra Fine Point Black Jobsite Markers
48-22-3154	4 Pc INKZALL™ Ultra Fine Point Black Jobsite Markers
48-22-3104	4 Pc INKZALL™ Fine Point Black Jobsite Markers
48-22-3105	2 Pc INKZALL™ Fine Point Black Jobsite Markers
48-22-3107	8 Pc INKZALL™ Fine Point Color Jobsite Markers
48-22-3106	4 Pc INKZALL™ Fine Point Color Jobsite Markers
48-22-3101	INKZALL™ Stylus and Fine Point Black Jobsite Markers
48-22-3102	2 Pc INKZALL™ Medium Point Black Jobsite Markers
48-22-3103	INKZALL™ Chisel Tip Black Jobsite Markers
48-22-3109	4 Pc INKZALL™ Chisel Tip Color Jobsite Markers
48-22-3100	INKZALL™ Fine Point Black Jobsite Markers (Bulk 36 Pc)
48-22-3130	INKZALL™ Chisel Tip Black Jobsite Markers (Bulk 36 Pc)

Model #	Description
48-22-3170	INKZALL™ Fine Point Red Jobsite Markers (Bulk 36 Pc)
48-22-3180	INKZALL™ Fine Point Blue Jobsite Markers (Bulk 36 Pc)
48-22-3190	INKZALL™ Fine Point Green Jobsite Markers (Bulk 36 Pc)
48-22-3209	12 Pc INKZALL™ Fine Point Black Jobsite Markers
48-22-3250	3 Pc INKZALL™ Large Chisel Tip Black Jobsite Markers
48-22-3255	INKZALL™ Large Chisel Tip Black Jobsite Markers (Bulk 12 Pc)
48-22-3256	INKZALL™ Large Chisel Tip Red Jobsite Markers (Bulk 12 Pc)
48-22-3257	INKZALL™ Large Chisel Tip Blue Jobsite Markers (Bulk 12 Pc)
48-22-3260	INKZALL™ Extra Large Chisel Tip Black Jobsite Markers
48-22-3265	INKZALL™ Extra Large Chisel Tip Black Jobsite Markers (Bulk 12 Pc)
48-22-3266	INKZALL™ Extra Large Chisel Tip Red Jobsite Markers (Bulk 12 Pc)
48-22-3267	INKZALL™ Extra Large Chisel Tip Blue Jobsite Markers (Bulk 12 Pc)

Available Colors



Lanyard Hole Hard Hat Clip

Fine Point



Up to 72 Hour Cap-Off Life

Anti-Roll Body

ULTRA FINE POINT

FINE POINT

MEDIUM POINT

CHISEL TIP

LARGE CHISEL TIP

EXTRA LARGE CHISEL TIP

INKZALL™ METALLIC MARKERS



Visible on Dark Surfaces

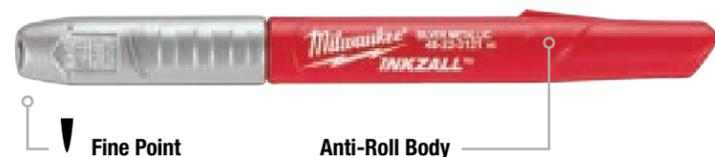

Fine Point

Anti-Roll Body

Available Colors



Model #	Description
48-22-3121	2 Pc INKZALL™ Fine Point Silver Metallic Markers
48-22-3122	2 Pc INKZALL™ Fine Point Gold Metallic Markers
48-22-3123	2 Pc INKZALL™ Fine Point Silver/Gold Metallic Markers

INKZALL™ PAINT MARKERS, PENS & HIGHLIGHTERS

INKZALL™ LIQUID PAINT MARKERS

**BLEED &
SMEAR
RESISTANT**

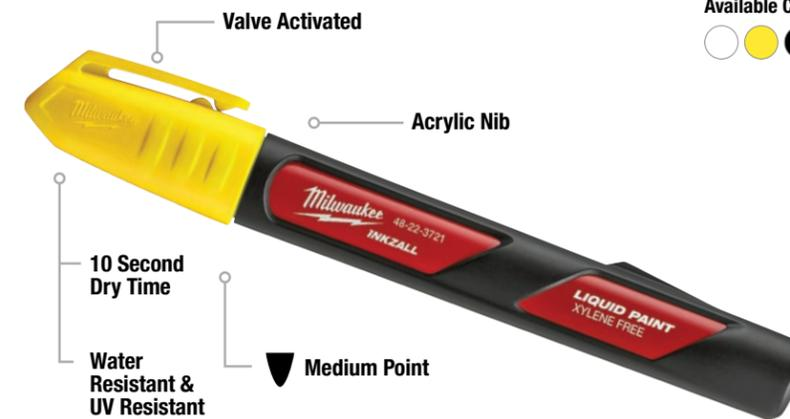

Valve Activated

Acrylic Nib

10 Second Dry Time

Water Resistant & UV Resistant Markings

Medium Point

Available Colors



Marks on Surfaces up to 300°F

Model #	Description
48-22-3712	INKZALL™ Medium Point White Liquid Paint Marker
48-22-3722	INKZALL™ Medium Point Yellow Liquid Paint Marker
48-22-3711	INKZALL™ Medium Point White Liquid Paint Markers (Bulk 12 Pc)
48-22-3721	INKZALL™ Medium Point Yellow Liquid Paint Marker (Bulk 12 Pc)
48-22-3731	INKZALL™ Medium Point Black Liquid Paint Markers (Bulk 12 Pc)

Model #	Description
48-22-3741	INKZALL™ Medium Point Red Liquid Paint Markers (Bulk 12 Pc)
48-22-3751	INKZALL™ Medium Point Green Liquid Paint Markers (Bulk 12 Pc)
48-22-3761	INKZALL™ Medium Point Blue Liquid Paint Markers (Bulk 12 Pc)
48-22-3771	INKZALL™ Medium Point Orange Liquid Paint Markers (Bulk 12 Pc)

INKZALL™ JOBSITE PENS

**SHARP,
PRECISE
LINES**



Clog Resistant Tip

Ultra Fine Point

Available Colors



Model #	Description
48-22-3160	12 Pc INKZALL™ Ultra Fine Point Black Jobsite Pens
48-22-3161	12 Pc INKZALL™ Ultra Fine Point Red Jobsite Pens
48-22-3162	12 Pc INKZALL™ Ultra Fine Point Blue Jobsite Pens
48-22-3164	4 Pc INKZALL™ Ultra Fine Point Black Jobsite Pens
48-22-3165	4 Pc INKZALL™ Ultra Fine Point Color Jobsite Pens

INKZALL™ JOBSITE HIGHLIGHTERS

UP TO **4X LONGER LIFE**



Lanyard Hole Hard Hat Clip

Chisel Tip

Anti-Roll Body

Available Colors



Model #	Description
48-22-3201	5 Pc INKZALL™ Chisel Tip Yellow Jobsite Highlighters
48-22-3206	5 Pc INKZALL™ Chisel Tip Colored Jobsite Highlighters

COMFORT GRIP STRAIGHT JAW PLIERS

**REAM
AND PUNCH™**



Ream Punch



Model #	Description	Jaw Capacity	Reaming Capacity
48-22-6306	6" Comfort Grip Straight Jaw Pliers	1"	3/4"
48-22-6310	10" Comfort Grip Straight Jaw Pliers	2"	2"
48-22-6312	12" Comfort Grip Straight Jaw Pliers	2-1/4"	2-3/4"
48-22-6316	16" Comfort Grip Straight Jaw Pliers	4-1/4"	3"
48-22-6320	20" Comfort Grip Straight Jaw Pliers	5-1/2"	3-1/2"
48-22-6330	2 Pc 6" & 10" Comfort Grip Straight Jaw Pliers Set	1" & 2"	3/4" & 2"
48-22-6331	3 Pc Comfort Grip Pliers Set	2"	2"

STRAIGHT JAW PLIERS

**MAXIMUM GRIP.
FORGED STRENGTH.**



Reaming Head

Model #	Description	Jaw Capacity	Reaming Capacity
48-22-6510	10" Straight Jaw Pliers	2"	2"
48-22-6512	12" Straight Jaw Pliers	2-1/4"	2-3/4"

SMOOTH JAW PLIERS

**SMOOTH JAW
PROTECTS SURFACES**



Non-Marring Smooth Jaw for Finish Applications

Model #	Description	Jaw Capacity	Reaming Capacity
48-22-6550	10" Smooth Jaw Pliers	2"	2"
48-22-6552	12" Smooth Jaw Pliers	2-1/4"	2-3/4"

COMFORT GRIP V-JAW PLIERS



Ream Punch



Model #	Description	Jaw Capacity	Reaming Capacity
48-22-6208	8" Comfort Grip V-Jaw Pliers	1-1/2"	1-1/2"
48-22-6210	10" Comfort Grip V-Jaw Pliers	2"	2"
48-22-6212	12" Comfort Grip V-Jaw Pliers	2-3/4"	2-3/4"

LINEMAN'S PLIERS

**MAXIMUM LEVERAGE.
EASIER CUTS.***

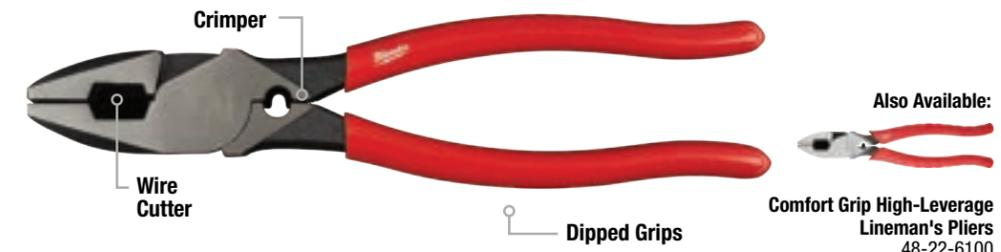

Easily Cuts #2 ACSR

Model #	Description
48-22-6100	Comfort Grip High-Leverage Lineman's Pliers w/ Crimper
48-22-6500	High-Leverage Lineman's Pliers w/ Crimper
48-22-6502	High-Leverage Lineman's Pliers
48-22-6503	High-Leverage Lineman's Pliers w/ Thread Cleaner

ANGLED HEAD PLIERS

BETTER ACCESS



Angled Head

Model #	Description
48-22-6128	8" Comfort Grip Angled Head Diagonal Cutting Pliers
48-22-6528	8" Angled Head Diagonal Cutting Pliers

* When compared to other ACSR cutting lineman pliers

COMFORT GRIP LONG NOSE PLIERS

LONG REACH



2" Gripping Nose

Model #	Description
48-22-6101	8" Comfort Grip Long Nose Pliers
48-22-6501	8" Long Nose Pliers

COMFORT GRIP PLIERS

UP TO 2X MORE CUTS IRON-CARBIDE EDGE

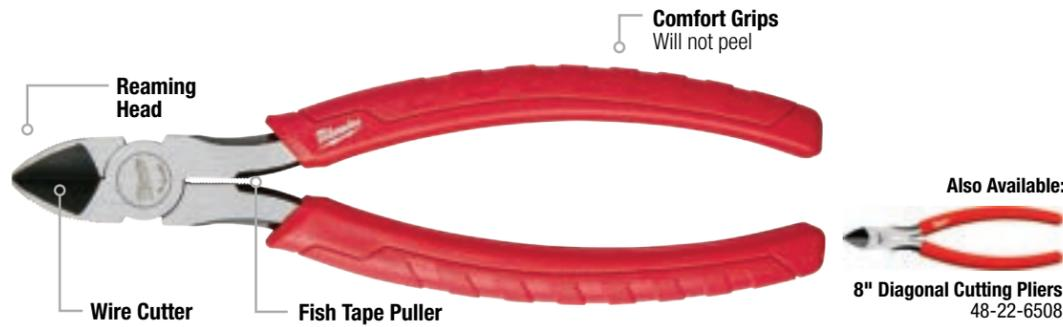

Tapered Nose

Model #	Description
48-22-6106	6" Comfort Grip Diagonal Cutting Pliers
48-22-6107	7" Comfort Grip Diagonal Cutting Pliers
48-22-6108	8" Comfort Grip Diagonal Cutting Pliers
48-22-6508	8" Diagonal Cutting Pliers

MULTI-FUNCTION PLIERS

FAST, ONE-HANDED OPERATION

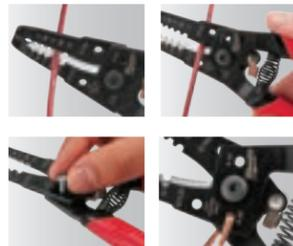

Model #	Description	Wire Stripper
48-22-6109	Wire Stripper	10-18 AWG Solid, 12-20 AWG Stranded
48-22-6579	Multi-Purpose Wire Stripper w/ Crimper	10-20 AWG Solid, 12-22 AWG Stranded

7IN1 HIGH LEVERAGE PLIERS

7IN1 EASIER CUTS

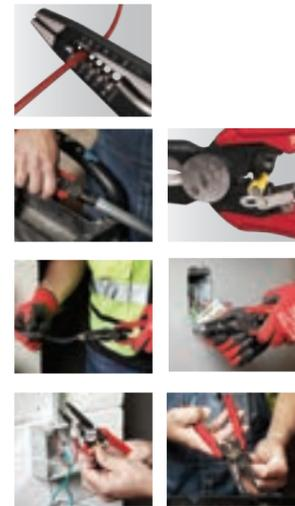
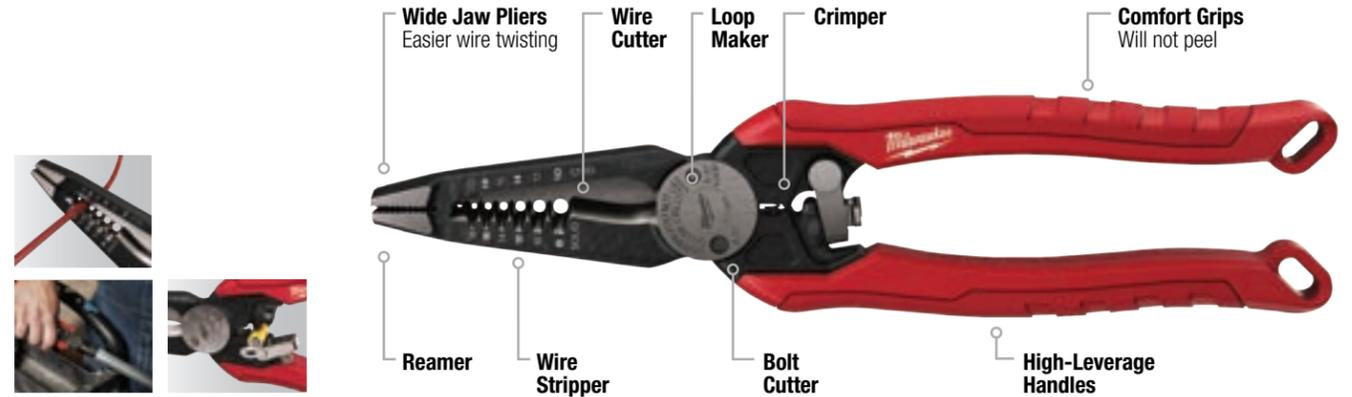

Model #	Description	Wire Stripper
48-22-3078	7in1 High-Leverage Pliers	8-18 AWG Solid, 10-20 AWG Stranded

COMFORT GRIP 6IN1 COMBINATION PLIERS

6IN1

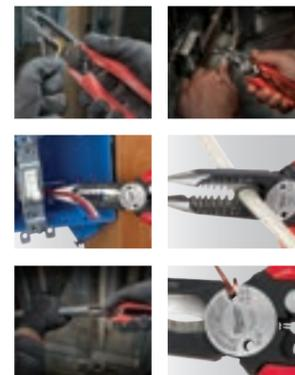

Model #	Description	Wire Stripper
48-22-3079	6in1 Comfort Grip Combination Pliers	8-18 AWG Solid, 10-20 AWG Stranded

IRONWORKER'S PLIERS

UP TO **2X MORE CUTS**

IRON-CARBIDE EDGE



Comfort Grips
Will not peel



For Twisting & Cutting Rebar Ties

Model #	Description
48-22-6102	Ironworker's Pliers

CRIMPING PLIERS

UP TO **2X CRIMPING FORCE**



Reaming Head
Wire Cutter

Comfort Grips
Will not peel



Crimper for Insulated & Non-Insulated Terminals

Model #	Description
48-22-6103	Crimping Pliers

CABLE CUTTING PLIERS

CLEAN CUTS



Comfort Grips
Will not peel



Cuts up to 2/0 Cu, 4/0 Al

Model #	Description
48-22-6104	Cable Cutting Pliers

PVC / OIL FILTER PLIERS

3-1/2" JAW CAPACITY



Comfort Grips
Will not peel



3.5" Jaw Capacity

Model #	Description
48-22-6321	PVC / Oil Filter Pliers

NIPPING PLIERS

CURVED HEAD. PROTECTS SURFACES.



Comfort Grips
Will not peel



Blades Will Not Mar Surfaces

Model #	Description
48-22-6407	7" Nipping Pliers

FENCING PLIERS

FORGED STRENGTH



Staple Gripper
Wire Cutter
Wire Crimper
Hammer

Comfort Grips
Will not peel



Wire Puller

Model #	Description
48-22-6410	Fencing Pliers

TORQUE LOCK™ FASTER SET-UP



LOCKING PLIERS w/ MAX BITE™

MAX BITE™
3X GRIPPING FORCE



CHROME
Chrome plated rust protection



GRIPPED
Rubber overmold

Model #	Description
48-22-3607	7" TORQUE LOCK™ MAX BITE™ Curved Jaw Locking Pliers
48-22-3610	10" TORQUE LOCK™ MAX BITE™ Curved Jaw Locking Pliers
48-22-3702	2 Pc 7" & 10" TORQUE LOCK™ MAX BITE™ Curved Jaw Locking Pliers

Model #	Description
48-22-3710	10" TORQUE LOCK™ MAX BITE™ Curved Jaw Locking Pliers w/ Grip
48-22-3707	7" TORQUE LOCK™ MAX BITE™ Curved Jaw Locking Pliers w/ Grip

LOCKING PLIERS



CURVED JAW
Maximizes pressure points for any bolt, nut or locking tool application



STRAIGHT JAW
Maximizes contact points on jobsite work surfaces



LONG NOSE
Best for long reach applications

Model #	Description
48-22-3405	5" TORQUE LOCK™ Curved Jaw Locking Pliers w/ Grip
48-22-3407	7" TORQUE LOCK™ Curved Jaw Locking Pliers w/ Grip
48-22-3410	10" TORQUE LOCK™ Curved Jaw Locking Pliers w/ Grip
48-22-3406	6" TORQUE LOCK™ Long Nose Locking Pliers w/ Grip
48-22-3409	9" TORQUE LOCK™ Long Nose Locking Pliers w/ Grip
48-22-3807	7" TORQUE LOCK™ Straight Jaw Locking Pliers w/ Grip
48-22-3810	10" TORQUE LOCK™ Straight Jaw Locking Pliers w/ Grip
48-22-3402	2 Pc 7" & 10" TORQUE LOCK™ Curved Jaw Locking Pliers w/ Grip Set
48-22-3602	2 Pc. 10" Curved Jaw & 6" Long Nose TORQUE LOCK™ Locking Pliers Set
48-22-3423	4" TORQUE LOCK™ Curved Jaw Locking Pliers

Model #	Description
48-22-3422	5" TORQUE LOCK™ Curved Jaw Locking Pliers
48-22-3421	7" TORQUE LOCK™ Curved Jaw Locking Pliers
48-22-3420	10" TORQUE LOCK™ Curved Jaw Locking Pliers
48-22-3504	4" TORQUE LOCK™ Long Nose Locking Pliers
48-22-3506	6" TORQUE LOCK™ Long Nose Locking Pliers
48-22-3507	7" TORQUE LOCK™ Straight Jaw Locking Pliers
48-22-3509	9" TORQUE LOCK™ Long Nose Locking Pliers
48-22-3510	10" TORQUE LOCK™ Straight Jaw Locking Pliers
48-22-3541	12" TORQUE LOCK™ Large Jaw Locking Pliers

C-CLAMPS & SPECIALTY

STANDARD JAW C-CLAMP
Greater clamping versatility on a variety of shapes and surfaces



SWIVEL JAW C-CLAMP
Pads provide surface stabilization and protect work surfaces from damage



Model #	Description
48-22-3521	11" TORQUE LOCK™ Swivel Jaw Locking C-Clamp
48-22-3522	6" TORQUE LOCK™ Swivel Jaw Locking C-Clamp
48-22-3531	11" TORQUE LOCK™ Locking C-Clamp
48-22-3532	6" TORQUE LOCK™ Locking C-Clamp
48-22-3520	18" TORQUE LOCK™ Swivel Jaw Locking C-Clamp
48-22-3529	18" TORQUE LOCK™ Deep Reach Locking C-Clamp
48-22-3530	18" TORQUE LOCK™ Locking C-Clamp

Model #	Description
48-22-3540	8" TORQUE LOCK™ Locking Seamer
48-22-3542	9" TORQUE LOCK™ Locking Chain Wrench
48-22-3543	9" TORQUE LOCK™ Locking Welding Clamp
48-22-3523	9" TORQUE LOCK™ Deep Reach Swivel Jaw Locking C-Clamp
48-22-3533	9" TORQUE LOCK™ Deep Reach Locking C-Clamp
48-22-3631	11" TORQUE LOCK™ Locking C-Clamp
48-22-3632	6" TORQUE LOCK™ Locking C-Clamp

CHEATER

CHEATER ALUMINUM ADAPTABLE PIPE WRENCH

**MOST ADAPTABLE.
ALL-IN-ONE.**

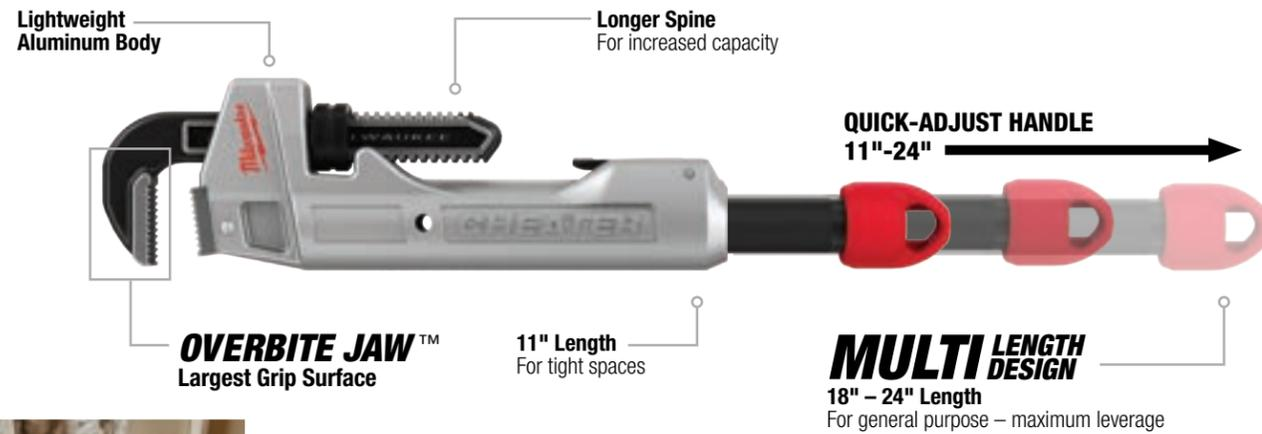

Ergonomic Handle
Maximum Comfort

Model #	Description	Material	Max Jaw Capacity
48-22-7318	CHEATER Aluminum Adaptable Pipe Wrench	Aluminum	2-1/2"

CHEATER STEEL ADAPTABLE PIPE WRENCH

3 LENGTH DESIGN



Hardened Jaws
Increased Durability and Grip

Model #	Description	Material	Max Jaw Capacity
48-22-7314	CHEATER Steel Adaptable Pipe Wrench	Steel	2-1/2"

STEEL & ALUMINUM PIPE WRENCHES

LARGEST GRIP SURFACE



Steel



Aluminum

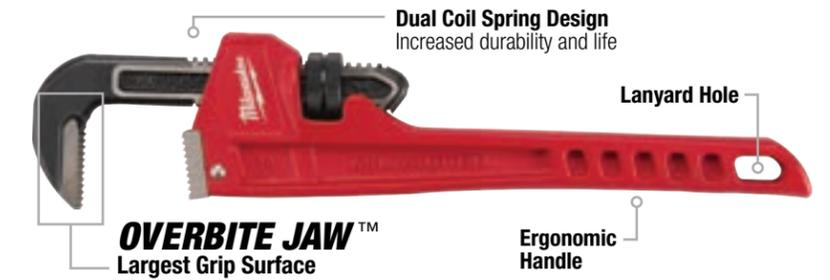

Model #	Description	Length	Material	Max Jaw Capacity
48-22-7106	6" Steel Pipe Wrench	6"	Steel	3/4"
48-22-7108	8" Steel Pipe Wrench	8"	Steel	1"
48-22-7110	10" Steel Pipe Wrench	10"	Steel	1-1/2"
48-22-7112	12" Steel Pipe Wrench	12"	Steel	2"
48-22-7114	14" Steel Pipe Wrench	14"	Steel	2"
48-22-7118	18" Steel Pipe Wrench	18"	Steel	2-1/2"
48-22-7124	24" Steel Pipe Wrench	24"	Steel	3"
48-22-7136	36" Steel Pipe Wrench	36"	Steel	5"
48-22-7148	48" Steel Pipe Wrench	48"	Steel	6"

Model #	Description	Length	Material	Max Jaw Capacity
48-22-7160	60" Steel Pipe Wrench	60"	Steel	8"
48-22-7210	10" Aluminum Pipe Wrench	10"	Aluminum	1-1/2"
48-22-7212	12" Aluminum Pipe Wrench	12"	Aluminum	2"
48-22-7214	14" Aluminum Pipe Wrench	14"	Aluminum	2"
48-22-7218	18" Aluminum Pipe Wrench	18"	Aluminum	2-1/2"
48-22-7224	24" Aluminum Pipe Wrench	24"	Aluminum	3"
48-22-7236	36" Aluminum Pipe Wrench	36"	Aluminum	5"
48-22-7248	48" Aluminum Pipe Wrench	48"	Aluminum	6"

STEEL OFFSET HEX PIPE WRENCH

SMOOTH JAW WON'T MAR SURFACES



Protects Chrome Surfaces



Model #	Description	Material	Max Jaw Capacity
48-22-7171	Steel Offset Hex Pipe Wrench	Steel	2-5/8"

STEEL SMOOTH JAW PIPE WRENCH

SMOOTH JAW PROTECTS SURFACES



Protects Chrome Surfaces



Model #	Description	Material	Max Jaw Capacity
48-22-7186	12" Steel Smooth Jaw Pipe Wrench	Steel	2-5/8"

ALUMINUM OFFSET HEX PIPE WRENCHES

BETTER ACCESS



Offset Head

Model #	Description	Material	Max Jaw Capacity
48-22-7184	14" Aluminum Offset Pipe Wrench	Aluminum	2"
48-22-7185	18" Aluminum Offset Pipe Wrench	Aluminum	2"
48-22-7182	24" Aluminum Offset Pipe Wrench	Aluminum	3"

10L ALUMINUM PIPE WRENCH w/ POWERLENGTH™ HANDLE

BETTER ACCESS. MAXIMUM LEVERAGE.

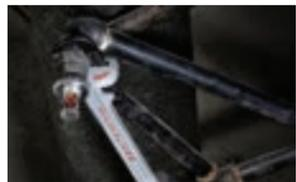

Jaw Capacity 1-1/2"

Model #	Description	Material	Max Jaw Capacity
48-22-7313	10L Aluminum Pipe Wrench w/ POWERLENGTH™ Handle	Aluminum	1-1/2"

ADJUSTABLE WRENCHES

JAWS WON'T BACK OFF Proprietary Screw

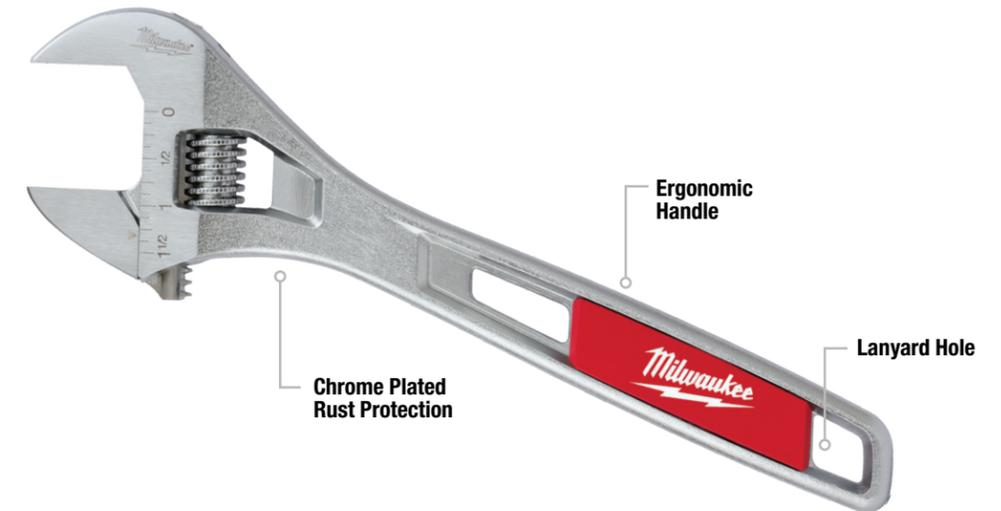
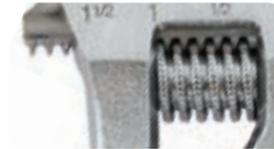

Perfectly Parallel Jaws

Model #	Description
48-22-7400	2 Pc 6" & 10" Adjustable Wrench Set
48-22-7406	6" Adjustable Wrench
48-22-7408	8" Adjustable Wrench
48-22-7410	10" Adjustable Wrench
48-22-7412	12" Adjustable Wrench
48-22-7415	15" Adjustable Wrench
48-22-7508	8" Wide Jaw Adjustable Wrench

BASIN WRENCHES

EASIEST SWAP-OUTS



Ratchet-Ready
Less jaw readjusting



Screwdriver-Ready
Up to 2X breakaway torque

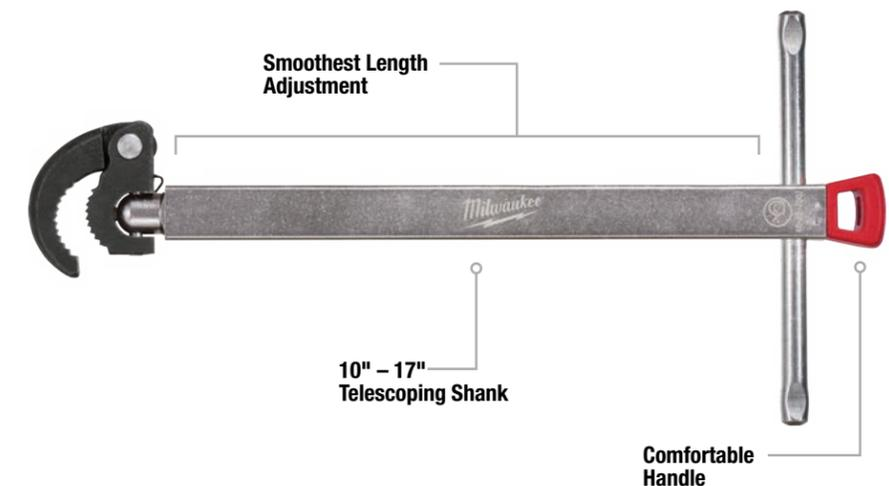

Model #	Description
48-22-7001	1-1/4" Basin Wrench
48-22-7002	2-1/2" Basin Wrench

CONTRACTOR RATCHET & SOCKET SETS

**VERSATILE DESIGN.
BETTER ACCESS.**

SAE METRIC



FOUR FLAT™ SIDES
Anti-Roll, Wrench-Ready.

Slim Design



Pivoting Head

Model #	Description	Size Spec.
48-22-9000	12 Pc 3/8" SAE Contractor Ratchet & Socket Set w/ FOUR FLAT™ Sides	SAE
48-22-9001	12 Pc 3/8" Metric Contractor Ratchet & Socket Set w/ FOUR FLAT™ Sides	METRIC

MECHANICS RATCHET & SOCKET SETS

**MOST VERSATILE SOCKETS.
ANTI-ROLL, WRENCH-READY.**

SAE METRIC

Stamped Sizes
Better visibility

Anti-Roll

Wrench-Ready

90° Tooth Design

Slim Design
Access tight spaces

4° ARC SWING

Ratchet & Socket Sets w/
PACKOUT™ Storage
48-22-9486



Anti-Roll

Wrench-Ready

Model #	Description	Sizes	Size Spec.
48-22-9404	26 Pc 1/4" Drive SAE Ratchet & Socket Set w/ FOUR FLAT™ Sides	1/4"	SAE
48-22-9408	28 Pc 3/8" Drive SAE Ratchet & Socket Set w/ FOUR FLAT™ Sides	3/8"	SAE
48-22-9410	22 Pc 1/2" Drive SAE Ratchet & Socket Set w/ FOUR FLAT™ Sides	1/2"	SAE
48-22-9504	28 Pc 1/4" Drive Metric Ratchet & Socket Set w/ FOUR FLAT™ Sides	1/4"	METRIC
48-22-9508	32 Pc 3/8" Drive Metric Ratchet & Socket Set w/ FOUR FLAT™ Sides	3/8"	METRIC
48-22-9510	28 Pc 1/2" Drive Metric Ratchet & Socket Set w/ FOUR FLAT™ Sides	1/2"	METRIC

Model #	Description	Sizes	Size Spec.
48-22-9004	50 Pc 1/4" Drive Metric & SAE Ratchet & Socket Set w/ FOUR FLAT™ Sides	1/4"	METRIC & SAE
48-22-9008	56 Pc 3/8" Drive Metric & SAE Ratchet & Socket Set w/ FOUR FLAT™ Sides	3/8"	METRIC & SAE
48-22-9010	47 Pc 1/2" Drive Metric & SAE Ratchet & Socket Set w/ FOUR FLAT™ Sides	1/2"	METRIC & SAE
48-22-9481	28 Pc 3/8" SAE Ratchet and Socket Set w/ PACKOUT™ Low-Profile Compact Organizer	3/8"	SAE
48-22-9482	32 Pc 3/8" Drive Metric Ratchet and Socket Set w/ PACKOUT™ Low-Profile Compact Organizer	3/8"	METRIC
48-22-9486	106 Pc 1/4" & 3/8" Drive Metric & SAE Ratchet and Socket Set w/ PACKOUT™ Low-Profile Organizer	1/4" & 3/8"	METRIC & SAE

RATCHETING COMBINATION WRENCHES

**BETTER ACCESS.
LONGEST LIFE.***



MAX BITE™
Anti-Slip Open End

Ink-Filled Sizes
Easy identification



Comfortable
I-Beam Handle

Chrome Plated
Rust Protection

2.5°
ARC SWING†

144 Ratcheting
Positions



Durable Double
Stacked Pawls

Model #	Description	Included Sizes	Size Spec.
48-22-9406	7 Pc SAE Ratcheting Combination Wrench Set	3/8", 7/16", 1/2", 9/16", 5/8", 11/16", 3/4"	SAE
48-22-9506	7 Pc Metric Ratcheting Combination Wrench Set	8mm, 10mm, 12mm, 13mm, 14mm, 15mm, 17mm	METRIC
48-22-9416	15 Pc SAE Ratcheting Combination Wrench Set	1/4", 9/32", 5/16", 11/32", 3/8", 7/16", 1/2", 9/16", 5/8", 11/16", 3/4", 13/16", 7/8", 15/16", 1"	SAE
48-22-9516	15 Pc Metric Ratcheting Combination Wrench Set	8mm, 9mm, 10mm, 11mm, 12mm, 13mm, 14mm, 15mm, 16mm, 17mm, 18mm, 19mm, 20mm, 21mm, 22mm	METRIC

SAE RATCHETING COMBINATION WRENCHES

Model #	Description
45-96-9208	1/4" SAE Ratcheting Combination Wrench
45-96-9209	9/32" SAE Ratcheting Combination Wrench
45-96-9210	5/16" SAE Ratcheting Combination Wrench
45-96-9211	11/32" SAE Ratcheting Combination Wrench
45-96-9212	3/8" SAE Ratcheting Combination Wrench
45-96-9214	7/16" SAE Ratcheting Combination Wrench
45-96-9216	1/2" SAE Ratcheting Combination Wrench
45-96-9218	9/16" SAE Ratcheting Combination Wrench
45-96-9220	5/8" SAE Ratcheting Combination Wrench
45-96-9222	11/16" SAE Ratcheting Combination Wrench
45-96-9224	3/4" SAE Ratcheting Combination Wrench
45-96-9226	13/16" SAE Ratcheting Combination Wrench
45-96-9228	7/8" SAE Ratcheting Combination Wrench
45-96-9230	15/16" SAE Ratcheting Combination Wrench
45-96-9232	1" SAE Ratcheting Combination Wrench

METRIC RATCHETING COMBINATION WRENCHES

Model #	Description
45-96-9308	8mm Metric Ratcheting Combination Wrench
45-96-9309	9mm Metric Ratcheting Combination Wrench
45-96-9310	10mm Metric Ratcheting Combination Wrench
45-96-9311	11mm Metric Ratcheting Combination Wrench
45-96-9312	12mm Metric Ratcheting Combination Wrench
45-96-9313	13mm Metric Ratcheting Combination Wrench
45-96-9314	14mm Metric Ratcheting Combination Wrench
45-96-9315	15mm Metric Ratcheting Combination Wrench
45-96-9316	16mm Metric Ratcheting Combination Wrench
45-96-9317	17mm Metric Ratcheting Combination Wrench
45-96-9318	18mm Metric Ratcheting Combination Wrench
45-96-9319	19mm Metric Ratcheting Combination Wrench
45-96-9320	20mm Metric Ratcheting Combination Wrench
45-96-9321	21mm Metric Ratcheting Combination Wrench
45-96-9322	22mm Metric Ratcheting Combination Wrench

*When compared to single-pawl ratchet designs †Includes sizes 3/8"-1" and 10mm-22mm. Sizes 1/4"-11/32" and 8mm-9mm offer 120 unique ratcheting positions and 3° of arc swing.

COMBINATION WRENCHES

UP TO
25% MORE TORQUE

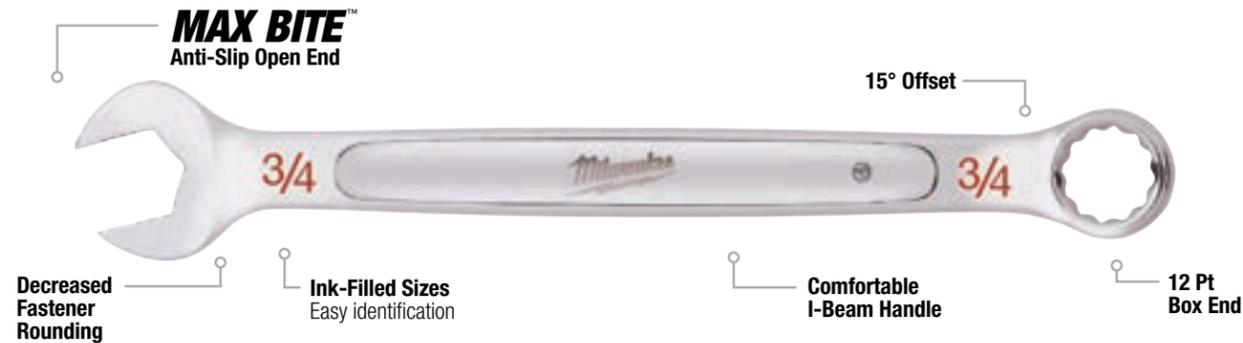

Innovative Storage Solution

Model #	Description	Included Sizes	
48-22-9407	7 Pc SAE Combination Wrench Set	3/8", 7/16", 1/2", 9/16", 5/8", 11/16", 3/4"	SAE
48-22-9507	7 Pc Metric Combination Wrench Set	8mm, 10mm, 12mm, 13mm, 14mm, 15mm, 17mm	METRIC
48-22-9415	15 Pc SAE Combination Wrench Set	1/4", 9/32", 5/16", 11/32", 3/8", 7/16", 1/2", 9/16", 5/8", 11/16", 3/4", 13/16", 7/8", 15/16", 1"	SAE
48-22-9515	15 Pc Metric Combination Wrench Set	8mm, 9mm, 10mm, 11mm, 12mm, 13mm, 14mm, 15mm, 16mm, 17mm, 18mm, 19mm, 20mm, 21mm, 22mm	METRIC

SAE COMBINATION WRENCHES

Model #	Description
45-96-9408	1/4" SAE Combination Wrench
45-96-9409	9/32" SAE Combination Wrench
45-96-9410	5/16" SAE Combination Wrench
45-96-9411	11/32" SAE Combination Wrench
45-96-9412	3/8" SAE Combination Wrench
45-96-9414	7/16" SAE Combination Wrench
45-96-9416	1/2" SAE Combination Wrench
45-96-9418	9/16" SAE Combination Wrench
45-96-9420	5/8" SAE Combination Wrench
45-96-9422	11/16" SAE Combination Wrench
45-96-9424	3/4" SAE Combination Wrench
45-96-9426	13/16" SAE Combination Wrench
45-96-9428	7/8" SAE Combination Wrench
45-96-9430	15/16" SAE Combination Wrench
45-96-9432	1" SAE Combination Wrench

METRIC COMBINATION WRENCHES

Model #	Description
45-96-9508	8mm Metric Combination Wrench
45-96-9509	9mm Metric Combination Wrench
45-96-9510	10mm Metric Combination Wrench
45-96-9511	11mm Metric Combination Wrench
45-96-9512	12mm Metric Combination Wrench
45-96-9513	13mm Metric Combination Wrench
45-96-9514	14mm Metric Combination Wrench
45-96-9515	15mm Metric Combination Wrench
45-96-9516	16mm Metric Combination Wrench
45-96-9517	17mm Metric Combination Wrench
45-96-9518	18mm Metric Combination Wrench
45-96-9519	19mm Metric Combination Wrench
45-96-9520	20mm Metric Combination Wrench
45-96-9521	21mm Metric Combination Wrench
45-96-9522	22mm Metric Combination Wrench

FLEX HEAD RATCHETING COMBINATION WRENCHES

**BETTER ACCESS.
LONGEST LIFE.***



Adjustable Set Screw

Model #	Description	
48-22-9413	15 Pc SAE Flex Head Ratcheting Combination Wrench Set	SAE
48-22-9513	15 Pc Metric Flex Head Ratcheting Combination Wrench Set	METRIC

Model #	Description	
48-22-9429	7 Pc SAE Flex Head Ratcheting Combination Wrench Set	SAE
48-22-9529	7 Pc Metric Flex Head Ratcheting Combination Wrench Set	METRIC

SAE FLEX HEAD RATCHETING COMBINATION WRENCHES

Model #	Description
45-96-9808	1/4" SAE Flex Head Ratcheting Combination Wrench
45-96-9809	9/32" SAE Flex Head Ratcheting Combination Wrench
45-96-9810	5/16" SAE Flex Head Ratcheting Combination Wrench
45-96-9811	11/32" SAE Flex Head Ratcheting Combination Wrench
45-96-9812	3/8" SAE Flex Head Ratcheting Combination Wrench
45-96-9813	7/16" SAE Flex Head Ratcheting Combination Wrench
45-96-9814	1/2" SAE Flex Head Ratcheting Combination Wrench
45-96-9815	9/16" SAE Flex Head Ratcheting Combination Wrench
45-96-9816	5/8" SAE Flex Head Ratcheting Combination Wrench
45-96-9817	11/16" SAE Flex Head Ratcheting Combination Wrench
45-96-9818	3/4" Flex Head Ratcheting Combination Wrench
45-96-9819	13/16" SAE Flex Head Ratcheting Combination Wrench
45-96-9820	7/8" SAE Flex Head Ratcheting Combination Wrench
45-96-9821	15/16" SAE Flex Head Ratcheting Combination Wrench
45-96-9822	1" SAE Flex Head Ratcheting Combination Wrench

METRIC FLEX HEAD RATCHETING COMBINATION WRENCHES

Model #	Description
45-96-9608	8mm Metric Flex Head Ratcheting Combination Wrench
45-96-9609	9mm Metric Flex Head Ratcheting Combination Wrench
45-96-9610	10mm Metric Flex Head Ratcheting Combination Wrench
45-96-9611	11mm Metric Flex Head Ratcheting Combination Wrench
45-96-9612	12mm Metric Flex Head Ratcheting Combination Wrench
45-96-9613	13mm Metric Flex Head Ratcheting Combination Wrench
45-96-9614	14mm Metric Flex Head Ratcheting Combination Wrench
45-96-9615	15mm Metric Flex Head Ratcheting Combination Wrench
45-96-9616	16mm Metric Flex Head Ratcheting Combination Wrench
45-96-9617	17mm Metric Flex Head Ratcheting Combination Wrench
45-96-9618	18mm Metric Flex Head Ratcheting Combination Wrench
45-96-9619	19mm Metric Flex Head Ratcheting Combination Wrench
45-96-9620	20mm Metric Flex Head Ratcheting Combination Wrench
45-96-9621	21mm Metric Flex Head Ratcheting Combination Wrench
45-96-9622	22mm Metric Flex Head Ratcheting Combination Wrench

*When compared to single-pawl ratchet designs. *Includes sizes 3/8"-1" and 10mm-22mm. Sizes 1/4"-11/32" and 8mm-9mm offer 120 unique ratcheting positions and 3° of arc swing.

RATCHETS

BETTER ACCESS



Slim Design
Access tight places

Model #	Description
48-22-9003	1/4" Drive 3" Ratchet
48-22-9014	1/4" Drive 6" Ratchet
48-22-9036	3/8" Drive 5" Ratchet

Model #	Description
48-22-9038	3/8" Drive 9" Ratchet
48-22-9012	1/2" Drive 11" Ratchet

EXTENDED HANDLE RATCHETS

BETTER ACCESS. MORE LEVERAGE*

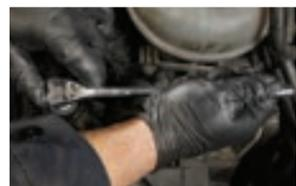
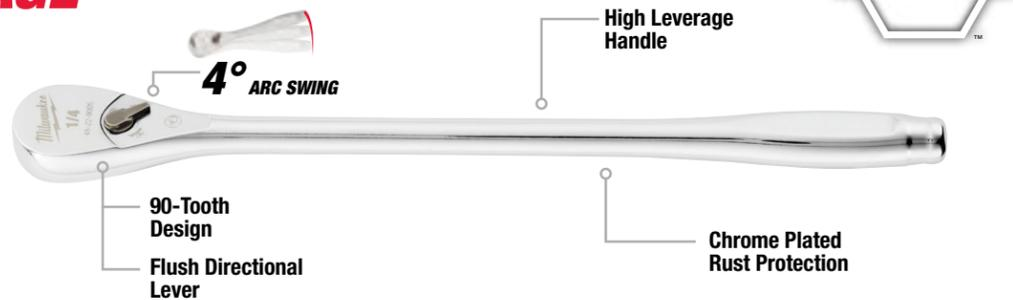

High Leverage Extended Handle

Model #	Description
48-22-9005	1/4" Drive 9" Ratchet
48-22-9037	3/8" Drive 12" Ratchet

Model #	Description
48-22-9050	1/2" Drive 18" Ratchet

STUBBY RATCHETS

BETTER ACCESS

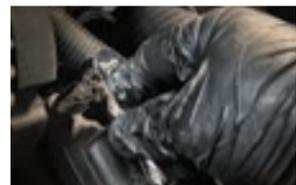
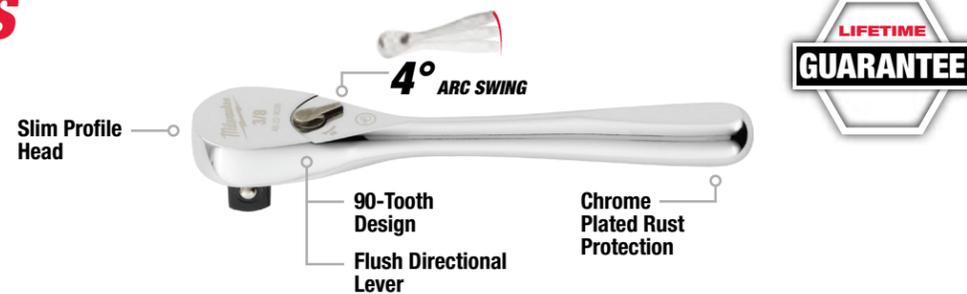

Stubby Handle for Tight Spaces

Model #	Description
48-22-9003	1/4" Drive 3" Ratchet

Model #	Description
48-22-9036	3/8" Drive 5" Ratchet

SOCKETS w/ FOUR FLAT™ SIDES

MOST VERSATILE SOCKETS. ANTI-ROLL, WRENCH-READY.



SAE SOCKETS

Model #	Description
45-34-9001	1/4" Drive 3/16" SAE Socket
45-34-9002	1/4" Drive 7/32" SAE Socket
45-34-9003	1/4" Drive 1/4" SAE Socket
45-34-9004	1/4" Drive 9/32" SAE Socket
45-34-9005	1/4" Drive 5/16" SAE Socket
45-34-9006	1/4" Drive 11/32" SAE Socket
45-34-9007	1/4" Drive 3/8" SAE Socket
45-34-9008	1/4" Drive 7/16" SAE Socket
45-34-9009	1/4" Drive 1/2" SAE Socket
45-34-9010	1/4" Drive 9/16" SAE Socket
45-34-9011	1/4" Drive 5/32" SAE Deep Socket
45-34-9012	1/4" Drive 3/16" SAE Deep Socket
45-34-9013	1/4" Drive 7/32" SAE Deep Socket
45-34-9014	1/4" Drive 1/4" SAE Deep Socket
45-34-9015	1/4" Drive 9/32" SAE Deep Socket
45-34-9016	1/4" Drive 5/16" SAE Deep Socket
45-34-9017	1/4" Drive 11/32" SAE Deep Socket
45-34-9018	1/4" Drive 3/8" SAE Deep Socket
45-34-9019	1/4" Drive 7/16" SAE Deep Socket
45-34-9020	1/4" Drive 1/2" SAE Deep Socket
45-34-9021	1/4" Drive 9/16" SAE Deep Socket
45-34-9060	3/8" Drive 1/4" SAE Socket
45-34-9061	3/8" Drive 5/16" SAE Socket
45-34-9062	3/8" Drive 3/8" SAE Socket
45-34-9063	3/8" Drive 7/16" SAE Socket
45-34-9064	3/8" Drive 1/2" SAE Socket
45-34-9065	3/8" Drive 9/16" SAE Socket
45-34-9066	3/8" Drive 5/8" SAE Socket
45-34-9067	3/8" Drive 11/16" SAE Socket
45-34-9068	3/8" Drive 3/4" SAE Socket
45-34-9069	3/8" Drive 13/16" SAE Socket
45-34-9070	3/8" Drive 7/8" SAE Socket
45-34-9071	3/8" Drive 15/16" SAE Socket
45-34-9072	3/8" Drive 1" SAE Socket
45-34-9073	3/8" Drive 1/4" SAE Deep Socket
45-34-3125	3/8" Drive 5/16" SAE Deep Socket
45-34-3750	3/8" Drive 3/8" SAE Deep Socket

SAE SOCKETS

Model #	Description
45-34-4375	3/8" Drive 7/16" SAE Deep Socket
45-35-5000	3/8" Drive 1/2" SAE Deep Socket
45-34-5625	3/8" Drive 9/16" SAE Deep Socket
45-34-6250	3/8" Drive 5/8" SAE Deep Socket
45-34-6875	3/8" Drive 11/16" SAE Deep Socket
45-34-7500	3/8" Drive 3/4" SAE Deep Socket
45-34-9074	3/8" Drive 13/16" SAE Deep Socket
45-34-9075	3/8" Drive 7/8" SAE Deep Socket
45-34-9100	1/2" Drive 1/2" SAE Socket
45-34-9101	1/2" Drive 9/16" SAE Socket
45-34-9102	1/2" Drive 5/8" SAE Socket
45-34-9103	1/2" Drive 11/16" SAE Socket
45-34-9104	1/2" Drive 3/4" SAE Socket
45-34-9105	1/2" Drive 13/16" SAE Socket
45-34-9106	1/2" Drive 7/8" SAE Socket
45-34-9107	1/2" Drive 15/16" SAE Socket
45-34-9108	1/2" Drive 1" SAE Socket
45-34-9109	1/2" Drive 1-1/16" SAE Socket
45-34-9110	1/2" Drive 1-1/8" SAE Socket
45-34-9126	1/2" Drive 1/2" SAE Deep Socket
45-34-9127	1/2" Drive 9/16" SAE Deep Socket
45-34-9128	1/2" Drive 5/8" SAE Deep Socket
45-34-9129	1/2" Drive 11/16" SAE Deep Socket
45-34-9130	1/2" Drive 3/4" SAE Deep Socket
45-34-9131	1/2" Drive 13/16" SAE Deep Socket
45-34-9132	1/2" Drive 7/8" SAE Deep Socket
45-34-9133	1/2" Drive 15/16" SAE Deep Socket

METRIC SOCKETS

Model #	Description
45-34-9085	3/8" Drive 15mm Metric Socket
45-34-9086	3/8" Drive 16mm Metric Socket
45-34-9087	3/8" Drive 17mm Metric Socket
45-34-9088	3/8" Drive 18mm Metric Socket
45-34-9089	3/8" Drive 19mm Metric Socket
45-34-9090	3/8" Drive 6mm Metric Deep Socket
45-34-9091	3/8" Drive 7mm Metric Deep Socket
45-34-9092	3/8" Drive 8mm Metric Deep Socket

METRIC SOCKETS

Model #	Description
45-34-9093	3/8" Drive 9mm Metric Deep Socket
45-34-0010	3/8" Drive 10mm Metric Deep Socket
45-34-9094	3/8" Drive 11mm Metric Deep Socket
45-34-0012	3/8" Drive 12mm Metric Deep Socket
45-34-0013	3/8" Drive 13mm Metric Deep Socket
45-34-0014	3/8" Drive 14mm Metric Deep Socket
45-34-0015	3/8" Drive 15mm Metric Deep Socket
45-34-9095	3/8" Drive 16mm Metric Deep Socket
45-34-0117	3/8" Drive 17mm Metric Deep Socket
45-34-0118	3/8" Drive 18mm Metric Deep Socket
45-34-0119	3/8" Drive 19mm Metric Deep Socket
45-34-9111	1/2" Drive 10mm Metric Socket
45-34-9112	1/2" Drive 11mm Metric Socket
45-34-9113	1/2" Drive 12mm Metric Socket
45-34-9114	1/2" Drive 13mm Metric Socket
45-34-9115	1/2" Drive 14mm Metric Socket
45-34-9116	1/2" Drive 15mm Metric Socket
45-34-9117	1/2" Drive 16mm Metric Socket
45-34-9118	1/2" Drive 17mm Metric Socket
45-34-9119	1/2" Drive 18mm Metric Socket
45-34-9120	1/2" Drive 19mm Metric Socket
45-34-9121	1/2" Drive 20mm Metric Socket
45-34-9122	1/2" Drive 21mm Metric Socket
45-34-9123	1/2" Drive 22mm Metric Socket
45-34-9124	1/2" Drive 23mm Metric Socket
45-34-9125	1/2" Drive 24mm Metric Socket
45-34-9134	1/2" Drive 10mm Metric Deep Socket
45-34-9135	1/2" Drive 11mm Metric Deep Socket
45-34-9136	1/2" Drive 12mm Metric Deep Socket
45-34-9137	1/2" Drive 13mm Metric Deep Socket
45-34-9138	1/2" Drive 14mm Metric Deep Socket
45-34-9139	1/2" Drive 15mm Metric Deep Socket
45-34-9140	1/2" Drive 16mm Metric Deep Socket
45-34-9141	1/2" Drive 17mm Metric Deep Socket
45-34-9142	1/2" Drive 18mm Metric Deep Socket
45-34-9143	1/2" Drive 19mm Metric Deep Socket

SOCKET SETS w/ FOUR FLAT™ SIDES

MOST VERSATILE SOCKETS. ANTI-ROLL, WRENCH-READY.



Chrome Plated Durability

Stamped Sizes

Model #	Description	SAE	METRIC
48-22-9405	10 Pc 3/8" SAE Deep Well Socket Set w/ FOUR FLAT™ Sides	SAE	
48-22-9505	10 Pc 3/8" Metric Deep Drive Socket Set w/ FOUR FLAT™ Sides		METRIC

Model #	Description	SAE	METRIC
48-22-9403	10 Pc 3/8" SAE Drive Socket Set w/ FOUR FLAT™ Sides	SAE	
48-22-9503	10 Pc 3/8" Metric Drive Socket Set w/ FOUR FLAT™ Sides		METRIC



SOCKET ACCESSORIES



Forged Strength

Rust Protection

Chrome Plated Durability

Model #	Description	SAE	METRIC
43-24-9100	1/4" Drive 3" Extension		
43-24-9101	1/4" Drive 6" Extension		
42-04-9102	1/4" Drive Universal Joint		
43-24-9102	3/8" Drive 3" Extension		

Model #	Description	SAE	METRIC
43-24-0006	3/8" Drive 6" Extension		
42-04-9103	3/8" Drive Universal Joint		
43-24-9103	1/2" Drive 3" Extension		
43-24-9104	1/2" Drive 5" Extension		



BREAKER BARS

BETTER LEVERAGE*



Forged Strength

Rust Protection

Chrome Plated Durability

Model #	Description
48-22-9011	1/2" Drive 15" Breaker Bar

Model #	Description
48-22-9013	1/2" Drive 24" Breaker Bar



HOOK AND PICK SET

UP TO **50% MORE DURABLE**
ALL-METAL CORE



Knurling
Increased tool control

Chrome Plated Rust Protection

Comfort Grip Handle

Model #	Description	Includes
48-22-9215	4 Pc Hook and Pick Set	Straight Pick, Offset Pic, Hook, 90° Pick, and Storage Tray



PRY BAR SET

UP TO **40% MORE PRYING STRENGTH**
I-BEAM DESIGN

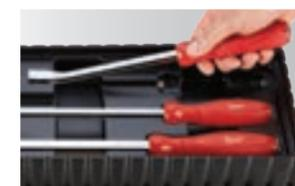

Chrome Plated Rust Protection

Comfortable Tri-Lobe Handles

All-Metal Core

Hammer-Ready Strike Cap

Model #	Description	Included Lengths
48-22-9214	4 Pc Pry Bar Set	8", 12", 18", 24"



11IN1 MULTI-BIT DRIVERS

11IN1



Interchangeable Tip Types

Loop Maker

Model #	Description	Nut Drivers	Bit Types
48-22-2760	11in1 Multi-Bit Driver w/ ECX™	1/4", 5/16", 3/8"	P#1, P#2, SL 3/16", SL 1/4", SQ#1, SQ#2, ECX™#1, ECX™#2
48-22-2761	11in1 Multi-Bit Driver w/ TORX®	1/4", 5/16", 3/8"	P#1, P#2, SL 3/16", SL 1/4", SQ#1, SQ#2, T10, T15

9IN1 MULTI-BIT DRIVERS

**BETTER ACCESS.
MORE VERSATILE.**

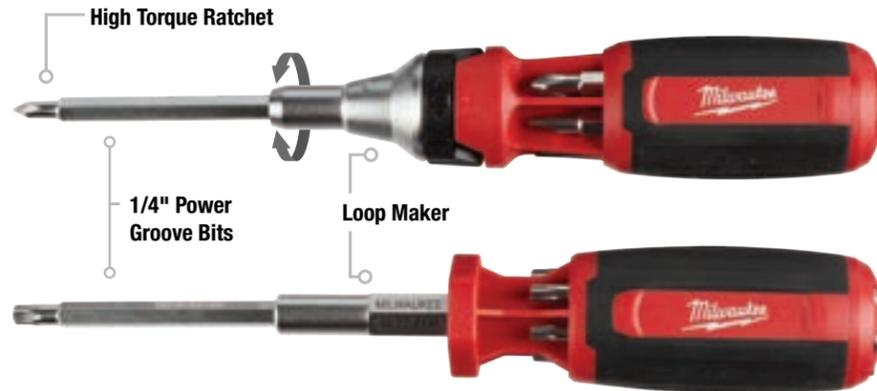

Power Tool Compatibility



In-Handle Storage

Model #	Description	Nut Drivers	Bit Types
48-22-2131	9in1 Multi-Bit Driver w/ ECX™	1/4"	P#1, P#2, SL 3/16", SL 1/4", SQ#2, ECX™#1, ECX™#2v
48-22-2132	9in1 Square Multi-Bit Driver	1/4"	P#1, P#2, SL 3/16", SL 1/4", SQ#1, SQ#2, SQ#3
48-22-2331	9in1 Ratchet Multi-Bit Driver w/ ECX™	1/4"	P#1, P#2, SL 3/16", SL 1/4", SQ#2, ECX™#1, ECX™#2
48-22-2322	9in1 Ratchet Multi-Bit Driver w/ Square	1/4"	P#1, P#2, SL 3/16", SL 1/4", SQ#1, SQ#2, SQ#3
48-22-2133	9in1 TORX® Key Driver	1/4"	T8, T10, T15, T20, T25, T27, T30
48-22-2134	9in1 SAE Hex Key Driver	1/4"	7/64", 1/8", 9/64", 5/32", 3/16", 7/32", 1/4"
48-22-2136	9in1 Metric Hex Key Driver	1/4"	1.5mm, 2mm, 2.5mm, 3mm, 4mm, 5mm, 6mm
48-22-2110	4 Pc Replacement Bit Set		P#1, P#2, SL 3/16", SL 1/4", SQ #1, SQ#1, ECX™#1

8IN1 COMPACT MULTI-BIT DRIVERS

**BETTER ACCESS.
MORE VERSATILE.**



In-Handle Storage

Model #	Description	Nut Drivers	Bit Types
48-22-2130	Compact 8in1 Multi-Bit Driver	1/4"	P#1, P#2, SL 3/16", SL 1/4", SQ#1, SQ#2, T15
48-22-2330	Compact 8in1 Ratchet Multi-Bit Driver	1/4"	P#1, P#2, SL 3/16", SL 1/4", SQ#1, SQ#2, T15

NAIL PULLERS

**MAXIMUM LEVERAGE.
MOST DURABLE GRIP.**



Precision Beveled Edge, Better Access

Model #	Description
48-22-9030	9" Finish Nail Puller
48-22-9031	10" Nail Puller

Model #	Description
48-22-9033	10" Molding Puller
48-22-9032	12" Nail Puller

PRY BARS

**ULTIMATE
VIBRATION REDUCTION**

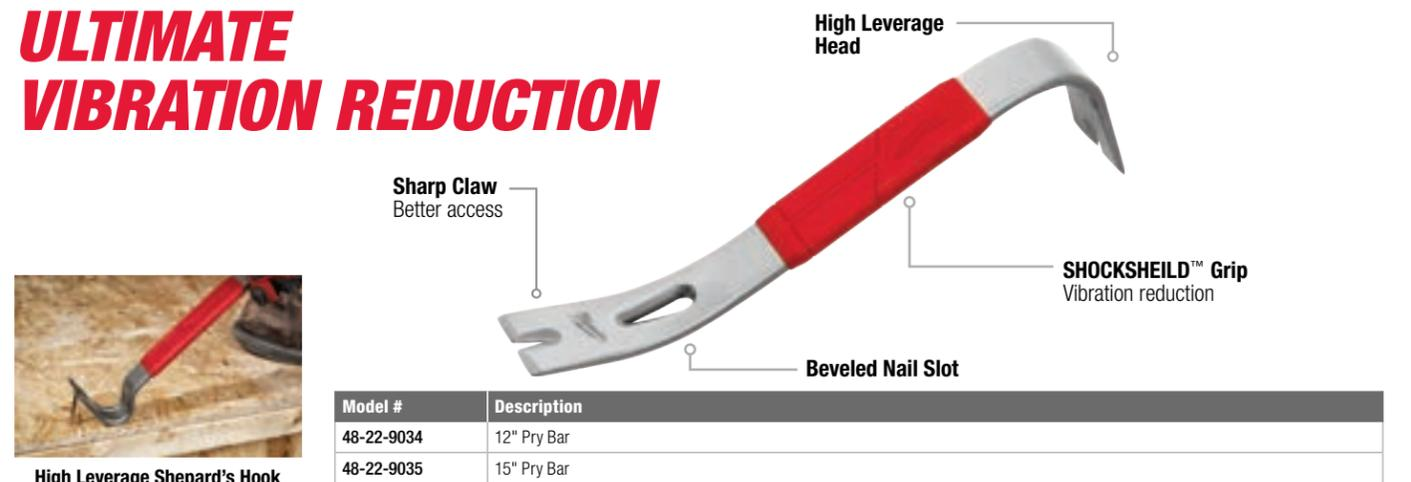

High Leverage Shepard's Hook

Model #	Description
48-22-9034	12" Pry Bar
48-22-9035	15" Pry Bar

DRILLING HAMMER

**DUAL FACE
VERSATILITY**



Dual Face Versatility Smooth and milled face

Model #	Description
48-22-9010	3 lbs Fiberglass Drilling Hammer

SCREWDRIVERS

**HIGH-LEVERAGE HANDLE.
MAGNETIC TIP.**



Comfortable Tri-Lobe Handle

Model #	Description	Bit Types
48-22-2702	2 Pc Demolition Screwdriver Set	P#2, SL 5/16"
48-22-2706	6 Pc Screwdriver Set	P#1, P#2, SL 3/16", SL 1/4", SL 5/16"
48-22-2708	8 Pc Screwdriver Set w/ ECX™	P#1, P#2, SL 3/16", SL 1/4", SL 5/16", ECX™#1, ECX™#2
48-22-2710	10 Pc Screwdriver Set	P#1, P#2, SL 3/16", SL 1/4", SL 5/16", SQ#1, SQ#2
48-22-2718	8 Pc Screwdriver Set w/ Square	P#1, P#2, SL 3/16", SL 1/4", SL 5/16", SQ#1, SQ#2
48-22-2700	Bottle Opener	

CUSHION-GRIP SCREWDRIVERS

**MOST DURABLE HANDLE.
PRECISION TIP.**



Anti-Peel Design Cushion Grips

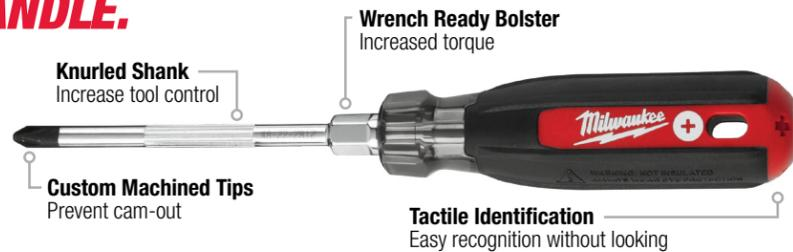

Model #	Description
48-22-2811	#1 Phillips (3")
48-22-2812	#2 Phillips (4")
48-22-2813	#3 Phillips (6")
48-22-2814	#2 Phillips (10")
48-22-2815	#2 Phillips (6") Cushion-Grip Demolition Screwdriver

Model #	Description
48-22-2821	1/4" Slotted (4")
48-22-2822	5/16" Slotted (6")
48-22-2824	3/8" Slotted (8")
48-22-2831	3/16" Cabinet (3")
48-22-2832	3/16" Cabinet (6")
48-22-2833	3/16" Cabinet (8")

Model #	Description
48-22-2834	1/4" Cabinet (10")
48-22-2841	#1 ECX™ (4")
48-22-2842	#2 ECX™ (4")
48-22-2851	#1 Square (3")
48-22-2852	#2 Square (4")
48-22-2853	#3 Square (6")

Model #	Description	Bit Types
48-22-2884	4 Pc Cushion-Grip Screwdriver Set	P#2, SL 1/4", SL 5/16", SL 6"
48-22-2885	5 Pc Cushion-Grip Screwdriver Set	P#2, SL 1/4", SL 5/16", SL 6"
48-22-2886	6 Pc Cushion-Grip Screwdriver Set	P#2, P#3, SL 1/4", SL 3/16", SL 5/16"

13IN1 CUSHION-GRIP SCREWDRIVERS

13IN1



ECX™ Bit



Schrader® Valve Core Remover

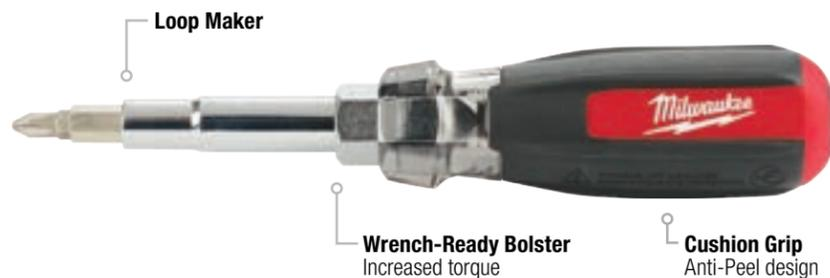

Model #	Description	Nut Drivers	Bit Types
48-22-2880	13in1 Cushion-Grip Screwdriver w/ ECX™ Bit	1/4", 5/16", 3/8", 1/2"	P#1, P#2, SL 3/16", SL1/4", SQ#1, SQ#2, ECX™#1, ECX™#2
48-22-2881	13in1 Cushion-Grip Screwdriver w/ Schrader® Bit	1/4", 5/16", 3/8", 1/2"	P#1, P#2, SL 3/16", SL1/4", SQ#1, SQ#2, Std Schrader®, Large Schrader®

DEMO DRIVERS



Aggressive Duct Piercing Tip

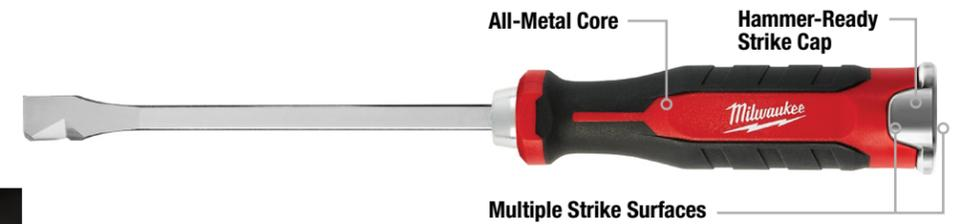

Model #	Description
48-22-2860	Demo Driver
48-22-2823	Slotted 5/16" 6" Cushion-Grip Demolition Screwdriver
48-22-2825	Slotted 3/8" 8" Cushion-Grip Demolition Screwdriver
48-22-2702	2 Pc Demolition Screwdriver Set

1000V INSULATED SCREWDRIVERS



Slim Drive Shaft
Allows access in recessed applications

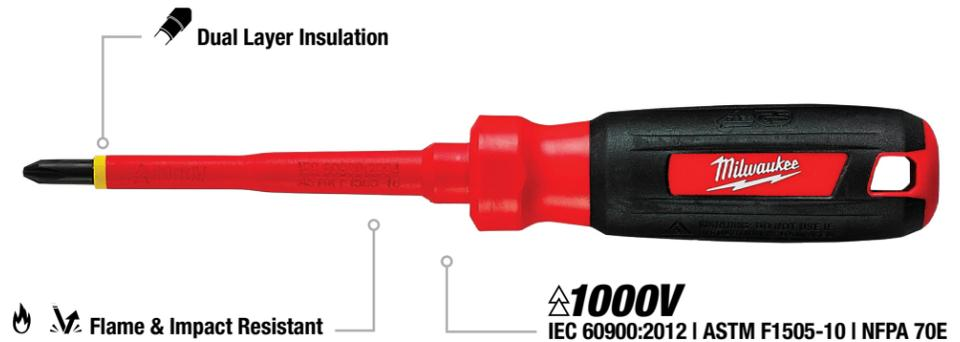

Model #	Description
48-22-2211	#1 Phillips (3")
48-22-2212	#2 Phillips (4")
48-22-2213	#3 Phillips (6")
48-22-2221	1/4" Slotted (6")
48-22-2222	5/16" Slotted (7")
48-22-2223	3/8" Slotted (8")
48-22-2224	3/8" Slotted (10")
48-22-2231	3/16" Cabinet (4")

Model #	Description
48-22-2232	3/16" Cabinet (6")
48-22-2233	3/16" Cabinet (8")
48-22-2241	#1 ECX™ (4")
48-22-2242	#2 ECX™ (4")
48-22-2251	#1 Square (3")
48-22-2252	#2 Square (4")
48-22-2253	#3 Square (6")

Model #	Description	Bit Types, Carrying Case
48-22-2202	3 Pc 1000V Insulated Screwdriver Set	P#2, SL 1/4", ECX™#1
48-22-2204	4 Pc 1000V Insulated Screwdriver Set w/ Case	P#1, P#2, SL 1/4", SL 3/8", Extra Capacity Roll Up Pouch
48-22-2205	4 Pc 1000V Insulated Screwdriver Set w/ Case	SL 1/4", SL 3/8", SQ#1, SQ#2, Extra Capacity Roll Up Pouch
48-22-2210	10 Pc 1000V Insulated Screwdriver Set w/ Case	P#1, P#2, P#3, SL 1/4", SL 5/16", SL 3/8", SQ#1, SQ#2, SQ#3, ECX™#1, EVA Foam Fitted Case
48-22-2203	3 Pc 1000V Insulated Screwdriver Set	#1 ECX™ (4"), #2 Phillips (4"), 1/4" Slotted (6")

PRECISION SCREWDRIVERS

UP TO 4X STRONGER



All-Metal Core



Model #	Description	Bit Types
48-22-2604	4 Pc Precision Screwdriver Set	P#1, SL 1/16", SL 3/32", SL 1/8"
48-22-2606	6 Pc Precision Screwdriver Set w/ Case	P#1, P#2, SL 1/16", SL 3/32", SL 1/8", SL 5/32"
48-22-2610	6 Pc TORX® Precision Screwdriver Set w/ Case	T6, T7, T8, T9, T10, T15

HOLLOWCORE™ MAGNETIC NUT DRIVERS

UNLIMITED DEPTH
FITS 4X MORE FASTENERS

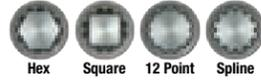

SAE METRIC



Model #	Description	Sizes
48-22-2502	2 Pc HOLLOWCORE™ Magnetic Nut Driver Set	1/4", 5/16"
48-22-2507	7 Pc HOLLOWCORE™ SAE Magnetic Nut Driver Set	1/4", 5/16", 11/32", 3/8", 7/16", 1/2", 9/16"
48-22-2517	7 Pc HOLLOWCORE™ Metric Magnetic Nut Driver Set	5mm, 5.5mm, 6mm, 7mm, 8mm, 10mm, 13mm

Model #	Description
48-22-2520	3/16" Magnetic Nut Driver
48-22-2521	1/4" HOLLOWCORE™ Magnetic Nut Driver
48-22-2522	5/16" HOLLOWCORE™ Magnetic Nut Driver
48-22-2523	11/32" HOLLOWCORE™ Magnetic Nut Driver
48-22-2524	3/8" HOLLOWCORE™ Magnetic Nut Driver

Model #	Description
48-22-2525	7/16" HOLLOWCORE™ Magnetic Nut Driver
48-22-2526	1/2" HOLLOWCORE™ Magnetic Nut Driver
48-22-2527	9/16" HOLLOWCORE™ Magnetic Nut Driver
48-22-2531	5mm HOLLOWCORE™ Magnetic Nut Driver
48-22-2532	5.5mm HOLLOWCORE™ Magnetic Nut Driver

Model #	Description
48-22-2533	6mm HOLLOWCORE™ Magnetic Nut Driver
48-22-2534	7mm HOLLOWCORE™ Magnetic Nut Driver
48-22-2535	8mm HOLLOWCORE™ Magnetic Nut Driver
48-22-2536	10mm HOLLOWCORE™ Magnetic Nut Driver
48-22-2537	13mm HOLLOWCORE™ Magnetic Nut Driver

HOLLOW SHAFT NUT DRIVERS

FITS 4X MORE FASTENERS



SAE METRIC

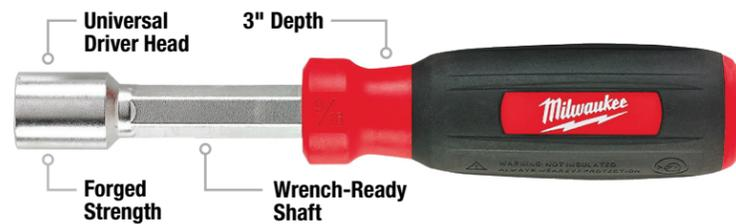

Model #	Description	Sizes
48-22-2402	2 Pc SAE Hollow Shaft Nut Driver Set	1/4", 5/16"
48-22-2404	4 Pc SAE Hollow Shaft Nut Driver Set	1/4", 5/16", 7/16", 9/16"
48-22-2407	7 Pc SAE Hollow Shaft Nut Driver Set	1/4", 5/16", 11/32", 3/8", 7/16", 1/2", 9/16"
48-22-2417	7 Pc Metric Hollow Shaft Nut Driver Set	5mm, 5.5mm, 6mm, 7mm, 8mm, 10mm, 13mm

Model #	Description
48-22-2420	3/16" Hollow Shaft Nut Driver
48-22-2421	1/4" Hollow Shaft Nut Driver
48-22-2422	5/16" Hollow Shaft Nut Driver
48-22-2423	11/32" Hollow Shaft Nut Driver
48-22-2424	3/8" Hollow Shaft Nut Driver

Model #	Description
48-22-2425	7/16" Hollow Shaft Nut Driver
48-22-2426	1/2" Hollow Shaft Nut Driver
48-22-2427	9/16" Hollow Shaft Nut Driver
48-22-2431	5mm Hollow Shaft Nut Driver
48-22-2432	5.5mm Hollow Shaft Nut Driver

Model #	Description
48-22-2433	6mm Hollow Shaft Nut Driver
48-22-2434	7mm Hollow Shaft Nut Driver
48-22-2435	8mm Hollow Shaft Nut Driver
48-22-2436	10mm Hollow Shaft Nut Driver
48-22-2437	13mm Hollow Shaft Nut Driver

FRAMING HAMMERS

UP TO 10X VIBRATION REDUCTION
SHOCKSHIELD™ GRIP

Available in



Magnetic Nail Set

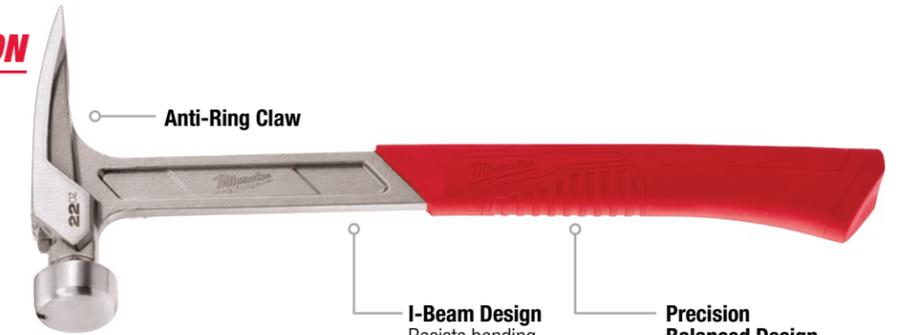

Model #	Description
48-22-9016	17oz Milled Face Hammer
48-22-9017	17oz Smooth Face Hammer
48-22-9022	22oz Milled Face Hammer

Model #	Description
48-22-9023	22oz Smooth Face Hammer
48-22-9080	20oz Curved Claw Hammer

POLY FIBERGLASS HAMMER

MOST DURABLE
FIBERGLASS HANDLE

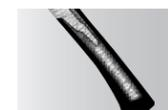

Reinforced Fiberglass Handle

Model #	Description
48-22-9316	19oz Smooth Face Poly/Fiberglass Hammer

HICKORY HAMMERS

BEST DRIVING
PERFORMANCE



Magnetic Nail Set

Model #	Description
48-22-9419	19oz Hickory Hammer – Milled Face
48-22-9419	19oz Hickory Hammer – Smooth Face

FIXED BLADE KNIFE

STAYS SHARPER LONGER



Durable Sheath



Model #	Description
48-22-1926	4" Tradesman Fixed Blade Knife

LINEMAN'S HAWKBILL KNIVES

STAYS SHARPER LONGER



Universal Hot Stick Compatible



- STICKWORK™ 3in1 RING**
- Shotgun Hot Stick Compatible
 - Universal Hot Stick Compatible
 - Hang Ring

Also Available:



Hawkbill Fixed Blade Knife
48-22-1925

Model #	Description
48-22-1923	Lineman's Hawkbill Knife w/ STICKWORK™ 3in1 Ring
48-22-1924	Lineman's Blunt Tip Hawkbill Knife w/ STICKWORK™ 3in1 Ring
48-22-1925	Hawkbill Fixed Blade Knife

LINEMAN'S UNDERGROUND KNIFE

STAYS SHARPER LONGER



Blade Cover Storage



Model #	Description
48-22-1929	Lineman's Underground Knife

HARDLINE™

HARDLINE™ FIXED BLADE KNIVES

ULTIMATE DURABILITY™

AUS-8 STEEL



Multi-Position Sheath



Model #	Description
48-22-1928	5" HARDLINE™ Fixed Blade Knife
48-22-1928B	5" HARDLINE™ Fixed Blade Knife

HARDLINE™ POCKET KNIVES

EXTREME WEAR RESISTANCE™

D2 STEEL



Drop Point Smooth Blade



Model #	Description	Model #	Description
48-22-1994	HARDLINE™ 3" Smooth Blade Pocket Knife	48-22-1998	HARDLINE™ 3" Serrated Blade Pocket Knife
48-22-1997	HARDLINE™ 2-1/2" Smooth Blade Pocket Knife	48-22-1999	HARDLINE™ 3-1/2" Smooth Blade Pocket Knife

FASTBACK™

FASTBACK™ 6in1 UTILITY KNIFE

PRESS AND FLIP



Screwdriver and Folding 1/4" Bit Holder



Model #	Description
48-22-1505	FASTBACK™ 6in1 Folding Utility Knife

FASTBACK™ 5in1 FOLDING KNIFE

PRESS AND FLIP™



Bottle Opener



Model #	Description
48-22-1540	FASTBACK™ 5in1 Folding Knife

FASTBACK™ FOLDING KNIVES

PRESS AND FLIP™

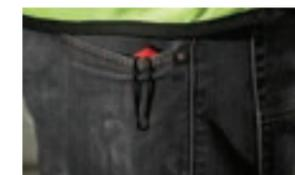

Durable Wire Belt Clip Reduces pocket tearing

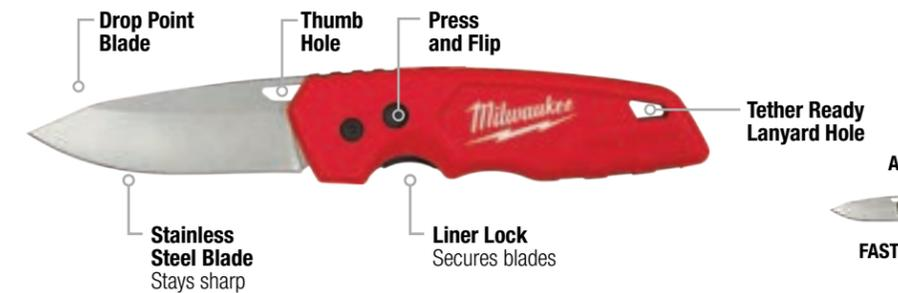

Also Available:



FASTBACK™ Camo Folding Knife
48-22-1524

Model #	Description
48-22-1520	FASTBACK™ Folding Knife
48-22-1525	FASTBACK™ Hawkbill Folding Flip Knife
48-22-1524	FASTBACK™ Camo Folding Knife

FASTBACK™ COMPACT FOLDING KNIFE

PRESS AND FLIP



Blade Holder Designed for Scoring

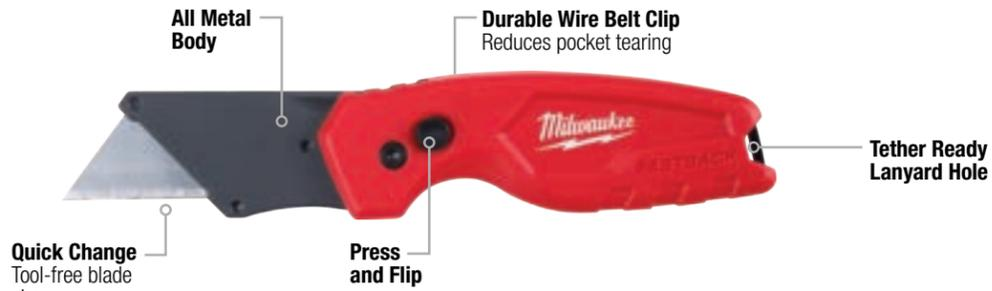

Model #	Description
48-22-1500	FASTBACK™ Compact Folding Utility Knife

FASTBACK™ HAWKBILL FOLDING KNIVES

PRESS AND FLIP™



Ideal for Stripping Cable



Model #	Description
48-22-1525	FASTBACK™ Hawkbill Folding Knife
48-22-1526	FASTBACK™ Blunt Tip Hawkbill Folding Knife

FASTBACK™ UTILITY KNIVES

PRESS AND FLIP™



Wire Stripper

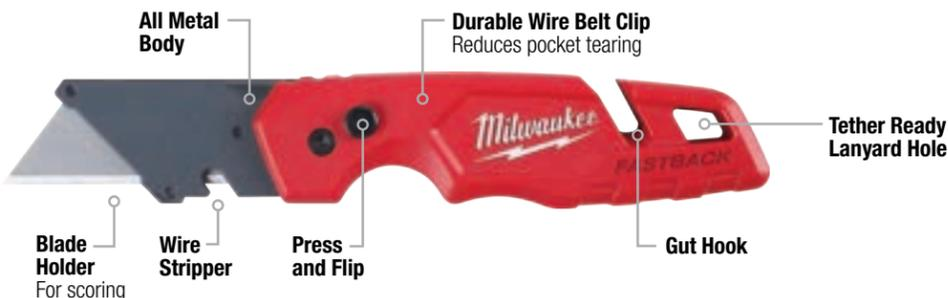

Model #	Description
48-22-1501	FASTBACK™ Folding Utility Knife
48-22-1502	FASTBACK™ Folding Utility Knife w/ Blade Storage
48-22-1503	FASTBACK™ Folding Utility Knife & FASTBACK™ Compact Knife Set

Model #	Description
48-22-1504	FASTBACK™ Folding Utility Knife w/ Blade Storage and 50 Pc General Blades
48-22-1901	FASTBACK™ Folding Utility Knife

FASTBACK™ SPRING ASSISTED POCKET KNIVES

Spring Assisted



Partially Serrated



Model #	Description
48-22-1530	FASTBACK™ Spring Assisted Knife
48-22-1535	FASTBACK™ Camo Spring Assisted Knife

Also Available:
FASTBACK™ Camo Spring Assisted Knife
48-22-1996

LOCKBACK POCKET KNIFE



Lockback Strong Secure Hold



Model #	Description
48-22-1940	Lockback Pocket Knife

COMPACT FOLDING KNIFE

STAYS SHARP



Drop Point Blade



Model #	Description
48-22-1521	Compact Folding Utility Knife

COMPACT SIDE SLIDE KNIFE

**SIDE SLIDE.
MAXIMUM CONTROL.**

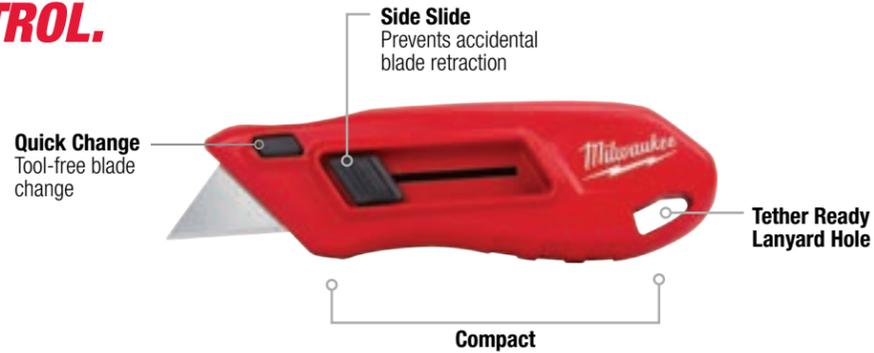

Tool-Free Blade Change

Model #	Description
48-22-1511	Compact Side Sliding Utility Knife

SIDE SLIDING UTILITY KNIFE

**MAXIMUM
DEPTH CONTROL**



Holds up to 5 Blades

Model #	Description
48-22-1510	Side Sliding Utility Knife

FIXED BLADE UTILITY KNIFE

FIXED BLADE



Overmold Grip

Model #	Description
48-22-1513	Fixed Blade Utility Knife

GENERAL PURPOSE

LASTS 5X LONGER



General Purpose



HOOK

UP TO 2X STRONGER



Ideal for Roofing

High Quality Steel



DRYWALL

UP TO 2X SHARPER



Ideal for Drywall

Custom Grind Angle



CARTON

LASTS 5X LONGER



Ideal for Cartons

Rounded Edges



Description	5 Pc	15 Pc (Case Included)	50 Pc (Dispenser Included)	75 Pc (Dispenser Included)	100 Pc (Dispenser Included)
General Purpose Utility Blades	48-22-1905	-	48-22-1950	48-22-1975	48-22-1900
Hook Utility Blades	48-22-1932	-	48-22-1952	-	-
Drywall Utility Blades	48-22-1933	-	48-22-1953	-	-
Carton Utility Blades	48-22-1934	-	48-22-1954	-	-
15 Pc Assorted Utility Blade Set	-	48-22-1930 (10) General Purpose, (2) Hook, (3) Carton	-	-	-

SELF RETRACTING UTILITY KNIFE

**SIDE SLIDE.
SELF RETRACT.**



2 Blade Positions

Model #	Description
48-22-1512	Self Retracting Utility Knife

SAFETY CUTTER

UP TO 5X LONGER LIFE

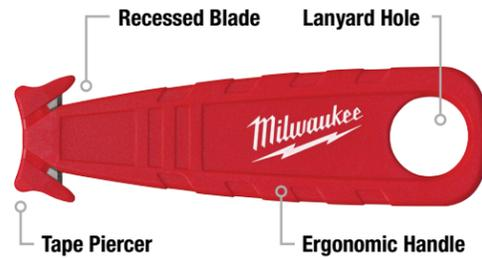

Model #	Description
48-22-1916	Safety Cutter

PRECISION SNAP-OFF KNIVES

**METAL LOCK
UP TO 10X LONGER LIFE**



Model #	Description
48-22-1960	9mm (A) Precision Snap-Off Knife
48-22-1961	18mm (L) Precision Snap-Off Knife w/ Metal Lock

Model #	Description
48-22-1962	25mm (H) Precision Snap-Off Knife w/ Metal Lock

Description	3 Pc	10 Pc
9mm (A) Precision Snap-Off Replacement Blades	48-22-9309	48-22-9109
18mm (L) Precision Snap-Off Replacement Blades	48-22-9318	48-22-9118
25mm (H) Precision Snap-Off Replacement Blades	48-22-9325	48-22-9125



Blade Snap Off

GENERAL PURPOSE SNAP-OFF KNIVES

**FASTER BLADE
ADJUSTMENT**

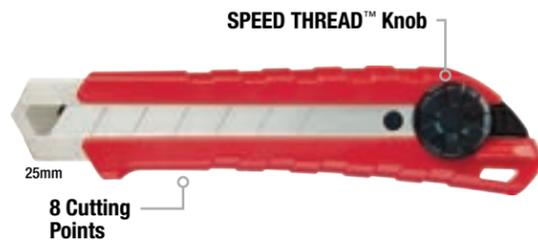

Model #	Description
48-22-1963	9mm (A) General Purpose Snap-Off Knife
48-22-1964	18mm (L) General Purpose Snap-Off Knife

Model #	Description
48-22-1965	25mm (H) General Purpose Snap-Off Knife

Description	3 Pc	10 Pc
9mm (A) General Purpose Snap-Off Replacement Blades	48-22-1309	48-22-1109
18mm (L) General Purpose Snap-Off Replacement Blades	48-22-1318	48-22-1118
25mm (H) General Purpose Snap-Off Replacement Blades	48-22-1325	48-22-1125



Blade Snap-Off

INSULATION KNIVES

STAYS SHARPER LONGER

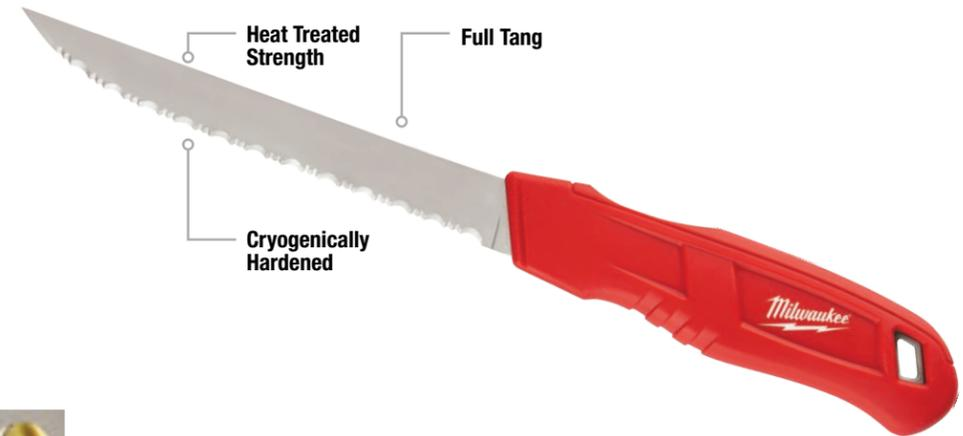

Rounded Handle
Smoothing Applications

Model #	Description
48-22-1921	Insulation Knife (Smooth)
48-22-1922	Insulation Knife (Serrated)

DUCT KNIFE

STAYS SHARPER LONGER

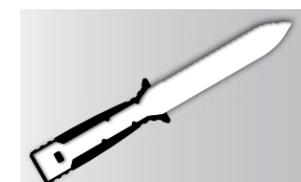
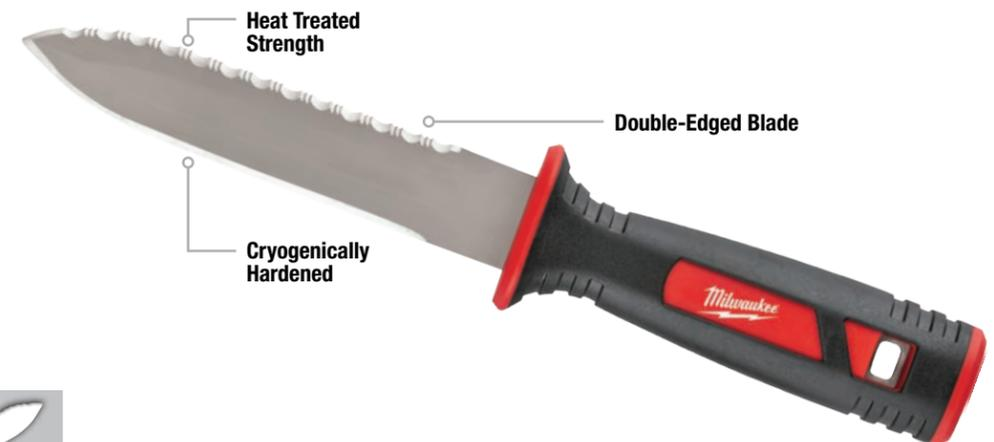

Full Tang

Model #	Description
48-22-1920	Duct Knife

RASPING JAB SAW

UP TO **2X FASTER PLUNGE CUTS**



Piercing Tip

Model #	Description
48-22-0304	Rasping Jab Saw

FOLDING JAB SAW

UP TO **10X FASTER BLADE CHANGE**



Folding Blade

Model #	Description
48-22-0305	Folding Jab Saw

PVC/ABS SAWS

FAST CUTS THROUGH PVC



Metal Core

Model #	Description
48-22-0212	12" PVC/ABS Saw
48-22-0222	12" PVC/ABS Saw Replacement Blade
48-22-0223	18" PVC/ABS Saw
48-22-0220	18" PVC/ABS Saw Replacement Blade

AVIATION SNIPS

UP TO **10X MORE CUTS**
FORGED BLADES



Flush Bolt Design
Won't hang up on material

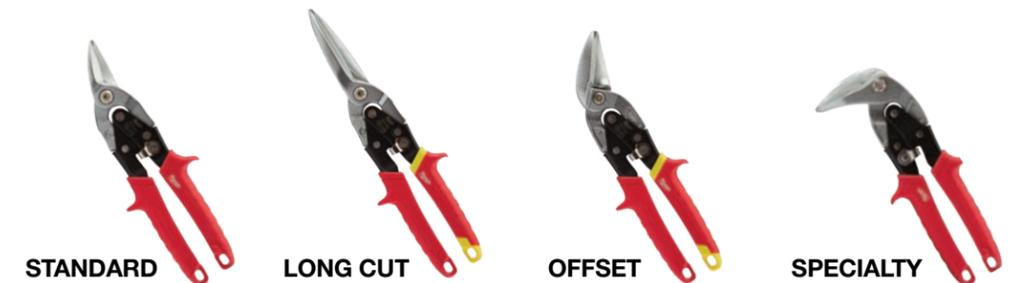

Model #	Description	Cold Rolled Steel	Stainless Steel
48-22-4530	Straight Cutting Standard Snips	18ga	22ga
48-22-4510	Left Cutting Standard Snips	18ga	22ga
48-22-4520	Right Cutting Standard Snips	18ga	22ga
48-22-4533	3 Pc Standard Snips Set	18ga	22ga
48-22-4532	Straight Cutting Offset Snips	18ga	22ga
48-22-4512	Left Cutting Offset Snips	18ga	22ga
48-22-4522	Right Cutting Offset Snips	18ga	22ga

Model #	Description	Cold Rolled Steel	Stainless Steel
48-22-4523	2 Pc Offset Snips Set	18ga	22ga
48-22-4537	Long Cut Straight Cutting Snips	20ga	22ga
48-22-4538	Long Cut Offset Snips	20ga	22ga
48-22-4500	Bulldog Snips	16ga	18ga
48-22-4511	Left Cutting Right Angle Snips	24ga	28ga
48-22-4521	Right Cutting Right Angle Snips	24ga	28ga

OFFSET COMPOUND TINNER

TOUGH CUTS

2X FORCE, LESS EFFORT

BOLT LOCK

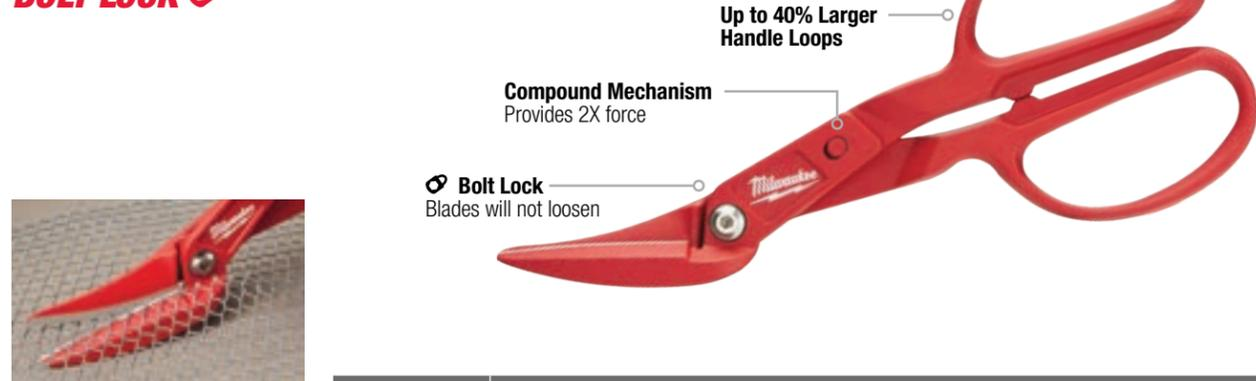

45° Offset Cut clearance

Model #	Description
48-22-4005	Offset Compound Tinner

CLASSIC TINNERS

BLADES WILL NOT LOOSEN

BOLT LOCK



40% Larger Handle Loops

Model #	Description
48-22-4003	10" Classic Tinner
48-22-4002	12" Classic Tinner
48-22-4001	16" Bulldog Tinner

DUCKBILL TINNER

BLADES WILL NOT LOOSEN

BOLT LOCK



40% Larger Handle Loops

Model #	Description
48-22-4004	10" Duckbill Tinner

LIGHTWEIGHT TINNER

STRAIGHTER, CLEANER CUTS



40% Larger Handle Loops

Model #	Description
48-22-4006	13" Lightweight Tinner
48-22-4007	Lightweight Tinner Replacement Blades

JOBSITE SCISSORS

ALL-METAL HANDLES

UP TO 10X LONGER LIFE

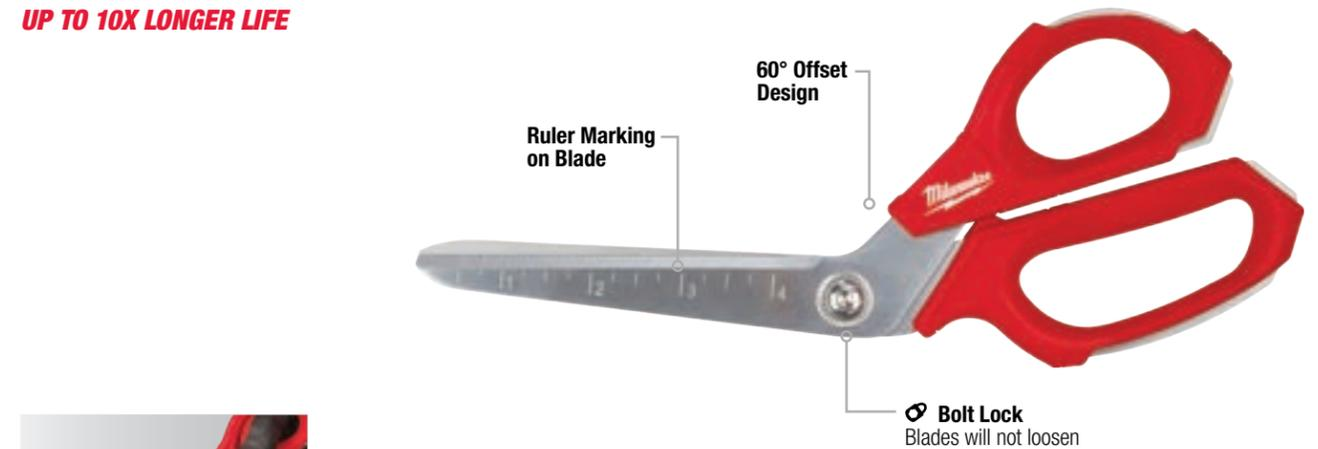

Index Finger Groove

Model #	Description
48-22-4047	Jobsite Offset Scissors

Model #	Description
48-22-4046	Jobsite Straight Scissors

ADAPTABLE BOLT CUTTERS w/ POWERMOVE™ EXTENDABLE ARMS

MORE CUTS. MAXIMUM VERSATILITY.

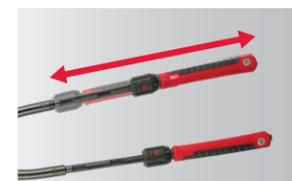

POWERMOVE™ Extendable Arms

Model #	Description	Max Capacity	
		Soft/Medium Materials (up to 31 HRC)	Hard Materials (up to 48 HRC)
48-22-4114	14" Adaptable Bolt Cutter	5/16"	3/16"
48-22-4124	24" Adaptable Bolt Cutter	7/16"	5/16"

BOLT CUTTERS

**MORE CUTS.
LONGER LIFE.**



Forged Steel Blades & Custom Heat Treated
Maximum durability

Model #	Description	Max Capacity	
		Soft/Medium Materials (up to 31 HRC)	Hard Materials (up to 48 HRC)
48-22-4014	14" Bolt Cutter	5/16"	3/16"
48-22-4018	18" Bolt Cutter	3/8"	1/4"
48-22-4024	24" Bolt Cutter	7/16"	5/16"
48-22-4031	30" Bolt Cutter	1/2"	3/8"

FIBERGLASS BOLT CUTTER w/ PIVOTMOVE™

**BEST ACCESS.
1000V INSULATED.**



PIVOTMOVE™ Rotating Handles
Greater Accessibility

Model #	Description	Max Capacity	
		Soft/Medium Materials (up to 31 HRC)	Hard Materials (up to 48 HRC)
48-22-4218	18" Fiberglass Bolt Cutter w/ PIVOTMOVE™ Rotating Handles	3/8"	1/4"
48-22-4224	24" Fiberglass Bolt Cutter w/ PIVOTMOVE™ Rotating Handles	5/16"	7/16"

HIGH-TENSION HACKSAW

**MOST DURABLE.
HIGHEST TENSION.**

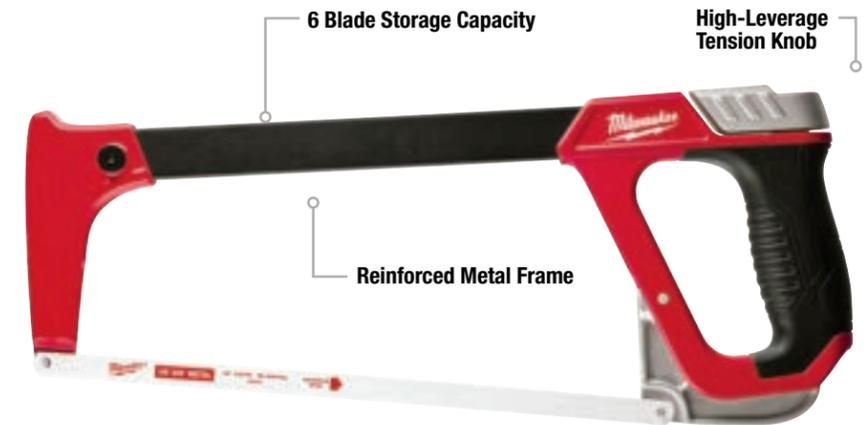

45° Angle Blade Position

Model #	Description
48-22-0050	12" High-Tension Hacksaw
48-43-0600	10 Pc 12" 14TPI Hacksaw Blade
48-43-0610	10 Pc 12" 18TPI Hacksaw Blade

Model #	Description
48-43-0620	10 Pc 12" 24TPI Hacksaw Blade
48-43-0630	10 Pc 12" 32TPI Hacksaw Blade

COMPACT HACKSAW

UP TO 10X FASTER BLADE CHANGE



Compact Design

Model #	Description
48-22-0012	Compact Hacksaw

LINEMAN'S HIGH-LEVERAGE RATCHETING WRENCHES

MOST DURABLE RATCHET BUILT-IN HAMMER

MILLED **SMOOTH**

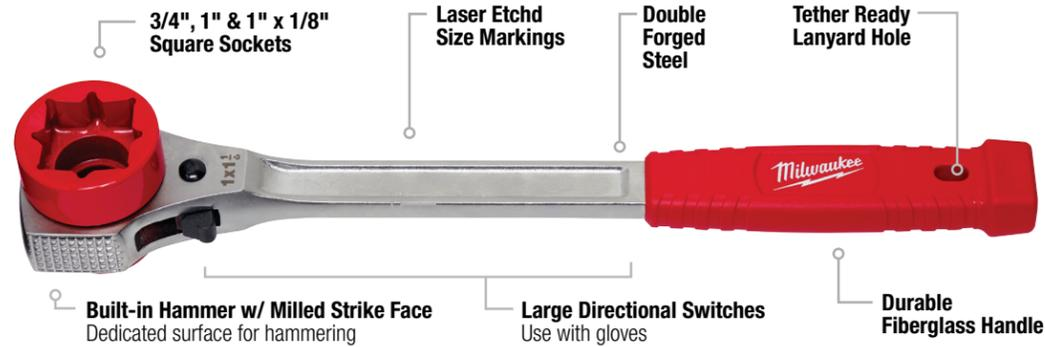

Durable Fiberglass Handle

Also Available:
Lineman's High-Leverage Ratcheting Wrench w/ Smooth Strike Face
48-22-9213

Model #	Description
48-22-9213M	Lineman's High-Leverage Ratcheting Wrench w/ Milled Strike Face
48-22-9213	Lineman's High-Leverage Ratcheting Wrench w/ Smooth Strike Face

LINEMAN'S 5IN1 RATCHETING WRENCHES

MOST DURABLE RATCHET BUILT-IN HAMMER

5in1

MILLED **SMOOTH**



Built-In Hammer

Also Available:
Lineman's 5in1 Ratcheting Wrench w/ Smooth Strike Face
48-22-9216

Model #	Description
48-22-9216M	Lineman's 5in1 Ratcheting Wrench w/ Milled Strike Face
48-22-9216	Lineman's 5in1 Ratcheting Wrench w/ Smooth Strike Face

2IN1 LINEMAN'S INSULATED RATCHETING BOX WRENCH

DURABLE, FORGED STEEL. 1000V INSULATED.



9/16" and 3/4" Twelve Point Sockets

Model #	Description
48-22-9211	Lineman's 2in1 Insulated Ratcheting Box Wrench

4IN1 LINEMAN'S INSULATED RATCHETING BOX WRENCH

DURABLE, FORGED STEEL. 1000V INSULATED.

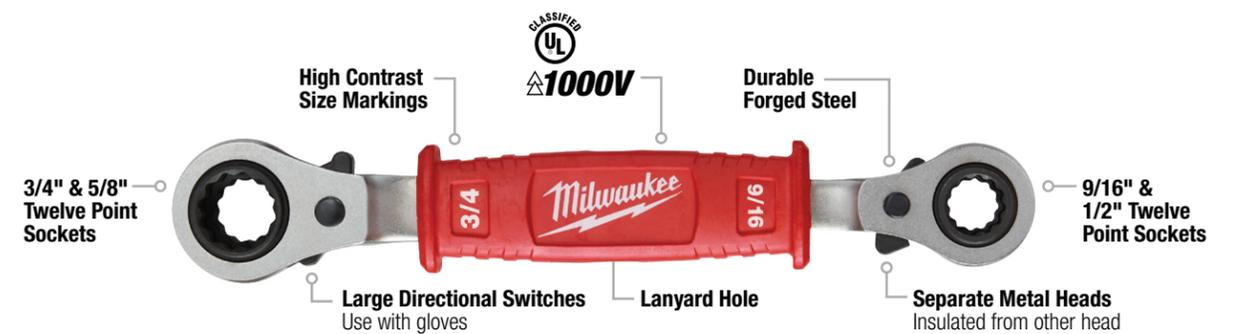

Ergonomic Handle

Model #	Description
48-22-9212	Lineman's 4in1 Insulated Ratcheting Box Wrench

TUBING CUTTER

**STRAIGHTER,
CLEANER CUTS**



Double Ground V-Shape Blade



Model #	Description
48-22-4204	Tubing Cutter
48-22-4203	Tubing Cutter Replacement Blade

RATCHETING PIPE CUTTERS

**STRAIGHT,
EASY CUTS**



Comfortable Handle Design



Model #	Description	Model #	Description
48-22-4210	1-5/8" Ratcheting Pipe Cutter	48-22-4215	2-3/8" Ratcheting Pipe Cutter
48-22-4211	1-5/8" Ratcheting Pipe Cutter Replacement Blade	48-22-4216	2-3/8" Ratcheting Pipe Cutter Replacement Blade

REAMING PEN



Copper

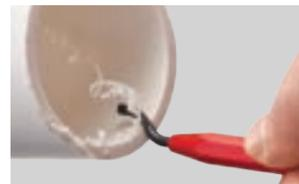

PVC



Model #	Description
48-22-4255	Reaming Pen

MINI COPPER TUBING CUTTERS

5X LONGER LIFE
**REINFORCED ADJUSTMENT
MECHANISM**



Chrome Rollers Rust Protection

Model #	Description	Cut Capacity	Extra Blade
48-22-4250	1/2" Mini Copper Tubing Cutter	1/8" – 5/8"	–
48-22-4258	3/4" Mini Copper Tubing Cutter	1/8" – 7/8"	–
48-22-4251	1" Mini Copper Tubing Cutter	1/8" – 1-1/8"	Yes
48-22-4256	2 Pc Replacement Cutter Wheels		–

CLOSE QUARTERS COPPER TUBING CUTTERS

**MOST COMPACT.
LONGEST LIFE.**



Chrome Rollers Rust Protection

Model #	Description
48-22-4260	1/2" Close Quarters Copper Tubing Cutter
48-22-4261	3/4" Close Quarters Copper Tubing Cutter
48-22-4262	1" Close Quarters Copper Tubing Cutter
48-22-4263	3 Pc Close Quarters Copper Tubing Cutter Set
48-22-4266	Replacement Copper Tubing Cutter Wheels

QUICK-ADJUST COPPER TUBING CUTTERS

**STRAIGHTER,
CLEANER CUTS**
4 CHROME ROLLERS



Adapt to Cut 3" PEX



Chrome Rollers Rust Protection

Model #	Description	Cut Capacity
48-22-4253	2-1/2" Quick-Adjust Copper Tubing Cutter	1/2" – 2-5/8"
48-22-4254	3-1/2" Quick-Adjust Copper Tubing Cutter	1/2" – 3-1/2"
48-22-4256	2 Pc Replacement Cutter Wheels	-
48-22-4206	Replacement PEX Cutter Wheel	-

CONSTANT SWING COPPER TUBING CUTTERS

**STRAIGHTER,
CLEANER CUTS**
4 CHROME ROLLERS

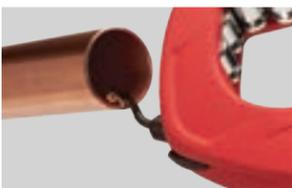

Built-In Reamer on 48-22-4252



Chrome Rollers Rust Protection

Model #	Description	Cut Capacity
48-22-4259	1" Constant Swing Copper Tubing Cutter	1/8" – 1-1/8"
48-22-4252	1-1/2" Constant Swing Copper Tubing Cutter	1/8" – 1-5/8"
48-22-4256	2 Pc Replacement Cutter Wheels	-
48-22-4257	3 Pc Replacement Reaming Blade	-

PUNCHDOWN TOOL

**BEST ACCESS
& VISIBILITY**



Extended Reach Punchdown Blade

Model #	Description	Blades Included
48-22-2165	Punchdown Tool w/ Extended Blade	66/110 Combination and Extended Reach 110
48-22-2166	Extended Punchdown Blade	Extended Reach 110
48-22-2167	Punchdown Blade	66/110 Combination

MINI FLUSH CUTTER

**CONSISTENT,
PRECISE CUTS**



Spring Assisted

Model #	Description
48-22-6105	Mini Flush Cutter

RATCHETING MODULAR CRIMPER

**CONSISTENT,
ACCURATE CRIMPS**



Parallel Crimping Design

Model #	Description
48-22-3075	Ratcheting Modular Crimper

MULTI-PICK TOOL

4in1



Wire Pick & Hook for Removing Errant Connections



Model #	Description
48-22-2145	Multi-Pick Tool

ELECTRICIAN SNIPS

**BLADES WON'T LOOSEN.
BOLT LOCK**



Wire Gullet Prevents Walking

Model #	Description
48-22-4045	Electrician Snips

UTP STRIPPER

**COMFORTABLE,
ONE HAND OPERATION**



Optimized Finger Loop

Model #	Description
48-22-3065	UTP Stripper

CONDUIT BENDERS

**HIGH CONTRAST
MARKINGS
BEST VISIBILITY**



Reinforced Multi-Position Foot Pedal

Model #	Description
48-22-4080	1/2" Iron Conduit Bender
48-22-4081	3/4" Iron Conduit Bender
48-22-4082	1" Iron Conduit Bender
48-22-4070	1/2" Aluminum Conduit Bender
48-22-4071	3/4" Aluminum Conduit Bender
48-22-4072	1" Aluminum Conduit Bender

FISH STICKS

**MOST DURABLE CONNECTIONS.
BRIGHTEST GLOW.**



Reinforced Threaded Connection Points



MET Part #	Description	Kit Includes
48-22-4149	5ft Low Flex Fish Stick	(1) 5' Low Flex Fish Stick, and Bullet Nose
48-22-4150	15ft Low Flex Fish Stick Kit	(3) 5' Low Flex Fish Sticks, Storage Tube, Bullet Nose and Hook
48-22-4151	5ft Mid Flex Fish Stick	(1) 5' Mid Flex Fish Stick, and Bullet Nose
48-22-4152	15ft Mid Flex Fish Stick Kit	(3) 5' Mid Flex Fish Sticks, Storage Tube, Bullet Nose and Hook
48-22-4153	5ft High Flex Fish Stick	(1) 5' High Flex Fish Stick, and Bullet Nose
48-22-4154	15ft High Flex Fish Stick Kit	(3) 5' High Flex Fish Sticks, Storage Tube, Bullet Nose and Hook

MET Part #	Description	Kit Includes
48-22-4160	25ft Fish Stick Combo Kit	(4) 5' Low Flex, (1) 5' Mid Flex Fish Sticks, (1) Storage Tube, Bullet Nose and Hook
48-22-4155	30ft Fish Stick Combo Kit	(4) 5' Low Flex, (1) 5' Mid Flex, (1) 5' High Flex Fish Sticks, (1) Storage Case, Bullet Nose, Hook, and Whisk
48-22-4156	60ft Fish Stick Combo Kit	(7) 5' Low Flex, (3) 5' Mid Flex, (2) 5' High Flex Fish Sticks, (1) Storage Case, Bullet Nose, Hook, Whisk, Magnet & Chain and Lighted Tip
48-22-4157	3 PC. Fish Stick Accessory Kit	(1) Whisk, Bullet Nose, and Hook
48-22-4158	Fish Stick Lighted Tip Accessory	(1) Lighted Tip Accessory
48-22-4159	Fish Stick Magnetic Tip and Chain Accessory	(1) Magnetic Tip and (1) Chain Accessory

POLYESTER FISH TAPES

**EASIEST FISHING.
MORE DURABLE TAPE.**



Also Available:

50ft Polyester Fish Tape w/ Nonconductive Tip
48-22-4162



Model #	Description
48-22-4192	50ft Polyester Fish Tape w/ Flexible Metal Leader
48-22-4195	100ft Polyester Fish Tape w/ Flexible Metal Leader
48-22-4197	200ft Polyester Fish Tape w/ Flexible Metal Leader
48-22-4162	50ft Polyester Fish Tape w/ Nonconductive Tip
48-22-4165	100ft Polyester Fish Tape w/ Nonconductive Tip
48-22-4167	200ft Polyester Fish Tape w/ Nonconductive Tip

STEEL FISH TAPES

**SMOOTH PAYOUT.
EASIER FISHING.**

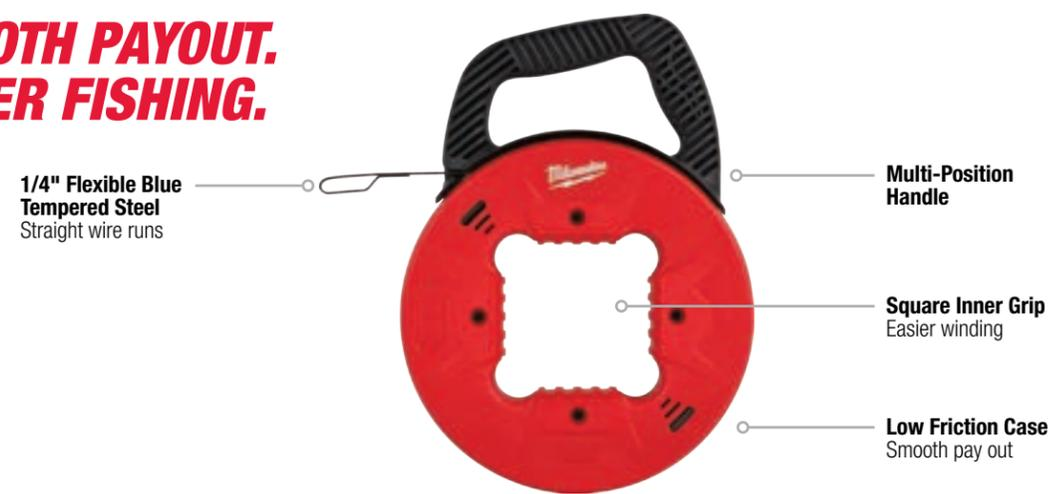

Model #	Description
48-22-4171	25ft 1/8" Steel Fish Tape
48-22-4172	50ft 1/8" Steel Fish Tape
48-22-4173	60ft 1/8" Steel Fish Tape
48-22-4176	120ft 1/8" Steel Fish Tape
48-22-4178	240ft 1/8" Steel Fish Tape
48-22-4181	25ft 1/4" Steel Fish Tape w/ Low Profile Tip
48-22-4185	100ft 1/4" Steel Fish Tape

PACKOUT™ MODULAR STORAGE SYSTEM

**MOST VERSATILE
DURABLE**
MODULAR STORAGE SYSTEM



**VIRTUALLY
BUILD YOUR SYSTEM**



or visit <https://qr.mke.tl/2zd46>



ROLLING TOOL BOX

250 LBS CAPACITY

IMPACT RESISTANT BODY

9" ALL-TERRAIN WHEELS

Industrial-Grade Extension Handle

Interior Organization Tray

Metal Reinforced Locking Point

Metal Reinforced Corners

IP65 Rated Protection

Modular Connectivity w/ All PACKOUT™ Components

9" All-Terrain Wheels

Model #	Description	Weight Capacity
48-22-8426	PACKOUT™ Rolling Tool Box	250 lbs

ROLLING TOOL CHEST

DUAL STACK TOP

250 LBS CAPACITY

9" ALL-TERRAIN WHEELS

Interior Storage Tray

Industrial-Grade Handle

Impact Resistant Body

Modular Connectivity with All PACKOUT™ Components

Locking Lid Support

Metal Reinforced Locking Points

Water & Debris Protection

Model #	Description	Weight Capacity
48-22-8428	PACKOUT™ Rolling Tool Chest	250 lbs

Fits Under Most Truck Beds

TOOL BOXES

IMPACT RESISTANT BODY

IP65 RATED PROTECTION

METAL-REINFORCED CORNERS

Also Available:

PACKOUT™ Tool Box
48-22-8424

Model #	Description	Weight Capacity
48-22-8424	PACKOUT™ Tool Box	75 lbs
48-22-8425	PACKOUT™ Large Tool Box	100 lbs
48-22-8429	PACKOUT™ XL Tool Box	100 lbs

Interior Organizer Trays

DRAWERS

50 LBS CAPACITY

LOCKING SECURITY BAR

IMPACT RESISTANT BODY

Locking Security Bar
Metal bar secures all drawers

50 lbs Weight Capacity

Modular Connectivity w/ All PACKOUT™ Components

Steel Ball Bearing Slides

Also Available:
PACKOUT™ 2-Drawer Toolbox
48-22-8442

Model #	Description	Model #	Description
48-22-8442	PACKOUT™ 2-Drawer Tool Box	48-22-8473	PACKOUT™ 3-Drawer Divider Kit
48-22-8443	PACKOUT™ 3-Drawer Tool Box	48-22-8452	Customizable Foam Insert for PACKOUT™ Drawer Tool Boxes
48-22-8450	PACKOUT™ Tool Case w/ Customizable Insert		
48-22-8472	PACKOUT™ 2-Drawer Divider Kit		

Quick Adjust Bin Dividers

COMPACT TOOL BOX

IMPACT RESISTANT BODY

IP65 RATED PROTECTION

QUICK-ADJUST DIVIDERS

IP65 Rated Protection

Interior Storage Tray

Impact Resistant Body

75 lbs Weight Capacity

Quick-Adjust Dividers

Modular Connectivity w/ All PACKOUT™ Components

Model #	Description	Weight Capacity
48-22-8422	PACKOUT™ Compact Tool Box	75 lbs

Interior Storage Tray

TOOL CASE WITH CUSTOMIZABLE INSERT

IMPACT RESISTANT BODY

IP65 RATED PROTECTION

CUSTOMIZE YOUR INSERT

Also Available:

PACKOUT™ Customizable Foam Insert
48-22-8451

Model #	Description	Weight Capacity
48-22-8450	PACKOUT™ Tool Case with Customizable Insert	75 lbs
48-22-8451	PACKOUT™ Customizable Foam Insert	—

Customizable Foam Insert

CRATE

STACK OR HANG

IMPACT RESISTANT BODY

50 LBS CAPACITY

50 lbs Weight Capacity

Stack or Hang

- Rear hanging points for vertical use
- Top attachment points for stacking

Modular Connectivity w/ All PACKOUT™ Components

Impact Resistant Polymer Construction

Model #	Description
48-22-8440	PACKOUT™ Crate

16QT COOLER

HOLDS ICE FOR 30 HRS

IMPACT RESISTANT BODY

IP65 RATED PROTECTION

IP65 Rated Protection

16 qt Capacity

Interior Storage Tray

Impact Resistant Body

Bottle Opener

Modular Connectivity w/ All PACKOUT™ Components

Model #	Description	Weight Capacity
48-22-8460	PACKOUT™ 16qt Compact Cooler	50 lbs

DEEP ORGANIZER

50 LBS CAPACITY

IP65 RATED PROTECTION

QUICK-ADJUST DIVIDERS

50 lb Weight Capacity

Quick-Adjust Dividers

4 Large Compartments

IP65 Rated Protection

Modular Connectivity with All PACKOUT™ Components

4 Small Compartments

50 lb Weight Capacity

Impact Resistant Polymer Body

Model #	Description	Compartments
48-22-8432	PACKOUT™ Deep Organizer	11

ORGANIZERS

IMPACT RESISTANT BODY

IP65 RATED PROTECTION

NO-TRAVEL BIN SEALS

Removable & Mountable Bins

Removable & Mountable Bins

Impact Resistant Polymer Base

Model #	Description
48-22-8430	PACKOUT™ Organizer
48-22-8435	PACKOUT™ Compact Organizer

LOW-PROFILE ORGANIZERS

IMPACT RESISTANT BODY

IP65 RATED PROTECTION

NO-TRAVEL BIN SEALS

6 Removable Bin Dividers

Removable Bins

Impact Resistant Polymer Base

Low-Profile Design

Model #	Description
48-22-8431	PACKOUT™ Low-Profile Organizer
48-22-8436	PACKOUT™ Low-Profile Compact Organizer

TOTES

TEAR-RESISTANT MATERIAL

IMPACT RESISTANT BASE

ALL-METAL HARDWARE

Durable Overmold Handle

Optimized Storage Capacity

All-Metal Hardware

Impact Resistant Polymer Base

Model #	Description	Tool Pockets
48-22-8310	PACKOUT™ 10" Tote	28
48-22-8315	PACKOUT™ 15" Tote	31
48-22-8320	PACKOUT™ 20" Tote	32

TOOL BAGS

TEAR-RESISTANT MATERIAL

IMPACT RESISTANT BASE

ALL-METAL HARDWARE

Versatile Carry
Cushioned shoulder strap, top handles, side handles

Also Available:

PACKOUT™ 15" Tool Bag
48-22-8321



Spacious Storage Compartment

Tear-Resistant 1680D Ballistic Material

Modular Connectivity w/ All PACKOUT™ Components

All-Metal Hardware

Impact Resistant Polymer Base

Model #	Description
48-22-8321	PACKOUT™ 15" Tool Bag
48-22-8322	PACKOUT™ 20" Tool Bag



COOLER

HOLDS ICE FOR 24 HRS

ALL-METAL HARDWARE

IMPACT RESISTANT BASE

Food-Grade Leak Proof Liner

All-Metal Hardware

No Sweat Exterior



Tape Measure Clip w/ Bottle Opener

Tear-Resistant Ballistic Material

Impact Resistant Polymer Base

Model #	Description
48-22-8302	PACKOUT™ Cooler



BACKPACK

TEAR-RESISTANT MATERIAL

IMPACT RESISTANT BASE

OPTIMIZED STORAGE CAPACITY

Load-Bearing Harness
■ Evenly distributes weight
■ Padded and breathable
■ Sternum strap

Tape Measure Clip

Modular Connectivity w/ All PACKOUT™ Components



Tear-Resistant 1680D Ballistic Material

Hardshell Protected Electronic & Equipment Pocket

Impact Resistant Polymer Base

Model #	Description	Tool Pockets
48-22-8301	PACKOUT™ Backpack	48



TECH BAG

TEAR-RESISTANT MATERIAL

IMPACT RESISTANT BASE

OPTIMIZED STORAGE CAPACITY

Padded Shoulder Strap

Tear-Resistant 1680D Ballistic Material

Protected Interior Laptop Pocket

Impact Resistant Polymer Base



All-Metal Hardware

Hardshell Protected Instrument Pocket

Fold Down Front Pocket

Modular Connectivity w/ All PACKOUT™ Components

Model #	Description	Tool Pockets
48-22-8300	PACKOUT™ Tech Bag	58



MOUNTING PLATE

WALL & FLOOR MOUNTING

50 LBS WALL MOUNTED CAPACITY

METAL-REINFORCED MOUNTING POINTS

100 lbs Floor Mounted Weight Capacity

50 lbs Wall Mounted Weight Capacity

Modular Connectivity w/ All PACKOUT™ Components

Metal Reinforced Tie-Down Points

Impact Resistant Polymer Construction

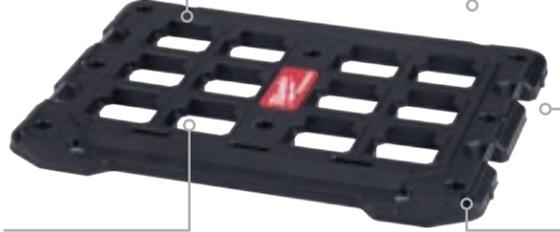

Metal-Reinforced Mounting Holes

Model #	Description
48-22-8485	PACKOUT™ Mounting Plate



DOLLY

- 250 LBS CAPACITY**
- QUICKSTOP LOADING LEVER**
- SMOOTH ROLL WHEELS**



QUICKSTOP™ Loading Lever

Model #	Description
48-22-8410	PACKOUT™ Dolly

RACKING SHELVES

- VERSATILE MOUNTING E-TRACK COMPATIBLE™**
- 50 LBS CAPACITY**
- METAL-REINFORCED FRAME**

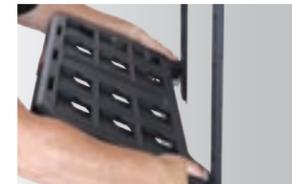

Quick Release Levers for Easy Repositioning

Also Available:



PACKOUT™ Racking Shelf
48-22-8481

Model #	Description
48-22-8480	PACKOUT™ Racking Kit
48-22-8481	PACKOUT™ Racking Shelf
48-22-8482	2 Pc 20" Vertical E-Track for PACKOUT™ Racking Shelves

2-WHEEL CART

- STACK OR HANG**
- 400 LBS CAPACITY**
- 10" FLAT-FREE WHEELS**



Stack or Hang

Model #	Description	Weight Capacity
48-22-8415	PACKOUT™ 2-Wheel Cart	400 lbs

CUSTOMIZABLE WORK TOP

- FASTENER-READY MOUNTING SURFACE**
- 50 LBS CAPACITY**
- IMPACT RESISTANT BODY**



Fastener-Ready Mounting Surface

Model #	Description	Weight Capacity
48-22-8488	PACKOUT™ Customizable Work Top	50 lbs

JOBSITE TECH BAG

UP TO **5X MORE DURABLE**

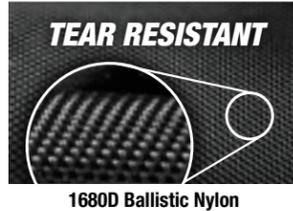

Model #	Description
48-22-8210	Jobsite Tech Bag

HARDTOP™ ROLLING BAGS

MOST DURABLE. ULTIMATE VERSATILITY.

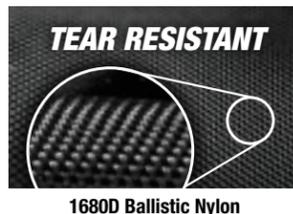

Model #	Description
48-22-8221	18" Rolling Bag
48-22-8220	24" HARDTOP™ Rolling Bag

JOBSITE COOLER

HOLDS ICE UP TO **24HRS**



Model #	Description
48-22-8250	Jobsite Cooler

LOW-PROFILE BACKPACK

DURABLE, LOW-PROFILE DESIGN

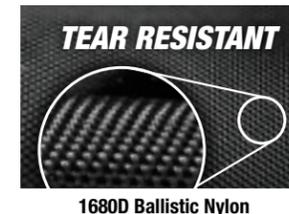

Model #	Description	Pockets
48-22-8202	Low-Profile Backpack	22

JOBSITE BACKPACK

UP TO **5X MORE DURABLE**



Impact-Resistant Base

Model #	Description	Pockets
48-22-8200	Jobsite Backpack	35

ULTIMATE JOBSITE BACKPACK

**ULTIMATE DURABILITY,
PROTECTION, & STORAGE**



Impact-Resistant Base

Model #	Description	Pockets
48-22-8201	Ultimate Jobsite Backpack	48

PARACHUTE ORGANIZER BAG

**FASTEST ACCESS,
BEST CONSTRUCTION**



Stand-Up & Stay-Open Design

Model #	Description
48-22-8170	Parachute Organizer Bag

BUCKET ORGANIZER WRAP

**MOST VERSATILE
BUCKET ORGANIZER**



Exterior Zipper Pockets

Model #	Description
48-22-8175	Bucket Organizer Wrap

ZIPPER POUCHES

UP TO **2X MORE DURABLE**



Also Available:



3 Pc Multi-Size Zipper Pouches
48-22-8183

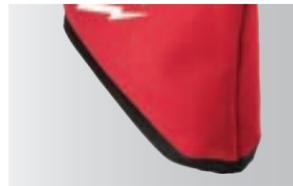

Water Resistant Stand-Up Base

Model #	Description
48-22-8180	Zipper Pouch
48-22-8193	3 Pc Zipper Pouches
48-22-8183	3 Pc Multi-Size Zipper Pouches

JOBSITE ORGANIZER

**MOST VERSATILE
JOBSITE ORGANIZER**



No-Travel Bin Seals

Model #	Description
48-22-8030	20" Jobsite Organizer

WORK BELTS & POUCHES

UP TO **5X LONGER LIFE**

Contractor's Work Belt w/ Suspension Rig
48-22-8120



Electrician's Work Belt
48-22-8110

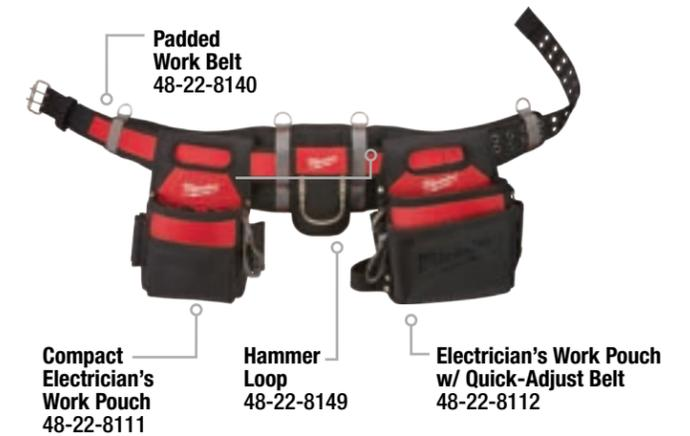

Model #	Description
48-22-8100	Electrician's Work Belt w/ Quick-Adjust Belt
48-22-8110	Electrician's Work Belt
48-22-8111	Compact Electrician's Work Pouch
48-22-8120	Contractor's Work Belt w/ Suspension Rig
48-22-8121	Carpenter's Work Pouch
48-22-8122	3-Tier Material Work Pouch

Model #	Description
48-22-8140	Padded Work Belt
48-22-8145	Padded Rig
48-22-8146	XL Padded Rig
48-22-8149	Hammer Loop
48-22-8112	Electrician's Work Pouch w/ Quick-Adjust Belt

COMPACT UTILITY POUCH

UP TO **5X LONGER LIFE**



Quick-Attach Belt Loop

Model #	Description
48-22-8118	Compact Utility Pouch

UTILITY POUCH



Quick-Attach Belt Loop

Model #	Description
48-22-8119	Utility Pouch

LINEMAN'S AERIAL TOOL APRON

**EASY ORGANIZATION.
LASTING DURABILITY.**

25 POCKETS



Also Available:



- 2" Bucket Hook
48-22-8292
- 3" Bucket Hook
48-22-8293



Dedicated Flood Light Pocket

Model #	Description
48-22-8290	Lineman's Aerial Tool Apron

LINEMAN'S COMPACT AERIAL TOOL APRON

**EASY ORGANIZATION.
LASTING DURABILITY.**

18 POCKETS



Reinforced Auger Holder
Won't burn through

Model #	Description
48-22-8291	Lineman's Compact Aerial Tool Apron

UNDERGROUND OVAL BAG

UP TO 5X LONGER LIFE



Puncture Resistant Pockets

Model #	Description
48-22-8275	Underground Oval Bag

AERIAL OVAL BAG

UP TO 5X LONGER LIFE



Puncture Resistant Pockets

Model #	Description
48-22-8276	Aerial Oval Bag



POWER UTILITY STORAGE

STAY SAFE. STAY PRODUCTIVE.



CANVAS UTILITY BUCKET w/ POCKETS

EASIEST ATTACHMENT. LASTING DURABILITY.



Double Layered Canvas Construction

Model #	Description
48-22-8270	Canvas Utility Bucket w/ Pockets

CANVAS UTILITY BUCKET

EASIEST ATTACHMENT. LASTING DURABILITY.



Large Swiveling Metal Carabiner

Model #	Description
48-22-8271	Canvas Utility Bucket



MILWAUKEE® has taken the time to understand users' needs and develop personal protective equipment from the ground up, delivering hard hats that allow users to adapt to each job and safety glasses that can be worn all day with lasting, fog-free lenses. MILWAUKEE® is focused on creating innovative PPE solutions that won't slow users down, helping them STAY SAFE. STAY PRODUCTIVE.™

LEARN MORE



or visit <https://qr.mke.tl/276hq>

BOLT™ ACCESSORIES

SAFETY HELMETS

**BETTER PROTECTION
MORE COMFORT**

ANSI/ISEA Z89.1
TYPE I, TYPE II, CLASS C

ANSI/ISEA Z89.1
TYPE I, TYPE II, CLASS E

BOLT™ Headlamp Mount

- Securely holds MILWAUKEE® and most other professional brand headlamps
- Mounts to front or back



CUSTOMIZATION AVAILABLE

See page 85 for details



Moisture Wicking Sweatband and Helmet Liner

Removable and Machine Washable

5 Adjustable Chin Strap Buckles
Comfortable fit



Adjustable Swinging Ratchet
Better comfort

Also Available:



White Front Brim Safety Helmet - Type 2, Class E
48-73-1321

No Brim		
Model #	Color	Description
48-73-1300	White	White Vented Safety Helmet – Type II, Class C
48-73-1302	Yellow	Yellow Vented Safety Helmet – Type II, Class C
48-73-1304	Blue	Blue Vented Safety Helmet – Type II, Class C
48-73-1306	Green	Green Vented Safety Helmet – Type II, Class C
48-73-1308	Red	Red Vented Safety Helmet – Type II, Class C
48-73-1310	Black	Black Vented Safety Helmet – Type II, Class C
48-73-1312	Orange	Orange Vented Safety Helmet – Type II, Class C

Front Brim		
Model #	Color	Description
48-73-1320	White	White Front Brim Vented Safety Helmet – Type II, Class C
48-73-1322	Yellow	Yellow Front Brim Vented Safety Helmet – Type II, Class C
48-73-1324	Blue	Blue Front Brim Vented Safety Helmet – Type II, Class C
48-73-1326	Green	Green Front Brim Vented Safety Helmet – Type II, Class C
48-73-1328	Red	Red Front Brim Vented Safety Helmet – Type II, Class C
48-73-1330	Black	Black Front Brim Vented Safety Helmet – Type II, Class C
48-73-1332	Orange	Orange Front Brim Vented Safety Helmet – Type II, Class C

BOLT™ ACCESSORIES

HARD HATS

**ADAPT TO
YOUR JOBSITE**

ANSI/ISEA Z89.1
CSA Z94.1
TYPE I CLASS C

ANSI/ISEA Z89.1
CSA Z94.1
TYPE I CLASS E

Temperature Reducing Vents

On vented hard hats only

BOLT™ Headlamp Mount

- Securely holds MILWAUKEE® and most other professional brand headlamps
- Mounts to front or back



CUSTOMIZATION AVAILABLE

See page 85 for details

Also Available:



Front Brim Hard Hat
48-73-1020



Quick-Adjust Ratcheting Suspension

Large Logo	Small Logo	No Logo	Description
48-73-1000	48-73-1001	–	Front Brim Vented Hard Hat w/ 4pt Ratcheting Suspension – Type I Class C
48-73-1010	48-73-1011	–	Full Brim Vented Hard Hat w/ 4pt Ratcheting Suspension – Type I Class C
48-73-1020	48-73-1021	–	Front Brim Hard Hat w/ 4pt Ratcheting Suspension – Type I Class E
48-73-1030	48-73-1031	–	Full Brim Hard Hat w/ 4pt Ratcheting Suspension – Type I Class E
48-73-1080	–	–	Hard Hat Sweat Band
48-73-1082	–	–	Hard Hat Chin Strap
48-73-1085	–	–	BOLT™ Hard Hat Marker Clip
48-73-1090	–	–	BOLT™ Hard Hat Headlamp Mount
48-73-1095	–	–	4-Point Ratchet Suspension Replacement
2111-21	–	2111-21	USB Rechargeable Hard Hat Headlamp Kit
2103	–	2103	Headlamp

SURVEYOR'S SAFETY VESTS

**MAXIMUM DURABILITY
CARRY MORE**

27 POCKETS

- External:**
- 1 Clear ID Holder
 - 2 Chest Pockets
 - 4 Reinforced Pen Pockets
 - 2 Hearing Protection Pockets
 - 1 Tablet Pocket
 - 2 Stake/Ruler Pockets
 - 2 Water Bottle Pockets
 - 2 Reinforced Barrel Pockets
 - 2 Front Zippered Pockets
 - 2 Mic Tabs
- Internal:**
- 3 Pen Pockets
 - 1 Chest Pocket
 - 1 Water Resistant Pocket
 - 2 Barrel Pockets

ANSI/ISEA 107-15
TYPE R CLASS 2



Comfortable Padded Collar

Tear Resistant Construction Woven 600D

Internal Size Adjustment

Fall Protection Pass Through

Anti-Microbial Prevent odor & bacteria

Moisture Wicking Stay cool, dry fast

Rear Zippered Tablet Pocket



Tear Resistant Construction

Class 2			
Size	Yellow – ANSI	Orange – ANSI	
S/M	48-73-5161	48-73-5165	
L/XL	48-73-5162	48-73-5166	
2XL/3XL	48-73-5163	48-73-5167	
4XL/5XL	48-73-5164	48-73-5168	

CUSTOMIZATION AVAILABLE

See page 85 for details

PERFORMANCE SAFETY VESTS

**CARRY MORE
REINFORCED POCKETS**

15 POCKETS

- External:**
- 1 Mic Tabs
 - 1 Clear ID Holder
 - 2 Chest Pockets
 - 4 Reinforced Pen Pockets
 - 2 Reinforced Barrel Pockets
 - 1 Tablet Pocket
- Internal:**
- 1 Chest Pocket
 - 2 Barrel Pockets

ANSI/ISEA 107-15
TYPE R CLASS 2



Comfortable Padded Collar

Tear Resistant Construction Woven 600D

Internal Size Adjustment

Fall Protection Pass Through

Secure Zippered Closure

Rear Zippered Tablet Pocket



Reinforced Pockets and Edges

Class 2				
Size	Yellow – ANSI	Orange – ANSI	Yellow – ANSI/CSA	Orange – ANSI/CSA
S/M	48-73-5041	48-73-5051	48-73-5081	48-73-5091
L/XL	48-73-5042	48-73-5052	48-73-5082	48-73-5092
2XL/3XL	48-73-5043	48-73-5053	48-73-5083	48-73-5093
4XL/5XL	48-73-5044	48-73-5054	48-73-5084	48-73-5094

SAFETY VESTS

CARRY MORE 10 POCKETS

- External:**
- 1 Clear ID Holder
 - 2 Chest Pockets
 - 4 Reinforced Pen Pockets
 - 2 Mic Tabs
- Internal:**
- 1 Chest Pocket

ANSI/ISEA 107-15

TYPE R CLASS 2

ANSI/ISEA 107-15

TYPE R CLASS 2

CUSTOMIZATION AVAILABLE
See page 85 for details

Also Available:
ANSI/CSA Safety Vests



Quickly Adjust Size
Better Fit

Class 2				
Size	Yellow - ANSI	Yellow - ANSI	Yellow - ANSI/CSA	Orange - ANSI/CSA
S/M	48-73-5021	48-73-5031	48-73-5061	48-73-5071
L/XL	48-73-5022	48-73-5032	48-73-5062	48-73-5072
2XL/3XL	48-73-5023	48-73-5033	48-73-5063	48-73-5073
4XL/5XL	48-73-5024	48-73-5034	48-73-0164	48-73-5074

Class 3		
Size	Yellow - ANSI	Orange - ANSI
S/M	48-73-5141	48-73-5145
L/XL	48-73-5142	48-73-5146
2XL/3XL	48-73-5143	48-73-5147
4XL/5XL	48-73-5144	48-73-5148

MESH SAFETY VESTS

STAY COOL ANTI ODOR

9 POCKETS

- External:**
- 1 Clear ID Holder
 - 2 Chest Pockets
 - 3 Reinforced Pen Pockets
 - 2 Mic Tabs
- Internal:**
- 1 Chest Pocket

ANSI/ISEA 107-15

TYPE R CLASS 2

ANSI/ISEA 107-15

TYPE R CLASS 2

CUSTOMIZATION AVAILABLE
See page 85 for details

Also Available:
ANSI/CSA Breakaway Mesh Safety Vest



Moisture Wicking
Stay Cool, Dry Fast

Class 2 - Mesh		
Size	Yellow - ANSI	Orange - ANSI
S/M	48-73-5111	48-73-5115
L/XL	48-73-5112	48-73-5116
2XL/3XL	48-73-5113	48-73-5117
4XL/5XL	48-73-5114	48-73-5118

Class 3 - Mesh		
Size	Yellow - ANSI	Orange - ANSI
S/M	48-73-5131	48-73-5135
L/XL	48-73-5132	48-73-5136
2XL/3XL	48-73-5133	48-73-5137
4XL/5XL	48-73-5134	48-73-5138

Class 2 - Breakaway Mesh				
Size	Yellow - ANSI	Orange - ANSI	Yellow - ANSI/CSA	Orange - ANSI/CSA
S/M	48-73-5121	48-73-5125	48-73-5171	48-73-5175
L/XL	48-73-5122	48-73-5126	48-73-5172	48-73-5176
2XL/3XL	48-73-5123	48-73-5127	48-73-5173	48-73-5177
4XL/5XL	48-73-5124	48-73-5128	48-73-5174	48-73-5178

PERFORMANCE SAFETY GLASSES w/ GASKET

ADVANCED PROTECTION. ULTIMATE PERFORMANCE.

Case Included

ANSI **Z87.1+** CSA **Z94.3** MIL-PRF-32432
BALLISTIC IMPACT
FRAGMENTATION - CLASS 1

Removable Gasket
Protects against debris

AVAILABLE LENSES

Lens Color	Packaging Style - Blister Card	Packaging Style - Bag
Polarized	48-73-2045	48-73-2046
Clear	48-73-2040	48-73-2041

PERFORMANCE SAFETY GLASSES w/ GASKET

HIGH IMPACT FOG-FREE LENSES

ANSI **Z87.1+** CSA **Z94.3** MIL-PRF-32432
BALLISTIC IMPACT
FRAGMENTATION - CLASS 1

Removable Gasket
Protects against debris

AVAILABLE LENSES

Lens Color	Packaging Style - Blister Card	Packaging Style - Bag
Clear	48-73-2020	48-73-2021
Yellow	48-73-2120	48-73-2121
Gray	48-73-2125	48-73-2126
Tinted	48-73-2025	48-73-2026

SAFETY GLASSES - FOG FREE LENSES

FOG-FREE ALL DAY COMFORT

ANSI Z87.1+ CSA Z94.3



AVAILABLE LENSES

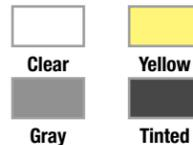

Flexible Nose Bridge

Lens Color	Packaging Style – Blister Card	Packaging Style – Bag
Clear	48-73-2012	48-73-2013
Yellow	48-73-2102	48-73-2103

Lens Color	Packaging Style – Blister Card	Packaging Style – Bag
Gray	48-73-2107	48-73-2108
Tinted	48-73-2018	48-73-2020

SAFETY GLASSES - ANTI-SCRATCH LENSES

ANTI-SCRATCH ALL DAY COMFORT

ANSI Z87.1+ CSA Z94.3



AVAILABLE LENSES

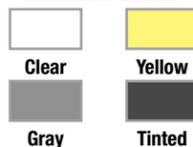

Magnified Clear
+1.0 – +3.0
(0.5 increments)



Anti-Scratch Hard Coat Protects Lenses

Lens Color	Packaging Style – Blister Card	Packaging Style – Bag
Clear	48-73-2010	48-73-2011
Yellow	48-73-2100	48-73-2101
Gray	48-73-2105	48-73-2106
Tinted	48-73-2015	48-73-2016

Lens Color	Packaging Style – Blister Card	Packaging Style – Bag
+1.0 Magnified Clear	48-73-2200	48-73-2201
+1.5 Magnified Clear	48-73-2202	48-73-2203
+2.0 Magnified Clear	48-73-2204	48-73-2205
+2.5 Magnified Clear	48-73-2206	48-73-2207
+3.0 Magnified Clear	48-73-2208	48-73-2209

MILWAUKEE® enables you to add logos or taglines to your hard hat and safety vest. The order process makes it easy to customize your PPE with long lasting prints.

HEAD PROTECTION CUSTOMIZATION

Hard Hat Logo Placement

Up to 4 locations



Hard Hat	Logo Size
Front/Back	2.5" W x 2" H
Sides	2.5" W x 2" H

PRINT UP TO 4 COLORS

SAFETY VEST CUSTOMIZATION

Safety Vest Logo Placement

Up to 2 locations



Safety Vest – ANSI	Logo Size
Left Pocket	3" W x 2.5" H
Back	9" W x 9" H
Performance Safety Vest – ANSI	Logo Size
Left Pocket	3" W x 2.5" H
Back	10" W x 6" H
Safety Vest – ANSI/CSA	Logo Size
Left Pocket	3" W x 2.5" H
Lower Back	15" W x 6" H
Performance Safety Vest – ANSI/CSA	Logo Size
Left Pocket	3" W x 2" H
Lower Back	15" W x 6" H

PRINT UP TO 2 COLORS

HOW TO SUBMIT ORDER

1. Place order through Sales Representative, Customer Experience, or MILWAUKEE® Connect
2. Once order is placed, an email will be sent with a link to the logo upload process
3. You will then receive an email with a link to review and approve a proof

LEAD TIME

- Artwork Proof will be sent within 1 business day after finishing the logo upload process
- Order will be fulfilled within 14 – 21 days from proof approval

ORDER MINIMUMS

- Hard Hats: Minimum order quantity of 36, must add in increments of 18
- Safety Vests: Minimum order quantity of 36, must add in increments of 36

MORE INFORMATION

- Email CXCustomSafety@milwaukeetool.com with questions

Once artwork is approved by the customer, the order cannot be canceled. Lead times are based on artwork approval date, not order date. If customer fails to approve artwork, order may be delayed. Orders placed with a mismatch on number of colors, locations, or logos will need to have the artwork updated or the order re-entered. Images may have some distortion on curved surfaces – the printer can accommodate for some, but it may not turn out the same as the flat image.

N95 VALVED RESPIRATORS



**STAY COOL
BETTER FIT**



Also Available:



N95 Valved Respirator
48-73-4011

N95 VALVED RESPIRATOR w/ GASKET

Model #	Description
48-73-4001	N95 Valved Respirator w/ Gasket
48-73-4002	3 Pk N95 Valved Respirator w/ Gasket
48-73-4004	10 Pk N95 Valved Respirator w/ Gasket

N95 VALVED RESPIRATOR

Model #	Description
48-73-4011	N95 Valved Respirator
48-73-4012	3 Pk N95 Valved Respirator
48-73-4014	10 Pk N95 Valved Respirator

BANDED EAR PLUGS

**ALL DAY COMFORT
VERSATILE WEAR**



Low Profile Band

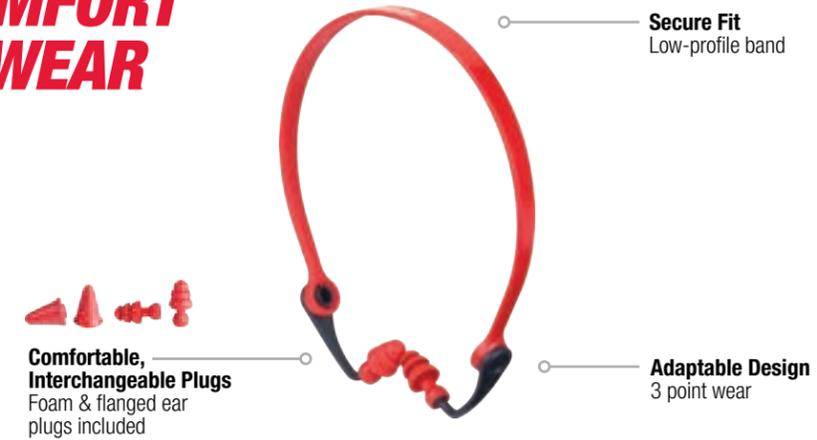

Model #	Description
48-73-3201	Banded Ear Plugs
48-73-3205	5 Pairs Replaceable Banded Flanged Ear Plugs
48-73-3206	5 Pairs Replaceable Banded Foam Ear Plugs

REUSABLE CORDED EAR PLUGS

ALL DAY COMFORT



Quick Fit Design



Model #	Description
48-73-3151	3 Pk Reusable Corded Ear Plugs

EAR PLUGS

ALL DAY COMFORT



Expands to Fit a Variety of Sizes



Model #	Description
48-73-3001	10 Pair Ear Plugs
48-73-3005	100 Pair Ear Plugs
48-73-3006	100 Pair Ear Plugs (Individually Wrapped)

DEMOLITION GLOVES

UP TO **5X LONGER LIFE**



Model #	Description
48-22-8735	Demolition Gloves S
48-22-8731	Demolition Gloves M
48-22-8732	Demolition Gloves L

Model #	Description
48-22-8733	Demolition Gloves XL
48-22-8734	Demolition Gloves XXL

PERFORMANCE GLOVES

ULTIMATE DURABILITY. ALL DAY COMFORT.



Model #	Description
48-22-8725	Performance Gloves S
48-22-8721	Performance Gloves M
48-22-8722	Performance Gloves L
48-22-8723	Performance Gloves XL
48-22-8724	Performance Gloves XXL

Model #	Description
48-22-8745	Performance Fingerless Gloves S
48-22-8741	Performance Fingerless Gloves M
48-22-8742	Performance Fingerless Gloves L
48-22-8743	Performance Fingerless Gloves XL
48-22-8744	Performance Fingerless Gloves XXL

FREE-FLEX GLOVES

ULTIMATE DURABILITY. ALL DAY COMFORT.



Model #	Description
48-22-8715	Free-Flex Gloves S
48-22-8711	Free-Flex Gloves M
48-22-8712	Free-Flex Gloves L

Model #	Description
48-22-8713	Free-Flex Gloves XL
48-22-8714	Free-Flex Gloves XXL

GOATSKIN LEATHER GLOVES

COMFORTABLE LEATHER. REINFORCED PALM.



Size	1 Pair	12 Pair (Contractor Pack)
S	48-73-0010	48-73-0010B
M	48-73-0011	48-73-0011B
L	48-73-0012	48-73-0012B

Size	1 Pair	12 Pair (Contractor Pack)
XL	48-73-0013	48-73-0013B
XXL	48-73-0014	48-73-0014B

IMPACT DEMOLITION GLOVES

IMPACT PROTECTION. REINFORCED DURABILITY.



Size	1 Pair	12 Pair (Contractor Pack)
S	48-22-8750	48-22-8750B
M	48-22-8751	48-22-8751B
L	48-22-8752	48-22-8752B

Size	1 Pair	12 Pair (Contractor Pack)
XL	48-22-8753	48-22-8753B
XXL	48-22-8754	48-22-8754B

WINTER DEMOLITION GLOVES

ALL DAY WARMTH. REINFORCED DURABILITY.



Size	1 Pair	12 Pair (Contractor Pack)
S	48-73-0040	48-73-0040B
M	48-73-0041	48-73-0041B
L	48-73-0042	48-73-0042B

Size	1 Pair	12 Pair (Contractor Pack)
XL	48-73-0043	48-73-0043B
XXL	48-73-0044	48-73-0044B

WINTER PERFORMANCE GLOVES

ALL DAY WARMTH.



Durable Reinforced Palm and Fingertips

Size	1 Pair	12 Pair (Contractor Pack)
S	48-73-0030	48-73-0030B
M	48-73-0031	48-73-0031B
L	48-73-0032	48-73-0032B

Size	1 Pair	12 Pair (Contractor Pack)
XL	48-73-0033	48-73-0033B
XXL	48-73-0034	48-73-0034B

CUT LEVEL 1 WINTER DIPPED GLOVES

ULTIMATE WARMTH. ALL DAY COMFORT.

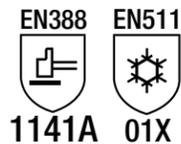

Size	1 Pair	12 Pair (Contractor Pack)
S	48-22-8910	48-22-8910B
M	48-22-8911	48-22-8911B
L	48-22-8912	48-22-8912B

Size	1 Pair	12 Pair (Contractor Pack)
XL	48-22-8913	48-22-8913B
XXL	48-22-8914	48-22-8914B

CUT LEVEL 3 WINTER DIPPED GLOVES

ULTIMATE WARMTH. ALL DAY COMFORT.

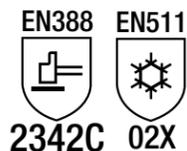

Size	1 Pair	12 Pair (Contractor Pack)
S	48-22-8920	48-22-8920B
M	48-22-8921	48-22-8921B
L	48-22-8922	48-22-8922B

Size	1 Pair	12 Pair (Contractor Pack)
XL	48-22-8923	48-22-8923B
XXL	48-22-8924	48-22-8924B

CUT LEVEL 1 NITRILE DIPPED GLOVES

ULTIMATE DURABILITY. ALL DAY COMFORT.

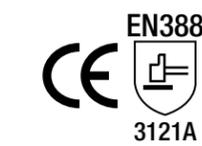

Size	1 Pair	12 Pair (Contractor Pack)
S	48-22-8900	48-22-8900B
M	48-22-8901	48-22-8901B
L	48-22-8902	48-22-8902B
XL	48-22-8903	48-22-8903B

Size	1 Pair	12 Pair (Contractor Pack)
XXL	48-22-8904	48-22-8904B

CUT LEVEL 3 NITRILE DIPPED GLOVES

ULTIMATE DURABILITY. ALL DAY COMFORT.



Size	1 Pair	12 Pair (Contractor Pack)
S	48-22-8930	48-22-8930B
M	48-22-8931	48-22-8931B
L	48-22-8932	48-22-8932B

Size	1 Pair	12 Pair (Contractor Pack)
XL	48-22-8933	48-22-8933B
XXL	48-22-8934	48-22-8934B

CUT LEVEL 5 NITRILE DIPPED GLOVES

ULTIMATE DURABILITY. ALL DAY COMFORT.



Size	1 Pair	12 Pair (Contractor Pack)
S	48-22-8950	48-22-8950B
M	48-22-8951	48-22-8951B
L	48-22-8952	48-22-8952B

Size	1 Pair	12 Pair (Contractor Pack)
XL	48-22-8953	48-22-8953B
XXL	48-22-8954	48-22-8954B

HIGH VISIBILITY CUT LEVEL 2 POLYURETHANE DIPPED GLOVES

**BETTER FIT.
BETTER PROTECTION.**



- 15 Gauge for Better Dexterity
- Reinforced Nitrile Coating
- High Performance Added protection
- Polyurethane Better fit
- SMARTSWIPE™ Touch Screen Compatible Fingertips & Palms
- Light and Breathable Back
- Color-Coded Bands Easy cut rating identification



Size	1 Pair	12 Pair (Contractor Pack)
S	48-73-8920	48-73-8920B
M	48-73-8921	48-73-8921B
L	48-73-8922	48-73-8922B

Size	1 Pair	12 Pair (Contractor Pack)
XL	48-73-8923	48-73-8923B
XXL	48-73-8924	48-73-8924B

HIGH VISIBILITY CUT LEVEL 3 POLYURETHANE DIPPED GLOVES

**BETTER FIT.
BETTER PROTECTION.**



- 15 Gauge for Better Dexterity
- Reinforced Nitrile Coating
- High Performance Added protection
- Polyurethane Better fit
- SMARTSWIPE™ Touch Screen Compatible Fingertips & Palms
- Light and Breathable Back
- Color-Coded Bands Easy cut rating identification



Size	1 Pair	12 Pair (Contractor Pack)
S	48-73-8930	48-73-8930B
M	48-73-8931	48-73-8931B
L	48-73-8932	48-73-8932B

Size	1 Pair	12 Pair (Contractor Pack)
XL	48-73-8933	48-73-8933B
XXL	48-73-8934	48-73-8934B

HIGH VISIBILITY CUT LEVEL 4 POLYURETHANE DIPPED GLOVES

**BETTER FIT.
BETTER PROTECTION.**

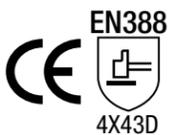

- 15 Gauge for Better Dexterity
- Reinforced Nitrile Coating
- High Performance Added protection
- Polyurethane Better fit
- SMARTSWIPE™ Touch Screen Compatible Fingertips & Palms
- Light and Breathable Back
- Color-Coded Bands Easy cut rating identification



Size	1 Pair	12 Pair (Contractor Pack)
S	48-73-8940	48-73-8940B
M	48-73-8941	48-73-8941B
L	48-73-8942	48-73-8942B

Size	1 Pair	12 Pair (Contractor Pack)
XL	48-73-8943	48-73-8943B
XXL	48-73-8944	48-73-8944B

LEATHER PERFORMANCE GLOVES

**DURABLE PALM.
LIGHTWEIGHT DESIGN.**



Secure Loop & Closure

- Reinforced Leather Palm Longer life
- Terry Cloth Sweat Wipe
- Soft Top Grain Goatskin Leather



- SMARTSWIPE™ Touch Screen Compatible Fingertips & Knuckles
- Breathable Back
- Secure Hook & Loop Closure

Size	1 Pair	12 Pair (Contractor Pack)
S	48-73-0020	48-73-0020B
M	48-73-0021	48-73-0021B
L	48-73-0022	48-73-0022B

Size	1 Pair	12 Pair (Contractor Pack)
XL	48-73-0023	48-73-0023B
XXL	48-73-0024	48-73-0024B

IMPACT CUT LEVEL 3 GOATSKIN LEATHER GLOVES

**IMPACT PROTECTION.
COMFORTABLE LEATHER.**



- Reinforced Palm Lasts longer
- Keystone Thumb Added mobility



- Impact Rated Enhanced TPR
- Soft Top Grain Goatskin Leather

Size	1 Pair	12 Pair (Contractor Pack)
S	48-22-8770	48-22-8770B
M	48-22-8771	48-22-8771B
L	48-22-8772	48-22-8772B

Size	1 Pair	12 Pair (Contractor Pack)
XL	48-22-8773	48-22-8773B
XXL	48-22-8774	48-22-8774B

IMPACT CUT LEVEL 5 GOATSKIN LEATHER GLOVES

**IMPACT PROTECTION.
COMFORTABLE LEATHER.**



- Soft Top Grain Goatskin Leather
- Gunn Cut Added comfort
- Reinforced Palm Lasts longer



- Impact Rated Enhanced TPR
- Keystone Thumb Added mobility

Size	1 Pair	12 Pair (Contractor Pack)
S	48-22-8780	48-22-8780B
M	48-22-8781	48-22-8781B
L	48-22-8782	48-22-8782B
XL	48-22-8783	48-22-8783B

Size	1 Pair	12 Pair (Contractor Pack)
XXL	48-22-8784	48-22-8784B

IMPACT CUT LEVEL 3 NITRILE DIPPED GLOVES

**IMPACT PROTECTION.
HIGH DEXTERITY.**



Size	1 Pair	12 Pair (Contractor Pack)
S	48-22-8970	48-22-8970B
M	48-22-8971	48-22-8971B
L	48-22-8972	48-22-8972B



Size	1 Pair	12 Pair (Contractor Pack)
XL	48-22-8973	48-22-8973B
XXL	48-22-8974	48-22-8974B

IMPACT CUT LEVEL 5 NITRILE DIPPED GLOVES

**IMPACT PROTECTION.
HIGH DEXTERITY.**



Size	1 Pair	12 Pair (Contractor Pack)
S	48-73-8980	48-73-8980B
M	48-73-8981	48-73-8981B
L	48-73-8982	48-73-8982B



Size	1 Pair	12 Pair (Contractor Pack)
XL	48-73-8983	48-73-8983B
XXL	48-73-8984	48-73-8984B



Nitrile Coated
Better Grip



SMARTSWIPE™ Touchscreen
Compatible Fingertips



Color Coded Bands
Easy Cut Rating Identification

FREE-FLEX

**LIGHTWEIGHT
COMFORT**



Water Resistant Cap

Model #	Description
48-73-6000	Free-Flex Knee Pads

HARD CAP GEL

**SECURE GEL ZONE.
BETTER COMFORT.**



2 Secure Adjustable Buckles

Model #	Description
48-73-6010	Hard Cap Gel Knee Pads

PERFORMANCE

**MAXIMUM COMFORT.
LONGEST LASTING.**

Robust Durable Cap

1680D Ballistic Nylon

Also Available:
Non-Marring Performance Knee Pads
48-73-6040

Model #	Description
48-73-6030	Performance Knee Pads
48-73-6040	Non-Marring Performance Knee Pads

STABILIZER PERFORMANCE

**MOST SECURE.
MAXIMUM COMFORT.**

Large Flat Cap
Increased stability

Hinged Thigh Strap
Better mobility

1680D Ballistic Nylon

Model #	Description
48-73-6050	Stabilizer Performance Knee Pads

Large Flat Cap for Increase Stability

LOCKING TOOL LANYARDS

**BEST SHOCK
ABSORPTION**

ANSI/ISEA
121-18

Integrated Swivel

Color Coded
Easy weight identification

Individualized Serial Numbers
Inventory management

Double-Locking Carabiner



Tether Tools When Working at Height

Part #	Weight Rating	Description
48-22-8810	10 lbs	10 lbs Locking Tool Lanyard
48-22-8811	10 lbs	10 lbs 54" Extended Reach Locking Tool Lanyard
48-22-8812	10 lbs	10 lbs 72" Extended Reach Locking Tool Lanyard
48-22-8815	15 lbs	15 lbs Locking Tool Lanyard
48-22-8816	15 lbs	15 lbs 54" Extended Reach Locking Tool Lanyard
48-22-8817	15 lbs	15 lbs 72" Extended Reach Locking Tool Lanyard
48-22-8850	35 lbs	35 lbs Locking Tool Lanyard

QUICK-CONNECT LOCKING TOOL LANYARD SYSTEM

**BEST SHOCK
ABSORPTION**

ANSI/ISEA
121-18

Integrated Swivel

Double-Locking Carabiner

Color Coded
Easy weight identification

Individualized Serial Numbers
Inventory management



Quick Tool Change Out

Part #	Weight Rating	Description
48-22-8820	10 lbs	10 lbs Quick-Connect Locking Tool Lanyard
48-22-8822	5 lbs	3 Pc 5 lbs Quick-Connect Lanyard Accessory
48-22-8823	10 lbs	3 Pc 10 lbs Quick-Connect Lanyard Accessory

ANCHOR STRAP

**TETHER MORE TOOLS,
MORE PLACES**

ANSI/ISEA
121-18



Model #	Weight Rating	Description
48-22-8855	50 lbs	50 lbs Anchor Strap

WRIST LANYARDS

ALL DAY COMFORT

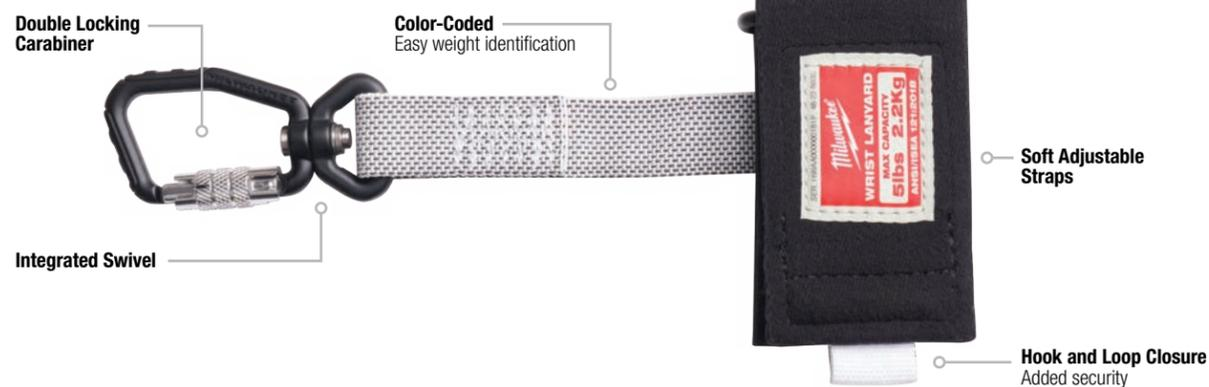

Also Available:



**5 lbs Quick-Connect
Wrist Lanyard**
48-22-8835



Model #	Weight Rating	Description
48-22-8830	5 lbs	5 Pc Wrist Lanyard
48-22-8835	5 lbs	5 lbs Quick-Connect Wrist Lanyard

HARD HAT LANYARDS

**BEST SHOCK
ABSORPTION**

ANSI/ISEA
121-18



Also Available:



**Hard Hat
Lanyard w/ Loop**
48-22-8801



Anchors to Shirt and Vest

Model #	Description
48-22-8800	Hard Hat Lanyard w/ Clip
48-22-8801	Hard Hat Lanyard w/ Loop

TAPE & D-RING WEB ATTACHMENTS

EASILY CONNECT

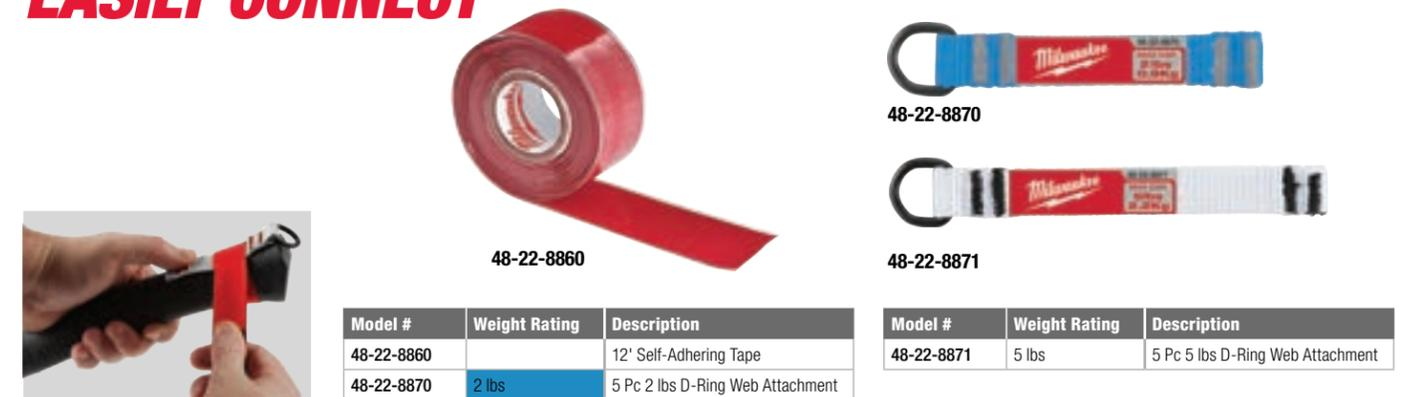

Model #	Weight Rating	Description
48-22-8860		12' Self-Adhering Tape
48-22-8870	2 lbs	5 Pc 2 lbs D-Ring Web Attachment

Model #	Weight Rating	Description
48-22-8871	5 lbs	5 Pc 5 lbs D-Ring Web Attachment

SPLIT RINGS

EASILY CONNECT

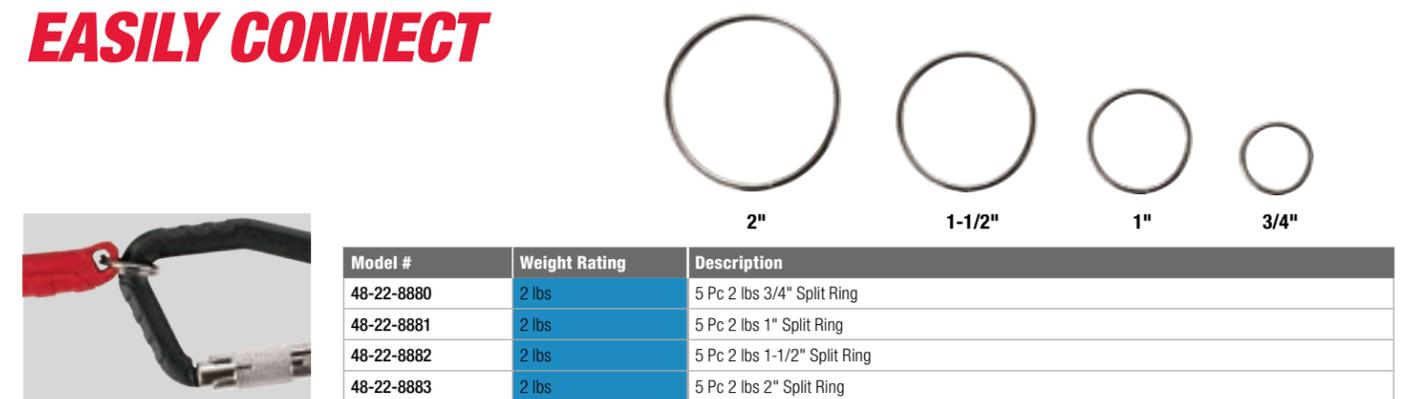

Model #	Weight Rating	Description
48-22-8880	2 lbs	5 Pc 2 lbs 3/4" Split Ring
48-22-8881	2 lbs	5 Pc 2 lbs 1" Split Ring
48-22-8882	2 lbs	5 Pc 2 lbs 1-1/2" Split Ring
48-22-8883	2 lbs	5 Pc 2 lbs 2" Split Ring

3-LAYER PERFORMANCE FACE MASK

**ALL DAY COMFORT.
BETTER FIT.**



Flexible Nose Bridge

Protective Barrier
Helps reduce the transmission of airborne contaminants

Model #	Description
48-73-4234	3-Layer Performance Face Mask – S/M
48-73-4235	3 Pk 3-Layer Performance Face Mask – S/M
48-73-4236	10 Pk 3-Layer Performance Face Mask – S/M

Model #	Description
48-73-4237	3-Layer Performance Face Mask – L/XL
48-73-4238	3 Pk 3-Layer Performance Face Mask – L/XL
48-73-4239	10 Pk 3-Layer Performance Face Mask – L/XL

2-LAYER FACE MASK

**LIGHTWEIGHT &
BREATHABLE**



Soft Breathable Layers

Protective Barrier
Helps reduce the transmission of airborne contaminants

Model #	Description
48-73-4230	Gray 2-Layer Face Mask
48-73-4231	3 Pk Gray 2-Layer Face Mask
48-73-4232	10 Pk Gray 2-Layer Face Mask

Model #	Description
48-73-4227	Red 2-Layer Face Mask
48-73-4228	3 Pk Red 2-Layer Face Mask
48-73-4229	10 Pk Red 2-Layer Face Mask

Also Available:



Red 2-Layer Face Mask
48-73-4227

- 2 TAPE MEASURES
- 4 LONG TAPES & MEASURING WHEELS
- 5 REDSTICK™ LEVELS
- 8 SQUARES & LASER DISTANCE METERS
- 9 FOLDING RULES & CHALK REELS
- 10 INKZALL™ JOBSITE MARKERS
- 11 INKZALL™ PAINT MARKERS, PENS & HIGHLIGHTERS
- 12 FASTENING PLIERS
- 13 FASTENING & CUTTING PLIERS
- 14 CUTTING PLIERS
- 15 COMBINATION & MULTI-FUNCTION PLIERS
- 16 APPLICATION SPECIFIC PLIERS
- 17 TORQUE LOCK™ PLIERS, C-CLAMPS & SPECIALTY
- 19 PIPE WRENCHES
- 21 ADJUSTABLE & BASIN WRENCHES
- 22 RATCHET & SOCKET SETS
- 23 RATCHETING COMBINATION WRENCHES
- 25 FLEX HEAD COMBINATION WRENCHES
- 26 RATCHETS
- 29 HOOK AND PICK SET & MULTI-BIT DRIVERS
- 30 MULTI-BIT DRIVERS
- 31 NAIL PULLERS, PRY BARS, DRILLING HAMMER
- 32 SCREWDRIVERS
- 33 DEMO DRIVERS & SCREWDRIVERS
- 34 NUT DRIVERS
- 35 HAMMERS & FIXED BLADE KNIVES
- 36 LINEMAN, FIXED BLADE, & POCKET KNIVES
- 37 FASTBACK™ POCKET & FOLDING KNIVES
- 38 FASTBACK™ FOLDING & UTILITY KNIVES
- 39 FASTBACK™ POCKET & FOLDING KNIVES
- 40 UTILITY KNIVES
- 41 UTILITY BLADES
- 42 UTILITY, SAFETY, & SNAP-OFF KNIVES
- 43 INSULATION & DUCT KNIVES
- 44 SAWS
- 45 AVIATION SNIPS
- 46 TINNERS
- 47 SCISSORS & BOLT CUTTERS
- 48 BOLT CUTTERS
- 49 HACKSAWS
- 50 LINEMAN'S WRENCHES
- 51 RATCHETING BOX WRENCHES
- 52 TUBING/PIPE CUTTERS & REAMING PEN
- 53 COPPER TUBING CUTTERS
- 55 LOW VOLTAGE VDV
- 57 CONDUIT BENDERS
- 58 FISH TAPES
- 59 PACKOUT™ MODULAR STORAGE
- 68 BAG & ROLLING BAGS
- 69 COOLER & BACKPACK
- 70 BACKPACKS
- 71 ORGANIZERS
- 73 WORK BELTS & UTILITY POUCHES
- 75 POWER UTILITY STORAGE
- 78 SAFETY HELMETS
- 79 HARD HATS
- 81 SAFETY VESTS
- 83 SAFETY GLASSES
- 85 HEAD PROTECTION & VEST CUSTOMIZATION
- 86 RESPIRATORS
- 87 EAR PLUGS
- 88 LEATHER GLOVES & WORK GLOVES
- 89 WORK GLOVES
- 90 WINTER GLOVES
- 91 CUT GLOVES
- 93 LEATHER PERFORMANCE & IMPACT CUT GLOVES
- 94 IMPACT CUT GLOVES
- 95 KNEE PADS
- 97 LANYARDS
- 99 LANYARD ACCESSORIES
- 100 FACE MASKS



25453 State Road 2 • South Bend, IN 46619

(574) 233-4300

Fax: (574) 233-4301

sales@SummitContractorSupply.com