

# **Solar Power for Home and Amateur Radio**

A freely distributable presentation for any  
Amateur Radio organization.

July 2013 by WN8U

# What will this presentation **not** cover?

- Mobile Solar Power
- Portable Solar Power (see Denny)
- Solar Power Theory

# What **will** be covered?

- Solar Panels
- Charge Controllers
- Wiring
- Batteries
- Home Applications
- Radio Applications

# Grid-Tied vs Off-Grid Solar

## Grid-Tied

- Feeds the grid when generating power.
- Saves you money on your electric bill.
- **Only** saves you money when the sun is shining
- Electric company **wants** you to have a grid-tied solar system. Why?

## Off-Grid

- Charges batteries when generating power.
- Reduces how much grid-power you use.
- Saves you money all the time.
- **You** want an off-grid solar system. Why?

# Solar Panels

Two types of silicon-based solar panels:

## Crystalline

- More expensive.
- More efficient (12% - 20%).
- Best choice for home solar (power / space).

## Thin Film

- Less expensive.
- Less efficient (6% - 10%).
- More area required for equivalent power generation.

# Two types of crystalline panels

## Monocrystalline

- Typically slightly more expensive.
- Typically slightly more efficient.
- Performance varies between makers and models

## Polycrystalline

- Typically slightly less expensive.
- Typically slightly less efficient.
- Performance varies between makers and models

# Typical Small Solar Panel



- 45W “12V” Panel (13%)
- Voltage at Max Power: 18.3 Volts
- Current at Max Power: 2.52 Amps
- $2.52 \times 18.3 = 46.116 \text{ W}$  maximum
- **Cost / Watt: \$2.95/W**

Almost all panels under 100W are “12V”

# Why 12 Volt Panels are 17 Volts

If panels were just made to produce 12V, they would provide power only when cool, under perfect conditions, and full sun. You cannot count on this. The panels need to provide some extra voltage so that when the sun is low in the sky, or you have heavy haze, cloud cover, or high temperatures, there is still useful output. A fully charged "12 volt" battery is around 12.7 volts at rest (around 13.6 to 14.4 under charge), so the panel has to put out at least that much under worst case conditions.

Contrary to intuition, solar panels work best at cooler temperatures. Roughly, a panel rated at 100 watts at room temperature will be an 83 watt panel at 110 degrees.



# Typical Large Solar Panel



- 285W Panel: \$275 (15%)
- Voltage at Max Power: 35.4 Volts
- Current at Max Power: 8.05 Amps
- $8.05 \times 35.4 = 250.004 \text{ W}$  maximum
- **Cost / Watt: \$0.96/W**

Almost all panels over 100W are 30V+

# Solar Charge Controllers

Essentially a charge regulator for voltage and current to keep batteries from overcharging. Most "12 volt" panels put out about 16 or more, so if there is no regulation the batteries will be damaged from overcharging.

Standard controllers will often work with high voltage panels if the maximum input voltage of the charge controller is not exceeded. However, ***you will lose a lot of power*** - from 20 to 60% of what your panel is rated at. Charge controls take the output of the panels and feed current to the battery until the battery is fully charged, usually around 13.6 to 14.4 volts. A panel can only put out so many amps, so while the voltage is reduced, the amps from the panel cannot go higher than the rated amps - so with a 175 watt panel rated at 23 volts/7.6 amps, you will only get 7.6 amps @ 12 volts or so into the battery. Ohms Law tells us that watts is volts x amps, so your 175 watt panel will only put about 90 watts into the battery.

# MPPT Solar Charge Controllers

Ohms Law says that Power is Power!

The only way to get full power out of high voltage grid tie solar panels is to use an MPPT controller. Most MPPT controllers can take up to 150 volts DC on the solar panel input side, you can often series two or more of the high voltage panels to reduce wire losses, or to use smaller wire. More on that later. For example, with the 285 watt panel, 2 of them in series would give you 70.8 volts at 8.05 amps into the MPPT controller, but the controller would convert that down to about 47.5 amps at 12 volts, or 23.75 amps at 24 volts.

$$70.8V \times 8.05A = 570W$$

$$24V \times 23.75A = 570W$$

$$12V \times 47.5A = 570W$$

# Standard Solar Charge Controller



- 45 amp maximum
- 12/24/48 volt configurable
- Good for up to 4kW
- \$149.50

# MPPT Solar Charge Controller



- 45 amp maximum
- 150 volt input maximum
- Good for up to 3.2kW
- 8-72 volt output range
- \$409.00

# Charge Controller Stages

**Bulk** - the voltage gradually rises to the Bulk level (per battery) while the batteries draw maximum current.

**Absorption** - the voltage is maintained at Bulk voltage level for a specified time (usually an hour) while the current gradually tapers off as the batteries charge up.

**Float** - the voltage is lowered to float level (usually 13.4 to 13.7 volts) and the batteries draw a small maintenance current until the next cycle.

# Wire Sizing for Solar Power

**Properly sized wire** can make the difference between inadequate and full charging of a battery system, between dim and bright lights, and between feeble and full performance of radios.

You will need to use correct wire sizes to ensure low loss of energy and to prevent overheating and possible damage or even fire.

AWG	Ohms / 100ft
20	1.114
18	0.689
16	0.435
14	0.254
12	0.170

AWG	Ohms / 100ft
10	0.100
8	0.069
6	0.044
4	0.025
2	0.016

# Wire Sizing for Solar Power

Compare the losses of 10 amp as 12 volts (120W)

AWG	Resistance	Voltage Drop	Power Delivered
20	0.557 $\Omega$	5.57 V	64.3 W
18	0.345 $\Omega$	3.45 V	85.5 W
16	0.218 $\Omega$	2.18 V	98.2 W
14	0.127 $\Omega$	1.27 V	107.3 W
12	0.085 $\Omega$	0.85V	111.5 W
10	0.050 $\Omega$	0.50 V	115.0 W
8	0.035 $\Omega$	0.35 V	116.5 W
6	0.022 $\Omega$	0.22 V	117.8 W
4	0.013 $\Omega$	0.13 V	118.7 W
2	0.008 $\Omega$	0.08 V	119.2 W



# Batteries

Nearly all large rechargeable batteries in common use are Lead-Acid type. The acid is typically 30% Sulfuric acid and 70% water at full charge.

NiFe (Nickel-Iron) batteries are also available. These have a very long life, but rather poor efficiency (60-70%) and the voltages are different, making it more difficult to match up with standard 12v/24/48v systems and inverters.

# Batteries

Batteries are divided into two types based on application

## Starter

- Designed to deliver short bursts of high amps
- NOT designed to discharge to low levels
- Not designed to absorb power rapidly

## Deep Cycle

- Designed to deliver sustained power
- Designed to discharge lower without damage
- Can absorb (recharge) rapidly

# Deep Cycle Batteries

Sometimes called "fork lift", "traction" or "stationary" batteries, are used where power is needed over a longer period of time, and are designed to be "deep cycled", or discharged down as low as 20% of full charge (80% DOD, or Depth of Discharge).

Deep cycle batteries have much thicker plates than automotive batteries. They are often used in larger PV systems because you can get a lot of storage in a single (very large and heavy) battery.

# Deep Cycle Batteries

Plate thickness (of the Positive plate) matters because of a factor called "**positive grid corrosion**". This ranks among the top 3 reasons for battery failure. The positive (+) plate is what gets eaten away gradually over time, so eventually there is nothing left - it all falls to the bottom as sediment.

Thicker plates are directly related to longer life, so other things being equal, the battery with the thickest plates will last the longest.

# Deep Cycle Batteries

Automotive batteries typically have plates about .040" (4/100") thick, while forklift batteries may have plates more than 1/4" (.265" for example in larger Rolls-Surrette) thick - almost 7 times as thick as auto batteries. The typical golf cart will have plates that are around .07 to .11" thick.

While plate thickness is not the only factor in how many deep cycles a battery can take before it dies, it is the most important one.

# Deep Cycle Batteries

Flooded batteries are the most common type of battery. They require maintenance (check acid level, add water). They can spill and leak if not stored properly (upright).

Sealed batteries are made with vents that cannot be removed. The so-called “Maintenance Free” batteries are also sealed, but are not usually leak proof. Sealed batteries are not totally sealed, as they must allow gas to vent during charging. If overcharged too many times, some of these batteries can lose enough water that they will die before their time. There is no way to add water.

# Gel Deep Cycle Batteries

Gelled batteries, or "Gel Cells" contain acid that has been "gelled" by the addition of Silica Gel, turning the acid into a solid mass that looks like gooey Jell-O. It is impossible to spill acid even if they are broken. However, they must be charged at a slower rate (C/20) to prevent excess gas from damaging the cells. They cannot be fast charged or they may be permanently damaged. This is not usually a problem with solar electric systems, but current **must be limited** to the manufacturers specifications.

Not typically used any more, replaced by AGM.

# AGM Deep Cycle Batteries

A newer type of sealed battery uses "Absorbed Glass Mats", between the plates. This is a very fine fiber Boron-Silicate glass mat. These are also called "starved electrolyte", as the mat is about 95% saturated rather than fully soaked. That also means that they will not leak acid even if broken.

Nearly all AGM batteries are "**recombinant**". The oxygen and hydrogen recombine INSIDE the battery, turning back into water while charging and prevent the loss of water through electrolysis. The recombining is typically 99+% efficient, so almost no water is lost.



# Charging Batteries

**It is absolutely crucial to understand that batteries must be charged at the battery manufacturers specification!**

A battery that does not charge at the proper voltage will never, **ever**, achieve a full charge.

Lots of people make this mistake and either assume that all batteries use the same voltage or use what the charge controller says. **WRONG!**

# Battery Comparisons



Trojan T015-RE “Golf Cart” 6V 225 AH  
\$174 each / \$348 for 12V 225 AH  
Weight: 67lbs (each)  
Size: 10” L x 7” W x 12” H

Trojan L16-RE-A 6V 325 AH  
\$305 each / \$610 for 12V 325 AH  
Weight: 115lbs (each)  
Size: 12” L x 7” W x 18” H



# Battery Comparisons



Trojan IND13-6V 6V 673 AH  
\$1,100 each / \$2,200 for 12V 673 AH  
Weight: 315lbs (each)  
Size: 22" L x 10" W x 24" H

Trojan 31-AGM 12V 100 AH  
\$239 each  
Weight: 69lbs  
Size: 13" L x 7" W x 10" H



# Battery Comparisons

Model	Amp-Hours	Cost @ 12V	\$\$\$ / AH
T015-RE	225 AH	\$348	\$1.54 / AH
L16-RE-A	325 AH	\$610	\$1.87 / AH
IND13-6V	673 AH	\$2200	\$3.26 / AH
31-AGM	100 AH	\$239	\$2.39 / AH

If the smaller flooded batteries are the most cost effective, why use larger more expensive batteries?

# Wiring Batteries to the Charger

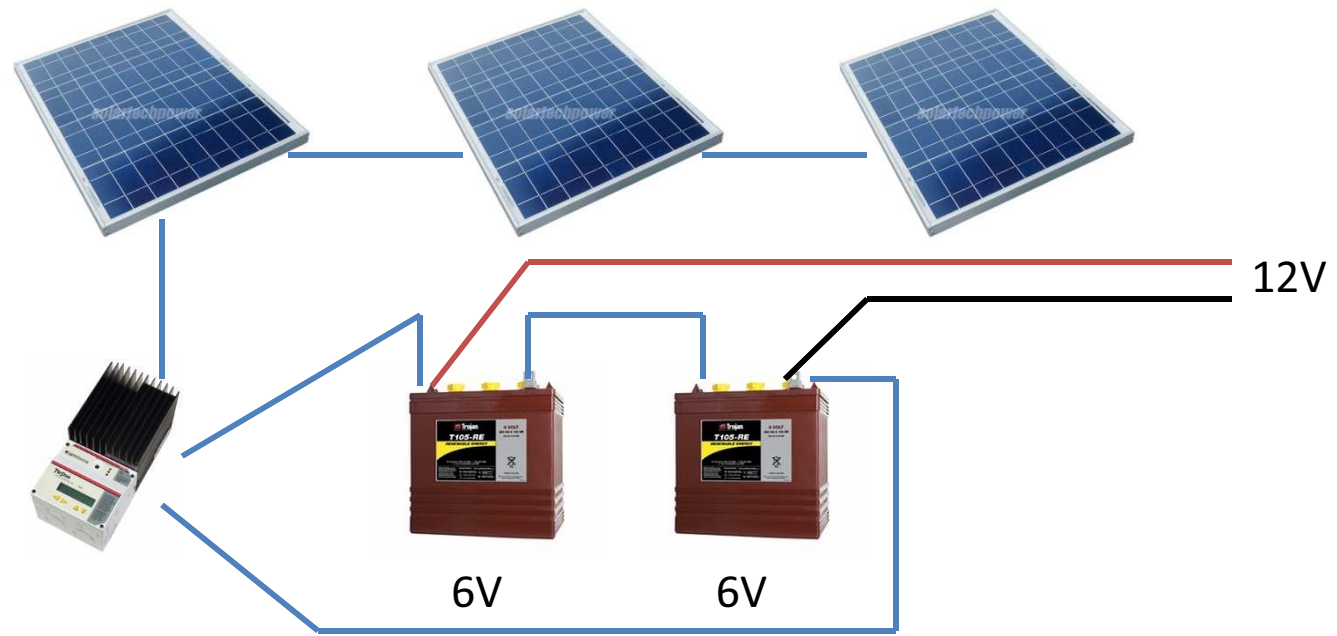

# Wiring Batteries to the Charger

## Method 1

The connections to the main installation are all taken from one end, i.e. from the end battery. The interconnecting leads will have some resistance. It will be low, but it still exists, and at the level of charge and discharge currents we see in these installations, the resistance will be significant in that it will have a measurable effect.

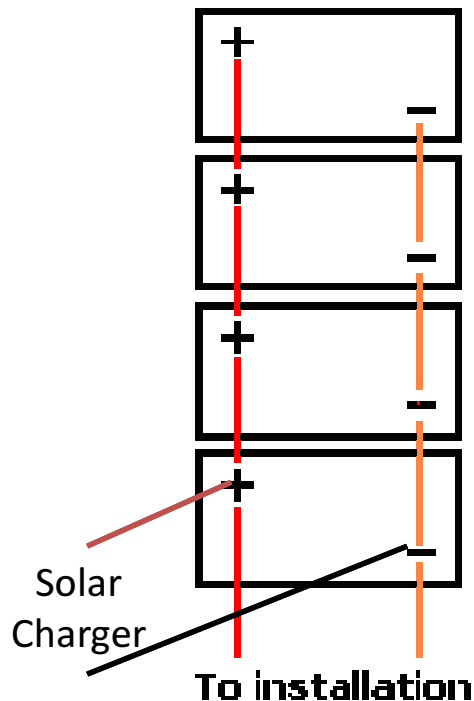

If we draw 100 amps from this battery bank we will effectively be drawing 25 amps from each battery. Or so we think. In actual fact what we find is that more current is drawn from the bottom battery, with the current draw getting progressively less as we get towards the top of the diagram. The effect is greater than would be expected.

Whilst this diagram looks simple, the calculation is incredibly difficult to do completely because the internal resistance of the batteries affects the outcome so much.

# Wiring Batteries to the Charger

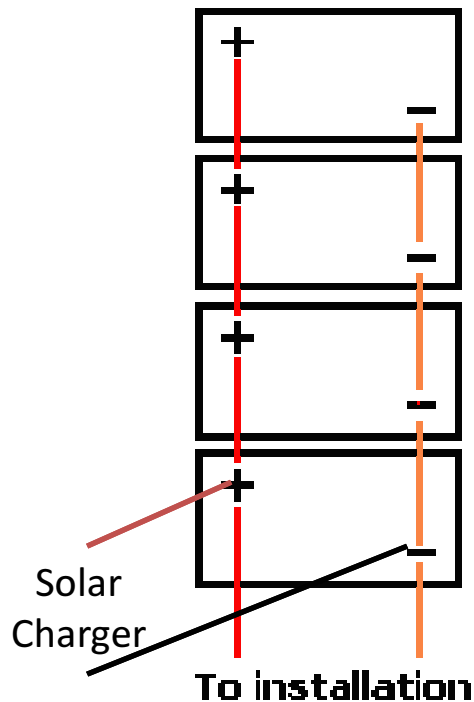

However look at where the load would be connected. The power coming from the bottom battery only has to travel through the main connection leads. The power from the next battery up has to travel through the same main connection leads but in addition also has to travel through the 2 interconnecting leads to the next battery. The next battery up has to go through 4 sets of interconnecting leads. The top one has to go through 6 sets of interconnecting leads. So the top battery will be providing much less current than the bottom battery.

During charging exactly the same thing happens, the bottom battery gets charged with a higher current than the top battery. The result is that the bottom battery is worked harder, discharged harder, charged harder. It fails earlier. The batteries are not being treated equally.

# Wiring Batteries to the Charger

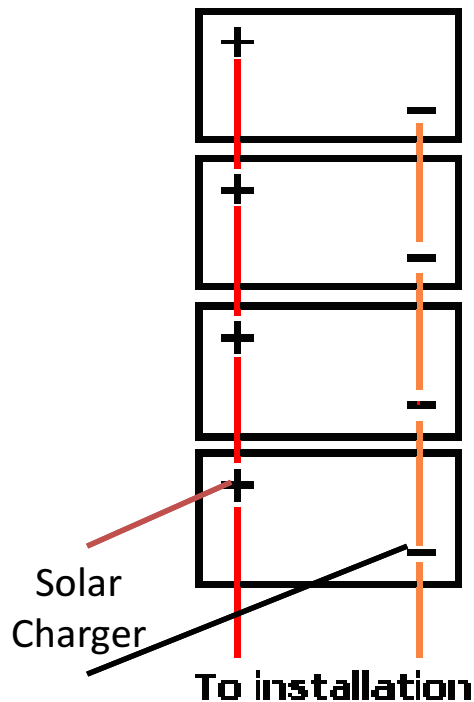

The problem is that in very low resistance circuits (as we have here) **huge** differences in current can be produced by **tiny** variations in battery voltage. I'm not going to produce the calculations here because they really are quite horrific. I actually used a PC based simulator to produce these results because it is simply too time consuming to do them by hand.

Battery internal resistance = 0.02 Ohms

Interconnecting lead resistance = 0.0015 Ohms per link

Total load on batteries = 100 amps

The bottom battery provides 35.9 amps of this.

The next battery up provides 26.2 amps.

The next battery up provides 20.4 amps.

The top battery provides 17.8 amps.

So the bottom battery provides over twice the current of the top battery.



# Wiring Batteries to the Charger

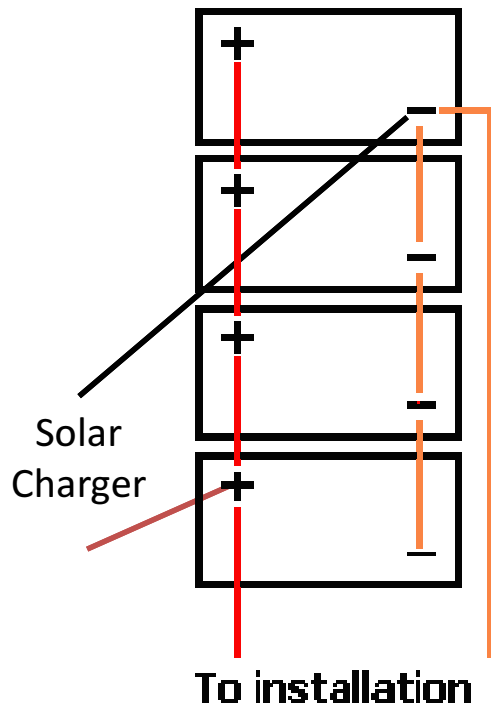

## Method 2

In this diagram the main feeds to the rest of the installation are from diagonally opposite posts. Everything else in the installation remains identical. Also, it doesn't matter which lead (positive or negative) is moved, whichever is easiest is the correct one to move. The results of this modification, when compared to the original diagram are shown:

With the same 100 amp load....

The bottom battery provides 26.7 amps of this.

The next battery up provides 23.2 amps.

The next battery up provides 23.2 amps.

The top battery provides 26.7 amps.

# Wiring Batteries to the Charger

Solar  
Charger

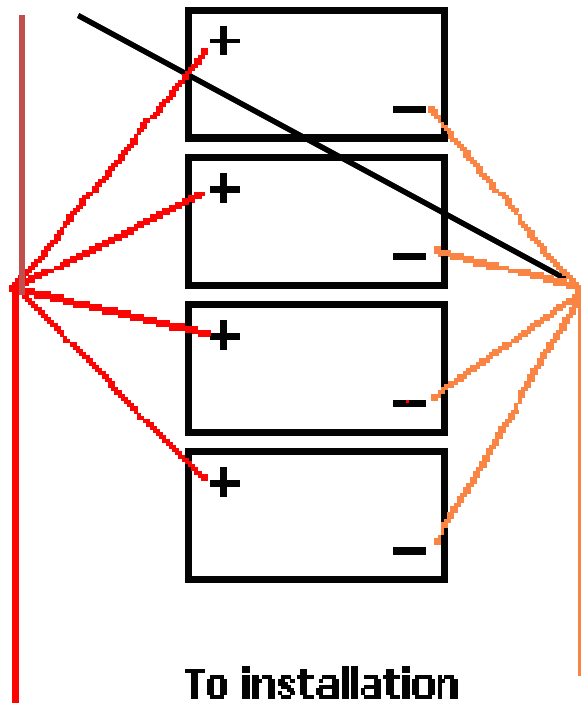

## Method 3

This looks more complicated. It is actually quite simple to achieve but requires two extra interconnecting links and two terminal posts. Note that it is important that all 4 links on each side are the same length otherwise one of the main benefits (that of equal resistance between each battery and the loads) is lost. The difference in results between this and the 2nd example are much smaller than the differences between the 1st and 2nd but with expensive batteries it might be worth the additional work.

This method isn't always so easy to install because of the required terminal posts. In some installations there is simply no room to fit these. Especially when using a large quantity of batteries (8, 16, etc).

# Wiring Batteries to the Charger

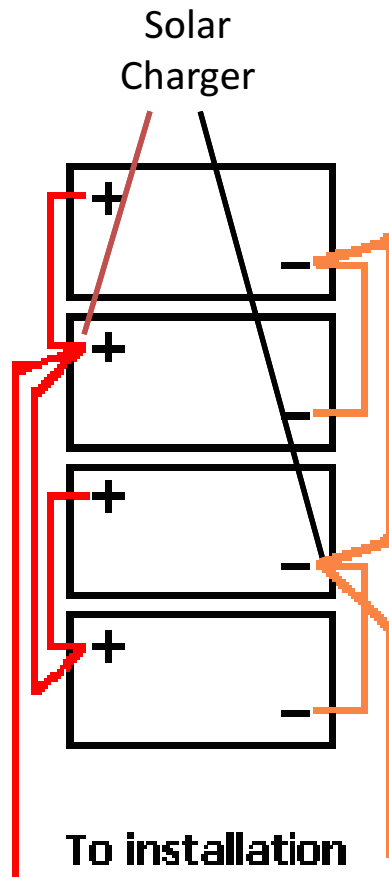

## Method 4

Another wiring method that achieves perfect battery balancing.

What has been done here is to start with 2 pairs of batteries. Each wired in the proper "cross diagonal" method. Then each pair is wired together, again in the cross diagonal method. Notice that for each individual battery, the current always goes through a total of one long link and one short link before reaching the loads. This method also achieves perfect balance between all 4 batteries and may be easier to wire up in some installations.

# Wiring Batteries to the Charger

The previous examples demonstrate wiring concerns when using 12V charging from the solar charger.

However, consider the using 24V or 48V storage might be more appropriate. This can be done by wiring several 12V systems in series. It can get complicated.

With 12V storage, you need to use very heavy wire to reduce the voltage loss when using high amps.

With 24V or 48V storage, you can use much lighter wire because your amperage will be lower by comparison. This can make your installation easier and cheaper.

# Batteries and Temperature

Lead-acid batteries temporarily lose approximately 20% of their effective capacity when their temperature falls to 30°F (-1°C). This is compared to their rated capacity at a standard temperature of 77°F (25°C). At higher temperatures, their rate of permanent degradation increases. So it is desirable to protect batteries from temperature extremes. Where low temperatures cannot be avoided, buy a larger battery bank to compensate for their reduced capacity in the winter. Avoid direct radiant heat sources that will cause some cells to get warmer than others. The 77°F temperature standard is not sacred, it is simply the standard for measurement of capacity. An ideal range is between 50 and 85°F (10-29°C).

Arrange batteries so they all stay at the same temperature. If they are against an exterior wall, insulate the wall and leave room for air to circulate. Leave air gaps of about 1/2 inch (13 mm) between batteries, so those in the middle don't get warmer than the others.

# Batteries and Ventilation

The enclosure should keep the batteries clean and dry, but a minimum of ventilation is required by the National Electrical Code, Article 490.9(A). A battery enclosure must provide easy access for maintenance, especially for flooded batteries. Do not install any switches, breakers, or other spark-producing devices in the enclosure. They will ignite an explosion of the hydrogen gas bubbles gassing out during charging.

(To the right: A beautifully installed 48 V battery bank -- sixteen 6 V batteries connected in 2 strings of 8. These big Surrrette batteries have 2 holes on each terminal, so cable lugs don't have to be stacked! The peaked battery enclosure allows for excellent hydrogen venting.)



# Home Applications



Morningstar SureSine SI-300-115V  
300W DC Pure Sine Wave Inverter  
115V AC  
\$232.70

Much larger inverters are available... up to 4000W.  
Make sure you get Pure Sine Wave inverters for  
anything electronic and beware anything cheap. You  
get what you pay for when it comes to these.

# Home Applications



Sundanzer DCF225

8.1CF Chest Freezer

\$1,195.00

Runs on 12V

Optimized for 24V

650 Watt-hours daily average

54 AH 12V / 27 AH 24V



# Home Applications



Solar Chill 18in Evap Cooler

1500 CFM

\$1,090.00

24V

60 Watt-hours daily average

5 AH 12V / 2.5 AH 24V

# Home Lighting



16 foot roll of LED lights, 24W for the entire roll, \$13 at Amazon. Takes 12V DC power.



# Home Lighting

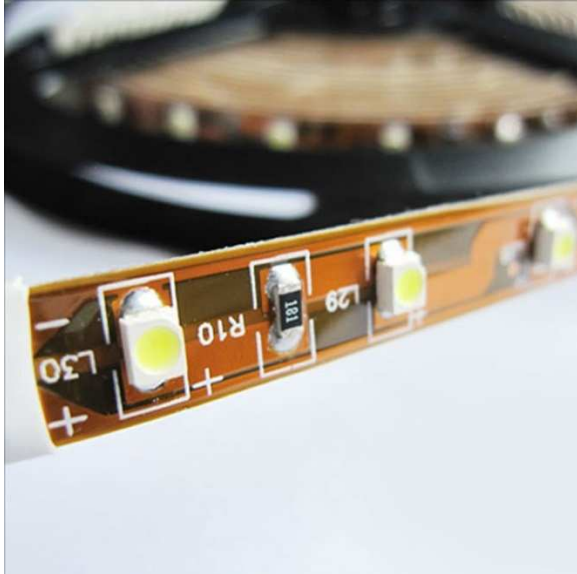

Can be cut after every 3<sup>rd</sup> LED.  
Dimmable (with potentiometer).  
Combine with Crown moulding for indirect room lighting



# Home Lighting

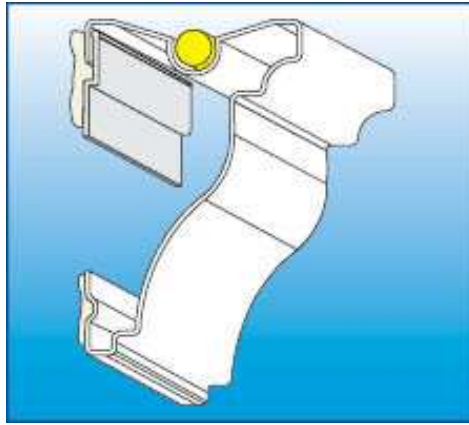

# Parallel Home Wiring



Run DC wiring through the house and plug in DC appliances and devices just like AC appliances!

Plug in any appliance that you use in your RV, at home.



# Radio Applications

Srsly?

(Seriously?)