

APPENDIX A

SUMMARIES OF
CUMULATIVE EFFECTS ANALYSIS METHODS

1

QUESTIONS, INTERVIEWS, AND PANELS

Questionnaires, interviews, and panels are important information gathering techniques for analyzing cumulative effects. Such techniques are especially valuable to the analyst, because they *collect information on the wide range of actions and effects needed to address cumulative problems*. The analyst will often use brainstorming sessions, interviews with knowledgeable individuals, and group consensus building activities to identify the important cumulative effects issues in the region.

Questionnaires, interviews, and panels are applicable to both social and environmental effects and are used primarily in the scoping process. They are often the principal method for identifying potential efforts and can be used to help characterize spatial and cause-and-effect relationships. Rather than simply collecting data, these techniques can be used for "strategizing" (i.e., prioritizing issues and defining the scope of the study).

The choice of information gathering techniques draws upon the experience and professional judgement of the analysts. Simple brainstorming of experts and other interested parties can be an effective technique for

identifying potential cumulative effects problems. Information gathering can be expanded to include structured interviews with key opinion leaders, indigenous peoples, and technical experts. These activities are essential components of the scoping process and, in many cases, are sufficient for qualitative analysis.

A common feature of information gathering and strategizing is the use of a multi-disciplinary panel of experts. These panels can bring consensus to subjective judgements and are useful for designing the assessment method, evaluating the significance of effects, and comparing alternatives. The Delphi method (Linstone and Turoff 1975) provides a structured process for producing expert consensus and is applicable to groups of various compositions. Fuzzy set models provide another means of structuring subjective evaluations of cumulative effects issues (Harris et al. 1994; Wegner and Reng 1987). Panels or other group-decision methods often use evaluative techniques to score or rank effects during the decisionmaking process. In this way, panels can be used to estimate the importance of cumulative effects even though they are necessarily subjective and qualitative (Stull et al. 1987).

METHODS

1

EXAMPLES:

Information gathering is essential to all environmental impact assessment and can become especially involved when scoping for cumulative effects in an EIS. Primarily, the analyst will use questionnaires, interviews, and panels to build a comprehensive list of environmental problems that could accumulate. During preparation of an EIS on the Castle Mountain open heap leach gold mine project, the U.S. Bureau of Land Management (1990) compiled a wide range of information into a list of activities that, combined with the proposed action, might produce cumulative effects (Chapter 3, Table 3-1). For each of 26 individual activities, anticipated cumulative effects were identified for each of 12 resource issues. The status (existing or proposed) of these additional activities and the primary geographical location of effects were also listed.

The analyst will also use these information gathering techniques to help develop a community vision for the region when the cumulative effect of a suite of actions will restore resources. The Restoration Plan for the Exxon Valdez Oil Spill in Alaska involved identifying many individual restoration options that, when combined as an alternative, would have the cumulative beneficial effect of mitigating natural resource damages resulting from the spill. The Restoration Plan required an extremely high level of coordination among federal and state agencies, as well as commercial fishermen, local businesses, and Native American communities. The Restoration Team had the formidable task of determining whether the cumulative effect of a set of restoration

options (an alternative) would meet the public's expectations for restoration of resources. To accomplish this, a scientific conference and many public meetings were held, producing a "Restoration Framework" that served as a scoping document under NEPA (EVOS Trustee Council 1992, 1993). In addition, a questionnaire was distributed to the public along with a summary of the draft Restoration Plan (EVOS Restoration Office 1993) as a means of soliciting public comment on the critical issues addressed by the Restoration Plan.

References

- Exxon Valdez Oil Spill (EVOS) Restoration Office. 1993. Exxon Valdez Oil Spill Restoration Plan. Summary of Alternatives for Public Comment. Anchorage, AK. April.
- Exxon Valdez Oil Spill (EVOS) Trustee Council. 1992. Exxon Valdez Oil Spill Restoration, Volume I: Restoration Framework. Anchorage, AK. April.
- Exxon Valdez Oil Spill (EVOS) Trustee Council. 1993. Exxon Valdez Oil Spill Symposium. Anchorage, AK. February.
- Harris, H.J., R.D. Wenger, V.A. Harris, and D.S. DeValut. 1994. A method for assessing environmental risks: A case study of Green Bay, Lake Michigan. *Environmental Management* 18(2):295-306.
- Linstone, H.A. and M. Turoff, eds. 1975. *The Delphi Methods: Techniques and Applications*. Addison-Wesley Publishing Co., Reading, MA.

METHODS

Stull, E.A., K.E. LaGory, and W.S. Vinikour. 1987. Methodologies for assessing the cumulative environmental effects of hydroelectric development on fish and wildlife in the Columbia River Basin - Volume 1: Recommendations. DOE/BP-19461-3. Final report to Bonneville Power Administration, Portland, OR.

U.S. Bureau of Land Management. 1990. Final Environmental Impact Statement. Castle Mountain Project, San Bernadino County, California. Needles, CA.

Wenger R. and Y. Reng. 1987. Two fuzzy set models for comprehensive environmental decisionmaking. *Journal of Environmental Management* 25:167-180.

2 CHECKLISTS

Checklists can help the analyst identify potential environmental effects by providing a list of common or likely effects. Checklists are especially valuable for analyzing cumulative effects because they *provide a format for juxtaposing multiple actions and resources in a way that highlights potential cumulative effects*. Checklists are potentially dangerous for the analyst who uses them as a shortcut to thorough scoping.

The strength of checklists is that they structure the analysis and reduce the likelihood that major effects will be overlooked; however, checklists are incomplete, they may cause important effects to be omitted. Because of the standard checklist format, checklists are more repeatable than ad hoc methods. They also provide a means of concisely presenting effects. At the same time, the simplicity of the checklist format has disadvantages. A checklist may be either an incomplete compilation of effects or a huge, unwieldy list with many irrelevant

effects. In an attempt to be comprehensive, the checklist may also lead to "double counting" the same effect under different headings.

Many of these disadvantages are avoided by developing checklists for specific kinds of projects. Checklists can also be simplified by organizing potential effects into separate lists or hierarchical categories for each resource, ecosystem, and human community of concern. To address cumulative effects, checklists need to incorporate all of the activities associated with the proposed action and other past, present, and future actions affecting the resources. A promising approach is to use project-specific checklists (for each relevant past, present, and future action) to identify and quantify effects on resources and then transfer these effects to a cumulative checklist or interaction matrix (see Method 3). Two or more effects on a single resource indicate a potential cumulative effect; weighted effects can be summed to indicate the magnitude of the effect.

METHODS

2 EXAMPLES:

Specific checklists have been developed for many different classes of actions (e.g., housing projects, sewage treatment facilities, power plants, highways, airports). Several federal agencies have standard checklists for preparing EISs or EAs (e.g., U.S. DOE 1994). The California Department of Transportation (1993) has developed a checklist of 56 questions that must be answered for each state highway project. Question 55 specifically addresses cumulative effects:

Does the project have environmental effects which are individually limited, but cumulatively considerable? Cumulatively considerable means that the incremental effects of an individual project are considerable when viewed in connection with the effects of past projects, the effects of other current projects, and the effects of probable future projects. It includes the effects of other projects which interact with this project and, together, are considerable.

This kind of "simple" questionnaire checklist acts merely as a reminder to the analyst and does not include supplemental information about the likely kinds of effects that may arise. Canter and Kamath (1995) have developed a comprehensive, yet generic, questionnaire checklist that addresses the cumulative effects

of projects. "Descriptive" checklists expand on the checklist concept by including information on measuring and predicting effects (Canter 1996). A more elaborate descriptive checklist is the environmental impact computer system developed by the U.S. Army Construction Engineering Laboratory (Lee et al. 1974). This system identifies potential environmental effects from 9 functional areas of Army activities on 11 broad environmental categories (Jain and Kumar 1973). This computer system can produce checklists of potential effects arising from up to 2,000 Army activities on 1,000 environmental factors. The organization of activities and resources in the same table constitutes an interaction matrix as originally devised by Leopold and others (1971).

Checklists can also be modified to include qualitative terms for each identified effect, such as "adverse" or "beneficial," "short-term" or "long-term," and "no effect" or "significant effect." The hypothetical cumulative checklist in Table A-1 uses a qualitative symbol in place of the usual checkmark next to each potential effect on the list. In this example, the cumulative effects column reflects the number or magnitude of cumulative effects identified for that resource row. More sophisticated uses of this tabular approach are discussed in the matrices section that follows.

METHODS

Table A-1. Hypothetical checklist for identifying potential cumulative effects of a highway project

Potential Impact Area	Proposed Action			Past Actions	Other Present Actions	Future Actions	Cumulative Impact
	Construction	Operation	Mitigation				
Topography and Soils	**			*			**
Water Quality	**	*	+	*	*	*	***
Air Quality		**		*			**
Aquatic Resources	**	**	+	*		*	**
Terrestrial Resources	*	*		*			**
Land Use	*	***		*		*	***
Aesthetics	**	***	+	*			**
Public Services	*	+				+	+
Community Structure		*			*		*
Others							

KEY: * low adverse effect ** moderate adverse effect *** high adverse effect
 + beneficial effect □ no effect

References

California Department of Transportation (Caltrans). 1993. Environmental Significance Checklist, Caltrans Contract No. 08E425. Project Report and Environmental Document for Interstate 215 from I-10 to SR 30. 9 pp.

Canter, L.W. 1996. *Environmental Impact Assessment. Second Edition*. McGraw-Hill, New York.

Canter, L.W. and J. Kamath. 1995. Questionnaire checklist for cumulative impacts. *Environmental Impact Assessment Review*. 15:311-339.

Jain, R.K. and R. Kumar. 1973. Environmental impact assessment study for Army military programs. Technical Report. D-13, U.S. Army Construction Engineering Laboratory, Champaign, IL.

Lee, E.Y.S., et al. 1974. Environmental impact

assessment computer system. Technical Report. E-37, U.S. Army Construction Engineering Laboratory, Champaign, IL.

Leopold, L.B., F.E. Clarke, B.B. Hanshaw, and J.R. Balsley. 1971. A Procedure for Evaluating Environmental Impact. Circular 645. U.S. Geological Survey. 13 pp.

U.S. Department of Energy (DOE). 1994. Environmental Assessment Checklist. Office of NEPA Oversight, U.S. DOE, Washington, DC.

METHODS

3 MATRICES

Matrices are two-dimensional checklists that attempt to quantify the interactions between human activities and resources or ecosystems of concern. They were designed to assess the magnitude and importance of individual interactions between activities and resources (Leopold et al. 1971) but have been extended to consider the cumulative effects of multiple actions on resources (Bain et al. 1986; Stull et al. 1987; LaGory et al. 1993).

Matrices alone cannot quantify effects, but they are a useful means of presenting and manipulating quantitative results of modeling, mapping, and subjective techniques. Once even relatively complex numerical data are obtained, matrices are well-suited to *combining the values in individual cells in the matrix (through matrix algebra) to evaluate the cumulative effects of multiple actions on individual resources, ecosystems, and human communities*. Matrices have the advantage of being mathematically straightforward and readily amenable to interpretation because of their familiar tabular format. Matrices are commonly used in social science research and have the potential for increased application in social and economic analyses.

The values entered in a matrix can take one of several forms. The analyst may elect to simply note the presence or absence of an effect (i.e., a binary entry). This has the benefit of being straightforward and readily understandable; however, it fails to note the magnitude of

effects on various resources and does not allow the user to value resources differentially (e.g., through the use of numeric weights). Thus, a binary approach does not facilitate analyzing the cumulative effects on a resource, where the activities have consequences of varying degrees.

Analysts may instead choose to score effects based on factors such as magnitude, importance, duration, probability of occurrence, or feasibility of mitigation. The value entered may reflect some measurable value (e.g., soil loss may be expressed in tons/acre/ year), or it may reflect some relative ranking of the effect. Although complex weighting schemes allow the user to rank resource effects, the results may be difficult for others to understand, and the weighting schemes can be highly subjective. When using weighting schemes, analysts should enunciate the ranking criteria and consider whether it is scientifically reasonable to attempt a numeric comparison of cumulative effects on different resources.

The matrix concept can be extended to include stepped matrices that display resources against other resources (Canter 1996). Stepped matrices address secondary and tertiary effects of initiating actions and facilitate tracing effects through the environment. For example, action 1 causes changes in resource A which causes further changes in resource B. Stepped matrices are an intermediate method between simple matrices and networks and system diagrams (see Method 4).

METHODS

3 EXAMPLES:

Matrices were first formally proposed for environmental impact assessment by the U.S. Geological Survey (Leopold et al. 1971). Since that time a number of matrix methods have been proposed for analyzing cumulative effects. One such methodology is the Cluster Impact Assessment Procedure (CIAP) developed by the Federal Energy Regulatory Commission in the mid-1980s (FERC 1985, 1986a; Russo 1985). The methodology was developed specifically for use in assessing the cumulative effects of small hydroelectric facilities within single watersheds. The CIAP uses a matrix for each resource (e.g., salmon) consisting of relative effect ratings (on a scale from 1 to 5) arranged by project and resource components (e.g., for salmon, spawning habitat, migration). Each resource matrix table contains a summary column that represents the sum of effect ratings across components for each project (Figure A-1). An overall summary table is then developed that presents the effects of each project on all resources analyzed.

The CIAP does not incorporate or consider the possibility of synergistic interactions among projects that could result in nonadditive effects on resources; the effects of individual projects are simply added together to determine cumulative effects. This short-coming led to modification of the methodology to include interaction effects. With these modifications, cumulative

effects are viewed as being equivalent to the sum of the effects of individual projects plus any interaction between pairs of projects. Modified CIAP procedures include the approach used in the Salmon River and Snohomish River EISs for hydroelectric development in those basins (FERC 1986b, 1987; Irving and Bain 1993). Other matrix methodologies that incorporate interaction effects have been proposed (Bain et al. 1986; Stull et al. 1987; LaGory et al. 1993). Each represents a further development of the approach with an attempt to more accurately quantify cumulative impacts; consequently, each succeeding methodology attains additional complexity.

The Integrated Tabular Methodology (Stull et al. 1987; LaGory et al. 1993) uses the same matrix approach as Bain et al. (1986) but involves a systematic (albeit relatively complex) method of quantifying and developing interaction coefficients. To determine interaction coefficients, this method requires identification of the impact zones for all projects being evaluated as well as knowledge of the response of resources to environmental change. The methodology is designed to be flexible and can use a wide variety of data and models. For example, the methodology can use evaluative criteria such as effect ratings, habitat suitability indices (USFWS 1980; Bovee 1982), or quantitative population models.

METHODS

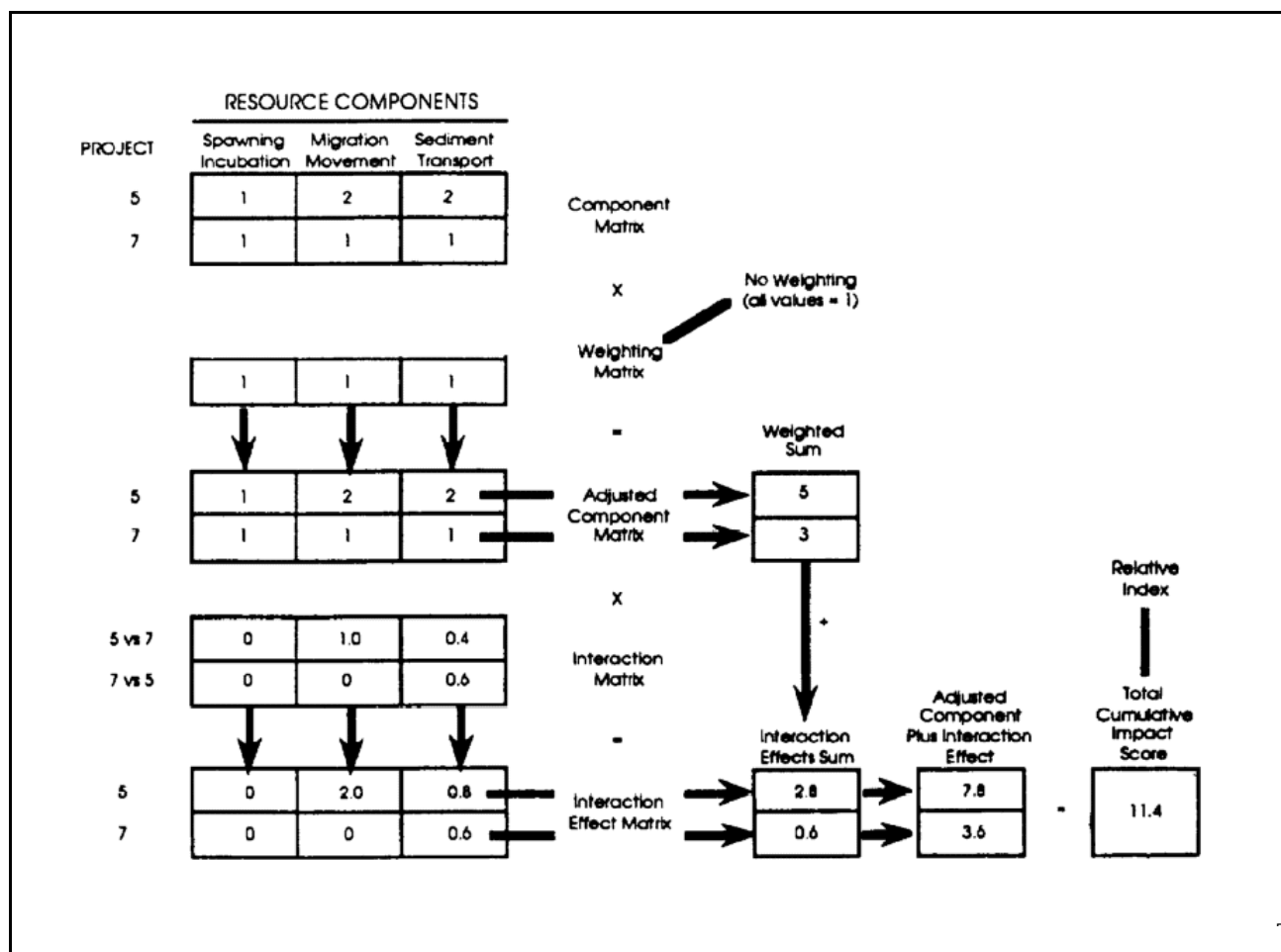

Figure A-1. Example of cumulative impact computations for a target resource with three resource components and two projects (FERC 1987).

References

Bain, M.B., J.S. Irving, R.D. Olsen, E.A. Stull, and G.W. Witmer. 1986. Cumulative impact assessment: evaluating the environmental effects of multiple human developments. ANL/EES-TM-309. Argonne National Laboratory, Argonne, IL.

Bovee, K.D. 1982. A guide to stream habitat analysis using the instream flow incremental methodology. Instream Flow Information Paper 12. FWS/OBS-82/26. U.S. Fish and Wildlife Service, Western Energy and Land Use Team, Fort Collins, CO.

Canter, L.W. 1996. *Environmental Impact Assessment, Second Edition*. McGraw-Hill, New York.

Federal Energy Regulatory Commission (FERC). 1985. Procedures for assessing hydropower projects clustered in river basins: request for comments. *Federal Register* 50:3385-3403.

Federal Energy Regulatory Commission (FERC). 1986a. Owens River Basin, seven hydroelectric projects, California. Federal Energy Regulatory Commission, Washington, D.C. FERC/DEIS-0041.

METHODS

Federal Energy Regulatory Commission (FERC). 1986b. Snohomish River Basin, seven hydroelectric projects, Washington. Federal Energy Regulatory Commission, Washington, D.C. FERC/FEIS-0042.

Federal Energy Regulatory Commission (FERC). 1987. Salmon River Basin, fifteen hydroelectric projects, Idaho. Federal Energy Regulatory Commission, Washington, D.C. FERC/FEIS-0044.

Irving, J.S. and M.B. Bain. 1993. Assessing Cumulative Impact on Fish and Wildlife in the Salmon River Basin, Idaho. In S.G. Hildebrand and J.B. Cannon. eds. *Environmental Analysis: The NEPA Experience*. Lewis Publishers, Boca Raton, FL. pp. 357-372.

LaGory, K.E., E.A. Stull, and W.S. Vinikour. 1993. Proposed methodology to assess cumulative impacts of hydroelectric development in the Columbia River Basin. Pp. 408-423 in S.G. Hildebrand and J.B. Cannon, eds. *Environmental Analysis: the NEPA Experience*. Lewis Publishers, Boca Raton, FL.

Leopold, L.B., F.E. Clarke, B.B. Hanshaw, and J.R. Balsley. 1971. A Procedure for Evaluating Environmental Impact. Circular 645. U.S. Geological Survey. 13 pp.

Russo, T.N. 1985. Perspectives on analyzing impacts related to multiple hydroelectric development. Pp 346-350 in F.W. Olson, R.G. White, and R.H. Hamre (eds), *Proceedings of the Symposium on Small Hydropower and Fisheries*, American Fisheries Society, Bethesda, MD.

Stull, E.A., K.E. LaGory, and W.S. Vinikour. 1987. Methodologies for assessing the cumulative environmental effects of hydroelectric development on fish and wildlife in the Columbia River Basin – Volume 2: Example and procedural guidelines. Final report to Bonneville Power Administration, Portland, OR. DOE/BP-19461-4.

U.S. Fish and Wildlife Service. 1980. Habitat evaluation procedures. ESM 102. U.S. Fish and Wildlife Service, Division of Ecological Services, Washington, D.C.

4

NETWORKS AND SYSTEM DIAGRAMS

Networks and system diagrams relate the components of an environmental or social system in a chain (network) or web (loop or system diagram) of causality and allow the user to trace cause and effect through a series of potential links. They allow the user to analyze the multiple, subsidiary effects of various actions and trace indirect effects on resources stemming from direct effects on other resources. In this way, the accumulation of multiple effects on individual resources, ecosystems, and human communities can be determined. *Networks and system diagrams are often the analyst's best method for identifying the cause-and-effect relationships that result in cumulative effects.*

Networks, loops, and system diagrams improve on the stepped matrix approach to illustrating the relationship among actions, effects, and environmental or socioeconomic conditions by using component boxes (or symbols) and linkage arrows (denoting processes). Networks and system diagrams concisely illustrate interactions among variables and secondary effects. Cumulative effects are identified whenever multiple sources affect the same resource, or when multiple effects of the same source affect a resource (via indirect pathways through other resource components). When quantitative measures are included, effects and their interactions can be evaluated using a common unit of measurement (usually energy flow). The use of a common scale distinguishes networks and system diagrams from other cumulative effects analysis methods but requires evaluating different classes of effects separately (e.g., ecological versus social impacts).

By definition, network analysis proceeds in only one direction (forward), whereas loops or system diagrams allow feedback of information output by one part of the system to any other part of the system. Networks also assume a strict hierarchical linkage among system variables and are thus not capable of showing all relationships among variables. In contrast, system diagrams are specifically designed to illustrate the interrelationships (and process pathways) among all components and thus are more realistic. The lack of an appropriate unit of measure for all system compartments can limit the analyst's ability to quantify system diagrams, but some success has been obtained by using the flow of water or energy flow as common units of measure (Gilliland and Risser 1977).

Expert systems can be used to implement network analysis. Expert systems are simply sets of logical rules that mirror the analysis process of an expert in some field. To identify cumulative effects, an expert system would (1) query the analyst about additional activities that might affect the resource in question and (2) carry the predicted effects through known causal links to reveal additional secondary effects on each resource. The line of questioning will take different courses, depending on the user's answers to questions along the way. The program used to work its way through the questions and answers is called an inference engine.

METHODS

4 EXAMPLES:

Since the introduction of network analysis for impact assessment by Sorensen (1971), networks and systems diagrams have been useful for describing cause-and-effect relationships in both natural and human-dominated systems. Figure A-2 illustrates how cumulative effects on socioeconomic conditions can be identified. The figure (modified from Rau and Wooten 1985) shows how the removal of both homes and businesses (following freeway construction) cumulatively results in an increase in property tax rate at the tetryary level of effects. A comprehensive network (Figure A-3) illustrating all causes, perturbations, primary effects, and secondary effects related to coastal zone development was prepared for the

Australian (Commonwealth) Environmental Protection Agency (1994).

An example of the case of a single activity resulting in cumulative effects on a single resource through indirect effects is illustrated in Figure A-4 (Bisset 1983). This system diagram shows damage to fish spawning resulting from aerial application of herbicides through five different pathways resulting in low dissolved oxygen and high sediment stress. Low dissolved oxygen is caused by decreased plankton growth and increased oxygen consumption from debris pollution and erosion; increased sediment is also caused by debris pollution and increased erosion following the loss of riparian vegetation.

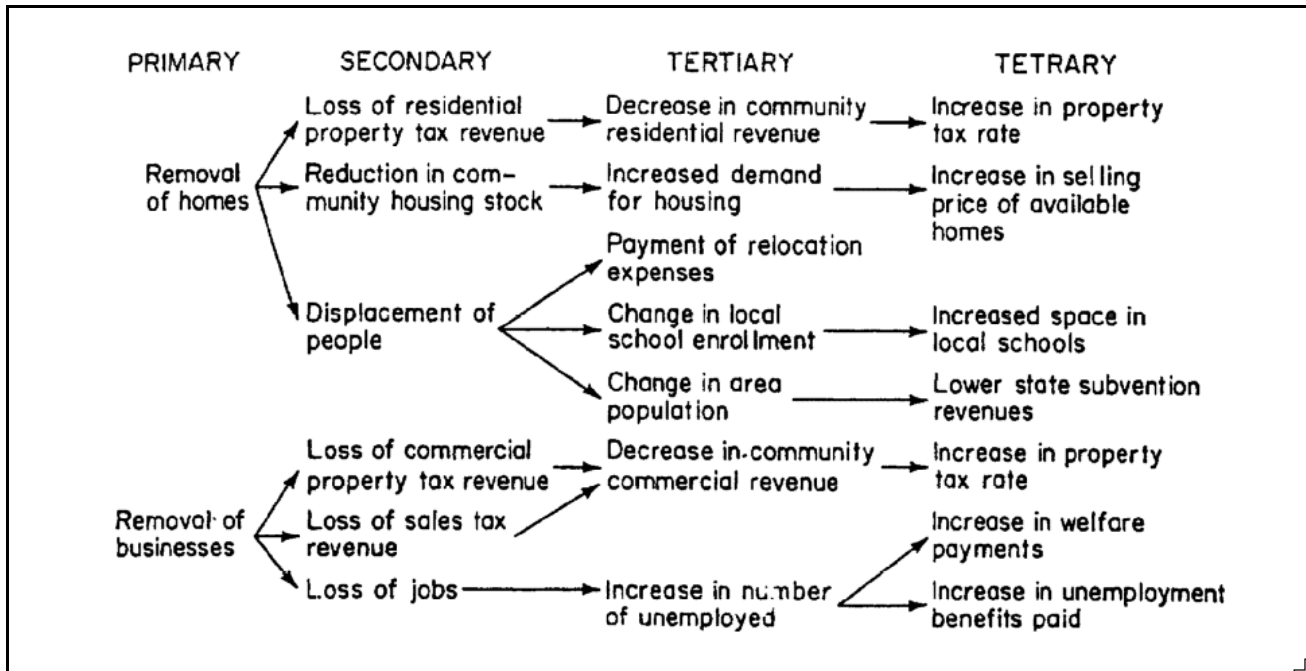

Figure A-2. Example of an "impact tree" for new freeway construction in an established downtown business district (modified from Rau and Wooten 1985)

METHODS

ALL CAUSES

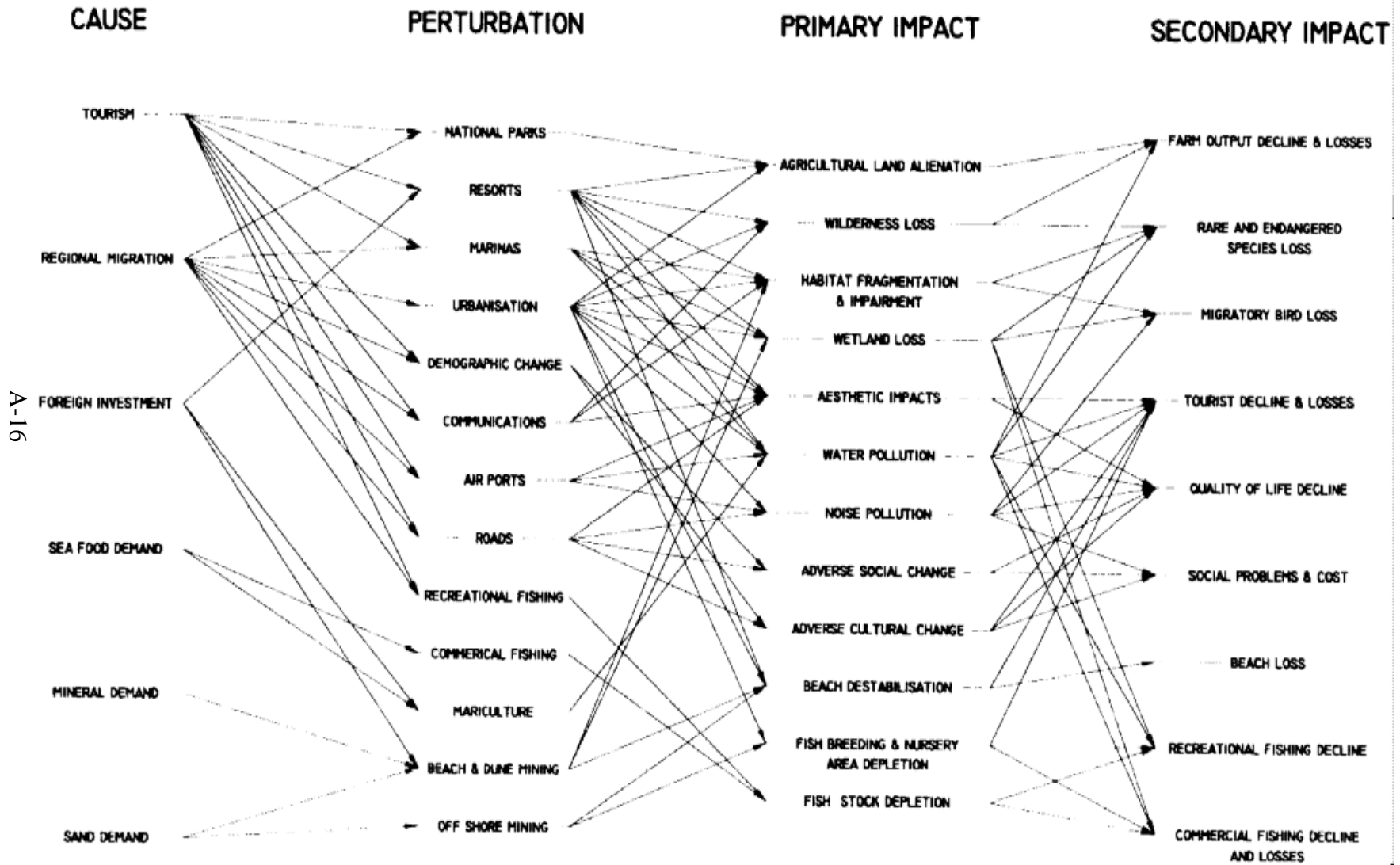

Figure A-3. A specific cause-and-effect network for coastal zone development cumulative impacts in Australia [Australian (Commonwealth) Environmental Protection Agency 1994]

A-16

METHODS

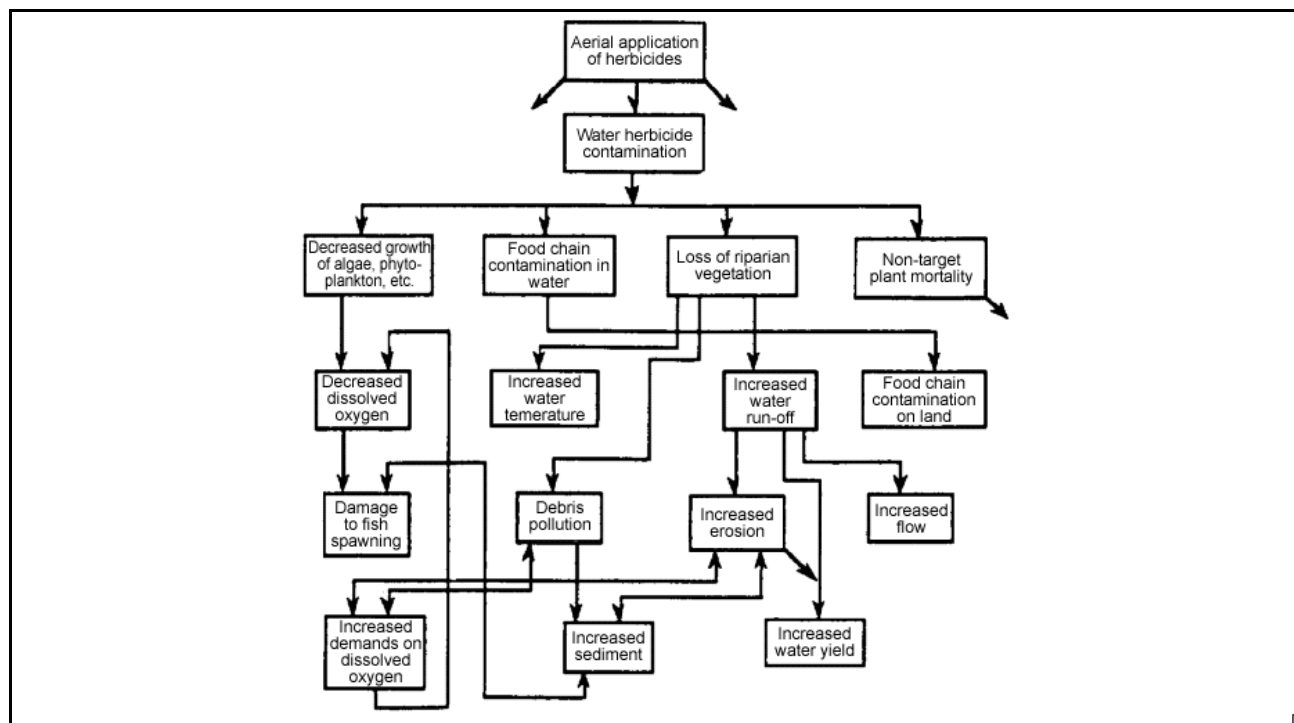

Figure A-4. System diagram showing cumulative indirect effects of aerial application of herbicide on an aquatic system (Bisset 1983).

As part of the Chesapeake Bay Restoration Plan, a cause-and-effect network analysis was conducted during a workshop charged with analyzing cumulative effects on the Bay (Williamson et al. 1987). This approach led the workshop away from focusing on development actions (near the start of the causal chains) or fish and wildlife species (near the end of the effect chains) to focusing on habitats as the hub of the cause-and-effect relationships contributing to cumulative effects on the Bay's living resources. This network analysis was instrumental in focusing the cumulative effects analysis on the appropriate ecological goals and remedial actions needed (Williamson 1993).

References

- Australian (Commonwealth) Environmental Protection Agency. 1994. Assessment of Cumulative Impacts and Strategic Assessment in Environmental Impact Assessment. Consultancy Report. May.
- Bisset, R. 1983. Methods for environmental impact analysis: recent trends and future prospects. *Journal of Environmental Management* 11:27-43.
- Gilliland, M.W. and P.G. Risser. 1977. The use of systems diagrams for environmental impact assessment. *Ecological Modelling* 3:188-209.
- Rau, J.G. and D.C. Wooten, eds. 1985. *Environmental Impact Analysis Handbook*. McGraw-Hill, New York.

METHODS

Sorensen, J.C. 1971. *A Framework of Identification and Control of Resource Degradation and Conflict in the Multiple Use of the Coastal Zone*. University of California, Berkeley, CA.

Williamson, S.C. 1993. Cumulative impacts assessment and management planning: Lessons Learned to Date. In: S.G. Hildebrand and J.B. Cannon (eds). *Environmental Analysis: the NEPA Experience*. Lewis Publishers, Boca Raton, FL. pp. 391-407.

Williamson, S.C., C.L. Armour, G.W. Kinser, S.L. Funderburk, and T.N. Hall. 1987. Cumulative impacts assessment: An application to Chesapeake Bay. *Transactions of the North American Wildlife and Natural Resources Conference* 52:377-388.

5 MODELING

Modeling is a powerful technique for *quantifying the cause-and-effect relationships leading to cumulative effects*. Modeling can take the form of mathematical equations describing cumulative processes such as soil erosion, or it may constitute an expert system that computes the effect of various project scenarios based on a program of logical decisions. Modeling is also used in socioeconomic analyses, ranging from macroeconomic models to community-level demographics (see Methods 10 and 11).

Developing project-specific models requires substantial resources and time. For this reason, cumulative effects analysis will most often use or modify existing models. The lack of baseline data or project-specific data can also limit the use of sophisticated models. Nonetheless, modeling holds considerable promise for analyzing cumulative effects. In general, the use of models requires that an agency invest in (1) developing a given model or technique, or (2) obtaining baseline data for use in an existing model. The short-term investment usually reaps long-term benefits in analyzing cumulative effects. In some cases, the analyst may find a direct match between the model and the application to existing data. Examples where

cumulative effects are routinely modeled include the following:

- Air dispersion models
- Hydrologic regime models
- Oxygen sag models
- Soil erosion models
- Sediment transport models
- Species habitat models
- Regional economic models.

Models that are easily defended and generally recognized in the scientific community should be used. Thus, general models form the basis for most practical work under NEPA, whereas more sophisticated models are often used on a case-by-case basis. Rarely are models used to combine and evaluate cumulative effects of the proposed and other actions. Tables and matrices provide a more straightforward means of displaying alternatives and their cumulative effects on individual resources. Nonetheless, it is possible to develop an evaluative model that assigns resources to compartments and quantifies effects and relationships mathematically. Generally, the assumptions required by this approach are many, and the likelihood of public understanding and acceptance is low.

METHODS

5 EXAMPLES:

Concern for air quality has produced sophisticated air models that track local and regional emissions and estimate ambient (cumulative) pollutant concentrations. The original bubble concept in air pollution control was predicated on limiting the cumulative emissions at a site or region while allowing flexibility in the amount released by individual sources. Figure A-5 displays projected NO₂ concentration isopleths for the cumulative effects of an existing power plant and the proposed addition of a second generating unit in Healy, Alaska. This kind of model output can be combined with map overlay techniques to reveal potential adverse effects on mapped resources.

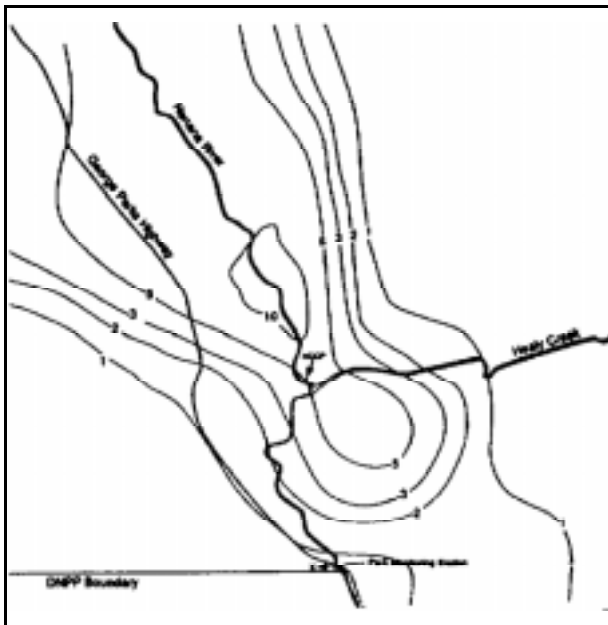

Figure A-5. Projected NO₂ concentration isopleths for combined HCCP and Unit 1 emissions, Healy, AK (Department of Energy 1993)

Water quality-based modeling is another approach to addressing cumulative effects of multiple discharges. Specifically, the cumulative effect of pollutant discharges into a waterbody can be determined through the wasteload allocation procedure under the National Pollution Discharge Elimination System (NPDES) permit process. The wasteload allocation uses a simple equation to incorporate receiving water dilution, background concentrations of pollutants, numeric water quality criteria or whole effluent toxicity information, and effluent volume for discharges into the stream of concern.

$$\text{waste load allocation} = \frac{[\text{WQC} (Q_s + Q_e) - (Q_s C_s)]}{Q_e}$$

- WQC = water quality criteria
- Q_s = upstream flow
- Q_e = effluent flow
- C_s = upstream concentration in toxic units

This wasteload allocation model sets the discharge limit so that the cumulative effect does not result in chronic toxicity to the aquatic biota of the stream. The most commonly used schemes for allocating waste loads among discharges are equal percent removal, equal effluent concentrations, and a hybrid method (where the criteria for waste reduction may not be the same for each point source).

Concerns over potential cumulative effects on aquatic resources resulting from decreases in dissolved oxygen (DO) concentrations prompted the Federal Energy Regulatory Commission (FERC) to model the DO in river reaches encompassing 19 potential hydroelectric generation sites in the Upper Ohio River Basin (FERC 1988). Although it is well known that introducing hydropower projects will affect DO

METHODS

concentrations by changing the amount of aeration that takes place at existing dams (from spillage over the dam), the cumulative effect on individual river reaches could only be determined by developing a simulation model (Figure A-6). This model first determined the amount of aeration provided by the dams, and then determined the change in DO caused by installing hydropower facilities. The amount of DO provided by dams was quantified by fitting field data to a statistical model. Then a mathematical model based on known biochemical oxygen demand (BOD) and hydraulic characteristics was developed to determine how changes in aeration at each dam where hydropower was proposed would affect DO concentrations over the entire study area. Ultimately, the effects of proposed hydropower projects on DO concentrations were analyzed under appropriate flow conditions, and the cumulative effects of different alternatives (combinations of projects) on target resources were defined.

The cumulative effects on species of concern can be modeled by quantifying specific mortality factors (e.g., entrainment of migrating species in the turbines of multiple hydropower facilities) or loss of suitable habitat. The cumulative effects of micro-hydro development on the fisheries of the Swan River drainage in Montana was modeled using the bull trout as the primary species of concern (Leathe and Enk 1985). A land-type-based watershed model was used to estimate future cumulative sediment loads resulting from a combination of forest management and micro-hydro development scenarios. The relationship of sediment load to substrate quality was determined and the substrate quality score was correlated with the number of bull trout. Based on these models, the cumulative effect on fisheries from scenarios containing 4 to 20 micro-hydro projects was estimated. Within the drainage, a 7% reduction in juvenile bull trout abundance was attributed to forest road construction; 13% to 24% losses were predicted for micro-hydro project development.

Truett et al. (1994) concluded that the best approach for assessing the cumulative effects on

wildlife is to focus on the habitat factors that control the distributions and abundances of

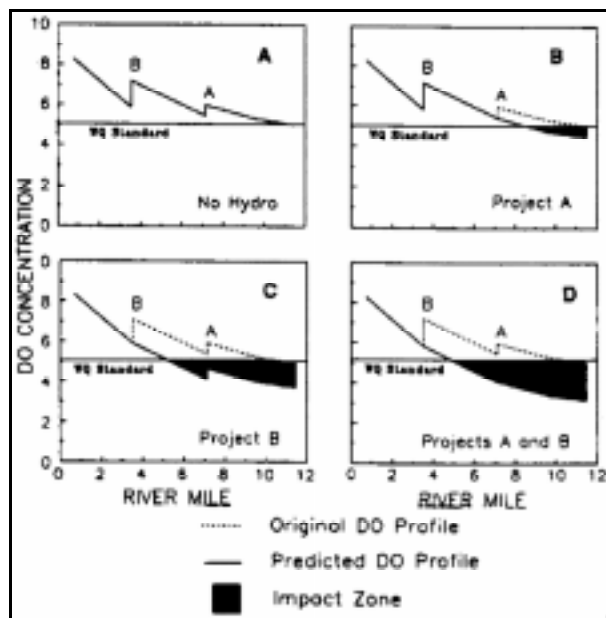

Figure A-6. Cumulative effects on dissolved oxygen caused by hydroelectric development, reduced spillages, and reduced aeration at dams (FERC 1988)

wildlife populations. The most commonly used models of resource-habitat relationships are the Habitat Evaluation Procedures (HEP; U.S. Fish and Wildlife Service 1980) and Instream Flow Incremental Methodology (IFIM; Armour et al. 1984) developed by the U.S. Fish and Wildlife Service. HEP uses Habitat Suitability Index (HSI) models to provide estimates of habitat quality (Schamberger et al. 1982; Hayes 1989). An HSI is developed for each species by aggregating functional values for specific habitat parameters known to support the species of interest. HSI models have also been developed for a few animal communities such as those found in shelterbelts (Schroeder 1986). The cumulative effect of multiple activities on a species can be determined by estimating the number of habitat units (combined HSIs for each habitat available to the species) affected in the area. HEP and IFIM models provide a common currency (habitat suitability) that can be debited by a wide variety of cumulative effects.

METHODS

Models are routinely used to assess regional economic effects. When the need to include socioeconomic considerations in NEPA analyses arose, the U.S. Army developed the Economic Impact Forecast System (EIFS) as a model that (1) was based in sound theory, (2) was accepted by the scientific community, and (3) could use readily available data. EIFS is discussed in more detail in the section on Economic Impact Analysis (Method 10).

Although the primary use of models in cumulative effects analysis is to quantify cause-and-effect relationships, optimization and simulation modeling can be used to evaluate among alternatives or against a predefined set of goals. Optimization methods (such as linear programming) address cumulative effects by explicitly incorporating multiple resources and seeking an optimum level for each resource relative to project objectives. Methods range from simple algebraic equations that are solved for variables of set ranges to complex versions including nonlinear functions, layers of optimizations, probabilities, and stochastic variables (Stull et al. 1987). Grygier and Stedinger (1985) used this technique to optimize energy production under the constraints of other goals including water supply, minimum flows, and reservoir levels. Simulation enables the practitioner to model an environmental or socioeconomic system, and simulate the effects of various actions on the system (as described by functional interactions among system components) over time and space. This is the most difficult of cumulative effects analysis methods, yet potentially most rewarding because it is capable of producing most nearly what a practitioner would want—a decisionmaking tool.

References

- Armour, C.L., R.J. Fisher, and J.W. Terrell. 1984. Comparison of the Use of the Habitat Evaluation Procedures (HEP) and the Instream Flow Incremental Methodology (IFIM) in Aquatic Analyses. U.S. Fish and Wildlife Service, Western Energy and Land Use Team, Fort Collins, CO. FWS/OBS-84/11.
- Federal Energy Regulatory Commission (FERC). 1988. Final Environmental Impact Statement. Hydroelectric Development in the Upper Ohio River Basin. Ohio, Pennsylvania, West Virginia. FERC Docket No. EL85-19-114. Federal Energy Regulatory Commission, Office of Hydropower Licensing. Washington, DC. September. FERC/FEIS-0051.
- Grygier, J.C. and J.R. Stedinger. 1985. Algorithms for optimizing hydropower development. *Water Resources Research* 16:14-20.
- Hayes, R.L. 1989. Micro-HSI master model library., cover type list and variable lexicon. Reference Manual v 2.1. U.S. Fish and Wildlife Service, Fort Collins, CO.
- Leathe, S.A. and M.D. Enk. 1985. Cumulative Effects of Micro-Hydro Development on the Fisheries of the Swan River Drainage, Montana. I: Summary Report. Prepared for the Bonneville Power Administration., Portland, OR. 114 pp. + appendices.
- Schamberger, M., A.H. Farmer, and J.W. Terrell. 1982. Habitat Suitability Index Models: Introduction. U.S. Fish and Wildlife Service, Washington, DC.
- Schroeder, R.L. 1986. Habitat Suitability Index Models: Wildlife Species Richness in Shelterbelts. Biological Report 82(10.128). U.S. Fish and Wildlife Service, Washington, DC. 17 pp.

METHODS

Stull, E.A., K.E. LaGory, and W.S. Vinikour. 1987. Methodologies for assessing the cumulative environmental effects of hydroelectric development on fish and wildlife in the Columbia River Basin – Volume 2: Example and procedural guidelines. Final report to Bonneville Power Administration, Portland, OR. DOE/BP-19461-4.

Truett, J.C., H.L. Short, and S.C. Williamson. 1994. Ecological impact assessment. In: T.A. Bookhout, ed. *Research and Management Techniques For Wildlife and Habitats*. The Wildlife Society, Bethesda, MD pp. 607-622.

U.S. Department of Energy. 1993. Final Environmental Impact Statement for the Proposed Healy Clean Coal Project. DOE/EIS-0186.

U.S. Fish and Wildlife Service. 1980. Habitat Evaluation Procedures. ESM 102. U.S. Fish and Wildlife Service, Division of Ecological Services, Washington, DC.

6

TRENDS ANALYSIS

Trends analysis assesses the status of resources, ecosystems, and human communities over time and usually results in the graphical projection of past or future conditions. Changes in the occurrence or intensity of stress over time can also be determined. Trends analysis *provides the historical context that is critical to assessing the cumulative effects of proposed actions*. Specifically, trends analysis can assist the cumulative effects analyst by

- **Identifying cumulative effects problems.** When trends analysis demonstrates that a substantial amount of a resource has been lost, it usually reveals a cumulative effects problem that may be exacerbated by additional actions. For example, historical declines in a fishery resource may indicate that the fishery is near the threshold of population collapse.
- **Establishing appropriate environmental baselines.** When data on the current state of a resource are lacking (or too variable), trends data can be used to describe the existing condition. Trends information can also be used to develop historical baselines or regional goals against which to evaluate restoration efforts.
- **Projecting future cumulative effects.** Trends analysis can identify historical cause-and-effect relationships

between stresses and resources or ecosystems. Common cumulative effects relationships can be used to predict future effects whenever the environmental conditions are similar. Historical trends may also reveal threshold points where cumulative effects become significant or qualitatively different.

By documenting the cumulative effects on the condition of resources over time, trends analyses have been used as planners to assist with the orderly development of communities (by charting the course of economic development), and by wildlife managers to develop appropriate harvest guidelines (by recording populations trends in species). Changes in the condition of resources or ecosystems can be illustrated in both simple and complex forms. A simple trends analysis might produce a line graph showing decreasing numbers of animals from annual surveys. Changes in habitat pattern might be illustrated with a series of figures, or in a 3-dimensional graphic where the amount of change is portrayed on the vertical axis. Video simulations can be used to show complex changes in geographic or aesthetic resources. Time-series information from aerial photographs or satellite imagery are increasingly available for trends analysis across the United States.

METHODS

6 EXAMPLES:

Trends identified from long-term data sets greatly enhance the evaluation of cumulative effects analyses on individual species. For example, the U.S. Fish and Wildlife Service's Breeding Bird Survey (BBS) has identified declining bird populations that may be at greater risk from future cumulative effects (Robbins et al. 1986). As is the case with most long-term records, data gaps in the BBS require

using advanced statistical methods to ensure accurate interpretation of trends. In this case, proportional trends for each survey route were estimated and then weighted to account for areal and data influences (Figure A-7). Trends analyses of bird surveys have identified a number of species with substantial declines in numbers, including many migratory songbirds (Atkins et al. 1990; Terborgh 1992).

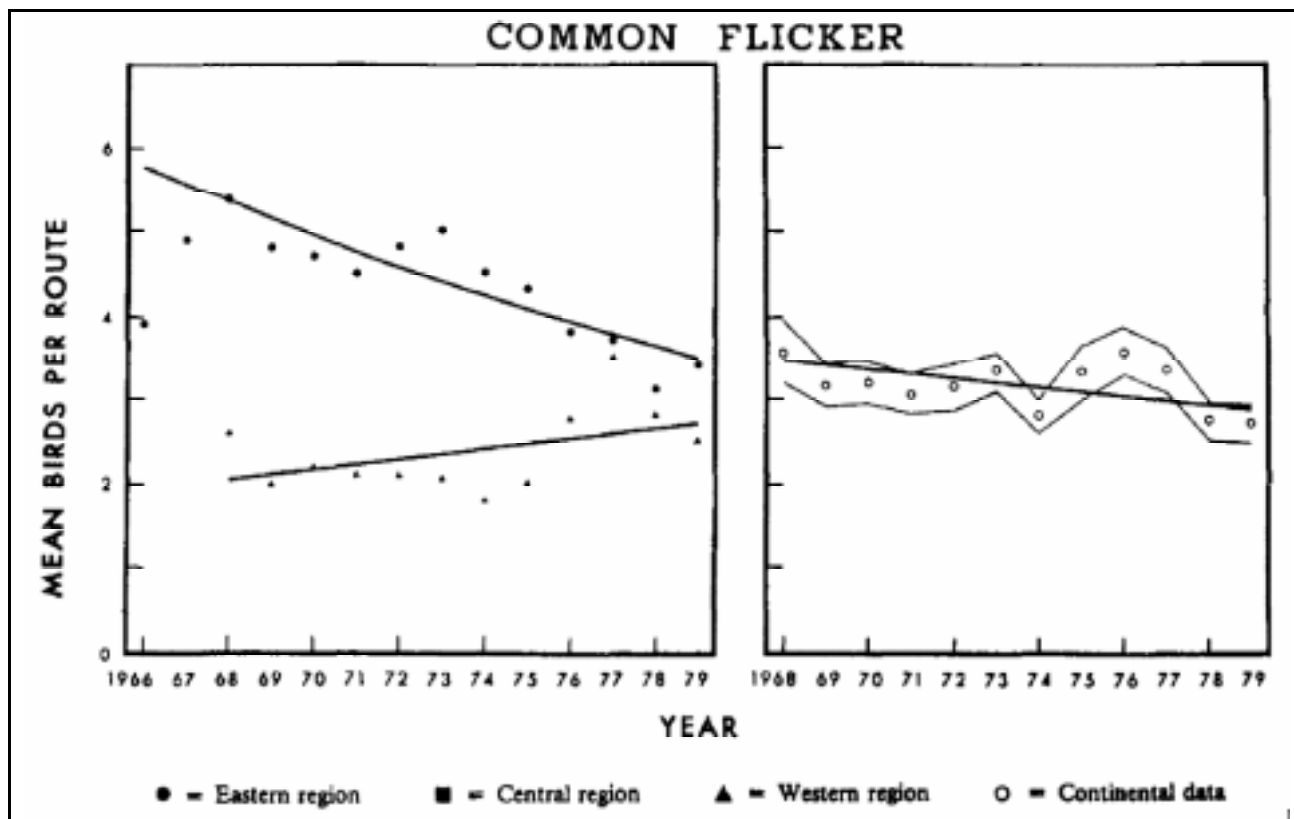

Figure A-7. Common flicker population trends (Robbins et al. 1986)

METHODS

Trends in the abundance and distribution of habitats are one of the most important indicators of cumulative effects problems. Figure A-8 dramatically illustrates the trend toward fragmentation of forested areas in Wisconsin (Curtis 1956 cited in Terborgh 1989). A recent study by the U.S. Army Corps of Engineers, in cooperation with U.S. EPA, Fish and Wildlife Service, and NOAA (1993), addressed historical trends in special aquatic habitats of Commencement Bay, WA, resulting from numerous dredge and fill activities since 1877. To address changes over 140 years, the trends analysis study combined historical literature with the photographic record. The use of remotely sensed photographic imagery allowed analysts to combine measures of the areal extent of spoil disposal with written information on the volume of material dredged, and produced a dramatic illustration of downward trends in the area of both intertidal mudflats and marshes (Table A-2).

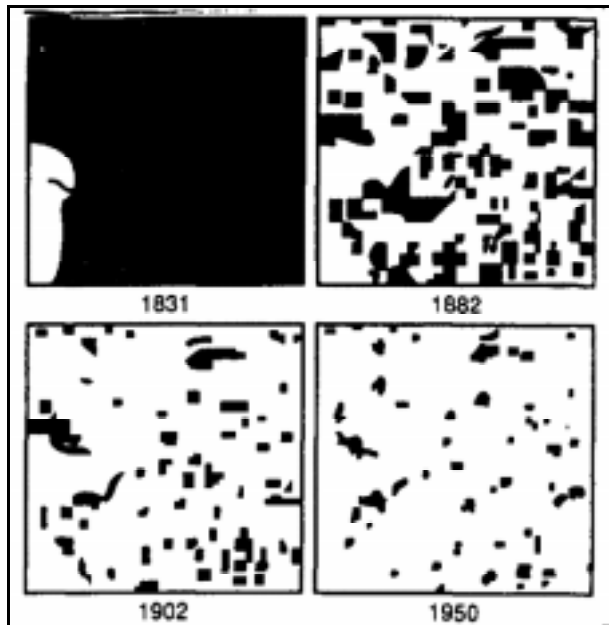

Figure A-8. Cadiz township forest fragmentation (Curtis 1956 cited in Terborgh 1989)

Many other examples of historical losses of wetlands have been reported by the U.S. Fish and Wildlife Service's National Wetlands Inventory (NWI; Dahl et al. 1991). In addition to identifying (and quantifying) this cumulative effects problem, the NWI trends analysis has produced statistics (such as the remaining acreage of different wetlands types) that can be used to predict thresholds where future wetlands losses will likely affect watershed functioning. The "synoptic approach" to cumulative effects analysis developed by the U.S. EPA Environmental Research Laboratory in Corvallis (Leibowitz et al. 1992) proposes to use this information as a quantitative means of comparing wetlands losses among watersheds and determining where future wetland losses will have the greatest effect.

Trends analysis can also be used to construct the environmental baseline for cumulative effects analysis when adequate data on the state of a resource are lacking or are too variable. For example, sediment cores drawn from lakes or estuaries can often be used to obtain a more accurate picture of the state of contamination than can standard sediment samples. Landings of commercial fish species are notoriously variable, but historical trends can identify appropriate baseline population levels as targets for restoration efforts.

Trends analysis in land disturbance have also been used to estimate future cumulative effects based on the causal relationship between land use and resource degradation. Time-series data and aerial photos illustrating trends in land disturbance in Elkhorn Slough, CA, over a 50-year period were used to predict the effect of future residential development (Dickert and Tuttle 1985). In addition, the trends analysis produced a historical trends target that was deemed acceptable for final buildout of the area.

METHODS

**Table A-2. Habitat loss by historic period in Commencement Bay, WA
(modified from USACE 1993)**

Historic Period	Habitat Type	Historical Records of Lost Habitat	Total Lost Habitat (includes historical records and photographic evidence)	Acres Remaining
1877 - 1894	mudflat	11	0	2,074
	marsh	20	0	3,874
1894 - 1907	mudflat	208	605	1,469
	marsh	41	415	3,459
1907 - 1917	mudflat	51	542	927
	marsh	35	64	3,395
1917 - 1927	mudflat	48	162	765
	marsh	0	72	3,320
1927 - 1941	mudflat	143	133	632
	marsh	399	1,676	1,44
1941 - Present	mudflat	105	412	187
	marsh	1,557	1,587	57
TOTALS	mudflat	566	1,54	
	marsh	1,052	3,814	

References

- Askins, R.A., J.F. Lynch, and R. Greenberg. 1990. Population declines in migratory birds in eastern North America. *Current Ornithology* 7:1-57.
- Curtis, J.T. 1956. The modification of mid-latitude grasslands and forests by man. In *Man's Role in Changing the Face of the Earth*, edited by W.L. Thomas, 721-736. University of Chicago Press, IL.
- Dahl, T.E., C.E. Johnson, and W.E. Frayer. 1991. Wetlands: Status and Trends in the Conterminous United States Mid-1970's to Mid-1980's. U.S. Department of the Interior, Fish and Wildlife Service, Washington, DC. 28 pp.
- Dickert, T.G. and A.E. Tuttle. 1985. Cumulative impact assessment in environmental planning: A coastal wetland watershed example. *Environmental Impact Assessment Review* 5:37-64.
- Leibowitz, S.G., B. Abbruzzese, P. Adamus, L. Hughes, and J. Irish. 1992. A Synoptic Approach to Cumulative Impact Assessment—A Proposed Methodology. U.S. Environmental Protection Agency, Environmental Research Laboratory, Corvallis, OR. EPA/600/R-92/167.
- Robbins, C.S., D. Bystrak, P.H. Geissler. 1986. The Breeding Bird Survey: Its First Fifteen Years, 1965-1979. USDOI, Fish and Wildlife Service, Resource Publication 157. Washington, DC.
- Terborgh, J. 1989. *Where Have All the Birds Gone?* Princeton University Press, NJ. 207 pp.
- Terborgh, J. 1992. Why American Songbirds are Vanishing. *Scientific American* 266(5):98-104.
- U.S. Army Corps of Engineers (USACE)A, U.S. Fish and Wildlife Service, and NOAA. 1993. Commencement Bay Cumulative Impact Study. Vol. I Assessment of Impacts. U.S. Army Corps of Engineers, Seattle, WA. May/June.

7

OVERLAY MAPPING AND GIS

Overlay mapping and geographic information systems (GIS) incorporate locational information into cumulative effects analysis. Simple mapping characterizes the spatial aspects of resources, ecosystems, and human communities and helps set the boundaries of the analysis. Overlay mapping can directly evaluate cumulative effects by identifying areas where effects will be the greatest. Mapping and GIS can also address concerns, such as landscape connectivity, that are difficult, if not impossible, to address with other methods. Map overlays *are extremely useful for any form of visual representation.*

The most direct use of overlay mapping for analyzing cumulative effects is "impact-oriented," wherein a composite cumulative effects map is produced by overlaying individual effects from different actions. Examples include the combined effects of both air deposition and water discharge of contaminants to a river, as well as the cumulative effects of multiple land uses in a forested watershed. The more common map overlay approach, however, combines thematic maps of different landscape features to rate areas or resources as to their suitability for development or risk from degradation. In this "resource-oriented" approach, cumulative effects in specific areas can be compared to land suitability determinations (resource or ecosystem thresholds) for those areas. The result is a suitability map that combines development opportunities and environmental and socioeconomic constraints (e.g., both endangered species habitats and public transportation routes) to

disturbance or the areas where disturbance will have the greatest consequences (e.g., those that

identify parcels suited to each activity type (McHarg 1969).

Resource-oriented overlay mapping supports the planning approach to cumulative effects analysis and is often called resource capability analysis. Resource capability analysis can be used to optimize the integration of a site's natural and cultural features with various site design elements (Rubenstein 1987), or to minimize wastefulness in resource utilization (McKenzie 1975). Resource capability analysis uses opportunity, constraint, and suitability maps (Rubenstein 1987). Opportunity maps generally depict conditions related to factors such as soil types or topographic slopes that are suitable for development; constraint maps depict areas that for various reasons, such as the presence of wetlands, floodplains, or cultural resources, are not conducive to development. The land suitability map combines the information in the opportunity and constraints maps to identify those areas best suited for the activities planned.

Suitability ratings can be used to express the responses of resources, ecosystems, and human communities in the absence of more sophisticated quantitative cause-and-effect models (Contant and Wiggins 1993). Where these suitability ratings are based on thresholds above which effects exceed the capacity of the affected resources to sustain themselves, the evaluation is equivalent to carrying capacity analysis. Resource-oriented overlay mapping usually identifies the areas most sensitive to

are most valued or have endured the greatest past losses).

METHODS

Overlay maps and land suitability maps have rapidly evolved from handmade transparencies to GIS-based computer overlays (for potential problems see Bailey 1988). In the simplest case, map layers are hand drawn on transparent sheets and then overlain. Each sheet represents a single map layer containing a certain type of information. Within each sheet (or overlay), the importance (or weight) assigned to different data categories is represented by the degree of shading used. The shading seen when all map overlays are stacked atop each other reveals graphically the overall suitability of different areas within the mapped region for the

user-defined purpose. In the effect-oriented approach, darker shading may be used to identify areas subject to the greatest cumulative effects (from multiple actions).

Using a GIS to implement overlay mapping allows the analyst to electronically overlay natural and cultural features and produce composite maps quickly (Johnson et al. 1988). In some cases, GIS maps are derived directly from satellite images using land cover interpretation algorithms. Like the user of the manual transparent map overlay technique, the GIS user can develop weighted functions to assign numeric weights to each map area (or groupings of grid cells) within a map layer. Such weights might be determined by an expert in the field, or based on a statistical classification drawn from field measurements.

METHODS

7 EXAMPLES:

Examples of the use of overlay mapping and GIS to analyze cumulative effects include both the effect-oriented approach (e.g., where two or more contaminant sources are mapped over a single resource) and the resource-oriented approach (e.g., where the map overlays are used to characterize land areas in terms of their suitability for development). The former approach is typified by GIS-based groundwater analyses where multiple plumes of contaminated water are overlain on the aquifer of interest to determine the cumulative effects. Many other resources and ecosystems have important geographical characteristics that must be considered in analyzing cumulative effects. For example, overlay mapping can reveal the cumulative fragmentation of a spatially contiguous forest (critical to many migratory songbirds) from activities such as road and building construction. In the Corridor Selection Supplemental Draft EIS for the construction of the Appalachian Corridor H highway near Elkins, West Virginia (West Virginia DOT 1992), GIS map overlays produced estimates of the amount of forest fragmentation, reduction in core forest area, and spatial contact of construction with remote habitat areas.

The resource-oriented overlay mapping approach is commonly used to select the preferred development option (e.g., the right-of-way route that minimizes cumulative effects on resources, ecosystems, and human communities). In his classic *Design With Nature*, Ian McHarg (1969) described the use of map overlays for planning coastal island development, highways, open space in Philadelphia, suburban growth near Baltimore, land use on Staten Island, and regional development around metropolitan Washington, D.C. In the highway development example, he used overlay mapping to determine

a "minimum-social-cost alignment" to replace the originally proposed highway corridor.

Master plans often use resource capability analysis to address the cumulative effects of multiple actions. The resources to be included in the capability analysis depend on the activities being undertaken, and analyses range from comprehensive assessments of all physical, biological, and socioeconomic factors in a regional planning area to limited analyses of the potential for sediment runoff related to the slope, soil, and permeability of a given plot of land. For example, overlays of a site's topographic features (e.g., geology, soils, slope, and vegetation) can be used to designate areas where construction will not contribute to cumulative runoff problems (i.e., soils with low erosion potential). Overlay mapping is also critical to planning conflicting land uses, such as combat training activities and natural resource conservation on military installations. The intersection of impact areas (e.g., aircraft flight corridors, tank maneuvers, large weapon firing areas, ordinance impact areas) and sensitive environments (e.g., wildlife refuges and endangered species habitats) can be determined through overlay mapping as illustrated in Figure A-9 (produced from map archives, Department of the Navy, Naval Air Station Patuxent River, MD, 1996).

Overlay mapping and GIS can also be used to document past cumulative effects and help predict future effects. Walker et al. (1987) used remote sensing data and GIS to evaluate the indirect effects of oil field development in the Prudhoe Bay Oil Field, Alaska. Aerial photographs revealed surface disturbance (flooding

METHODS

and thermokarst) extending beyond the areas directly affected by construction. These unanticipated effects on frozen arctic soils and thaw-lake wetlands constitute an important cumulative effects problem for oil field activities. Overlay mapping of the spatial properties of areas (e.g., vegetation, amount of open water, land and surface form types, and soil type) where these indirect effects were more pronounced can be used to predict future cumulative effects and better plan resource extraction in this fragile ecosystem.

The promise of GIS as a tool for solving cumulative effects problems is evidenced by the rapidly increasing applications of GIS to land management of forests (Sample 1994) and wetlands (Lyon and McCarthy 1995). Jerry Franklin (1994) states that GIS may be the most important technology resource managers have acquired in recent memory. He predicts that GIS will be invaluable in (1) inventory and monitoring, (2) management planning, (3) policy setting, (4) research, and (5) consensual decisionmaking. In a much publicized example, the

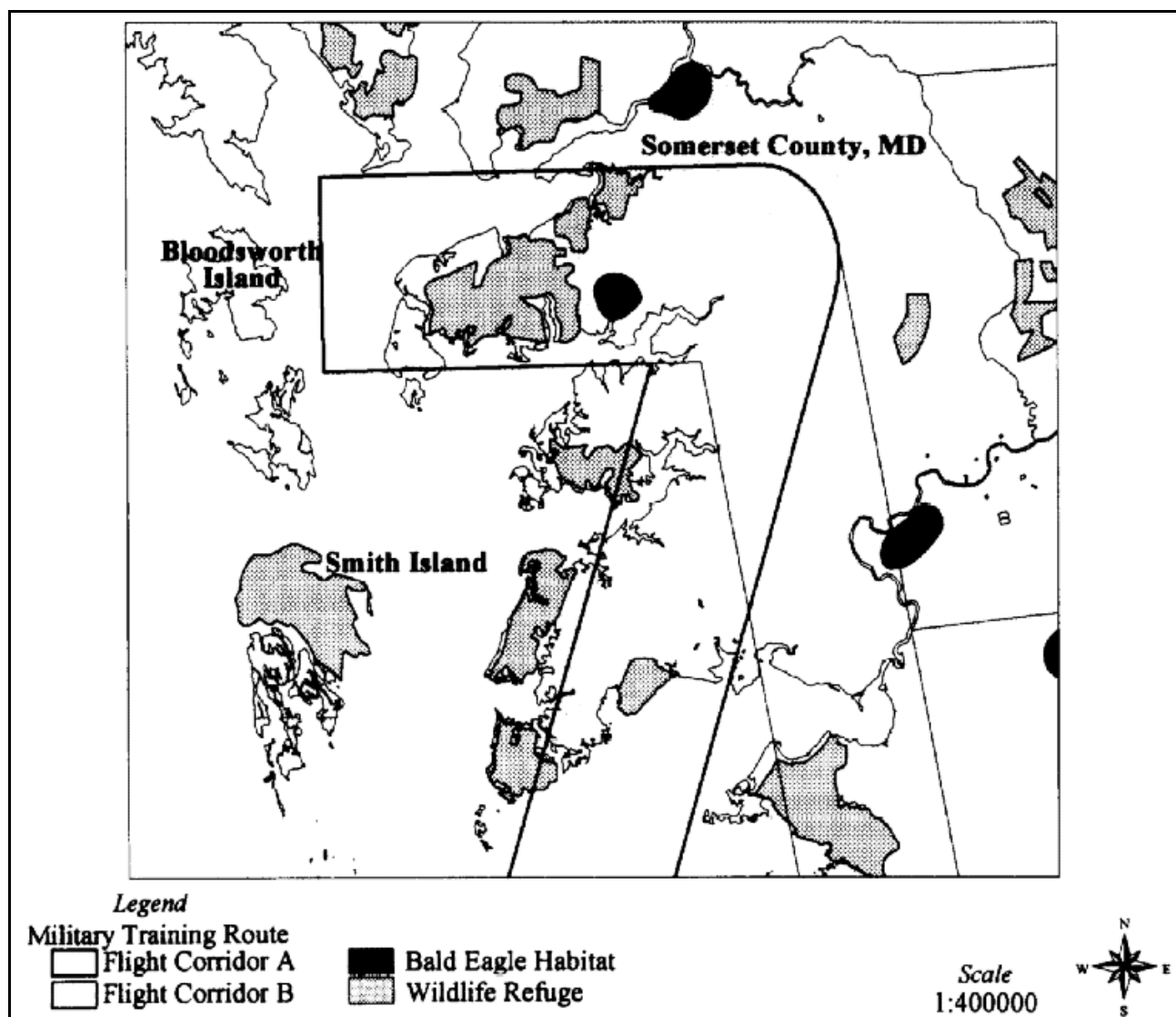

Figure A-9. Hypothetical intersection between aviation flight corridors and environmental resources near a typical U.S. military installation (Department of the Navy 1996)

METHODS

resolution of the Pacific Northwest forest controversy would have been impossible without GIS. Only when GIS was combined with remote sensing information was the actual extent (or lack) of old growth forest determined. Perhaps more importantly, various scientific panels were charged with developing and evaluating alternatives for protecting late-successional forest ecosystems and associated species (e.g., northern spotted owl). Only when an effective GIS capability was developed, was it possible to display and modify the alternatives before decision-makers (including Congressional delegations) so that reasonable consensus could be achieved.

References

- Bailey, R.G. 1988. Problems with overlay mapping for planning and their implications for geographic information systems. *Environmental Management* 12:11-17.
- Contant, C.K. and L.L. Wiggins. 1993. Toward Defining and Assessing Cumulative Impacts: Practical and Theoretical Considerations. In: S.G. Hildebrand and J.B. Cannon. eds. *Environmental Analysis: The NEPA Experience*. Lewis Publishers, Boca Raton, FL. pp. 336-356.
- Department of the Navy. 1996. Hypothetical intersection between aviation flight corridors and environmental resources near a typical U.S. military installation. Map created by the Joint Innovative Interdisciplinary Solutions Team (JIIST) Program Office, Naval Air Station Patuxent River, MD.
- Franklin, J.F. 1994. Developing information essential to policy, planning, and management decision-making: The promise of GIS. In: V.A. Sample, ed. *Remote Sensing and GIS in Ecosystem Management*. Island Press, Washington, DC. pp. 18-24.
- Johnson, C.A., N.E. Detenbeck, J.P. Bonde and G.J. Niemi. 1988. Geographic Information Systems for Cumulative Impact Assessment. *American Society of Photogrammetry and Remote Sensing*. 54(11):1609-1615.
- Lyon, J.G. and J. McCarthy. 1995. *Wetland and Environmental Applications of GIS*. Lewis Publishers, Boca Raton, FL. 368 pp.
- McHarg, I. 1969. *Design with Nature*. Natural History Press, New York, NY. 197 pp.
- McKenzie, G.D. 1975. Physical Environment in Regional Planning. In *Regional Environmental Management*, L.E. Coate and P.A. Bonner eds. John Wiley & Sons, New York, New York, pp 235-244.
- Rubenstein, H.M. 1987. *A Guide to Site and Environmental Planning*. John Wiley & Sons, New York, New York, pp. 7-53.
- Sample, V.A., ed. 1994. *Remote Sensing and GIS in Ecosystem Management*. Island Press, Washington, DC. 369 pp.
- Walker, D.A., P.J. Webber, E.F. Binnian, K.R. Everett, N.D. Lederer, E.A. Nordstrand, and M.D. Walker. 1987. Cumulative impacts of oil fields on northern Alaskan landscapes. *Science* 238:757-761.
- West Virginia Department of Transportation (DOT). 1992. Corridor Selection Supplemental Draft Environmental Impact Statement (SDEIS): Appalachian Corridor H Elkins to Interstate 81. West Virginia DOT, Division of Highways, Charleston, WV.

8

CARRYING CAPACITY ANALYSIS

Carrying capacity analysis derives from the fact that inherent limits, or thresholds, exist for many environmental and socioeconomic systems. Carrying capacity in the ecological context *is defined as the threshold of stress below which populations and ecosystem functions can be sustained*. In the social context, the carrying capacity of a region is the sum of human activities that can be maintained while providing the level of services (including ecological services) desired by the populace. When cumulative effects exceed the carrying capacity of a resource, ecosystem, and human community, the consequences are significant.

As a method for evaluating cumulative effects, carrying capacity analysis serves to identify thresholds for the resources and systems of concern (as constraints on development) and provide mechanisms to monitor the incremental use of unused capacity. Carrying capacity analysis begins with the identification of potentially limiting factors (e.g., the supply of water in a desert riparian ecosystem). Mathematical equations are then developed to describe the capacity of the resource or system in terms of numerical limits (thresholds) imposed by each limiting factor. In this way, projects can be systematically evaluated in terms of their effect on the remaining capacity of limiting factors (Contant and Wiggins 1993).

Carrying capacity analysis can be especially useful for assessing cumulative effects in the following situations:

- Infrastructure and public facilities
- Air and water quality
- Wildlife populations
- Recreational use of natural areas
- Land use planning

The determination of carrying capacity is straightforward for public facilities such as water supply systems, sewage treatment systems, and traffic systems. A reservoir can only supply water to a finite number of consumptive users. In the case of air and water quality control programs, statutory limits (or standards) are regulatory thresholds of the carrying capacity of air or water in the region of interest. Cumulative effects can be estimated through physical and mathematical models and then compared with these standards. Unlike engineered systems, thresholds involving subjective human uses must be based on goal-oriented statements of public opinion and can only be obtained through opinion survey information or the scoping process. Such thresholds include the degree of enjoyment obtained from a recreational experience. In natural systems, the carrying capacity of well-studied populations (usually game species) can be adequately modeled, but the capacity of whole ecosystems to withstand and recover from stress (i.e., their resilience) has yet to be modeled precisely and at best is expressed in gross probabilistic terms (i.e., the likelihood of a set of events occurring).

METHODS

8 EXAMPLES:

The air and water quality criteria provisions of the Clean Air Act and Clean Water Act, respectively, represent carrying capacity approaches to dealing with cumulative effects (as opposed to best available technology approaches). Under the Clean Air Act Amendments of 1990, states measure the cumulative effect of all sources on the concentration of air pollutants in specified attainment areas using regional models. New stationary sources are not permitted if they are determined to cause, in the aggregate, the concentration of a pollutant of concern to exceed its standard (the presumed carrying capacity of the area). Similarly, total maximum daily loads (TMDLs) are calculated for water bodies receiving point and nonpoint discharges as part of the NPDES permit process to ensure that the cumulative effects on water quality do not exceed the assimilation capacity of the receiving waters. If the cumulative effect remains below standards, capacities are not exceeded, and new proposals can be authorized (Contant and Wiggins 1993).

Wildlife and fisheries managers have been conducting carrying capacity analyses for many years (Smith 1974). Specifically, managers have used the maximum-sustained-yield concept to determine the amount of harvest of fish or game populations that will not result in deterioration of the population (i.e., not exceed the capacity of the population to renew itself). The U.S. Forest Service developed *Management Recommendations for the Northern Goshawk in the Southwestern United States* based on the concern that the goshawk, a forest habitat generalist, may be experiencing declining populations and reproduction associated with tree harvests and other factors affecting the carrying capacity of western forests (Reynolds et al. 1992). These guidelines will be used to develop national forest plans in the Southwestern Region that will

maintain the forest carrying capacity (i.e., specific habitat attributes and important prey species) needed to sustain goshawk populations despite the cumulative effects of human influences and natural perturbations, including loss of an herbaceous and shrubby understory, reduction in the amount of older forests, and increased areas of dense tree regeneration.

Managers of natural areas also employ the carrying capacity concept to prevent parks and other recreation areas from becoming overused.

Techniques used to evaluate the cumulative effects of recreation applications involve use thresholds (i.e., standards) based on social values (e.g., opportunities for solitude) and ecological factors (e.g., presence of rare and endangered species). The recreational carrying capacity concept is explicitly linked to the notion of nondegradation, where current conditions set a baseline or standard for environmental quality. For example, Forest Service researchers have devised the Limits of Acceptable Change process for setting and monitoring recreational carrying capacity in a wilderness area (Stankey et al. 1985). The U.S. Army Corps of Engineers (1993) addressed both the social carrying capacity and the resource carrying capacity of the Fox waterway in Illinois as it developed permitting policy guidelines for the area. Based on a definition of when people feel crowded, the social carrying capacity was determined to be approximately 854 boats and 236 jet skis on the open areas of the waterway. Based on a water quality definition that used a threshold of water clarity needed for vegetation growth, the resource carrying capacity was determined to be 350 cruising boats (i.e., the number that could use the deeper water areas that did not support sensitive vegetation).

METHODS

Carrying capacity analysis is a critical part of land use planning for sustainable development. Ideally, knowledge of the carrying capacity of an area provides the basis for developing suitability maps to guide future growth (including proposed federal projects). When applied to human communities, carrying capacity can be defined as "the ability of a natural or man-made system to absorb population growth or physical development without significant degradation

or breakdown" (Schneider et al. 1978). As part of comprehensive planning for Sanibel Island, Florida, land capability analysis was conducted to determine the cumulative effects of development actions on the structure and functions of the ecological zones of the island (Clark 1976). This analysis led to a comprehensive set of management guidelines based on the carrying capacity of these natural systems for sustaining human development. Figure A-10 illustrates the combinations of population numbers and population density that are possible without exceeding the carrying capacity of interior wetlands to assimilate runoff from developed areas.

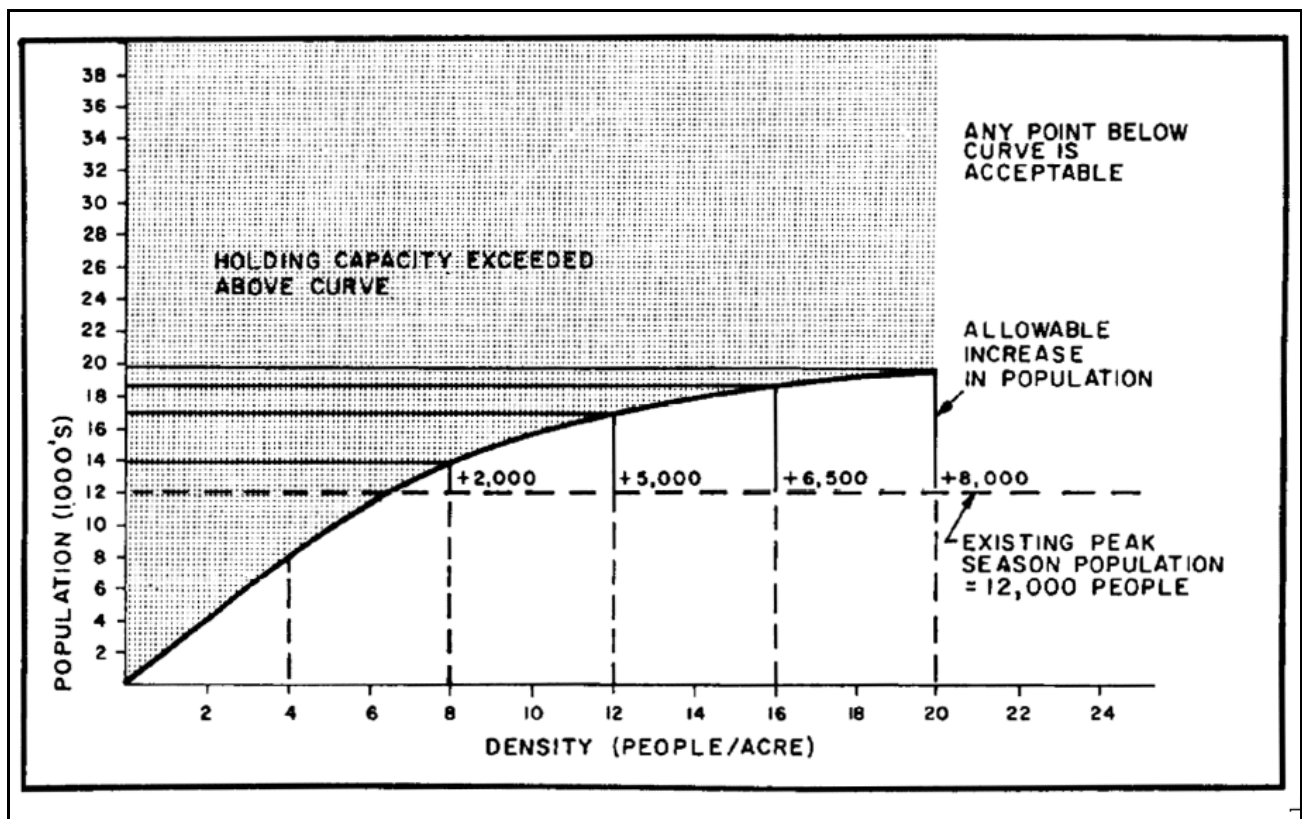

Figure A-10. Sanibel Island, Florida population versus runoff assimilation capacity (Clark 1976)

METHODS

References

Clark, J. 1976. The Sanibel Island Report: Formulation of a Comprehensive Plan Based on Natural Systems. Conservation Foundation, Washington, DC.

Contant, C.K. and Wiggins, L.L. 1993. Toward defining and assessing cumulative impacts: Practical and theoretical considerations. in Hildebrand, S.G. and Cannon, J.B., eds. *Environmental Analysis: the NEPA Experience*. Lewis Publishers, Boca Raton, Florida.

Reynolds, R.T., R.T. Graham, M.H. Reiser, R.L. Bassett, P.L. Kennedy, D.A. Boyce, Jr., G. Goodwin, R. Smith, and E.L. Fisher. 1992. Management Recommendations for the Northern Goshawk in the Southwestern United States. USDA Forest Service, General Technical Report RM-217, Fort Collins, CO.

Schneider, D.M., Godschalk, D.B., and Axler, N. 1978. The Carrying Capacity Concept As a Planning Tool. Planning Advisory Service Report Number 338. The American Planning Association, Chicago, Illinois.

Smith, R.L. 1974. *Ecology and Field Biology*, Second Edition. Harper and Row, Publishers. New York, NY.

Stankey, G.H., Cole, D.N., Lucas, R.C., Petersen, M.E. and Frissell, Sidney S. 1985. The Limits of Acceptable Change (LAC) System for Wilderness Planning. United States Department of Agriculture, Forest Service. General Technical Report INT-176.

U.S. Army Corps of Engineers. 1993. Draft Environmental Impact Statement. Cumulative Impacts of Recreational Boating on the Fox River and Chain O' Lakes Area in Lake and McHenry Counties, Illinois. USA Corps of Engineers, Chicago District.

9 ECOSYSTEM ANALYSIS

Ecosystem analysis involves considering the full range of ecological resources and their interactions with the environment. This approach can improve cumulative effects analysis by *providing the broad regional perspective and holistic thinking needed to address the following cumulative effects principles:*

- **Focus on the resource or ecosystem.** Ecosystem analysis specifically addresses biodiversity and uses the full range of indicators of ecological conditions ranging from the genetic to species to local ecosystem to regional ecosystem levels.
- **Use natural boundaries.** Ecosystem analysis uses ecological regions, such as watersheds and ecoregions, to encompass ecosystem functioning and landscape-scale phenomena such as habitat fragmentation.
- **Address resource or ecosystem sustainability.** The ecosystem approach to management explicitly addresses the ecological interactions and processes necessary to sustain ecosystem composition, structure, and function (Ad Hoc Committee on Ecosystem Management 1995).

Traditionally, environmental impact assessment has considered air quality, water resources, wildlife, and human communities as separate entities for analysis. This separation of resources has obscured many cumulative effects. Recognition of the interconnectedness of land, water, and human resources has driven many federal and state agencies to undertake eco-

system or watershed approaches to environmental protection. Since 1991, the U.S. EPA (1996) has embraced the watershed approach as the major mechanism for addressing cumulative nonpoint-source pollution. Specific applications include watershed-based TMDLs (U.S. EPA 1994) and the "watershed analysis" approach to addressing cumulative effects and improving resource management on timber land (Washington State Department of Natural Resources 1992; Regional Interagency Executive Committee 1995).

By its nature, biodiversity conservation is a cumulative effects issue. Because it encompasses all the structural and functional components of the biological environment (and its interactions with the physical world), biodiversity is constantly affected by a wide range of stresses. For this reason, the goals of biodiversity and ecosystem protection are usually coincident with those of cumulative effects analysis; therefore, the analyst should employ an ecosystem approach whenever biodiversity is an issue.

Principles of the ecosystem approach are included CEQ's (1993) report, *Incorporating Biodiversity Considerations Into Environmental Impact Analysis Under the National Environmental Policy Act* (see box) and the Interagency Ecosystem Management Task Force's (1995) report, *The Ecosystem Approach: Healthy Ecosystems and Sustainable Economics*. These principles involve three basic concepts: (1) taking a "big picture" or landscape-level view of ecosystems, (2) using a diverse suite of indicators including community-level and ecosystem-level

METHODS

indices, and (3) addressing the myriad interactions among ecological components that are needed to sustain ecosystem functioning. Applying the ecosystem approach to cumulative effects analysis entails using biological indicators (e.g., indices of biotic integrity for surface waters; K a r r 1 9 9 1 ; U . S .

EPA 1990) as integrators of cumulative effects and landscape indices (e.g., patch distribution of wetlands; Preston and Bedford 1988; Leibowitz et al. 1992) as measures of the cumulative diminution of ecosystem functioning. Natural resource agencies may soon be able to provide guidance on assessing and mitigating environmental effects at the ecosystem level (Truett et al. 1994).

PRINCIPLES OF BIODIVERSITY CONSERVATION (CEQ 1993)

1. Take a "big picture" or ecosystem view.
2. Protect communities and ecosystems.
3. Minimize fragmentation.
Promote the natural pattern and connectivity of habitats.
4. Promote native species.
Avoid introducing non-native species.
5. Protect rare and ecologically important species.
6. Protect unique or sensitive environments.
7. Maintain or mimic natural ecosystem processes.
8. Maintain or mimic naturally occurring structural diversity.
9. Protect genetic diversity.
10. Restore ecosystems, communities, and species.
11. Monitor for biodiversity impacts.
Acknowledge uncertainty.
Be flexible.

METHODS

9 EXAMPLES:

Constructing precise models of ecosystem structure and function sometimes exceeds the capabilities of NEPA practitioners. Considerable progress, however, has been made in applying the principles of ecosystem analysis to analyzing cumulative effects by extending considerations beyond species to the ecosystem and by looking at landscape-scale processes such as habitat fragmentation.

The most celebrated example where ecosystem analysis was used to extend the analysis of cumulative effects beyond a single species is the *Supplemental Environmental Impact Statement on Management of Habitat for Late-Successional and Old-Growth Forest Related Species Within the Range of the Northern Spotted Owl* (U.S. Forest Service and Bureau of Land Management 1993). Expert panels were convened to determine the likelihood of maintaining viable populations of a comprehensive suite of species and groups of species based on available habitat. Addressing the entire ecosystem involved considering terrestrial forest ecosystems (i.e., amounts of late-successional and old-growth forests and the viability of species ranging from fungi to bats), aquatic ecosystems (habitat conditions, riparian ecosystem processes), and aquatic and riparian dependent organisms (e.g., anadromous salmonids, resident fish species and subspecies, and other aquatic, riparian, and wetland organisms). The U.S. Forest Service (in conjunction with the U.S. Bureau of Land Management and Food and Drug Administration) also incorporated ecosystem analysis into the *Pacific Yew Final Environmental Impact Statement* by defining the role of the Pacific yew in the forest ecosystem (Figure A-11; U.S. Forest Service 1993). The cumulative effects of harvesting Pacific yew

on federal lands in the Pacific northwest for taxol production (for use as a cancer treatment) were analyzed in three different contexts: the Pacific yew itself (including its genetic diversity), the forest ecosystem that supports yew populations, and the relationship of the yew and human communities.

The ecosystem analysis approach implemented by the Forest Ecosystem Assessment Team (FEMAT) in the spotted owl EIS also considered ecosystem processes affected by the cumulative actions on lands owned and managed by states, tribes, corporations, individuals, and other nonfederal agencies. The analysis included an aquatic conservation strategy based on the designation of key watersheds and the use of watershed analysis. The Washington State Department of Natural Resources (1992) recently published a watershed analysis manual including a set of technically rigorous procedures that can be used to determine what processes are active in a watershed, how these processes are distributed in time and space, what the current upland and riparian conditions are, and how all of these factors influence ecosystem services or other beneficial uses. Watershed analysis is being expanded to encompass other aspects of the ecosystem approach to management (Montgomery et al. 1995; Regional Interagency Executive Committee 1995). In the **synoptic landscape approach** to cumulative effects analysis developed by the U.S. EPA Environmental Research Laboratory in Corvallis, OR, the landscape is the unit of analysis (Leibowitz et al. 1992). Synoptic indices are chosen from the following landscape-level measures: function value, functional loss, and replacement potential. Subsequently, landscape indicators are chosen as

METHODS

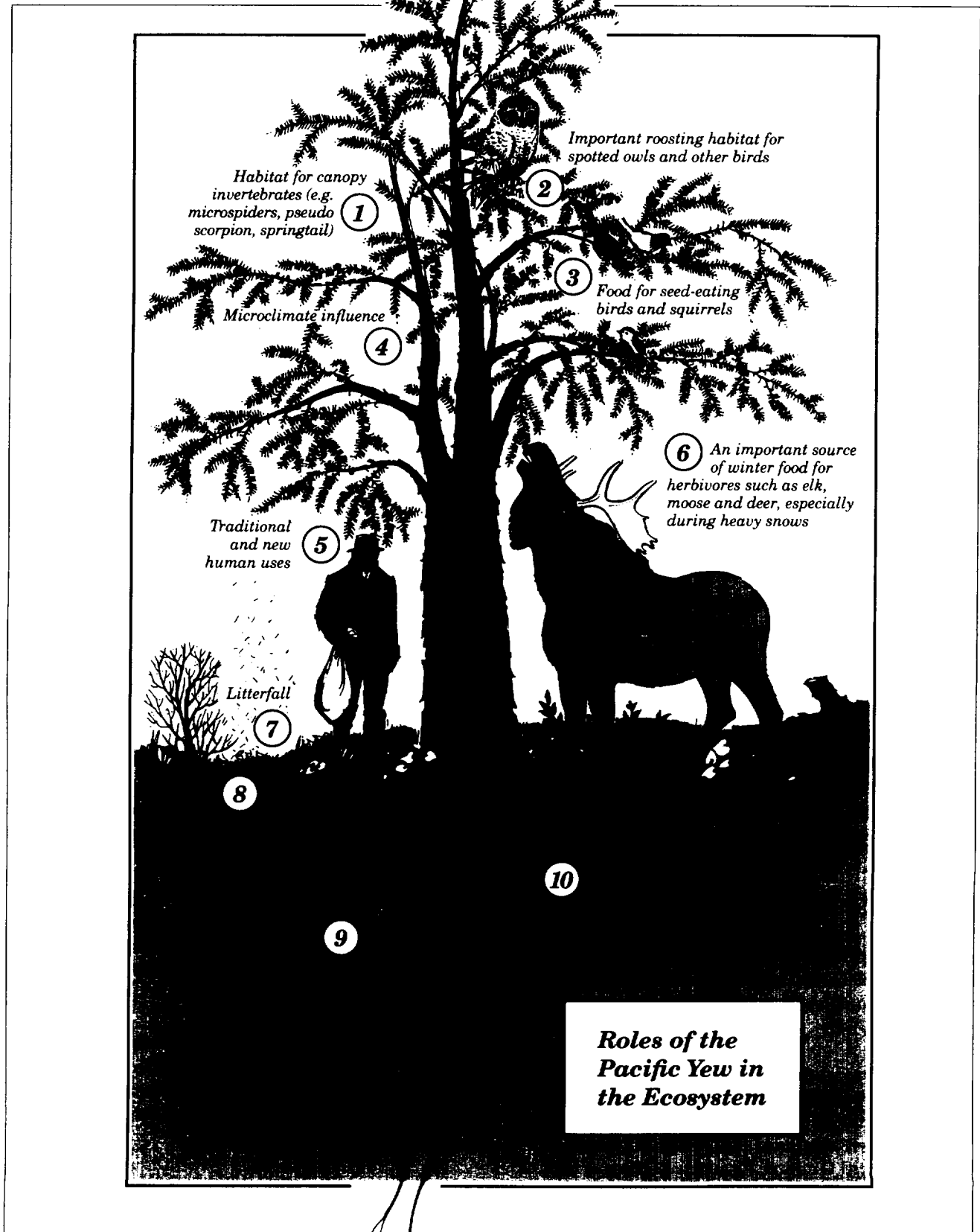

Figure A-11. Roles of the Pacific Yew in the Ecosystem (U.S. Forest Service 1993)

METHODS

first-order approximations of the synoptic indices. This approach provides a framework for comparing the cumulative effects of actions on landscape processes such as flood storage and wildlife support.

Habitat fragmentation is one of the most important ecosystem-level processes to address in cumulative effects analysis. Concerns about potential cumulative effects of habitat fragmentation on biodiversity prompted a supplemental information report to the FEIS and Record of Decision (ROD) of the Trail Creek Timber Sale, Beaverhead National Forest, Montana (U.S. Forest Service 1991). The report assessed habitat loss effects, edge effects, patch size effects, insularity effects (on genetics of populations linked by habitat corridors), and effects on rare elements. Specifically, the report evaluated the importance of the area as a biological corridor between the large wildland areas of the Northern Continental Divide, Selway-Bitterroot, and Greater Yellowstone areas. Similar concerns have been raised in other areas (e.g., Klamath National Forest; Pace 1990) and have prompted considerable research into landscape-level indicators such as abundance or density of habitats, habitat proportion, patch size and perimeter-to-area ratio, fractal dimension (amount of edge), and contagion or habitat patchiness (Hunsaker and Carpenter 1990; Noss 1990; O'Neill et al. 1994).

References

- Ad Hoc Committee on Ecosystem Management. 1995. The Scientific Basis for Ecosystem Management. Ecological Society of America, Washington, DC.
- Council on Environmental Quality (CEQ). 1993. Incorporating Biodiversity Considerations Into Environmental Impact Analysis Under the National Environmental Policy Act. Council on Environmental Quality, Executive Office of the President, Washington, DC. 29 pp.
- Hunsaker, C.T. and D.E. Carpenter. 1990. Environmental Monitoring and Assessment Program—Ecological Indicators. U.S. Environmental Protection Agency, Research Triangle Park, NC. EPA 600/3-90/060.
- Interagency Ecosystem Management Task Force. 1995. The Ecosystem Approach: Healthy Ecosystems and Sustainable Economies, Vol. I Overview. Washington, DC.
- Karr, J.R. 1991. Biological Integrity: A Long-Neglected Aspect of Water Resource Management. *Ecological Applications* 1:66-84.
- Leibowitz, S.G., B. Abbruzzese, P. Adamus, L. Hughes, and J. Irish. 1992. A Synoptic Approach to Cumulative Impact Assessment—A Proposed Methodology. U.S. Environmental Protection Agency, Environmental Research Laboratory, Corvallis, OR. EPA/600/R-92/167.
- Montgomery, D.R., G.E. Grant, and K. Sullivan. 1995. Watershed analysis as a framework for implementing ecosystem management. *Water Resources Bulletin* 31(3):369-386.
- Noss, R.F. 1990. Indicators for monitoring biodiversity: a hierarchical approach. *Conservation Biology* 4:355-364.
- O'Neill, R.V., K.B. Jones, K.H. Riitters, J.D. Wickham, and I.A. Goodman. 1994. Landscape Monitoring and Assessment Plan. U.S. Environmental Protection Agency, Las Vegas, NV. EPA/620/R-94/009.
- Pace, F. 1990. The Klamath Corridors: Preserving biodiversity in the Klamath National Forest. In: Hudson, W.E., ed. *Landscape Linkages and Biodiversity*. Island Press, Washington, DC, pp. 105-106.
- Preston, E.M. and B.L. Bedford. 1988. Evaluating cumulative effects on wetland functions: A conceptual overview and generic framework. *Environmental Management* 12:565-583.

METHODS

Regional Interagency Executive Committee. 1995. Ecosystem Analysis of the watershed scale: Federal guide for watershed analysis - Version 2.2. Regional Ecosystem Office, Portland, OR. 26 pp.

Truett, J.C., H.L. Short, and S.C. Williamson. 1994. Ecological impact assessment. In: T.A. Bookhout, ed. *Research and Management Techniques For Wildlife and Habitats*. The Wildlife Society, Bethesda, MD pp. 607-622.

U.S. Environmental Protection Agency (EPA). 1990. Biological Criteria: National Program Guidance for Surface Waters. U.S. EPA, Office of Water Regulations and Standards, Washington, DC. EPA-440/5-90-004.

U.S. Environmental Protection Agency. 1994. Moving the NPDES Program to a Watershed Approach. Office of Wastewater Management, Washington, D.C. EPA 833-R-96-001.

U.S. Environmental Protection Agency (EPA). 1996. Watershed Events: A Bulletin on Sustaining Aquatic Ecosystems. Spring. U.S. EPA, Office of Water, Washington, DC. EPA 840-N-96-002.

U.S. Forest Service. 1991. Supplemental information report, Trail Creek Timber Sale, Wisdom Ranger District, Beaverhead National Forest. USDA, Forest Service, Northern Region. April 2.

U.S. Forest Service. 1993. Pacific Yew Final Environmental Impact Statement. USDA, Forest Service, Pacific Northwest Regional Office, Portland, OR.

U.S. Forest Service and Bureau of Land Management. 1993. *Draft Supplemental Environmental Impact Statement on Management of Habitat for Late-Successional and Old-Growth Forest Related Species Within the Range of the Northern Spotted Owl*. Portland, OR. July.

Washington State Department of Natural Resources. 1992. Watershed Analysis Manual. Version 1.0. Timber, Fish, and Wildlife, Olympia, WA. TFW-CEI-92-002.

10

ECONOMIC IMPACT ANALYSIS

Economic impact analysis satisfies the mandate under NEPA to "...fulfill the social, economic and other requirements of present and future generations of Americans" [National Environmental Policy Act, Title I Sec. 101 (a)]. *It is an important component of analyzing cumulative effects, because the economic well-being of a local community depends on many different actions.* The following effects are the minimum that an economic impact analysis should determine:

- change in business activity
- change in employment
- change in income
- changes in population.

The three primary steps in conducting an economic impact analysis are (1) establishing the region of influence, (2) modeling the economic effects, and (3) determining the significance of the effects.

The definition of the geographic region of influence (ROI) is often controversial. Most regional and urban analysts prefer to use a functional area concept for defining study regions (Fox and Kuman 1965). Regions defined in this way explicitly consider the economic linkages between the residential population and the businesses in the geographic area. Specifically, the affected region should include all of the self-sustaining ingredients of region-local businesses, local government, and local population (Chalmers and Anderson 1977). Although no standard methodology exists, the definition of a ROI should consider residence patterns of the affected population,

availability of local shopping opportunities, "journey-to-work" time for employees, and local customs and culture.

Economic models are invaluable for analyzing cumulative effects. The suite of economic models can vary from simple to complex (Richardson 1985; Treyz 1993). As a rule, economic models are sets of mathematical equations that represent the interactions among the integral components of the regional economy; the modeled relationships are based upon economic principals that have a long history of accuracy and use. Data to "drive" the models are critical to performing an impact analysis and acquiring data is often the limiting factor for the analyst. Although they are focused on economic relationships, economic models can incorporate demographics. Ultimately, economic models are used to project effects under each alternative.

Once model effects projections are obtained, additional tools, such as the rational threshold value (RTV) and the forecast significance of impacts (FSI) approaches, can provide timely and cost-effective evaluations of the significance of the effect (Huppertz and Bloomquist 1993). These analytical tools review the historical trends for the defined region and develop measures of historical fluctuations in sales activity, employment, income, and population. This use of time-series data provides the analyst with a historical context in which to evaluate significance. The use of economic impact models in combination with the RTV and FSI techniques has proven successful in addressing cumulative economic impacts.

METHODS

10 EXAMPLES:

Three kinds of models are most often used in economic impact analysis: economic base models, input-output models, and econometric models. The underlying assumption of an economic base model is that changes in a regional economy occur as a result of changes in the amounts of goods and services that are sold outside the region. The economic base model is based on the bifurcation of the regional economy into "basic" and "non-basic" sectors. Defined simply, basic sectors produce goods and services that are generally consumed outside the region and non-basic sectors produce goods and services that are consumed within the region. Basic sectors can be identified by surveying local firms and households to determine where they purchase their goods and services or by the "location-quotient" technique (Isserman 1977), which measures the extent to which a sector is more concentrated within the region than within the nation as a whole. The location-quotient assumes this excess production is exported outside the region.

Input-output models (Miller and Blair 1985) explicitly consider the interrelationships between different sectors of a regional economy and how these interactions affect the process of economic changes within the region. Input-output models provide more information on economic transactions by sector within a local economy than economic base models, but they require more data. Regional econometric models (Glickman 1977; Treyz 1993) represent a compromise between economic base and input-output analysis in terms of data requirements and information produced. Econometric models are usually statistically derived and draw upon survey-based data, traditional regression techniques, and other statistical tools. Fluctuations in the subject regional economies, respectively. The total aggregate changes in business volume, employment, income, and population (four of the model outputs) are then used

Econometric models use time-series data to show the pattern of effects due to outside influences over a period of years. As a result, regional econometric models are better suited for predictions of long-run effects. Unfortunately, local-time series data are often not available for the region of concern.

The Economic Impact Forecast System (EIFS) is perhaps the most commonly used method for assessing regional economic effects; it is the specified model of choice for all environmental analyses associated with Army Base Realignment and Closure (BRAC). EIFS was developed as a simple model based upon three major criteria: (1) basis in sound theory, (2) acceptance by the scientific community, and (3) availability of data to drive the model. By entering county names to designate the Region of Economic Influence (ROI), Bureau of Economic Analysis (BEA) and other data are readily available for use. After six variables associated with the action [i.e., number of military and civilian employees being transferred, the average salary of both categories, the percent of military personnel living on base, and the anticipated change in local (or total) procurements] are added to the thousands of BEA data elements, EIFS automatically performs the needed trends analysis, multiplier calculations, and other computations. EIFS has provided a consistent methodology for all BRAC studies and has allowed the Army to "rank-order impacts" among alternatives as required by NEPA.

The significance of BRAC actions is determined by adding two evaluative components to EIFS. As described previously, RTV and FSI techniques measure historical and statistical

to assess the significance of regional economic effect. As analysts begin to address the cumulative effects of more and more actions,

METHODS

other models that lead directly from available data to conclusions of significance will be needed.

References

Chalmers, J.A. and E.J. Anderson. 1977. Economic/Demographic Assessment Manual: Current Practices, Procedural Recommendations, and a Test Case. U.S. Bureau of Reclamation. Denver, Colorado.

Fox, K.A. and T.K. Kuman. 1965. The functional economic area: Delineation and implications for economic analysis and policy. *Papers and Proceedings, Regional Science Association* 15: 57-85.

Glickman, N.J. 1977. *Econometric Analysis of Regional Systems*. New York: Academic Press.

Huppertz, C.E. and K. M. Bloomquist. 1993. Economic Impact Forecast System (EIFS): Guide to Economic Models and Software Version 4.1, Draft CERL Technical Report. Department of the Army, Construction Engineering Research Laboratories, Champaign, Illinois.

Isserman, A.M. 1977. The location quotient approach to estimating regional economic impact. *Journal of American Institute of Planners*, January 1977, 33-41.

Miller, R.E. and P.D. Blair. 1985. *Input-Output Analysis: Foundations and Extensions*. Prentice-Hall, Inc. Englewood Cliffs, New Jersey.

Richardson, H.W. 1985. Input-output and economic base multipliers: Looking backward and forward. *Journal of Regional Science* 25: 607-661.

Treyz, G.I. 1993. *Regional Economic Modeling: A Systematic Approach to Economic Forecasting and Policy Analysis*. Kluwer Academic Publishers, Boston, Massachusetts.

11 SOCIAL IMPACT ANALYSIS

Social impact analysis fulfills the mandate under CEQ's regulations that the "human environment" in NEPA be "interpreted comprehensively" to include "the natural and physical environment and the relationship of people with the environment" (40 CFR§ 1508.14). The social sciences have *made considerable progress in addressing cumulative effects related to environmental stewardship by focusing on key social impact variables*. The Interorganizational Committee on Guidelines and Principles (1994) has identified five basic categories of social impact variables:

1. Population characteristics such as its size and expected size, ethnic and racial diversity, and the influx and outflux of temporary (e.g., seasonal or leisure) residents.
2. Community and institutional structures including the size, structure, and linkages of local government; the historical and present patterns of employment and industrial diversification; and the size, activity, and interactions of voluntary associations, religious organizations, and interest groups.
3. Political and social resources such as the distribution of power and authority, the identification of interested and affected parties, and the leadership capacity within the community or region.
4. Individual and family changes including factors that influence the daily life of individuals and families (and indigenous and religious subcultures) in the community or region such as attitudes toward the proposed policy, alterations in family and community networks, and perceptions of risk, health, and safety.
5. Community resources such as patterns of natural resource and land use; the availability of housing; and community services including health, police, fire protection, and sanitation facilities.

The key to analyzing the cumulative effects on these social impact variables is incorporating multiple actions into projections of future social conditions. The following general categories describe the range of methods used to predict future social effects:

- linear trend projections (identifying taking an existing trend and projecting the same rate of change into the future);
- population multiplier methods (a specified increase in population implies designated multiples of some other variable);
- scenarios (characterization of hypothetical futures through a process of mathematically or schematically modeling the assumptions about the variables in question);
- expert testimony (experts can be asked to develop scenarios and assess their implications);
- simulation modeling (mathematical formulation of premises and a process of quantitatively weighing variables).

METHODS

11 EXAMPLES:

Social impact analysis differs from other analyses of cumulative effects because it must deal with the subjective perception of effects. Social effects appraisal and social well-being accounts are examples of methods for analyzing subjective social variables.

Social effects appraisal determines the social meaning and significance of the objective changes produced by cumulative actions. The social analyst assesses the social meaning of the changes from the different perspectives of the affected groups. One way to measure the meaning of a change is to tap the knowledge of opinion leaders (formally or informally) within the affected groups to determine the values they assign to each change. For example, an influx of 200 construction workers and their families might be viewed positively by families suffering from a stagnant economy but negatively by retirees looking for a quiet neighborhood. The social analyst needs to acknowledge that while some negative social effects can be remedied materially (perhaps by economic growth), others are qualitative and defy mitigation.

The social well-being account is a display that summarizes findings by cross tabulating levels of analysis, evaluation categories, and effect factors with a social effects evaluation of the present condition and each of the alternatives (including no-action). It provides either a quantitative (numerical) or qualitative rating of each alternative's overall social effect and a description of the rating scale. The Multi-Attribute Tradeoff System (MATS) and other computer programs assist in producing a systematic numerical evaluation of social effects. The result is an overall quantitative ranking for

each alternative, reflecting the alternative's relative social benefit to the affected group.

The Federal Highway Administration (FHWA) frequently deals with social impact issues related to its transportation projects. FHWA (1996) recently prepared a primer for analysts who assess the effects of proposed transportation actions on human communities. FHWA states that community impact studies must include secondary effects and influences from outside developmental pressures to determine the ability of an area to survive removal of housing, businesses, and community services. Also, such studies must describe a community's ability to absorb relocated residents and businesses in terms of social and economic disturbance (e.g., available housing, public services affected, areas zoned for business use). The primer describes nine impact categories to be analyzed, including social and psychological aspects, physical aspects, visual environment, land use, economic conditions, mobility and access, provision of public services, safety, and displacement. Considering these effects naturally includes environmental justice issues. Community impact analysis is analogous to ecosystem analysis in that the human community should be thought of as an integral unit with a characteristic social setting and operation. Decisions about avoiding and mitigating effects should be based on consensus visions of the desired condition of the community. Lastly, if community effects are to receive attention comparable to that given the natural environment, special effort to ensure public involvement must be employed (e.g., using nontraditional and informal approaches).

References

METHODS

Federal Highway Administration (FHWA). 1996. Community Impact Assessment: A Quick Reference for Transportation. FHWA, Office of Environmental and Planning, Washington, DC. FHWA-PD-96, HEP-30.

Interorganizational Committee on Guidelines and Principles. 1994. Guidelines and principles for social impact assessment. *Impact Assessment* 12(2):107-152.

METHODS
