

Presentation:

An Introduction to Residential Insulated Concrete Forms

PRESENTED BY

Cameron Ware

cware@Nudura.com

www.nudura.com

866.468.6299



Nudura is now part of

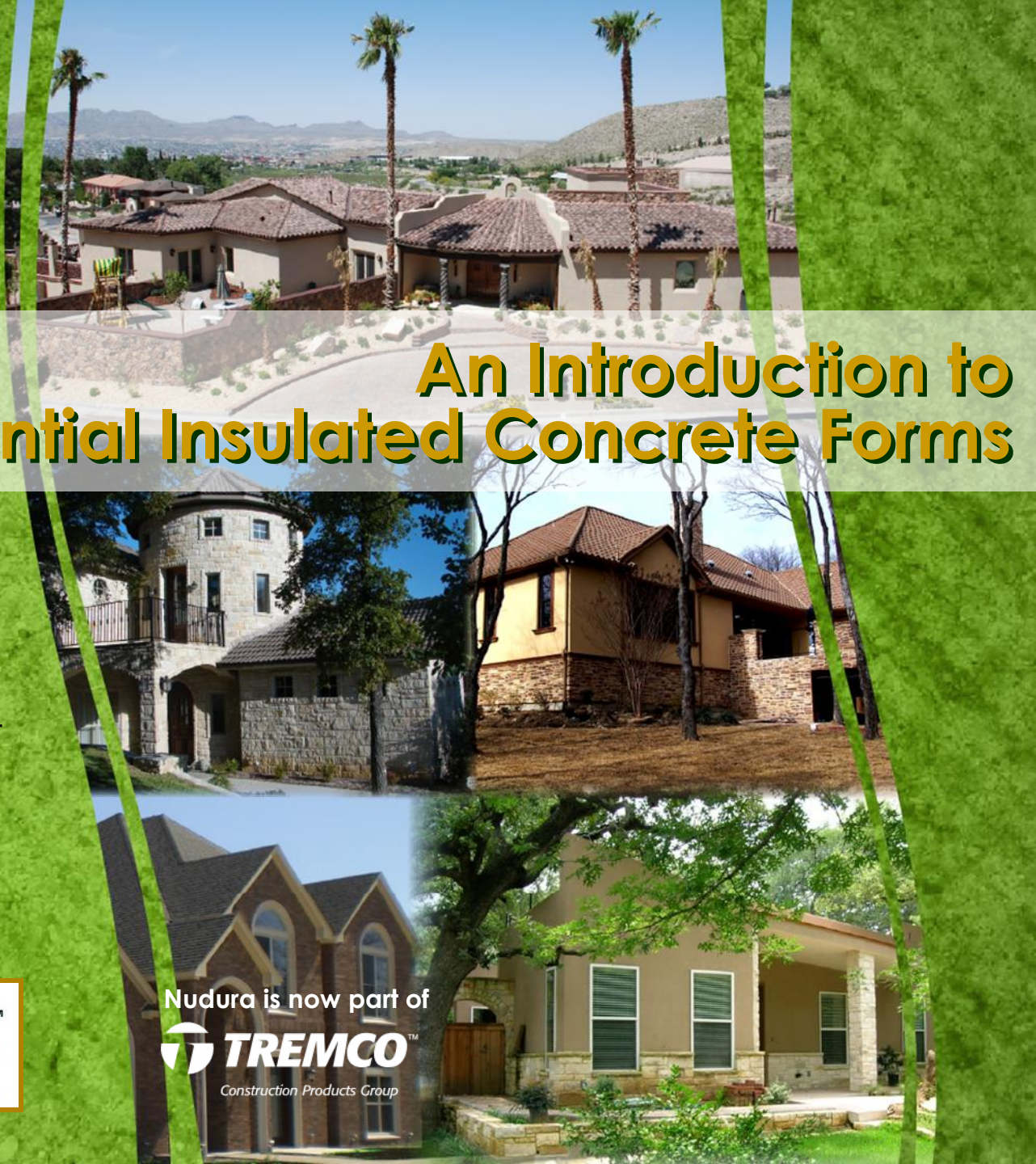



History of ICFs

□ Development of the ICF technology

- Early ICFs first appeared in Europe in late **1960s**
- Imported into Canada in late **1970s**
- **1980s** saw a number of new ICF forming systems enter market
- **1990s** -- ICF manufacturer's bring new systems to market in United States
- New millennium ushered in next generation of ICF products
- ICF systems now in use world-wide

ICF Basics

□ Concept Design

- ICFs combine simplicity, strength, and energy efficiency
- ICFs are basically stay-in-place forms for pouring concrete walls

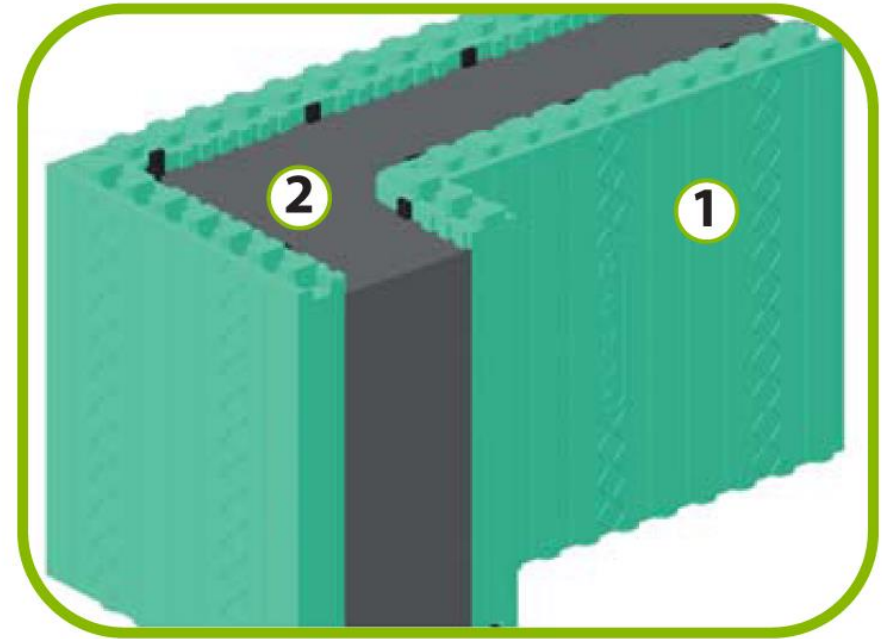

- 1** Double insulation protection for maximum comfort
- 2** Reinforced monolithic concrete core for maximum safety and energy efficiency

ICF Basics

❑ Insulated or Insulating Concrete Forms

- Consist of two panels of foam insulation
- Made of expanded (EPS) or extruded (XPS) polystyrene

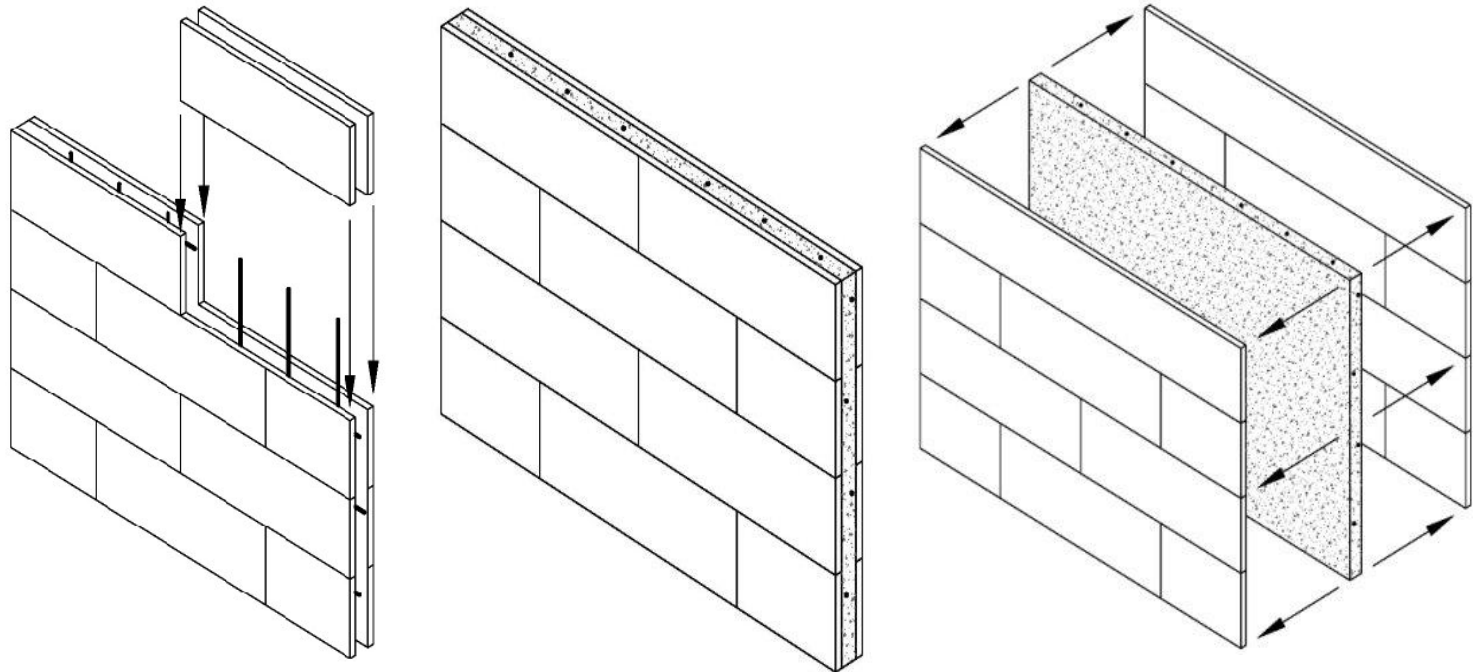

ICF Basics

□ Webs or cross ties

- ICF panels are held together with cross ties or webs
- Usually recycled plastic, nylon or metal inserts
- Molded in place or added on-site
- Forms are stacked or locked on-site
- Most ICFs provide a finish fastening strip placed at regular intervals

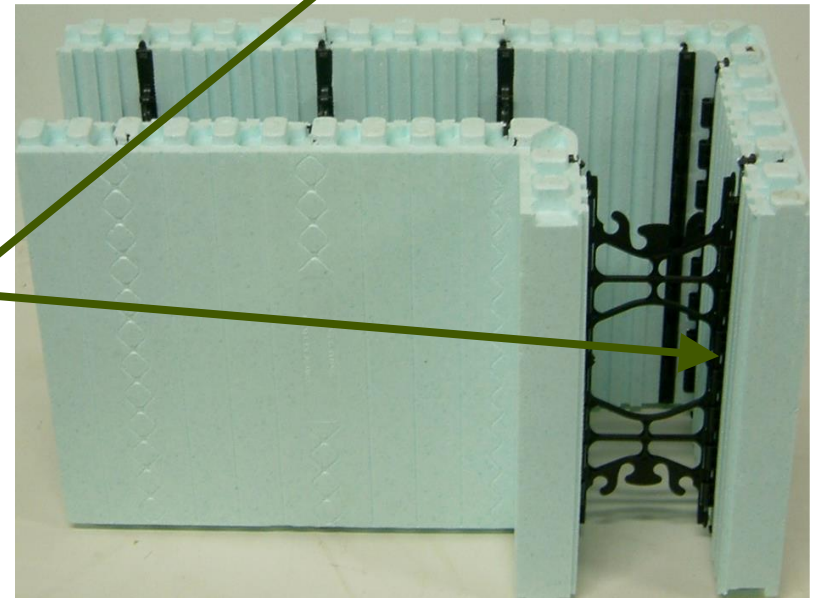

ICF Basics

❑ Construction basics

- Horizontal reinforcing steel (rebar) is added as the blocks are stacked
- Vertical reinforcing steel (rebar) is added pre-pour
- Forms are filled with concrete
- Forms provide a wall finish backing surface



ICF Basics

□ Completed ICF assembly

- Forms are left in place to create an integral structure
 - Structural monolithic poured concrete walls
 - Wall assembly with high thermal insulation and high STC

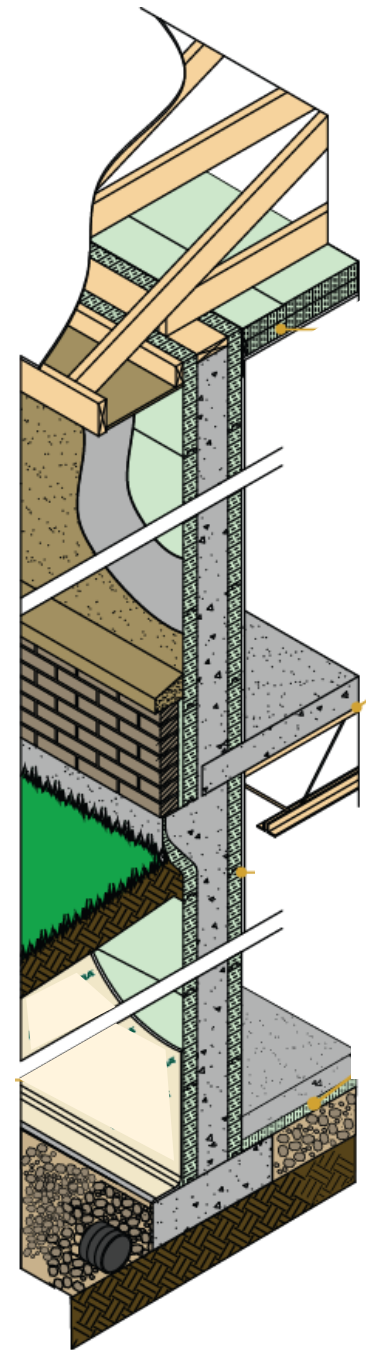
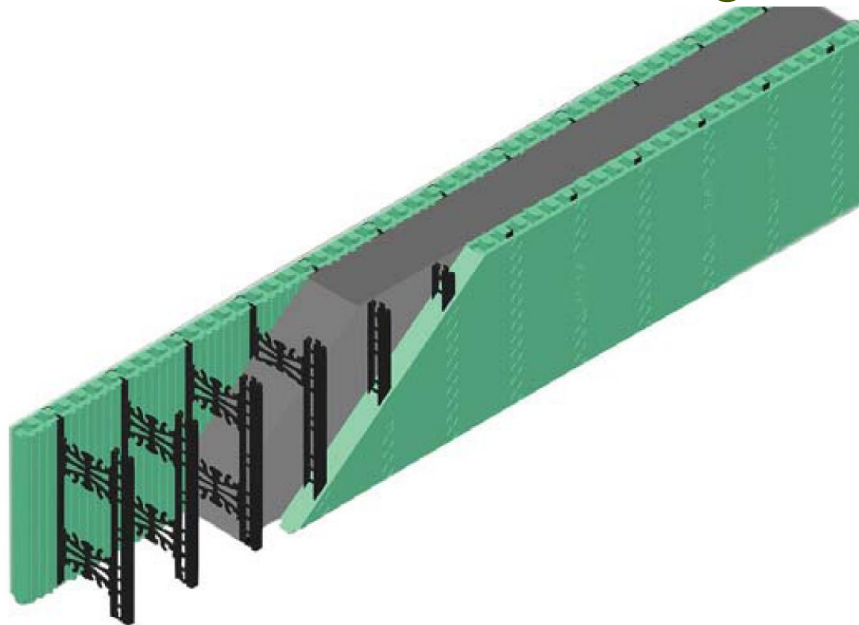

Types of ICFs

□ Assembly Methods

- Site assembled
- Preformed fully assembled units
- Fully assembled folding units

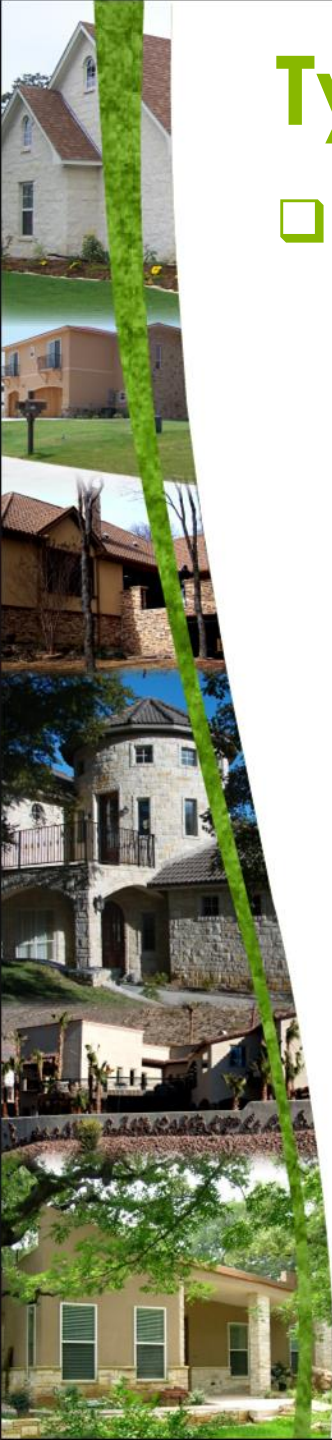
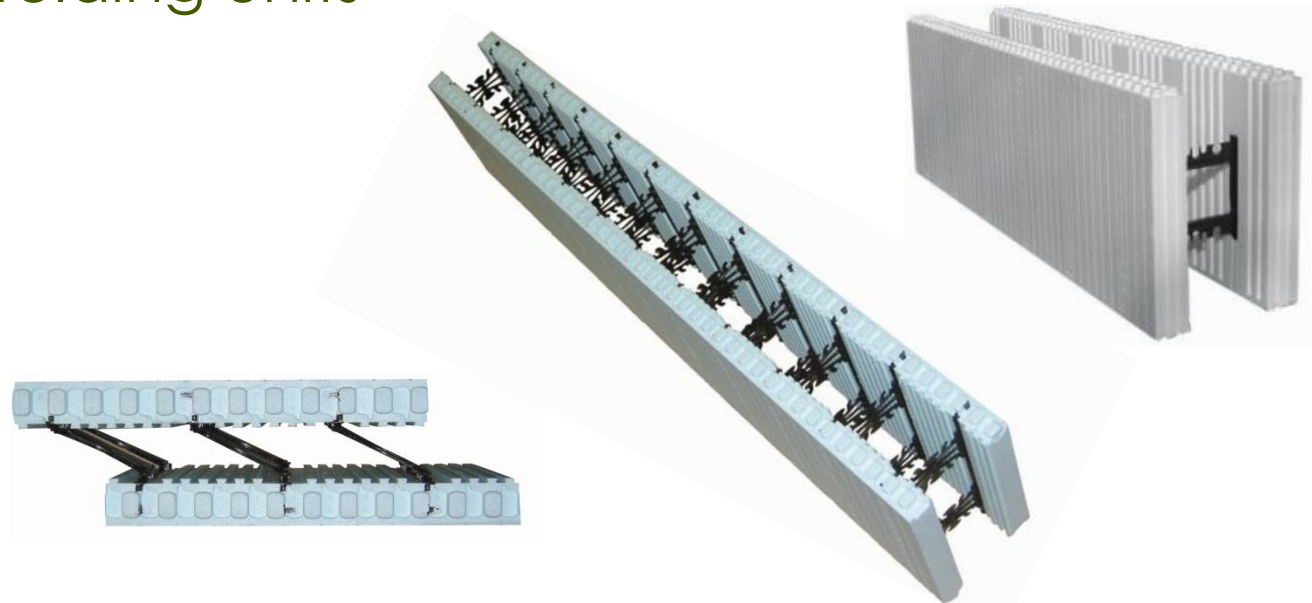
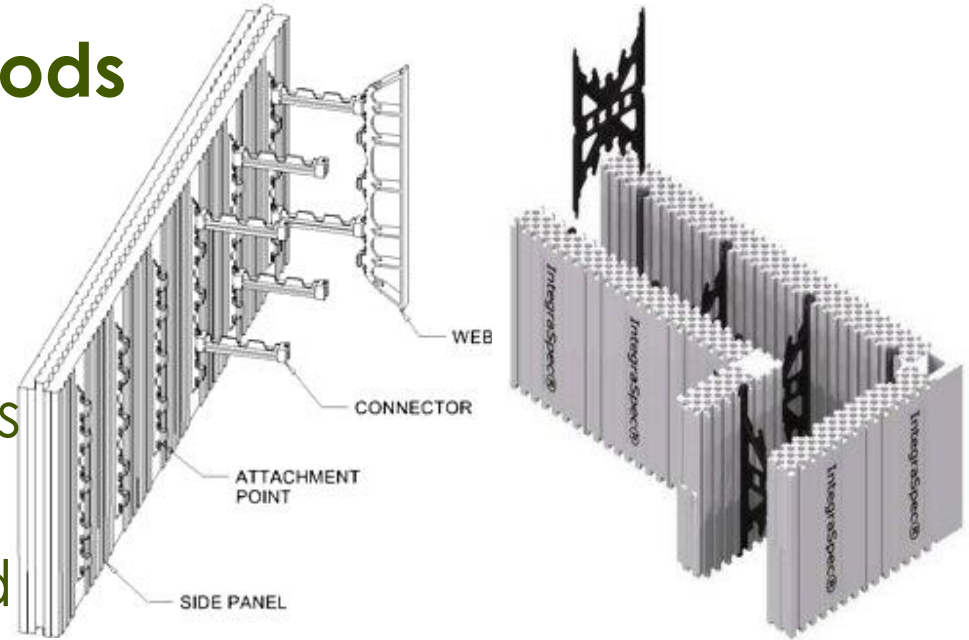

Flexible Wall Design Capabilities

□ Multiple Block Options

- 90s
- 45s
- Brick Ledges
- Taper-Top Units
- T-Forms
- Radius Units

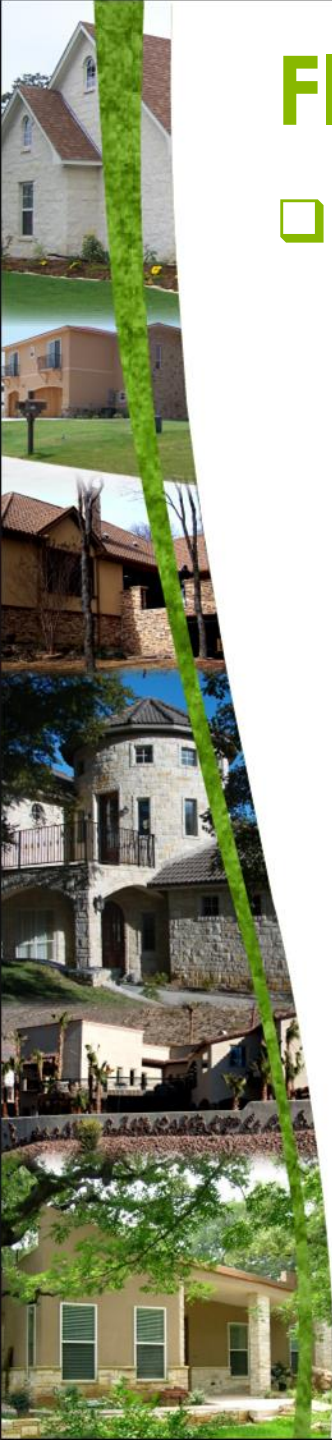
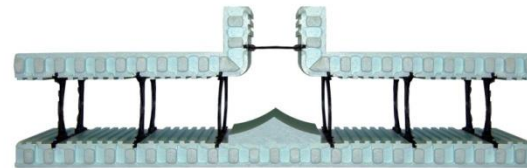
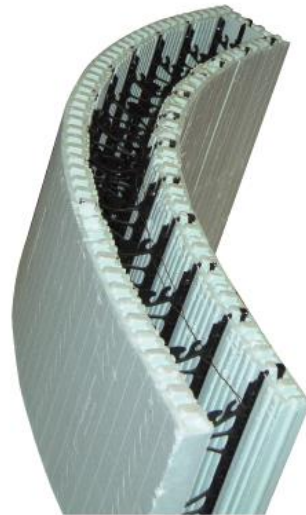
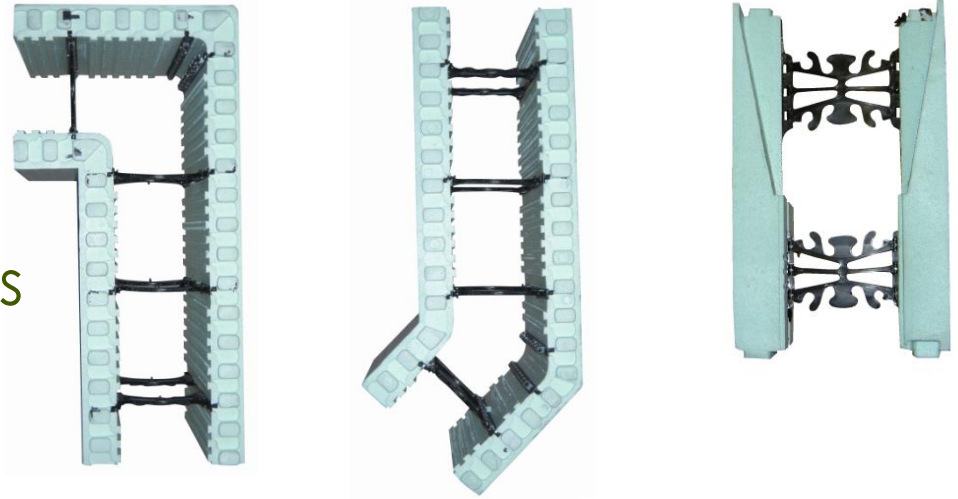

Broad Wall Height & Building Types

□ ICF Construction Options

- Multiple capabilities with flexible concrete core
 - Thicknesses ranging from 4", 6", 8", 10", 12" and up
- Construction type options
 - Below Grade
 - Single Story
 - Multi-story
 - Bearing Walls
 - Curtain Walls

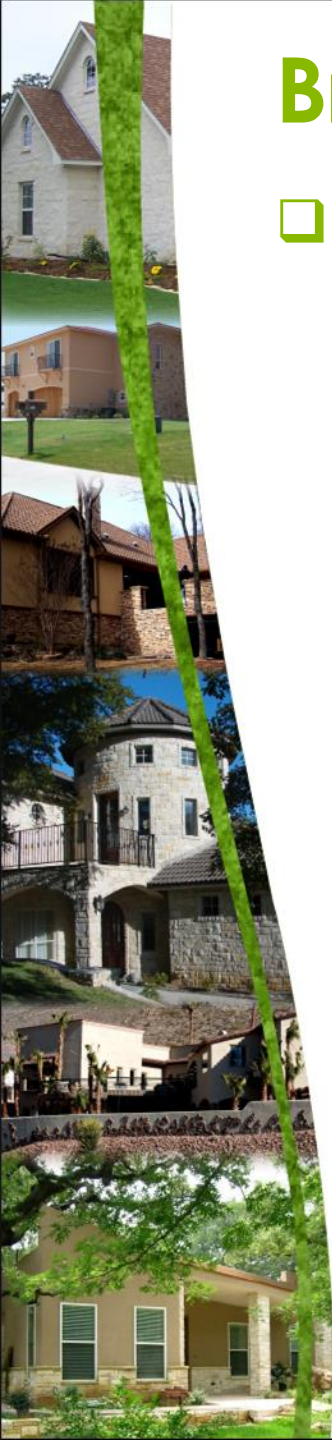

Multiple Surface Finishes

□ Finish Options

- Almost any finish can be applied to the inside and outside of ICFs
 - Brick veneer
 - Stone
 - Stucco
 - EIFS
 - Wood & cement board siding
 - Drywall

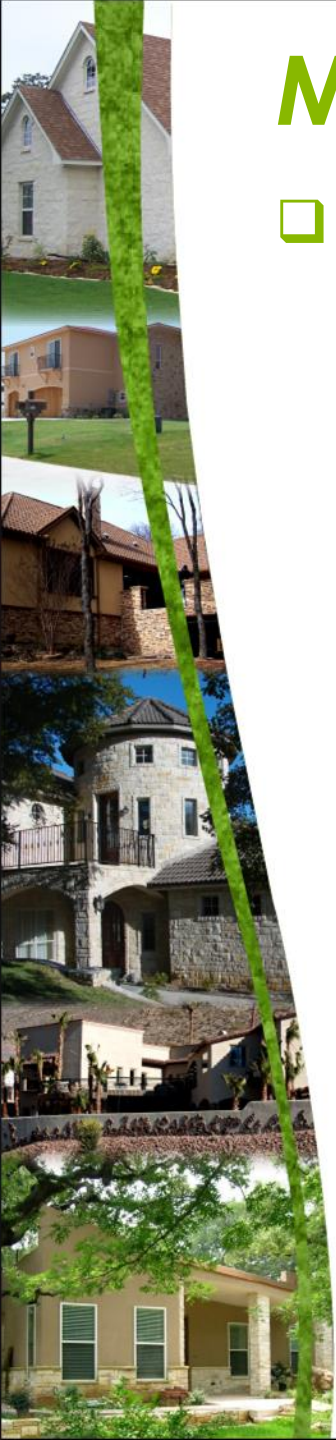

ICF Construction Process Overview



ICF Construction Process Overview

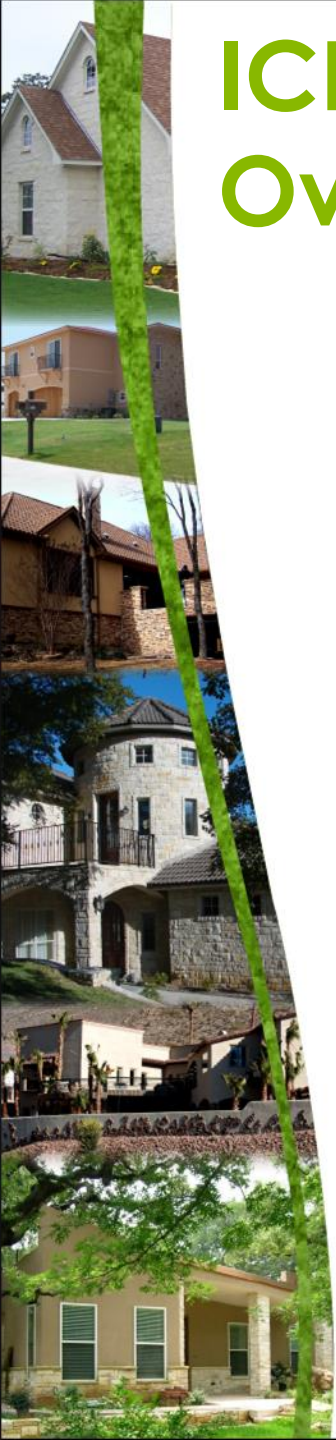

ICF Construction Process Overview



ICF Construction Process

❑ Foundation/Wall connections

- Standard vertical reinforcement dowels provide lateral support at the base of the wall
- Dowels must be placed in the footing or slab edge at the center of monolithic concrete wall

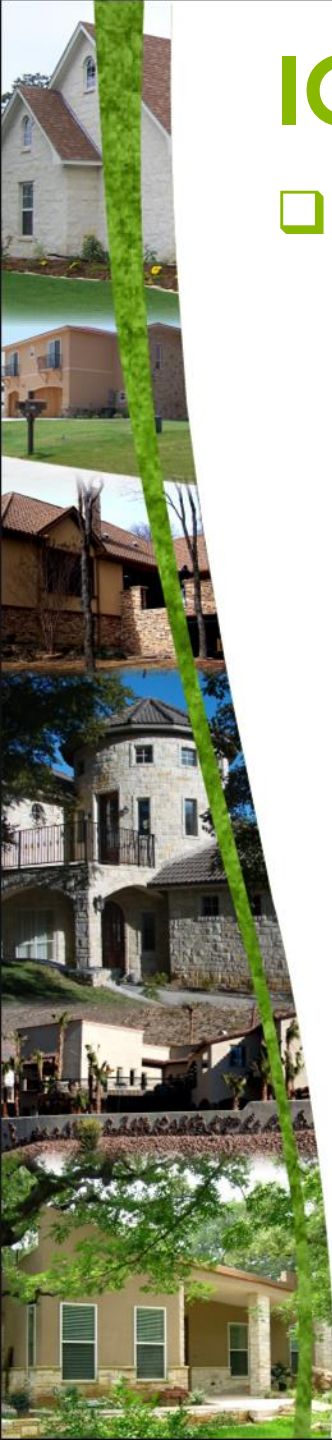

ICF Construction Process

□ Form Unit Placement

- Form units are stacked similar to building blocks to the required building dimensions

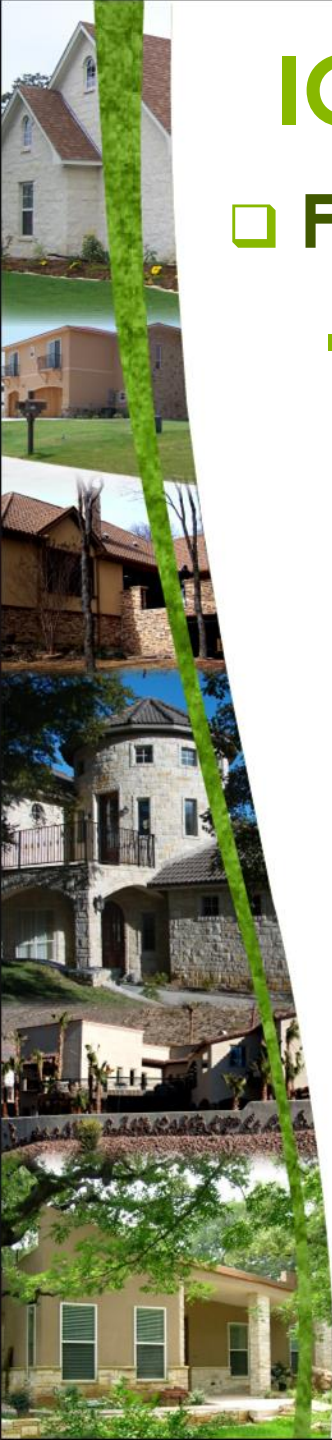
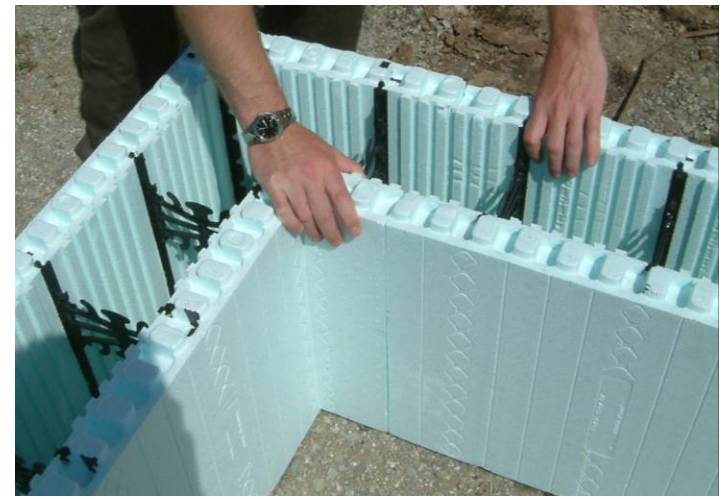
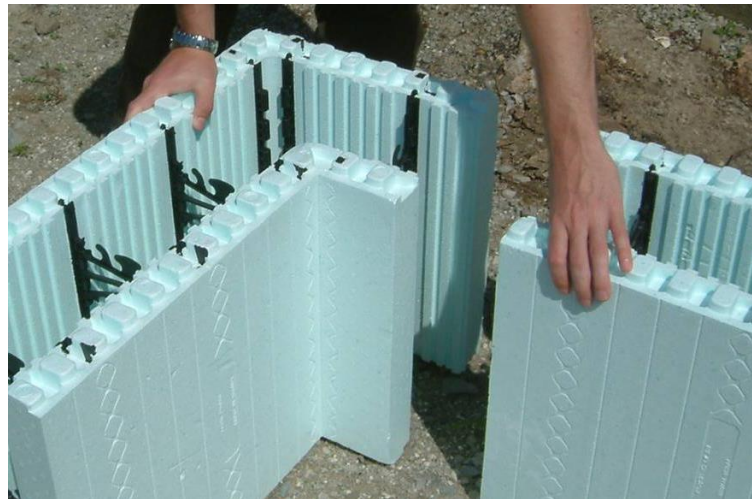
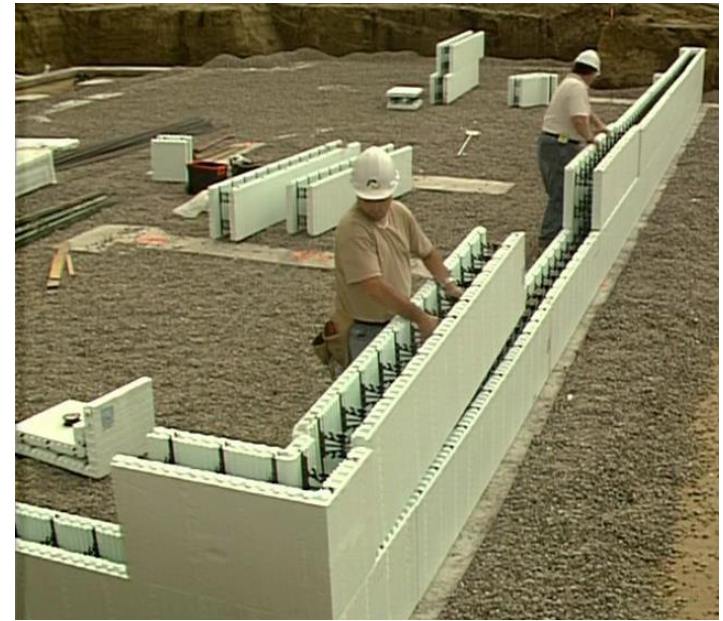

ICF Construction Process

❑ Reinforcing steel placement

- Placed according to the design requirements into notches provided by the web
- Webs provide accurate positioning of reinforcing steel
- When actual block's reinforcing web design is considered for structural specification, construction speed is greatly enhanced



ICF Construction Process

□ Windows & Doors

- Window and door “bucks” or frames are placed as the wall is constructed
- “Bucks” can be created using several different material options

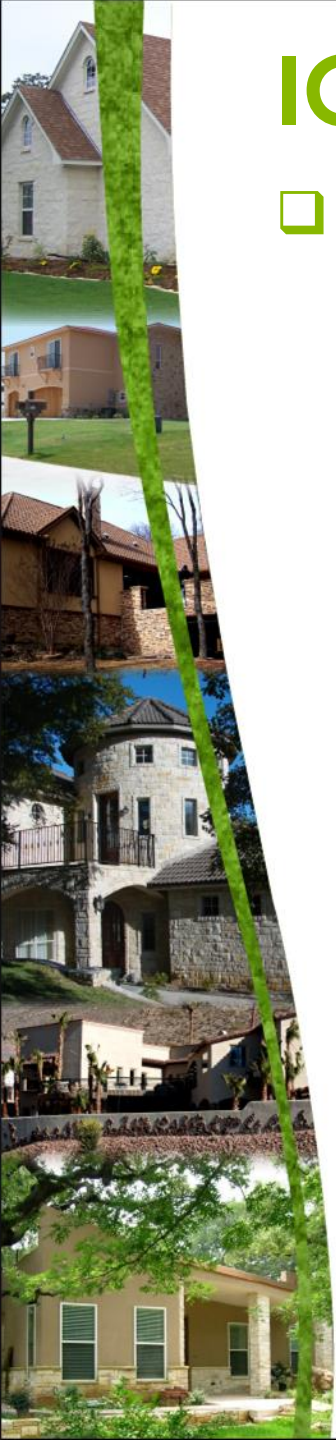

ICF Construction Process

□ Bracing, alignment & scaffolding system

- Wall alignment systems and bracing is placed as the wall is stacked

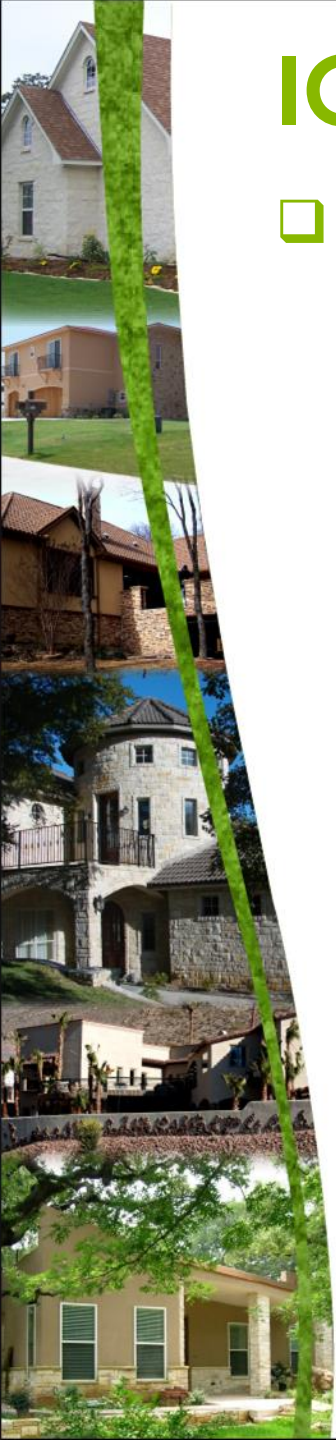

ICF Construction Process

❑ Concrete placement

- Concrete is poured into the hollow cavity of the wall to create a solid 4" to 12" solid concrete wall



ICF Construction Process

❑ Special form shapes and conditions

- Gable End Walls
- Taper-top forms or brick ledge forms may be used to create a wider bearing surface
- Ledges can be created by combining forms of different widths
- T-wall connections can be installed at intersecting walls

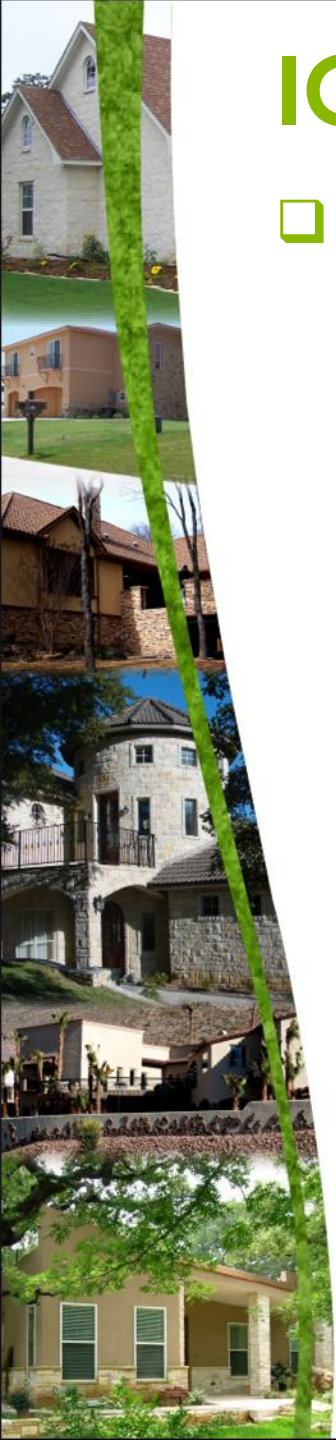

ICF Construction Process

□ Curves

- EPS Foam can easily be shaped to create
 - Arches
 - Radius walls
 - Pilasters
 - Step footings
 - Parapet walls
- Their small, modular size makes ICFs a great option for creating curving or angled walls
 - Radius forms are also available directly from the factory or may be constructed in the field



ICF Construction Process

□ ICF Flexibility Examples

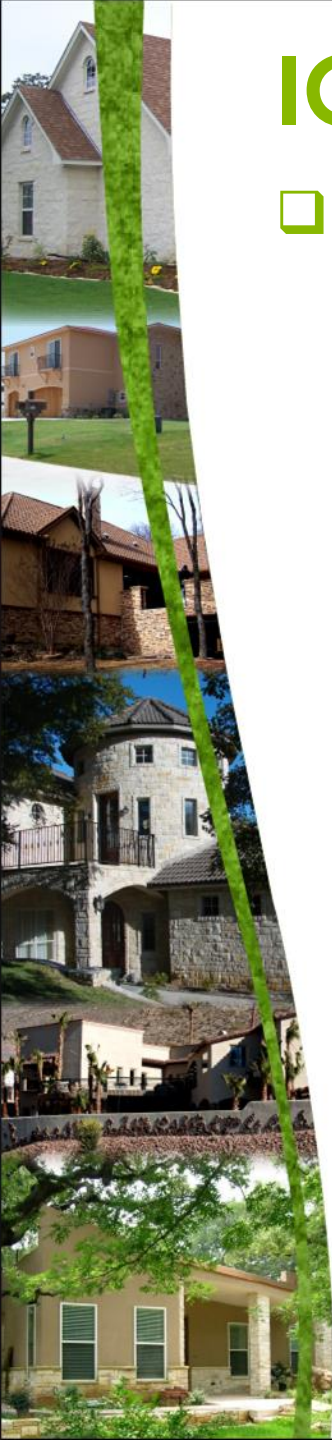

ICF Construction Process

□ ICF Flexibility Examples



ICF Construction Process

□ ICF Flexibility Examples



ICF Construction Process

❑ Floor and roof options

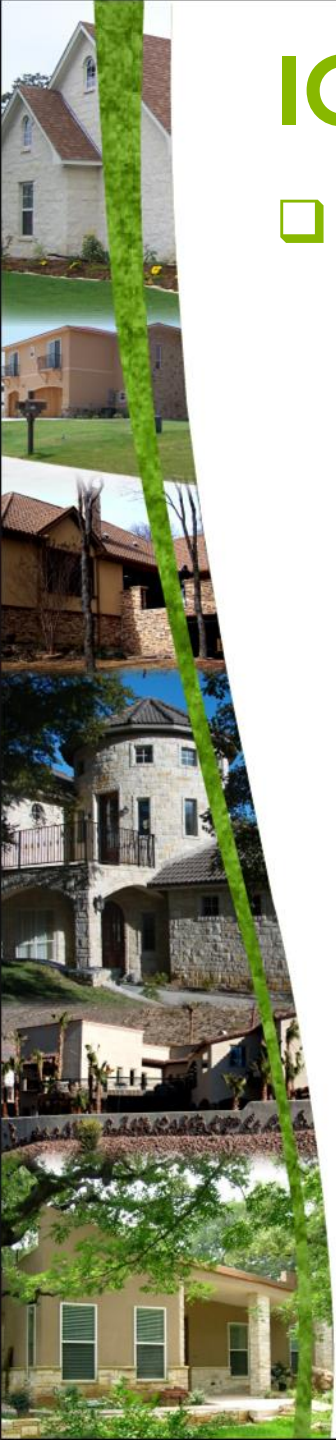

ICF Construction Process

❑ Floor and roof options



ICF Construction Process

❑ Roof Connections

- Anchor bolts or hurricane clips
 - Installed per local building code or as specified
- Roof sill plates
 - Installed per local codes or as specified
 - Roof sill plates can be recessed 1 ½" in form to locate ceiling joist tight to EPS of wall, reducing thermal bridging



Integration with MEP

□ Electrical

- Electrical Installations rough-in for electrical work is accomplished in various ways
- Electrical installations must conform to local electrical codes and standards

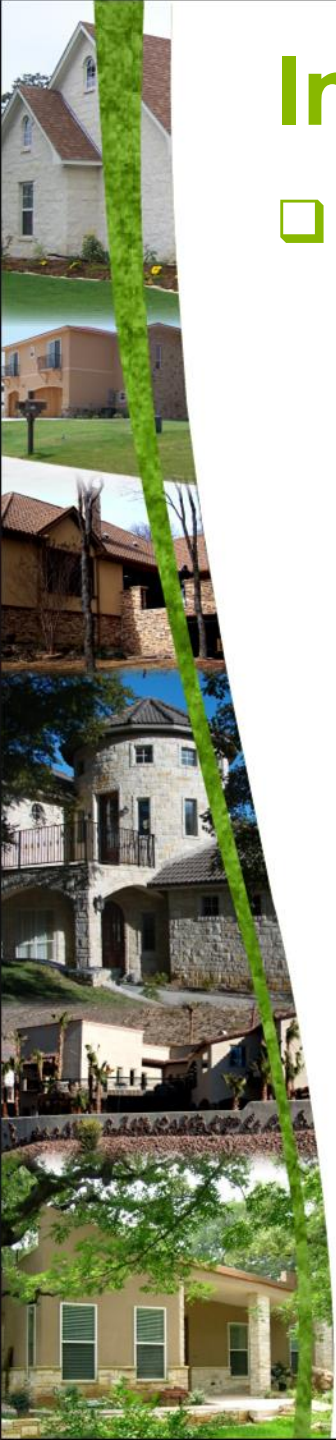
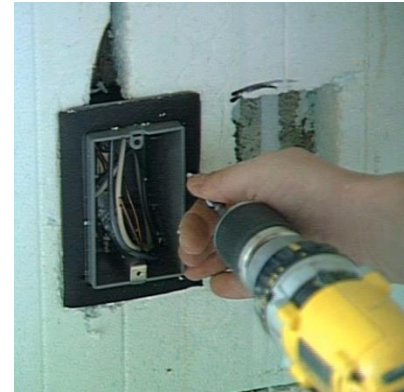

Integration with MEP

❑ Plumbing

- Installations up to 1 ½" PVC pipe with coupler in most flat wall systems
- Because the walls are solid concrete, plan electrical, plumbing and mechanical chases as in a regular concrete building

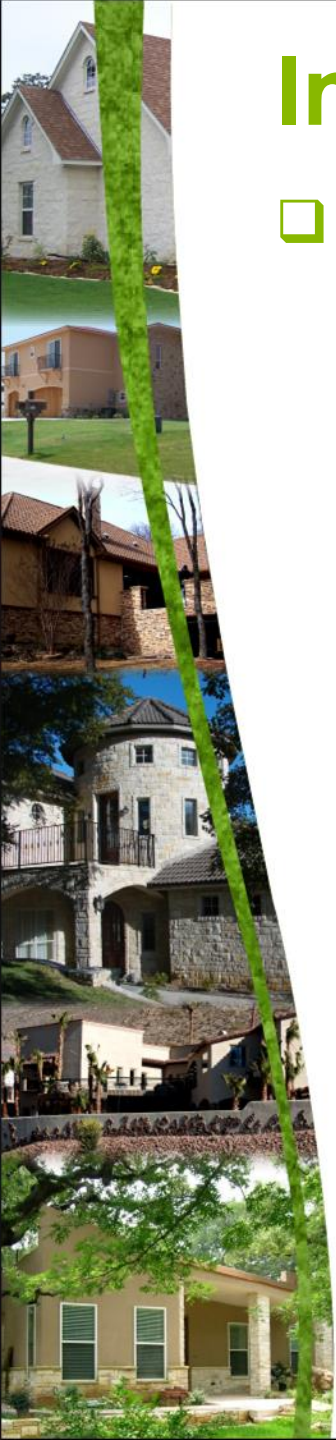
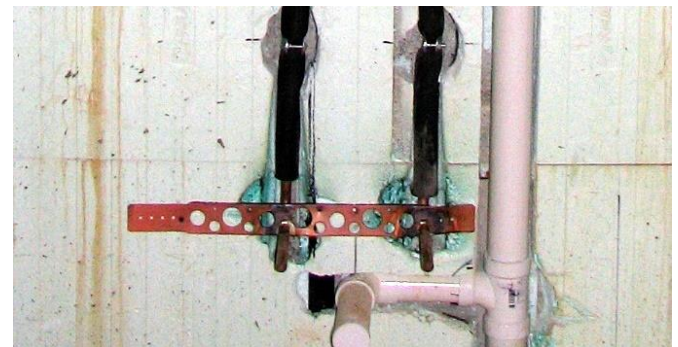

Integration with MEP

❑ Mechanical

- Rough in same as electrical & plumbing
- Be sure to coordinate closely with other trades during ICF installation process

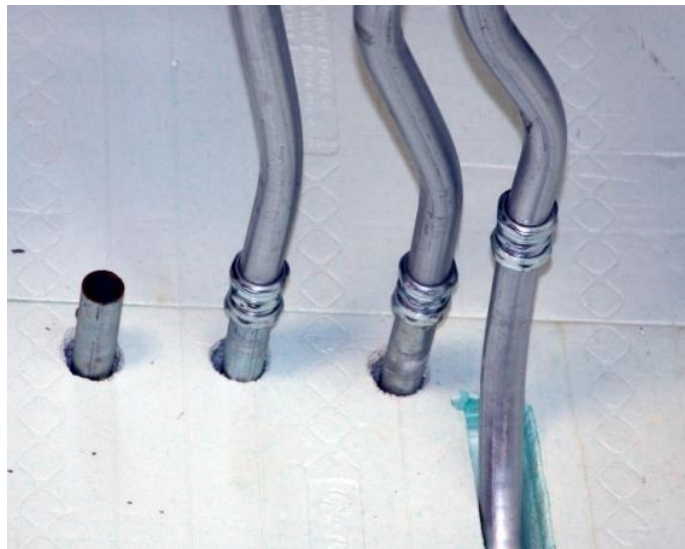
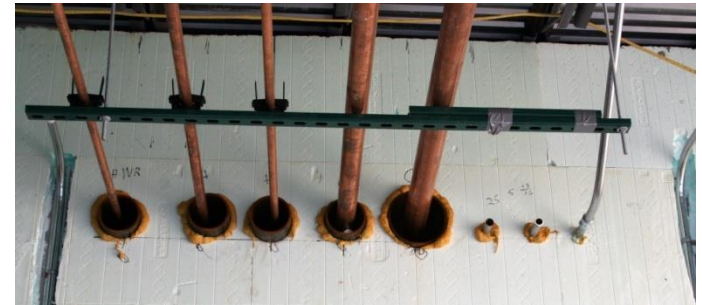

Applying Codes to ICF Systems

❑ ICFs combines 6 Wall Elements within 1 product

1. Form System
2. Wall Structure
3. Insulation
4. Air Barrier
5. Vapor Barrier
6. Interior & Exterior Anchorage

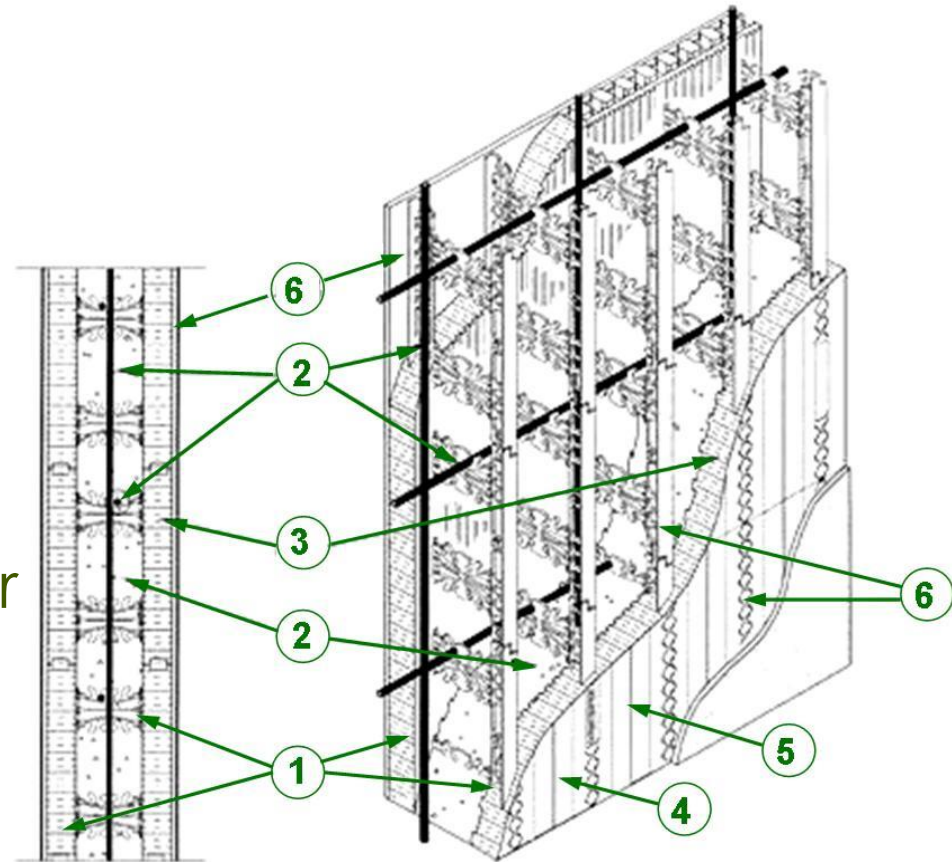

Applying Codes to ICF Systems

□ Energy Efficient

- “Thermal Mass Effect” enables an R22 insulation value to perform equivalent to a low mass wall of significantly higher R-value

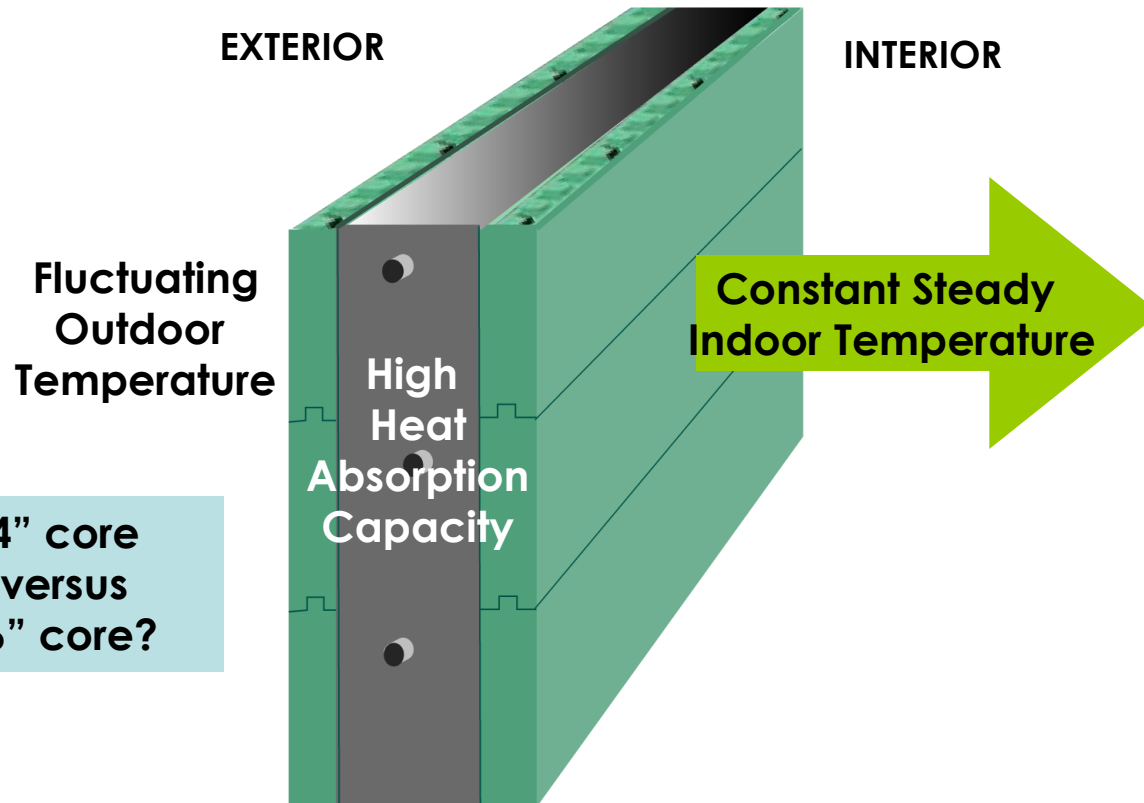

EXOAIR® 230

Next generation of high-performance air barrier membranes

- **High-Temperature Resistant** -

Specially formulated for high temperature resistance allowing product stability at intermittent temperatures up to 240 °F (116 °C), permitting use of the product during projects where high temperature exposures are a concern.

- **NFPA 285 Compliant** - Independent UL

Certification for NFPA 285 provides peace of mind and simplifies the process for architects, consultants and specifiers when determining International Building Code (IBC) compliance for fire propagation characteristics.

- **Vapor Permeable** - Formulated to

retard the migration of air and bulk water while permitting water vapor to pass through resulting in greater flexibility of the air barrier membrane placement within the wall design.

- **Primerless** - Primerless installation and adhesion accelerates construction schedules.

- **UV Resistant** - Contains a UV resistant formulation that grants the flexibility to install rainscreen systems with open joints or allows extended membrane exposure during the construction process.

- **Accelerated Installation** - The ability to roller or spray apply the material accelerates installation times when compared to traditional self-adhered membrane systems.

- **Custom Colors** - Custom coloring is available to meet all design specifications.

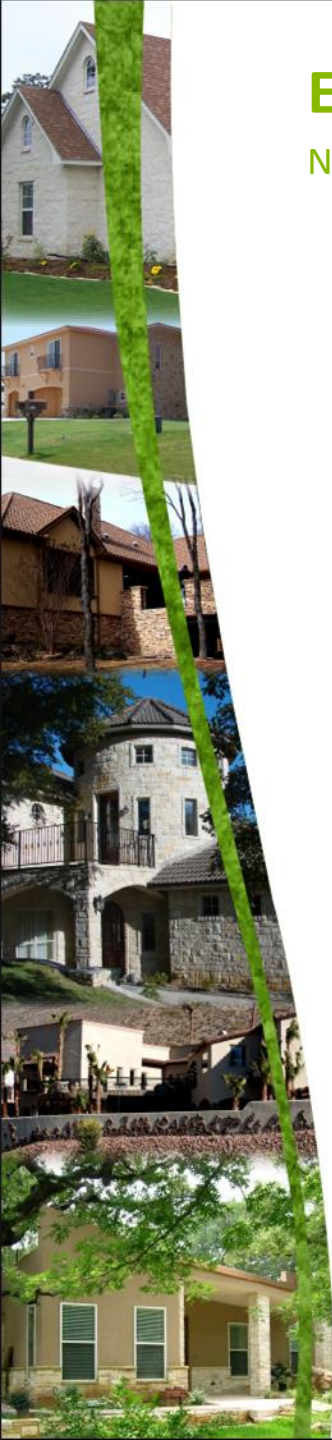

Applying Codes to ICF Systems

□ Air Tight Envelope

- Solid monolithic concrete wall eliminates air infiltration within the wall cavity of traditional systems

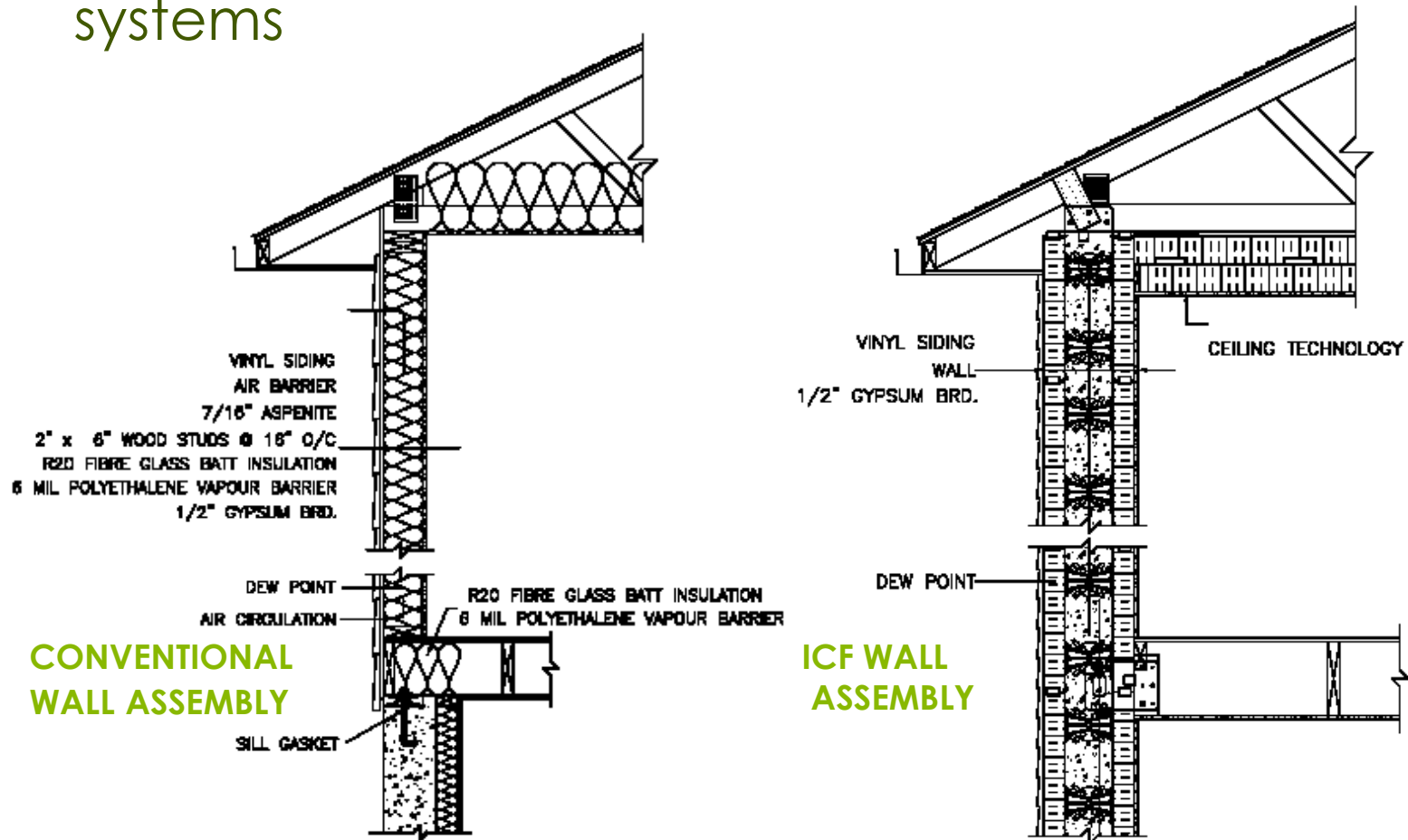

Applying Codes to ICF Systems

❑ Superior Sound Barrier

- ICFs provide high sound absorption
- 6" concrete core provides an STC of 50+
- Can easily be adapted to as high as STC 71 or more



Applying Codes to ICF Systems

❑ Superior Wind Resistance

- Greater impact resistance against natural disasters
 - Protection from hurricane and tornado damaging winds and debris
 - Solid monolithic ICF concrete walls can be designed to meet seismic requirements more easily than concrete block

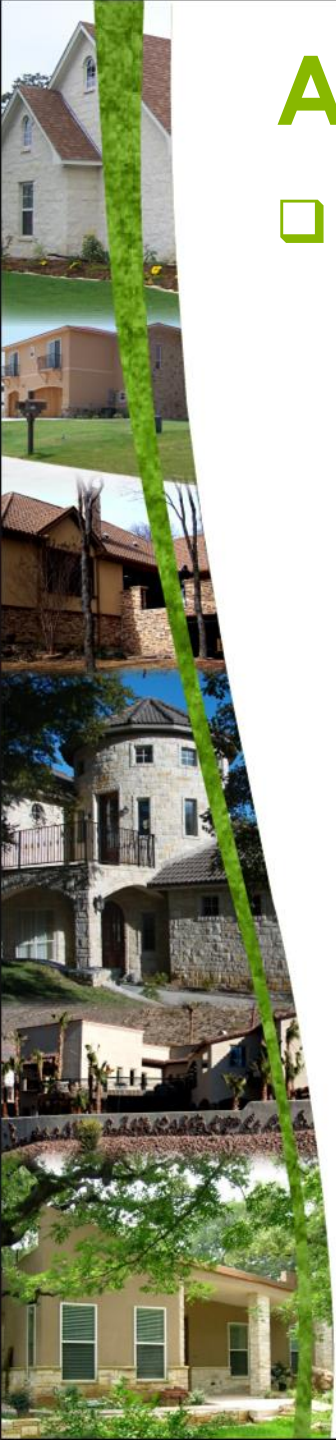

Applying Codes to ICF Systems

□ Superior Fire Resistance

- 6" concrete core resists up to 4-hour fire resistance rating exceeding ASTM E-119
- ICFs are composed of non-combustible self-extinguishing materials
- Code dictates all foam plastics be protected with a thermal barrier



UL -U930

During fires in this San Diego, CA neighborhood, 3 of the surviving structures were constructed with ICFs



Applying Codes to ICF Systems

❑ Superior Mold Resistance

- EPS foam will not propagate mold growth
- Passes all fungi resistance testing

TEST DATE: 5/28/04 - 6/26/04.

RESULTS: Test data and results on the following page(s).

CONCLUSION: The samples do comply with the requirements of ASTM C1338-2000 for fungus resistance.

CERTIFICATION: The tests reported here were conducted under the continuous direct supervision of SGS U.S. Testing Company Inc., Tulsa, OK.

**SIGNED FOR AND ON BEHALF OF
SGS U.S. TESTING COMPANY INC.**



bk Jeffrey Simmons
Manager Laboratory Operations



Dale E. Holloway
Branch Manager Laboratory Operations

Applying Codes to ICF Systems

❑ Code Approvals

- Check with individual ICF manufacturers for specific code information and testing reports



Architectural Details

- Most ICF manufactures have standard design details

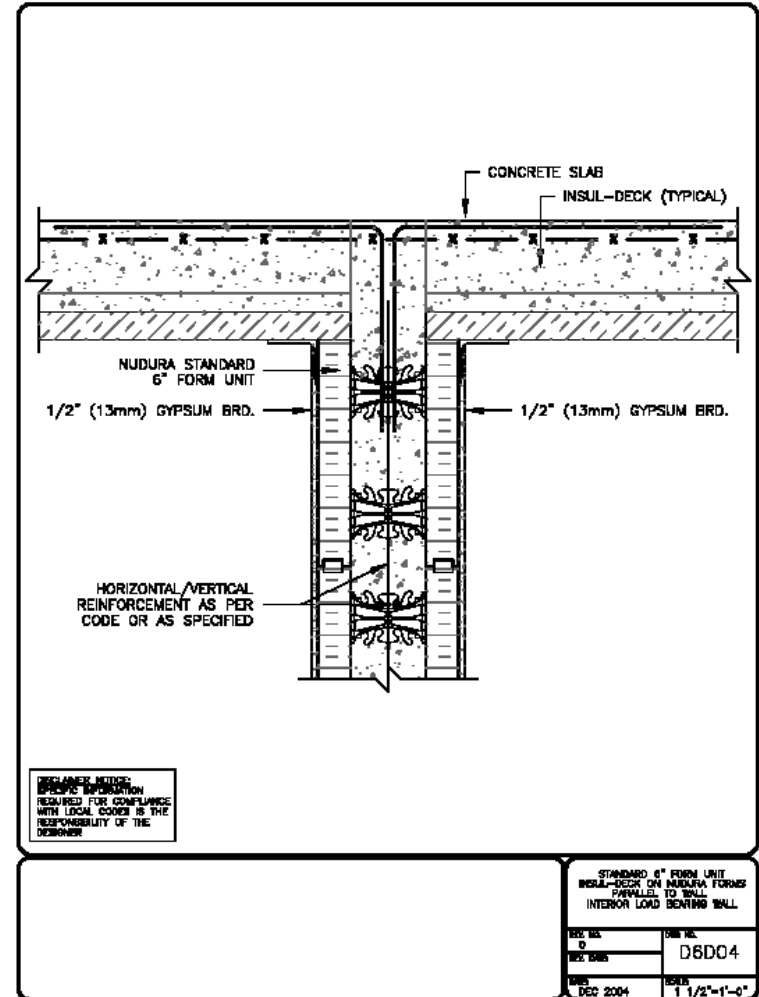

Sustainable Design

□ Building Green with ICFs

- Designing and building with ICFs helps attain Leadership in Energy and Environmental Design (LEED®) Green Building status
 - (See "[ICF Points to LEED](#)" handout)
- Consult manufacturers for reports on possible point attainment under LEED®



"The LEED® (Leadership in Energy and Environmental Design) Green Building Rating System is the nationally accepted benchmark for the design, construction, and operation of high performance green buildings."

Sustainable Design

□ Building Green with ICFs

- ICF construction can significantly contribute to:
 - 1. Optimized Energy Performance
 - 2. Durability
 - 3. Recycled Material Content
 - 4. Local Materials
 - 5. Improved Indoor Air Quality
- Other "green" advantages include:
 - Air-tight construction
 - No off-gassing for better control of indoor air quality
 - Minimal construction waste
 - Durable building materials
 - Energy efficiency performance increased by 25-50%
 - Enables increase of daylight to building

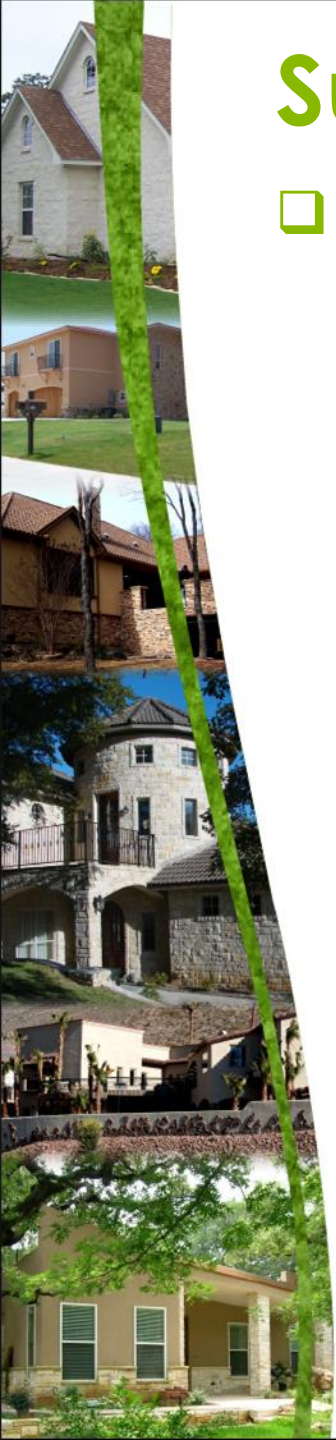

Examples of ICF Structures



- ❑ Residential
- ❑ Small Commercial

























ICF Construction Process Discussion

- ❑ Differences compared to typical wood process:
 - Slab
 - Dowels
 - Plumbing
 - Electrical
 - Roof Connection
 - A/C & Peak Loads
 - Embeds



Nudura is now part of



THANK YOU

PRESENTED BY
Cameron Ware

cware@Nudura.com

www.nudura.com

817.437-4585

866.468.6299

