



OLED TV

User's Manual



SL6524TM





Please read this manual carefully for proper usage before installation and use. It is recommended to keep this manual properly for future check. The pictures in this manual are only for reference.

Contents

Safety Warning and Notice	1
Mounting and Connecting	3
Packing list.....	3
Mounting the TV set.....	3
Connecting peripheral equipment.....	4
Panel Control Keys	5
Remote Control	5
Basic Operations	7
Turning on/Standby.....	7
Signal source selection.....	7
Menu operation description	7
Channel scanning.....	7
REC option.....	7
Time Shift option.....	8
Instructions for quick start	8
Basic Operations.....	8
Quick Start.....	8
Smart Applications.....	8
Network Settings.....	9
OLED Panel Care Functions	10
Recommendations	10
Important Statement on Network Services	10
Troubleshooting	11
Technical Specifications	12

Safety Warning and Notice

Thanks for choosing the high-performance and multifunctional intelligent OLED TV produced by our company. This precious thing will bring you better audiovisual enjoyment. The design of this product has given consideration to factors affecting personal safety, and the product itself has gone through strict tests prior to delivery. However, improper operation may result in electric shock and fire disaster. To ensure safety, prolong the service life of this product, and make sure the best performance of this product can be given full play to, please read the manual and marking label carefully before using it and comply with the following safety instructions. Please keep the user manual for later use.

 Warning	May result in casualties
	Indicate the behaviors that must be prohibited
 Attention	May result in personal injury or property losses
	Indicate the operations that must be performed

Under Following Conditions

- Power failure or unstable voltage.
- Abnormal sound or smell from the device.
- AC power cord is damaged.
- TV set is damaged due to falling off, knock or impact.
- Any liquid or foreign matters enter into the TV set.

Turn off the TV set immediately, unplug the power cord from the power outlet, and contact authorized maintenance personnel.

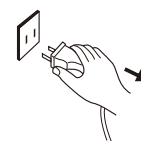



- **If coal gas or other flammable gases leak, do not unplug the power cord of the TV set or other electric appliances; instead, close the valve of the gas immediately and open the doors and windows.**

 **Warning**

-  ● Only use 100-240VAC, 50/60Hz power supply.
- All cables can be connected or pull out only after power supply is turned off.
- Do not fix the TV set on instable position, or else it may cause falling off, damage, or even fire.
- Do not put the TV set in the environment:
 1. With direct sunshine, moisture, overheating, undercooling or heavy dust;
 2. With flammable or explosive substance;
 3. With flammable or corrosive gas;
 4. In bathroom, kitchen, etc.
- Do not use damaged or improper power socket, and ensure that the plug and socket are connected properly.
- Keep the power plug and socket free of dust and metal pieces.
- Do not damage the power cord:
 1. It is prohibited to refit the power cord;
 2. Do not put heavy object on the power cord;
 3. Keep the power cord away from heat source;
 4. Do not drag the power cord when unplugging.
- Do not connect too many appliances to one power strip, or else it may cause fire due to high power consumption.
- Do not let open flame (e.g. lit candle) approach the TV set, or else it may cause electric shock or fire.
- Do not put the container filled with water on the TV set, to avoid electric shock or fire caused by water drop or splashing.
- Do not penetrate any sharp object, metal or liquid into the signal connector or air vents, to avoid short circuit and product damage as well as electric shock.
- The slots on the case is designed to release heat so as to assure that all inside components will not reach an extra high temperature and can work normally for a long time. Please do not cover the holes while place it.

 **Warning**

-  Do not touch the plug with wet hands, or else it may cause electric shock.
-  Do not turn on the TV set in thunderstorm weather; instead, unplug the power plug and antenna connector to avoid lightning strike.
-  Do not disassemble the TV set by yourself, or else it may cause electric shock or fire. Contact qualified personnel for maintenance.

 **Attention**

- Do not let children climb onto the TV set.
- Keep the small accessories away from children's reach to avoid swallowing.
- If the TV set won't be used for a long time, please turn off the device and unplug the power cord.
- Before cleaning the TV set, unplug the power cord and wipe with soft cloth; do not use chemical reagents and avoid foreign substances entering into the device. The incorrect cleaning (such as cleaning fluid, water, etc) may lead to damage of product's appearance, erasing products printing information, even flow into the machine and damage components, cause machine can not display.
- To adjust the position or angle of the TV set, please disconnect all wires and move slowly to avoid falling off.
- Do not rub with hard object, knock at, bend or squeeze the screen.
- Do not use machine immediately after transferring machine to the places with high temperature from low temperature, which will cause fogging inside machine and failures.
- If the screen is broken and the liquid splashes on skin, please wash with clean water immediately for 15 minutes, and go to see your doctor.
- To move the television, at least two persons are needed to raise the base of television, keep the television upright, not tilt.
- Do not jog the television or press the panel to prevent from damage.



Attention

- **Displaying the same image for a long time or active image with fixed words, icons will leave "image persistence" on screen which will not disappear after powering off for a long time. This undesirable phenomenon is not covered by warranty.**
- **Healthy TV watching:**
 1. **Watch in appropriate light; poor light or long time watching may hurt your eyes.**
 2. **Adjust the volume appropriate to avoid hurting your hearing.**
- **Unplug the power cord of the device to cut off the power supply.**
- **If a power plug or appliance coupler is used as disconnecting device, it should ensure easy operation.**
- **Power plug shall be connected reliably. Loose power plugs may cause sparkle and fire.**
- **All the technical specifications in the user's manual and on the packaging are subject to changes without prior notice. If there is slight deviation between the user's manual and actual operation, the latter shall prevail.**

Google TV is the name of this device's software experience and a trademark of Google LLC. Google, YouTube, Google Cast, YouTube Music and other marks are trademarks of Google LLC.

Google Assistant is not available in certain languages and countries. Availability of services varies by country and language.



The terms HDMI, HDMI High-Definition Multimedia Interface, HDMI Trade dress and the HDMI Logos are trademarks or registered trademarks of HDMI Licensing Administrator, Inc.

Mounting and Connecting

Packing list

1. The TV set.
2. User Manual.
3. Remote control.
4. Power cord (or attached to TV set).

Mounting the TV set

Tips on Installation

- The TV set should be mounted near the AC power socket for easy plugging and unplugging.
- To avoid hurt, it is required to place the TV set on stable plane.
- Do not place the TV set at any place susceptible to mechanical vibration.
- Do not place the TV set at any place that insects may enter.
- Do not mount the TV set against air conditioner, or else the internal panel of the display may condense moisture and cause failure.
- Do not place the TV set at any place with strong magnetic field, or else it may be interfered with and damaged by electromagnetic wave.

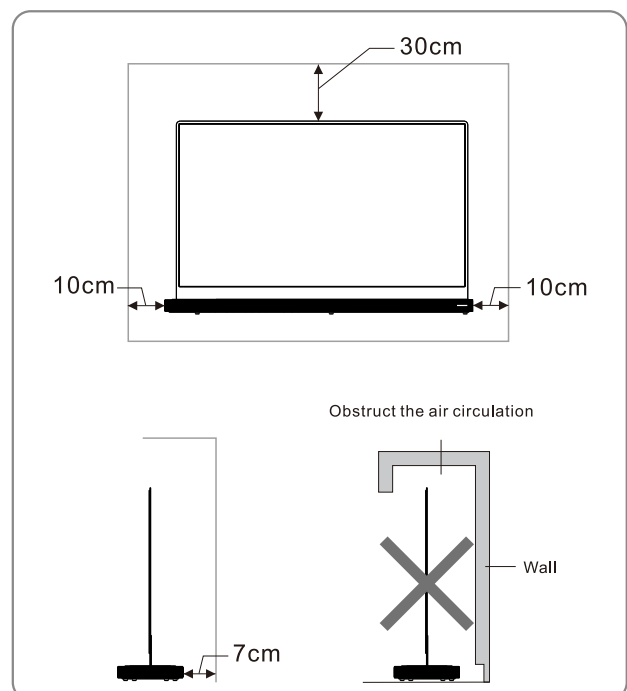

Ventilation

- Please keep this space at least around the TV, as shown in the figure.
- Do not cover the air vents or insert any object into the enclosure.
- Do not put the device in limited space, e.g. bookcase or embedded closet, unless the TV set is properly ventilated.

Warning

Never place a television set in an unstable location. A television set may fall, causing serious personal injury or death. Many injuries, particularly to children, can be avoided by taking simple precautions such as:

- Using cabinets or stands recommended by the manufacturer of the television set.
- Only using furniture that can safely support the television set.
- Ensuring the television set is not overhanging the edge of the supporting furniture.
- Not placing the television set on tall furniture (for example, cupboards or bookcases) without anchoring both the furniture and the television set to a suitable support.
- Not placing the television set on cloth or other materials that may be located between the television set and supporting furniture.
- Educating children about the dangers of climbing on furniture to reach the television set or its controls.

If your existing television set is being retained and relocated, the same considerations as above should be applied.

Connecting peripheral equipment

Remark:

1. When you need to connect the device which support the eARC function, please select the HDMI 3 interface.
2. HDMI connector can realize DVI connector function with external HDMI/DVI commutator.
3. The peripheral equipment and cables described in this manual should be purchased separately.

Warning

When connecting outdoor antenna to signal port of the TV set, please turn off the main power switch of the TV set first. Do not approach the outdoor antenna to high voltage mains power line to avoid electric shock. The wired network antenna connected to this TV set must be isolated from the protective grounding, or else it will cause fire or other hazards.

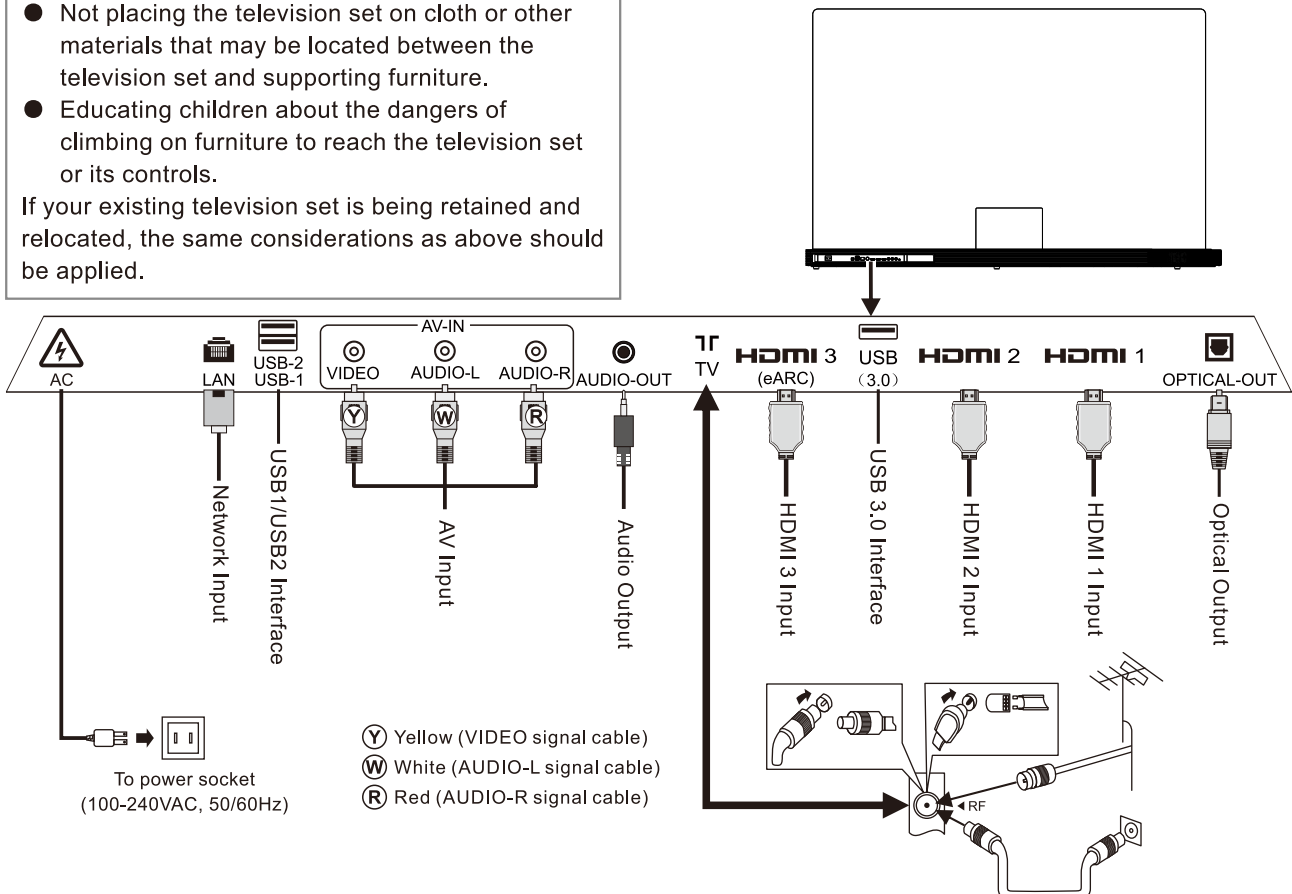

Panel Control Keys

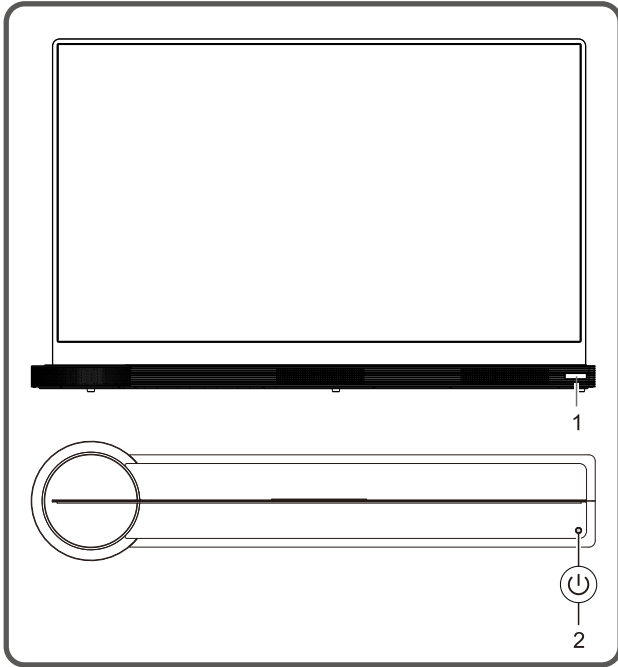

1. Power LED indicator and remote receiving window.
2. ⏻ Standby: To switch the TV on or back to standby.

Remark:

- ①. The appearance varies depending on the model, and the actual product shall prevail.
- ②. Please use the remote control for more operation.

Remote Control

Method for Installation of Remote Control Battery

Remove the battery compartment cover and insert two AAA (No. 7, 1.5V) batteries; make sure the polarity of the batteries is in compliance with the polarity mark "+" and "-" in the battery compartment of the remote control.

Precautions for using the remote control

- The remote control should be pointed at the remote control sensor during operation. An object placed between the remote control and the remote control sensor may impede normal operation.
- The remote control should be prevented from strenuous vibration. Besides, please do not set or place the remote control under direct sunshine, as heating power may result in deformation of the remote control.
- Remote control failure may occur when the remote control sensor of the main unit is under direct sunshine or strong lighting; in this case, please change the angle of lighting or this TV set, or operate the remote control near the remote control sensor.
- Low battery will influence the remote control distance, in which case, the battery should be replaced with a new one. If the remote control is going to be idle for a long time or the battery runs out, please take the battery out to prevent the remote control from being corroded by battery leakage which may result in damage and failure of the remote control.
- Please do not use batteries of different types. It is not allowed to use old and new batteries together; the batteries should be replaced in pair.
- Please do not throw the batteries into fire or charge or decompose the batteries; do not charge, short-circuit, disassemble/assemble, heat or burn used batteries. Please dispose the waste batteries pursuant to relevant regulations on environmental protection.

Voice remote control operation manual

Pairing the voice remote control

If the remote control is not paired, press the Google Assistant key, then long press [←] + [🏠] keys to pair. When the TV show the device, select it and press [OK] key to finish.

Note:

1. Some models may not be supported.
2. Your Location must correspond to the language for exact search results. Some functions may not be available if your location settings and

language settings are different.

3. You can change the language according to language input settings. The languages available for Google Assistant may be changed in accordance with service operation policy.
4. Details of service may vary by model.
5. Before you use Google Assistant, you should make sure remote control paired.

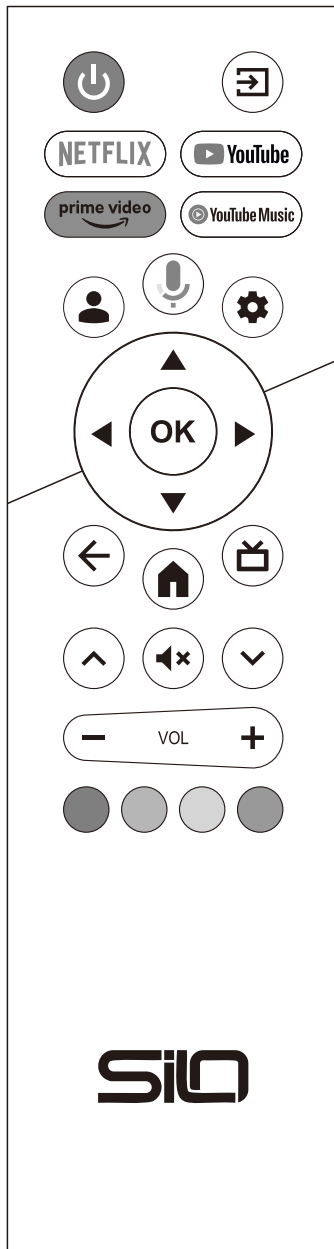

Keys of the Remote Control

Note: The appearance of the remote control may be different from this diagram; please refer to the real object as standard.

Keys	Function
Power (⏻)	Switch between working and standby status.
Source (📺)	Show signal source menu.
NETFLIX	Open application.
YouTube	Open application.
prime video	Open application.
YouTube Music	Open application.
👤	Manage Google Account. (It is valid after login)
🎤	Microphone / Google Assistant Ask Google Assistant to find movies, stream apps, play music, and control the TV - all with your voice.
Setup (⚙️)	Open the Dashboard menu.
◀️, ▶️, ▲, ▼	Select items or adjust values.
OK	1. Show the TV function menu.(In TV mode) 2. Confirm the operation.
Back (←)	Return to previous menu or exit the menu.
Home (🏠)	Show home page.
📺	Electronic program guide.
⬆️ / ⬇️	Change channel.
Mute (🔇)	Turn on/off the sound.
VOL + / -	Turn up/down the volume.
Red key	Special function keys.
Green key	
Yellow key	
Blue key	

Basic Operations

Remark:

1. The keys operation here refers to remote control operation, as for panel control keys operation, please refer to "**Panel Control Keys**".
2. Menu Operation Instruction in this manual explains the operation under TV mode, which could also be the reference to other modes.
3. Before powering on platform, please make sure that the power supply is stable.
4. The software of different countries is different. The specific software operation should be subject to the actual situation.
5. Because the product is constantly updated, the software is upgraded at any time, if the software operation is different from the actual operation, please refer to the actual product.

Turning on/Standby

Plug power cord into the electrical socket, then press [⏻] key to turn on the TV. When it is the first time to turn on the TV, the Initialization Settings interface appears, please set it as needed.

In power on state, press [⏻] key to switch to standby mode.

Signal source selection

You can connect various devices to the TV set and view high quality images. If the video device has HDMI, AV and other video output ports. You can select one of them and connect to corresponding input ports of the TV set. After connection, turn on the device and press [⏻] key, then menu of signal source will be displayed on the screen. Press the [▲]/[▼] key to select the input signal, and press [OK] key to confirm .

Menu operation description

Press [OK] key to show the TV function menu on the screen:

1. Press [▲]/[▼] key to select a menu from **Channels, TV options**.
2. Press [◀]/[▶] key to select an item in the menu.
3. Press [OK] key to enter the submenu.
4. Press [▲]/[▼] key to adjust the value or setting.
5. Press [←] key to return to previous menu or exit the menu.
6. During menu operation, the icons of invalid options are gray.

Note: Different channel types have different TV menus, please refer to the actual.

Channel scanning

Scan channels if it is the first time to use the product. Before scanning, please make sure that the antenna has been connected properly.

ATV Scanning

After selecting **ATV** source, press [⚙️] key, and press [▲]/[▼]/[◀]/[▶] key to select ⚙️ > **Channels & Inputs > Channels > Channel Scan**, then press [OK] key to enter.

- Select **Analogue Auto Scan**, and press [OK] key, then the machine starts auto scanning.
- Select **Analogue Manual Scan**, and press [OK] key, then set **Program, Audio System, Color System, Frequency**. Select **Start Scan**, and press [OK] key, then select **Scan Up** or **Scan Down**, and press [OK] key, the machine starts scanning.

DTV Scanning

After selecting **Cable/Antenna** source, press [⚙️] key, and press [▲]/[▼]/ [◀]/[▶] key to select ⚙️ > **Channels & Inputs > Channels > Channel Scan > Tuner Mode > Antenna/Cable**, then press [←] key.

If the tuner mode is **Antenna**.

- Select **Antenna Auto Scan**, and press [OK] key, then the machine starts auto scanning.
- Select **Antenna Manual Scan**, and press [OK] key. Set **Channel Number, Frequency(MHz), BandWidth(M)**, and select **Start Scan**, then press [OK] key, the machine starts scanning.

If the tuner mode is **Cable**.







- Select **Cable Auto Scan**, and press [OK] key, then set **Scan Type, Frequency(MHz), Network ID**. Select **Start**, and press [OK] key, then the machine starts auto scanning.
- Select **Cable Manual Scan**, and press [OK] key. Set **Channel Number, Frequency(MHz)**, and select **Start Scan**, then press [OK] key, the machine starts scanning.

REC option

In DTV mode, press [OK] key, select **Channels > Start Recording**. Press [OK] key to select recording time, and the machine start recording. In the process of recording, select **Channels > ■ REC**, then press [OK] to save and exit recording.

Press [OK] key, then select **Channels > Recorded Programs**. Select the file that you want to play, and press [OK] key. Select **Play recording**, then press [OK] key to play it.

While playing, press [OK] key to display toolbar. Select the menu option which you want, and press [OK] key to perform the operation. You can press [←] key to exit playing.

Icon	Description
	Play: Play.
	Pause: Pause.
	FB: Fast back.
	FF: Fast forward.
	Forward: Make a 15S jump forward.
	Backward: Make a 15S jump backward.







Note: Only the memorizer with FAT32 file system supports the recording function. Memorizer with other file systems need to be formatted; Before formatting memorizer, please back up useful data because the content of memorizer can not recover after formatting.

Time Shift option

In DTV mode, press [OK] key, and select **Channels > Start TimeShift**, then press [OK] key to turn on the time shift function. Press [←] key to stop and exit time-shift.

When user pauses program for a short time, time-shift function can suspend and cache the playing program to U disk. When user resumes playing, the program can continue to be played.

In the process of the time shift, press [OK] key, and select **Play controls** to display toolbar. Select the menu option which you want, and press [OK] key to perform the operation.

Icon	Description
	Play: Play.
	Pause: Pause.
	FB: Fast back.
	FF: Fast forward.
	Forward: Make a 15S jump forward.
	Backward: Make a 15S jump backward.

Instructions for quick start

Note: Please log in to your Google Account to get access to more features.

Basic Operations

Press [⬆] key to show the home page.

1. Press [▲]/[▼]/[◀]/[▶] key to select an application;
2. Press [OK] key to run the application;
3. Press [←] key to return to previous page.

Quick Start

Before using this device, please get familiar with the operations below for better experience.

Language input setting

Language: In the smart mode, select the system language. Press [⚙] key, and select ⚙ > **System > Language**, and press [OK] key. Press [▲]/[▼] key to select the desired language, and then press [OK] key.

Selecting Input Method: In the smart mode, press [⚙] key, and select ⚙ > **System > Keyboard > Current keyboard**, and press [▲]/[▼] key to choose input method.

Setting System Time: In the smart mode, press [⚙] key, and select ⚙ > **System > Date & Time > Automatic date & time**, then select **Use network-provided time**. You can also set the system time manually.

Smart Applications

Apps: The **Apps** helps users manage applications, and allows users to install or uninstall apps in local disk.

Press [⬆] key, then press [▲]/[▼]/[◀]/[▶] key to select an application and press [OK] key to enter.

■ How to install an application?

Press [⬆] key, and select apps, then press [OK] key to enter, search apps you want and install them.

■ How to uninstall an application?

Press [⬆] key, and select the app that you want to uninstall, long press [OK] key and select to View details and uninstall it.

Media Player: Open **Media Player** app, and press [OK] key to enter and select **All, Photo, Audio,** and **Video.**

■ **Playing Files in local disk device:** Before playing files in the local disk, insert the USB mass storage device into the USB interface.

Open **Media Player** app, and press [OK] key to enter. Select the target folder or file, press [OK] key to enter the folder or play the file, and press [←] key to return to the desktop.

Attention:

1. Non-standard USB devices can't be recognized probably; in this case, please replace a standard USB device;
2. The stream media system has certain restriction on the format of files; the playing will be abnormal if it is out of the system restriction;
3. Do not remove the USB device while playing, or else the system or device may have problem; Before replacing the USB device, please turn off the machine's power supply;
4. The USB-1 and USB-2 ports support standard USB1.1 and USB2.0 devices. The USB(3.0) port supports standard USB1.1, USB2.0 and USB3.0 devices, such as USB mass storage devices and mobile hard disks;
5. The maximum output current of the USB-1 and USB-2 port of this device is 500mA. The maximum output current of the USB(3.0) port of this device is 900mA. The self-protection will be enabled if it is beyond this limit; please use external power supply if an external device of higher current will be connected;
6. The system is complicated; when it is reading or playing files, the screen may be still or certain functions may be invalid due to the compatibility and stability of the USB device; in this case, please turn off the device and re-initialize the system.

While playing, press [OK] key to display toolbar. Select the menu option which you want, and press [OK] key to perform the operation; you can press [←] key to exit playing.

Network Settings

Wi-Fi

1. In smart mode, press [⚙] key, select ⚙ > **Network & Internet > Wi-Fi**, and press [OK] key to turn on WiFi, then the machine automatically searches for nearby wireless network signal. The network searched without 🔒 icon indicate that the machine can connect to the network without a password. The network with 🔒 icon indicate that it is encrypted and you must enter the correct password to connect to the network;
2. Select the desired network from the list, and press [OK] key;
3. Enter the password in the password box, then select ✓ and press [OK] key to connect to network.

Ethernet

1. Press [⚙] key, then select ⚙ > **Network & Internet > ETHERNET**;
2. Set **Proxy settings** and **IP settings**, then press [OK] key to connect to the internet.

Wake On Network

It allows remote systems to wake up the sleeping TV by sending a frame of a specific format which the client anticipates. (It is available when network is connected.)

Press [⚙] key, and select ⚙ > **Network & Internet > WiFi Configs > Wake On Network**, then press [OK] key to set it to on or off.

OLED Panel Care Functions

Manual OFF-RS Compensation

OFF-RS is a fast image repair function that can repair many temporary images. In the process of OFF-RS, the screen does not display, and the standby light flashes. This process takes about 7 minutes, during which the AC power cannot be turned off. Otherwise, the repair action cannot be completed. After the repair is complete, the machine goes into standby mode.

In smart mode, Press [**⚙**] key, and select **Picture > Advanced Settings > OLED > Pixel Cleaning > OFF-RS**, and press [**OK**] key to enter. In the dialog box that appears, select **OK** and press [**OK**] key, and then the machine stands by and performs screen calibration operation.

Manual JB Compensation

Manual JB Compensation is a deep residual image repair function, when OFF-RS can not repair the residual image, you can try Manual JB compensation to repair. In the process of Manual JB compensation, the screen does not display, and the standby light flashes. This process takes about 1 minutes, during which the AC power cannot be turned off, otherwise the repair action cannot be completed. After the repair is complete, the motherboard enters the standby state.

In smart mode, Press [**⚙**] key, and select **Picture > Advanced Settings > OLED > Pixel Cleaning > JB**, and press [**OK**] key to enter. In the dialog box that appears, select **OK** and press [**OK**] key, and the machine is on standby and panel noise removal is performed.

Pixel Shift

With pixel offset enabled, the machine periodically moves pixels to prevent screen ghost. When pixel offset is used, some images at the edge of the screen may move outside the screen boundary and may not be visible. To hold the screen in its original position, turn off pixel offset. To prevent ghost images from appearing when viewing content that contains a large number of still images, turn on Pixel Offset.

In smart mode, Press [**⚙**] key, and select **Picture > Advanced Settings > OLED > Pixel shift**, and press [**OK**] key to turn on or turn off pixel offset.

Recommendations

Google Assistant

Use your voice to search for shows, control devices, and more - just ask Google Assistant.

Google Cast™

Easily cast your favorite movies, music, and more to your TV with Google Cast.

Important Statement on Network Services

All contents and services obtained from this TV set belong to the third party and are protected by laws on copyright, patent right, trademark right and/or other intellectual property right. The said contents and services are only for your non-commercial purposes. It is not allowed to use any content or service without the authorization of the content owner or the service provider.

Our company will undertake no liability for any direct, indirect and accidental losses or damages caused by your or a third party's access to any content or service or any information or any third party software through this set under any circumstances.

Third party service may be changed, deleted or stopped without prior notice. Our company neither implies nor guarantees the continuous availability of some service or content within any period of time.

Our company is not held responsible for services related to the said service and content. Besides, we will not bear any liability for client service. Please directly contact relevant content and service providers if you have any problem and service request concerning relevant service or content.

Troubleshooting

■ **Snowflake spots occur in the TV images and there is noise in accompanying sound.**

1. Check if the antenna plug is loose or the cable is in good condition.
2. Check the antenna type (VHF/UHF).
3. Adjust the direction and position of the antenna.
4. Try to use signal enhancer.

■ **There is neither display nor sound on the screen. The indication light is not on.**

Check if the power line is connected.

■ **Dotted line or strip disturbance occurs in TV images.**

Do not use electric hair dryer aside the TV set and adjust the antenna direction to reduce disturbance.

■ **Double images occur on the TV screen.**

1. Use high oriented antenna.
2. Adjust the direction of the antenna.

■ **The TV has no accompanying sound.**

1. Adjust the volume to a proper degree.
2. Press [MUTE] key on the remote control to cancel mute mode.

■ **No signal input images show on the machine screen. The indicator light is blinking.**

1. Check if the signal connecting cable is loose or falls off. Reconnect it.
2. The machine may be in standby mode, please reboot.

■ **The remote control distance is short or out of control.**

1. Remove the object to avoid blocking the remote control receiving window.
2. Replace the battery.

■ **The browser cannot access any link.**

1. Ask the network administrator to obtain available IP address and other parameters.
2. Check if the network connecting cable is normally connected.
3. Consult the network service provider.

■ **Online video play is very slow.**

1. Please upgrade your network bandwidth to a higher one.
2. Please try to replace with other addresses to obtain better resources.

■ **Machine is slow, system crash, can't operate the machine.**

Disconnect the power supply first, and connect the power supply after about 1-2 minutes, then turn on the TV again.

Technical Specifications

Master unit

65"

Max. Resolution	3840×2160
Power Supply	100-240VAC 50/60Hz
Power Consumption of Speaker	12W+12W+20W
Operating environment:	
Temperature	5°C~40°C
RH	20%~80%
Atmospheric pressure	86kPa~106kPa
Storage environment:	
Temperature	-20°C~55°C
RH	20%~80%
Atmospheric pressure	86kPa~106kPa

Dimension (L×W×H) and Weight

Including base	Unpacking: 1559×330×974 (mm ³)
	Packing: 1671×380×1083 (mm ³)
	Net Weight: 35.9 kg
	Gross Weight: 59.2 kg

Technical specifications for TV

- Supported standard:
ATV: PAL, SECAM.
DTV: DVB-T/C (DVB-T2 option).
- Antenna input: 75Ω coax, unbalanced.
- AV video input: 75Ω, 1±0.1Vp-p, RCA terminal.
- AV audio input: 20KΩ, 0.2~2Vrms.
- HDMI video input: 480i, 480P, 576i, 576P, 720P, 1080i, 1080P, 2160P.
- Specific internal memory capacity in accordance with actual configuration.
- Specific cache capacity in accordance with actual configuration.
- Wireless connection: Wi-Fi (IEEE 802.11 b/g/n/a/ac).

Power management

Mode	Power Consumption
Normal working	≤400W
Standby	≤0.5W

Note: If you turn on **Wake On Network** function, the maximum power consumption of the machine in standby mode does not exceed 1W.

HDMI display mode

Video mode			
NO.	Mode	Resolution	Refresh rate
1	SD	720×480i/p	60Hz
2		720×576i/p	50Hz
3	HD	1280×720p	50Hz
4			60Hz
5	FHD	1920×1080i/p	50Hz
6			60Hz
7	UHD	3840×2160p	24Hz
8			25Hz
9			30Hz
10			50Hz
11			60Hz

Remark: Under UHD mode, 50Hz and 60Hz refresh rate is effective only under HDMI version 2.0/2.1.

VESA mode			
NO.	Mode	Resolution	Refresh rate
1	VGA	640×480	60Hz
2	SVGA	800×600	60Hz
3	XGA	1024×768	60Hz
4	SXGA	1280×1024	60Hz
5	WXGA	1600×900	60Hz
6	WUXGA	1920×1080	60Hz
7	4K	3840×2160	30Hz
8			60Hz

Remark: Under 4K mode, 60Hz refresh rate is effective only under HDMI version 2.0/2.1.

