



# Ducted Systems Technical Services Service Tips Letter

Letter: **ST-012-2019**

Date: September 9, 2019

To: All Ducted Systems Branch Service, Sales, and Training Managers  
All Ducted Systems Distribution Service, Sales, and Training Managers

Subject: **Twinning - Standard ECM Gas Furnace**

Product: Source 1 twinning kit S1-33103764000

This letter is to announce that single-stage standard ECM furnace models TM\*E, RGF1\*E, and TM8X may now be utilized in “twinned” applications using Source 1 twinning kit S1-33103764000. Twinning is defined as **two** identical model residential gas furnaces connected to a common duct system. We strongly recommend the heating and cooling equipment is always properly sized based on an acceptable heat loss/gain load calculation. ACCA Manual J, ACCA manual N, or other approved methods may be used. Many different duct and equipment configurations can be used in twinning applications. The intent of this letter is not to go into system design, but to announce twinning is available for this equipment and discuss low voltage wiring, operation, and room thermostat control of different configurations and stages of equipment. This letter covers both residential and commercial outdoor sections connected to a twinned furnace application. A typical twinning application is shown to the right.

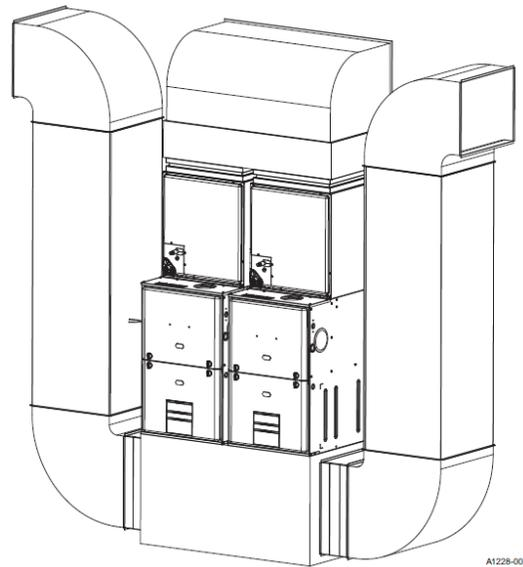

Source 1 twinning kit S1-33103764000 consists of one twinning control, two blower motor current sensors, two integrated furnace control wire harnesses and twinning kit installation instructions. Twinning kit components are shown below.

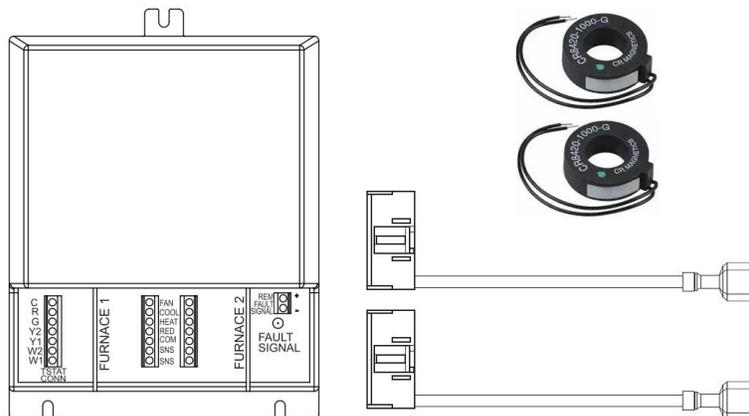

The twinning control serves multiple purposes:

- A – Operates primary and secondary furnace indoor blower motors simultaneously with any thermostat call.
- B – Monitors primary and secondary furnace indoor blower motor current in case a blower motor failure or loss of power to one furnace should occur.
- C – Isolates primary and secondary furnace low voltage power.
- D – Provides multi-stage room thermostat inputs so equipment can be operated as a multi-stage system.
- E – Provides true lead/lag control of furnace heating sections and outdoor equipment so equipment gets equal run time.
- F – Provides diagnostic information via on-board fault signal light.

As mentioned above, Source 1 twinning kit includes two integrated furnace control wire harnesses. These harnesses **must** be used to achieve simultaneous operating of the furnace indoor blower motors with a thermostat call. If not used there may be air recirculation, high limit trips, incorrect blower motor rotation, etc. When the twinning control receives either a single-stage (W1) heat call or multi-stage (W1 + W2) heat call, the twinning control immediately closes both furnace continuous blower motor circuits (R-G) to start the indoor blowers. Standard ECM furnace models utilize integrated ignition control 542760 (S1-03102951001). With a call for heat, the integrated furnace control will **de-energize** all outputs to the indoor blower motor regardless if the furnace has a continuous blower motor (R-G) input. The use of each integrated furnace control wire harness will insure continuous blower operation.

Furnace model numbers and blower motor speed tap selections are to be identical. Indoor blower motor wiring/setup on each furnace is to be as follows:

1. Disconnect the low voltage blower motor lead from the “G” terminal on the furnace control board and the indoor blower motor. Discard this removed wire.
2. Disconnect the low voltage blower motor lead from the “LO COOL” terminal on the furnace control board and the indoor blower motor. Discard this removed wire.
3. Disconnect the low voltage blower motor lead from the “HI COOL” terminal on the furnace control board.
4. Connect the insulated male end of the integrated furnace control wire harness (included with kit) to the blower motor “HI COOL” lead removed from the furnace control board.
5. Connect the opposite end of the integrated furnace control wire harness to the integrated furnace control P6 connector. An image of the integrated furnace control wire harness and integrated furnace control is shown below. The P6 connector is located close to the field low voltage wire connection terminal block.

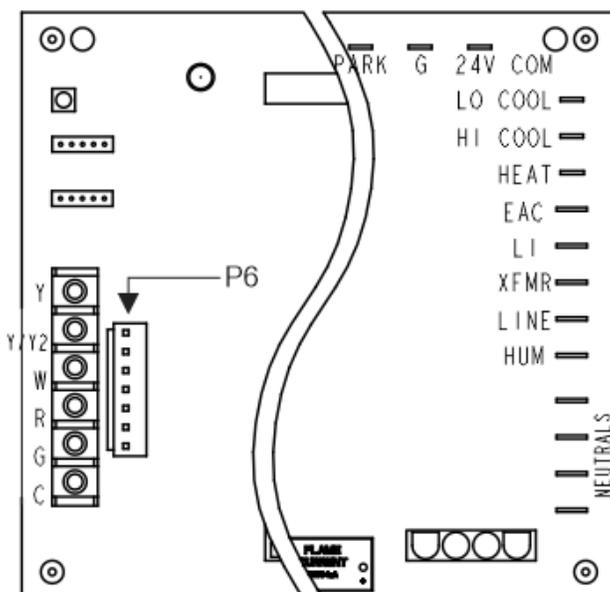

After the above wiring is complete, energize the twinning kit “G” signal to simultaneously energize the furnace blower motors. Measure and calculate total external static pressure (TESP) by taking a pressure reading at each location indicated by the GREEN arrows shown in the image to the right. Supply air external static pressure MUST be taken after the furnace before the indoor coil. Return air external static pressure MUST be taken after the furnace filter before the indoor blower. The supply air external static pressure is a positive number. The return air external static pressure is a negative number. Treat the return air static pressure as a positive number and add both return and supply air measurements together. This is total external static pressure. Using the indoor blower performance chart in the unit installation manual, reference the total external static pressure, model of furnace, blower motor speed tap utilized and approximate delivered cubic feet per minute (CFM) of air. For twinned installations, the relationship between TESP and CFM may be different than the blower performance chart as the chart is generated with a single furnace. In the example shown below the model furnaces used are TM9E100C20, .50” w.c. total external static pressure and blower motor speed tap selection of HIGH (#1). Blower performance chart indicates delivered CFM at 2006 cfm per furnace times 2 furnaces which is calculated at approximately 4012 CFM.

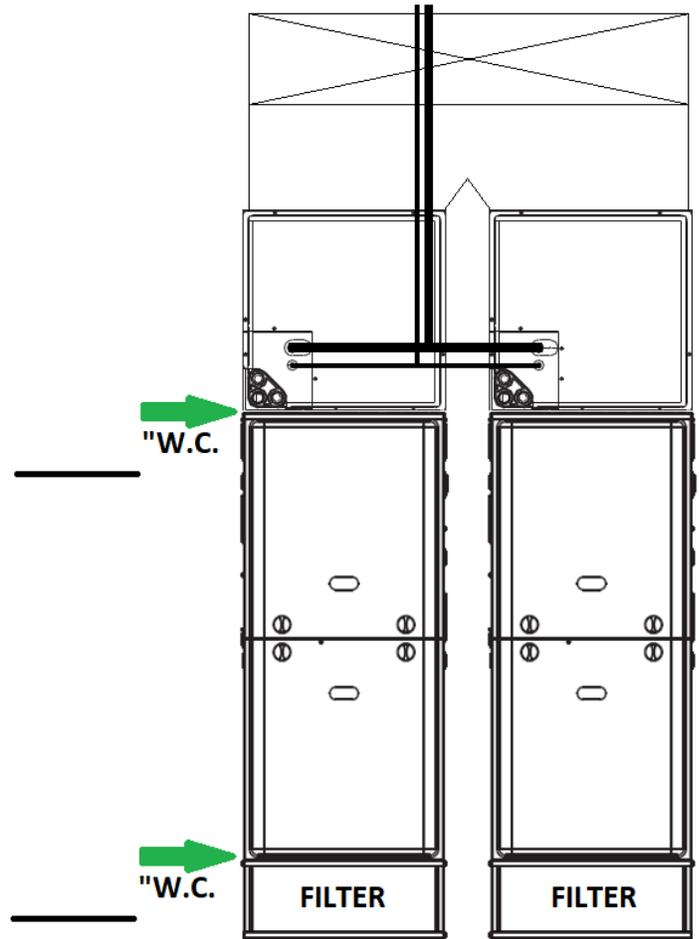

Models	Speed	Airflow Data (SCFM)							
		Ext. Static Pressure (in. H <sub>2</sub> O)							
		0.1	0.2	0.3	0.4	0.5	0.6	0.7	0.8
TM9E100C20	High	2140	2100	2070	2038	2006	1932	1871	1786
	Medium High	1883	1854	1818	1777	1720	1676	1649	1590
	Medium	1671	1624	1595	1557	1498	1450	1407	1351
	Medium Low	1581	1525	1493	1443	1394	1346	1292	1253
	Low	1350	1311	1244	1202	1138	1098	1053	978
TM9E120D20	High	2159	2118	2089	2050	2005	1939	1856	1756
	Medium High	1941	1907	1864	1824	1779	1736	1688	1645
	Medium	1789	1749	1714	1677	1629	1586	1540	1494
	Medium Low	1643	1607	1555	1515	1468	1420	1380	1332
	Low	1396	1343	1302	1250	1190	1152	1095	1034

Since the relationship between TESP and CFM may be different than the blower performance chart indicates due to twinning, it is recommended to calculate delivered CFM based on temperature rise. To perform this exercise both furnaces will be operated at the same time. Disconnect the HEAT blower motor speed tap (indicated by the RED arrow) wire from each furnace control board so that the speed utilized during this test will be the COOLING speed. Place a jumper on the twinning kit control board from thermostat connection terminals as shown below. The jumper will connect R + W1 + W2.

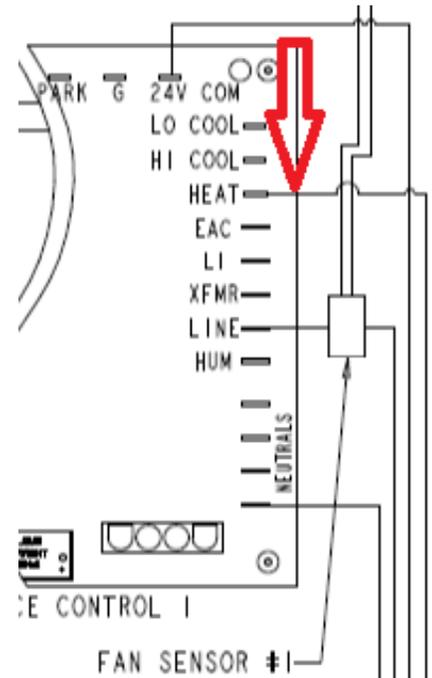
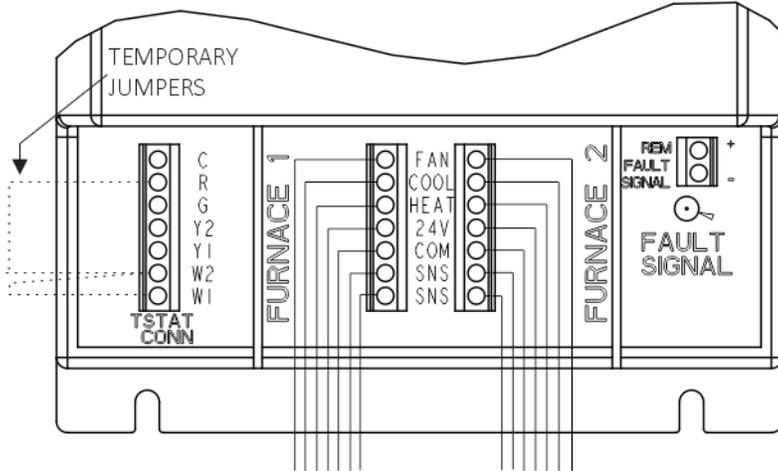

Once power has been applied both gas furnace indoor blower motors should start. Each furnace will perform an ignition sequence. Insure manifold gas pressure is correct during furnace operation. After approximately 5 - 10 minutes of furnace run time, obtain a supply air temperature and a return air temperature to calculate temperature rise. Using the calculation to the right, calculate approximate delivered system CFM. For our example we are using furnace model number TM9E100C20. Measured temperature rise of 50F. Furnace #1 and furnace #2 BTU's equal 200,000.  $200,000 \times .95$  (% Efficiency) = 190,000. Note that the efficiency was entered as a decimal.  $1.085 \times 50$  equals 54.25. 190,000 divided by 54.25 calculates to an approximate delivered CFM of 3502. If utilizing two 5 ton outdoor equipment sections, this example would indicate approximately 350 CFM / ton.

$$\text{CFM} = \frac{\text{BTUH Input (Furnace \#1 and \#2)} \times \% \text{ Efficiency}}{1.085 \times \text{Temperature Rise}}$$

Re-connect HEAT blower motor speed tap wires to both furnaces. Perform the same test with the HEAT blower motor wires connected and obtain another temperature rise measurement. Adjust the HEAT blower motor speed tap on each furnace blower motor so that measured heat rise falls in between the air temperature rise value indicated in the unit installation manual and on the unit data plate. Be sure that the blower motor speed tap selections utilized on each furnace are the same. The integrated furnace control board has a blower off delay jumper **factory set** at 120 seconds. **DO NOT** adjust this off delay. If the room thermostat is not providing a circulating blower call during a heat call, once the heat call has ended the twinning control will cycle the indoor blower motors off after a 155-second delay. The 155-second delay is built into the twinning control and is not field adjustable.

In most twinning applications, two outdoor units are utilized and the system is controlled by a multi-stage room thermostat. This provides the customer with full system airflow, but the heating and cooling equipment is staged to provide the best efficiency and comfort as possible. A single-stage room thermostat may be used, but multi-stage operation will be lost. When a single-stage room thermostat is used, furnace heating sections and/or both outdoor sections of equipment will start and stop at the same time. If the outdoor sections are heat pumps, the room thermostat **MUST** control fossil fuel operation, therefore, an outdoor sensor is required for heat pump low temperature cut off. Below are wiring diagrams detailing different room thermostat connections and A/C or H/P outdoor sections.

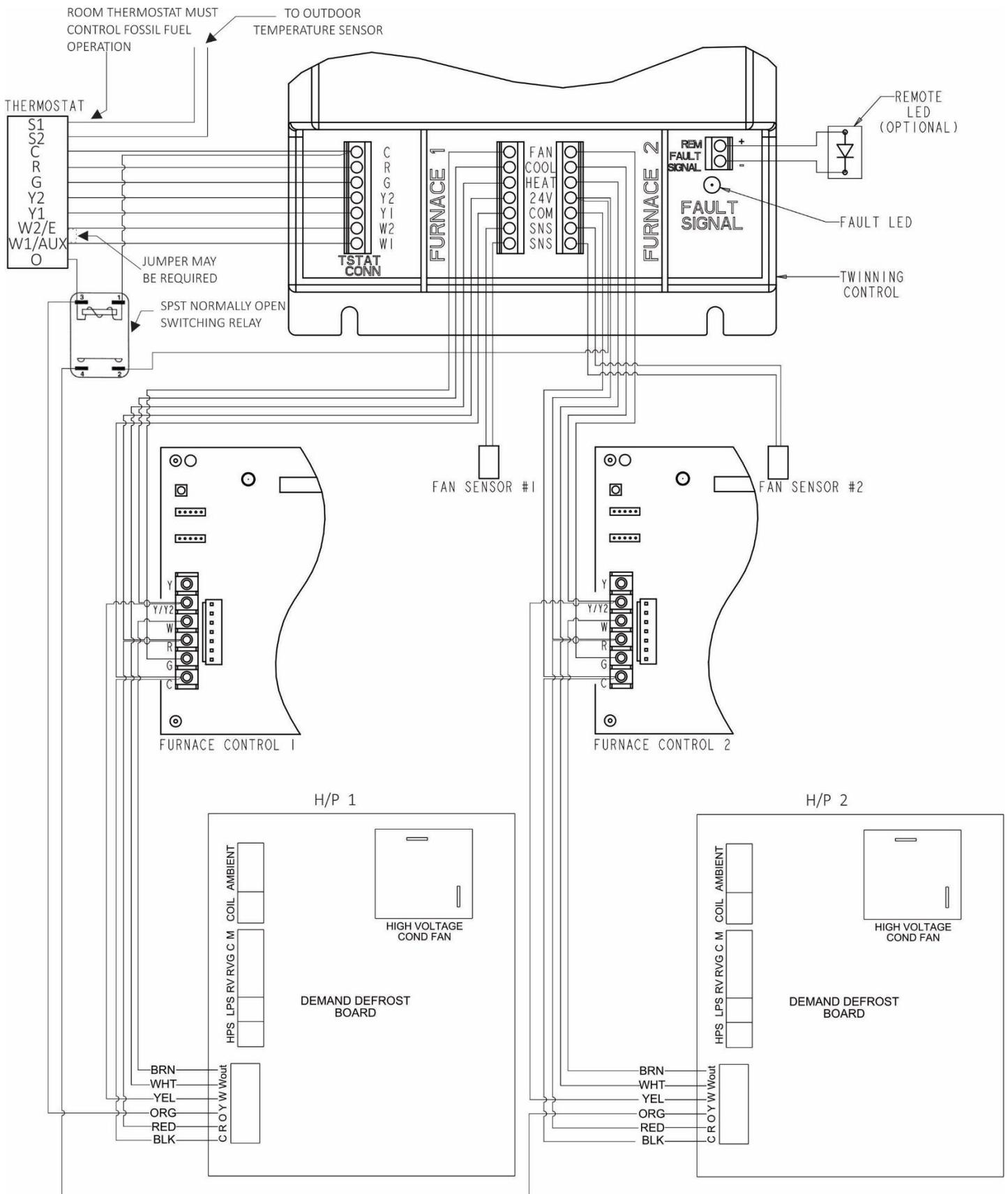

Control wiring diagram – Residential H/P – Multi-stage room thermostat.  
 Room thermostat **MUST** control fossil fuel operation.

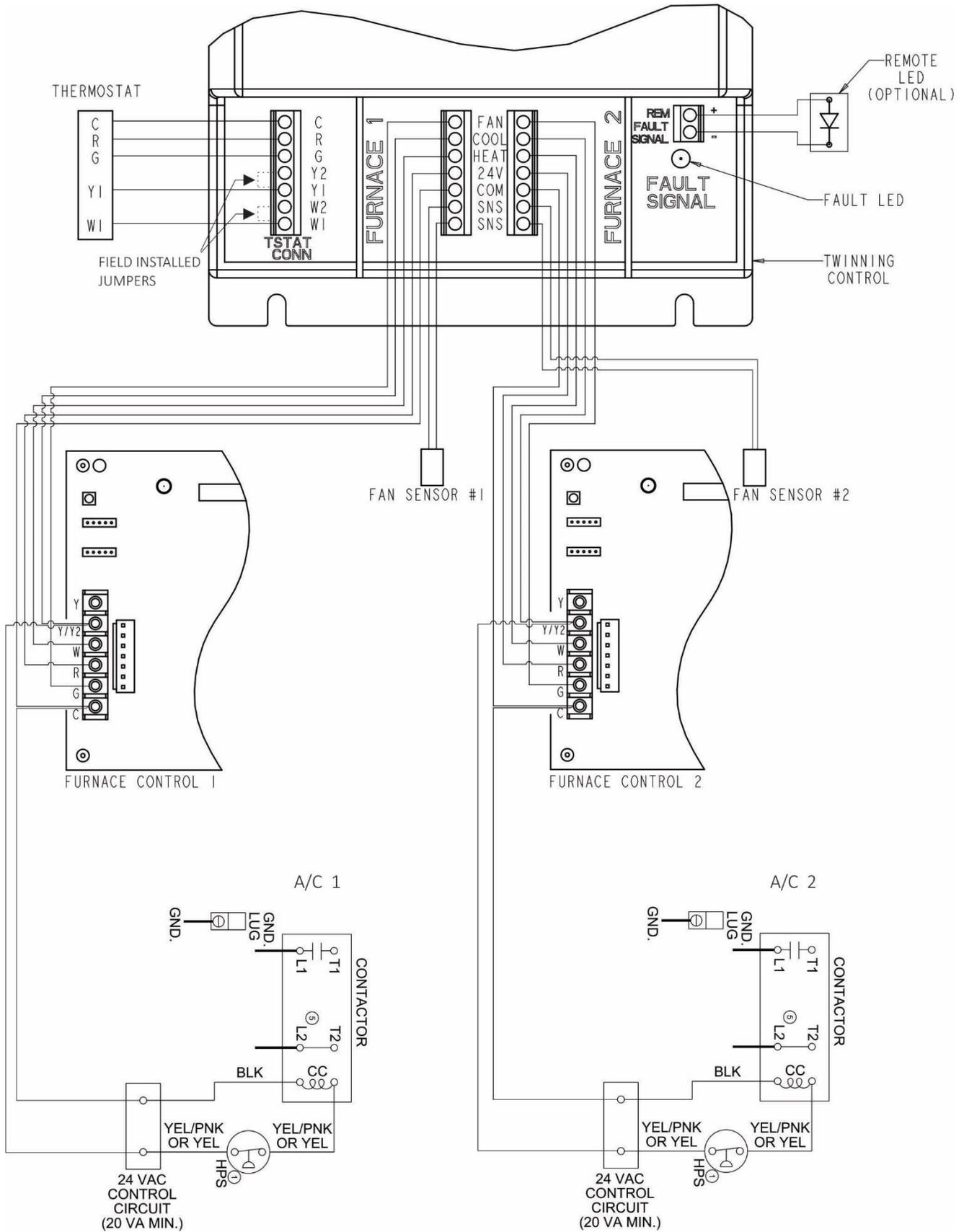

Control wiring diagram – Residential A/C – Single-stage room thermostat.

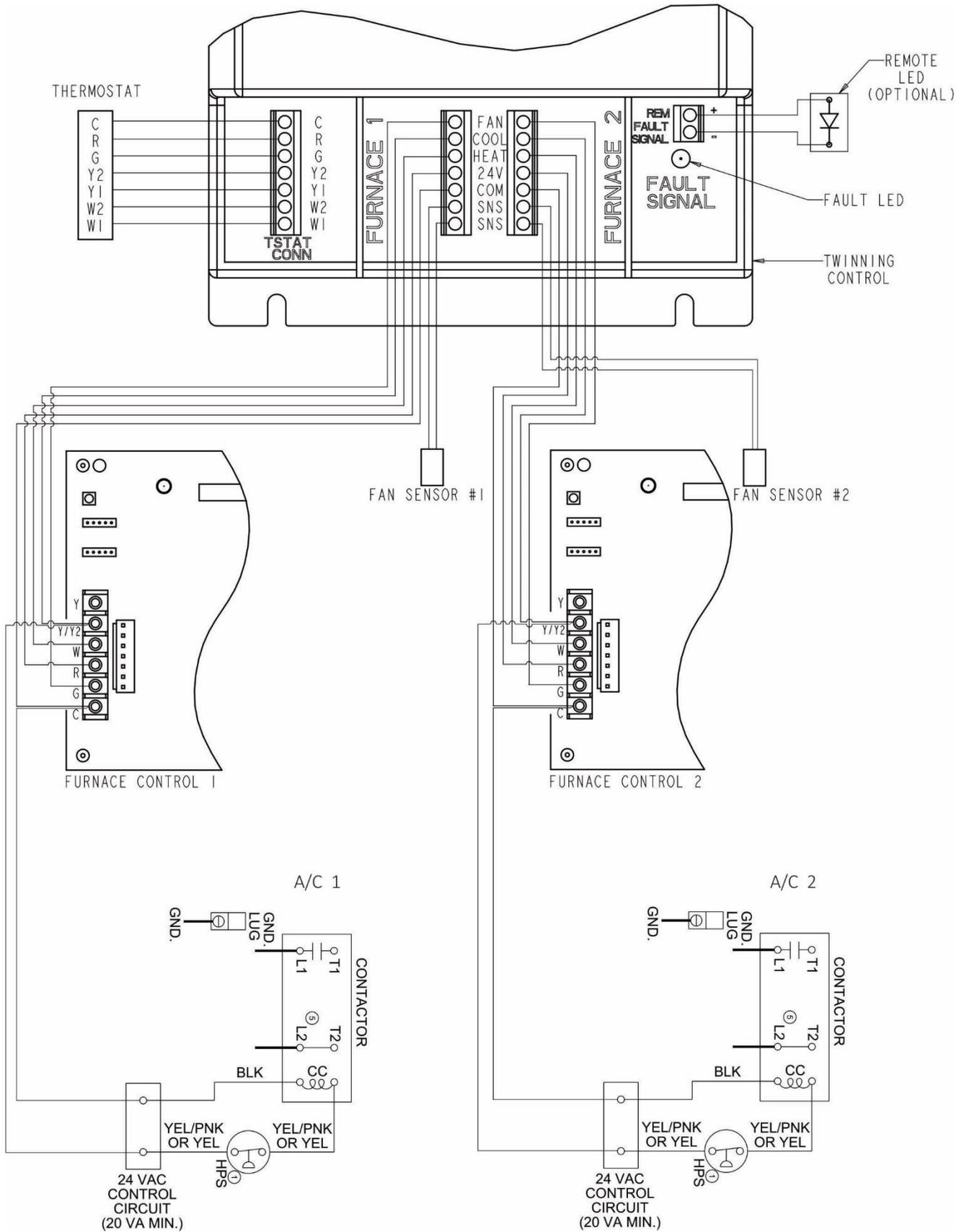

Control wiring diagram – Residential A/C – Multi-stage room thermostat.

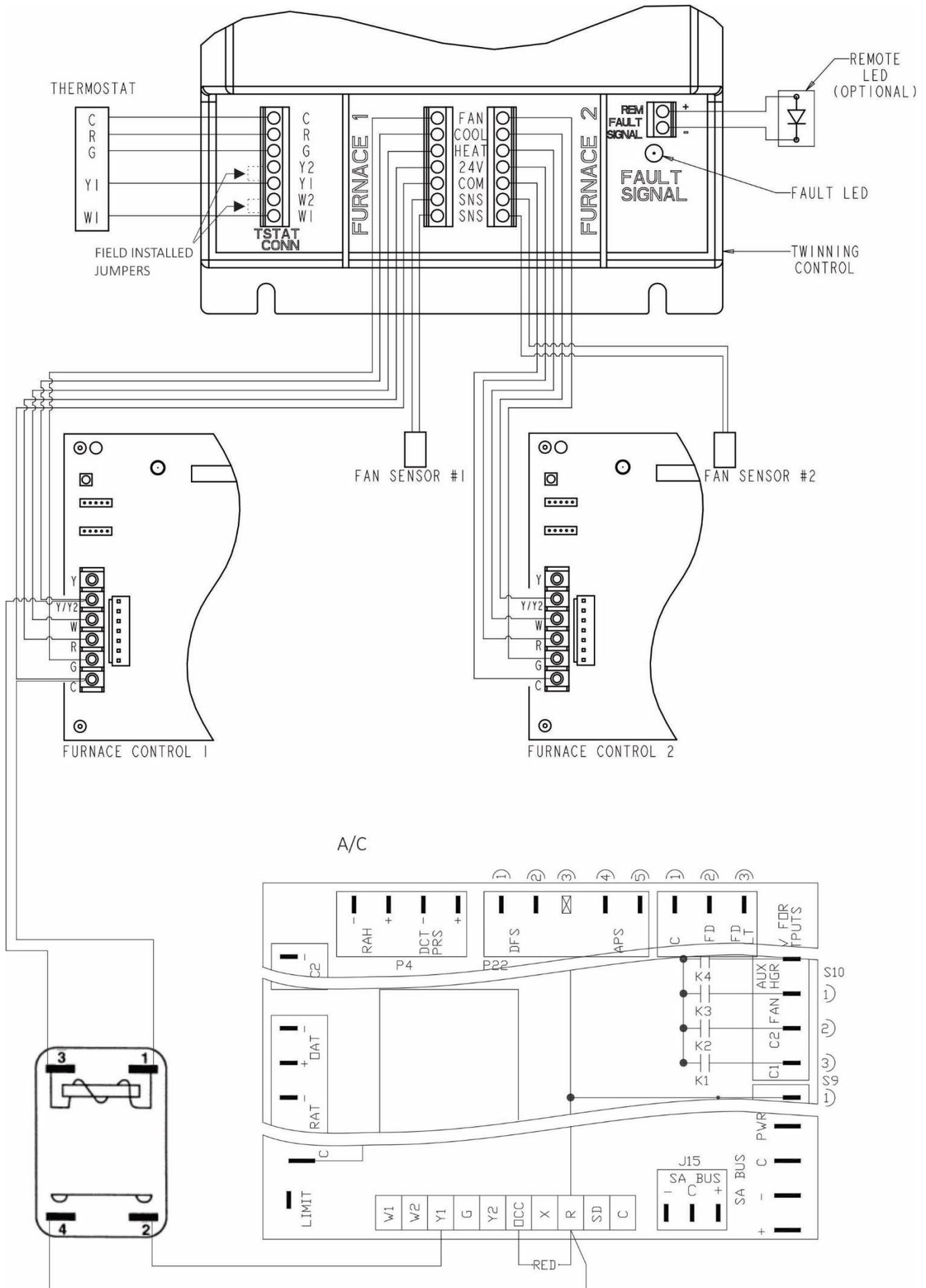

Control wiring diagram – Commercial 7.5 ton A/C – Single-stage room thermostat.

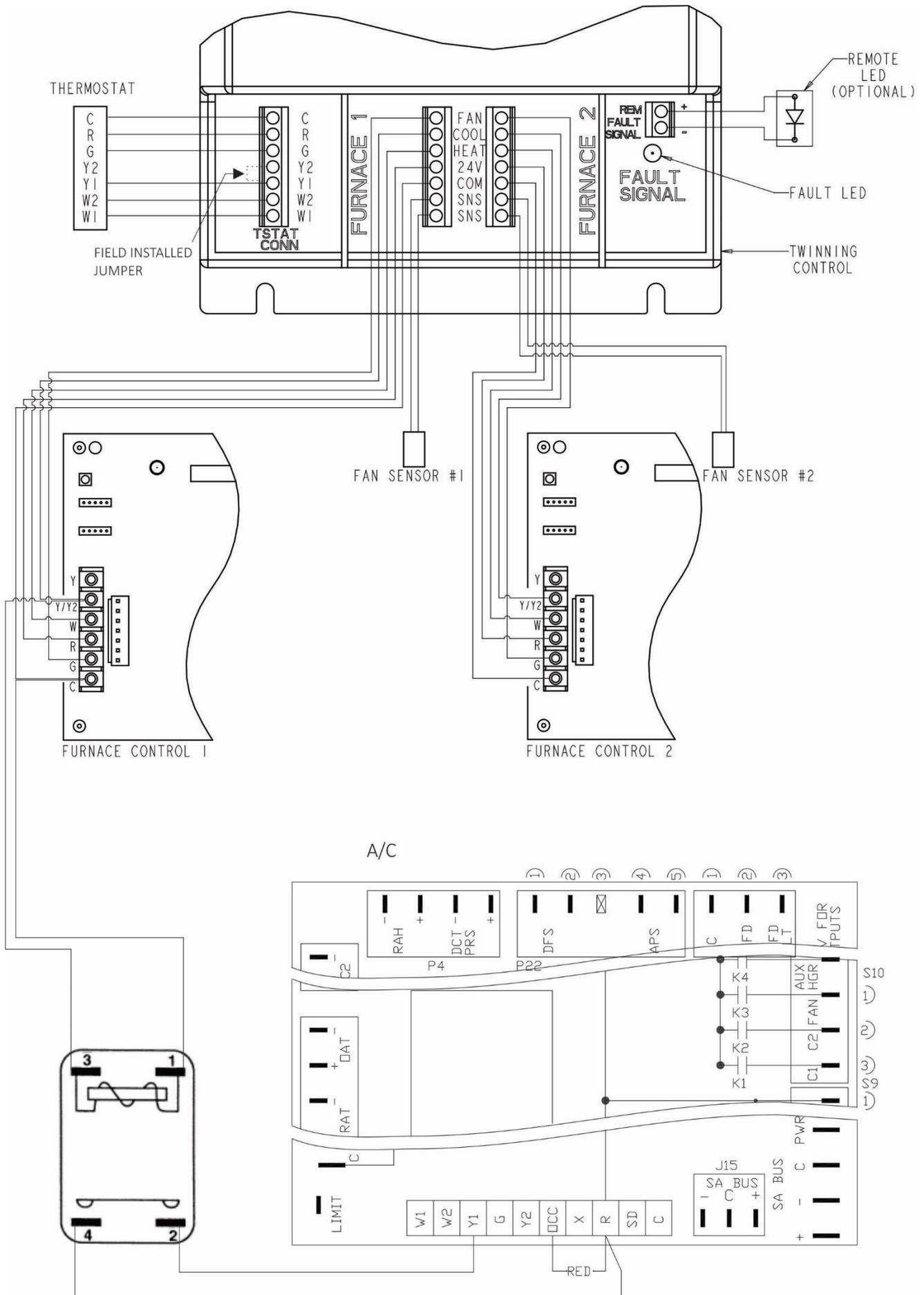

Control wiring diagram – Commercial 7.5 ton A/C – Multi-stage room thermostat.

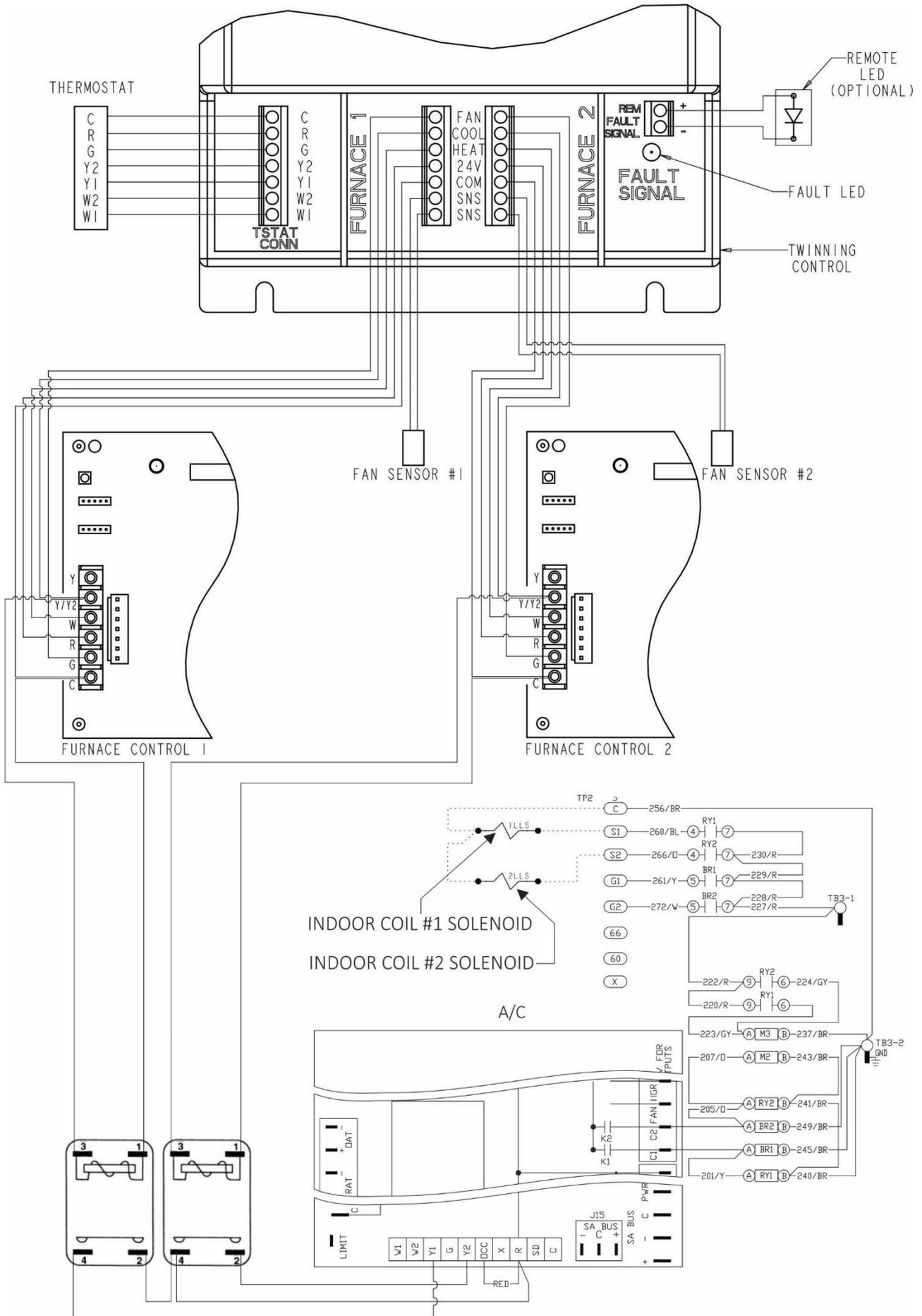

Control wiring diagram – Commercial 10 ton A/C – Multi-stage room thermostat.

The commercial equipment shown in the diagrams above contain their own control transformers, therefore, isolation relay(s) **MUST** be utilized to separate the indoor control transformers from the outdoor control transformer. Relay utilized should be S1-S90-290Q (or equivalent) which is a Single Pole Single Throw Normally Open (SPST-NO) relay containing a 24 VAC coil. An image of this type of relay is shown on the right. Residential heat pump (HP) applications will also require one of these switching relays to isolate the reversing valve (RV) input connected to HP 2 shown in the first diagram included in this letter.



If using commercial outdoor equipment, we recommend keeping the indoor coils and outdoor section as closely coupled as possible due to the sensitive refrigerant charge when the outdoor equipment contains micro-channel coil(s). For extended refrigeration piping applications (>100 feet) liquid line receiver(s) may be necessary. Contact the commercial applications group for further assistance.

Commercial outdoor equipment sections shown in the diagrams above contain Smart Equipment Controls (SEC). When the commercial outdoor sections are paired with commercial indoor sections, the room thermostat connects to the SEC and the SEC controls indoor blower motor operation, etc. In the applications shown above where residential indoor furnaces are utilized, the SEC will be used only to control the outdoor section and in the case of the 10-ton model, the SEC will also control the liquid line solenoid valves located at the indoor coil sections.

Once power is applied to the outdoor section, a startup sequence will begin. The joystick, ENTER and CANCEL buttons will not function during this sequence. A setting change is **REQUIRED** for proper operation when using the commercial 10-ton outdoor section. See below for steps through the SEC display menu guide. 4 Pipe Split Enable (**4pipeEna**) must be switched to **YES**.

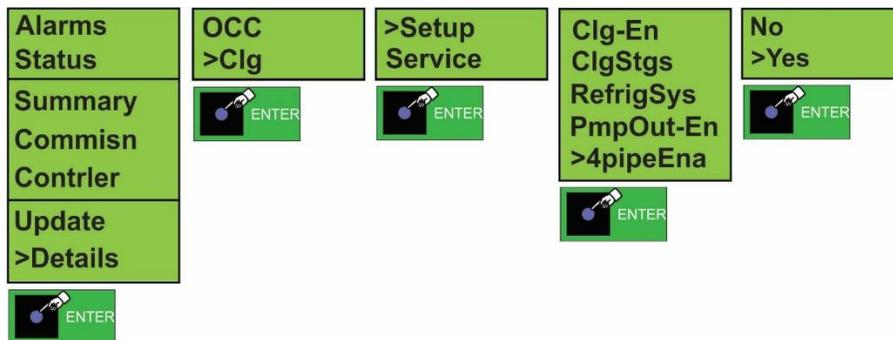

From the main menu the selection is **Details, Clg, Setup, 4pipeEna, Yes**.

If you have any questions on this feel free to call Factory Direct Northeast Technical Services at 1-855-251-8267 and speak with a technical support representative.

Regards,  
 Thomas Hoffmaster II  
 York Factory Direct Northeast  
 Area Service Manager