

LAMONA

Built-In Dishwasher

LAM8304



User Instructions

Register 
my appliance

www.howdens.com/appliance-registration



**Free 3 year
guarantee**

Call now¹

0333 010 0009

Alternatively, visit www.howdens.com/appliance-registration

LAMONA

**3 year guarantee available.
Register your appliance within 90 days²**

**By registering your appliance and creating an account, we
will keep you up to date with the latest product information
and notify you immediately of any important product updates**

¹Lines are open Monday to Friday 9am to 5pm. Calls will be charged at your local rate and may be recorded and monitored for training and quality purposes.

²So that in the event of an important product update, or recall, we can contact you.

Register 
my appliance

Welcome

Dear Customer

Congratulations on your choice of dishwasher which has been designed to give you excellent service.

- Please read these User Instructions to ensure safe operation of the dishwasher.
- Please keep these instructions in a safe place for your future reference.
- If you have any questions, or if you are not sure about any information contained in this booklet please contact us - details at the end of these User Instructions

NOTE: Due to the quality control processes during production, there may be some water left in your machine. This does not cause any damage.

Preparation before use:

It is recommended that the dishwasher is operated on the **P4** ☺ > 60°C programme without loading any items.

This appliance is intended to be used in household and similar domestic applications where it is used by a maximum of 8 people.

Throughout this manual the following symbols are used.

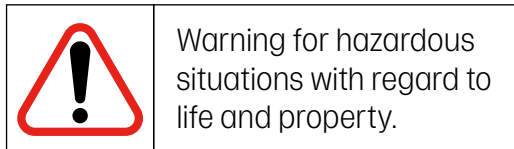

**DO NOT KINK HOSES
BEHIND MACHINE!**
Machine will not work properly.

Contents

Safety information

Children and vulnerable people safety	p.4	Select programme	p.12
General safety	p.4	Spray arms	p.13
Installation of dishwasher.....	p.5	Using Tablets.....	p.13
Use.....	p.5	Smells and residue Build-Up	p.13
Service.....	p.5	Controls and programmes.....	p.14
Disposal of old appliance	p.5	Programme the dishwasher	p.15
Disposing of packaging material.....	p.5	Opening the door whilst operating.....	p.16
Compliance	p.5	Programme ends / setting audible warning.....	p.16
1 - Before first use	p.6	Unloading the dishwasher	p.16
Check water hardness	p.6	3 - Cleaning the dishwasher	p.17
Setting water hardness level.....	p.7	Cleaning the filters.....	p.17
Check and refill salt	p.7	Cleaning the upper and lower spray arms.....	p.17
Check and refill rinse aid.....	p.8	Cleaning the dishwasher.....	p.18
Setting rinse aid level	p.8	4 - Detergents and use	p.19
2 - Operating the dishwasher	p.9	5 - Before calling for service	p.20
eco programme.....	p.9	Fault codes	p.20
Loading dishwasher	p.9	Problem solving.....	p.20
Items not suitable for a dishwasher.....	p.11	6 - Guarantee	p.22
Cutlery basket	p.11	7 - Specifications	p.23
Upper basket height adjustment.....	p.11	Water softening system.....	p.23
Folding shelves	p.12	Information	p.23
Add detergent or tablet	p.12		

Safety information

Please read these instructions. The manufacturer is not responsible if an incorrect installation and use causes injuries and/or damage. Always keep the instructions with the dishwasher for future reference.

Children and vulnerable people safety

- This appliance can be used by children aged from 8 years and above and persons with physical, sensory or mental capabilities or lack of experience and knowledge if they have been given supervision or instruction concerning use of the appliance in a safe way and understand the hazards involved.
- **Do not** let children play with the appliance.
- Keep all detergents away from children.
- Keep children and pets away from the appliance door when it is open.
- Cleaning and maintenance shall not be made by children without supervision.

General safety

This appliance is intended to be used in household and similar applications, (8 persons maximum).

- **Do not** change the specification of this appliance.
- The operating water pressure (minimum and maximum) must be between 0.03 - 1.0Mpa (0.3 - 1.0 Bar).
- The maximum number of place settings is 10.
- Put knives and cutlery with sharp points in the cutlery basket with the points down or in a horizontal position.
- **Do not** leave appliance door open - trip hazard.
- Before maintenance, switch off the appliance and disconnect the mains plug from the mains socket.
- **Do not** use steam cleaners or jet washers to clean the appliance.

Installation of dishwasher

Separate Installation Instructions are provided with your dishwasher.

Please follow these installation instructions in order to assemble and install your dishwasher easily and correctly.

- After unpacking your dishwasher, check for any possible transportation damage.
- Never install and use a damaged dishwasher. If your dishwasher is damaged contact your supplier.
- Always have your dishwasher installed by a suitably qualified person.
- Any repairs or service work on this dishwasher should only be carried out by a **LAMONA** Authorised Service Agent.
- Unauthorised repairs are dangerous and will lead to the cancellation of your guarantee.
- Make sure the electricity and water connections are in compliance as stated in the Installation Instructions.
- **Do not** install or use a damaged appliance.
- **Do not** install or use the appliance where the temperature is less than 0°C.
- Make sure that the appliance is installed below and adjacent to safe and solidly fixed structures.

Use

- **Do not** sit or stand on the open door.
- Dishwasher detergents are hazardous. Obey the safety instructions on the detergent packaging.
- **Do not** drink the water from the appliance.
- **Do not** remove the dishes from the appliance until the programme is completed. There may be detergent on the dishes.
- The appliance may release hot water if you open the door while a programme is in operation.
- **Do not** put flammable products or items that are wet with flammable products in, near, or on the appliance.
- **Caution:** If removing dishes before or immediately after the programme has ended be aware that the dishes may be hot and hot steam may be released.

Service

- Contact the Depot or Helpline for any Service requirements. We recommend only the use of original spare parts.

Disposal of old appliance

-  **WARNING!** Risk of injury or suffocation.
- Disconnect the appliance from the mains supply.
- Cut off the mains cable and discard it safely.
- Disable the door catch to prevent children and pets becoming trapped in the appliance.
- Contact local council for safe disposal.

Disposing of packaging material

-  Packaging materials are dangerous to children
- Keep packaging materials away and out of reach of children.
- Packaging materials are manufactured from recyclable materials. Dispose of them properly and sort in accordance with recycled waste instructions.
- **Do not** dispose of them with normal domestic waste.

Compliance with WEEE Directive and Disposal of the Waste Product



This product complies with EU WEEE Directive (2012/19/EU). This product bears classification symbol for waste electrical and electronic equipment (WEEE). This product has been manufactured with high quality parts and materials which can be reused and are suitable for recycling. **Do not** dispose of the waste product with normal domestic and other wastes at the end of its service life. Take it to the collection centre for the recycling of electrical and electronic equipment. Please contact your local council authority to learn about these collections.

 This appliance complies with all relevant EU Directives

1 - Before first use

Check water hardness

In order to achieve good cleaning results, the dishwasher needs to operate with soft water. Hard water results in the build-up of calcium deposits on crockery and on the inner surfaces of the appliance.

The dishwasher has a special water softening system to remove the hardness of the tap water.

Make sure the current setting of water softener agrees with the hardness, as below.

Test strip

- Remove the test strip from the packet.
- Let the water flow from your tap for 1 minute.
- Fill a glass with tap water and dip the test strip into the water and stir around. 1 second
- Take the test strip out of the water and shake.
- Hold for 1 minute.
- Set the water hardness level of the dishwasher according to the result shown by the test strip.

Level 1: No lime
 Level 2: Very low lime content
 Level 3: Low lime content
 Level 4: Medium lime content
 Level 5: High lime content
 Level 6: Very high lime content

Hardness level	Water hardness °dE	Water hardness programme setting
Level 1	0-5	r 1
Level 2	6-9	
Level 3	10-15	r 2
Level 4	16-19	r 3
Level 5	20-24	r 4
Level 6	25-62	r 5

If the hardness level of the supply water is below 7°dE, there is no need to use salt in your dishwasher.

Note: If the water hardness level adjustment is set to level 1, the “No salt warning indicator” will illuminate continuously although it is not necessary to use salt. However, if you fill the salt reservoir under this condition, salt will not be consumed and the salt indicator will not illuminate.

- For optimum performance we recommend the use of separate detergent, salt and rinse aid.

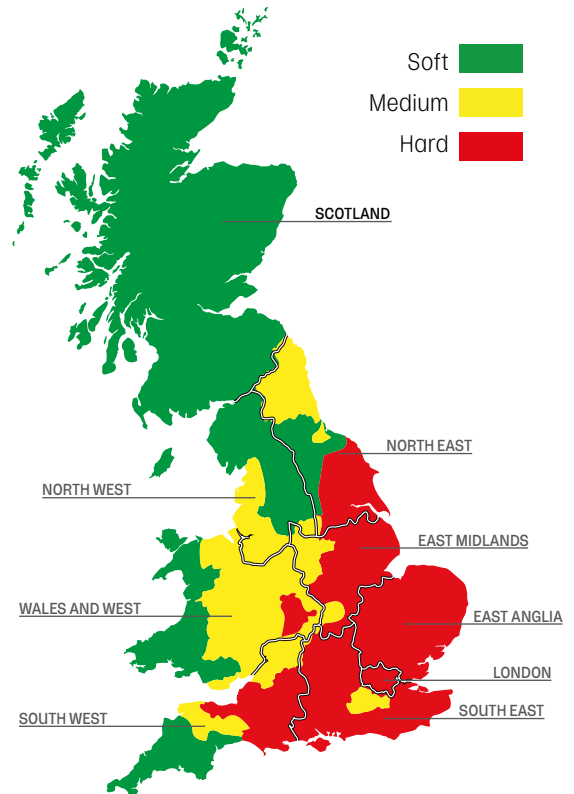

(If the hardness level of the supply water is above 62°dE or if you are using well water, then it is recommended to use water purification devices and special filters.)

Setting water hardness level / adding dishwasher salt

Select correct water hardness salt setting to ensure wash performance and protect the machine's components.

White 'chalky' deposits during use:
 • Increase salt softener level.

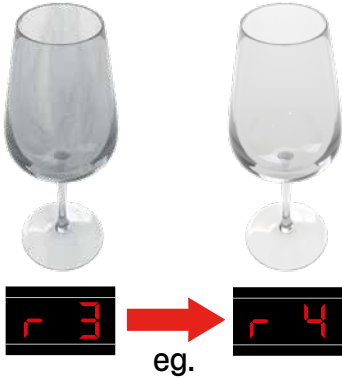

Switch On



Press and hold (display counts down 3,2,1)



Press, hold and release when display shows



Select water hardness setting (r...)



Press to select new water hardness setting



Switch Off to save new water hardness setting



(Changing L option has no effect on this model)

Check and re-fill every 30 days or if display shows **S**.

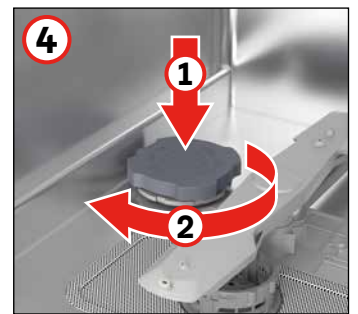
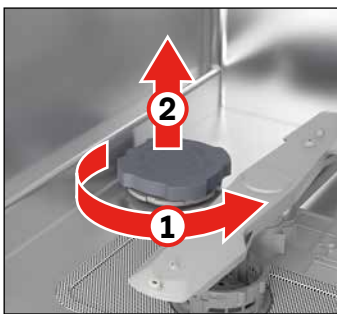

Only use granular dishwasher salt.

- ⚠ Risk of corrosion.
- ⚠ Ensure lid is correctly seated and secured as saline solution will corrode internal cabinet and components.
- ⚠ Always run a programme cycle after filling salt container.



Rinse aid, check and re-fill if display shows ✨.

Rinse aid helps dry the dishes without streaks and stains. It is automatically released during the hot rinse phase.

Always re-fill just before a wash programme.

Only use dishwasher rinse aid.

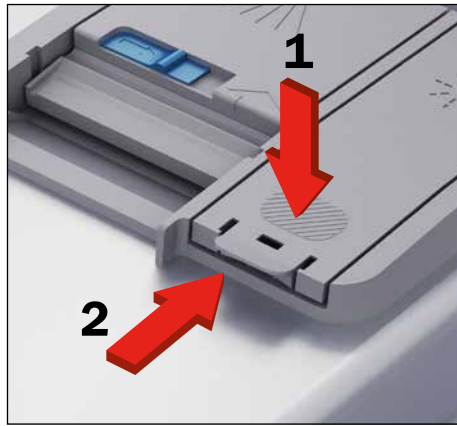

Setting rinse aid level / adding rinse aid

If there are stains on tableware items after washing the level must be increased and if there is a blue trace after wiping them by hand, it must be decreased. Adjust the setting from the values 0,1,2,3,4 (factory pre-set, level 3).

Switch **On**

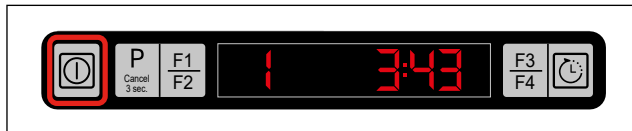

Press and hold (display counts down 3,2,1)

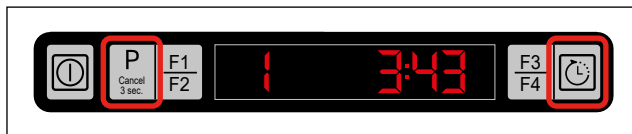

Press, hold and release when display shows

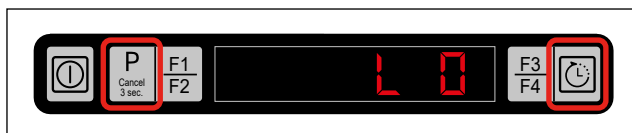

Select rinse aid setting (P..)



Press to select new rinse aid setting



Switch **Off** to save new rinse aid setting



(Changing L option has no effect on this model)

For optimum performance we recommend the use of dishwasher detergent with separate rinse aid and salt.

Blue streaks

- Lower rinse aid setting.



2 - Operating the dishwasher

 Ensure all items are 'dishwasher safe'.

Washing tableware in a household dishwasher usually consumes less energy and water in the use phase than hand dish washing when the household dishwasher is used according to the manufacturer's instructions.

Pre-rinsing is not recommended = higher water and energy costs.



eco programme

Suitable for cleaning normally soiled tableware, for this use, it is the most efficient programme in terms of its combined energy and water consumption*

P1
eco
50°C



Loading dishwasher

Scrape all food waste and debris from plates.



Do not pre-rinse.



Load dishwasher as shown.

Note: A fully loaded dishwasher is more economical, more efficient and better for the environment.



Upper basket - small items

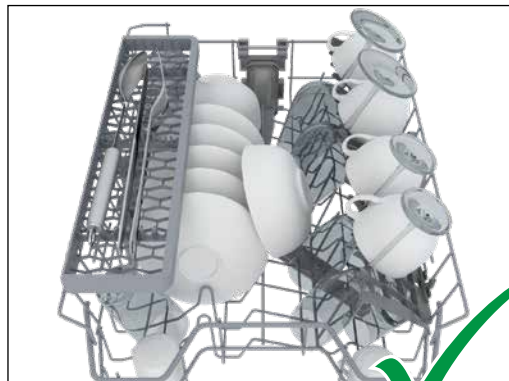

Lower basket - large items



* It is used to assess compliance with the EU ecodesign legislation; Reference programme for testing institutes. The tests in accordance with EN 50242/60436 must be carried out with a full water softener salt dispenser and a full rinse aid reservoir, and using the test programme.

Loading dishwasher (continued)

- Long-stemmed glasses should lean against the basket or the support shelves and not against dishes, (A).
- Always arrange saucepans, cups and glasses etc. upside down.

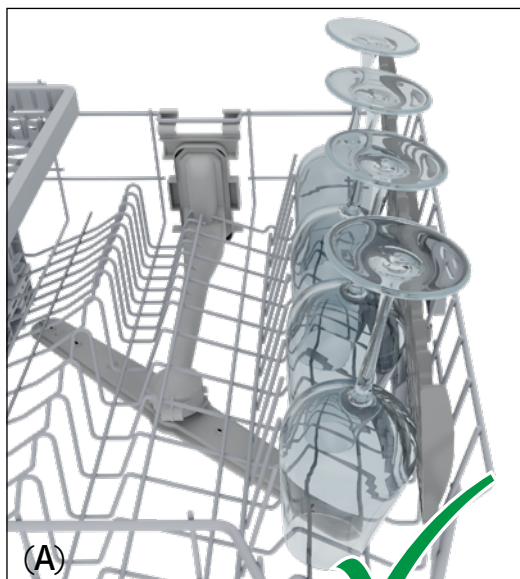

Upper basket - lightly soiled
Lower basket - heavily soiled

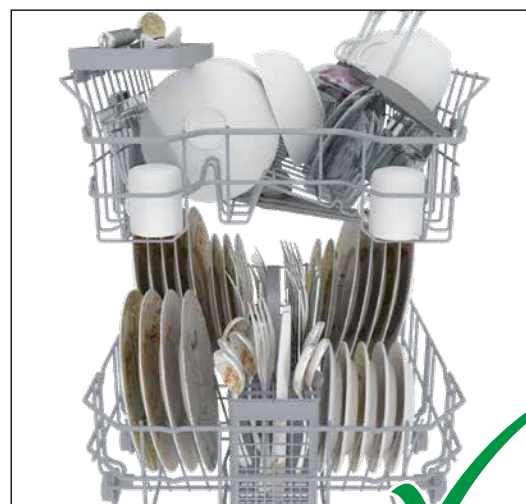

Incorrect loading will adversely affect wash performance!



! **DO NOT** allow tall glasses to rest against each other because of possible damage during the wash programme.

! Carefully place glasses so they don't move and break.

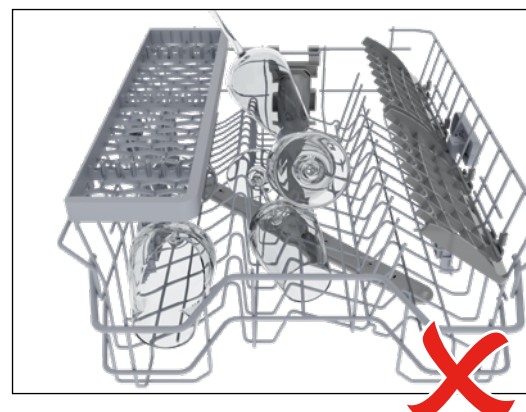

Loading dishwasher (continued)

Items not suitable for a dishwasher

Items not suitable;

- Non-heat resistant.
- Wooden items.
- Plastic containers.

 **Electrical items.**



Cutlery basket

- Move cutlery basket as desired.

 **DO NOT** allow cutlery to protrude out of the sides or bottom as it can stop spray arms rotation

- To avoid the risk of injury, knives and forks should be placed with the handles upwards in the cutlery basket. However, cutlery placed handle down in the cutlery basket will come out cleaner and drier.

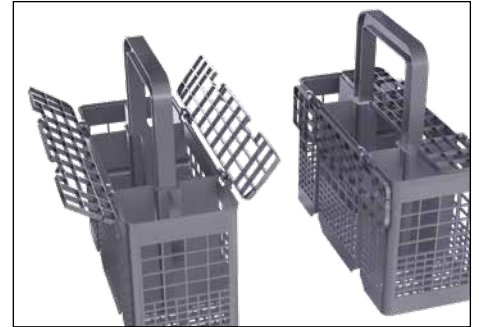
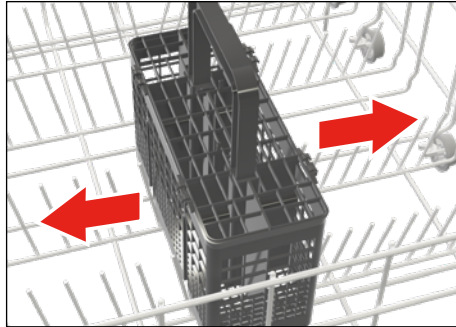

Upper basket height adjustment (3 positions)

To raise the height of the upper basket.

- Hold the upper basket and pull upwards, (A).
- An audible click will be heard.

 The height adjustment may not work properly if the basket is overloaded.

 Ensure the basket is level after adjustment.

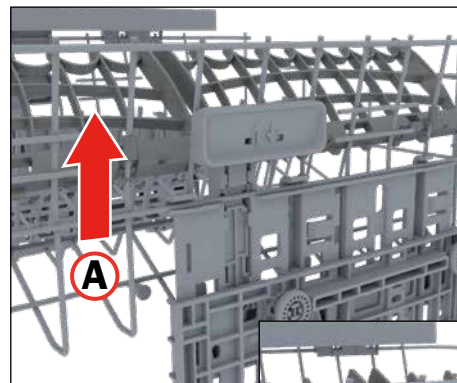

To lower the height of the upper basket.

- Hold the upper basket and press the adjustment handles, (B).
- Lower the basket to the desired position.

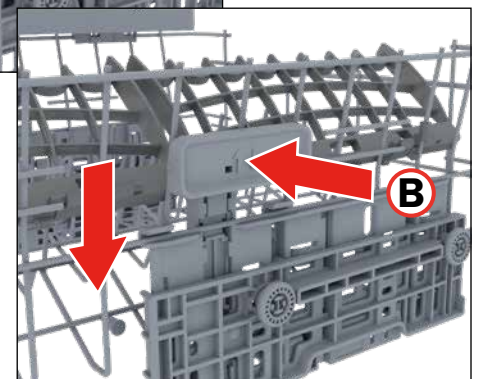

Loading dishwasher (continued)

Folding shelves

Fold the shelves to suit small or larger, taller items, (A) and (B).

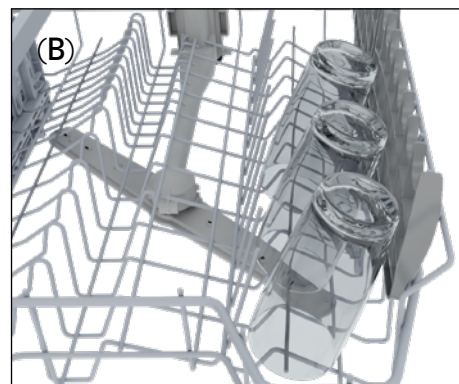
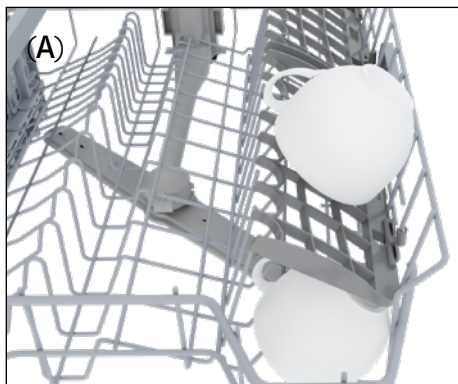

Add detergent or tablet

Only use dishwasher detergent or tablets.

Use according to manufacturer's instructions.

(Use powder or gel for short programme cycles)



Turn on and select programme with any options

See 'Controls and programmes'.



Fast +

Reduce certain wash programmes' time by increasing wash water pressure.



Half load option

Select if you need to wash before you have a fully loaded dishwasher.



Available options dependant upon Programme selected.

Close the dishwasher door to start the programme

Programme cycle will run, complete cycle, sound an audible alert and after a period of time enter standby mode.

Spray arms

- Check that the upper and lower spray arms can rotate freely,

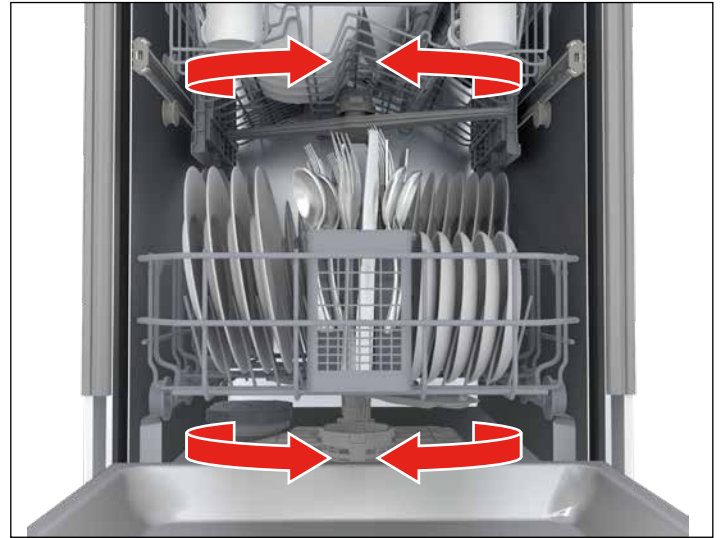

Using tablets

- Place tablet in main container (1).
- Ensure tablet is inserted correctly and lid is able to close properly.
- Close the container lid (2) and ensure you hear a clicking sound.

If you are using 'all in one tablets', read the manufacturer's recommendations in order to determine where the tablets should be placed inside the dishwasher.

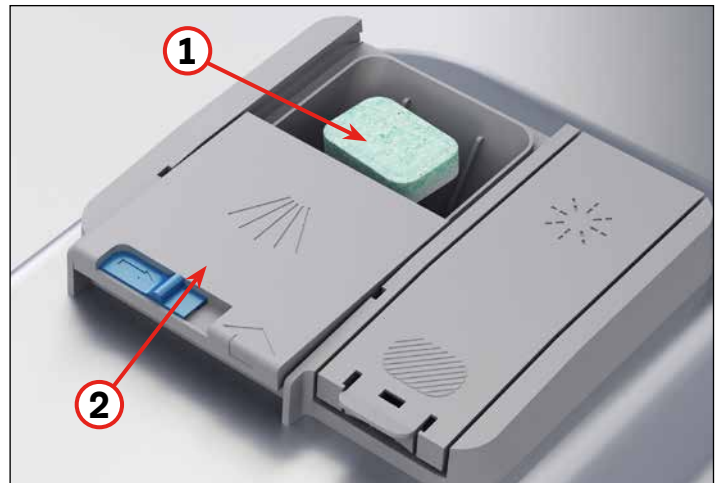

Caution: Never put washing-up liquid in the dishwasher.



When using the tablet function key the time duration may alter.

- It is possible that some detergent tablets may not fully dissolve during the shortest wash cycle.
- When using combi-tablets tablets wash programme will be amended to ensure optimum results. May cause change in programme duration



Smells and residue Build-Up

- Use of low temperature and shorter wash programmes may lead to smells and residue build-up.
- Run the **P2** Programme 1 x per month to restore your machine.

x30 days **P2**

70°C

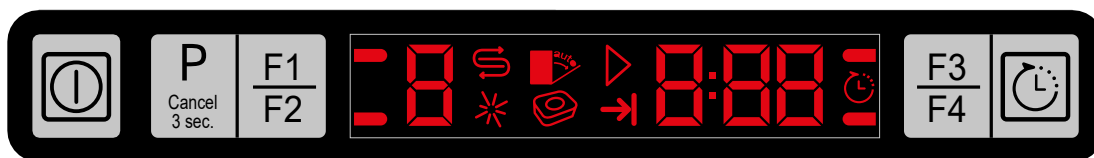
Controls and programmes



1. Power On/Off

Display illuminates when the power is **On**.
For energy saving, the machine automatically turns off following the completion of the programme or if the programme is not started.

2. Programme Selection/Programme Cancel

Press until the desired programme appears.
The programme will start when the dishwasher door is closed.

To cancel a running programme or time delay function;

- Open the dishwasher door
- Hold for 3 seconds, (countdown 3-2-1), until 0:01 is displayed.
- Close the dishwasher door.
- Wait for 2 minutes until the draining process is completed and an audible warning is heard.
- Power **Off/On** and re-programme.

3. Function Keys

F1 - All in one tablet.

F2 - Half load.

F3 - Fast +

F4 - Extra Rinse

Use the function keys to select tablet or half load options after selecting the desired programme.

4. Programme Indicator

The programme will start when the dishwasher door is closed.

5. Salt Indicator

Refill salt reservoir when illuminated.

6. Not used

7. Start / Cancel Indicator

8. Programme Time Indicator / Time Delay

Indicator displays the duration of the programme or the time delay before starting the selected programme.

9. Time Delay - 30 minutes to 24 hours.

Press and select the desired time delay before starting the selected programme.

10. Time Delay Indicator

Illuminates and flashes when time delay is selected.

11. End of Programme Indicator

Illuminates when the selected programme finishes.

12. Tablet Detergent Function

Illuminates when the tablet function key has been selected.

13. Rinse Aid Indicator

Refill rinse aid reservoir when illuminated.

Programmes and temperatures	Cycle selection information	Degree of soiling	Prewash	Wash	Dry	Time (mins)	Water (l)	Energy (kWh)
P1 *** eco 50°C	Dishes with normal amount of soil. It is the most efficient program in terms of combined power and water consumption.	Medium	+	+	+	239	9.5	0.73* / 0.755**
P2 70°C	Heavily soiled dishes, pots and pans.	High	+	+	+	164	14.8	1.25
P3 65°C	Daily washing programme for normally soiled dishes.	Medium	+	+	+	120	14.8	1.18
P4 60°C	Daily washing programme for normally soiled dishes in the fastest way.	Low-Medium	-	+	+	58	10.6	1.12
P5 35°C	Lightly soiled daily dishes that are scraped or pre-cleaned.	Low	-	+	-	30	10.4	0.74

* : EN 60436:2016 ** : EN 60436:2020 The consumption values shown in the table were determined under standard conditions. Differences may therefore occur under practical conditions. *** Reference programme for testing institutes. The tests in accordance with EN 50242/60436 must be carried out with a full water softener salt dispenser and a full rinse aid reservoir, and using the test programme. The values given for programmes other than Eco 50°C programme are indicative only.

Programme the dishwasher

Power On/Off ①



Select programme ②



Option F1-
Select all in one tablet

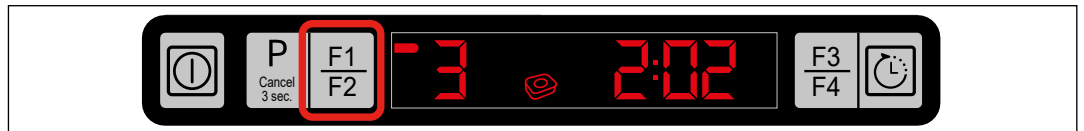

Option F2-
Select 1/2 load



Option F3-
Select Fast +



Option F4-
Select Extra Rinse



Option -
Select time delay
30 minutes to 24 hours

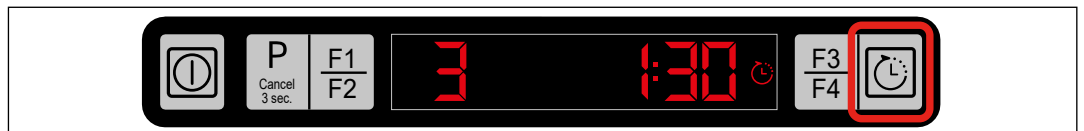

**Close the door
programme** ③
will start.

End of programme
indicator



To cancel a programme or time delay;

- Open the dishwasher door
- Hold for 3 seconds, (countdown 3-2-1), until 0:01 is displayed.
- Close the dishwasher door.
- Wait for 2 minutes until the draining process is completed and an audible warning is heard.
- Power **Off/On** and re-programme.



⚠ Opening the door whilst operating

If you open the door while a programme is running, the dishwasher stops immediately. When you close the door, the dishwasher continues from the point of interruption.

⚠ **Caution:** Care must be taken when opening the door, as steam and water will escape.

⚠ **Caution:** Water may be very hot.

⚠ **Caution:** Just after the dishwasher has started the selected programme and you want to include another item to be washed, open the door very slowly. Care must be taken when opening the door, as steam and water will escape. Load the item and close the door. The dishwasher will resume operation.

Programme ends / setting audible warning

An audio signal with an interval of 10 seconds warns you to switch your machine off when the selected washing programme ends. This audio signal warns you for a duration of 5 minutes and then turns off.

⚠ **Caution:** Care must be taken when opening the door, as hot steam may escape.

- Press the 'On/Off button' when the programme has finished. The indicator lights will go off.
- The audio signal has 3 settings 'off,low,high' which can be altered as shown opposite.

Switch On

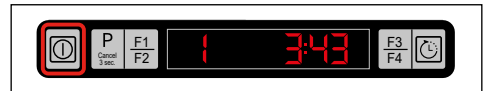

Press and hold (display counts down 3,2,1)

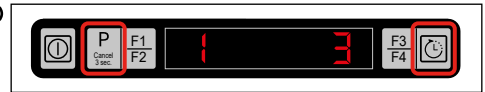

Press and hold until display shows



Select audible warning setting (S...)



Press to select new audible warning setting 0,1,2 (off,low,high)



Switch Off to save new audible warning setting



Unloading the dishwasher

End →



Wait to cool
15-20mins

⚠ **Caution:** Items may be hot.



Unload



Unload



NOTE: At end of programme water may be present on plastic items and on tops of cups, bowls etc. This is normal. Use a clean tea towel to dry.

3 - Cleaning the dishwasher

Cleaning the filters (regular cleaning ensures optimum performance)

There are three different filters in your machine. **Main filter, Coarse filter and Micro filter**

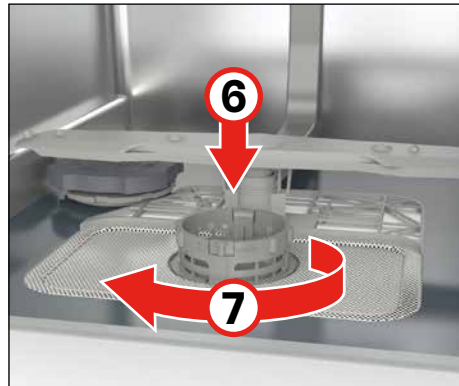
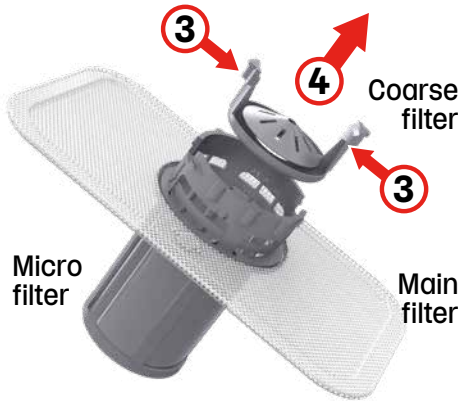
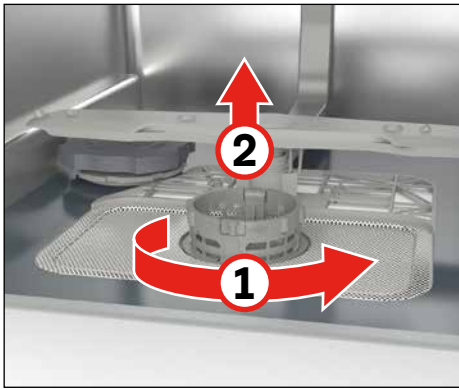

! Caution: The dishwasher must not be used without filters. Incorrect repositioning of the filters will produce poor washing results. Cleaning of the filters is vital to ensure correct operation of the machine. Clean every 2 weeks.

Cleaning the upper and lower spray arms

Upper spray arm

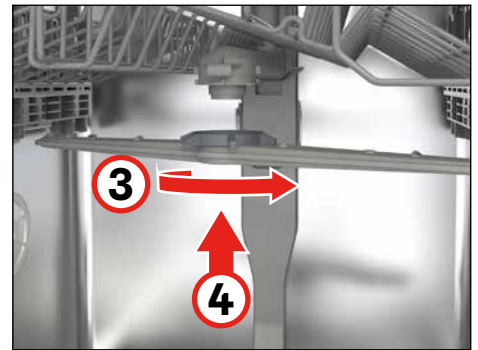
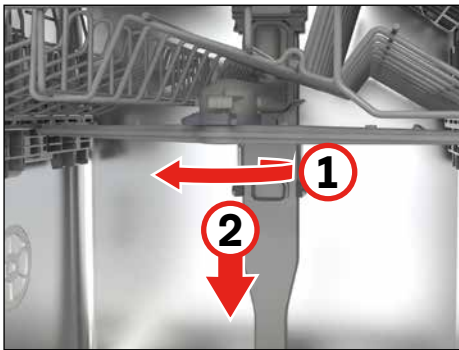

Lower spray arm

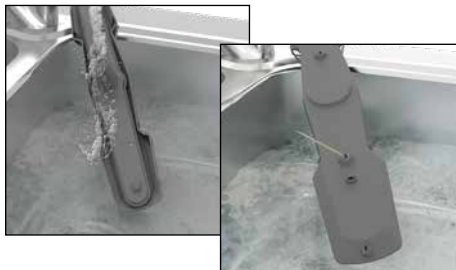
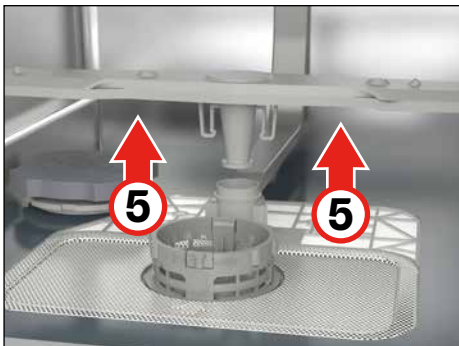

If necessary use a cocktail stick or similar to unblock holes.

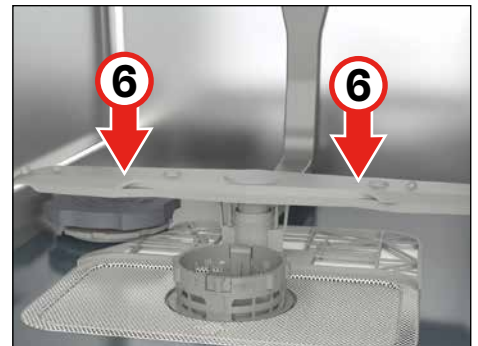

Cleaning the dishwasher

Normally the occasional use of 'PO SELF CLEAN' is all that is necessary to keep the dishwasher internals clean. Use with dedicated machine cleaning detergent.

PO



 **Caution:** Always switch off the dishwasher.



Wipe clean with a clean damp cloth and mild detergent only. Then dry with a clean dry cloth.

 **Do not** use abrasive or caustic agents/solvents as they will damage the appliance.

 **Caution:** Do not use steam cleaners or jet washers.

If the dishwasher is not going to be used for a long period of time.

- Switch off.
- Turn off the water supply.
- Clean and leave the door ajar.



4 - Detergents and use



Any brand of powder, gel and all in one tablets that have been designed for household dishwashers, may be used.

Keep detergents in a cool and dry place and out of the reach of children.

Detergent must be added to the container before each use.

Detergent overdose may cause scratches on your dishes and there may be traces of detergent left in your machine.

Three types of detergent are available

- Phosphate and containing chlorine.
- Phosphate containing no chlorine
- Neither containing phosphate nor chlorine

New compact powders are generally phosphate-free. As phosphates have water softening properties, we suggest you add salt to the salt container even if the hardness of your water is as low as a 6 clark degrees.

In hard water areas if a phosphate free detergent is used, white marks on the dishes and glasses may be observed. It may be prevented by increasing the amount of detergent.

Detergents without chlorine have less bleaching effect. Coloured stains may not be completely removed. This may be prevented by increasing the amount of detergent, using a programme with a higher wash temperature or using a detergent with chlorine.

Warning: Two-in-one and three-in-one detergents.

You will obtain the best results from your dishwasher if you use separate detergent, rinse aid and water-softening salt.

Detergent manufacturers also produce combined detergents known as 'two-in-one' and 'three-in-one'.

Two-in-one: These products contain detergent and either rinse aid or water-softening salt.

Three-in-one: These products contain detergent, rinse aid and water-softening salt.

In general, you will obtain satisfactory results from combined detergents only under specific usage conditions. These detergents contain predetermined amounts of rinse aid and/or softening salt. This means that you cannot adjust the amount of water-softening salt and rinse aid required to suit the water hardness level in your home.

You should bear the following points in mind when using such detergents:

- Be sure to check the specifications of the product you are using and whether it is a combined product or not.
- Follow the instructions on the packet when using these products.
- The use of these products at the correct appliance settings will ensure economical use of salt and/or rinse aid.
- If the detergent is in tablet form, never place these in the internal section or cutlery basket of the dishwasher. Always place the tablets in the detergent dispenser of the detergent holder.

Using three-in-one detergent, softening salt and rinse aid.

These detergents will not give you the same drying performance that you can obtain by using separate detergent, salt and rinse aid. To increase the drying performance:

- Put your appliance's rinse aid setting at "1" and apply rinse aid. When the rinse aid is used up, add more rinse aid to the rinse aid dispenser.
- If you use combined detergents with a rinse aid setting higher than 1, hand contact may leave rainbow-coloured water stains on the washed items and inside the machine.
- If you use combined detergents without adding salt, lime scale may form especially on glasses.
- To avoid lime scale formation: Put your appliance's water softener setting at "1" and add salt. When the salt is used up, add more salt to the water softener.

Using two-in-one detergent: Detergent and softening salt.

These detergents **do not** contain rinse aid so you need to use the rinse aid setting as described in the manual, making sure that there is rinse aid in the rinse aid dispenser with every wash and that you refill the rinse aid dispenser with rinse aid every time it is empty.

Using two-in-one detergent and rinse aid.

These detergents will not give you the same drying performance that you can obtain by using separate detergent, salt and rinse aid. To increase the drying performance:

- Put your appliance's rinse aid setting at "1" and apply rinse aid. When the rinse aid is used up, add more rinse aid to the rinse aid dispenser.
- If you use combined detergents with a rinse aid setting higher than 1, hand contact may leave rainbow-coloured water stains on the washed items and inside the machine.
- These detergents **do not** contain softening salt so you need to use the softening setting as described in the manual, making sure that there is salt in the water softener with every wash and that you refill the water softener with salt every time it is empty.

Important warning.

Should you encounter a problem that has previously never occurred after you start using these detergents, contact the detergent manufacturer directly. You will find contact details on the packet.

If you stop using this kind of detergent:

- Ensure that the salt and rinse aid dispensers are full.
- Put the water hardness setting at the highest level and run a wash cycle with the appliance empty.
- After washing while empty, return the water hardness setting to the correct level for your mains water hardness shown in the manual.
- Put the rinse aid setting at the correct level.

5 - Before calling for service/problem solving

Before calling the **LAMONA** Service Line check the following and trouble shooting guide below.

- Is the machine plugged in and switched on?
- Is the circuit breaker switch on?
- Is the water supply valve turned on?
- Is the dishwasher door closed firmly?
- Are the filters clogged?
- Is the detergent dosage and/or rinse aid sufficient?
- Is there enough salt in the water softener?
- Are the spray arms blocked / turning freely?

Fault codes



Not draining water.

Check drain hose for kinks/blockages.

Internal leak - signs of water.

Turn off at water supply and mains electric.

Call for a Service Engineer.



No water supply.

Check water valve is on and fill hose is not kinked.

PROBLEM SOLVING		
Problem	Reason	Solution
Spotting / filming / poor cleaning results.	Insufficient amount of detergent.	Increase the amount of detergent, especially when washing full loads or in hard water areas.
	Hard water areas.	Increase water softener dosage. Use additional detergent, increase rinse agent dosage.
	Incorrect wash programme selected.	Wash using a hotter, longer cycle.
	Utensils have surface deterioration.	Not possible for water to flow away on surface.
	Spray arm needs cleaning.	Check the nozzle holes in the spray arms are not blocked with food debris. Check and clean them periodically.
	Improper loading.	Follow instructions for use and loading procedures. Place dishes so that water spray reaches all soiled surfaces. Do not overcrowd the baskets since this will block the water spray.
	Insufficient water fill.	Check mains water pressure. Fill hose kinked.
	Filter system needs cleaning.	Remove any accumulated food debris. Check and clean filters periodically.
	Over sudsing - pre-washing with a liquid dish washing detergent.	Rinse items thoroughly before putting them into the dishwasher to remove dish washing detergent.
Dishes not dry.	Improper loading.	Load so that all items are properly tilted for good drainage. Avoid nesting of dishes and/or silverware.
	Rinse aid supply depleted.	Add liquid rinse aid.
	Short, cooler wash programme selected.	Select longer, hotter programme.
	Some plastic dishes and similar products do not always dry well due to lack of heat retention.	

PROBLEM SOLVING

Problem	Reason	Solution
Small particles (food or detergent) left on items.	Water not reaching surfaces, dishwasher overcrowded.	Check to be sure water action is not blocked by dishes. Check filter system for accumulated or deposited food or detergent. Load dishwasher correctly. Keep filter system clean.
	Insufficient water fill.	Check mains water pressure. Fill hose kinked.
	Powder detergent stored too long or under adverse conditions.	Use powder detergent within one or two months after purchase. Open one box at a time. Always close pouring spout after each use. Store in a cool, dry place.
	Rinse aid supply depleted.	Add rinse aid to the dispenser.
Decorations being erased on kitchenware	Items unsuitable for dishwasher.	
Items being scratched	Salt leakage.	Check lid on dispenser is tight.
	High salt content on plate.	Perform wash cycle sooner.
Pitting of steel items.	Prolonged contact with salty or high acidic foods or with undissolved or highly concentrated detergent.	Remove spots with silver polish. Rewash. Wash soon after use, or pre-wash items if they will not be washed right away. Do not overload cutlery basket. Avoid spilling or pouring detergent directly on flatware. Make sure dispenser cup is properly closed.
Scratches on glassware.	A water or chemical reaction with some glassware. Usually caused by some combination of soft or softened water and alkaline washing solutions reacting with the glassware. Can be accelerated by poor rinsing, overloading and excessive temperature.	The condition may not always be preventable. To minimise the possibility of etching, use minimum amount of detergent.
		Use of the appropriate programme.
		Use of a rinse aid may also help.
Detergent cakes in detergent dispenser.	If using a powder detergent, there may be dampness in the dispenser.	Make sure dispenser is dry before adding powder detergent. Start dishwasher immediately.
	If using a gel detergent, the detergent may be left in dispenser too long before using.	Start dishwasher soon after adding gel detergent. Do not allow detergent to dry out in the dispenser.
	Faulty cover.	Do not overfill. Cover should close tightly. Check cover for fit.
	Improper loading.	Do not place large items in front part of dishwasher.
	Old detergent.	Use detergent within one or two months of purchase. To assure freshness, buy detergent as needed and no more than one or two at a time. Store in a cool, dry place.
	Tablet not dissolving.	Select longer wash programme.
Chipping and breakage of dishes / glasses.	Improper loading.	Load with care following the instructions for use. Place glassware so it does not touch the other dishes. Remove from dishwasher carefully.
Odour in dishwasher.	Dishes washed only every two or three days.	Use the pre-wash cycle at least once a day until a load accumulates, or hand rinse dishes before loading the dishwasher.
	A dirty filter system may contribute to a bad odour.	Clean filter system.
	Using low temperature programmes constantly.	Run a service wash programme.

6 - Guarantee

Product Guarantee Details (UK only)

Your appliance has the benefit of a comprehensive manufacturer's guarantee which covers the cost of breakdown repairs. (Details of which are shown on your Proof of Purchase Document).

- Any claim during the period of the guarantee **MUST BE ACCOMPANIED BY THE PROOF OF PURCHASE.**
- The product must be correctly installed and operated in accordance with the manufacturer's instructions and used for normal domestic purposes.
- This guarantee does not cover accidental damage, misuse or alterations which are likely to affect the product.
- The guarantee is invalid if the product is tampered with, or repaired by any unauthorised person. (The guarantee in no way affects your statutory or legal right)

What to do if you need to report a problem.

Please ensure you have ready:

- The product's model and serial numbers.
- Howdens Proof of Purchase Document.
- Your full contact details.

Call the Depot number on your Proof of Purchase Document supplied with the product/kitchen.

or

Call the LAMONA Service Line on 0344 460 0006

* Product installed within a domestic kitchen or a non-domestic kitchen where 8 or fewer people are using the washing machine.

Spare parts availability - 10 years

Only fit Genuine Spare Parts

www.lamonaspares.co.uk



Where to find the model and serial number on the washing machine.	On the right-hand edge of the door.
-------------------------------------------------------------------	-------------------------------------

7 - Technical specifications

Specifications

Supplier name/trademark	LAMONA
Model name	LAM8304
Load capacity	10 Place setting
Built-in	Yes
Height	820mm
Width	448mm
Depth	570mm
Net weight	29.6kg
Supply voltage	220-240 V ~ 50 Hz
Fuse current	13 Amp
Total power	1800-2100 W
Diameter of plate for;	
Upper basket	250mm maximum
Lower basket	310mm maximum

Water softening system

Washing performance will increase when water softening system is adjusted properly.

The regeneration of the water softening system can be done in all programmes during drying step. When regeneration occurs, duration, energy and water consumption of the programme increase.

For regeneration process; frequency of regeneration cycle, maximum additional duration, water and energy consumption are given in table below depending on Eco 50°C programme water consumption, when the dishwasher is run under standard conditions with 14 dH water supply on its Eco 50°C programme:

Eco 50°C water consumption (l)	Regeneration after cycles	Additional duration (min)	Additional water consumption (l)	Additional energy consumption (kWh)
12.3-14.7	5	5	3.0	0.05
9.6-12.2	6	5	3.0	0.05
9.0-9.5	7	5	3.0	0.05
8.0-9.0	8	5	3.0	0.05
7.0-7.9	9	5	3.0	0.05

Information

The model's technical information can be retrieved by scanning the QR code on the Energy label and proceeding to the website entering the model identifier.

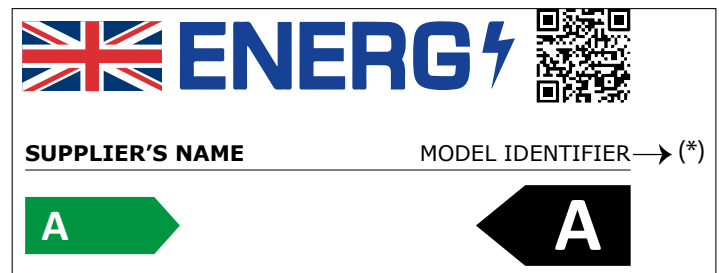
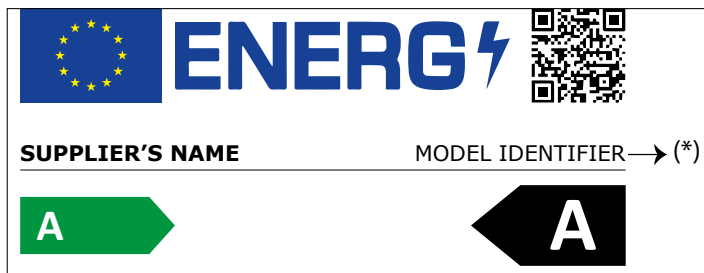



Product serial number
(Place sticker here)

LAMONA

Product information correct at the time of publication in November 2020.
The company has a policy of continuous product development and reserves the right to change any products and specifications given in this manual. Subject to the Terms and Conditions of Trading, a copy of the Howdens Terms and Conditions is available upon request.
Copyright © 2020 Howden Joinery Ltd. All rights reserved.

ISSUE v1 011120