

# Bus Safety Solutions



## Installation Manual

Extended Stop Arm V1 2022

**Electric and Air System**

**IC, Blue Bird and Thomas Built Buses**



## Table of Contents

Tools and Supplies Needed.....	3
Introduction .....	4
Control Box Versions.....	4
Removal of Electric/Air Original Stop Arm - All .....	5
Install Hinge Frame Assembly – All .....	6
Position frame and installing - All .....	8
Install Control Box and Board - All .....	9
V2: Typical IC positioning .....	10
V2.5: Typical Thomas Positioning .....	10
Typical Bluebird Positioning Wire Port in front: .....	11
Power source - All .....	12
Thomas Power .....	12
Removing rub rail and drilling holes: Thomas only .....	13
IC (International) Power.....	13
Blue Bird Power.....	14
Connect Air Hose – For air installs only - skip for electric actuator models .....	15
Thomas Air .....	15
IC AIR.....	16
Blue Bird Air .....	16
Complete Wiring – All .....	17
Wiring Diagrams - All .....	17
Control Box Versions - All.....	20
Control Box Install and Wiring: - All .....	21
Run Electrical Connections - All .....	22
Connect Actuators – All .....	22
Attach Air Actuator – air model only .....	23
Attach Electric Actuator – electric model only .....	23
Install Frame & Sign - All .....	24
Install Bumper – All.....	25
Button Up - All.....	26

## Tools and Supplies Needed

- Safety Glasses
- Work Cart
- Magnetic dish
- Tape measure
- Small Level
- Impact Driver
- Drill Motor
- Assorted nut drivers
- #2 Philips Bit, #3 Philips Bit
- Assorted drill bit set
- 7/8" Conduit Hole bit
- 9/64" steel bit
- 3/16" steel bit
- ¼" steel bit
- 9/32" steel bit
- 5/16" steel bit
- 5/8" steel bit
- 9/16" steel bit
- Hammer
- Roll of purple 16-gauge wire
- Roll of yellow 16-gauge wire
- Vice Grip – Small & Large
- Utility Knife
- Needle Nose Pliers
- Cold Chisel
- #2 Philips head screwdriver
- #3 Phillips head screwdriver
- Flathead screwdriver
- 2 - ½" Wrenches
- 2 – 5/8" Wrenches
- 2 – 7/16" Wrenches
- 1/8" Allen Wrench
- Socket Set
- Electrical Wire Crimping Tool
- Electrical Wire Stripping Tool
- Electrical Multi-Meter
- Clear Exterior Silicone
- School Bus Yellow Exterior Silicone
- Air hose cutter
- Roll of blue 16-gauge wire

## Introduction

Welcome and thanks for installing our Standard 24" Extended Stop Arm!

This manual cover Blue Bird, International (IC), and Thomas buses for electric and air models. Each section will note if the steps are for "All" or a specific model. Skip parts that are for a model that you are not working on. If we mention a specific version model like Air or Electric, then you can skip if you are installing the other model.

Have fun and feel free to call us if you have a question. Number at end of document.

Note for Blue Bird and Thomas buses make sure you have the proper install kits for them before beginning.

## Control Box Versions

There are two versions of the Control Box

### V2 Enclosure



Note: If installing with V2.5 enclosure both light cables and power line will run through bottom loom.

### V2.5 Enclosure:



## Removal of Electric/Air Original Stop Arm - All

- Carefully remove the entire existing Specialty or SMI stop arm.
- The original sign and wiring harness will be re-used with the Extended Stop Arm.
- Save all parts – some for re-use later, others as replacement in your inventory.
- For Air System install: Don't lose airline as you will use it again and if needed add some additional line added to it.
- Disconnect sign from the specialty box by removing the four nuts connecting the sign.



- Pull out as much cable to the lights as you can. If an electrical unit, they will be tied up inside the box, if an air bellows unit it will be tied up inside the control panel.
- Remove the old sign unit whether electric or air bellows unit.
- Do not cut the electrical light harness cable and air hose. This will need to be used later.
- Disconnect wiring at the male/female connections.
- If there is a back sign on the bus and is operated by an air bellows unit, then cap the front line off.
- If bus is using Flasher: Save the flasher relay if the old sign doesn't have the flasher incorporated in the lights.
  - Note: diagram shows how you will use the flasher.
- 

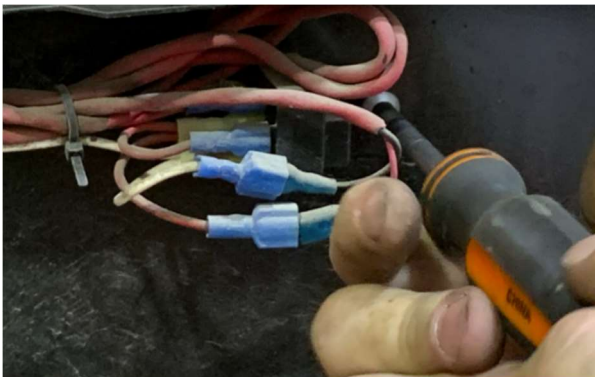

- Mark the connections so you can remember them

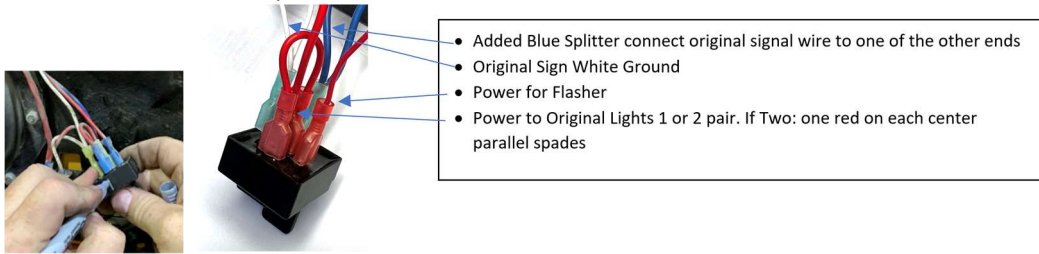

For reference below. Note the flasher location. We will install this later on.

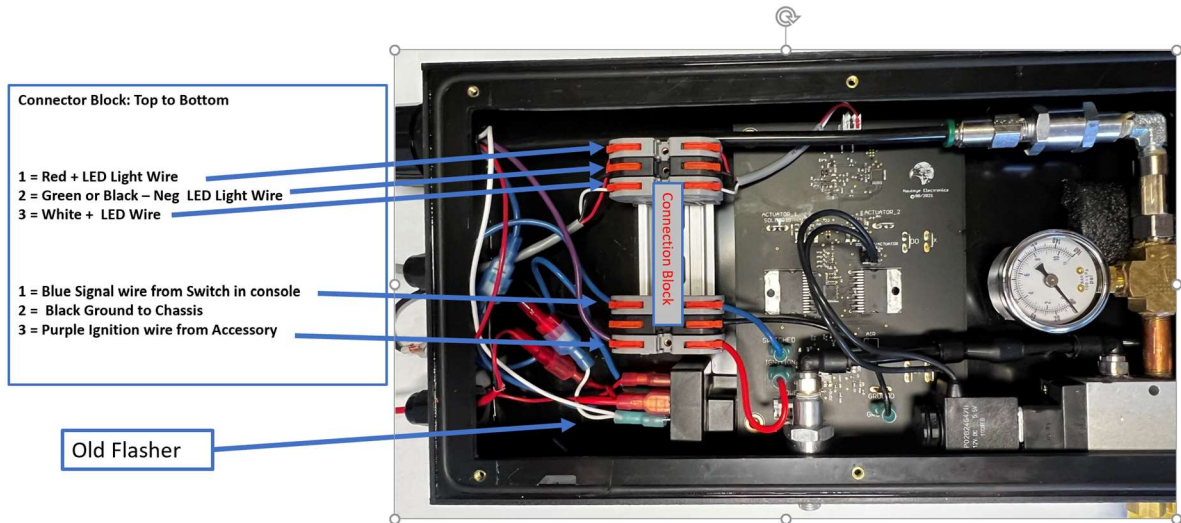

## Standard Air for all models

### Install Hinge Frame Assembly – All

- PRIOR TO INSTALL, MAKE SURE NO SCREWS WILL PENETRATE A CABLE WITHIN THE BUS!
- Install Black Frame assembly, must be vertical, use yellow bus siding panels as guide. Pre-drill with 9/64" drill bit as needed. Note: you should be able to use original Specialty Box front mounting holes. Use all three mounting points in the vertical portion of the frame.

Note: there is a great chance that bus will have a large hole where the current wires com out. We supply a yellow plate that you use to cover this hole and you drill a 7/8" hole in at the proper location to cover the hole and allow the connection of our loom with watertight connector: Sample diagram: Also, newer models have different loom connection they all use a 7/8" hole.





Someimtes even two holes!

- Use the provided plate to cover them and drill the 7/8" hole. Use silcone to seal the plate.
- Use black frame to hold down front of plate and back of plate should be covered by control box.
- Mark the location of the existing hole and where it will align to the plate once it is placed on bus.

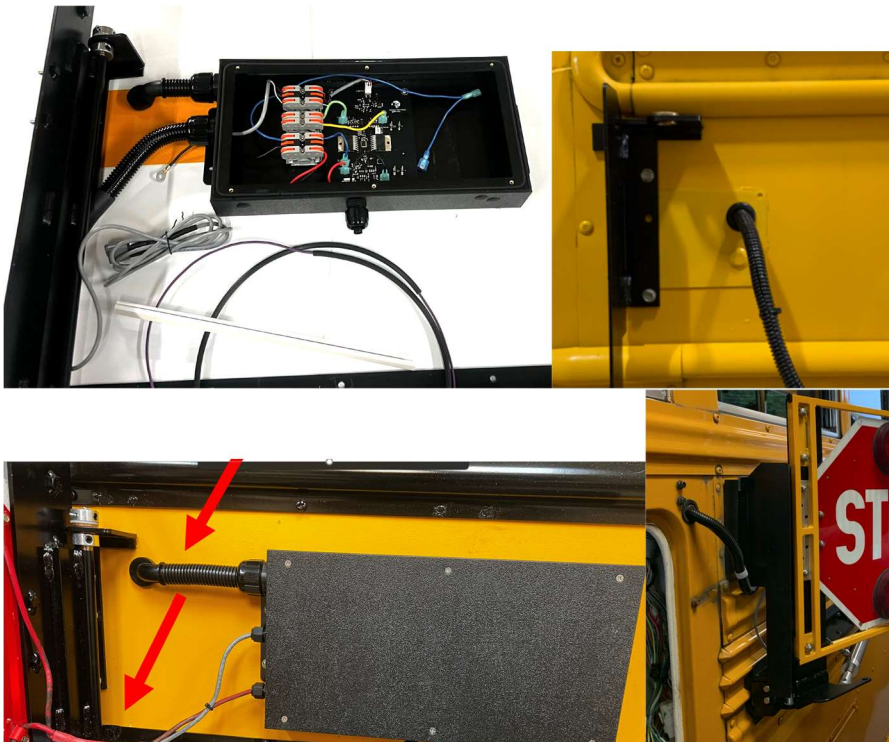

### Position frame and installing - All

- Position frame just under to rib
- Align over old Sign front bolt holes. Note: you do not want to attempt to run screws in seam of body.
- **Blue Bird Only** - Place spacer under horizontal frame (Long spacer in Blue Bird kit) and short under Vertical frame as shown in diagram.
  - Using longer 12mm screws supplied in bluebird spacer kit, run a few screws in the lower horizontal frame to support vertical frame.
- **IC and Thomas Only** – Use stand 12mm screw and secure horizontal frame aligned just under bottom of rib keeping vertical square to bus side.
- Be sure no rivets or screws interfere with a tight fit against the side of the bus, if so remove them.
- Place short spacer under top frame



- The vertical frame should be marked, drilled, screwed in with self-taping screw to securely anchor the vertical bracket and spacer if bluebird





- All - Finish securing screws on frame

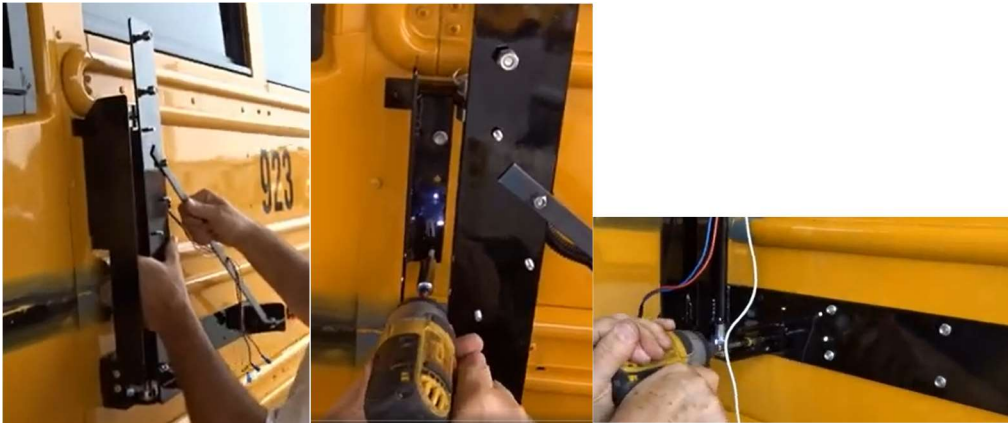

Note: for any holes for the wiring that need to be covered we supply a rectangular plate you can seal with silicone behind it. Tuck in under the new frame to help hold it and use a few self-tapping screws to secure the other end.

- Use  $\frac{3}{4}$ " x 12 self-tapping stainless-steel screws for the installation of the entire frame assembly.
- Be sure no rivets or screws interfere with a tight fit against the side of the bus, if so remove them.
- Ensure you have used screws in all holes for Black frame.

#### Install Control Box and Board - All

**Note:** Note the watertight loom kit. Signal Wire, Air Line and Power from Ignition will feed through the watertight loom. The Note the Old Stop light red wire and the new grey Light wiring is routed through smaller ports. There is an extra port supplied is two are needed for old wires from light.

**Important note:** Do not fully install loom kit till you have power and air lines installed so you will be able to gauge the length of wiring and airline in installing air. This will also allow you to feed the lines through easier.

- Use 4 #12 x 1" ss screws
- Silicone back of box for additional adhesion if you wish.
- Attach the box with 4 short 12mm self-tapping screws

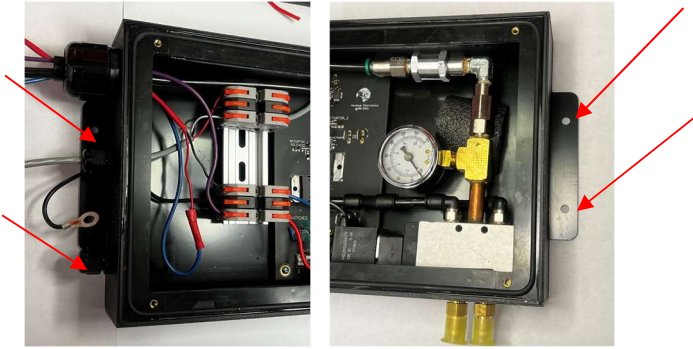

V2: Typical IC positioning

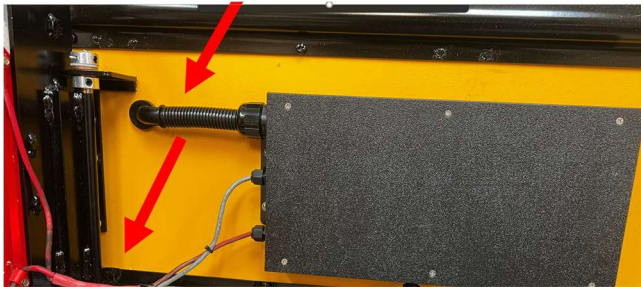

V2.5: Typical Thomas Positioning

## V2.5 All 24" Standard Enclosure Positioning

Design layout and proximate location for enclosure

1A = legacy wiring and power for IC and Blue Bird  
1.B = old wiring for Thomas

2A = Old sign wires and new sign wires for IC and Bluebird  
2B = Power, Old sign and New sign wires for Thomas

3 = Wiring kit for Thomas - 5' Purple wire, 3' tubing, 18 cable guard for rib installation and protection.

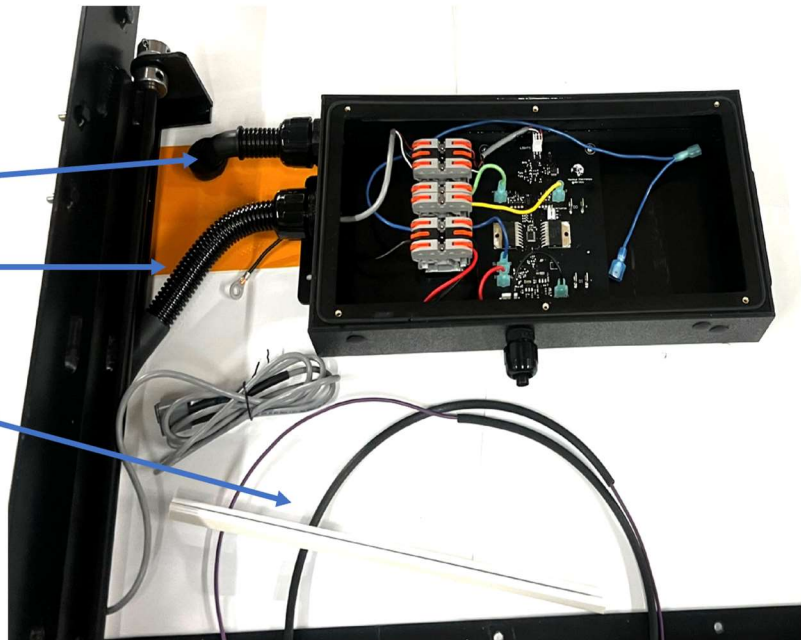

- Notice the yellow plate in above diagram and positioning of enclosure (Control Box)

- Connect the black external wire to the lower left screw and then run the screw down.  
Note: Ground wire outside by hole
- For V2.5 make sure you strap down lower loom tube with included white clamp.

Typical Bluebird Positioning Wire Port in front:



- Wire Port on front of Frame
- Loom Strap
- Spacers

- Notice the yellow plate in above diagram and positioning of enclosure (Control Box)
- Connect the black external wire to the lower left screw and then run the screw down.  
Note: Ground wire outside by hole
- For V2.5 make sure you strap down lower loom tube with included white clamp.
- Tubing on end of loom is heat shrink tubing and you may wish to shrink the tubing down after installing all wiring.
- If the control box covers any numbers, new decals will need to be applied.
- Run old wire through loom before locking it into side of bus.
- Once wire is pulled through clip watertight loom and elbow into side of bus using yellow plate and the 7/8" hole.

## Power source - All

### Thomas Power

- Thomas - The Extended Stop Arm requires a 12-Volt power source. This can be found underneath the left console switch panel.



- Open the left driver side console: Note the location and use empty space and connect purple wire direct instead of supplied fusible link if able. Connect with female connector and 15-amp ATC fuse in open space of the accessory block.

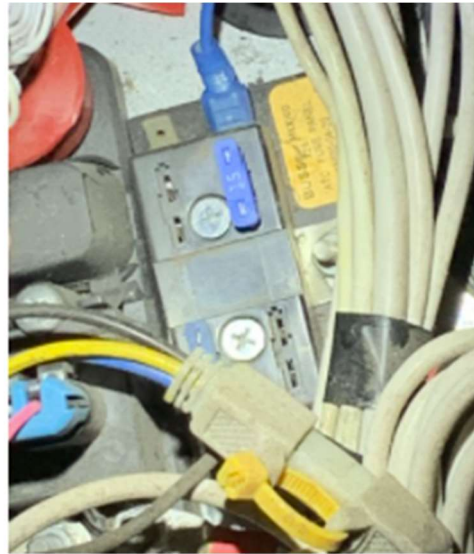
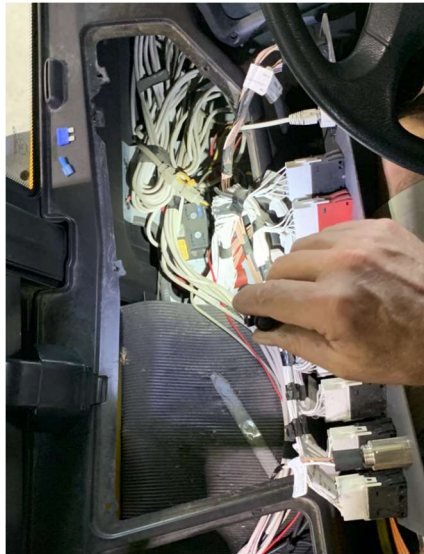

- The Purple wire is our preferred Power (Accessory) wire with 15amp in-line fuse or with 15-amp fuse in accessory block. Locate an accessory connection if not able to use block; usually you can use a round connector where main power comes into the accessory block and use inline fusible link.



- Fusible Line



### Removing rub rail and drilling holes: Thomas only

- Remove the horizontal rib underneath the driver window. Carefully drill one 5/16" holes into the wiring compartment under the switch panel. Insert grommets in the hole. Run one 5-ft length of purple 16 gauge into the bus compartment using supplied tubing to protect wire.



#### Note:

- Connect the purple accessory wire to the accessory block as described earlier if not already done and run through the bus wall
- Be sure to protect the wire from rubbing the metal hole with tubing large enough for wires and flexible enough to bend. We use rainbird tubing. Some is included in Thomas kit.
- Do not shorten wiring till measured to fit to installed box.
- Cut a length of wire mold almost long enough to reach the next section of bus rib
- Place a piece of ¼" flexible tubing (resembles airline) over the purple wire and run it up far enough to reach the control box and use one of the spare connector ports to run the wire inside the box.
  - The tubing should be long enough to reach inside the bus to protect wire from sheet metal and reach the connector and go through it on the control box.



**All outside wires will go in lower loom from Enclosure for Thomas which end will be located just under the vertical frame for easy access. Be sure to fill hole with some silicone when all wires are feed through.**

- Replace rib making sure not to pinch tubing and wire.

### IC (International) Power

- The Extended Stop Arm requires a 12-Volt power source. This can be found in the electrical panel in an **IC**.
- Connect the wire to an accessory block and insert a 15-amp fuse
- If the block is not present or functioning, connect to the solenoid and use an in-line 15-amp fuse. A Few Options: first is preferred method.

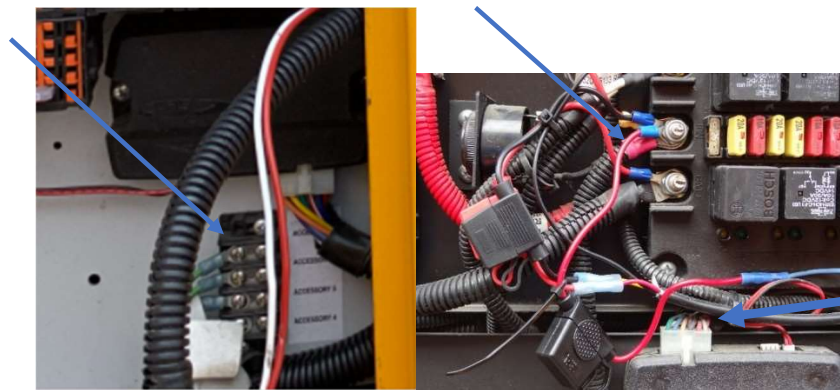

### Blue Bird Power

- The Extended Stop Arm requires a 12-Volt power source. This can be found in the panel box in Bluebirds.
- On a **Bluebird**, run the power wire through the same hole that the Specialty light wires are located.
- Connect the wire to an accessory block **THAT IS CONTROLLED BY THE IGNITION SWITCH** and insert a 15-amp fuse
- If the accessory fuse block is not present or functioning, connect to the main power and use an in-line 15-amp fuse.
- Run the power wire all the way into the control box with the Bus Safety Air Solenoid. Connect the black power line to the 12-Volt source using a butt connector.

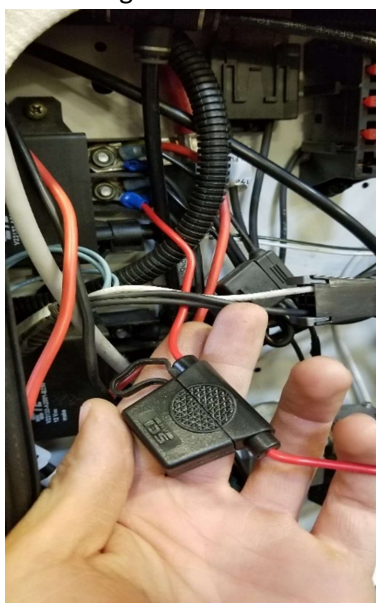



## Connect Air Hose – For air installs only - skip for electric actuator models

### Thomas Air

- Locate the air supply line—the sample shot: green hose—located on most Thomas C2s in the lower access panel left of driver.
- Disconnect the airline from the stop sign regulator, usually the one on the left that goes to the specialty box. This line will be reconnected to the tee and extended outside to run into our new box.
- Note: Air should be on the high-pressure side 100-120 PSI. Not after the regulator valves.
- Disconnect the line from the stop sign regulator output side – you will connect it to the new connection as below.
- Trim off ½” of the line for clean fit when reconnected.
- Disconnect the line coming from the first tee going to the regulator.
- Connect the original line going to the specialty box to this tee. This will supply full pressure to the control box outside now.

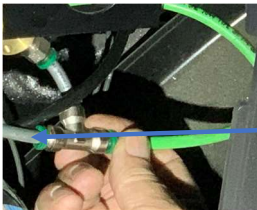

Disconnect this line and reconnect the line to outside box here.

- Do not cut the exterior airline until the boxes and air assembly are mounted. You may need to use a bullet connector and add some line.

## IC AIR

Disconnect the main airline from regulator and connect a new line to our control box which will be install further down.

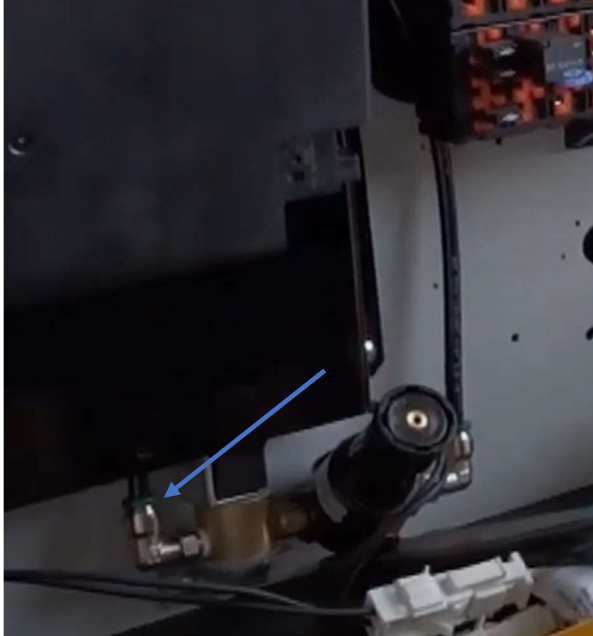

## Blue Bird Air

- Locate the input air line, disconnect from regulator, connect a tube-to-tube connector and run the line straight out to the solenoid in the box.
- IF you have 2 signs on the bus, and the back one is run by Air Bellows as well, then you will have to TEE off at the incoming side and run a new air line to the front unit. Cap off the old line at the side of the bus.
- The Extended Stop arm needs at least 60# pressure to operate and can handle 120#. That is why you by pass both the control solenoid and the pressure regulator.

Disconnect here and connect to new  
airline and then add new line as on  
right

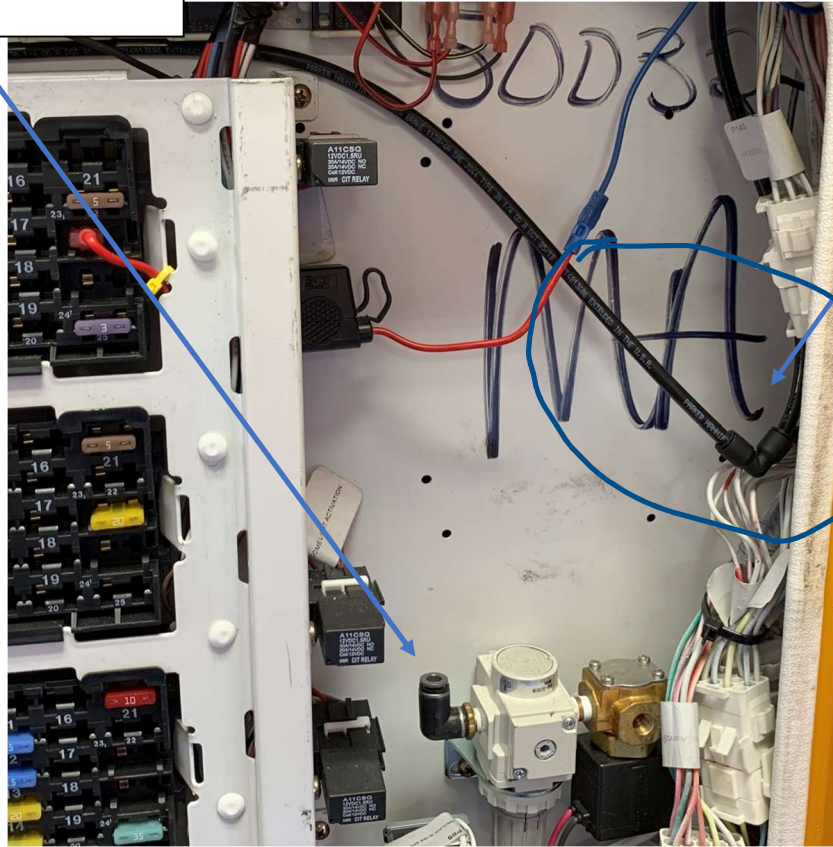

### Complete Wiring – All

Wiring is very important to ensure we do not short out connection Pay close attention to wiring diagrams and schematics for each solution.

### Wiring Diagrams - All

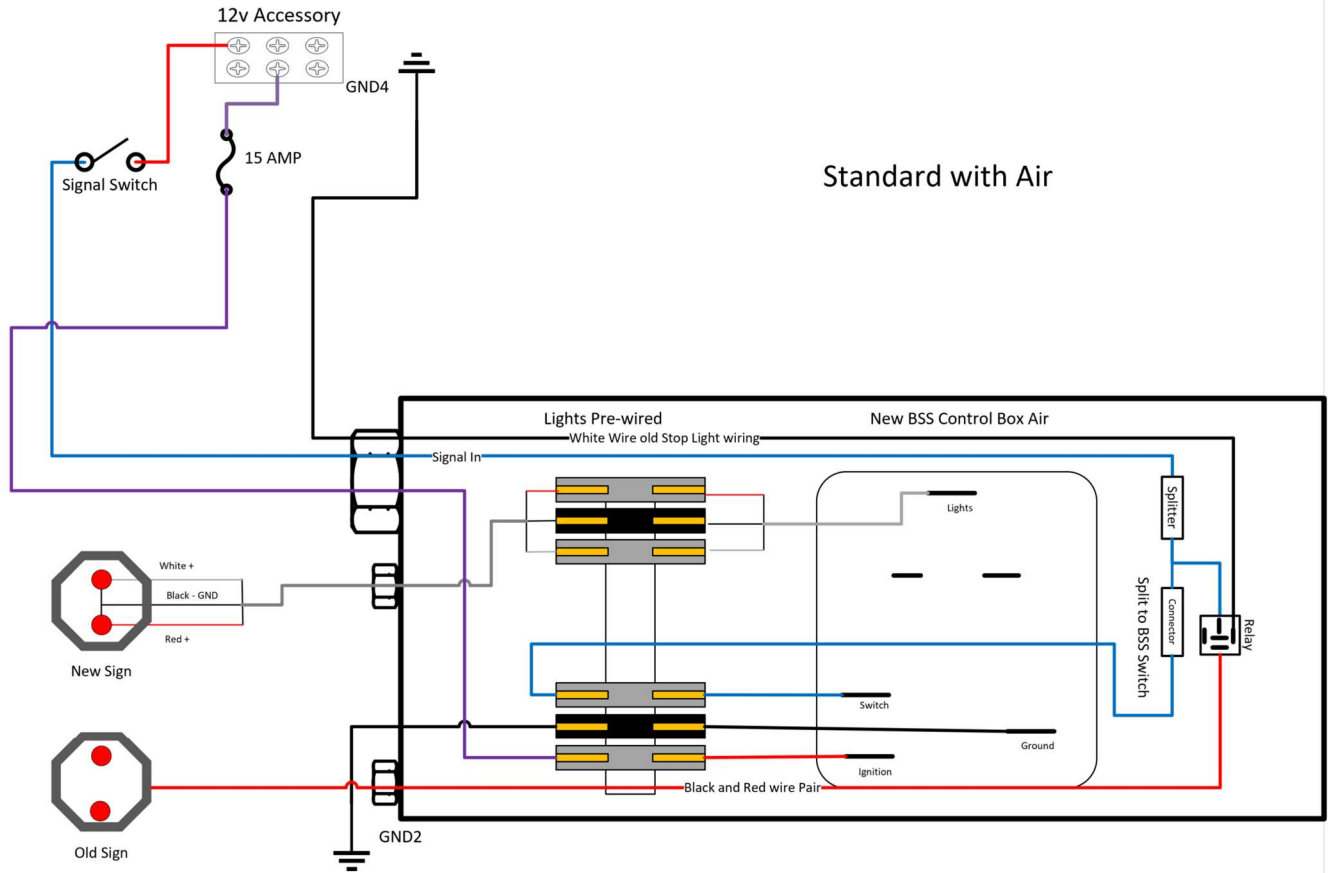

Standard with Air

BSS 3/3/22

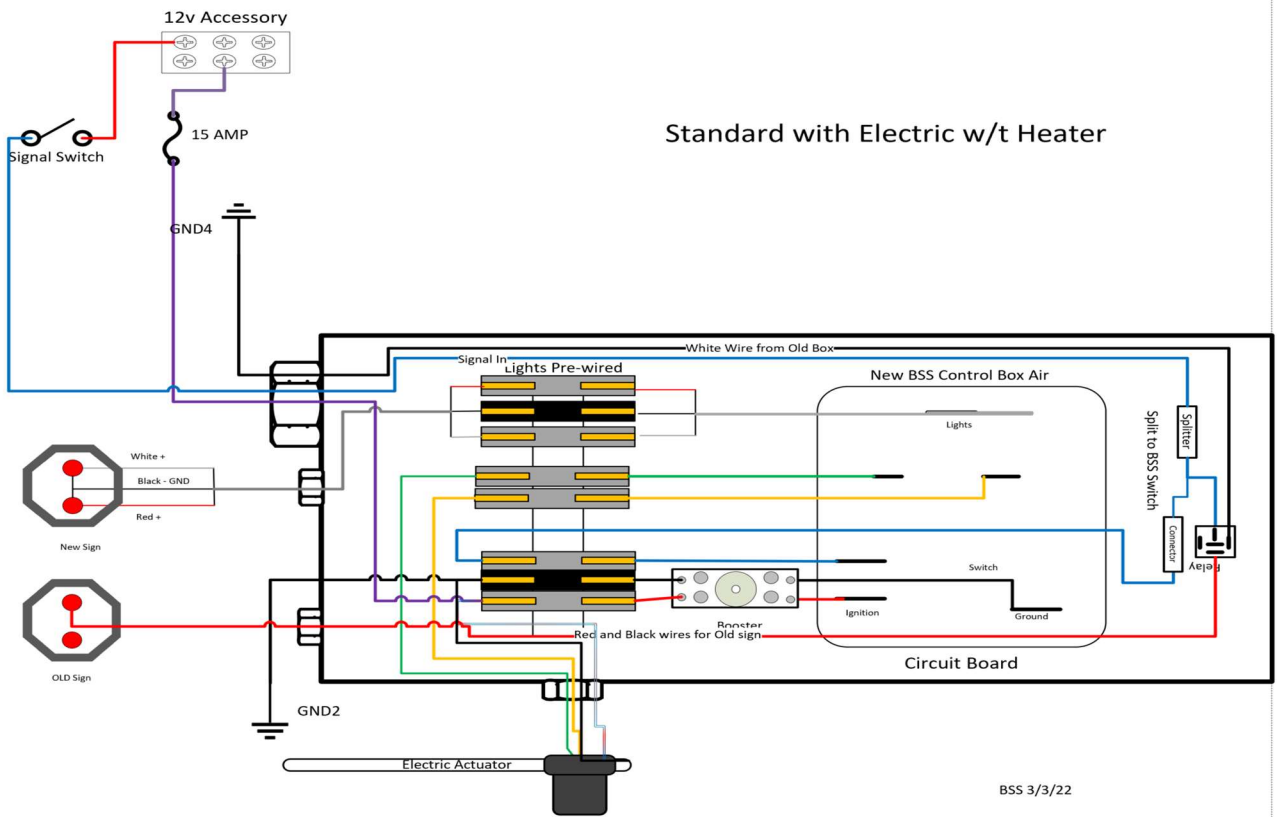
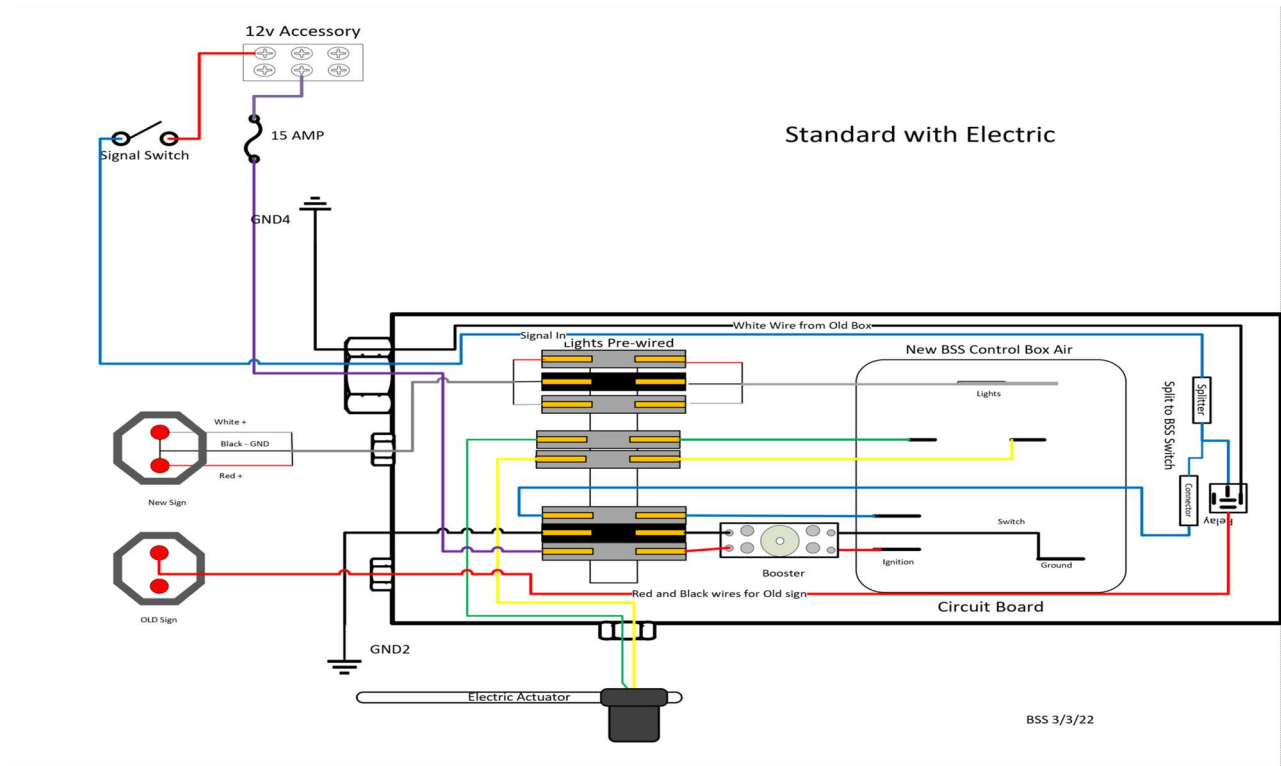

## Control Box Versions - All

There are two versions of the Control Box. We left out the Air components, so it is simpler to digest

### V2 Enclosure



Note: If installing with V2.5 enclosure both light cables and power line will run through bottom loom.

V2.5 Enclosure: We added lower loom for better cable protection





Control Box Install and Wiring: - All

- Important to understand the wiring at this point.

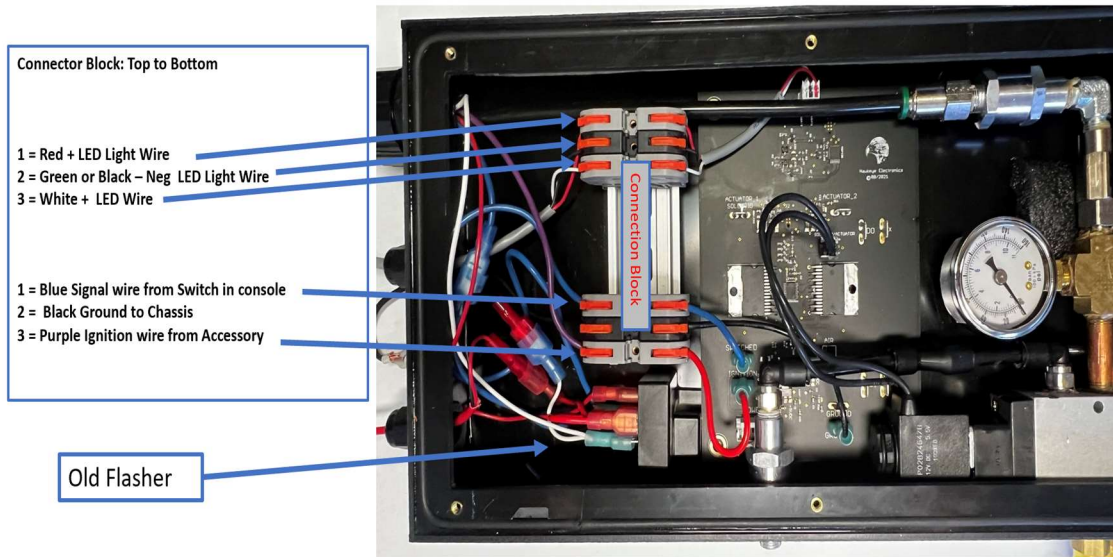

## Standard Air for all models

### Typical for Blue bird:

#### New Box Connection / Heater / Electric Actuator / No Flasher

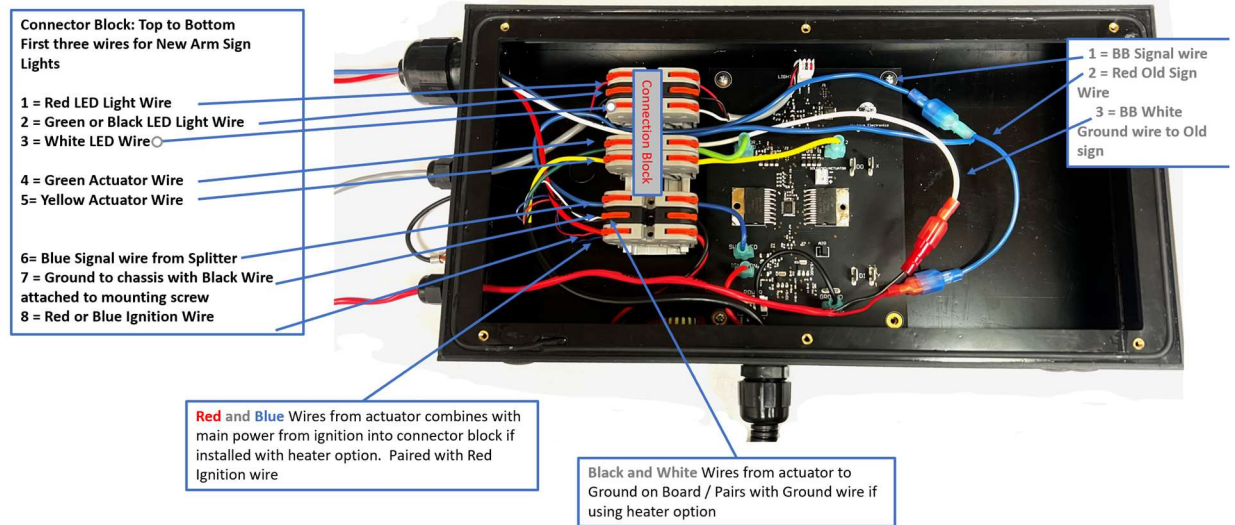

**Especially important:** When wiring using these terminal wires, they need to be **stripped ¾" long** and with orange tab lifted insert wires all the way in and then push orange lever back down to lock in wire.

- Do Not Screw on the cover plate until all testing is done later.

## Run Electrical Connections - All

- Finish running purple wire into control box
  - For V2.5 Enclosure make sure the wire is long enough to go to watertight loom on the bottom port of control box. Run tubing in a fair distance and run purple wire into box and connect to the connection block.
- Connect Power "Purple lead" to connection block
- Connect Splitter to blue wire
- Connect one end to the flasher where the signal wire connected
- Connect some addition wire and connector to the other splitter connection and run to the signal connection on the connection block for Signal to our board.
- Connect old red wire to the flasher the position it was before.
- Pull wiring for old stop sign into control box
  - V2 Using older Thomas light with one wire use additional connector and knock out bottom plug for Tubing and power cable. If you have two red light wires use the two connector ports to run the wire and make a small hole in the top loom and run the tubing into the hole and wire run to the connection block in the enclosure. Use some good vinyl electrical tape to secure the tubing and seal hole.
    - Note you may need to clip old sign connectors and use new ones if installing V2 enclosure
  - V2.5 - Run Old sign wires into box using lower left connector or loom. V2.5 will accommodate the connectors if run through looming first.
    - You can take the provided shrink tubing on the end of loom and shrink more if you have a heat gun to ensure a better seal once all the wires are run and tested.
  - Connect to Flasher as originally installed
- Connect Old flasher, using old light wires, red power wire for old lights, Ground wire "White" and signal wire with splitter. Review electrical diagram and images if needed in top of doc.
- Put two side tape on back of flasher and attach it to the box below the connection block.

Leave the cover off the new box till testing is complete.

When done you will use supplied stainless steel screws and snug them down when closing

## Connect Actuators – All

We support two types of actuators

- Air (pneumatic)
- Electric in two options

- Standard
- Heated for Cold Weather: 0 and below

Note: The control box comes set up for the specific option.

#### Attach Air Actuator – air model only

- Mount tail piece of Air actuator to the right-side mount on the horizontal support bar, using a nylon washer and 7/16” bolt and nut. The washer should rest between the top tab of the tail piece and the top side of the mount. Do not tighten bolts till complete and ready to wrap up job.
- If kit uses clevis pin and cotter key be sure to use them and set cotter pin by bending end to each side to lock it in.



- Connect the airline to the box – Right connection goes to front of actuator
- After you start bus check air pressure to ensure it will be between 100 – 120 PSI.
- Left port on box goes to rear connector on air cylinder. Looking at cylinder it will be on the right side per arrow.

#### Attach Electric Actuator – electric model only

- Mount tail piece of Electric actuator to the right-side mount on the horizontal support bar, using a nylon washer and 7/16” bolt and nut. The washer should rest between the top tab of the tail piece and the top side of the mount. Do not tighten bolts till complete and ready to wrap up job.
- Kit uses clevis pin and cotter key be sure to use them and set cotter pin by bending end to each side to lock it in.
- Measure the length of loom needed for a loose fit for the external wire and cut to proper length. Wire nut on enclosure will lock down on loom.
- Insert cable through bottom middle connector by loosening the gland nut and sliding in. follow wiring diagram on connecting yellow and green wires, if with heated actuator option wiring will be paired together with Red and Blue together and Black and white together. They will connect in the connection block, Red/Blue with purple wire and Black/White with Ground.
- Don't forget the cotter pin when you are done. We do not lock in till we are sure of completed project.

## Install Frame & Sign - All

- Attach steel frame to the vertical frame using three 3/8" nylon insert nuts found on hinge plate.
- Tighten with 9/16" nut driver.
- Attach Extended Stop Arm to steel frame.
- Align using steel 1/4" round studs, once aligned, hold with vice grip, or an additional set of hands.



- Secure using two 5/16" nylon bolts and 2 nylon nuts.



- Tighten nylon nuts to snug with a wrench. Do not overtighten.
- Connect electrical harness to extended stop arm using harsh environment ATM connector

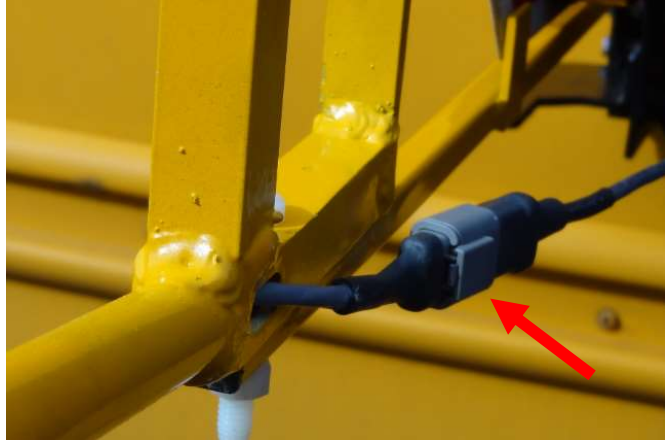

- Attach electrical harness to bottom of steel frame using 3 yellow zip ties.



#### Install Bumper – All

Note: For Air Only the Buyer should have a magnet in it and it will help hold in the arm if arm pressure is low

- Position rubber bumper vertically at the point of the bar connecting sign to frame.



- Attach with 2 self-tap screws, one on either side of bumper.





- Adjust sign by bending it slightly away from bus to ensure lights do not hit the bus when closing.

#### Button Up - All

- Close up stop arm box using original screws. Ensure yellow switch wire is secure.
- Cover exposed wiring from plastic box conduit to bus rib using wire loom.
- Place cover (bolts included) on plastic control box.
- Secure actuator nose piece to hinge using 7/16" clevis pin and 1/8" x 3/4" cotter key.
- Adjust actuator nose piece/cylinder to ensure reasonably tight fit against bumper, then tighten 7/16" bolt and nut.
- Run through installation checklist to ensure that all items are complete.
- Ensure that bus driver is aware and trained on using their new Extended Stop Arm.

**From your Friends at Bus Safety Solutions**

*Please Call* **336-671-0838**

**if you have any problems with the installation**