

How to Build a Double Voice Cracker

CAUTION!!

Working with pyrotechnic devices is a very rewarding endeavor that can become a lifetime passion. To ensure continued enjoyment of this hobby, please follow appropriate safety guidelines. Work in an open area outdoors, keep all pyrotechnic mixtures in closed containers, limit any compositions to only the amount needed for a particular item, store finished items in an appropriate day box or magazine, be sure to wear appropriate non-synthetic clothing, wear eye protection and keep a source of water nearby. FireSmith cannot be held responsible for any accidents or incidents resulting from the construction and use of any pyrotechnic devices. It is highly recommended to check and adhere to all local, state and federal regulations. Please consider joining the PGI and any pyro clubs in your area so that you may construct pyrotechnic items in a safe and legal environment. Additional information can be found at www.pgi.org.

Double Voice crackers are quick and simple devices to construct, but are immensely entertaining. The device is essentially a self contained aerial salute. The black powder lift charge is contained in the bottom cavity of the tube while a burst or salute charge is contained in the top cavity of the tube. The clay plug separates these two compartments and encapsulates a length of black match that acts as both a passfire and a time delay. Upon ignition, the black powder sends the device airborne while simultaneously igniting the fuse contained in the clay plug. When the fuse burns through to the top compartment the burst charge is ignited, delivering a nice report.

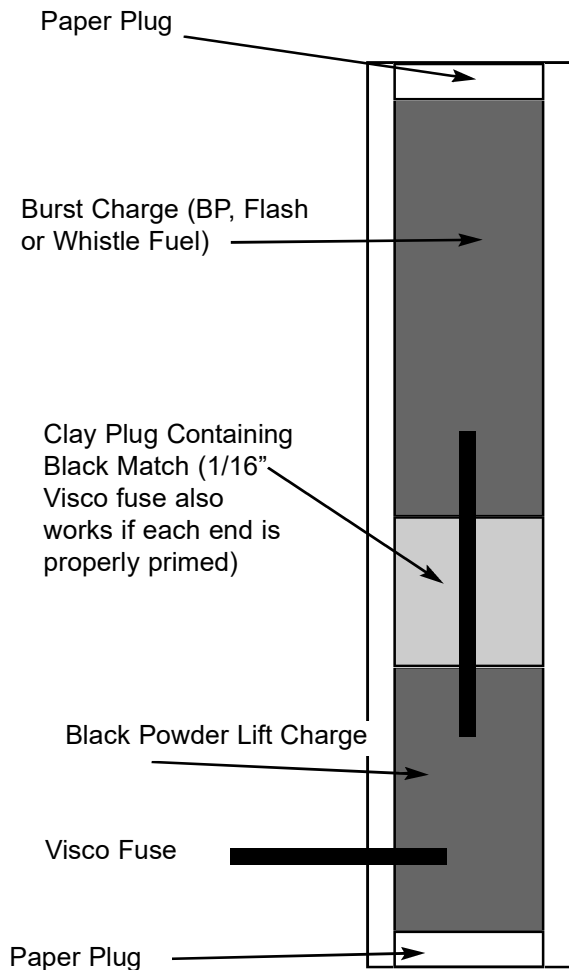



Required Materials:

- FireSmith Double Voice Cracker Tooling
- 1" ID x 6" paper Tube
- 2) 1" Diameter Paper Plugs
- 1) 2" Black Match
- 1) 3" Visco Fuse
- 1/8" Drill Bit
- Funnel
- Teaspoon
- Disposable Brush
- Cordless Drill (not pictured)
- Dead Blow Mallet (not pictured)
- Powdered Clay (not pictured)
- Black Powder (not pictured)
- Burst Charge (Flash, BP or Whistle, not pictured)

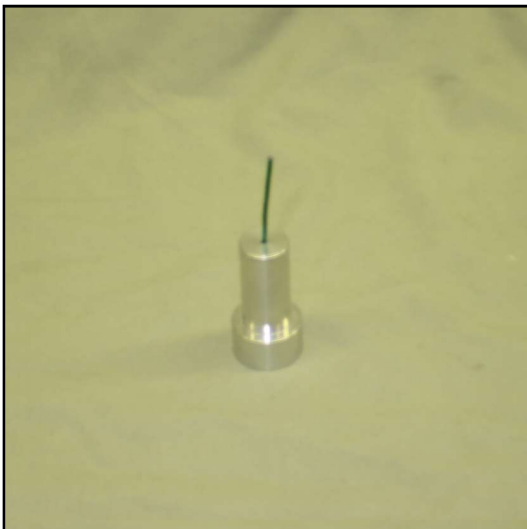

Step 1

Place the 2" length of black match or 1/16" Visco into the bore of the ramming base. Straighten the fuse as much as possible



Step 2

Slip the paper tube over the base.



Step 3

Add 1 tablespoon powdered clay to the tube and center the fuse. This is accomplished by tapping the tube while holding the fuse in place with the tip of your finger.



Step 4

Insert the rammer with a twisting motion to help capture the fuse in the rammer bore. Use a dead blow mallet to pack the clay into a solid plug. Typically 4-5 good hits is sufficient. The plug should be approximately 1" in thickness. The correct thickness is attained when the groove machined into the rammer is visible at the top of the tube after ramming.



Step 5

Remove the rammer and the base. The black match should be sticking up through each end of the clay plug.



Step 6

Mix a slurry of BP and water. Using the brush, coat each end of the black match with this prime.

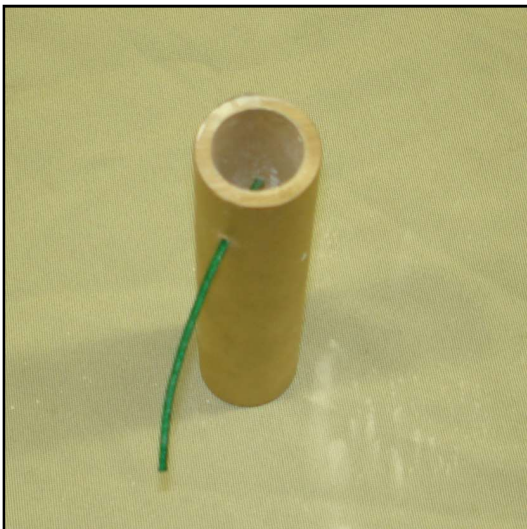

Step 7

Using a 1/8" bit, drill a hole in the lower compartment of the tube approximately 1" from the bottom of the tube. Insert the 3" length of Visco fuse and secure with a bit of glue.

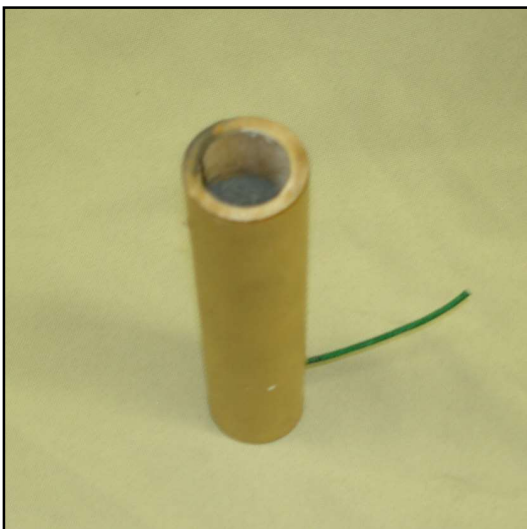

Step 8

Place the tube upright and fill the top compartment with the burst charge of your choice. Typically this is BP, Flash or Whistle Fuel.

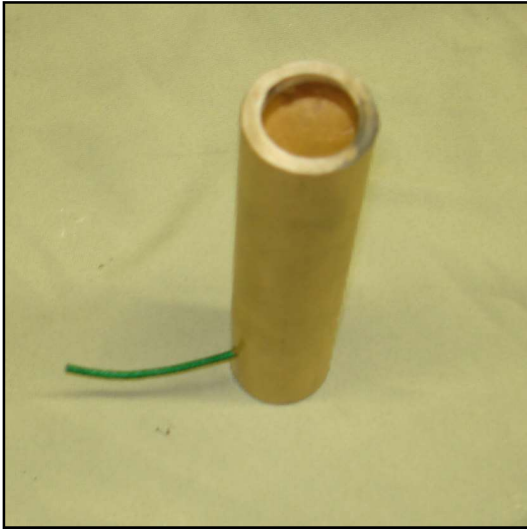

Step 9

Insert and glue a 1" paper plug into the top compartment of the tube.

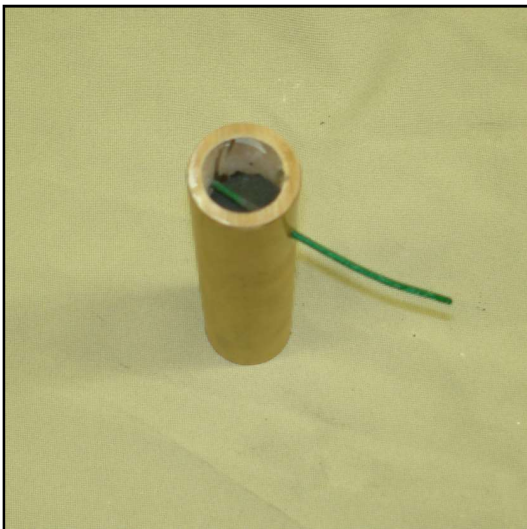

Step 10

Flip the tube upside down and fill the lower compartment with black powder. These devices do require quite a bit more lift charge than a shell that is typically shot from a tube. A good starting point is to use 8-10% of the weight of the device for a lift charge. This may vary depending on the performance of your black powder. Test this with a few devices that contain inert burst charges (clay works well) until you are able to get the lift amounts dialed in.

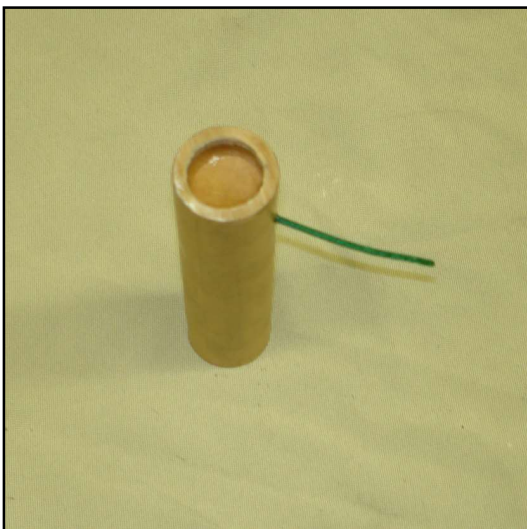

Step 11

Insert a paper plug and secure with a small bit of glue. Your device is now complete.



Step 12

Place the cracker on a level and solid surface. Light the fuse and retire to a safe distance.