

AABS

America's Affordable Building Supply

Product Guide

Metal Panels ● Trims ● Building Materials



IRON DOME

DURABLE, DEPENDABLE, BUILT TO PERFORM

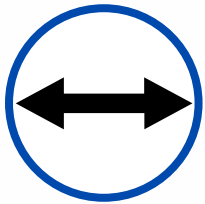

Panel Width
36"

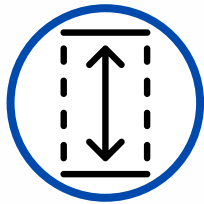

Rib Height
3/4"

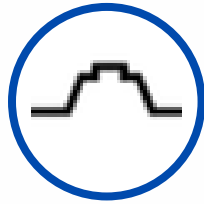

Rib Features
9"



Fastener System
Exposed

PANEL MEASUREMENTS

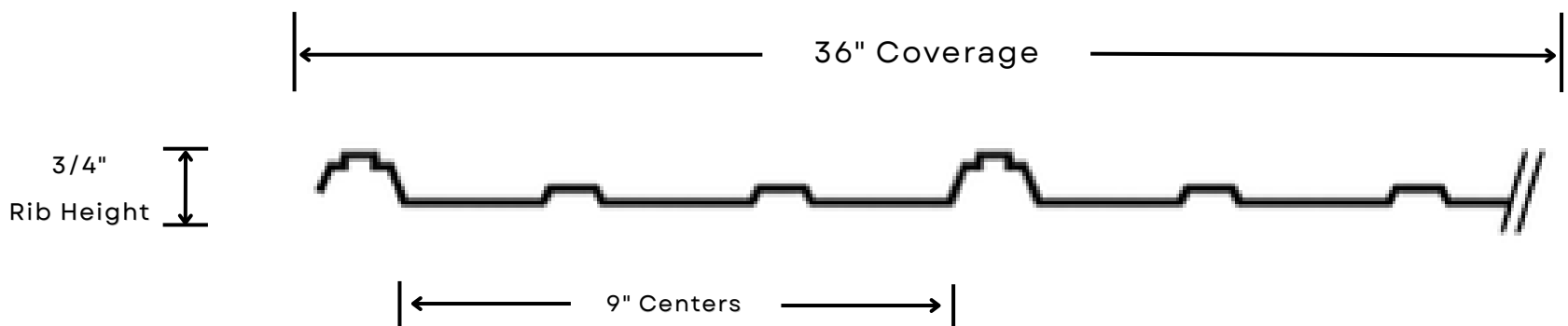

2 ½:12
Pitch and Above



29 or 26
Gauge



36"
Coverage



3/4"
Max Rib Height

Available Colors can be viewed on Page 23 & 24

Iron Dome Trims

The Finishing Touch For Maximum Protection

*Available Colors
can be viewed on
Page 23 & 24

Residential Eave Trim (RET)

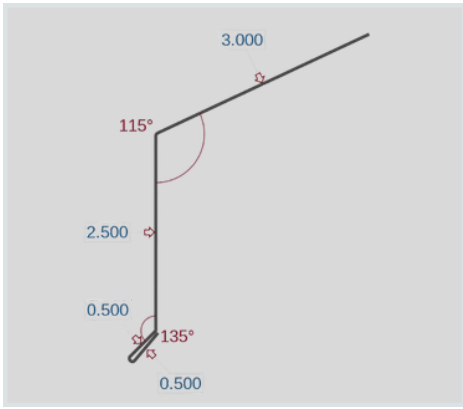

Step-Up Ridge Cap (RCP)

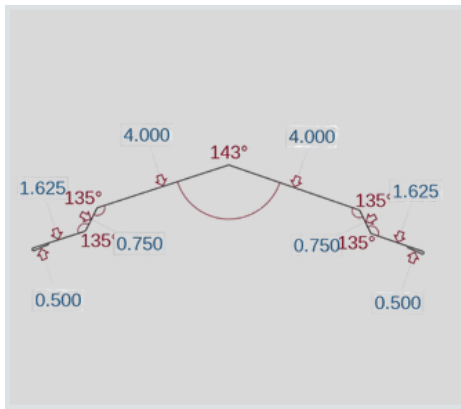

Residential Rake Trim (RRT)

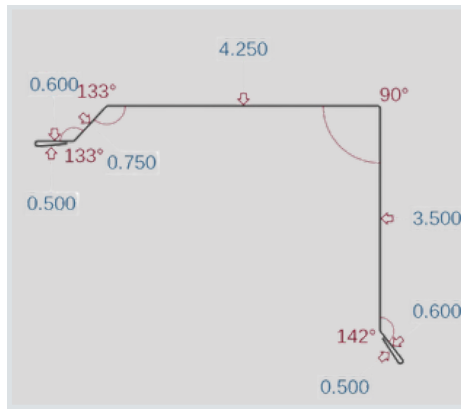

High Side Peak Trim (HPT)

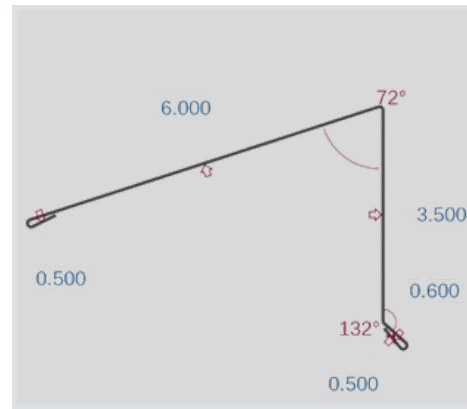

Universal Endwall (EWT)

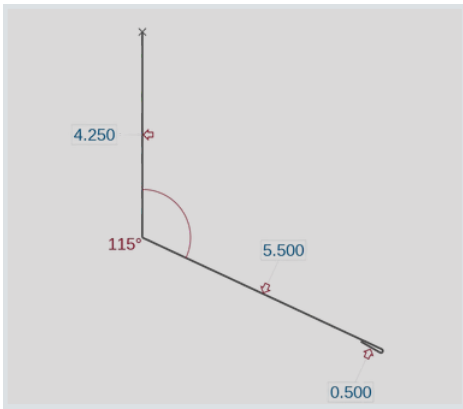

Universal Sidewall (SWT)

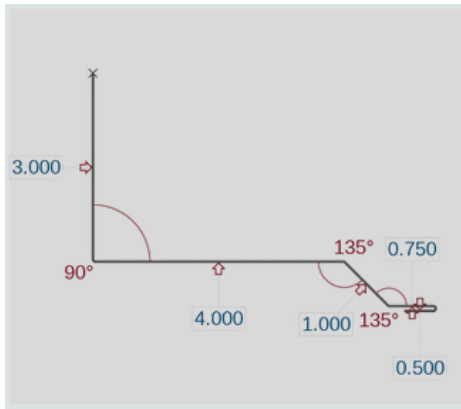

Sloped Transition (ST)

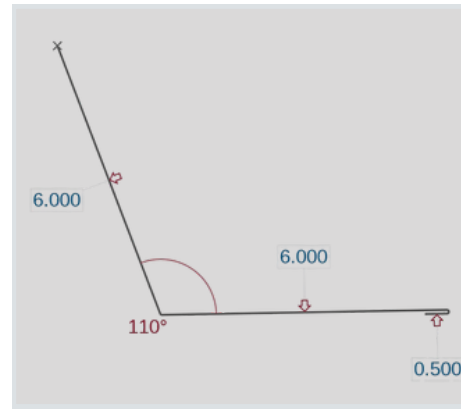

Valley Trim No Hem (VT1)

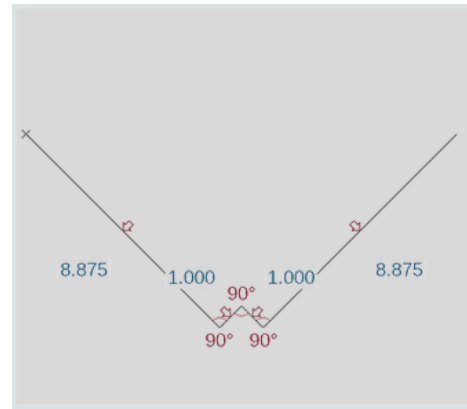

Snow Guard (SG)

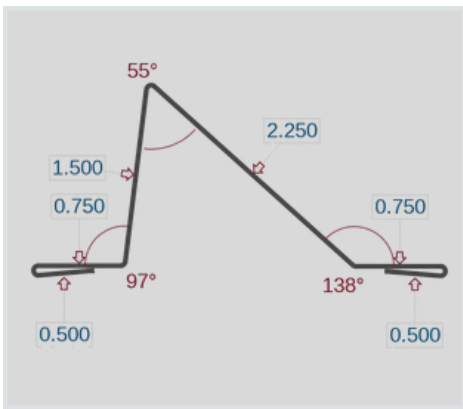

Fascia 5 1/2" (FT55)

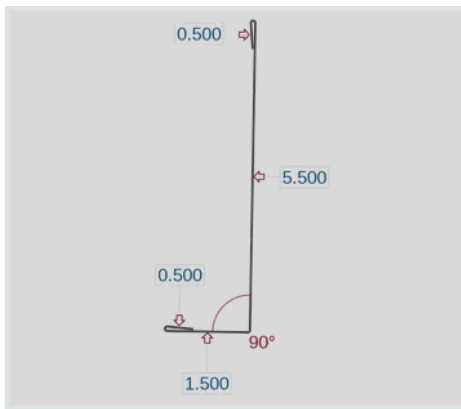

Soffit F&J Channel (SFJ)

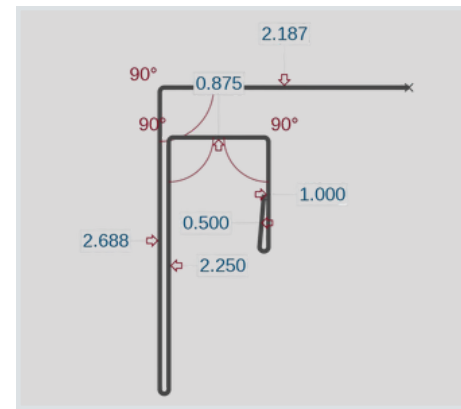

Widow Drip Cap (WDC)

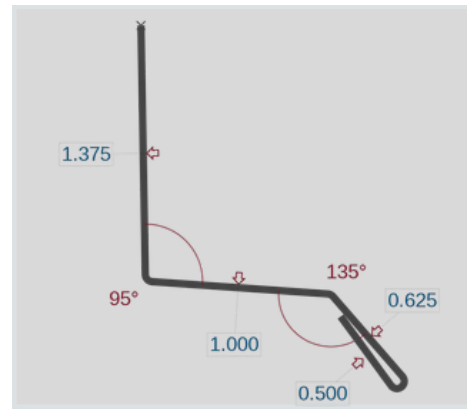

Outside Corner (COR)

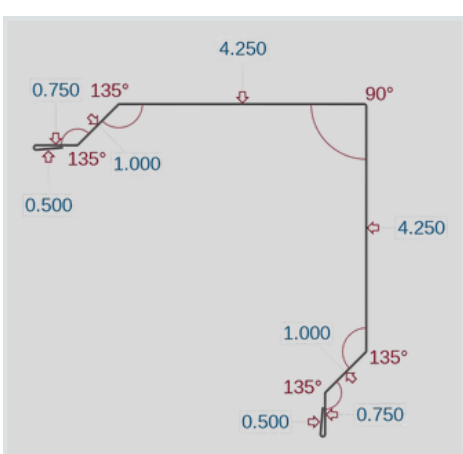

Inside Corner (IC1)

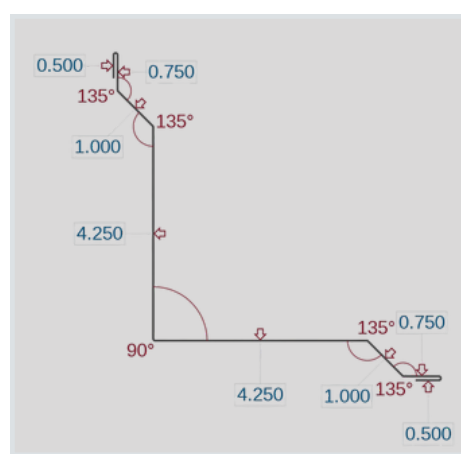

Garage Door J (GDJ)

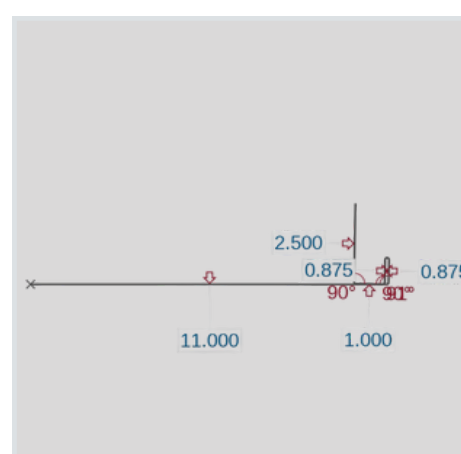

Top J (TJ)

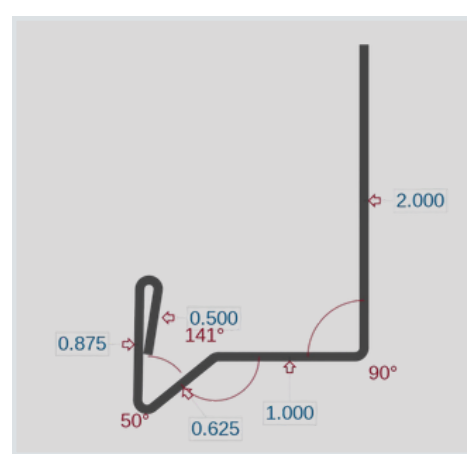

J-Channel (JT)

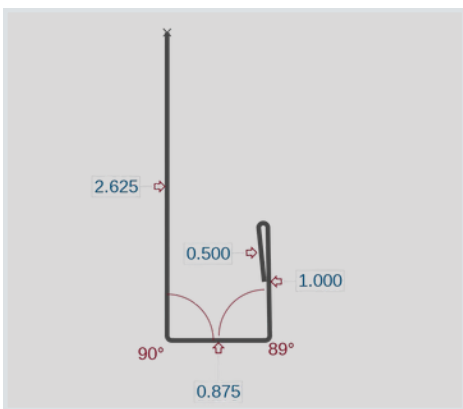

Wainscot (WC)

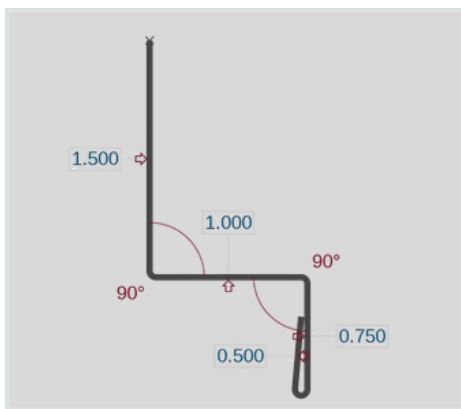

Angle Base (AB)

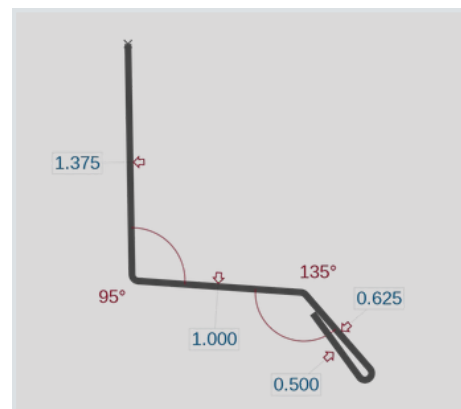

Rat Guard (RG)

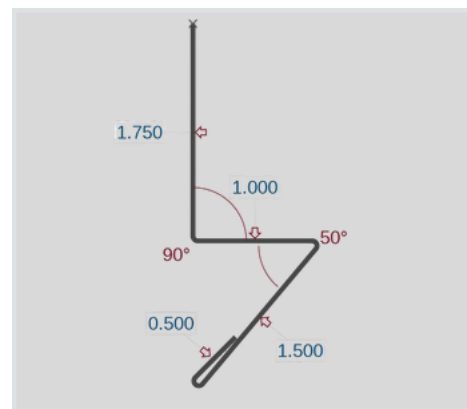



PBR PANEL

DURABLE, DEPENDABLE, BUILT TO PERFORM

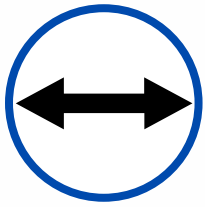

Panel Width
36"

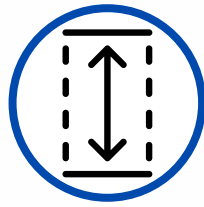

Rib Height
1-1/4"

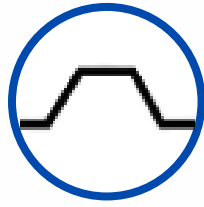

Rib Features
12"



Fastener System
Exposed

PANEL MEASUREMENTS

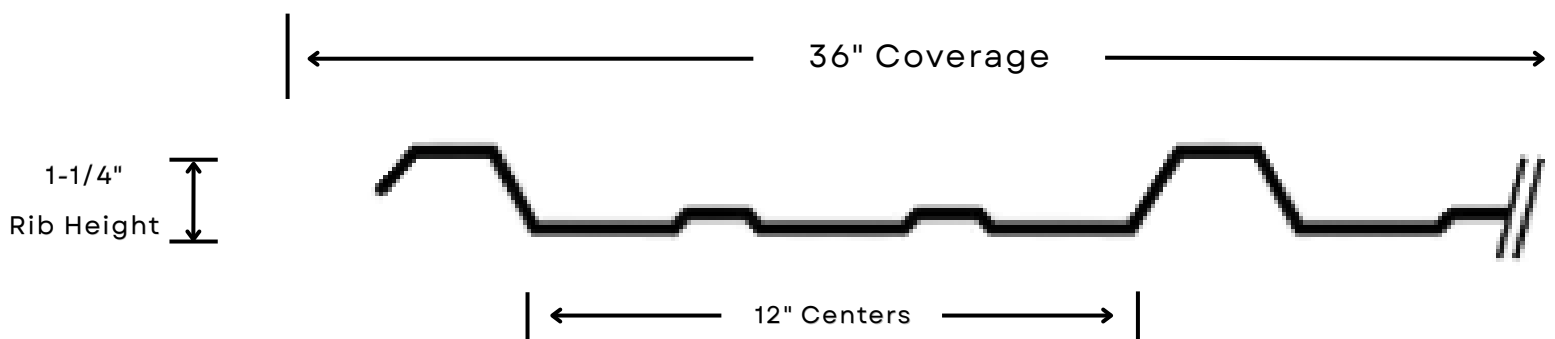

1/2:12
Pitch and Above



29, 26, & 24
Gauge



36"
Coverage



1-1/4"
Max Rib Height

Available Colors can be viewed on Page 23 & 24

PBR Panel Trims

The Finishing Touch For Maximum Protection

*Available Colors can be viewed on Page 23 & 24

Commercial Eave Trim (CET)

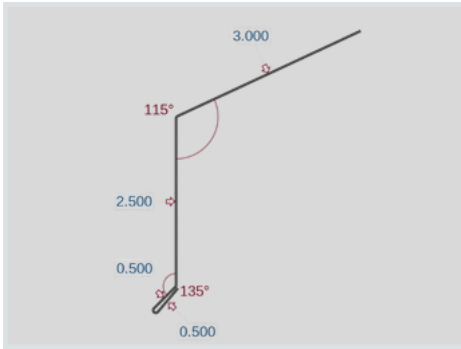

Commercial Step-Up-Ridge Cap (CRC)

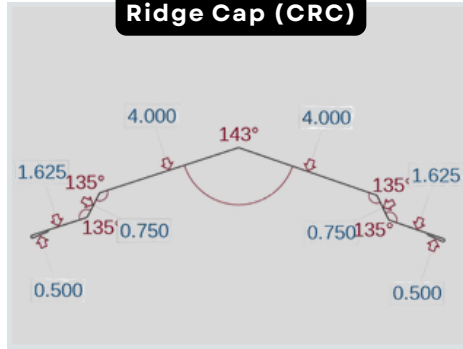

Commercial Rake Trim (CRT)

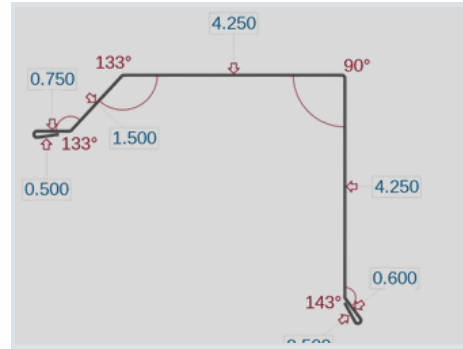

Commercial High Side Peak Trim (CHPT)

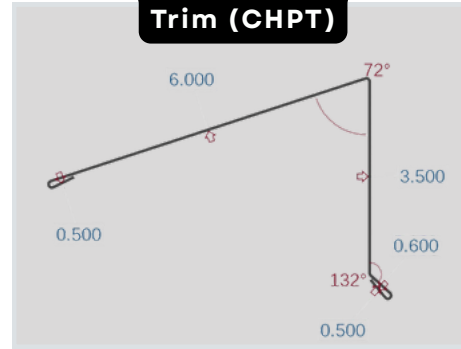

Commercial Endwall (CEW)

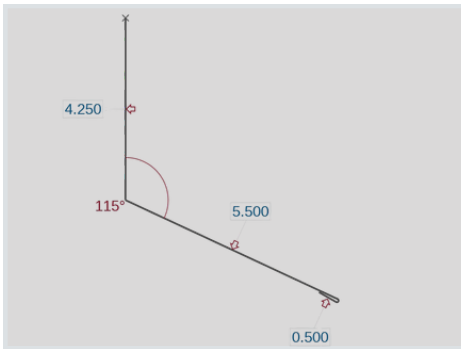

Commercial Sidewall (CSW)

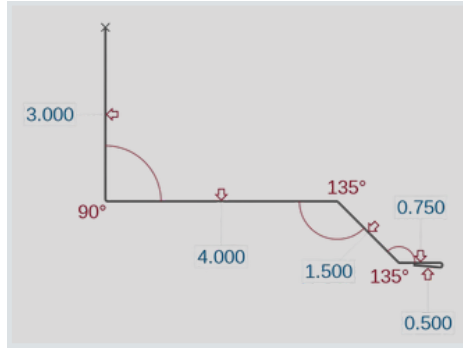

Commercial Slope Transition (CST)

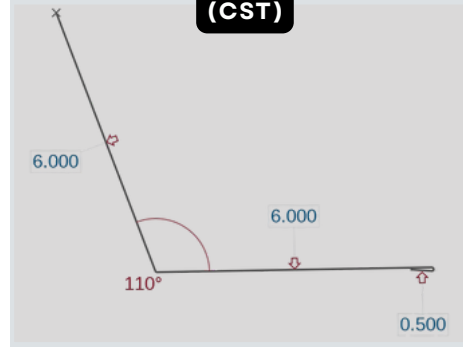

Commercial Valley Trim (CVT1)

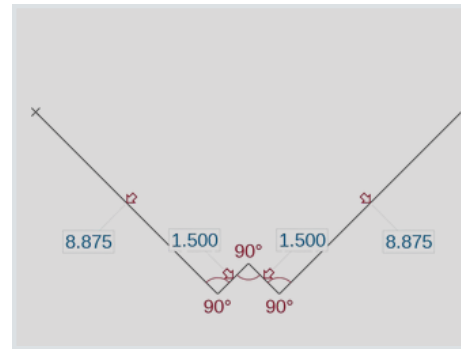

Commercial Snow Guards (CSG)

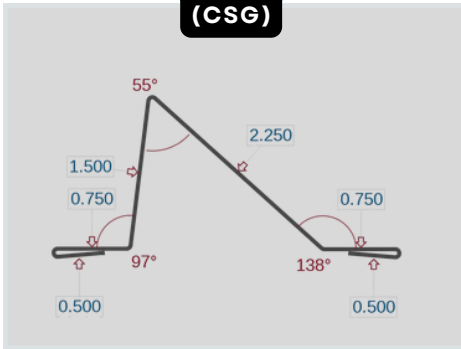

Commercial Fascia (CFT)

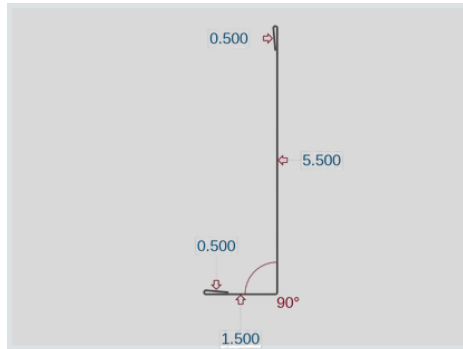

Commercial FJ Channel (CFJ)

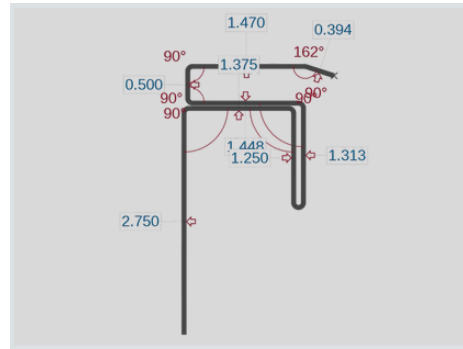

Commercial Drip Cap (CDC)

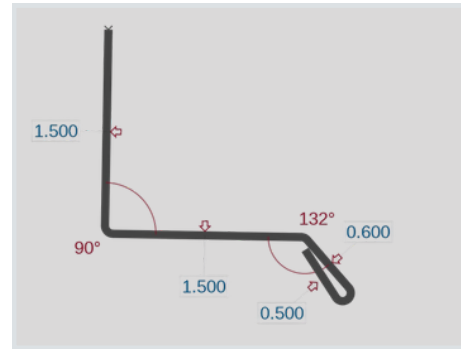

Commercial Outside Corner (COC)

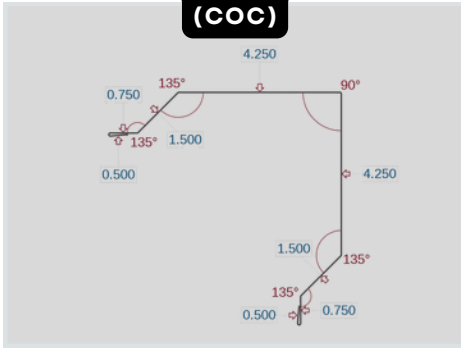

Commercial Inside Corner (CIC1)

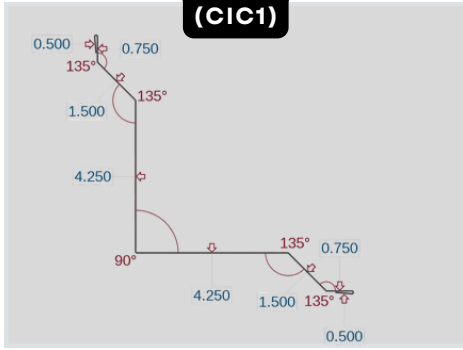

Commercial Garage Door J (CGDJ)

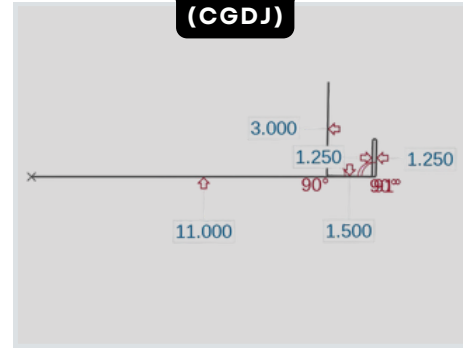

Commercial Top J (CTJ)

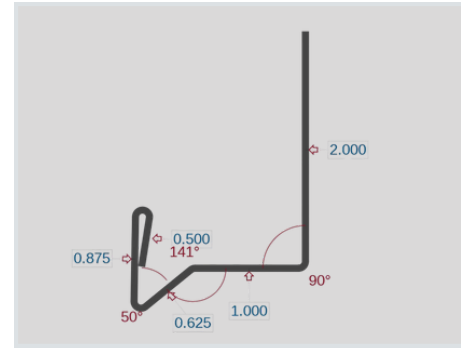

Commercial J-Channel (CJC)

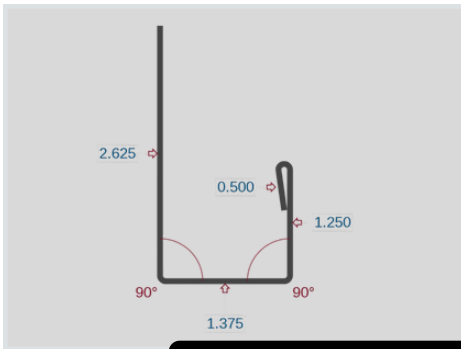

Commercial Wainscot (CWC)

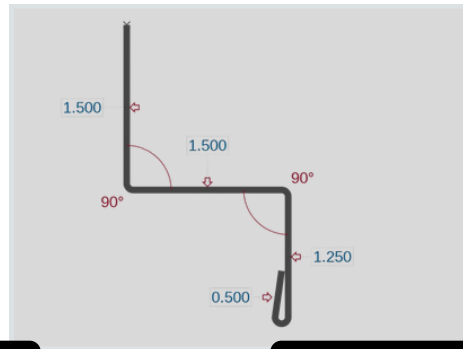

Commercial Angle Base (CAB)

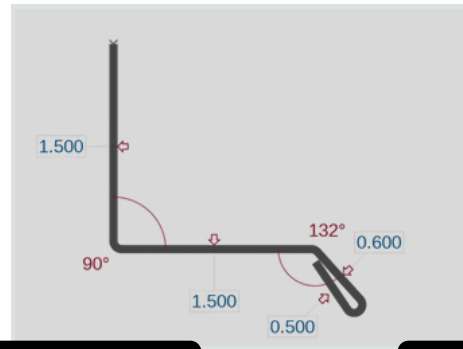

Commercial Rat Guard (CRG)

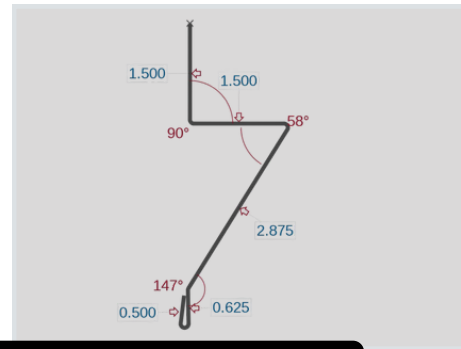

Commercial Gable (CG)

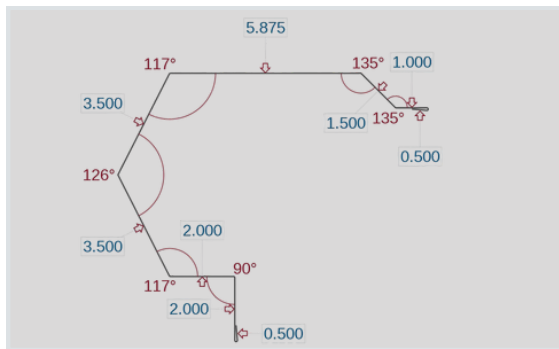

Sculptured Gutters (SHOG...)

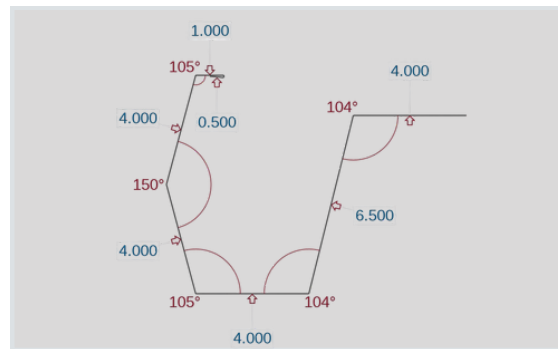

Commercial Downspout (CDS)

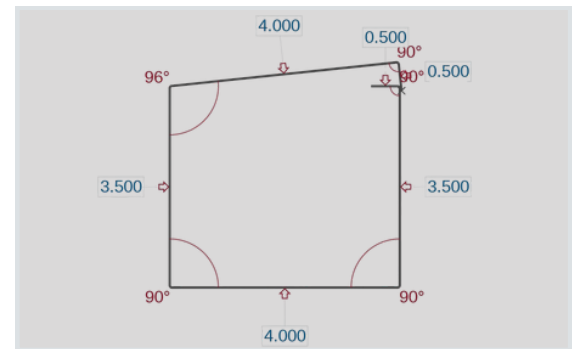



M LOC

DURABLE, DEPENDABLE, BUILT TO PERFORM

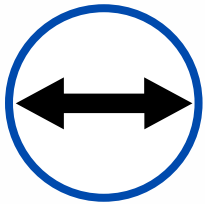

Panel Width
36"

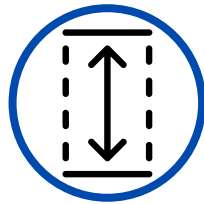

Rib Height
13/16"

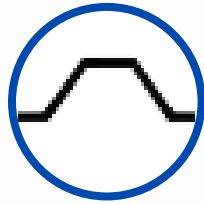

Rib Features
6"



Fastener System
Exposed

PANEL MEASUREMENTS

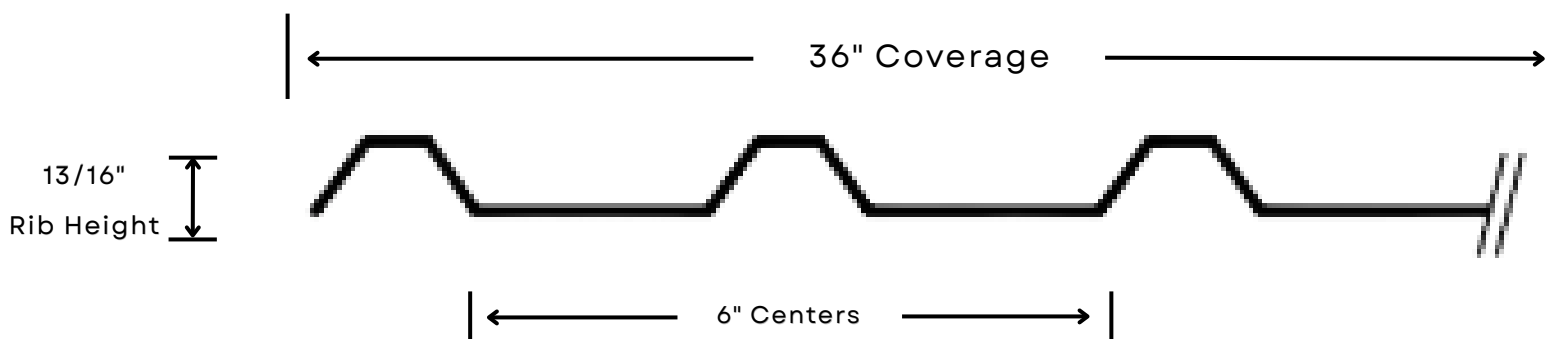

1:12
Pitch and Above



26 & 24
Gauge



36"
Coverage



13/16"
Max Rib Height

Available Colors can be viewed on Page 23 & 24



IRON LOC

DURABLE, DEPENDABLE, BUILT TO PERFORM

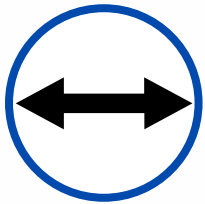

Panel Width
36"

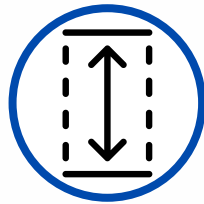

Rib Height
5/8"

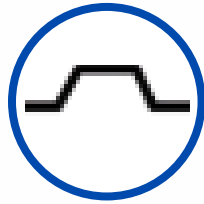

Rib Features
9"

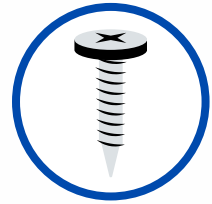

Fastener System
Exposed

PANEL MEASUREMENTS

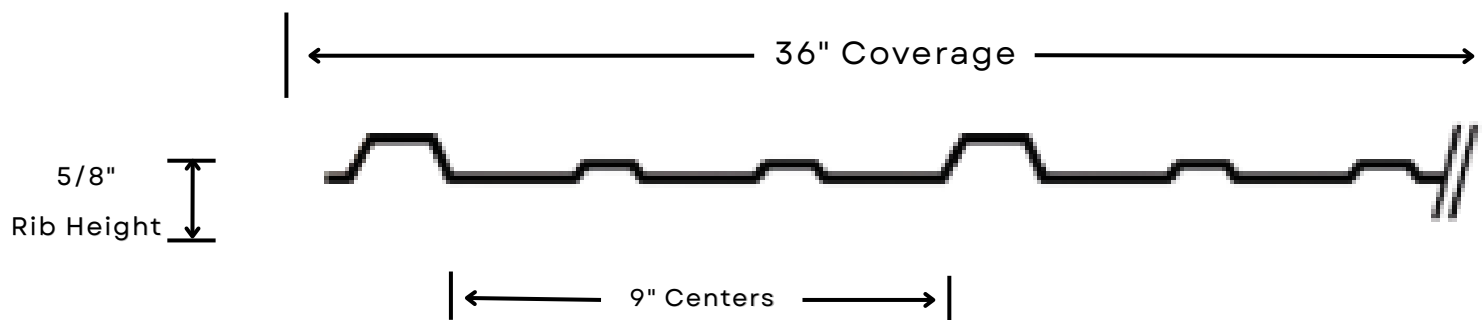

3:12

Pitch and Above



26 & 29

Gauge



36"

Coverage



5/8"

Max Rib Height

Available Colors can be viewed on Page 23 & 24

Iron Loc Trims

The Finishing Touch For Maximum Protection

*Available Colors
can be viewed on
Page 23 & 24

Residential Eave Trim (RET)

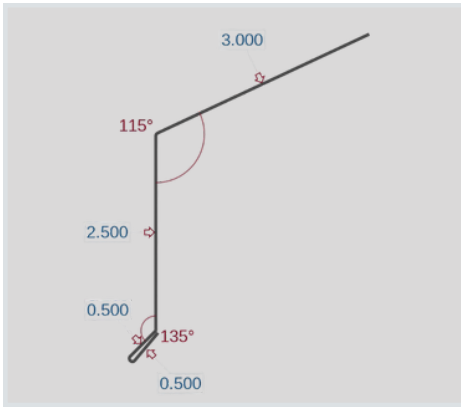

Step-Up Ridge Cap (RCP)

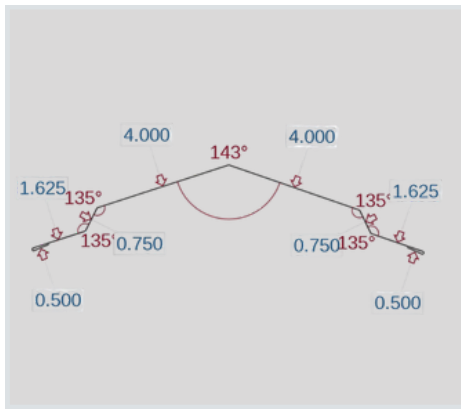

Residential Rake Trim (RRT)

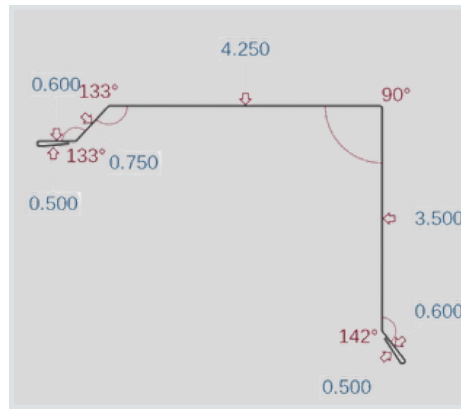

High Side Peak Trim (HPT)

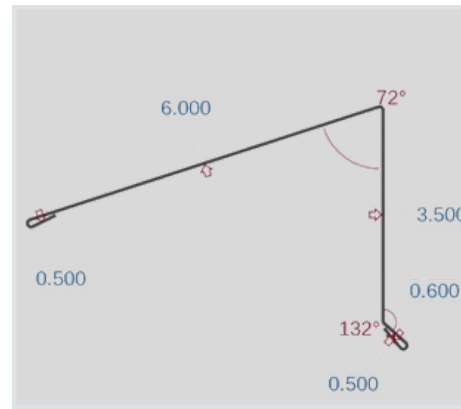

Universal Endwall (EWT)

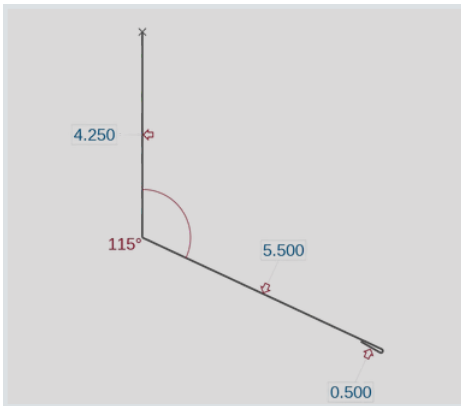

Universal Sidewall (SWT)

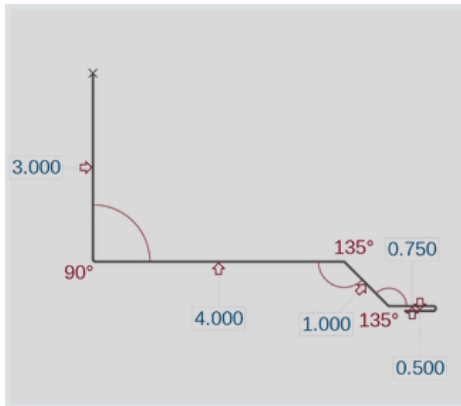

Sloped Transition (ST)

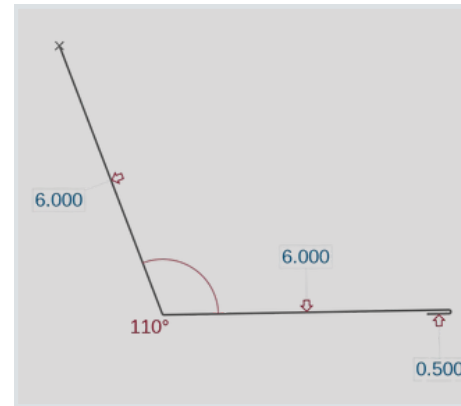

Valley Trim No Hem (VT1)

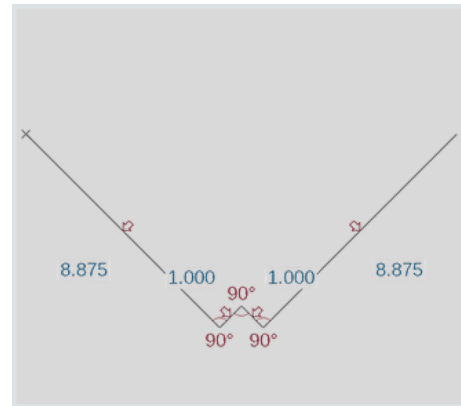

Snow Guard (SG)

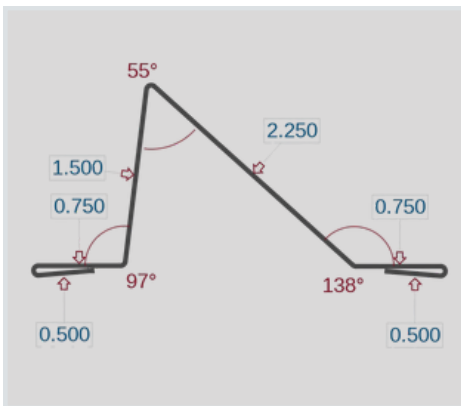

Fascia 5 1/2" (FT55)

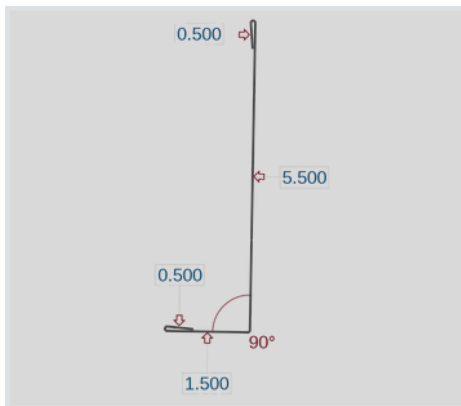

Soffit F&J Channel (SFJ)

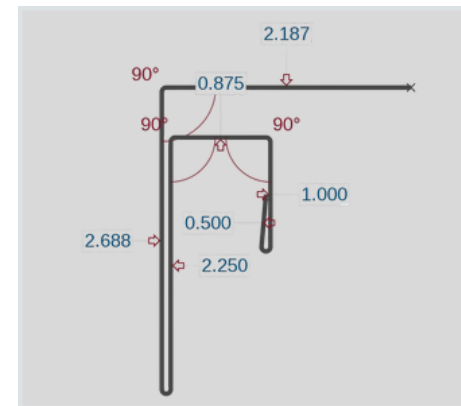

Widnow Drip Cap (WDC)

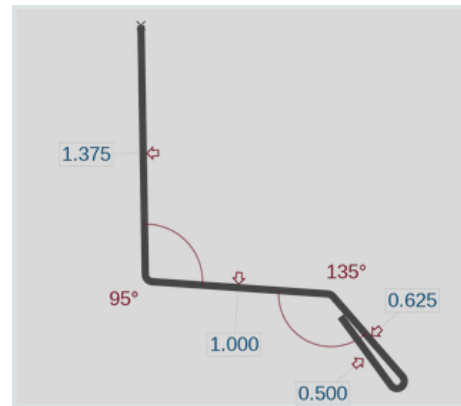

Outside Corner (COR)

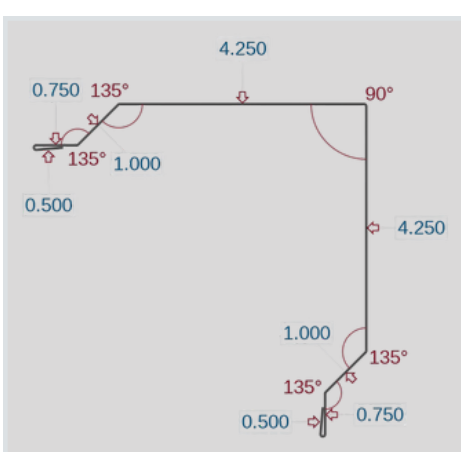

Inside Corner (IC1)

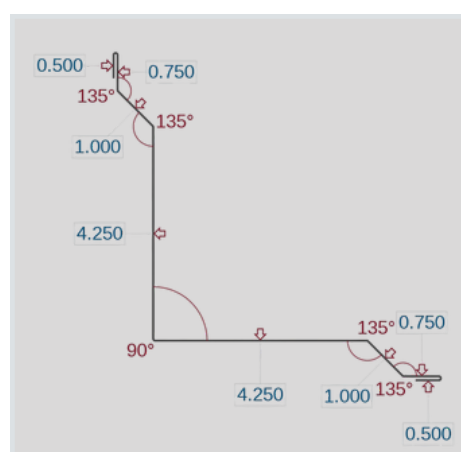

Garage Door J (GDJ)

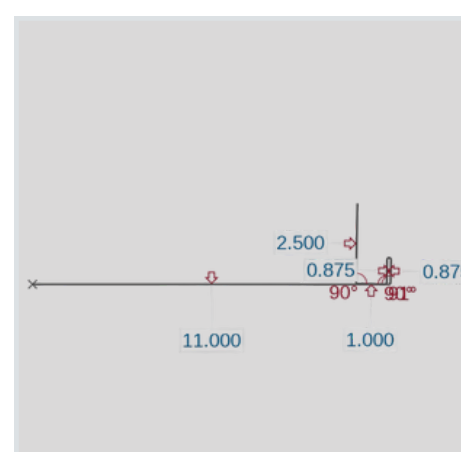

Top J (TJ)

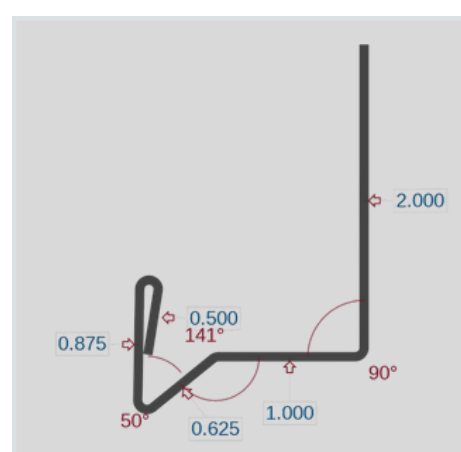

J-Channel (JT)

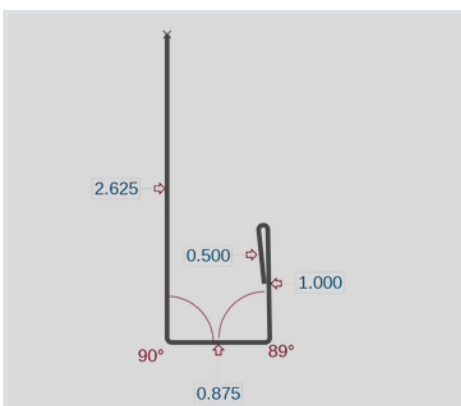

Wainscot (WC)

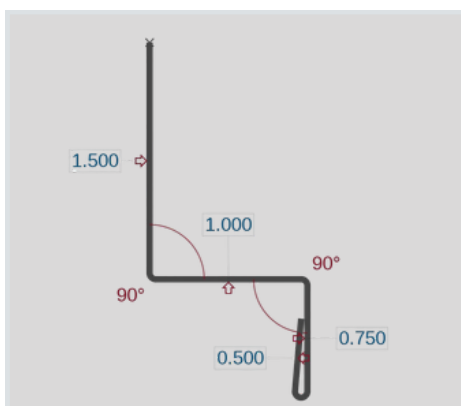

Angle Base (AB)

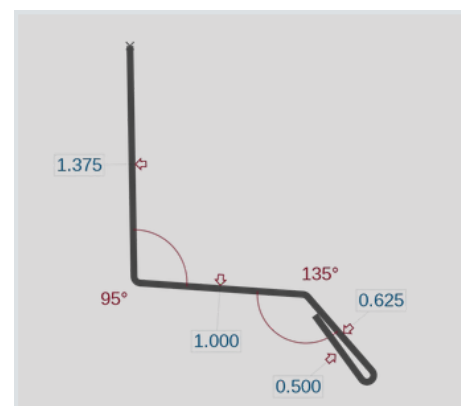

Rat Guard (RG)

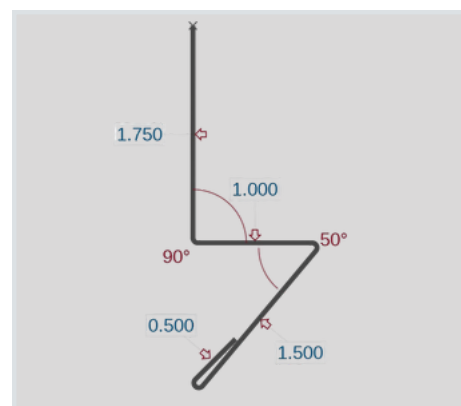

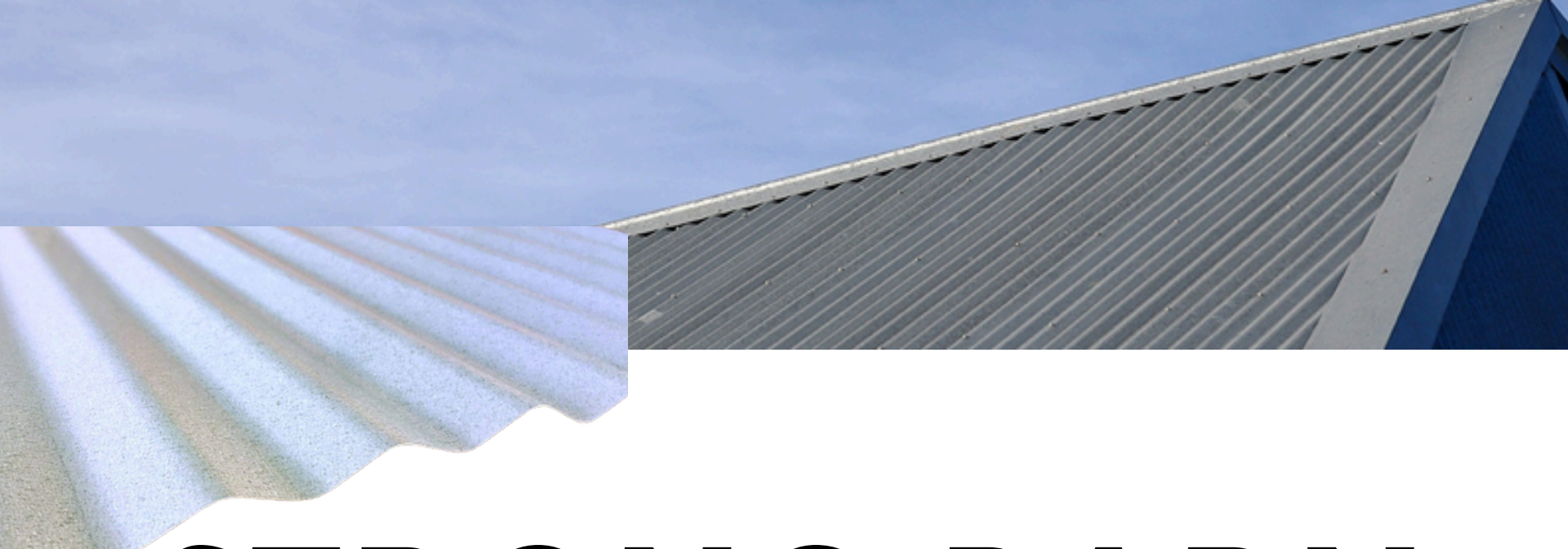

STRONG BARN

DURABLE, DEPENDABLE, BUILT TO PERFORM

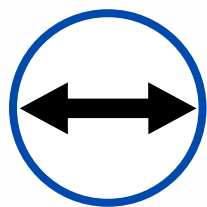

Panel Width
24"

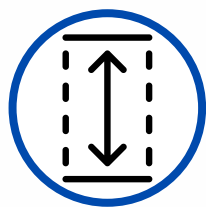

Rib Height
1/2"

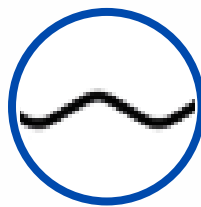

Rib Features
2.67"



Fastener System
Exposed

PANEL MEASUREMENTS

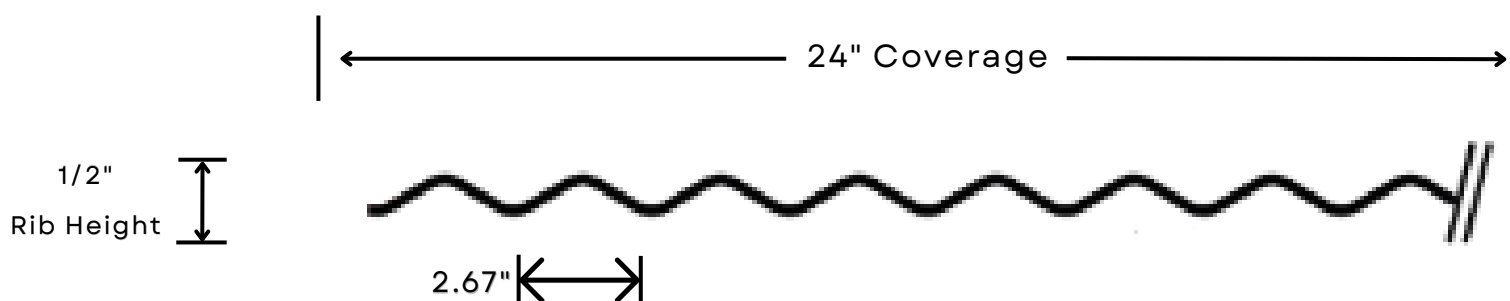

3:12
Pitch and Above



29
Gauge



24"
Coverage



1/2"
Max Rib Height

Available Colors can be viewed on Page 23 & 24

Strong Barn Trims

The Finishing Touch For Maximum Protection

*Available Colors
can be viewed on
Page 23 & 24

SB Eave Trim (SBET)

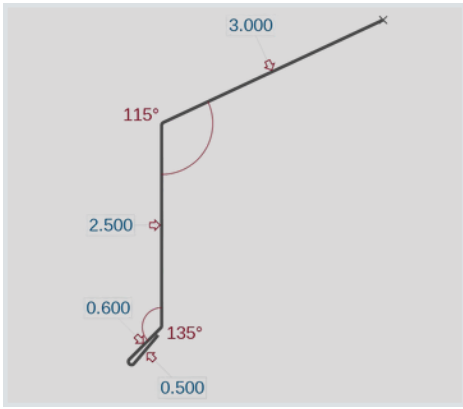

SB Step Up Ridge Cap (SBRC)

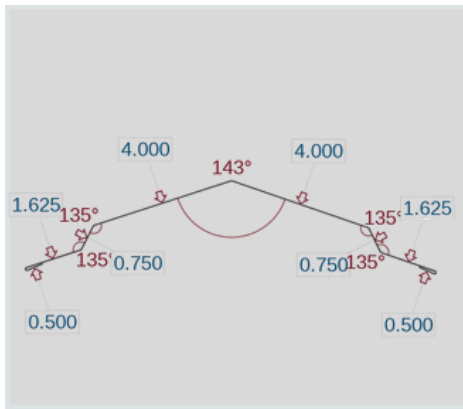

SB Rake Trim (SBRT)

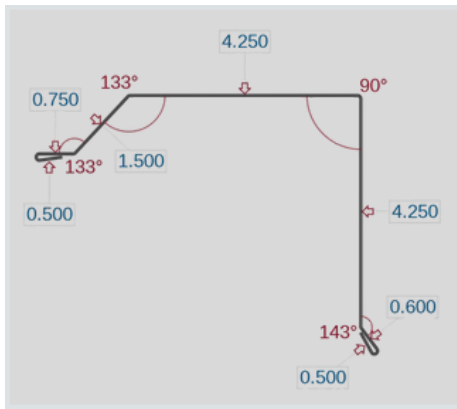

SB High Side Peak Trim (SBHPT)

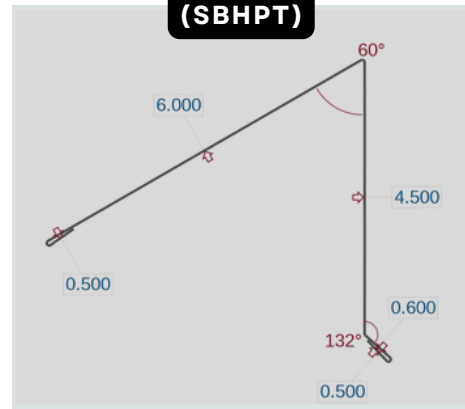

SB Endwall (SBEW)

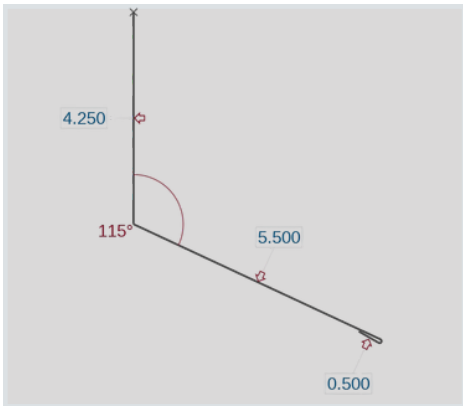

SB Sidewall (SBSW)

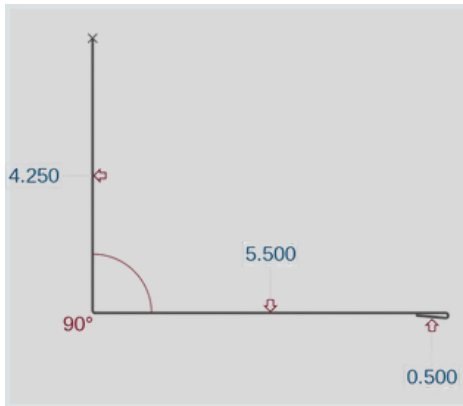

SB Sloped Transition (SBST)

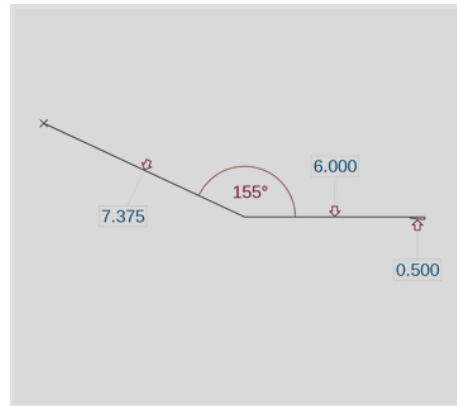

SB Valley Trim NO HEM (SBVT)

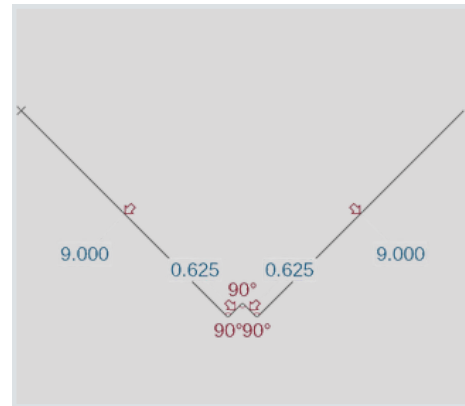

SB Snow Guard (SBSG)

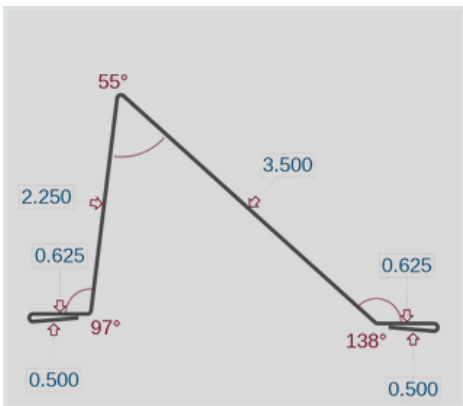

SB Fascia 5 1/2" (SBFT55)

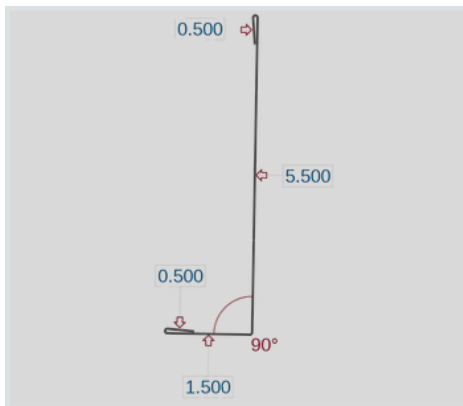

SB FJ Channel (SBFJ)

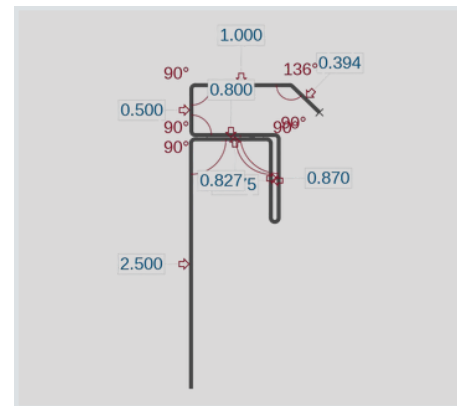

SB Window Drip Cap (SBWDC)

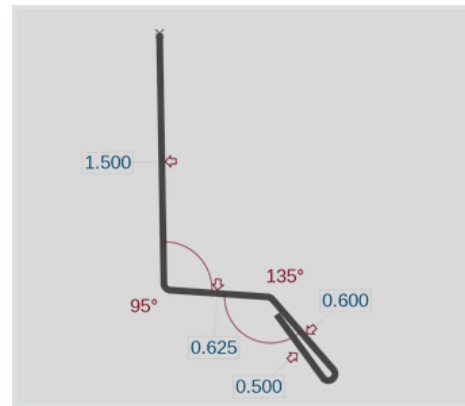

SB Outside Corner (SBOC)

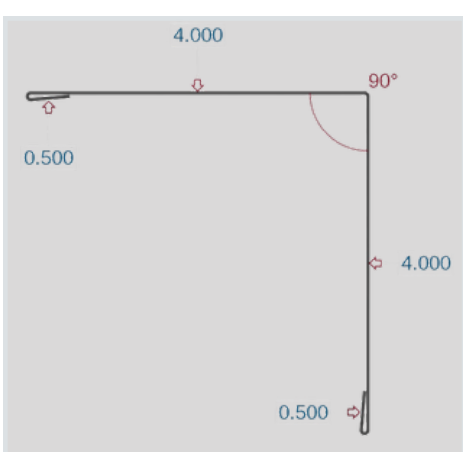

SB Inside Corner (SBIC)

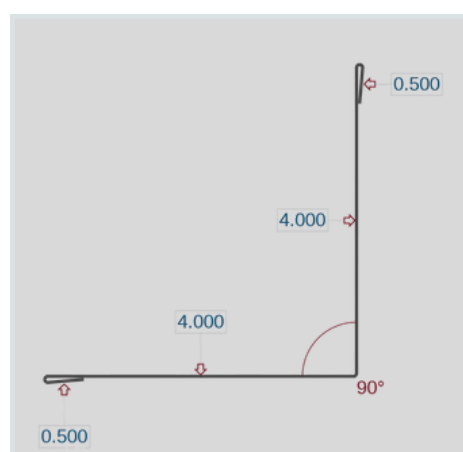

SB Garage Door J (SBGDJ)

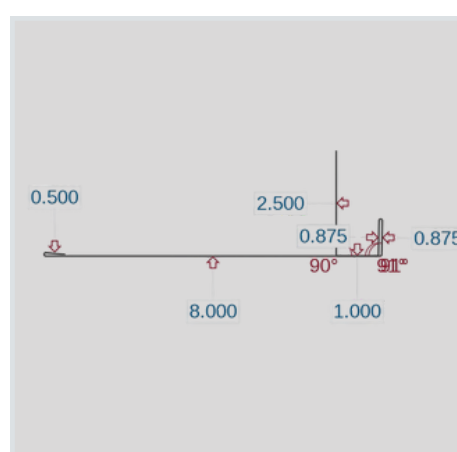

SB Top J (SBCTJ)

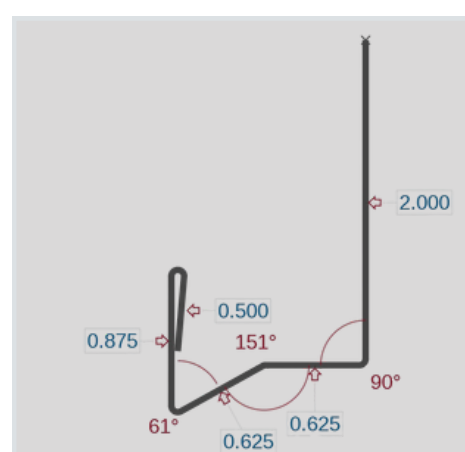

SB J - Channel (SBJT)

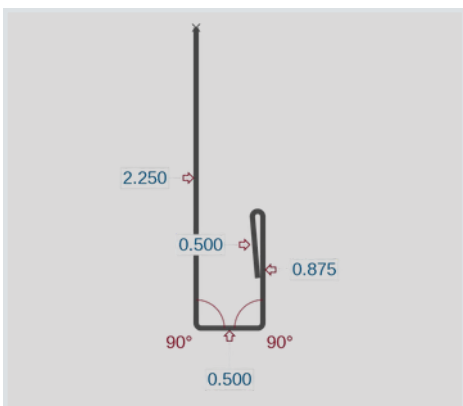

SB Wainscot (SBWC)

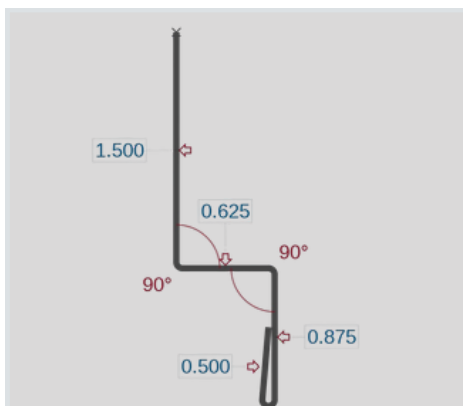



TRAPEZOIDAL LOC

DURABLE, DEPENDABLE, BUILT TO PERFORM

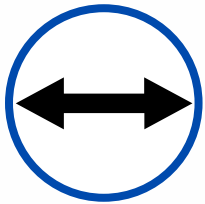

Panel Width

18" or 24"

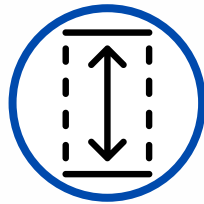

Rib Height

3"

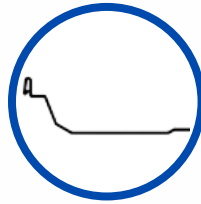

Rib Features

18" or 24"

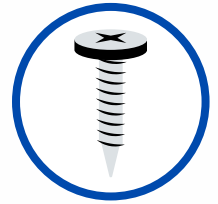

Fastener System

Hidden

PANEL MEASUREMENTS

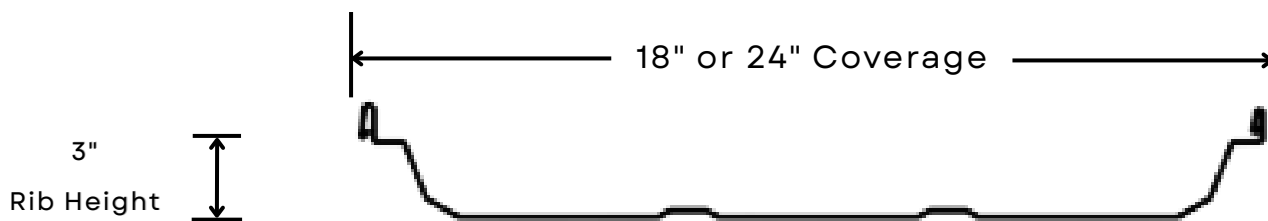

1/4:12

Pitch and Above



24

Gauge



18" or 24"

Coverage



3"

Max Rib Height

Available Colors can be viewed on Page 23 & 24



2.0 MECHANICAL SEAM

DURABLE, DEPENDABLE, BUILT TO PERFORM

Panel Width 16"	Rib Height 2"	Rib Features 16"	Fastener System Hidden

PANEL MEASUREMENTS

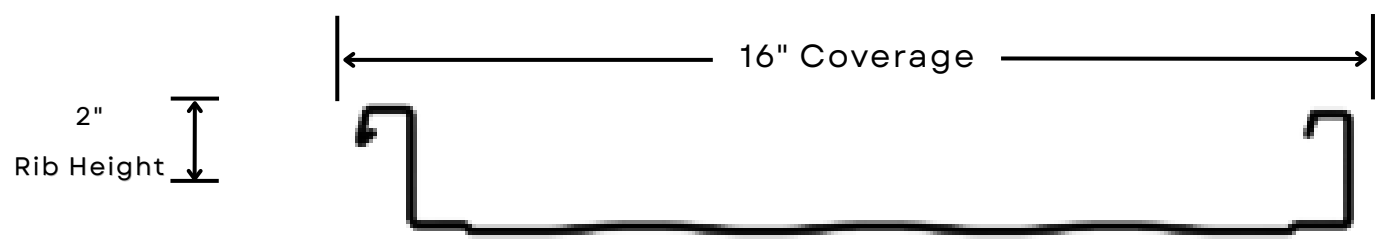

1/4:12
Pitch and Above

24
Gauge

16"
Coverage

2"
Max Rib Height

Available Colors can be viewed on Page 23 & 24

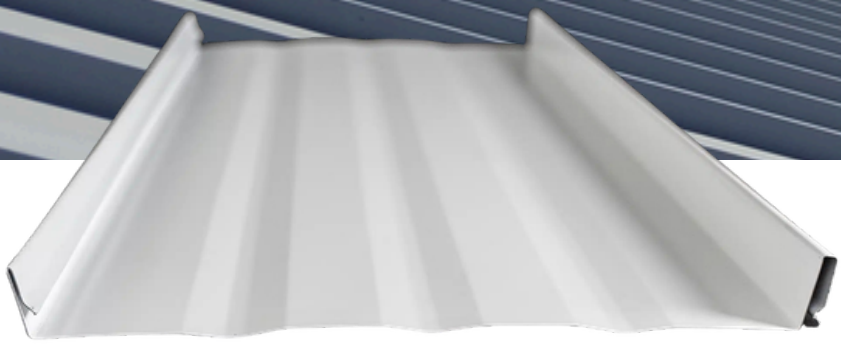

1.75 SNAP

DURABLE, DEPENDABLE, BUILT TO PERFORM

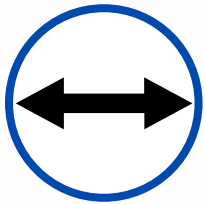

Panel Width

16" or 18"

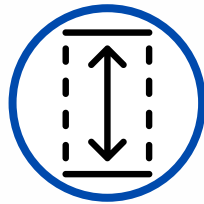

Rib Height

1-3/4"

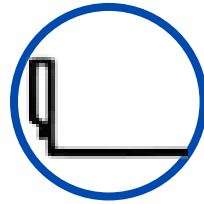

Rib Features

16" or 18"



Fastener System

Hidden

PANEL MEASUREMENTS

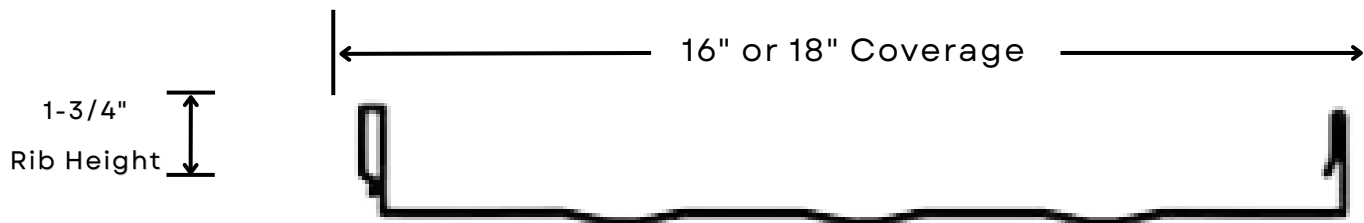

1:12

Pitch and Above



24

Gauge



16" or 18"

Coverage



1-3/4"

Max Rib Height

Available Colors can be viewed on Page 23 & 24

1.75 Snap Trims

The Finishing Touch For Maximum Protection

*Available Colors
can be viewed on
Page 23 & 24

1.75 D style Eave (DE1)

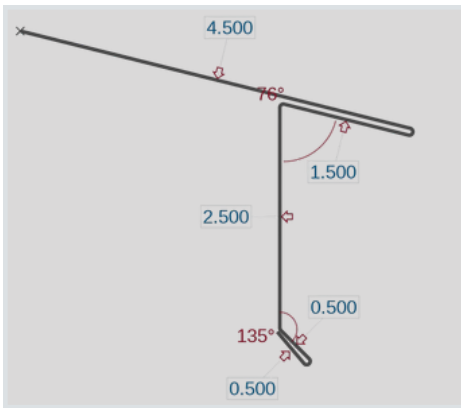

1.75 End Wall (EW1)

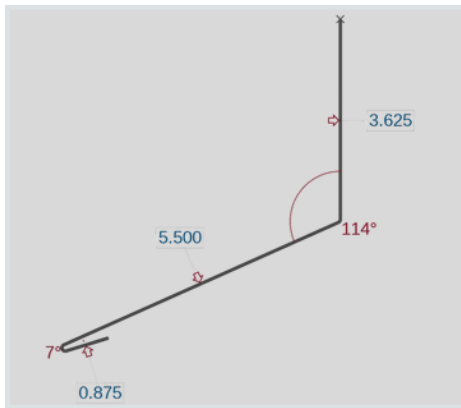

1.75 Rake Trim (RT1)

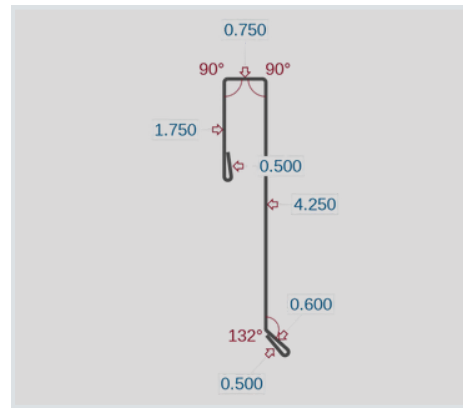

1.75 Valley Trim (VT1)

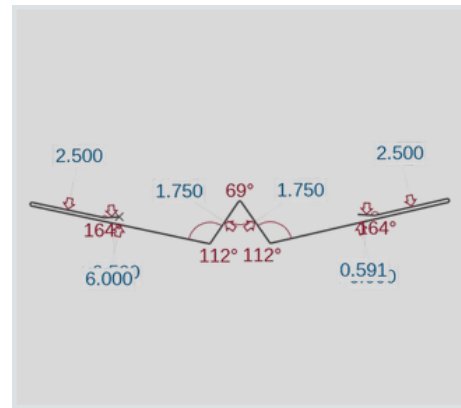

1.75 8"x8" Flat Ridge Cap (FRC1)

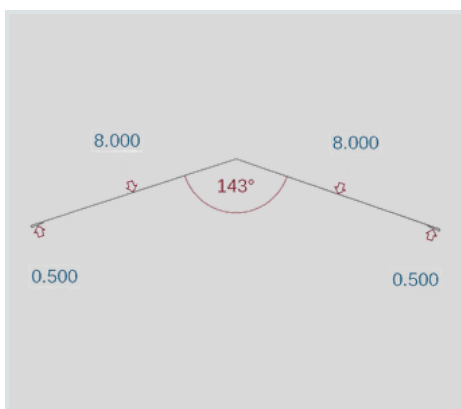

1.75 Z Clouser (ZC1)

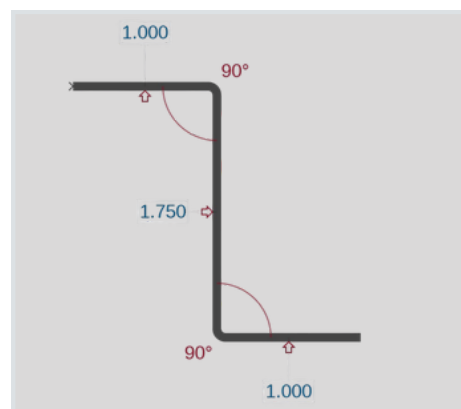

1.75 Sidewall (SW1)

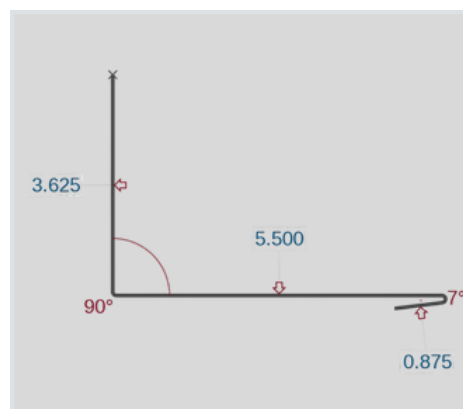

1.75 High Side Peak Trim (HPT1)

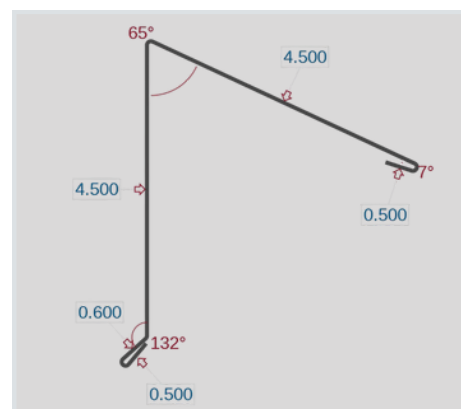

1.75 Transition (TT1)

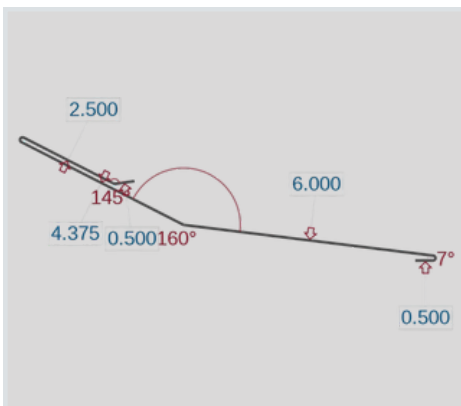

1.75 FJ Channel (FJC1)

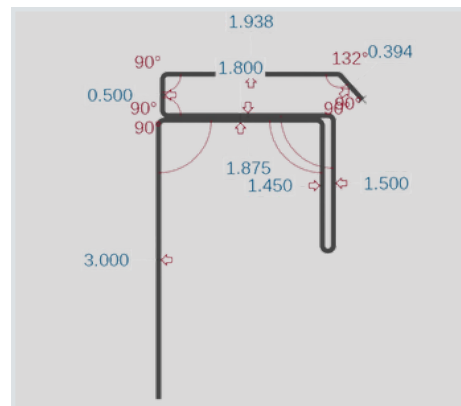

1.75 Drip Cap (DC1)

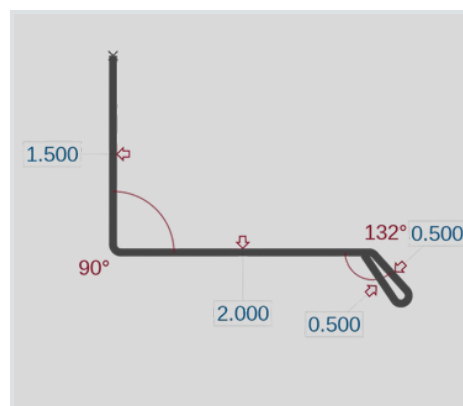

1.75 Outside Corner (OC1)

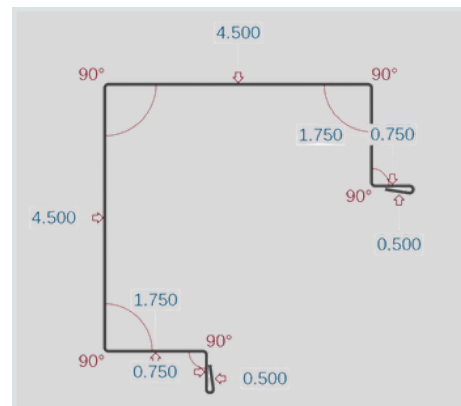

1.75 Inside Corner (IC1)

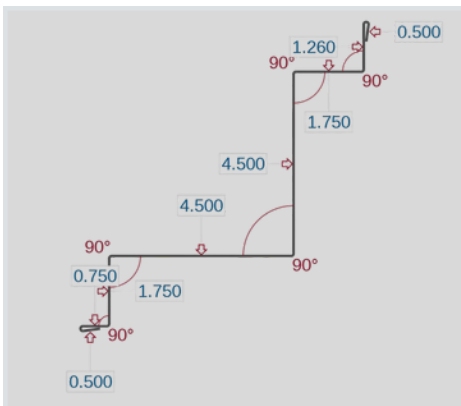

1.75 Garage Door J (GDJ1)

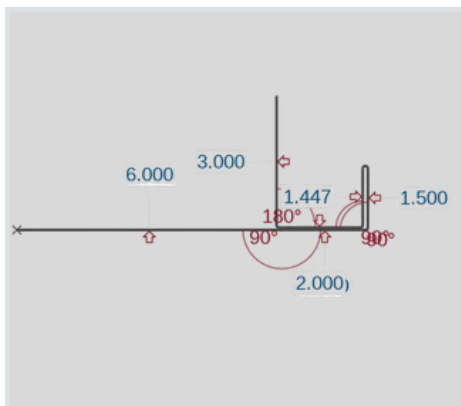

1.75 Wainscot (WC1)

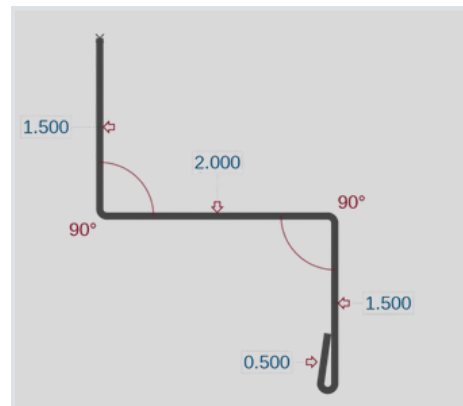

1.75 Angle Base (AB1)

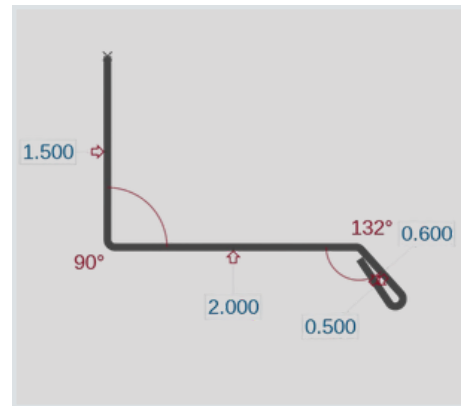

1.75 Rat Guard (RG1)

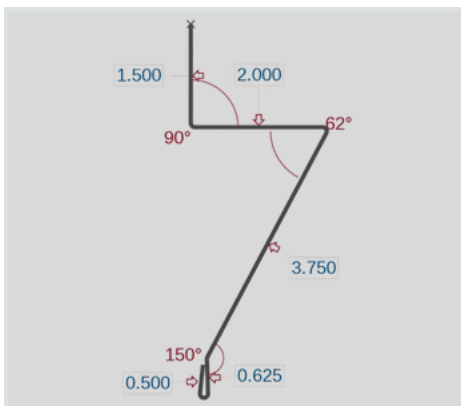

Fascia 5 1/2" (FT55)

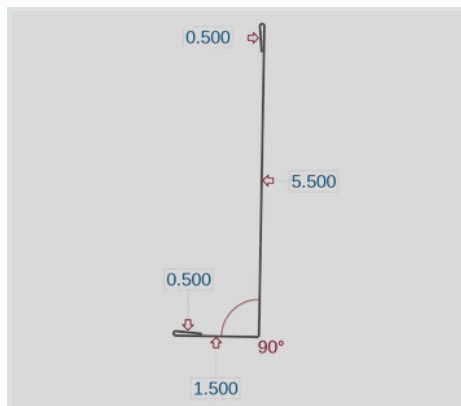

1.75 Fascia Trim 7 1/4 (FT71)

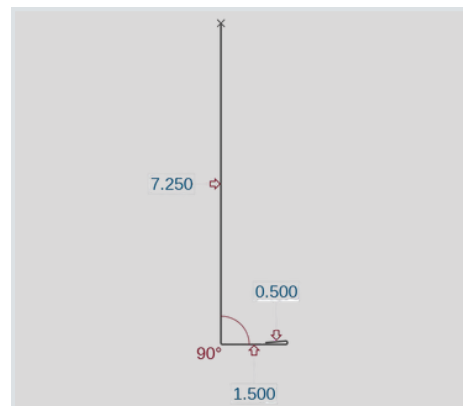



BOARD & BATTEN

DURABLE, DEPENDABLE, BUILT TO PERFORM

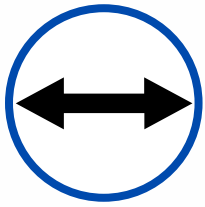

Panel Width

10" or 12"

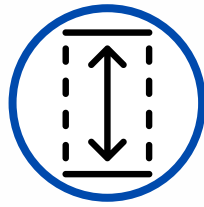

Rib Height

3/4"

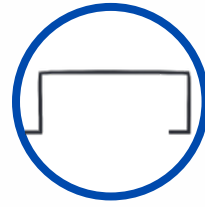

Batten Width

2"



Fastener System

Hidden

PANEL MEASUREMENTS

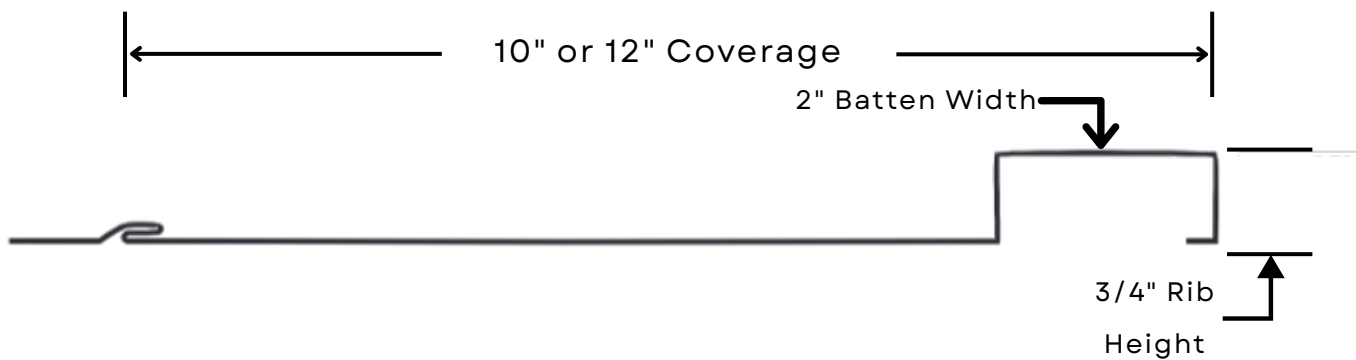

6"

Min Length



26 & 24

Gauge



10" or 12"

Coverage



3/4"

Max Rib Height

Board & Batten Trims & Colors

The Finishing Touch For Maximum Protection

BB Outside Corner (BBOC)

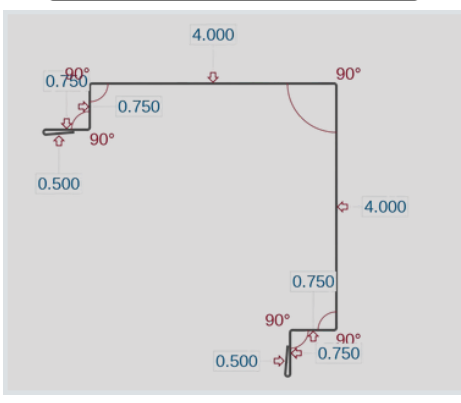

BB Inside Corner (BBIC)

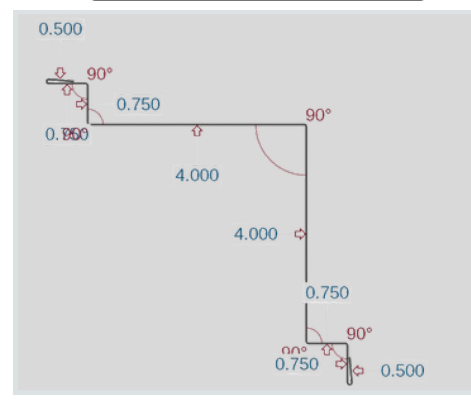

BB Top J (BBTJ)

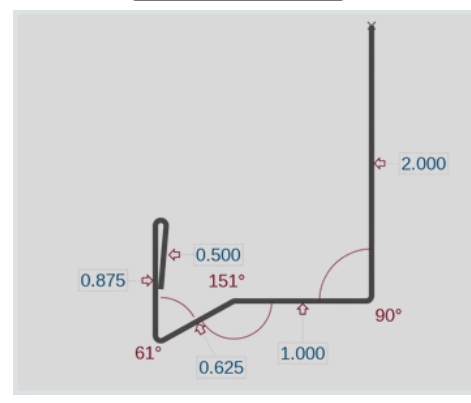

BB J Channel (BBJC)

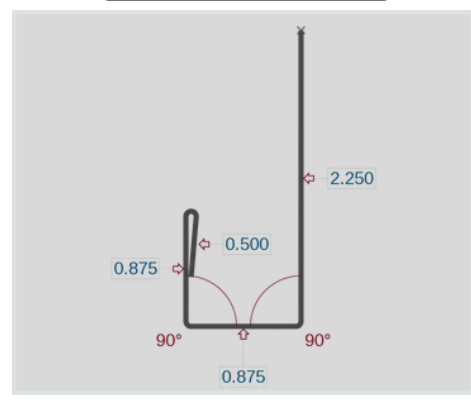

BB Garage Door J (BBGDJ)

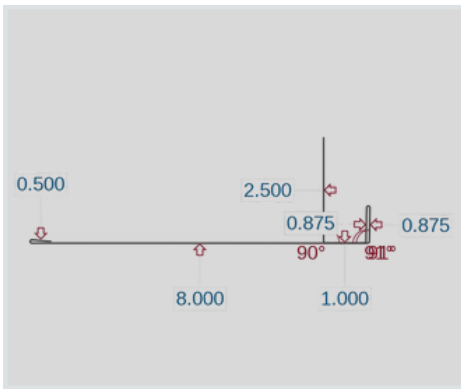

BB Window Drip Cap (BBWDC)

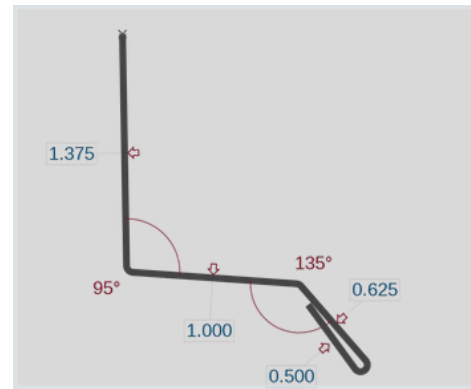

BB Broom Base (BBBB)

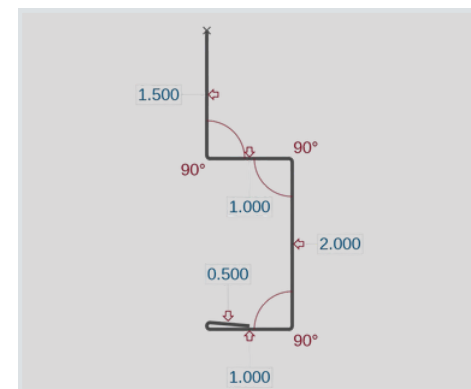

BB Angle Base (BBAB)

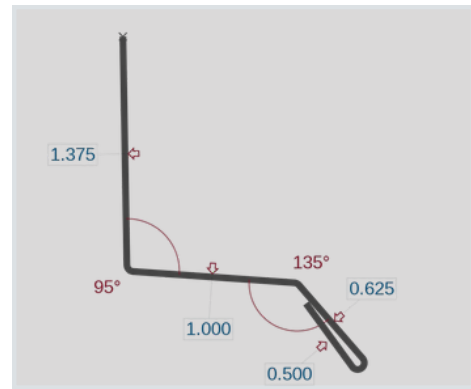

BB Fascia 5 1/2" (BBFT55)

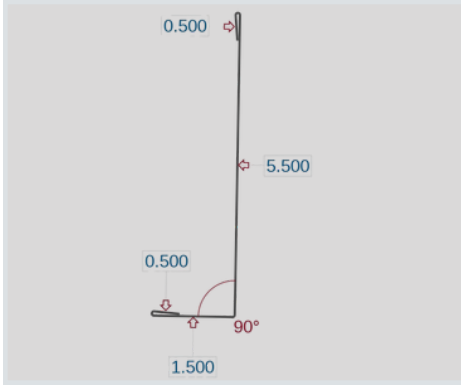

BB FJ Channel (BBFJ)

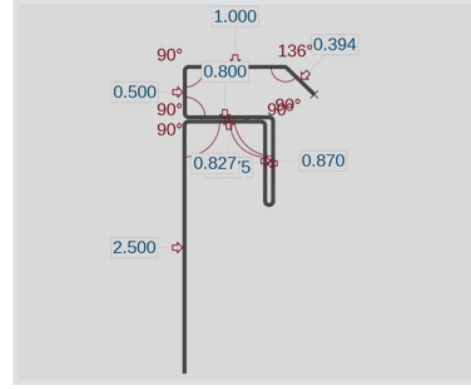

BB Wainscot (BBWC)

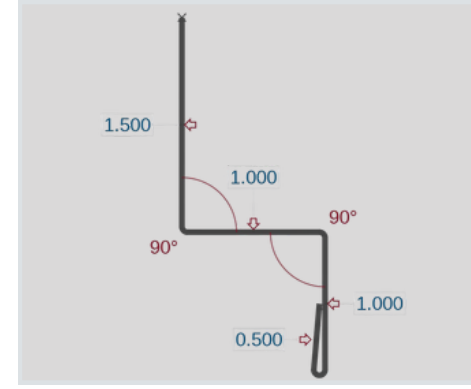

<p>Polar White (26G)</p>	<p>Black (26G)</p>	<p>Koko Brown (26G)</p>	<p>Ash Gray (26G)</p>	<p>Saddle Tan (26G)</p>
<p>Burnished Slate (26G)</p>	<p>Rural Red (26G)</p>	<p>Fern Green (26G)</p>	<p>Charcoal Gray (26G)</p>	<p>Matte Black (26G)</p>
<p>Black Crinkle (26G)</p>	<p>Koko Brown Crinkle (26G)</p>	<p>Charcoal Gray Crinkle (26G)</p>	<p>Burnished Slate Crinkle (26G)</p>	<p>Rough Cedar Gray (26G)</p>
<p>Snow Whtie (24G)</p>	<p>Sandstone (24G)</p>	<p>Mansard Brown (24G)</p>	<p>Slate Gray (24G)</p>	<p>Dark Bronze (24G)</p>
<p>Antique Barn-wood (26G)</p>	<p>Matte Black (24G)</p>			

SPEEDLAP

DURABLE, DEPENDABLE, BUILT TO PERFORM

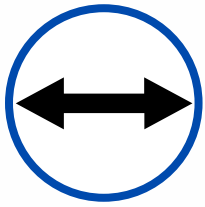

Coverage
16"

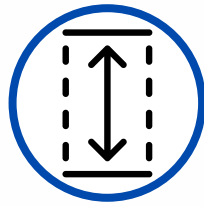

Rib Height
3/8"

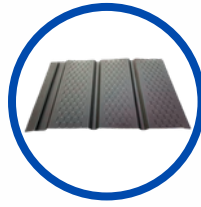

Flats Between Ribs
1-1/4"



Smooth,
Textured & Wood
Grain Coatings

Steel Soffit

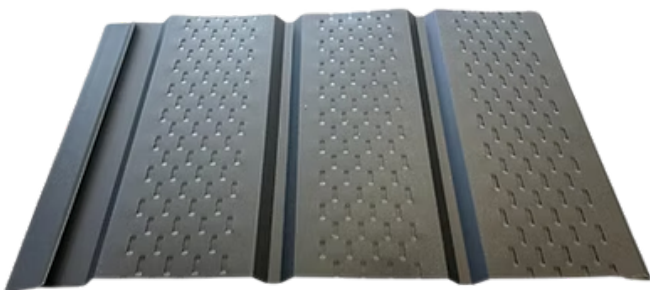

Vented

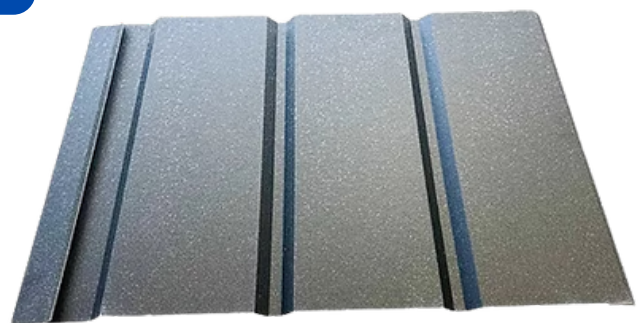

Solid



29
Gauge



16"
Coverage



3/8"
Max Rib Height

SpeedLap Trims & Colors

The Finishing Touch For Maximum Protection

Fascia 5 1/2" (FS55)



Fascia 7 1/4" (FS7)

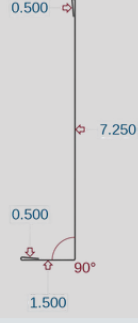

Soffit Angle Base (SFAB)



Soffit Broom Base (SFBB)

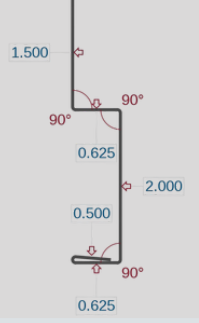

Soffit FJ Channel (SFFJ)

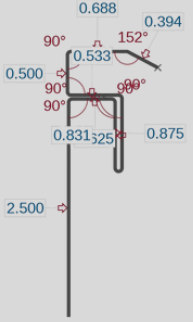

Soffit Garage Door J (SFGDJ)

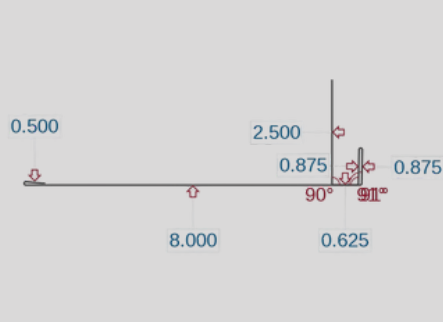

Soffit Inside Corner (SFIC)

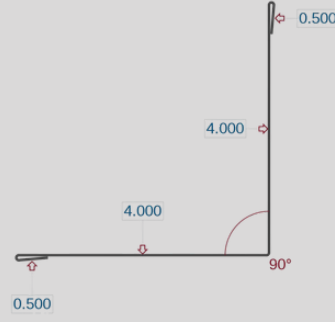

Soffit J Channel (SFJC)

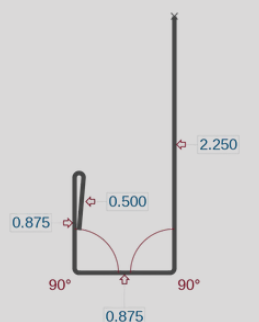

Soffit Outside Corner (SFOC)

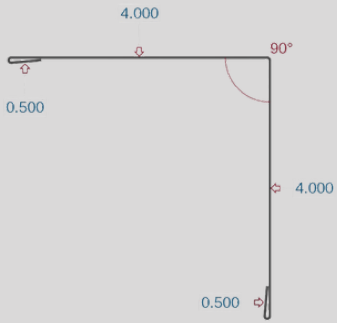

Soffit Rat Guard (SFRG)

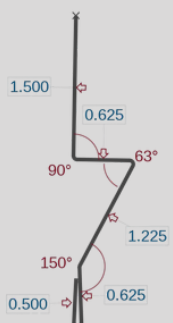

Soffit Top J (SFCTJ)

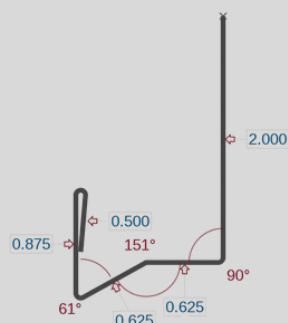

Soffit Wainscot (SFWC)



Soffit Window Drip Cap (SFWDC)



STANDARD COLORS



TEXTURED COLORS

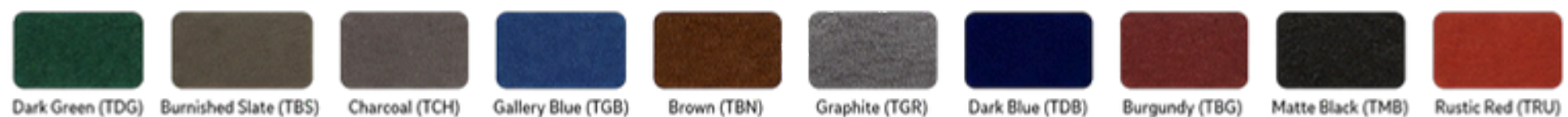

PRINTS

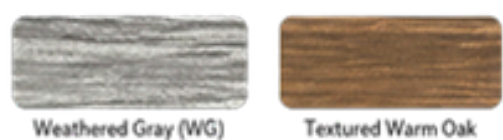

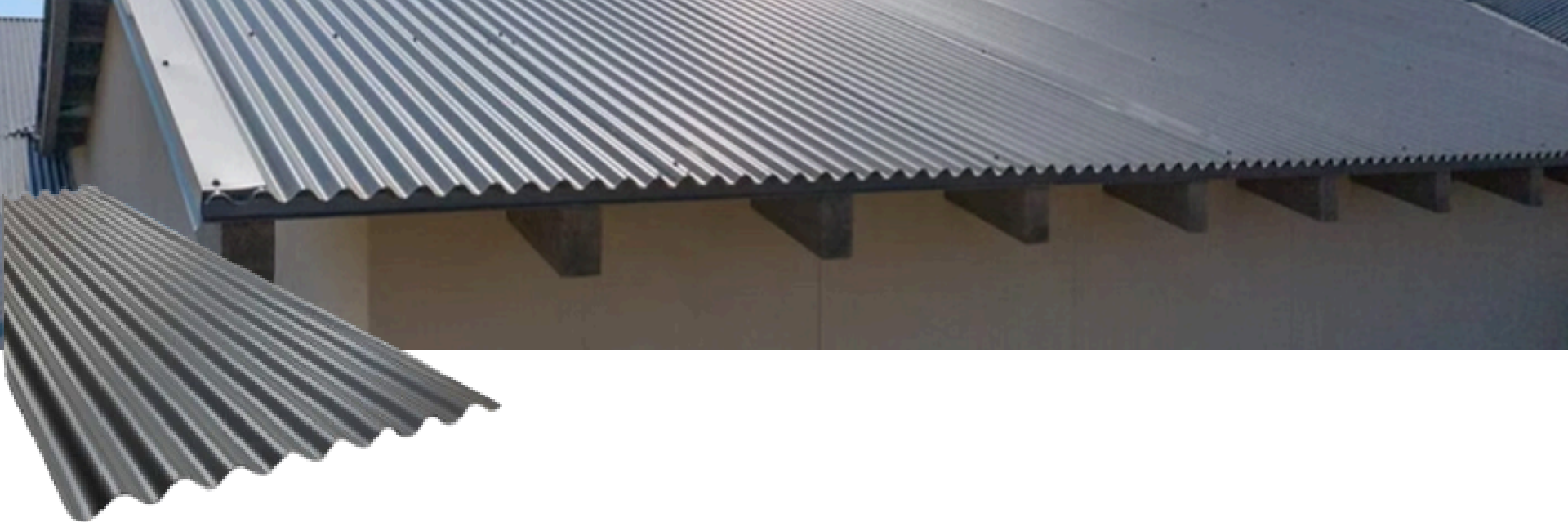

7/8 CORRUGATED PANELS

DURABLE, DEPENDABLE, BUILT TO PERFORM

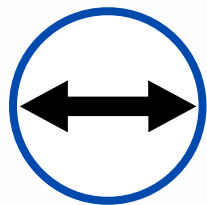

Coverage
32-37"

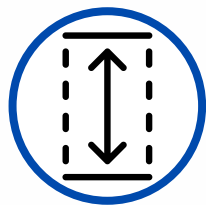

Rib Height
7/8"

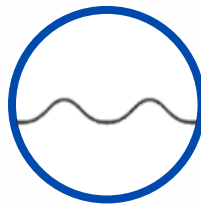

Flats Between Ribs
2-11/16"

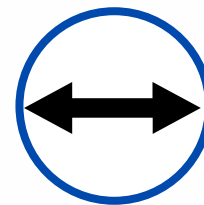

Lengths
4'-45'

PANEL MEASUREMENTS

26 Gauge: 29-1/2" Roof Coverage; 32" Wall Coverage

24 & 22 Gauge: 34-1/2" Roof Coverage; 37" Wall Coverage

← 2-11/16" Centers

7/8" Rib Height



26 & 24
Gauge



32-37"
Coverage



7/8"
Max Rib Height

Available Colors can be viewed on Page 23 & 24



7.2 PANELS

DURABLE, DEPENDABLE, BUILT TO PERFORM

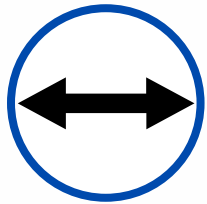

Coverage
36"

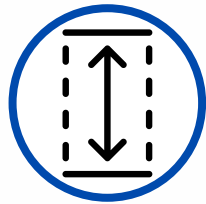

Rib Height
1-1/2"

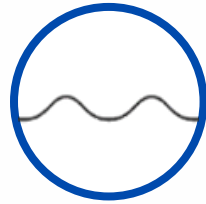

Rib Features
7.2"

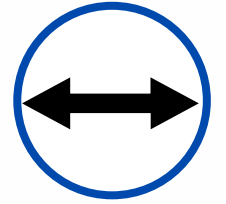

Lengths
4' - 45'

PANEL MEASUREMENTS



1-1/2"
Rib Height



24 & 22
Gauge



36"
Coverage



1-1/2"
Max Rib Height

Available Colors can be viewed on Page 23 & 24

7.2 Panel Trims

The Finishing Touch For Maximum Protection

*Available Colors
can be viewed on
Page 23 & 24

7.2 Eave Trim (ET72)

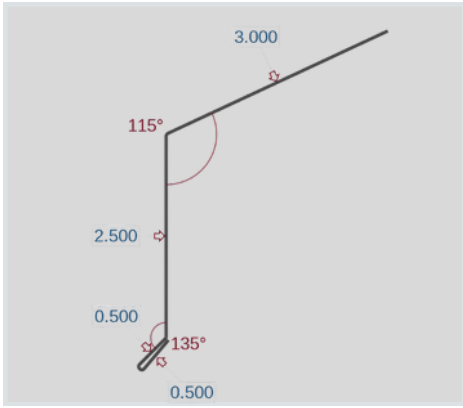

7.2 Step-Up Ridge Cap (RC72)

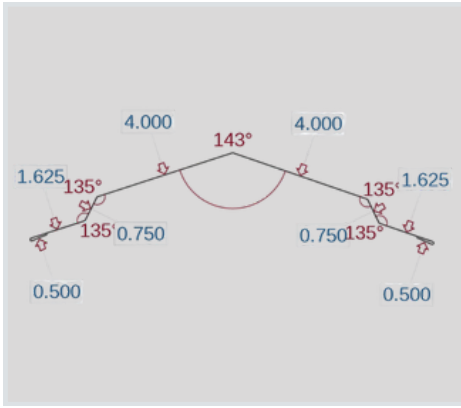

7.2 Rake (R72)

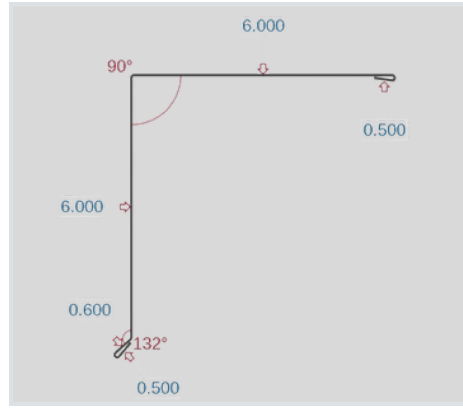

7.2 High Side Peak Trim (HPT72)

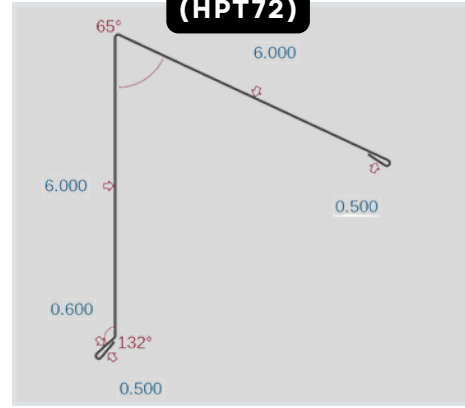

7.2 End Wall (EW72)

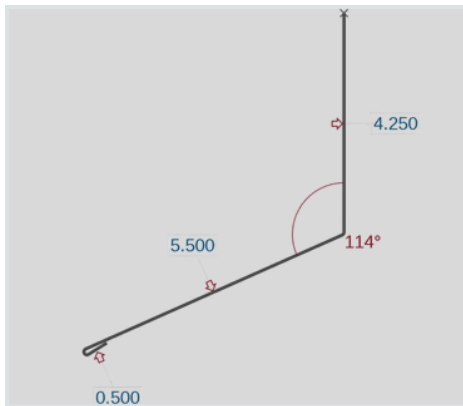

7.2 Sidewall (SW72)

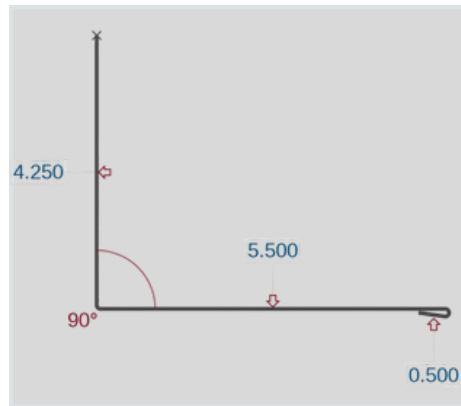

7.2 Transition (TT72)

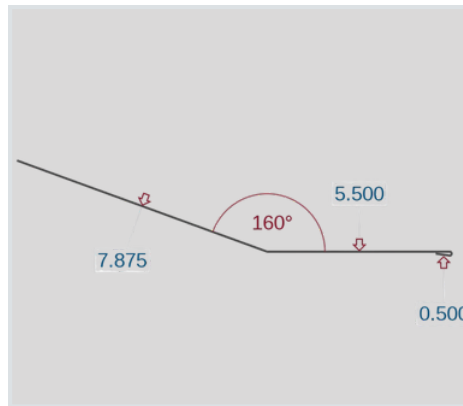

7.2 Valley Trim (VT72)

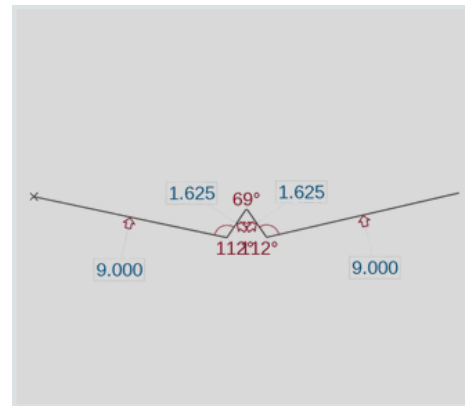

7.2 Snow Stop (ST72)

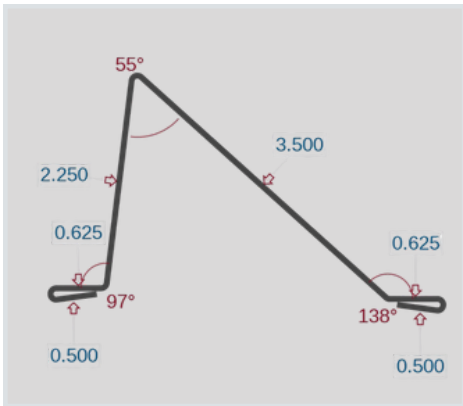

7.2 Fascia 5 1/2" (FS72)

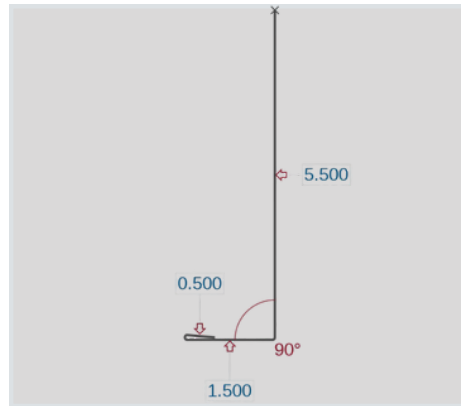

7.2 Fascia 7 1/4" (FS772)

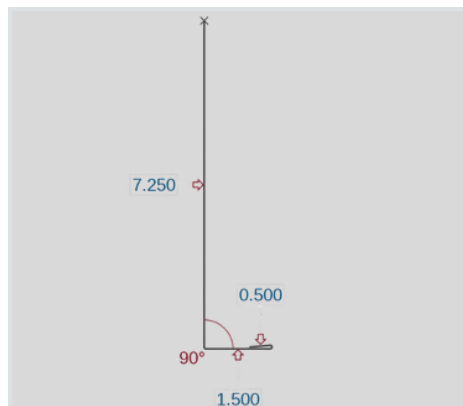

7.2 FJ Channel (FJC72)

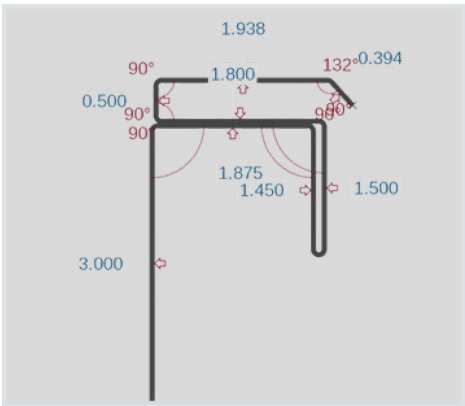

7.2 Drip Cap (DC72)

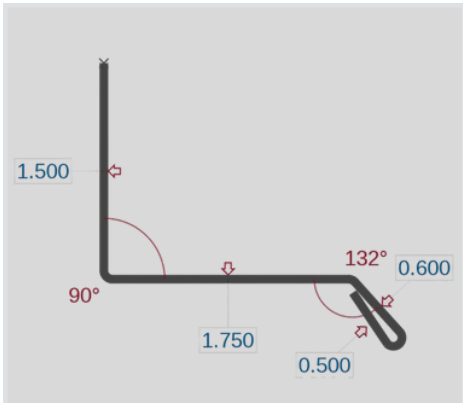

7.2 Outside Corner (OC72)

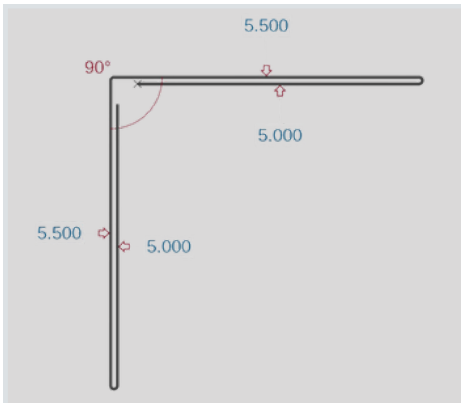

7.2 Inside Corner (IC72)

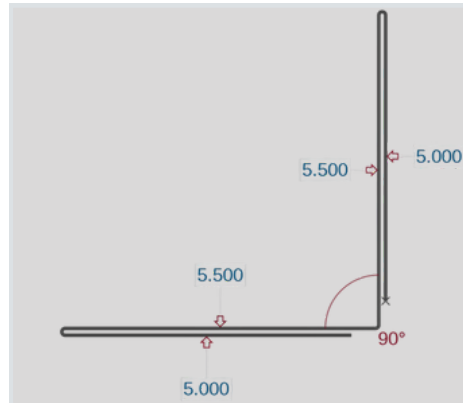

7.2 Garage Door J (GDJ72)

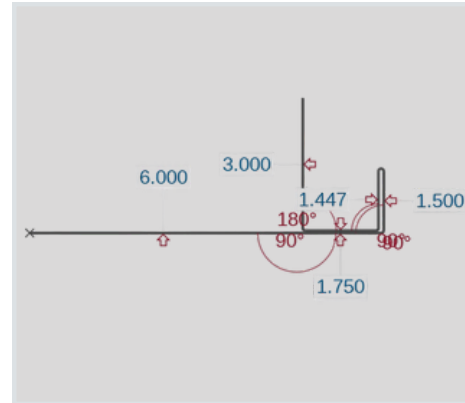

7.2 Top J (TJ72)

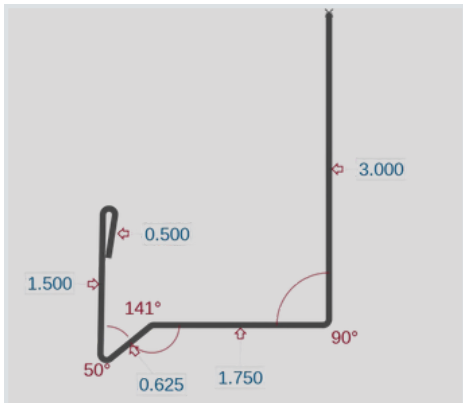

7.2 Wainscot (WC72)

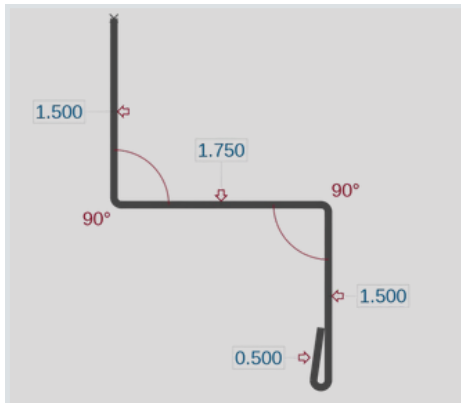

7.2 Angle Base (AB72)

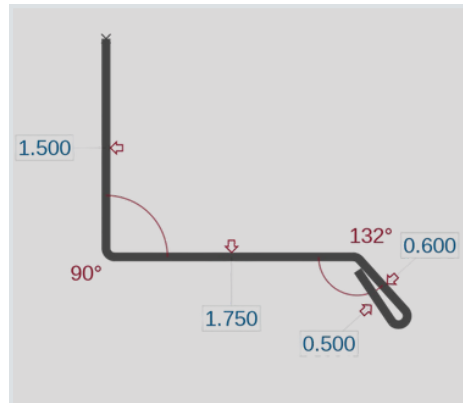

7.2 Rat Gaurd (RG72)

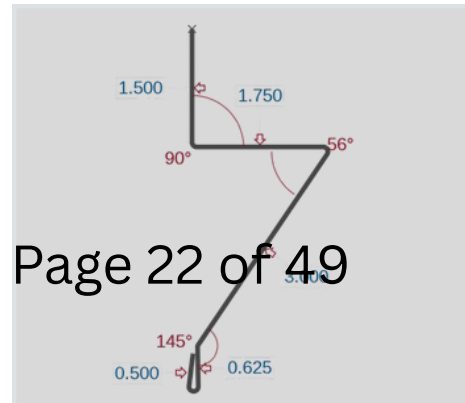

Available Colors

Colors shown are for reference only and may vary due to screen settings, lighting, photography, printing, and material finish. For the most accurate selection, please view a physical color sample before ordering.

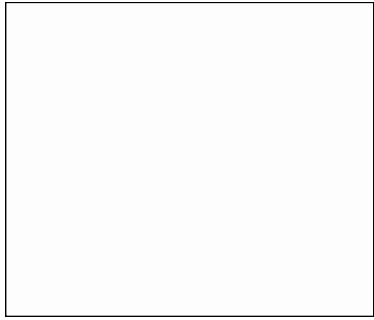

Arctic White

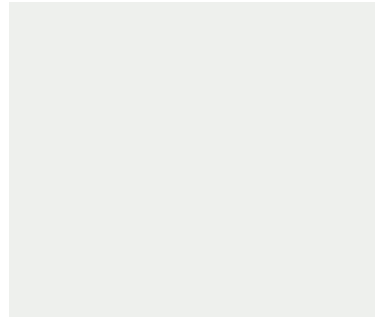

Polar White

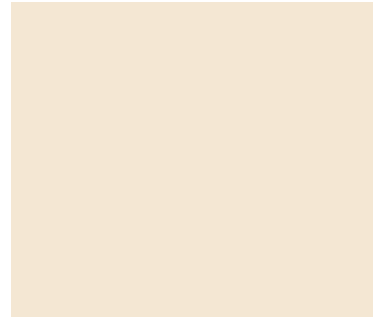

Ivory



Light Stone



Saddle Tan



Taupe



Desert Sand



Burnished Slate

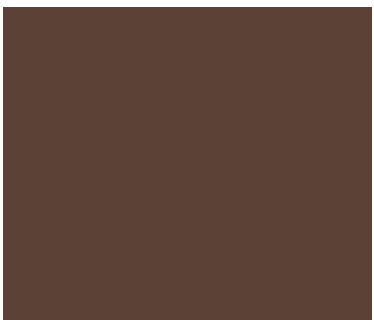

Koko Brown

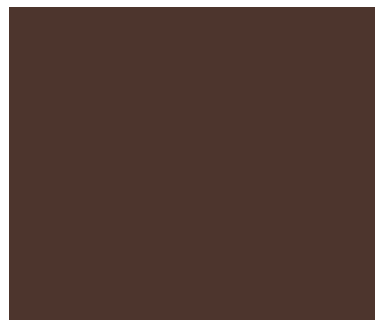

Brown



Old Town Gray



Charcoal Gray



Charcoal Blue Gray

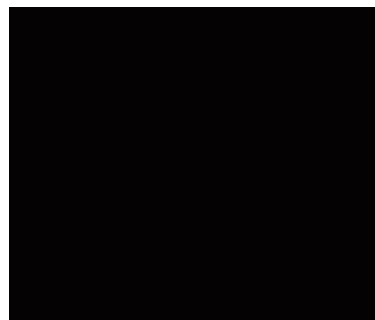

Black



Crimson Red



Rural Red

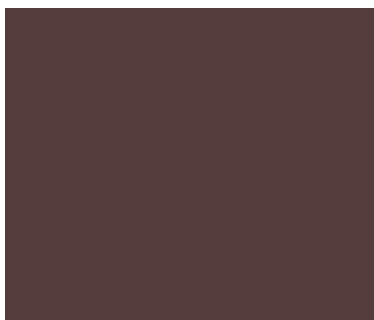

Berry



Colony Green



Evergreen



Ivy Green



Hawaiian Blue



Gallery Blue



Copper Metallic



Galvalume

Specialty Colors

Colors shown are for reference only and may vary due to screen settings, lighting, photography, printing, and material finish. For the most accurate selection, please view a physical color sample before ordering. Specialty colors may be available for an additional cost.



Antique Barnwood

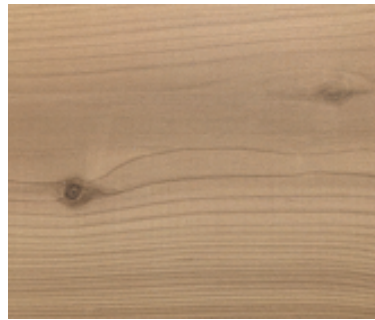

Smooth Cedar



Cedar Natural



Cedar Gray



Cedar Taupe



Rough Cedar Distressed

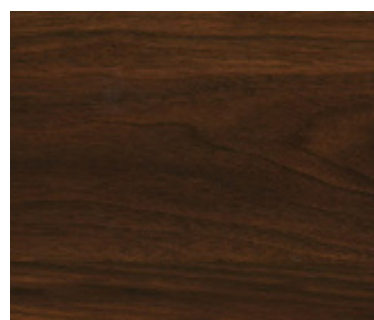

Walnut

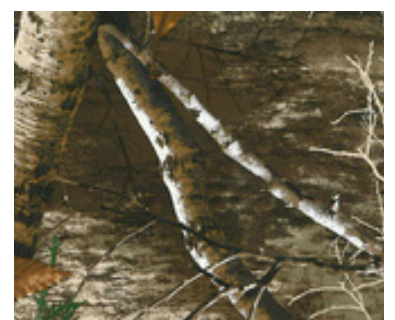

Camo

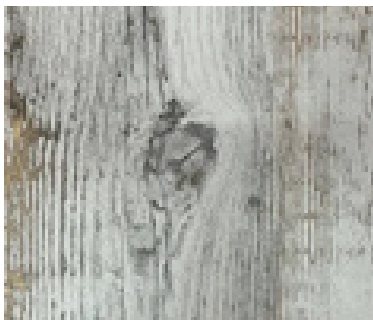

Chippy White

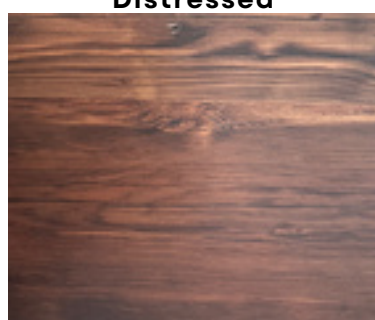

Prime Pine Plank

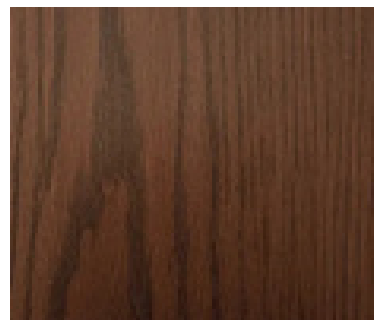

Dark Oak

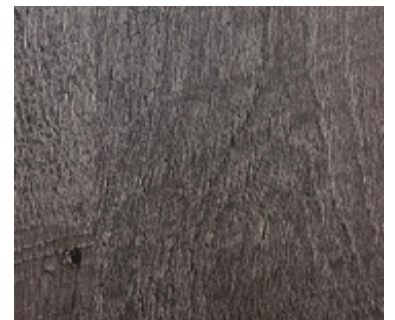

Distressed Gray Barnwood

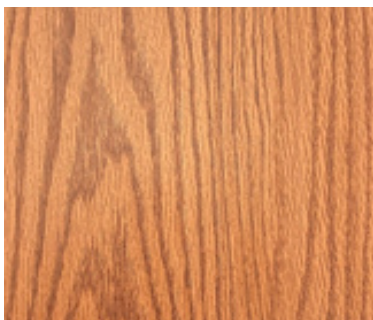

Medium Oak

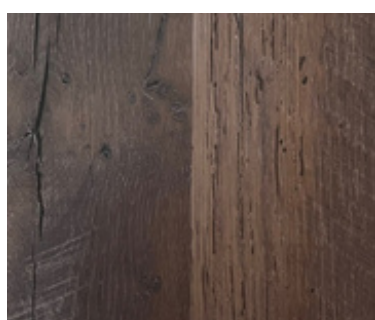

Gray Wash Barn Plank



Knotty Alder Plank

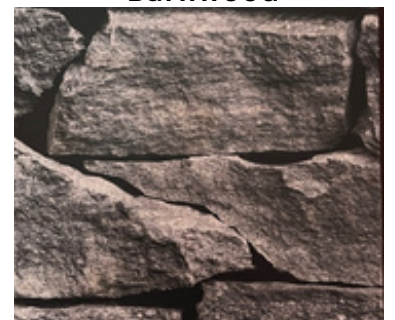

Arcadia Ledge Stone

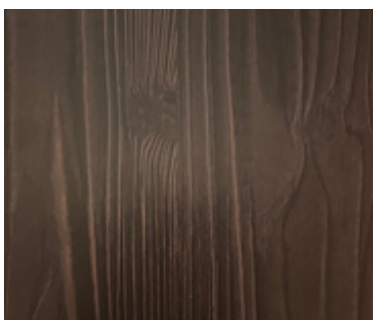

Burnt Charcoal

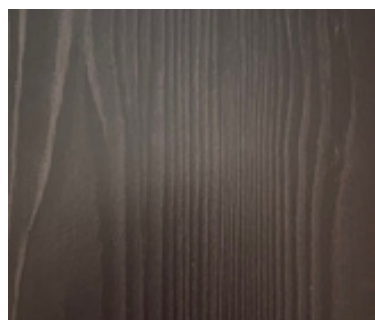

Burnt Black



Charcoal Gray CRINKLE



Black CRINKLE



Evergreen CRINKLE



Rustic Red CRINKLE



Burnished Slate CRINKLE



Koko Brown CRINKLE

Corner Trim

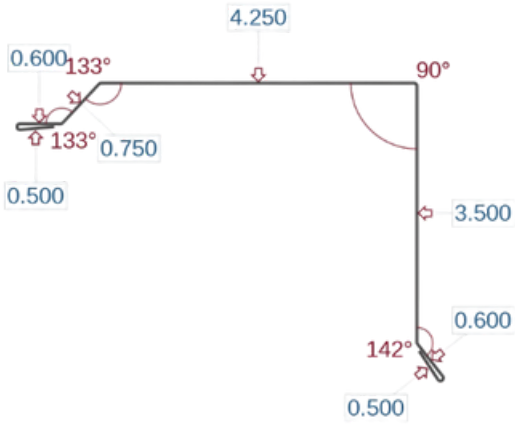

Residential Rake Trim (RRT)

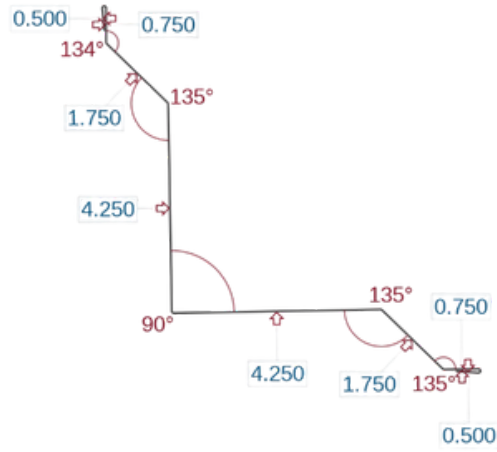

Commercial Inside Corner (CIN)

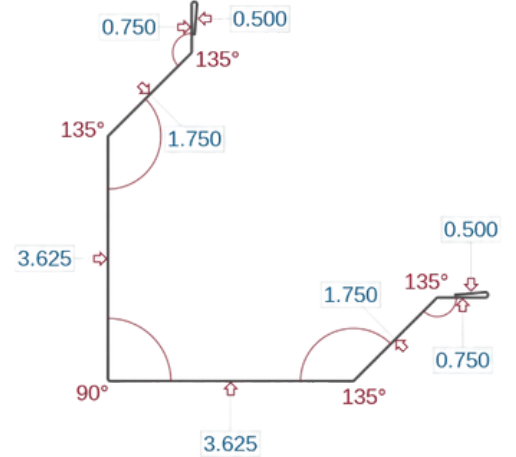

Commercial Outside Corner (COU)

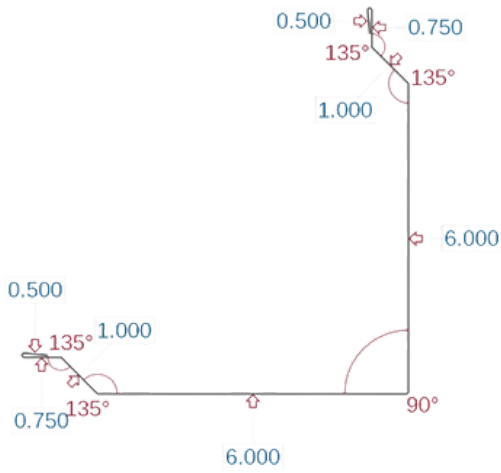

Corner Style Rake 6" Face (CSR)

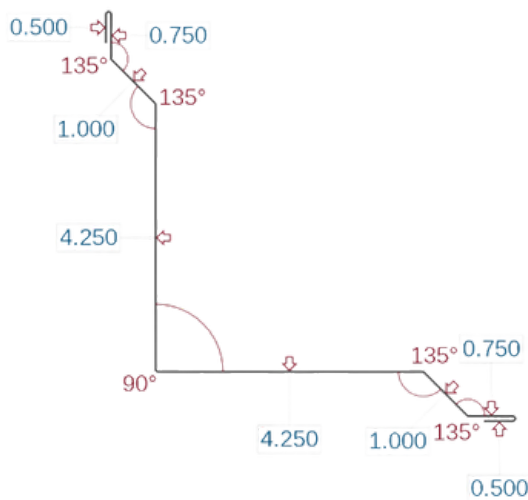

Inside Corner (IC1)

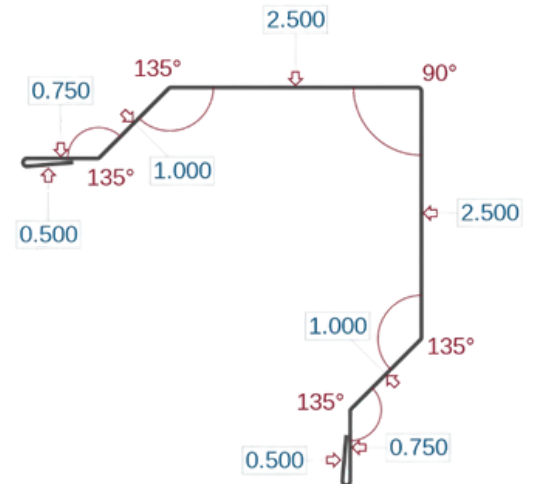

Mini Corner (MCRN)

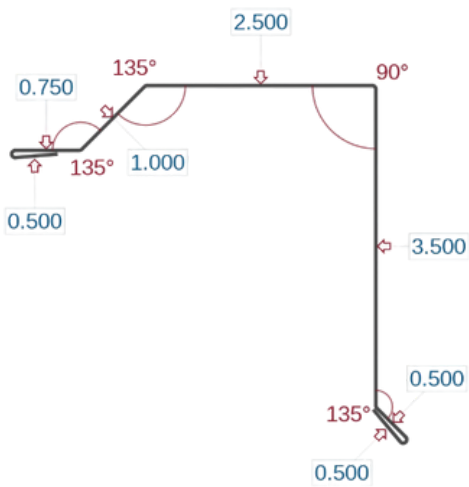

Mini Residential Rake Trim (RRTM)

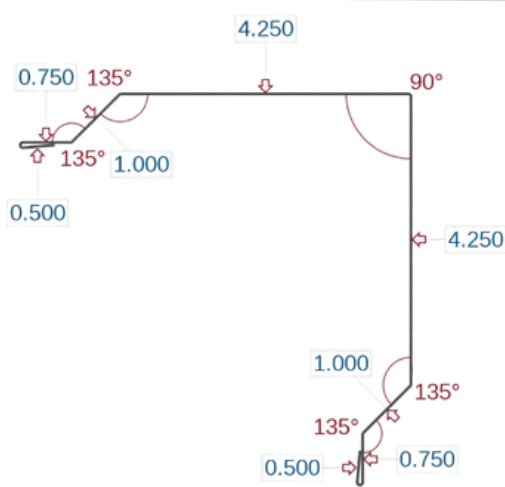

Outside Corner (COR)

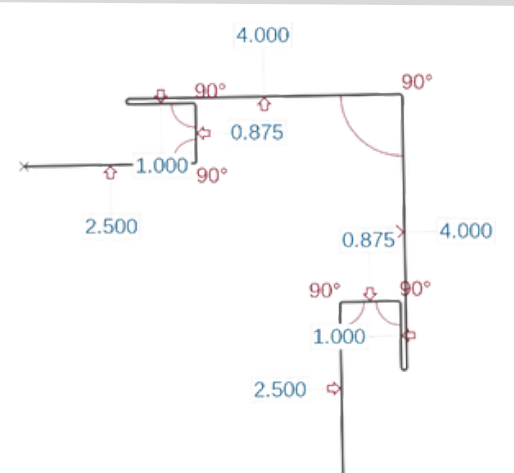

Outside Corner with 1" Receiver (OC1R)

Rake No Kick (HR)

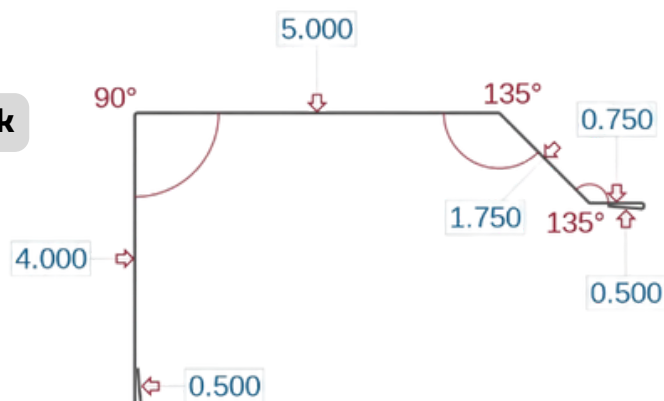

Counter Flashing

Counter Flashing (CF)

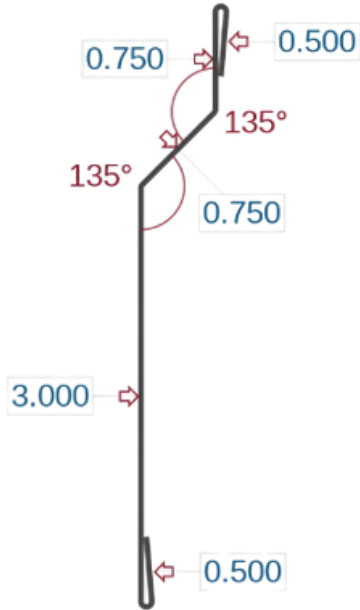

REGLET Counter Flashing (ACF)

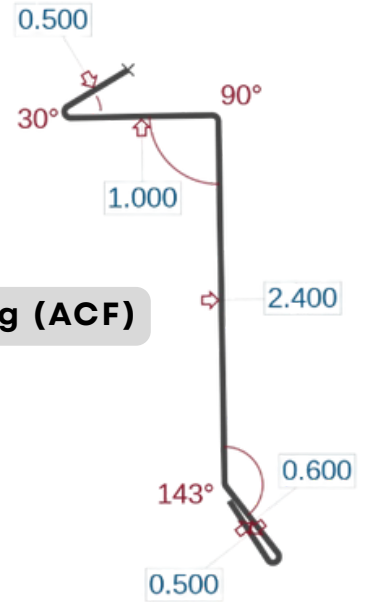

Double Angle

1" Double Angle (DA1)

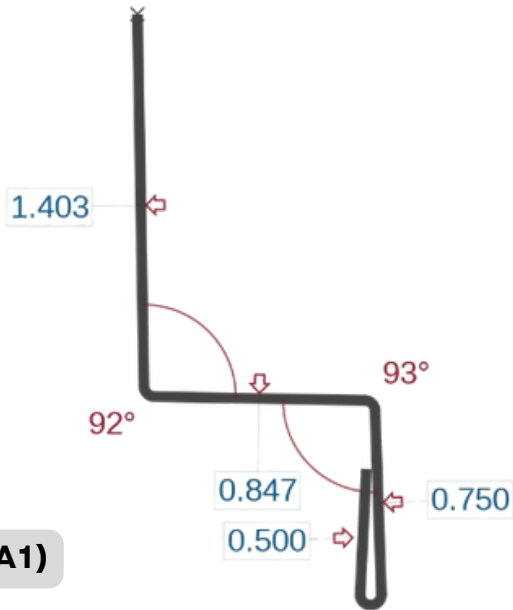

2" Double Angle (DA)

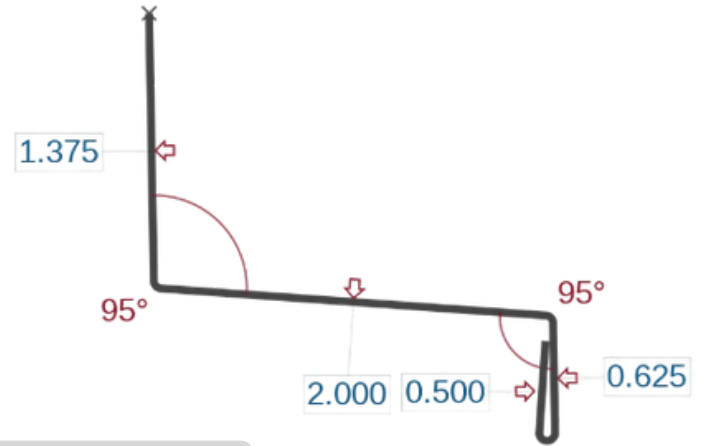

Wainscot

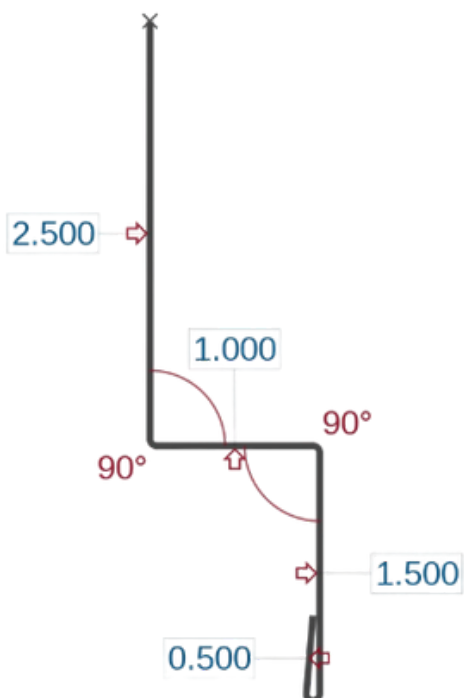

Wainscot

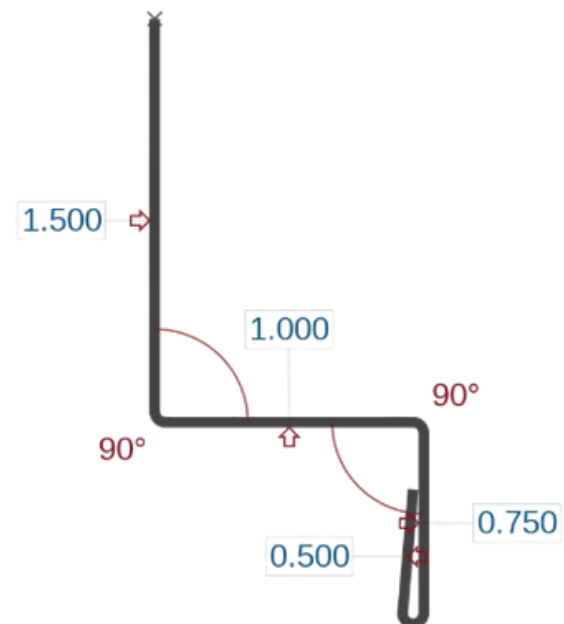

Eave Trim

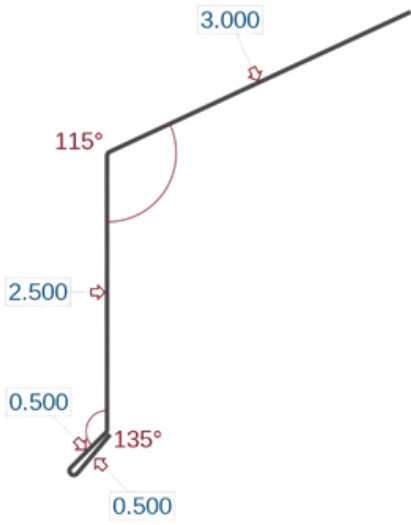

Residential Eave Trim (RET)

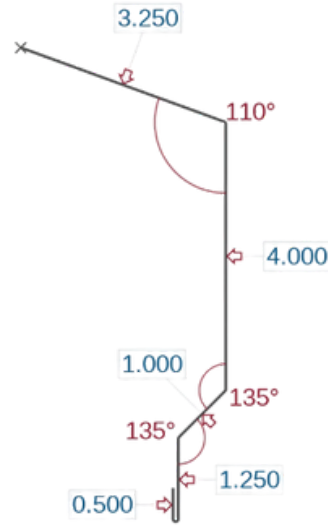

Fascia (FT)

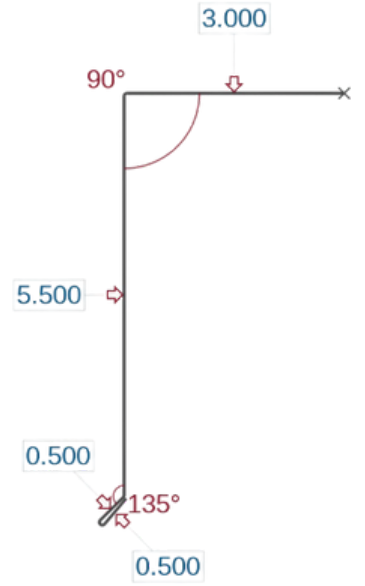

Long Eave (LEA)

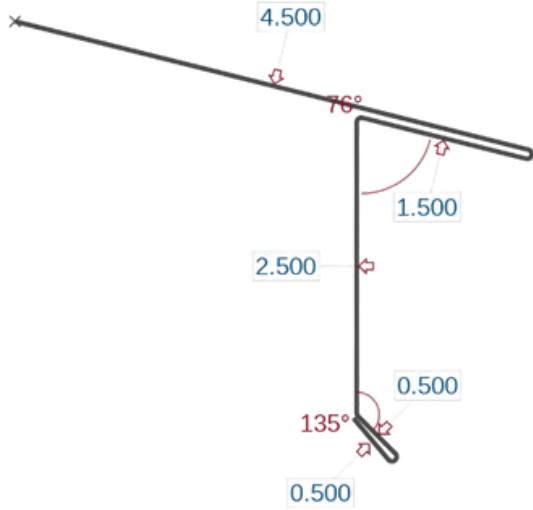

Residential Drip Edge D Style (RDE)

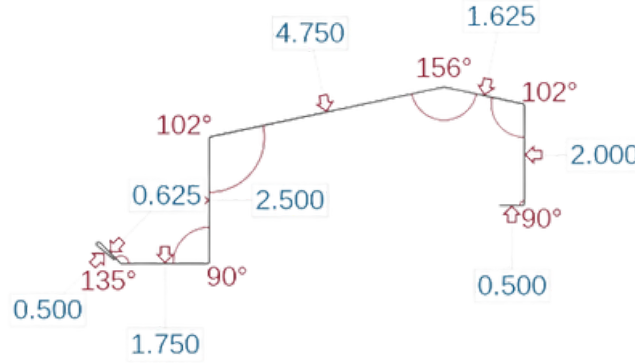

Sculptured Eave (SSEA)

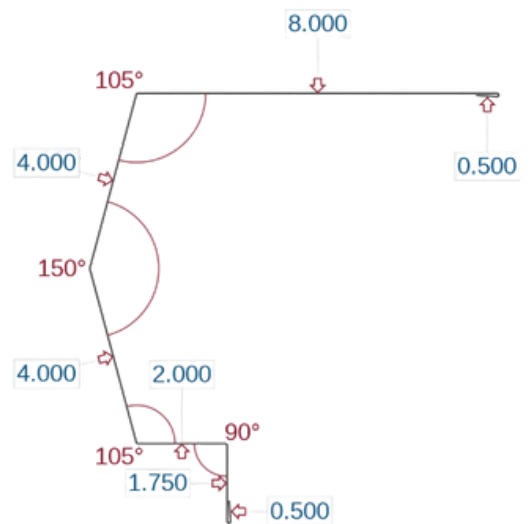

Sculptured High Side Eave (HI)

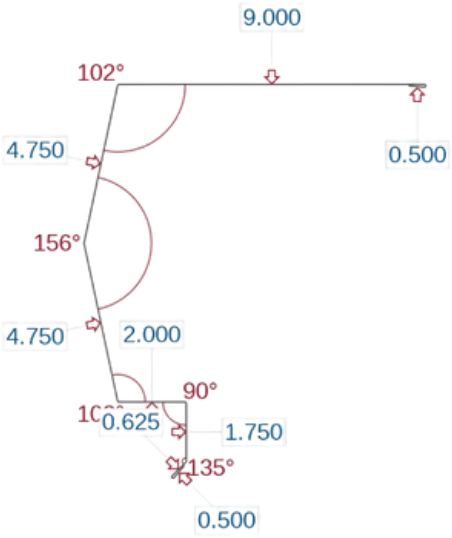

Sculptured High Side Eave < 2:12 (SSHI)

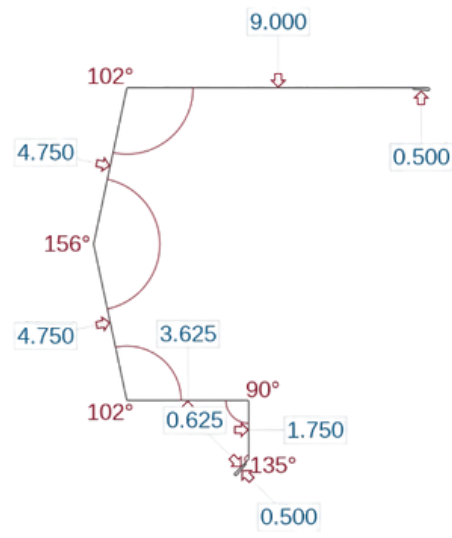

Sculptured High Side Eave > 2:12 (SSHI>)

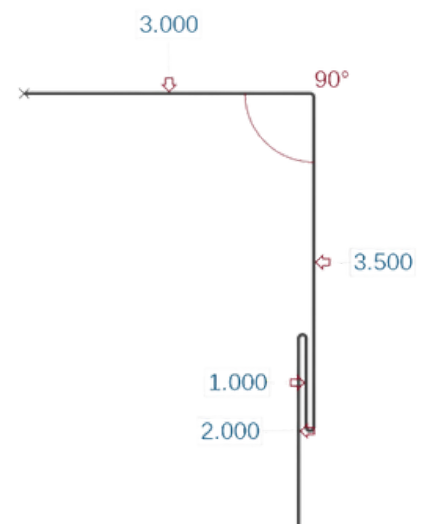

Style L Eave With Receiver Channel

Endwall

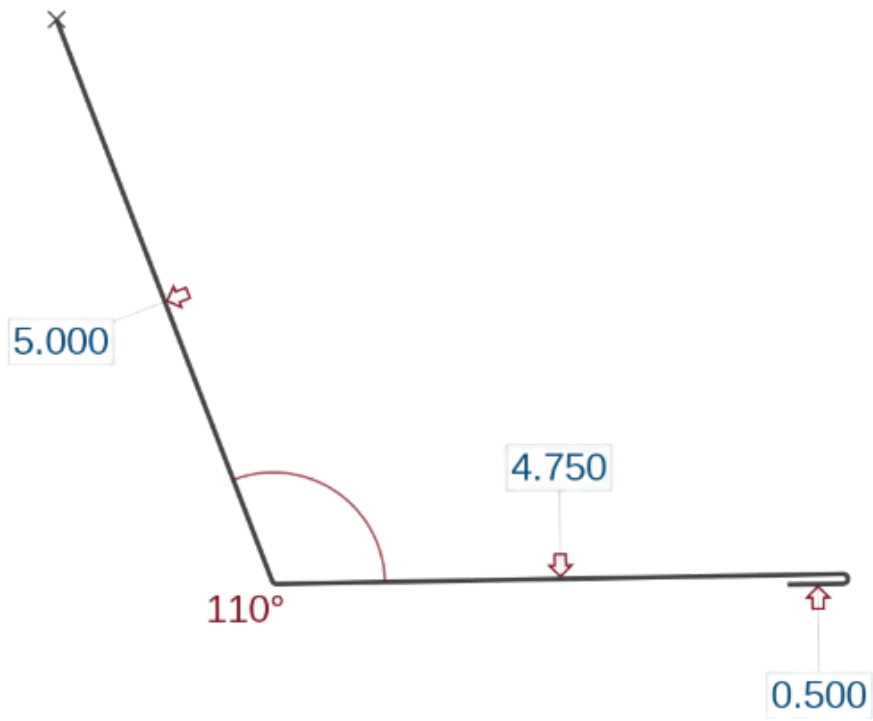

Low Gambrel (LGT)

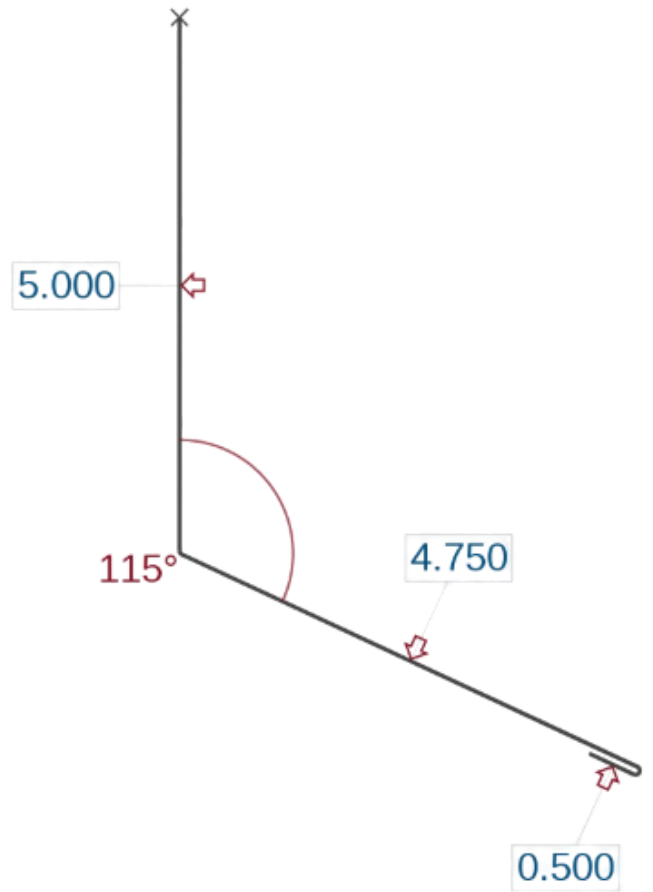

Universal Endwall (EWT)

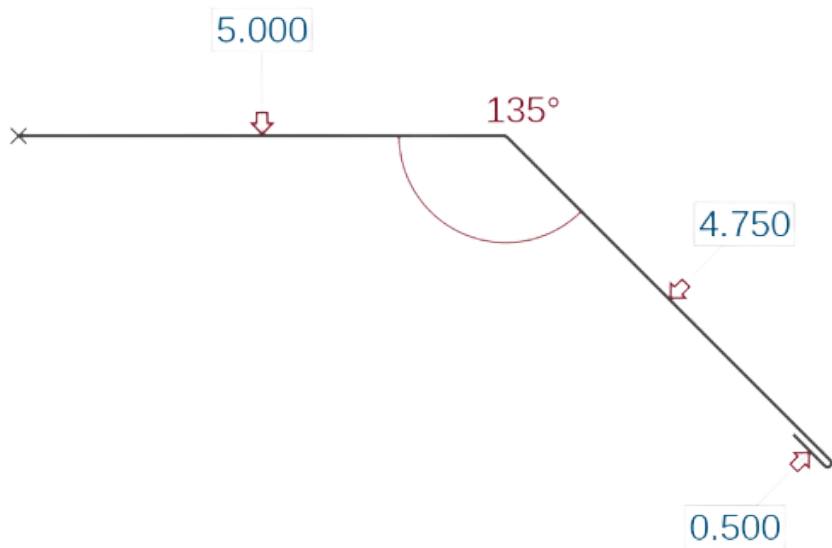

Upper Gambrel (UGT)

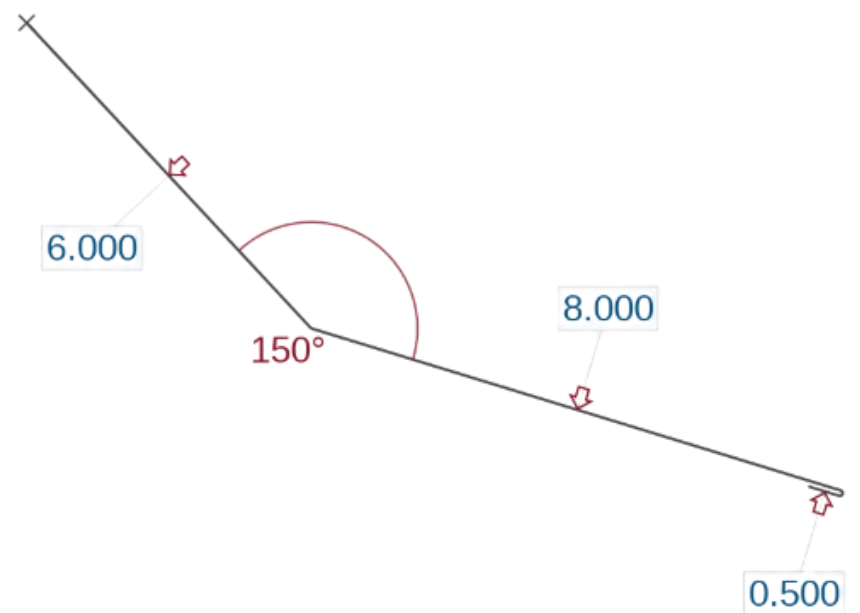

Wide Lower Gambrel (GTL2)

Fascia

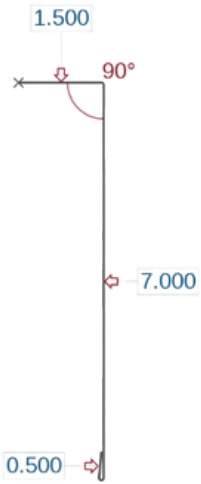

7" Door Post Trim (DJ7)

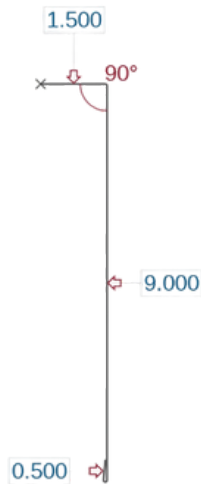

9" Door Post Trim (DJ9)

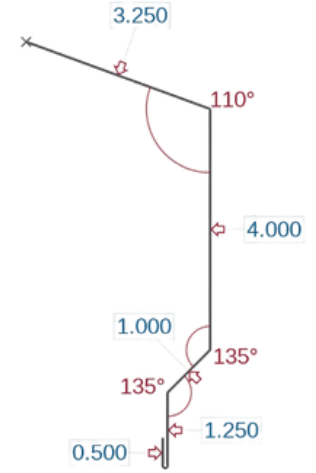

Fascia (FT)

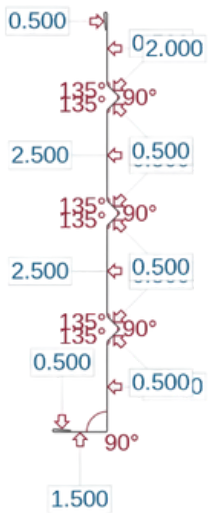

Fascia 11 1/2" Ribbed (FR)

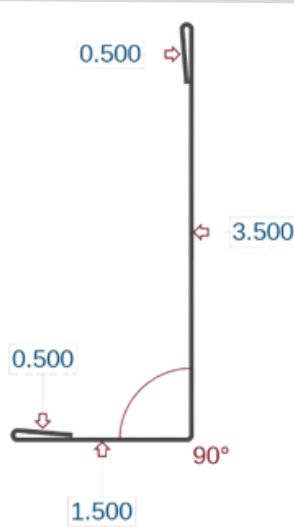

Fascia 3 1/2" (FT35)

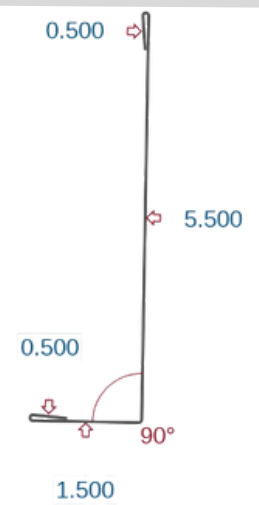

Fascia 5 1/2" (FT55)

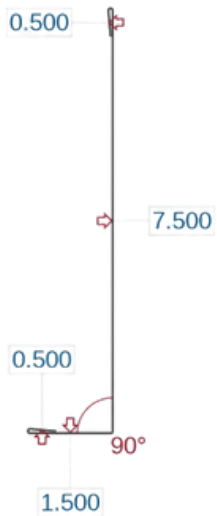

Fascia 7 1/2" (FT75)

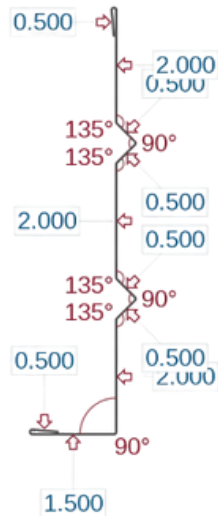

Fascia 7 1/2" Ribbed (FR75)

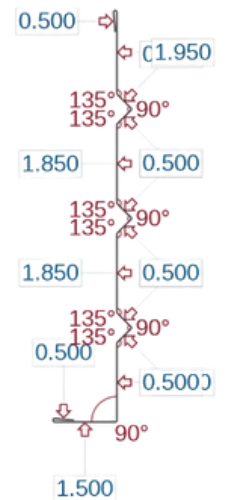

Fascia 9 1/2" Ribbed (FR95)

**Residential Fascia Trim
3 1/2" (RFT31)**

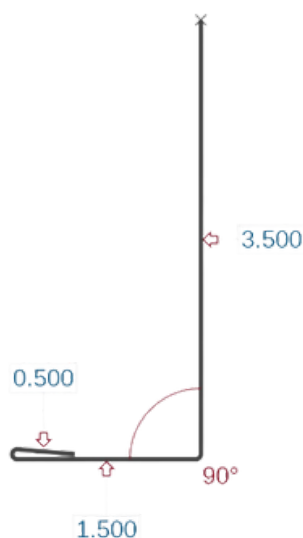

J-Channel

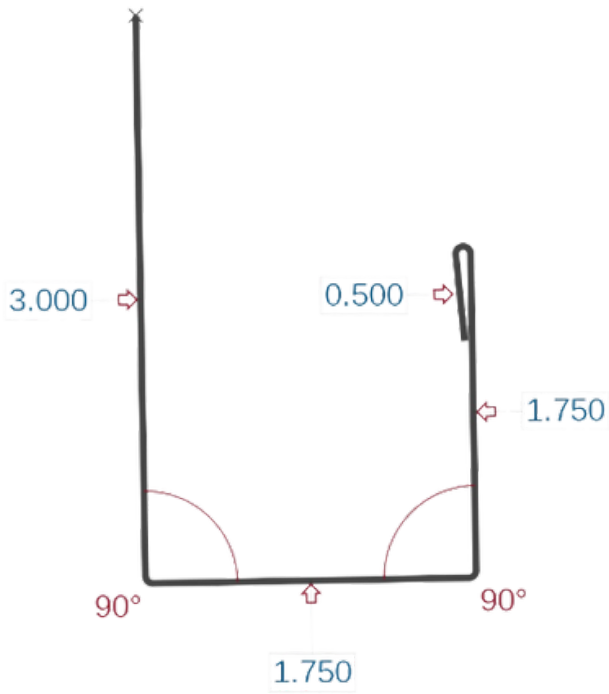

J - Channel 1 3/4" Receiver R-Loc Open

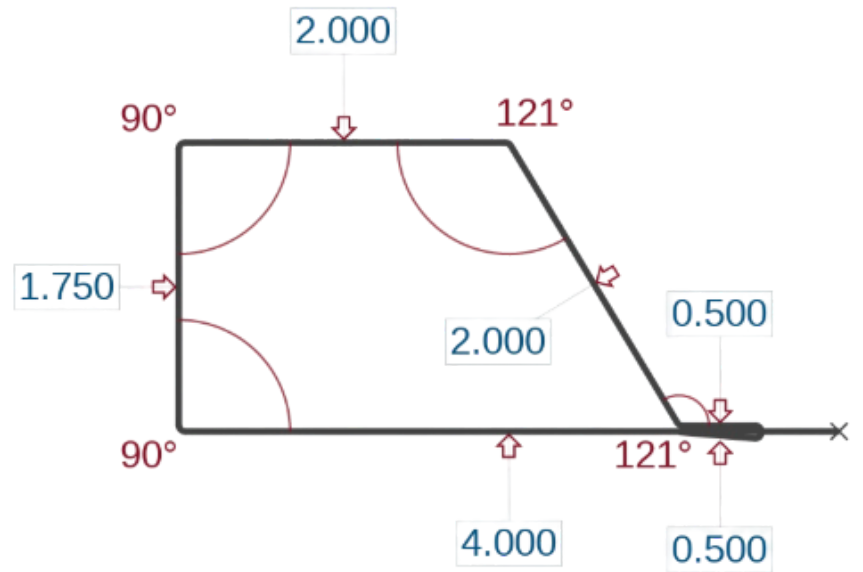

J-Channel R-Loc Closed

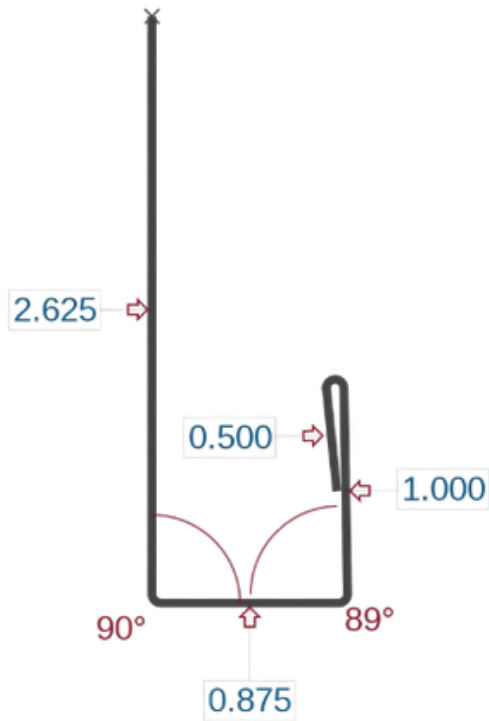

J - Channel (JT)

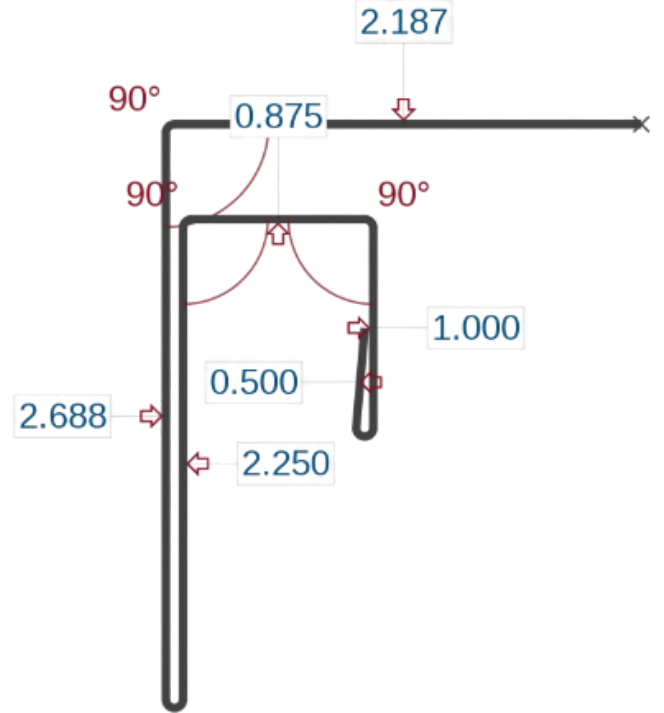

Soffit F and J channel (SFJ)

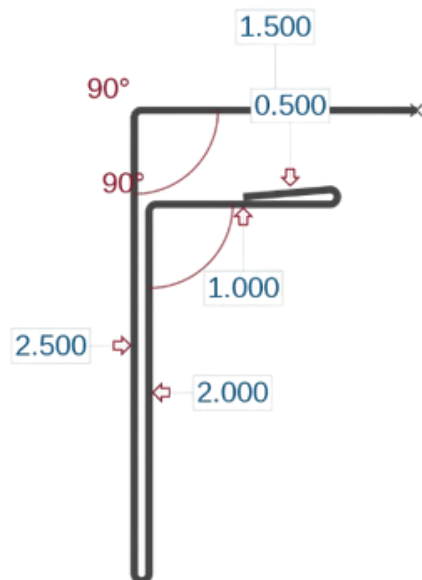

Soffit F Channel (FC12)

Overhead Door Jambs

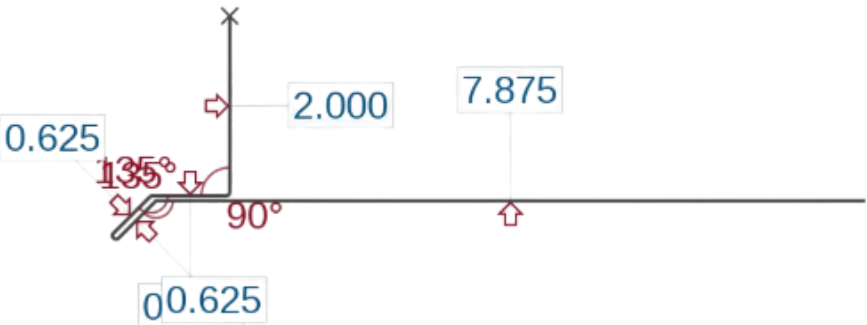

7 1/8 Overhead Door Jamb (OHDJ7)

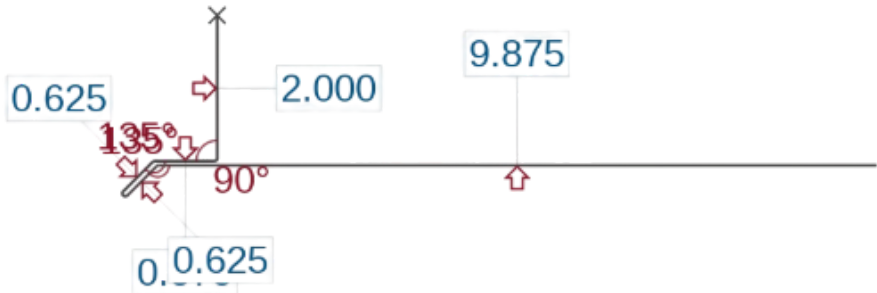

9 1/4 Overhead Door Jamb (OHDJ9)

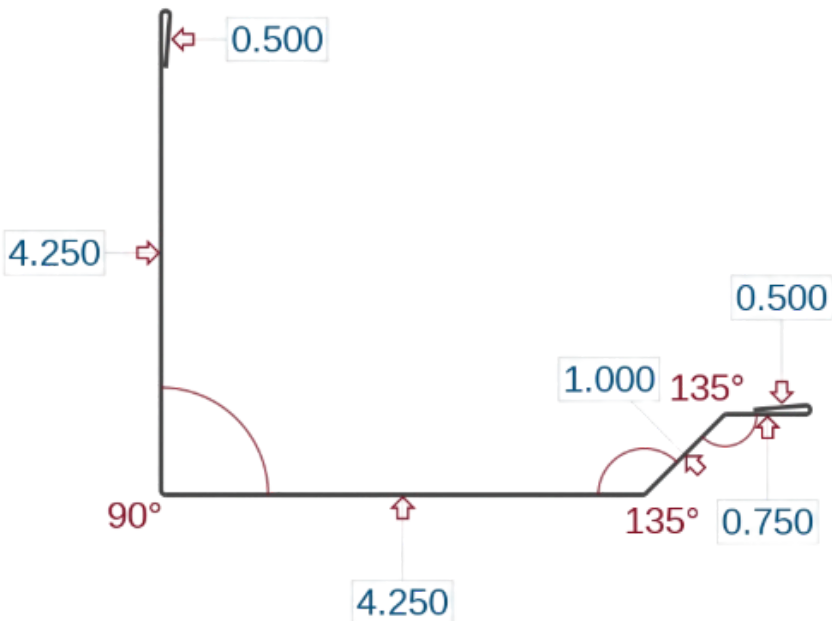

Door Edge (DJ10)

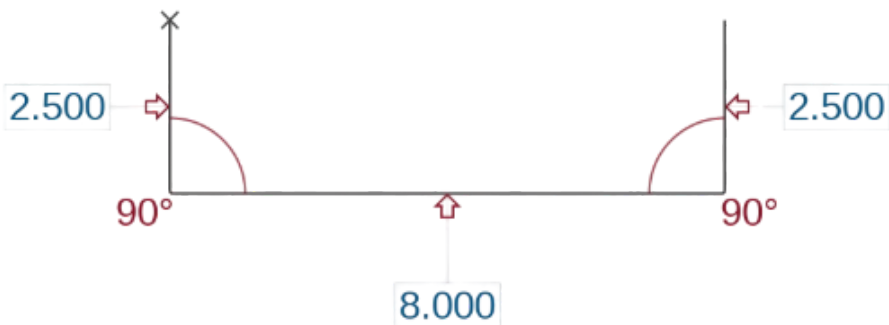

Jamb Header (JH)

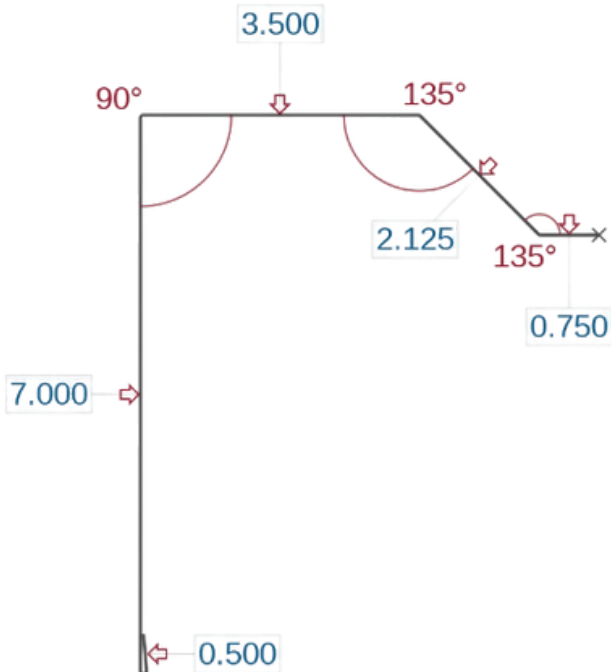

Track Door Jamb (TDJT)

Rake Trim

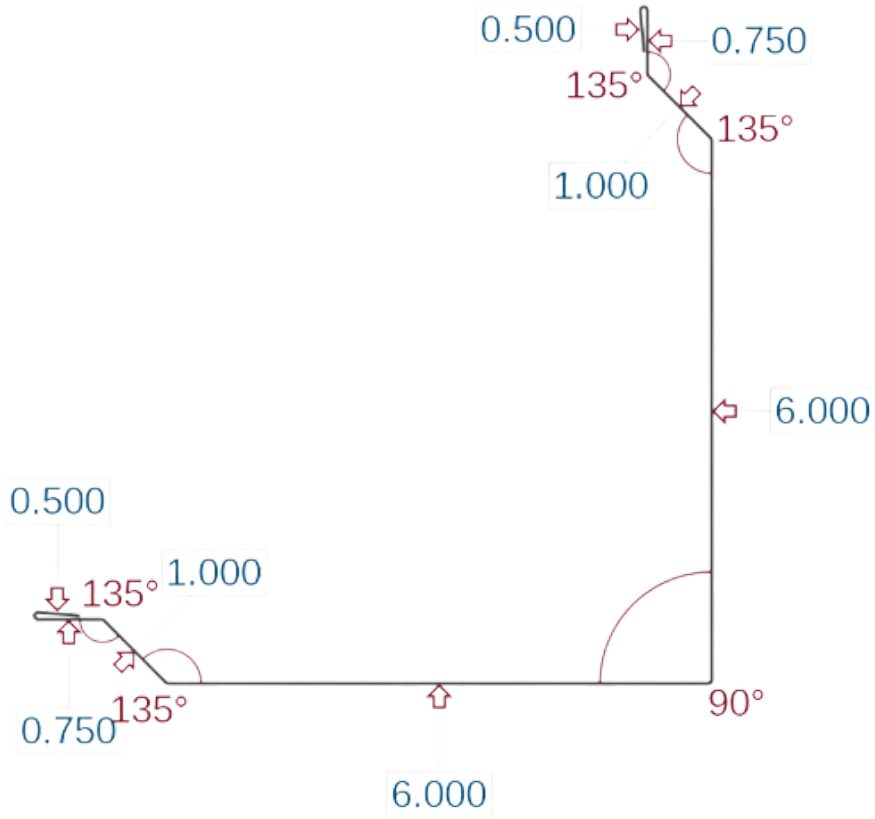

Corner Style Rake 6" Face (CSR)

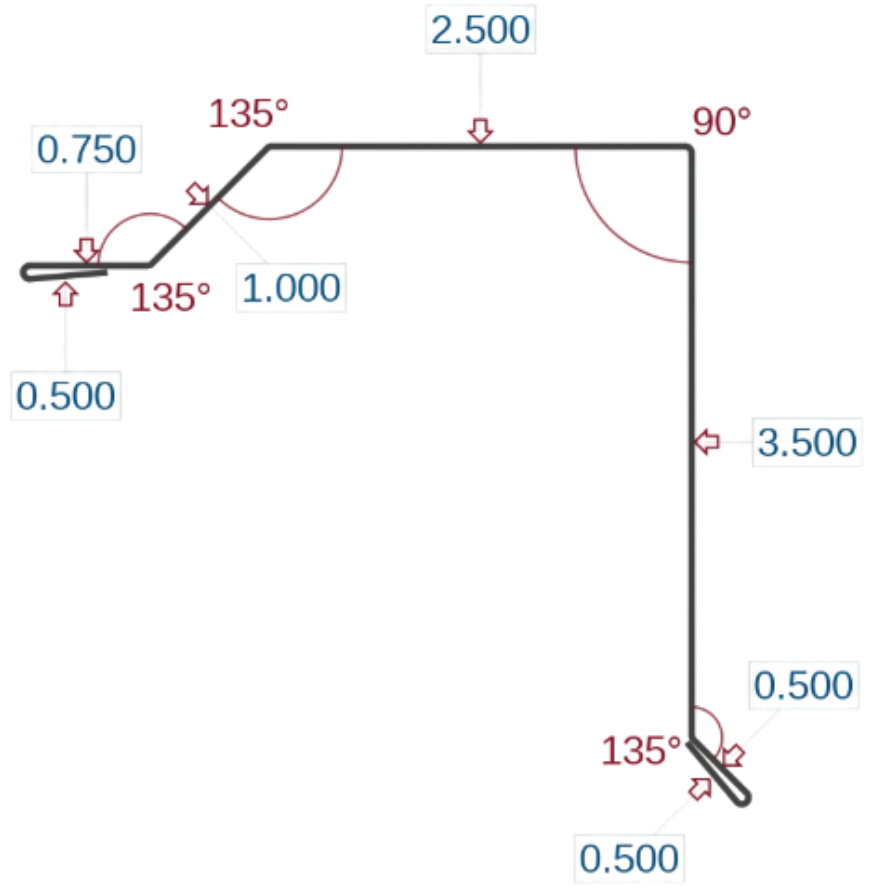

Mini Residential Rake Trim (RRTM)

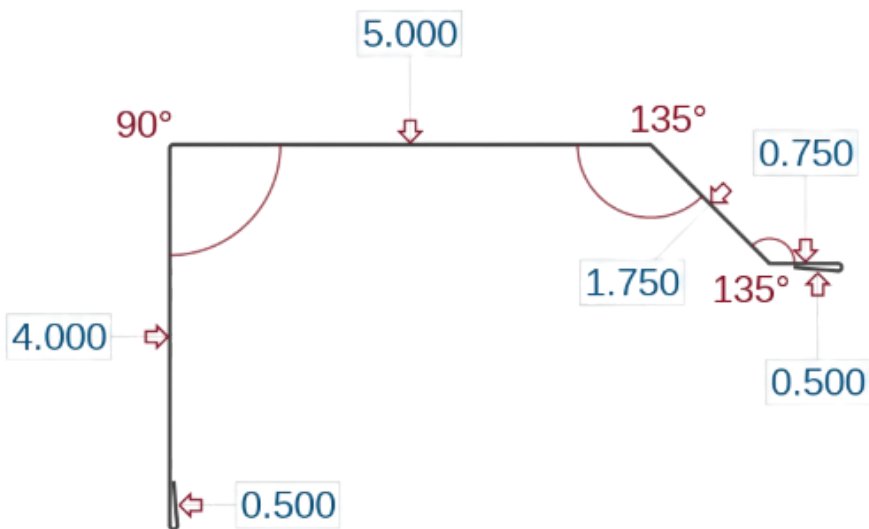

Rake No Kick (HR)

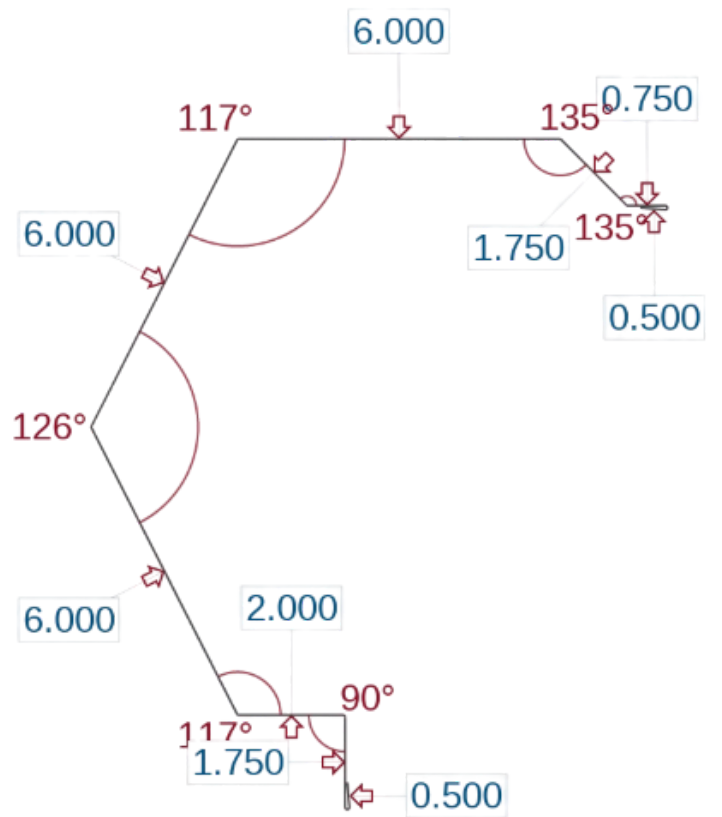

Sculptured Gable Flashing

RATguard

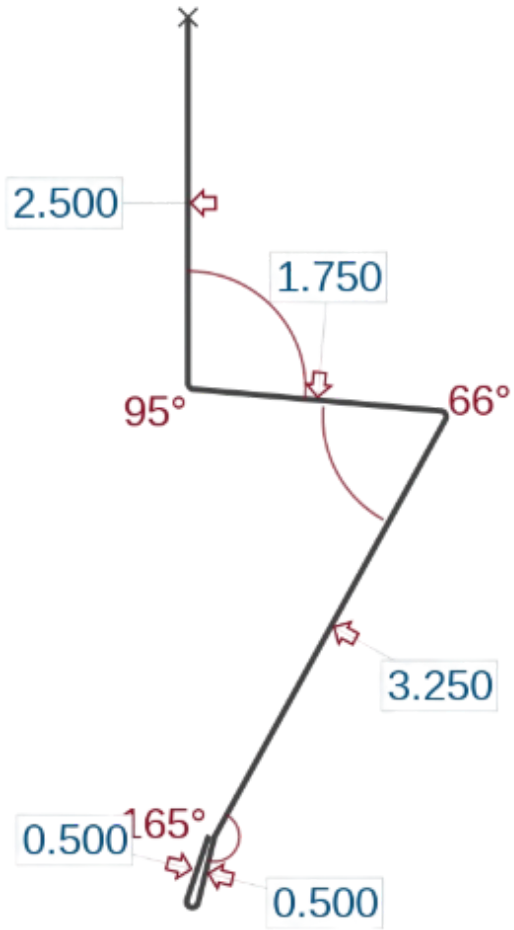

1 3/4" Commercial Ratguard (RGC)

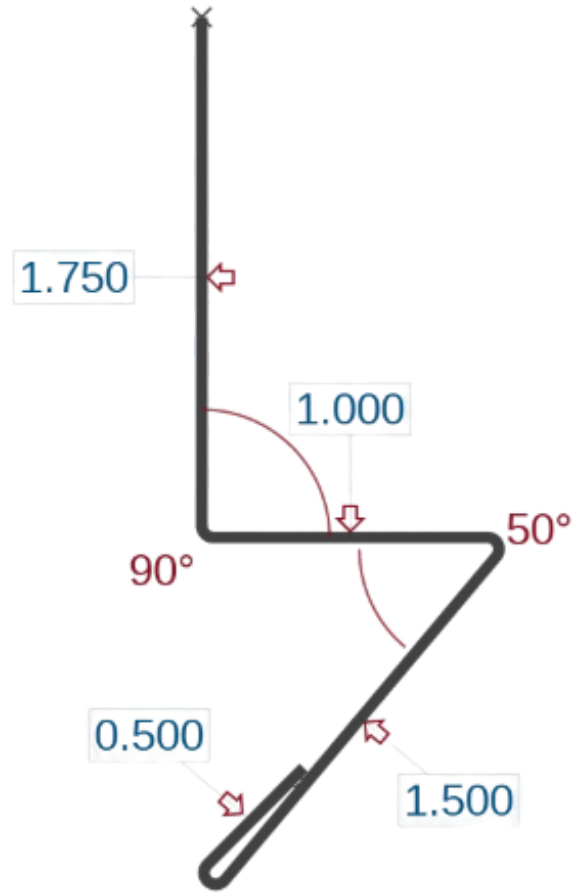

1" Rat Guard (RG)

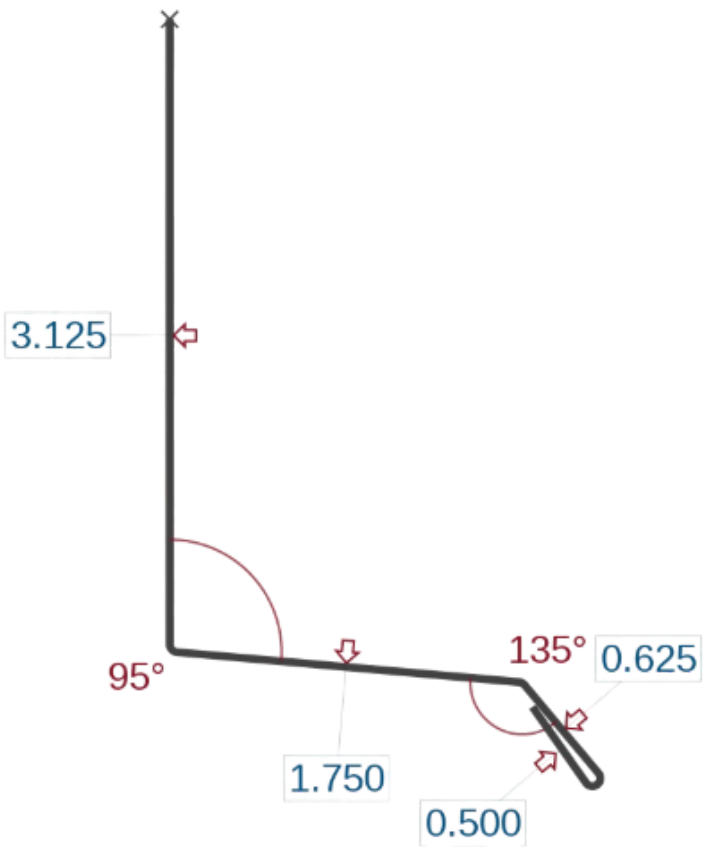

Base Trim (BA)

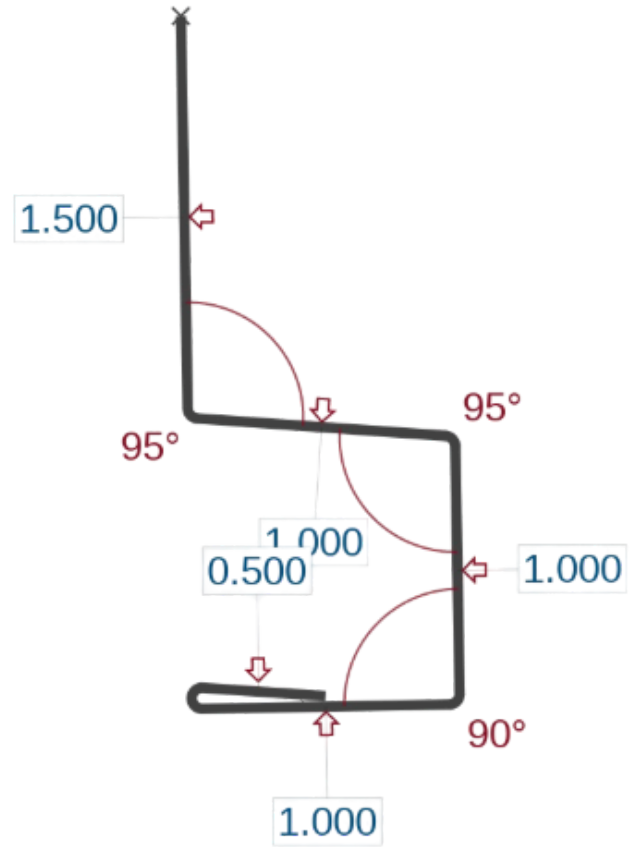

Square Base (SBA)

Ridge and Hip

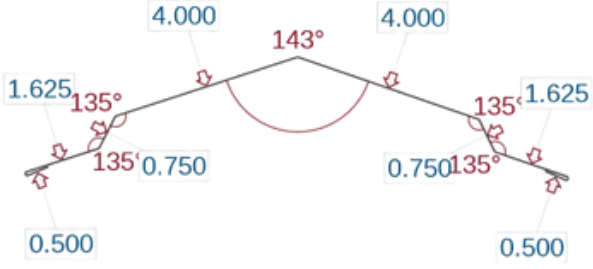

Step Up Ridge Cap (RCP)

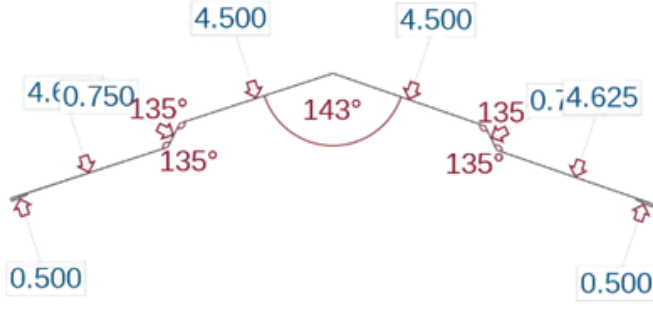

19" Wide Ridge Cap (RC)

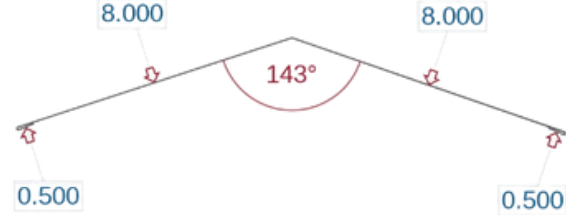

8"x8" Flat Ridge Cap (RRCP)

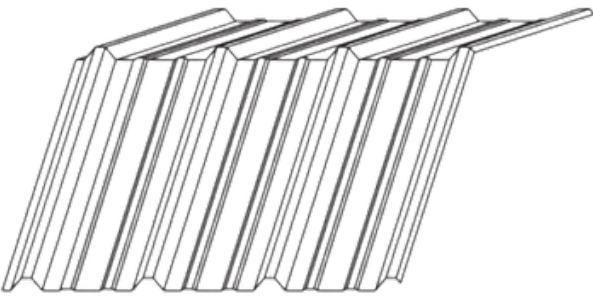

**Formed Ridge Cap
0/12 to 4/12 Pitch**

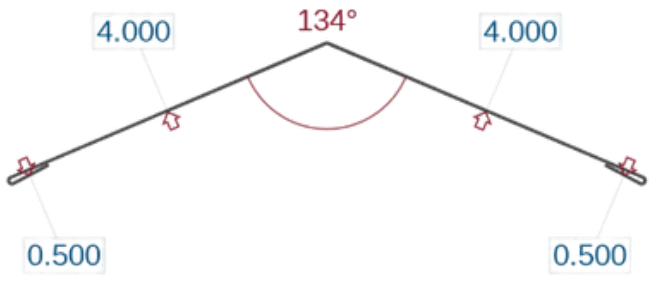

Hip Trim (HIP)

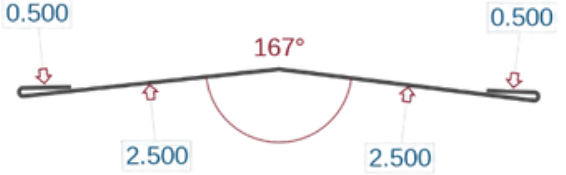

Inside Ridge Cap (INRCP)

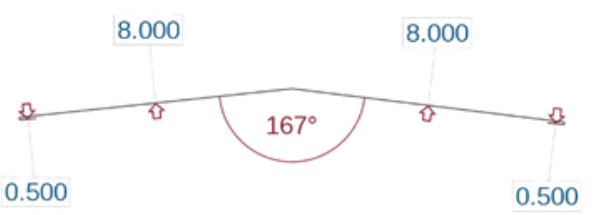

OPEN HEM Ridge Cap

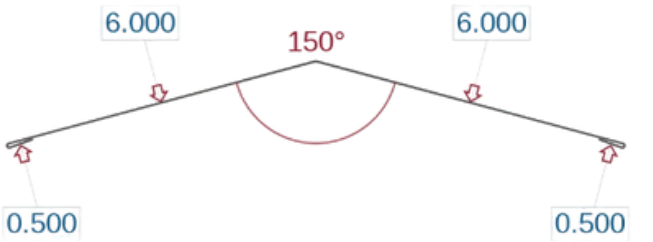

Ridge and HIP 6"X6" FLAT

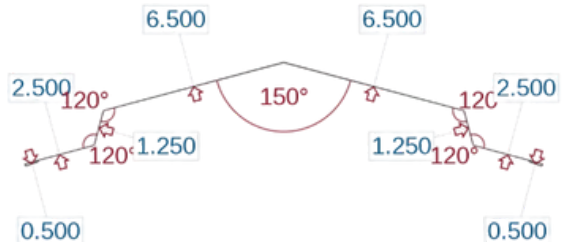

**RidgeCap Floating
6.5" (SSRCP6)**

**RidgeCap Floating
7.5" (SSRCP7)**

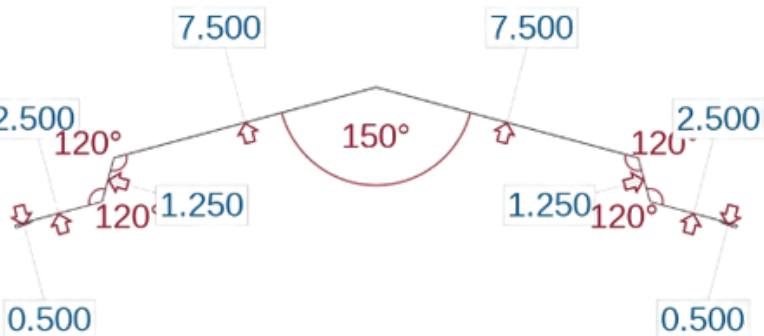

Single Angle/Endwall

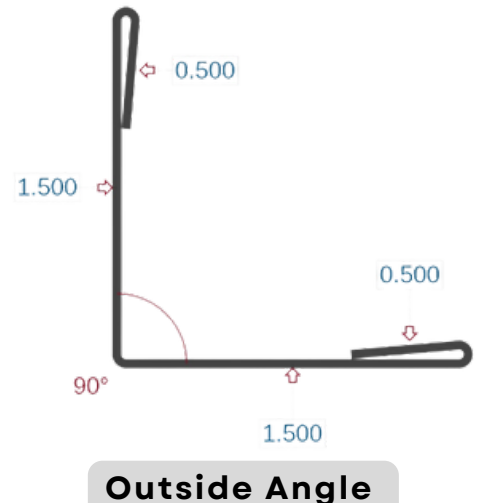
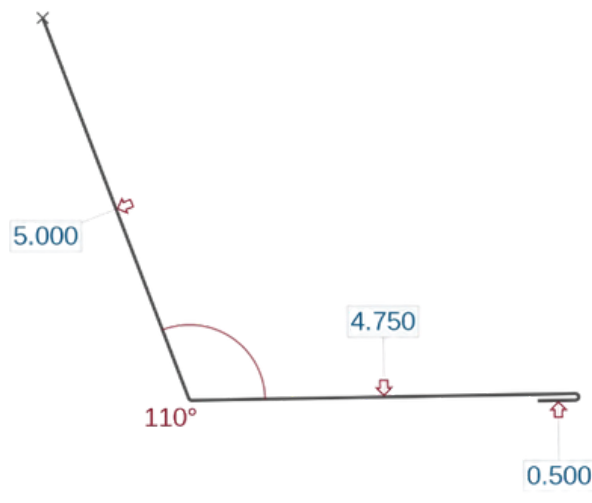
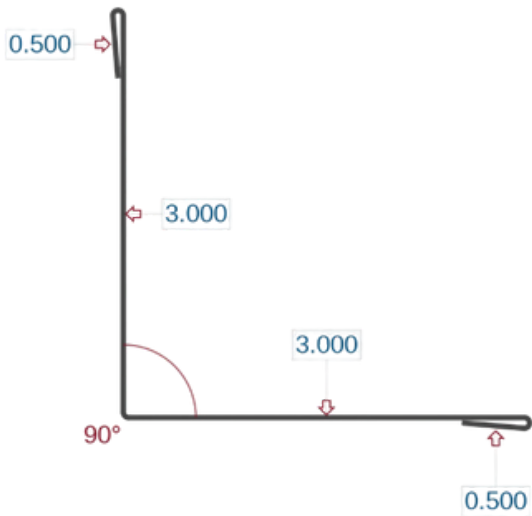
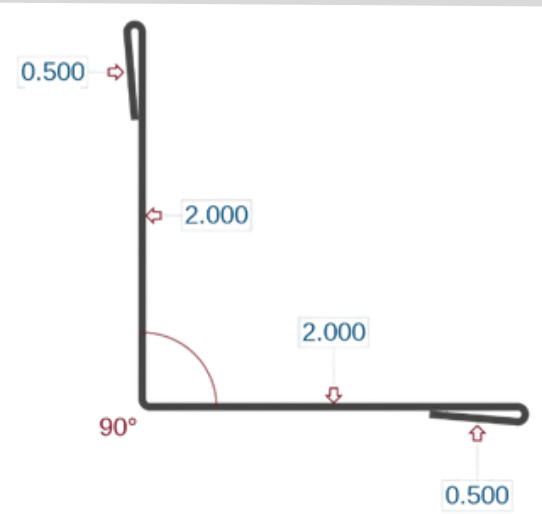
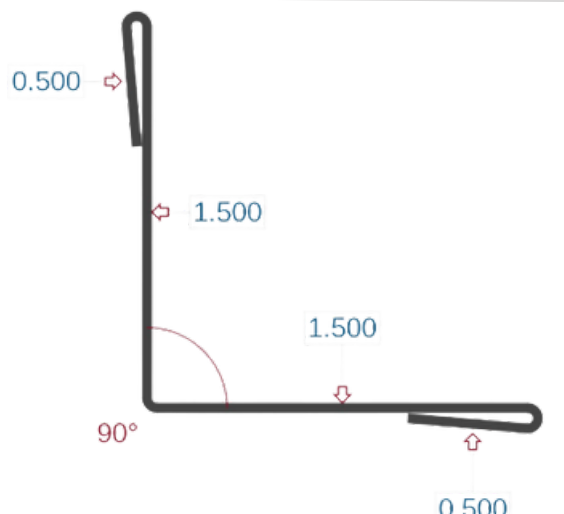
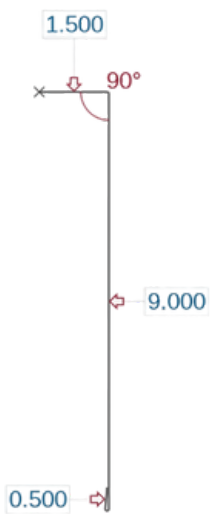
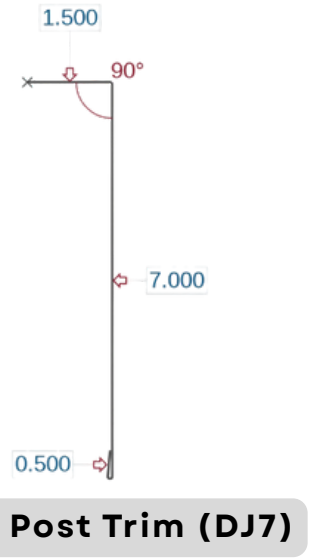
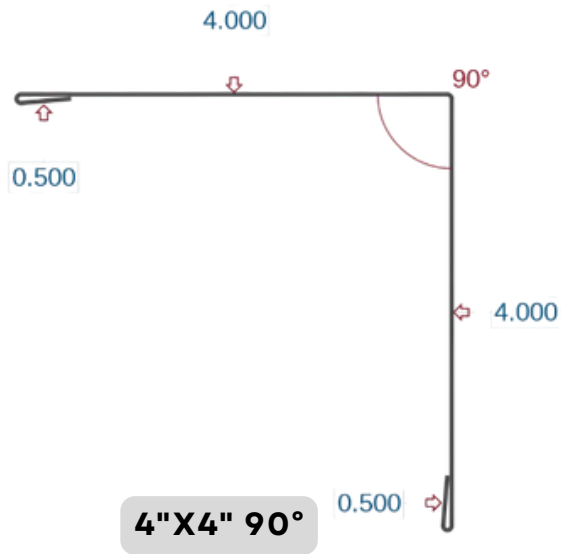
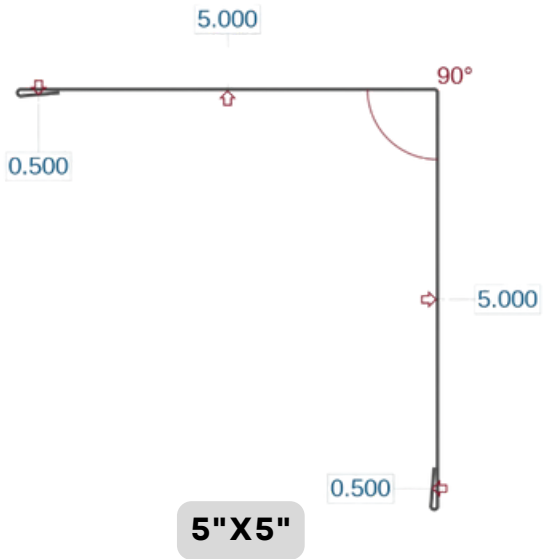

Outside Angle 2" X 2" (OA2)

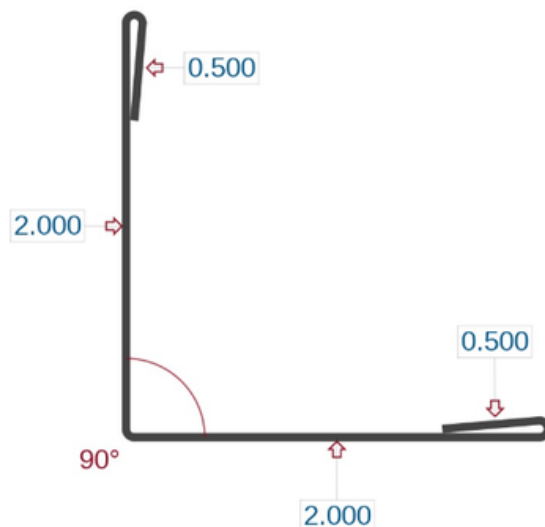

Sliding Door



Door Stop

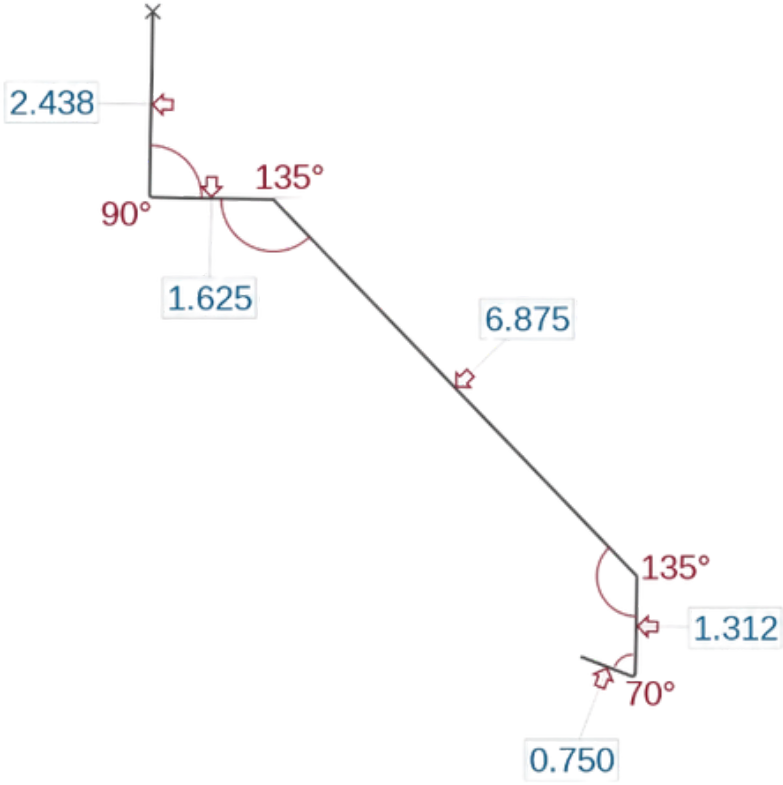

Round Track Covers (CTC)

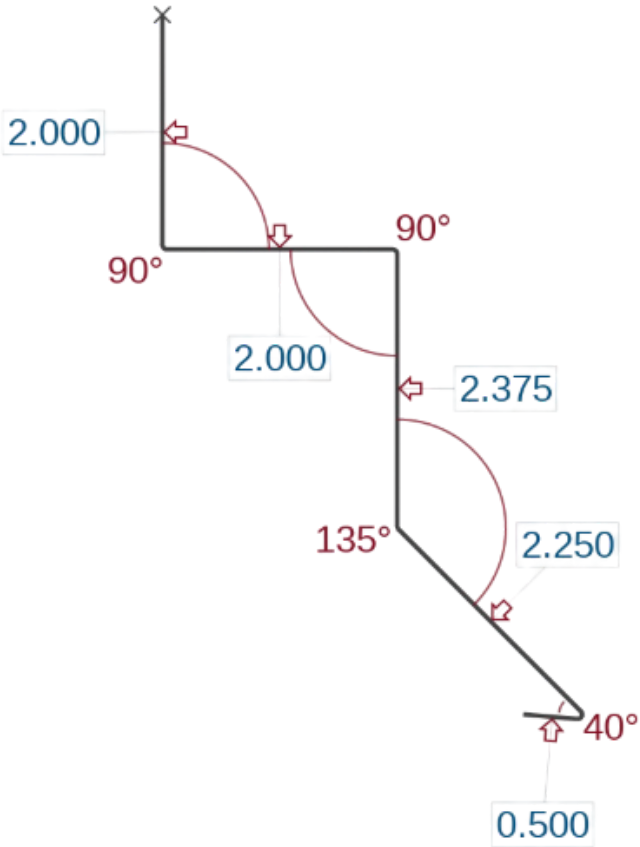

Square Track Covers (NTC)

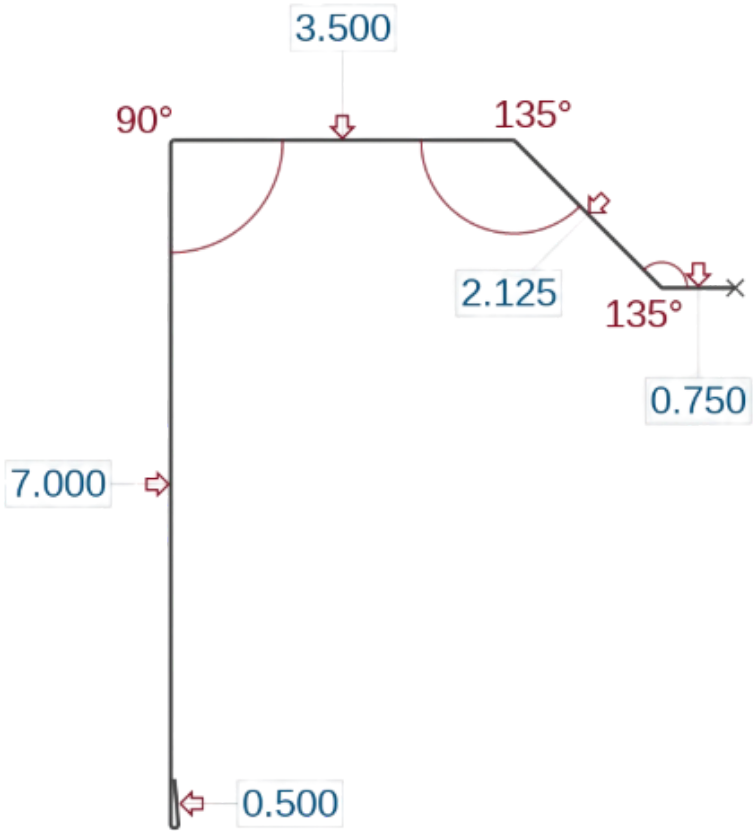

Track Door Jamb (TDJT)

Snow Guard's

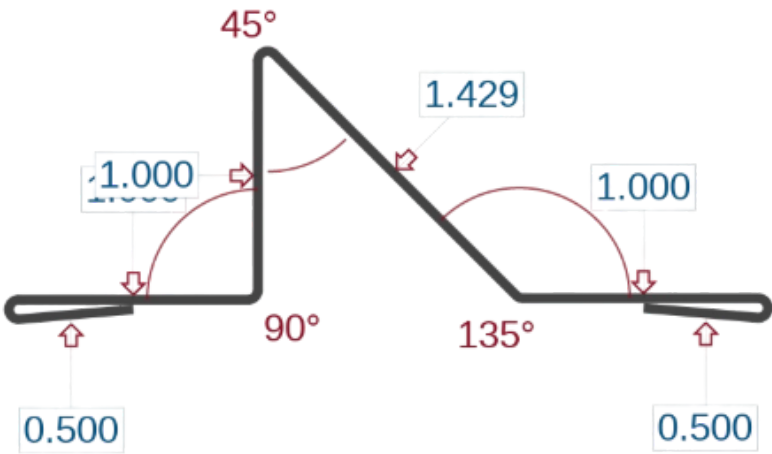

Exposed Fastener Snow Guard 1"



Snow Defender 1500 16g 304 Powder Coated



Snow Defender 4500 16g 304 Powder Coated



Snow Defender 85RF 304 Powder Coated for Standing Seam



Snow Defender PC240 Clear Poly

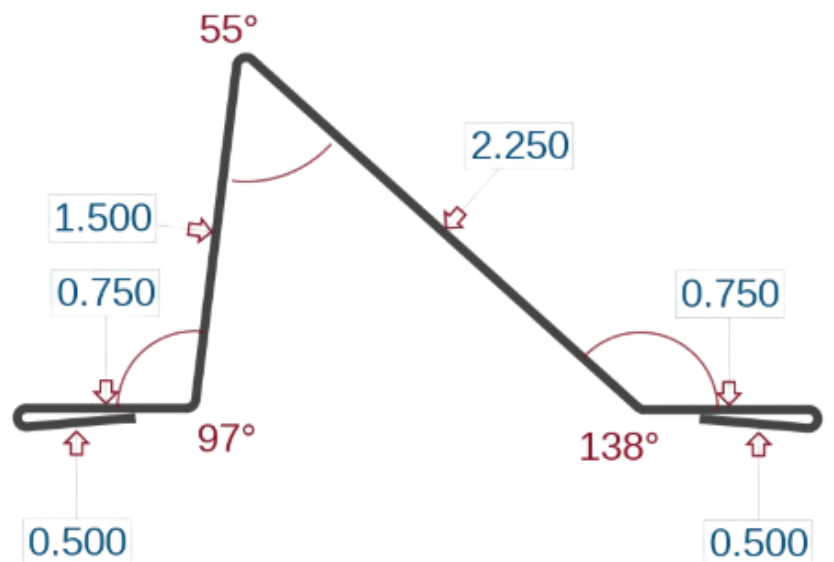

Snow Guard (SG)

Valley Trim

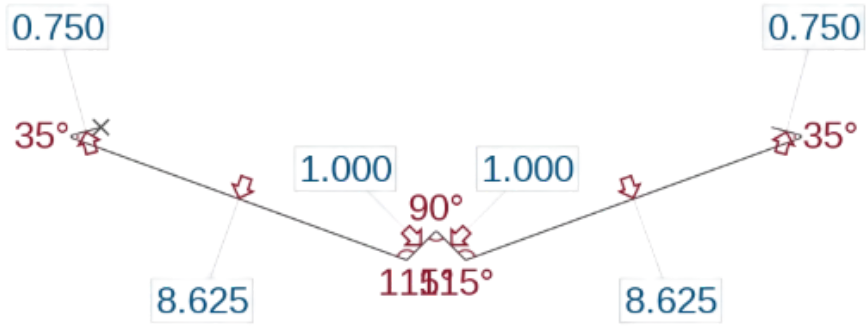

Open Valley Trim (VT2)

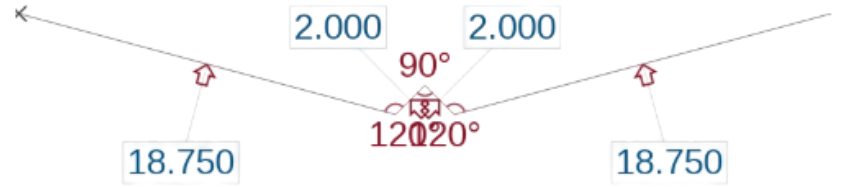

Extended Valley (EVA)

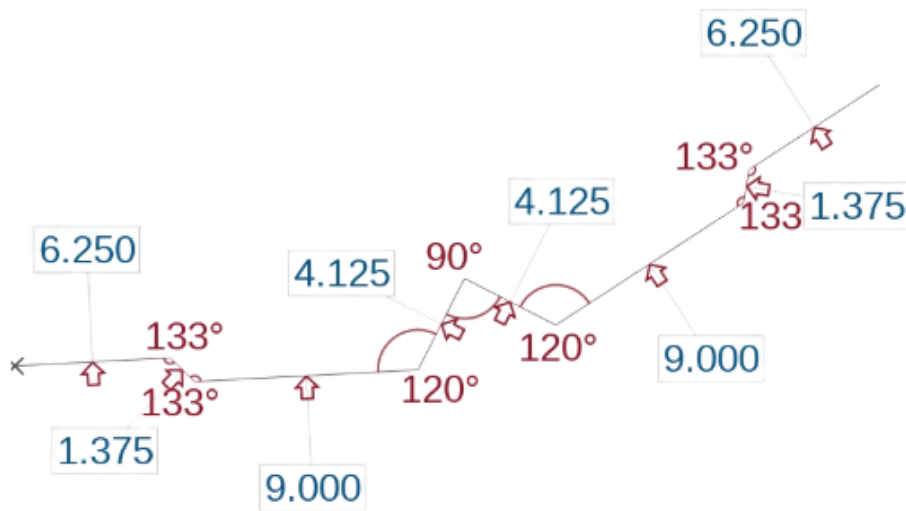

High Valley (HVAL)

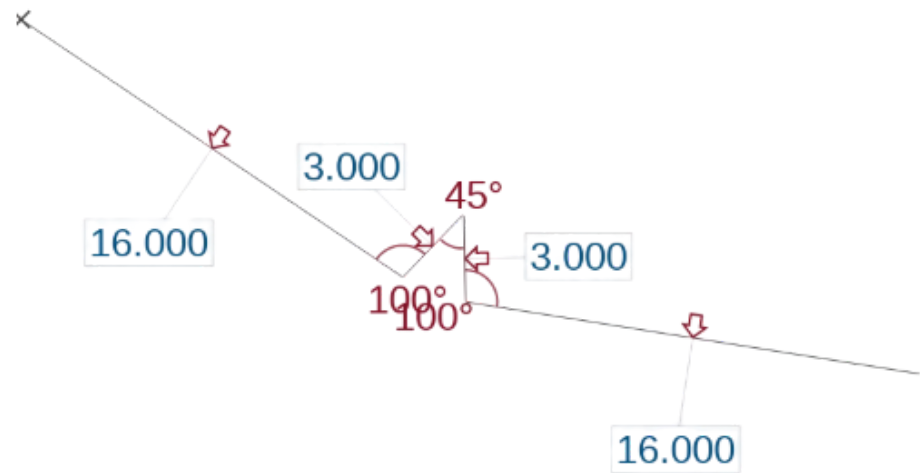

Low Valley (LVAL)

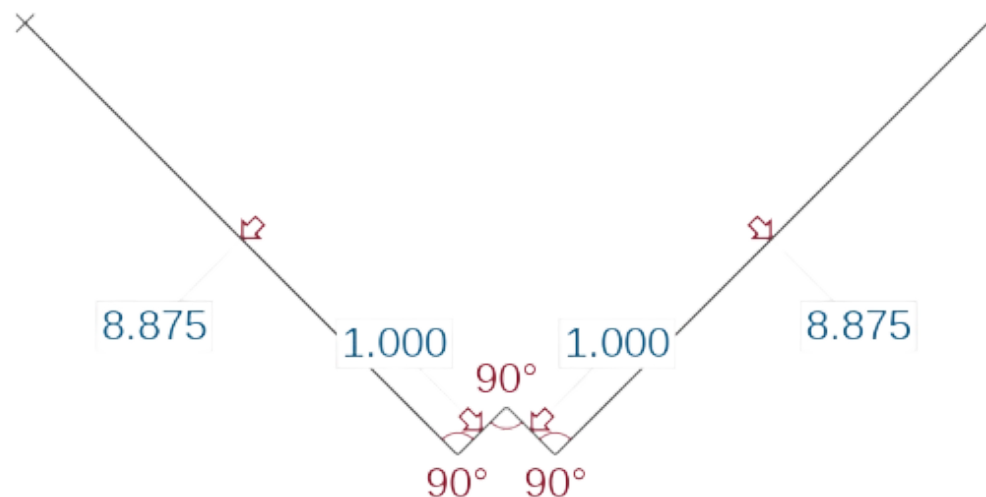

Valley Trim NO HEM (VT)

Shingle Style Drip Edge

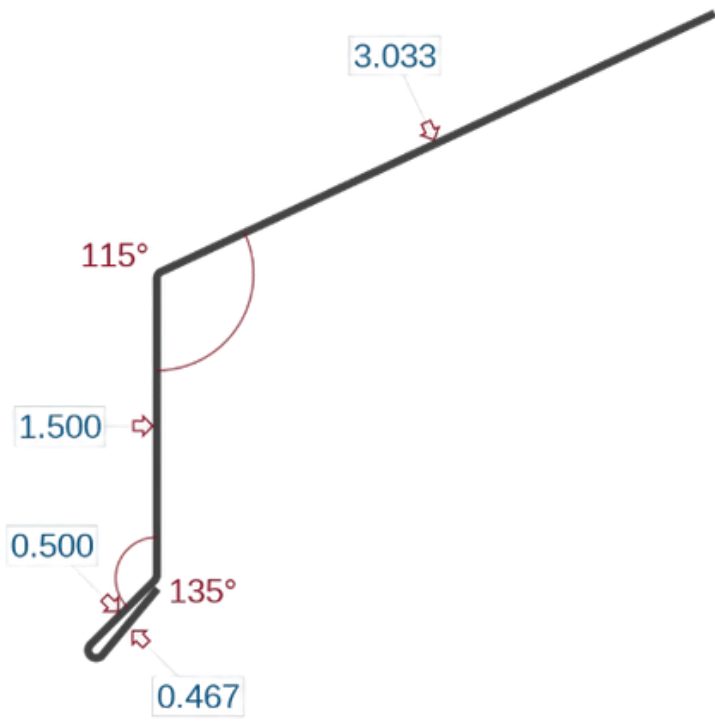

A Style Drip Edge

Sidewall

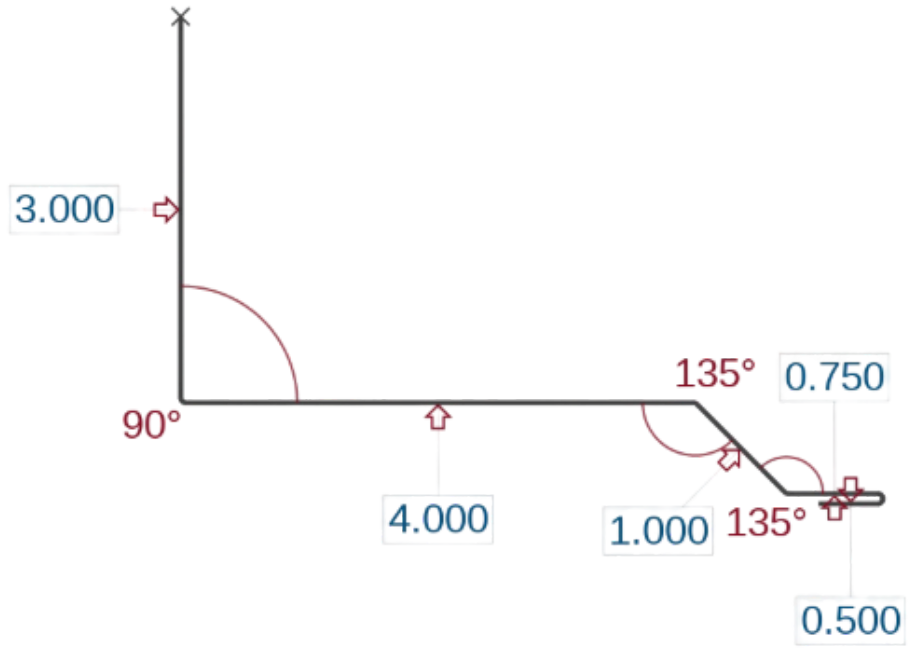

Universal Sidewall (SWT)

Window Drip Cap

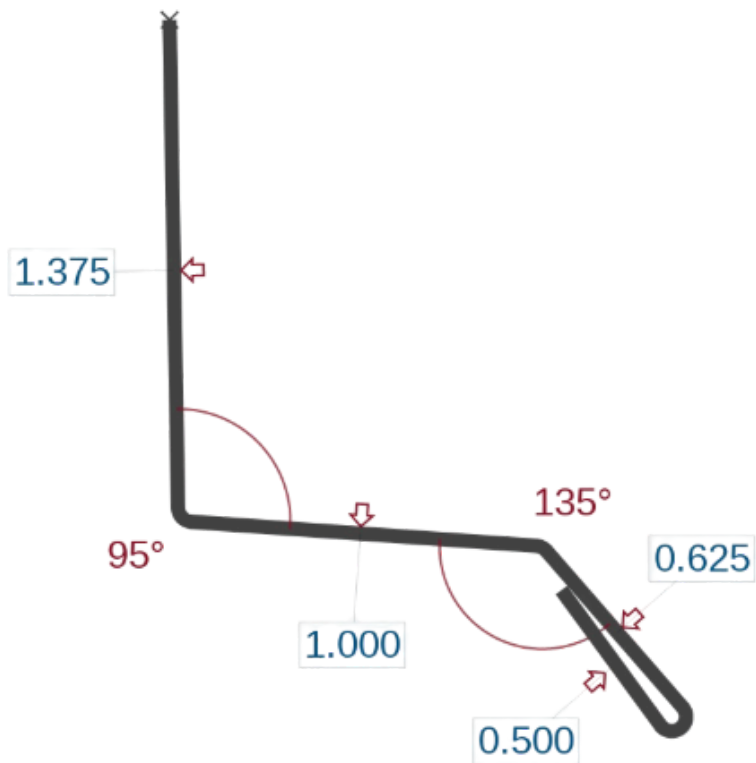

Window Drip Cap (WC)

ZEE Closures

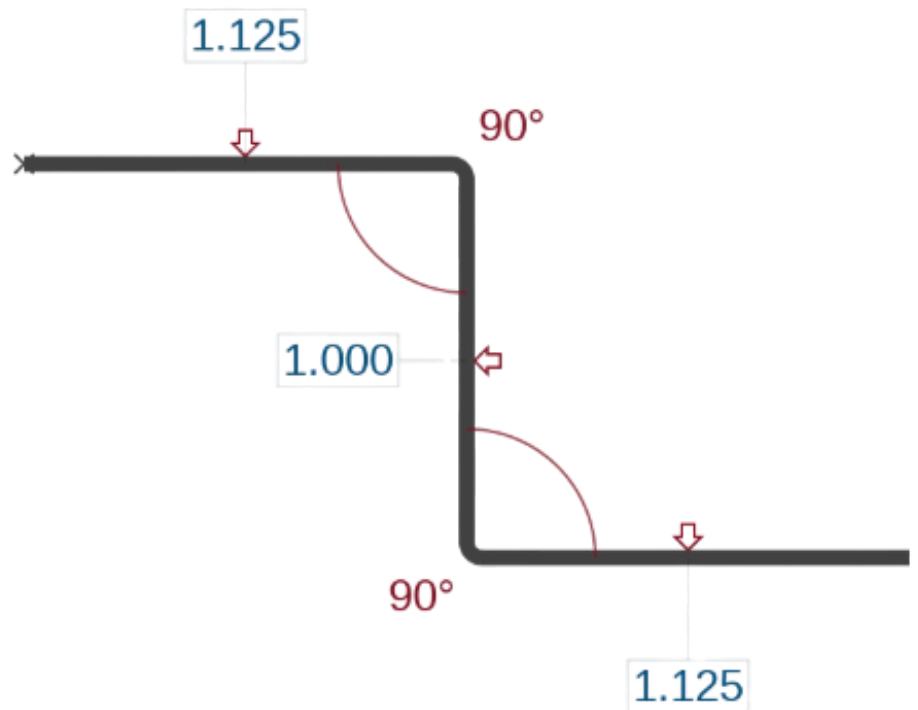

ZEE Closures (HLZC)