



**CASTELLANOS**  
**DRAPERY HARDWARE**



AUTHORIZED DEALER AND

★★★ PLATINUM

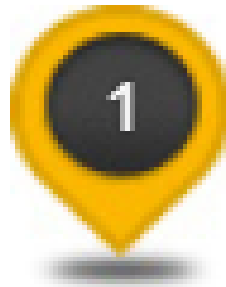

Everything in Hardware for Shades, Drapes, and Textiles  
2573 NW 74th Ave. Miami, FL 33122  
T: (305) 597-8671 F: (305) 597-8673  
info@megamarinc.com www.castellanosdraperies.com



# GENERAL TECHNICAL INFORMATION



RTS is the abbreviation for RADIO TECHNOLOGY SOMFY. This is a wireless home automation control system by which radio waves are transmitted from a remote control, or wall switch to operate motorized window coverings and by pressing a button or wireless wall switch, it sends out a radio wave signal to move any motorized interior or exterior window covering with is. There is no need to point or aim the transmitter because RTS is omnidirectional and operates within a range of up to 65 feet.



The Somfy mylink offers convenient control of any RTS motorized application with a smartphone or tablet. Transform your experience with this simple plug-in device and free app that allows you to speak natural voice commands to control your RTS connected solutions. The myLink puts you in control so that you can operate your motorized applications whether you'r home or not.

POWER  
SOLUTIONS  
OPTIONS  
VOLTAGE

**DC = Low Voltage    AC= Line Voltage**



### RS485 (Serial Communication)

- Each motor has its own address
- Encoder based precision positioning +/- 1/16"
- 16 intermediate positions available
- Wiring compatible with competitive motors

**DRY CONTACT**

### DCT (Dry Contact)

- Dry contact control
- Wires directly to switch or automation system
- Limit setting tool needed to set limits

THE CONCEPT  
OF TORQUE

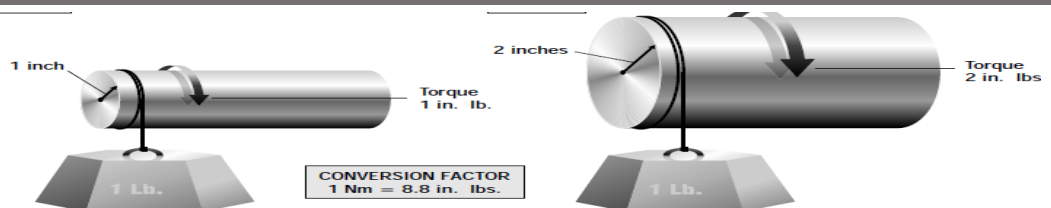

# SOMFY R28 RTS - WIRELESS



## Dimensions - in. (mm)

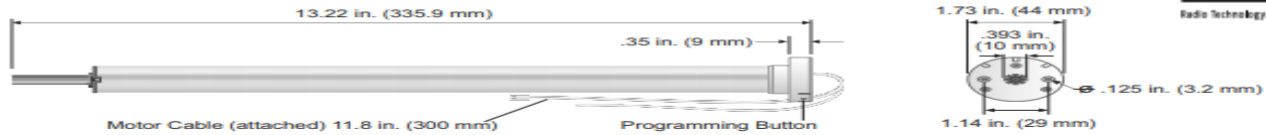

Performances	Roll Up W R28 RTS	Fabrication Recommendations
Voltage	12V DC	• Minimum roller tube inside diameter is 26.6 mm.
Torque	1.1 Nm	• Aluminum or steel tubes can be used.
Thermal Protection	2.5 minutes	• Somfy requires Energizer® Lithium batteries #L91 that provide patented safety protection.
Over Current Protection	2 amps	
*Sound Level	48 dBA - 56dB	
Speed	28 rpm	
Radio Frequency for RTS	433.42 MHZ	

\* According to standards ISO 3741 NF 31022 in dB(A) re

**CHARACTERISTICS:** Replaced the LT30 RTS motor. One of the greatest benefits of the R28 is that can be powered by a 12v DC solar recharging battery. They are designed for roller shades. The R28 can lift 8 lb on a 1.5" tube and can be used on shades up to 85" x 110" depending on the weight of the materials.

## STANDARD BRACKET COMPONENTS FOR ROLLESE R OR SKYLINE SERIES

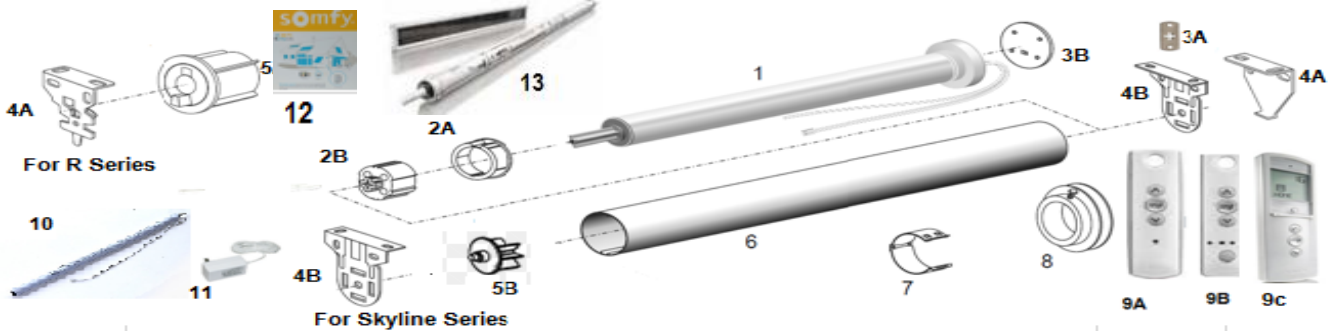

DESCRIPTION		
1	SOMFY-1002481	Motor R28 RTS
2A	SOMFY-9018475	Crown for 1.5" - 38mm
2B	SOMFY-8018477	Drive for 1.5"-38mm
3A	SOMFY-R8	Cross Adapter
3B	ROLL-SLAMLS40BK	Adapter Skyline
4A	ROLL-RB360	Bracket R8 1 1/2" Zinc (Pair)
4B	ROLL-SLB660	Brck for SkylineC:Black,White,Brown,Zinc-Each
5A	ROLL-REP53W	End Plug White for 1 //2"-Rollease R Series
5B	ROLL-SLPEV653	Pin End for Skyline-White, Black, Grey
6	TUBE 1.5"	For 1.5" or 38mm - 19'
7	ROLL-RRTC15	Clip Tube 1 1/5"-To be used with Romans
8	ROLL-CS4US	Spool tube roller 1 1/2"-To be used with Romans
9A	SOMFY-1810632	Telis 1 Channel RC
9B	SOMFY-1810633	Telis 4 Channel RC
9C	SOMFY-1811081	Telis 16 Channel RC
10	SOMFY-9018685	Battery Wand-Reloadable
11	SOMFY-1822445	Plug in power > than 60"x60"
12	SOMFY MYLINK 1811403	MyLink
13	SOMFY-9019235	Solar Recharge Kit with batteries



Castellanos Drapery Hardware

# SONESSE 30 Li-ion RTS - WIREFREE



BY **somfy**

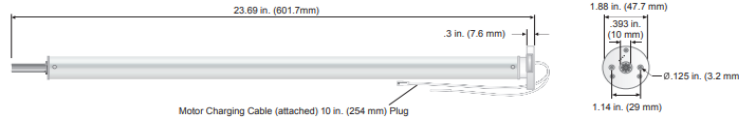

The Sonesse 30 Li-ion benefits are: build-in rechargeable battery to minimize maintance, no wires needed-Adjustable speed and a 2Nm strong power lifting capacity. It is designed for silence and simplicity with RTS voice control. Applications include: Roller/Solar, Sheer/Layered, Roman/Woven Shades as well as Horizontal Blinds

## Specifications

Voltage	12V DC
Torque	2 Nm
Sound Level	44 dBA
Speed	10-28 rpm adjustable
Low Battery Indicator	LED
Radio Frequency for RTS	433.42 MHZ

## Technical Features

<b>Voltage Supply</b>	12V DC
<b>Index Protection Rating</b> (interior use only)	IP 20
<b>Limit Switch Type</b>	Electronic

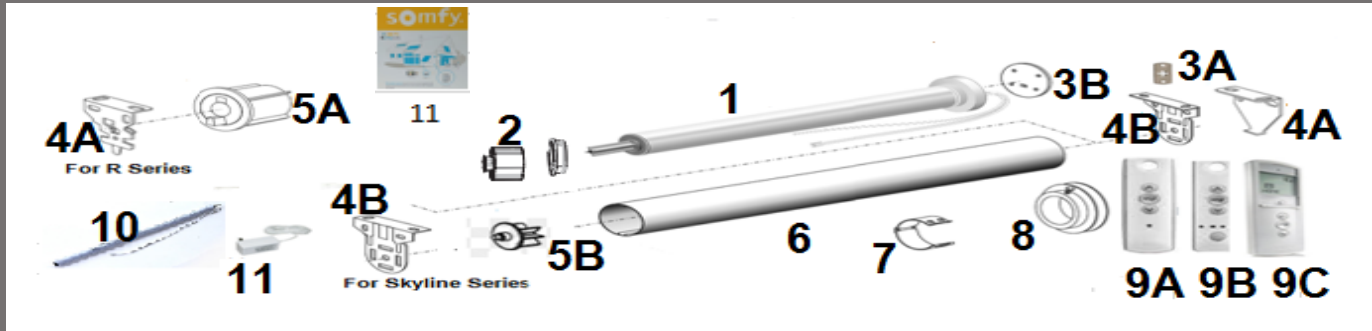
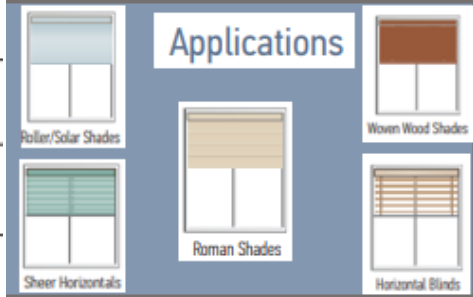

## PARTS AND ACCESSORIES

1	SOMFY-1003128	Sonesse 30 Li-ion RTS
2	SOMFY-9013775	Rollease Crown & Drive Set
3A	SOMFY-R8	Cross Adapter
4A	ROLL-RB360	Bracket R8 1 1/2" Zinc-Pair
5A	ROLL-REP53W	End Plug White for 1/2"-Rollease R Series
3B	ROLL-SLAMLST30W	Adapter Skyline for SOMFY ST30
4B	ROLL-SLB660	Bracket for Skyline C:Black,White,Brown,Zinc (Each)
5B	ROLL-SLPEV653	Pin End for Skyline- White, Black, Grey
6	TUBE 1.5"	For 1.5" or 38mm - 19'
7	ROLL-RRTC15	Clip Tube 1 1/5"-To be used with Romans
8	ROLL-CS4US	Spool tube roller 1 1/2" To be used with Romans
9A	SOMFY-1810632	Telis 1 Channel RC
9B	SOMFY-1810633	Telis 4 Channel RC
9C	SOMFY-1811081	Telis 16 Channel RC
10	SOMFY-1822209	Wall Mount Power Supply 24V DC
11	SOMFY MYLINK 181140	MyLink



Castellanos Drapery Hardware

# SOMFY SONESSE ST 30 RTS



Dimensions - in. (mm)



**Characteristics:** The ST30 RTS is engineered with superior noise reduction technology at 44 dBA  
**Low voltage wiring 24 VDC.** -Fully compatible with all RTS controls and accessories.-Torque 17.7in / Lbs 2Nm  
**Applications:** Roller/solar shades, Roman shades, Woven wood shades, Venetian Blinds, Sheer horizontal Cellular/Pleated shades. **Benefits:** Quiet operation, No electrician required, Easy installation.  
 Sonesse ST30 is ideal for tubes as small as 1.5" diam.- Speed: 6 -28 rpm - Weight approx: 1.5lbs  
**Lift capacity:** If using 1.5" tube, up to 17.6lbs. If 2.0" tube, up to 13.2lbs, If 2.5" tube up to 11.lbs  
 The range of RTS can be of 65' or two concrete walls.

## STANDAR BRACKET COMPONENTS FOR R SERIES

## STANDARD BRACKETS COMPONENTS FOR SKYLINE SERIES

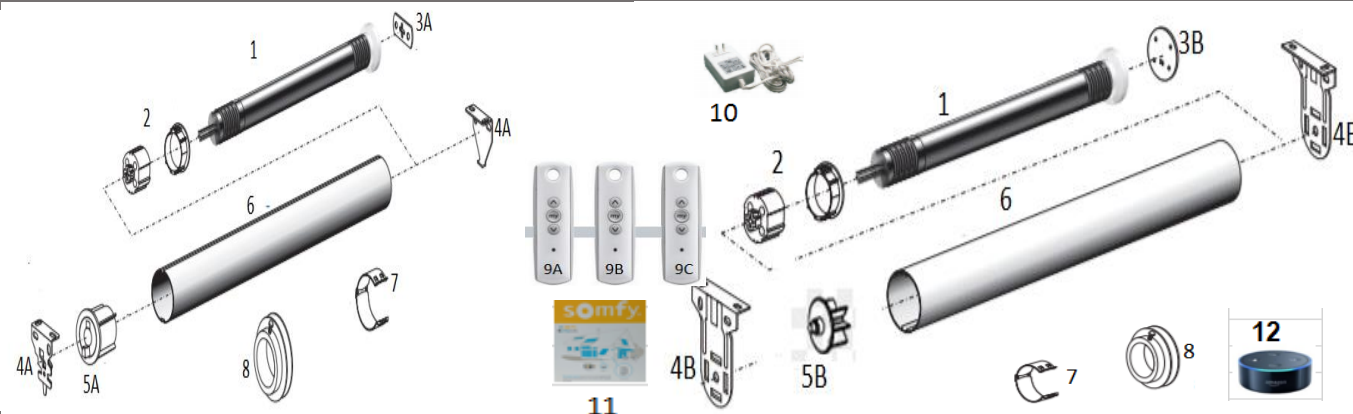

### DESCRIPTION

1	SOMFY-1001524	Sonesse ST30 RTS
2	SOMFY-9013775	Rollese Crown and Drive set for ST30
3A	SOMFY-R8	Cross Adapter
4A	ROLL-RB360	Bracket R8 1 1/2" Zinc-Pair
5A	ROLL-REP53W	End Plug White for 1/2"-Rollese R Series
3B	ROLL-SLAMLST30W	Adapter Skyline for SOMFY ST30
4B	ROLL-SLB660	Bracket for Skyline-C:Black,White,Brown,Zinc (Each)
5B	ROLL-SLPEV653	(Pin End for Skyline) White, Black, Grey
6	TUBE 1.5"	For 1.5" or 38mm 19'
7	ROLL-RRTC15	Clip Tube 1 1/5"-To be used with Romans
8	ROLL-CS4US	Spool tube roller 1 1/2"-To be used with Romans
9A	SOMFY-1810632	Telis 1 Channel RC
9B	SOMFY-1810633	Telis 4 Channel RC
9C	SOMFY-1811081	Telis 16 Channel RC
10	SOMFY-1822209	Wall Mount Power Supply 24V DC
11	SOMFY MYLINK 1811403	MyLink
12	Alexa -echo -dot	Alexa -echo -dot



Castellanos Drapery Hardware

# SOMFY SONESSE 40 RTS-404S2

**CHARACTERISTICS:** The Sonesse 40 RTS 404S2 is for interior applications, it requires a min of 40mm tube and can also be used with the 2" tube. It is used for all screen and roller blinds as well as large-size wood or aluminum Venetian blinds. Power cord is included. **LIFT CAPACITY:** If a 40mm tube is used"= up to 35lbs; if a 2" tube is used: up to 27lbs.



**Dimensions**

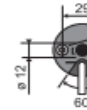
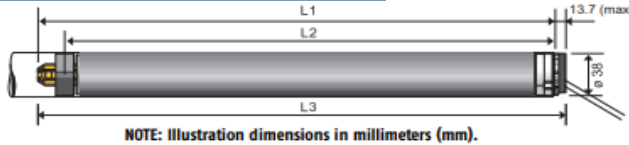

2 holes for self tapping mounting screws (diameter: 4mm, depth: 9.4 mm)

Self tapping mounting screws are included with each motor.

Dimensions	404S2	Performances	404S2
L1	19.84 in. (504 mm)	Torque	4Nm
L2	18.90 in. (480 mm)	Nominal Voltage	120V / 60Hz
L3	20.35 in. (517 mm)	Rated Current	.95A
Cable Length	11.5 ft. (3.5m)	Speed	36rpm
		Thermal Protection	4 minutes
		Radio Frequency	433.42 MHz
		Sound Level	42dBA

The Sonesse 40 RTS is a very versatile motor. It can be used with different tubes by using the right adaptor. For double rollers by using double brackets or it can align two tubes by using the correct coupler. Fascia 3" and 4" can be used. Ask a Castellanos representative for more information in parts and components.

**BRACKET COMPONENTS FOR SKYLINE SYSTEM**

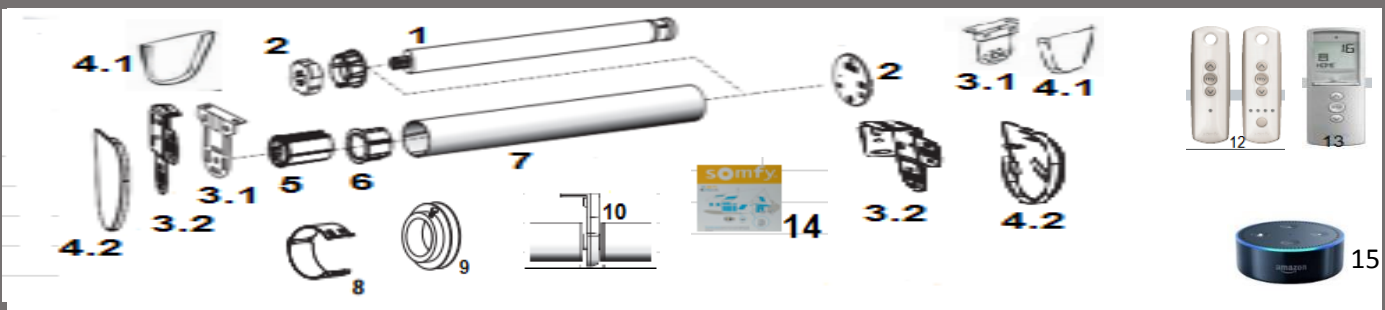

**Parts & Accessories for Skyline**

1	SOMFY-1001636	Sonesse 40 RTS 404S2 4
2	ROLL-RTA5LS40	Crown, Driver and Adapter
3.1	ROLL-SLB660-680	Sky.single bracket- 680 to projec
3.2	ROLL-SLDB38-SLDB48	Sky-dbl bracket
4.1	ROLL-SLBC660-680	Sky-single-bkt cover
4.2	ROLL-SLDBC38-48	Sly-double bkt cover
5	ROLL-SLPEHD53W	Pin End Sky Heavy Duty 1 1/2"
6	ROLL-RA2/RA225	Idler Adap.(clutch) if 2" - 2.5" tube
7	ROLC-RS-013	2" TUBE 16'
8	ROLL-RRTC2	Clip Tube 2.0" For Romans
9	ROLL-CS5US	Spool Tube roller 2" For Romans
10	ROLL-RB41	Bkt Sky Medium Link
11	ROLC-RS-886	Ultra Index Coupler
12	SOMFY-181632-633	Telis 1/ Telis 4 Channel RC
13	SOMFY-1810081	Telis 16 Channel RC
14	SOMFY MYLINK 1811403	MyLink
15	ALEXA - echo -dot	ALEXA - echo -dot



Castellanos Drapery Hardware



# SOMFY LT50 - ALTUS RTS ULTRA 525A2



The ALTUS LT50 RTS is suitable for pre-and post- construction opportunities and can be controlled with any RTS accessory, including hand held remote controls, wireless wall switches and timers. It can be used in outside and inside mount installations. This motor features rapid push button limit adjustment for easy settings. Applications: Rolling shutter-Retractable Awnings-Blinds-Ext. Solar Screen-Shades

## Dimensions

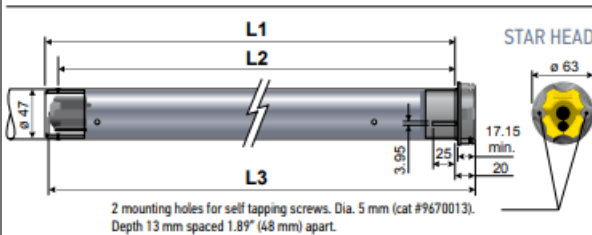

## Dimensions

	525
L1	25.79 in. (655 mm)
L2	25.20 in. (640 mm)
L3	26.10 in. (663 mm)
Cable Length	12.3 ft. (3.75 m)

## Specifications

	525
Torque	25 Nm
Nominal Voltage	120V/60Hz
Rated Current	1.6A
Speed	20 rpm
Thermal Protection	5 minutes
Radio Frequency	433.42 MHz

## SOMFY 2" SYSTEM

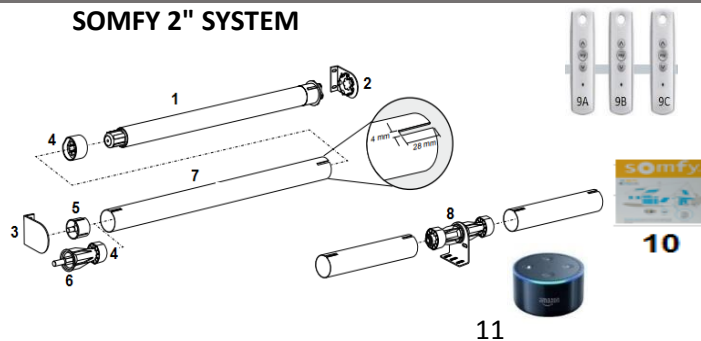

## ROLLEASE SILENT PIN SYSTEM

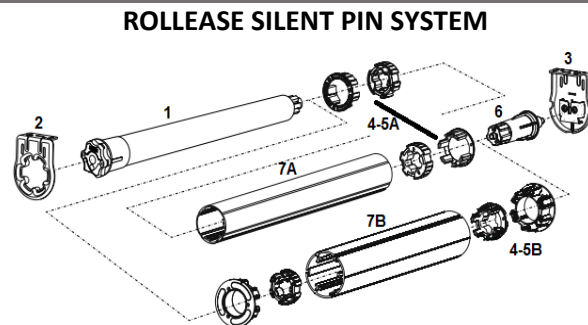

## DESCRIPTION

1	SOMFY-1001809 - Sonesse 50 RTS 506S2 - Star He	1	SOMFY-1001809 - Sonesse 50 RTS 506S2 SH
1	SOMFY-1001806 - Sonesse 50 RTS 506S2 RH - Rou	1	SOMFY- 1001806 -Sonesse 50 RTS 506S2RH
2	SOMFY-9410651 - LT50 Universal Motor Bracket	2	ROLL-MSBM6 - Sonesse 50 Motor Brkt Wh/Zn
3	SOMFY-9410635 - LT50 Idler Bracket w/10mm Ho	3	ROLL-MSBI6 - Idler Brk Sonesse 50
4	SOMFY-9206088 - 2" Round LT50 - Hard Clip	4-5A	ROLL-RTA6U50 Crown/Drive Adapt for 2.5"
5	SOMFY-9013592 - 2" collapsible End Cap (Silent)-	4-5B	ROLL-RTA7U50 Crown/Drive Adapt for 3.25"
6	SOMFY-9420800 - 2" Universal End Cap-Collapsib	6	ROLL-MSPE5BK Silent Pin End Mtr Shade 2"
7	ROL-RS-013 (2" TUBE 16')	7A	Tube 2"- 50mm 19'
8	SOMFY-9410648 - LT50 2" Universal Intermediate	7B	Tube 2.50"-63mm 19'
9A	SOMFY-1810632 (Telis 1 Channel RC)	7C	Tube 3.25"-83mm 19'
9B	SOMFY-1810633 (Telis 4 Channel RC)		
9C	SOMFY-1811081 (Telis 16 Channel RC)		
10	SOMFY MYLINK 1811403		
11	ALEXA - echo dot		



Castellanos Drapery Hardware



**SOMFY SONESSE ultra 506A2 Star Head - 506A2RH Round Head**



**SONESSE ULTRA 506A2 STAR HEAD**

**SONESSE ULTRA 506ARH ROUND HEAD**

SONESSE ULTRA 506A2 or 506ARH are the Ultra quiet and strongest motor solution for window covering. Provides 6Nm of Power & acoustic performance of less than 38 dBA. The most powerful quietest motor in the market with superior torque level which allows the motor to be installed for almost any application on the market. Up to six interior shades in unison. Can be suitable for residential or commercial applications.

**Dimensions**

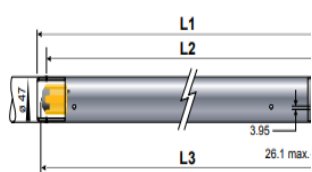

2 mounting holes for self tapping screws. Dia. 5 mm (cat #H) Depth 13 mm spaced 1.89" (48 mm) apart.

**Dimensions**

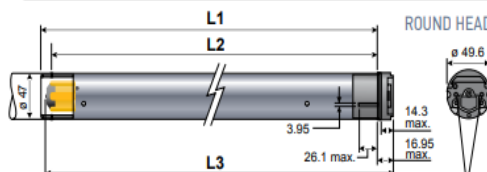

2 mounting holes for self tapping screws. Dia. 4 mm (cat #100405B). Depth 9 mm spaced 1.14" (29 mm) apart.

**Dimensions**

L1	31.8 in. (808 mm)
L2	31.3 in. (795 mm)
L3	SH 32.4 in. (823 mm) RH 32.3 in. (820 mm)
SJTW Power Cable Length	9.8 ft. (3 m)

**SOMFY 2" SYSTEM**

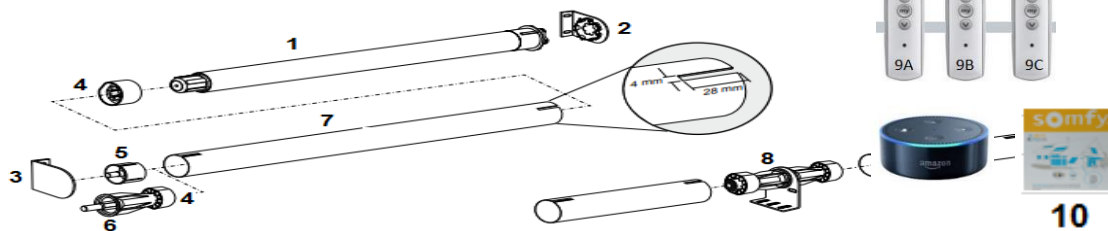

**PARTS AND ACCESSORIES**

1	SOMFY-1002562	Sonesse Ultra 506A2
1	SOMFY-1002562	Sonesse Ultra 506A3
2	SOMFY-9410651	LT50 Universal Motor Bracket
3	SOMFY-9410635	LT50 Idler Bracket w/10mm Hole Nylon Bearing
4	SOMFY-9206088	2" Round LT50 - Hard Clip
5	SOMFY-9013592	2" collapsible End Cap (Silent) -10mm Shaft
6	SOMFY-9019716	Idle End for Quiet Motor
7	ROLC-RS-013	2" TUBE 16'
8	SOMFY-9410648	LT50 2" Universal Intermediate Bracket Kit
9A	SOMFY-1810632	Telis 1 Channel RC
9B	SOMFY-1810633	Telis 4 Channel RC
9C	SOMFY-1811081	Telis 16 Channel RC
10	SOMFY MYLINK 1811403	MyLink
11	ALEXA echo - dot	ALEXA echo - dot

**Sonesse® ULTRA 50 AC**

- ≤ 38 dBA ULTRA Quiet
- 6 Nm
- 24 rpm
- 120 VAC - 60 Hz
- CE | TS | c-UL US



Castellanos Drapery Hardware





SOMFY SONESSE 50RTS 506S2 Star Head - 506S2RH Round Head



SONESSE 50RTS 506S2 STAR HEAD



SONESSE 50 RTS 506S2RH ROUND HEAD

The Sonesse 50 RTS (506S2-SH or 506S2RH) can be used for different applications. Ideal for large shades and interior applications. Torque 6Nm - 32 rpm. Dimensions: L=26.20" x 2.25" diam. It uses a minimum tube of 2.00" and wider tubes with proper adapters. It can be mounted in ceiling or wall. Maximum shade" W=144"x144" and maximum lift: 48 lbs.

Dimensions

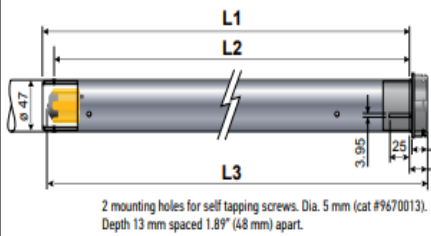

Dimensions

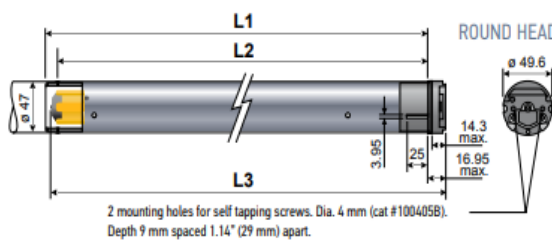

Dimensions 506

L1	25.7 in. (653 mm)
L2	25.2 in. (640 mm)
L3	SH 26.2 in. (666 mm) RH 26.1 in. (663 mm)
Cable Length	6.5 ft. (2 m)

SOMFY 2" SYSTEM

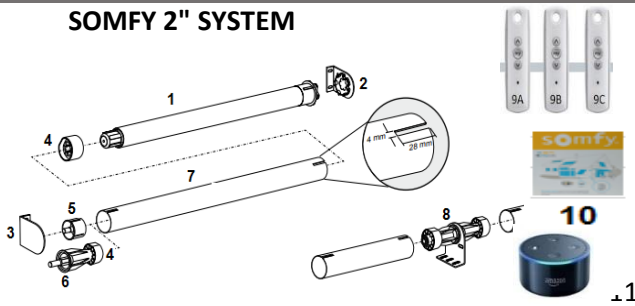

ROLLEASE SILENT PIN SYSTEM

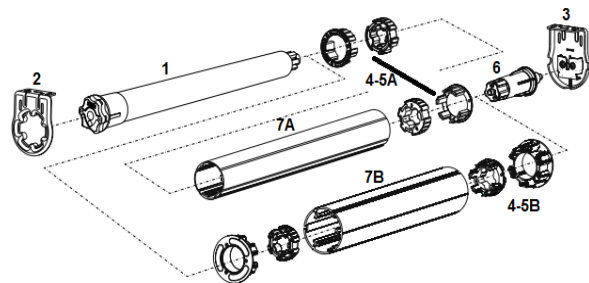

DESCRIPTION

1	SOMFY-1001809 - Sonesse 50 RTS 506S2 - Star He	1	SOMFY-1001809 - Sonesse 50 RTS 506S2 SH
1	SOMFY-1001806 - Sonesse 50 RTS 506S2 RH - Rou	1	SOMFY- 1001806 -Sonesse 50 RTS 506S2RH
2	SOMFY-9410651 - LT50 Universal Motor Bracket	2	ROLL-MSBM6 - Sonesse 50 Motor Brkt Wh/Zn
3	SOMFY-9410635 - LT50 Idler Bracket w/10mm Ho	3	ROLL-MSBI6 - Idler Brk Sonesse 50
4	SOMFY-9206088 - 2" Round LT50 - Hard Clip	4-5A	ROLL-RTA6U50 Crown/Drive Adapt for 2.5"
5	SOMFY-9013592 - 2" collapsible End Cap (Silent)-	4-5B	ROLL-RTA7U50 Crown/Drive Adapt for 3.25"
6	SOMFY-9420800 - 2" Universal End Cap-Collapsib	6	ROLL-MSPE5BK Silent Pin End Mtr Shade 2"
7	ROLC-RS-013 (2" TUBE 16')	7A	Tube 2"- 50mm 19'
8	SOMFY-9410648 - LT50 2" Universal Intermediate	7B	Tube 2.50"-63mm 19'
9A	SOMFY-1810632 (Telis 1 Channel RC)	7C	Tube 3.25"-83mm 19'
9B	SOMFY-1810633 (Telis 4 Channel RC)		
9C	SOMFY-1811081 (Telis 16 Channel RC)		
10	SOMFY MYLINK 1811403		
11	ALEXA - echo dot		





# GLYDEA 35e RTS



Castellanos Drapery Hardware

## Motorized track main characteristics

	Glydea® 35e
Power supply	110V AC 50/60 HZ
Amperage	0.5 A
Average linear speed	4.9"/s - 7.86"/s
Power consumption	60 W
Power cable type	3-wire cable with molded NEMA plug 4-wire cable (wired version only)
Control connector type	RJ12
DCT control circuit voltage	3.3 VDC
Motor sound level	< 44 dB(A)

Certifications	c TUV us, CE
Track maximum length	32 ft (9.7 m)
Maximum number of splices	2
Minimum bending radius	11.8 in. (30 cm)
Minimum curving radius	118 in. (300 cm)
Side opening max weight	77 lbs 35 kg
Center opening max weight	77 lbs 35 kg
Tandem alternative (see page 21)	154 lbs / 70 kgs 64 ft / 19.4 m



GENERAL



RIPPLEFOLD



PINCH PLEAT

Somfy Glydea 35e RTS is a motor designed specifically for draperies including Pinch Pleat, Ripplefold and Accordia. Advantages: Easy to conceal behind fabric, its adjustable limit setting provides precise alignment of drapery, minimize light gaps, soft start and stop motion, easy installation (wall and ceiling mount), the motor can be installed to the right or left. Automatic or adjustable limit setting. The tracks can be bended and curved; please contact our expert at Castellanos.

### DESCRIPTION

		DESCRIPTION
1	Somfy-1001615	Glydea 35e RTS w/10" plug Motor with 35Kg or 77.16Lbs capacity.(L=11.45" W=3.66")
2	Somfy-1780945	Glydea Drive Pulley Pulley assembly to use on the motor side
3	Somfy-1780898	Glydea Pulley Cover Pulley Cover
4	Somfy-1782318	Glydea Small Pulley Small pulley to be used in one way
5	Somfy-1780899	Glydea Rail 1 Rail can be used up to 192" or 16ft or 4.88mt
6	Somfy-1782084	Glydea Belt 2 times the length of the track is necessary
6-1	Somfy-1781344	Master Carrier Assembly 1 for one way and 2 for CO
7	Somfy-1780906	Swivel Ceiling Bracket 2 - Swivel ceiling bkt to minimize light gap
8	Somfy-1780907	One Touch Ceiling Bracket 2 easy posit.of the fix holes and snap on mounting of track
9	Somfy-1780909	4.5"-6" Projection Adj sing Adjustable Wall Mount Bracket (2)
10	Somfy-1780910	8.75"-10.25" Proj. Double Adjustable Double Wall Mount Bracket
11	Somfy-1782316	Straight Rail JOINT For spliced tracks under 16 feet
12	Somfy-1782320	Overlap Arm 1 Way For PP & RF one way - 1 per drapery track
13	Somfy-1782321-2	Overlap Arm CO- PP RF 1 Overlap and 1 Straigh per drapery track
14	Somfy-1780901-02	120%-100%-80% Runners 120%=7 per ft-100%=6 per ft - 60%=5 per ft
15	Somfy-1780905	Return Snap RF 2 if one way or 4 if CO - RF only
16	Somfy-1780953	RF-CO butt masters arms 2 per drapery track required
17	Somfy-1782319	RF- One way butt Arm 1 per track required
18	KSF-9003-25-1	Ripplefold Snap Tape 1" Snap Tape for Ripplefold
19	Somfy-1780947	One Way Overlap Uni-large Overlap arm 1 per track for PP
20	Somfy-1781415	Eyelet runner For PinchPleat uses 3 carriers per foot or 10 mt
21	Somfy-1782662	Straight Arm Kit for PP Straight arm 1 per track for PP
22	Somfy-1780895	Return Hook PP 2 if one way or 4 if CO - Pinch Pleat only



## Motorized track main characteristics

	Glydea® 35e
Power supply	110V AC 50/60 HZ
Amperage	0.5 A
Average linear speed	4.9"/s – 7.86"/s
Power consumption	60 W
Power cable type	3-wire cable with molded NEMA plug 4-wire cable (wired version only)
Control connector type	RJ12
DCT control circuit voltage	3.3 VDC
Motor sound level	< 44 dB(A)

Certifications	c TUV us, CE
Track maximum length	32 ft (9.7 m)
Maximum number of splices	2
Minimum bending radius	11.8 in. (30 cm)
Minimum curving radius	118 in. (300 cm)
Side opening max weight	77 lbs 35 kg
Center opening max weight	77 lbs 35 kg
Tandem alternative (see page 21)	154 lbs / 70 kgs 64 ft / 19.4 m

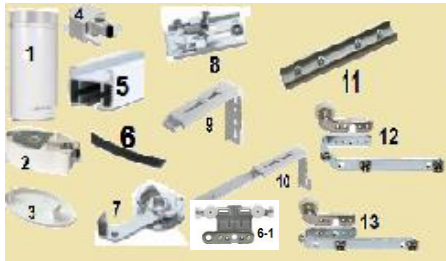

GENERAL



RIPPLEFOLD



PINCH PLEAT

Somfy Glydea 35e RTS is a motor designed specifically for draperies including Pinch Pleat, Ripplefold and Accordia. Advantages: Easy to conceal behind fabric, its adjustable limit setting provides precise alignment of drapery, minimize light gaps, soft start and stop motion, easy installation (wall and ceiling mount), the motor can be installed to the right or left. Automatic or adjustable limit setting. The tracks can be bended and curved; please contact our expert at Castellanos.

### DESCRIPTION

1	Somfy-1001617	Glydea 60e RTS w/10" plug	Motor up to 132 lbs capacity- 36ft
2	Somfy-1780945	Glydea Drive Pulley	Pulley assembly to use on the motor side
3	Somfy-1780898	Glydea Pulley Cover	Pulley Cover
4	Somfy-1782318	Glydea Small Pulley	Small pulley to be used in one way
5	Somfy-1780899	Glydea Rail	1 Rail can be used up to 192" or 16ft or 4.88mt
6	Somfy-1782084	Glydea Belt	2 times the length of the track is necessary
6-1	Somfy-1781344	Master Carrier Assembly	1 for one way and 2 for CO
7	Somfy-1780906	Swivel Ceiling Bracket	2 - Swivel ceiling bkt to minimize light gap
8	Somfy-1780907	One Touch Ceiling Bracket	2 easy posit.of the fix holes and snap on mounting of track
9	Somfy-1780909	4.5"-6" Projection Adj sing	Adjustable Wall Mount Bracket (2)
10	Somfy-1780910	8.75"-10.25" Proj. Double	Adjustable Double Wall Mount Bracket
11	Somfy-1782316	Straight Rail JOINT	For spliced tracks under 16 feet
12	Somfy-1782320	Overlap Arm 1 Way	For PP & RF one way - 1 per drapery track
13	Somfy-1782321-2	Overlap Arm CO- PP RF	1 Overlap and 1 Straigh per drapery track
14	Somfy-1780901-02	120%-100%-80% Runners	120%=7 per ft-100%=6 per ft - 60%=5 per ft
15	Somfy-1780905	Return Snap RF	2 if one way or 4 if CO - RF only
16	Somfy-1780953	RF-CO butt masters arms	2 per drapery track required
17	Somfy-1782319	RF- One way butt Arm	1 per track required
18	KSF-9003-25	Ripple Snap Tape	1" Snap tape for Ripplefold
19	Somfy-1780947	One Way Overlap Uni-large	Overlap arm 1 per track for PP
20	Somfy-1781415	Eyelet runner	For PinchPleat uses 3 carriers per foot or 10 mt
21	Somfy-1782662	Straight Arm Kit for PP	Straight arm 1 per track for PP
22	Somfy-1780895	Return Hook PP	2 if one way or 4 if CO - Pinch Pleat only



**ADDITIONAL PARTS**

Please contact a Castellanos' sales representative for other related products, color, size and use

**SINGLE BRACKETS**



ROLL-SLB660



ROLL-SLB680



ROLL-SLB660I

**COVERS**



ROLL-SLBC

**DOUBLE BRACKETS**



SLDB38W



SLDB48W



SLB660DBHW



SLB660DBV

**COVERS**



ROLL-SLDBC38

**UNIVERSAL BRACKETS**  
Universal Brackets are ideal for most window frames, as there's no need for a right and left style bracket. They are available in two sizes (38" & 48") with matching covers and intermediate brackets

**HORIZONTAL BRACKETS**  
Horizontal Brackets are better for heavier shades and wide window frames. Available for right and left mounts, they are perfect for wide window frames.

**VERTICAL BRACKETS**  
Vertical Brackets are thin, compact and reliable. Available for right and left mounts, they are great for narrow window frames.

**ADAPTER**



ROLL-RA2 FOR 2" TUBE

ROLL-RA25 FOR 2.5" TUBE

**TUBES**



Tube 1 1/2" 38mm



Tube Somfy Sonesse 40



Tube Somfy Sonesse 50



Tube 2" 50mm



Tube 2" 50mm  
19' - 1" Tape



Tube 2 1/2" 63mm  
19' - 1" Tape



Tube 3 1/4" 83mm  
19' - 1" Tape



**CASTELLANOS  
DRAPERY  
HARDWARE**





















Everything in Hardware for Shades, Drapes and Textiles  
2573 N.W. 74th Ave., Miami, FL 33122 • T: (305) 597-8671 F: (305) 597-8673  
info@megamarinc.com • www.castellanosdraperies.com

ITEM	DESCRIPTION	PHOTO
<b>WireFree™ MOTOR &amp; ACCESSORIES</b>		
SOMFY-1002481	Roll UP WireFree™ R28RTS 1.1 Nm (9.68) 28 RPM	
SOMFY-9018475	WireFree™ Crown for R28 1.5" (38mm) Tube each	
SOMFY-9018477	WireFree™ Drive for R28 1.5" (38mm) Tube each	
SOMFY-9018685	WireFree™ 12V DC, Reloadable Battery Wand (Batteries not included)	
SOMFY-1822445	12V DC Plug-In Power Supply with 3m(9.9') Cable for use with R27	
<b>Sonesse™ 30 MOTOR &amp; ACCESSORIES</b>		
SOMFY-1001524	Sonesse™ 30RTS®, 2 (17.7), 28 RPM	
SOMFY-9013775	RollEase® Crown and Drive Set, for Sonesse™ 30	
SOMFY-1822209	Sonesse™ 30, 24V DC, 1.66A, Wall Mount Power Supply	
<b>400 Series MOTOR &amp; ACCESSORIES</b>		
SOMFY-1001636	Sonesse™ 40 RTS®, 404S2, 4(35.2), 36 RPM	
SOMFY-9016654	400 Series Crown & Drive Set, Somfy® 40mm Round Tube	
<b>Sonesse™ 30 Li-Ion MOTOR &amp; ACCESSORIES</b>		
SOMFY-1003128A	Sonesse 30 WF Li-Ion RTS 20 RPM 2Nm	
SOMFY-9020674	Sonesse 30 WF Rollease1.5" Crown & Drive Set	
SOMFY-9020672	Sonesse 30 WF Plug-in Charger	



**CASTELLANOS  
DRAPERY  
HARDWARE**

ITEM	DESCRIPTION	PHOTO
<b>500 Series MOTOR &amp; ACCESSORIES</b>		
SOMFY-1002562	Sonessé™ ULTRA 506A2 RTS 6 Nm (52.8) 24 RPM	
SOMFY-1002564	Sonessé™ ULTRA 506A2 RTS RH 6 Nm (52.8) 24 RPM	
SOMFY-1001809	Sonessé™ 50 RTS® 506S2 6(52.8) 32 RPM	
SOMFY-1001806	Sonessé™ 50 RTS® 506S2RH 6(52.8) 32 RPM Round Head	
SOMFY-1043287	LT50 Altus RTS® ULTRA 525A2 25(220) 20RPM	
SOMFY-"R" Ser. Adapter	RollEase® "R Series" Bracket Adapter Can be used on RollEase® Brcket RB580	
SOMFY-9910017	LT50 RHY "LO" Plate with Stud (Silver)	
SOMFY-9206089	2" (47mm) Round Drive "Soft Clips" for 500 Series Brown	
SOMFY-9206088	2" (47mm) Round Drive "Hard Clips" for 500 Series Black	
SOMFY-9013592	2" Collapsible End Cap (Silent) 10mm Shaft for 500 Series	
SOMFY-9410648	LT50 2" Universal Intermedia Bracket Kit for 500 Series	
SOMFY-9410651	LT50 Universal Motor Bracket (50Nm max) for 500 Series	
SOMFY-9410635	LT50 Idler Bracket with 10mm Hole Nylon Bearing for 500 Series	
<b>ELECTRONICS CONTROLS</b>		
SOMFY-1810632	Telis 1 Channel, RTS® Trdansmitter, Pure	
SOMFY-1810633	Telis 4 Channel, RTS® Trdansmitter, Pure	
SOMFY-1811081	Telis 16 Channel, RTS® Trdansmitter, Pure	
SOMFY-1810813	DecoFlex WireFree™, RTS® Switch, 5 Channel, White	
SOMFY-1810872	Universal RTS Interface II (URTSI II-16 Channel) Conversts IR/RS232/RS485 to RTS®	
SOMFY-1870210	Lutron Translator	

**somfy**



**CASTELLANOS  
DRAPERY  
HARDWARE**



Everything in Hardware for Shades, Drapes and Textiles  
2573 N.W. 74th Ave., Miami, FL 33122 • T: (305) 597-8671 F: (305) 597-8673  
info@megamarinc.com • www.castellanosdraperies.com

### BRACKETS & ACCESSORIES



RollEase Star Head  
Bracket  
ROLL-MSBM6W



RollEase Motor Silent  
Pin End Bracket  
ROLL-MSBI6W



Idle End Bracket  
ROLC-RS-721



RollEase Motor Silent  
Pin End  
ROLL-MSPE5BK



Intermedia Bracket  
ROLC-RS-761



Star Head Bracket  
ROLC-RS-701



4" Fascia Intermedia Bracket  
ROLC-831



4" Fascia Idle End Bracket  
ROLC-851



4" Fascia Star Head Bracket  
ROLC-811



4" Fascia Small R8  
Tab Bracket  
ROLC-UGF



4" Fascia Bracket for  
R16/R24  
ROLL-RB581RTNW



3" Fascia Bracket for R8  
ROLL-RB362RTNW



5" Fascia Bracket  
ROLL-RE0020110



5" Fascia Bracket  
Insert Plate  
ROLL-RE0020202



Skyline Motor Adapter  
Plate for Somfy ST30 and  
RollEase Motors  
ROLL-SLAMST30W



Skyline Motor Adapter  
Plate for Somfy LS40  
ROLL-SLAMLS40BK-1



**CASTELLANOS  
DRAPERY  
HARDWARE**



Everything in Hardware for Shades, Drapes and Textiles  
2573 N.W. 74th Ave., Miami, FL 33122 • T: (305) 597-8671 F: (305) 597-8673  
info@megamarinc.com • www.castellanosdraperies.com

**BRACKETS & ACCESSORIES**



Adjustable Idler  
Bracket Assembly  
Short Wall Mount  
C-AIBAS-WM-LH



Bracket Motor  
Short Ceiling Mount  
C-BMSCM



Idler Bracket Short  
C-BIS



Adjustable Idler  
Bracket Assembly  
Short Ceiling Mount  
C-AIBAS-CM



Idler Box Bracket  
Assembly White  
C-IBBA-WHITE



Adjustable Idler  
Bracket Assembly  
C-AIBBA-WHITE



4" Fascia  
ROLL-RE0022502  
C-4IFMB-W

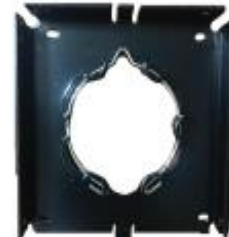

Motor Bracket  
C-4IFMB-B



Motor Shade  
Yode Idler  
ROLL-MSILD



5" Fascia System  
Motor Side Insert  
ROLL-RE0022502



Bracket R8  
Cross Adapter  
SOMFY-R8-CROSS  
ADPT



Adjustable Coupling Box  
Bracket Assembly  
C-ACBBA



Adapter Set For  
Motor in 3 1/4"  
ROLL-RA7U50T



Adapter Set For  
Motor in 2 1/2"  
ROLL-RA6U50BK



Adapter set  
For Motor in 40mm tube  
ROLL-RTA52S40



Motorized Shades  
Bracket Cover  
C-MSBC-B (W-V)