

HP10 Series EV charger



User Manual



UM2146.HP10.A5A0

About this User Manual

Read carefully before installation, maintenance and operation!

- ▷ Failure to read this manual carefully may lead to improper operation.
- ▷ Failure to follow the safety notes may lead to a danger of death, injury and damage to the device, supplier cannot accept any liability for claims resulting from this.

Thank you very much to use our AC EV Charging Station.

- ▷ This manual describes the installation, use and maintenance of AC EV Charging station. This manual is intended for installation and maintenance personnel.

Article	Model Number
1-phase, 3.5kW, with charging cable	HP10116
1-phase, 7kW, with charging cable	HP10132

- ▷ The text and illustrations in this user manual are general explanations of these type of equipment, and the actual product may be inconsistent with this manual in detail.

All rights reserved.

CONTENTS

1. ABBREVIATIONS	4
2. SAFETY NOTES.....	5
2.1. Safety signs used.....	5
2.2. Environment	6
2.3. Installation.....	7
2.4. Operation.....	7
2.5. Maintenance	8
3. STANDARDS COMPLIANCE	9
3.1. Charging mode	9
3.2. Charging connection	9
3.3. Charging interface	10
4. PRODUCT INFORMATION	11
4.1. General.....	11
4.2. Model number definition.....	12
4.3. Specifications.....	12
4.3.4.Mechanical parameters.....	13
4.4. Nameplate.....	14
5. INSTALLATION.....	15
5.1. Unpacking.....	15
5.2. Prepare.....	16
5.3. Power supply system.....	18
5.4. Installation steps	19
5.5. Empty socket	21
6. OPERATION	22
6.1. Power on.....	22
6.2. Human-Machine Interface.....	22

6.3. Configure parameters.....	24
6.4. Start Charging.....	25
6.5. Normally stop charging.....	26
6.6. Abnormally stop charging.....	27
7. FAULT HANDLING AND MAINTENANCE.....	28
7.1. Fault Handling.....	28
7.2. Maintenance.....	30
WARRANTY AGREEMENT	31
DECLARATION OF CONFORMITY(DOC).....	32
COMPLIANCE STATEMENT OF WEEE	33

1. ABBREVIATIONS

S/N	Abbreviations	Description
1	IEC	International Electrotechnical Commission
2	EV	Electrical Vehicle, this can be BEV (battery EV) or PHEV (plug-in hybrid EV)
3	EVSE	Electric Vehicle Supply Equipment [IEC61851-1]
4	OBC	On-board charger (of an EV)
5	LCD	Liquid Crystal Display
6	LED	Light-emitting Diode
7	RFID	Radio Frequency Identification
8	CMS	Central Management System
9	OCPP	Open Charge Point Protocol
10	IP	Ingress Protection
11	HMI	Human-Machine Interface
12	RCMU	Residual Current Monitoring Unit
13	MCB	Miniature Circuit Breaker
14	TN	<p>"T" — indicates the connection between earth and the power supply is direct connection of a point with earth (French: Terre).</p> <p>"N" — the earth connection is supplied by the electricity supply network, either separately to the neutral conductor (TN-S), combined with the neutral conductor (TN-C), or both (TN-C-S).</p> <div style="display: flex; justify-content: space-around; align-items: flex-start;"> <div style="text-align: center;"> <p>TN-S system 230/400VAC</p> </div> <div style="text-align: center;"> <p>TN-C system 230/400VAC</p> </div> <div style="text-align: center;"> <p>TN-C-S system 230/400VAC</p> </div> </div>
15	PE	Protective Earth. The conductor that connects the exposed metallic parts of the consumer's electrical installation
16	PEN	PEN line is to accurately and well ground the original neutral line, and connect the shell of the equipment to be protected to the PEN line

2. SAFETY NOTES

2.1. Safety signs used

The following warning signs, mandatory signs and information signs are used in this manual, on and in the AC EV Charging station.



CAUTION: Warning of electrical hazards.

This sign is intended to alert the user that severe personal injury or substantial property damage can result if the device is not operated as requested.



ATTENTION: Warning of a danger spot or dangerous situation.

This sign is intended to alert the user that minor personal injury or material damage can result, if the device is not operated as requested.



CAUTION: Do not touch by hands in case of ESD.

Indicates the possible consequences of touching electrostatically sensitive components.



CAUTION: Warning of combustion.



No access for unauthorized persons.



No access for persons wearing pacemakers.



Use protective footwear.



Must wear a safety helmet.



Indicates important texts, notes or tips.



Indicates recycling information.



Indicates assemblies or parts that must be disposed of properly.
Do not dispose of them in the household waste.

2.2. Environment



- ▷ EV Charging station should be installed on the incombustible such as concrete; otherwise, hazardous fire may result.
- ▷ EV Charging station should not be installed in the area that contains explosive gas; otherwise, hazardous blast may result.
- ▷ Leave no inflammable or explosive substances near the EV Charging station; otherwise, hazardous blast may result.



- ▷ EV Charging station should be installed in a place with no conductive dust and insulation-destructive gas or vapor.
- ▷ EV Charging station should be installed in a place with no violent vibration and impact; for good ventilation, mount the charging station vertically.
- ▷ The installation foundation shall be higher than the ground level, and drainage ditch shall be set around the EV Charging station, otherwise the equipment may be damaged.

2.3. Installation



Safety protection must be done when installing the EV Charging station.



- ▷ Installation and wiring should be done by personnel with professional qualification, otherwise, hazardous electric shock may result.
 - ▷ Make sure input power supply is entirely disconnected before wiring; otherwise, hazardous electric shock may result.
 - ▷ PE terminal of the EV Charging station must be grounded securely; otherwise, hazardous electric shock may result.
 - ▷ The lead nose of the charging station must be securely attached or there is a risk of damaging the equipment.
 - ▷ Leave no metals such as bolts, gaskets into the inside of the EV Charging station; otherwise, hazardous blast and fire may result.
-



- ▷ Main loop terminal of the EV Charging station should be firmly connected with the wiring ends; otherwise, damage to property may result.
 - ▷ Bare parts of wiring ends of electrical cables must be wrapped with insulating tape; otherwise, hazardous fire and property loss may result.
-

2.4. Operation



- ▷ Strictly forbidden for minors or persons of restricted capacity to approach the charging station to avoid injury.
 - ▷ Forced charging is strictly forbidden when the electric vehicle or charging station fails.
-



- ▷ It is strictly prohibited to use the charging station when the charging adapter or charging cables are defective, cracked, worn, broken or the charging cables is exposed. If you find any, please contact the supplier in time.
- ▷ EV can only be charged with the engine off and stationary.



- ▷ Do not charge in rainy and thunderous weather.
-

2.5. Maintenance



Personnel must always use protective footwear when maintenance work.

Caution ESD to avoid damaging electronic devices, especially to protect microchips on PCBA.



- ▷ Accessory replacement must be done by qualified personnel, thrums or metals are prohibited to be left in the controller; otherwise, hazardous blast and fire may result.



- ▷ After replacing main PCBA, parameters must be adjusted and matched before operation; otherwise, property loss may result.
 - ▷ It is recommended that routine safety inspection visits to charging station be conducted at least once a week.
 - ▷ Keep the charging connector clean and dry and wipe with a clean, dry cloth if soiled.
-

3. STANDARDS COMPLIANCE

3.1. Charging mode

- Conformed to *EN IEC 61851-1:2019*



Charging mode:

method for connection of an EV to the supply network to supply energy to the vehicle

- The Charging mode of HP10 series product is Mode 3



Mode 3 is a method for the connection of an EV to an AC EV supply equipment permanently connected to an AC supply network, with a control pilot function that extends from the AC EV supply equipment to the EV.

3.2. Charging connection

- According to *EN IEC 61851-1:2019*, HP10 series products meet the Case C connection.



Case C:

Connection of an EV to a supply network utilizing a cable and vehicle connector permanently attached to the EV charging station.

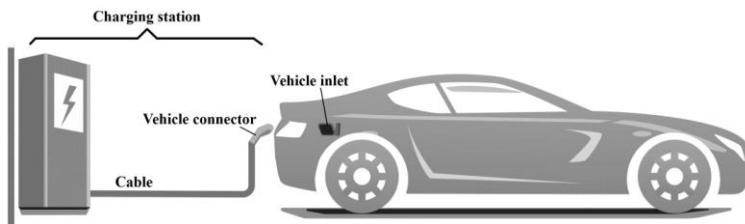

Fig. 3-1 Schematic diagram of CASE C connection

3.3. Charging interface

- The charging connector of HP10 series products meet IEC 62196-2, Type 2 plug (with charging cable).



Fig. 3-2 Type 2 plug on HP10 series products

- HP10 series products provide a Type 2 female plug with charging cable, it only charging an EV with a Type 2 vehicle inlet.

4. PRODUCT INFORMATION

4.1. General

Welcome to use AC EV Charging station produced by our company.

- The shape & dimensions of AC EV charging station shown as Fig. 4-1.

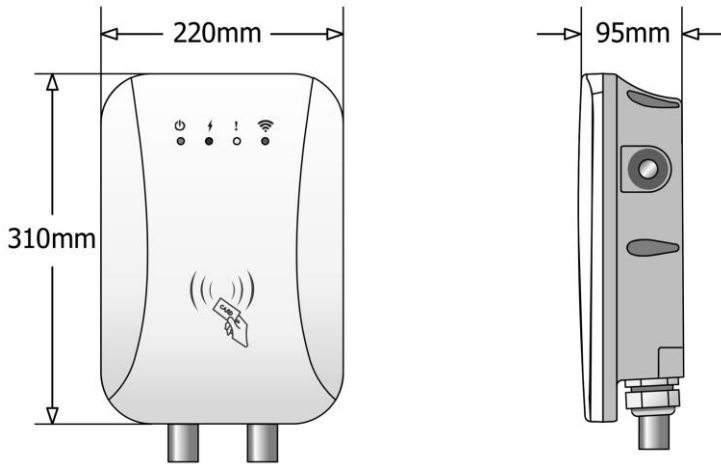

Fig. 4-1 The shape & dimensions of HP10 series

- The block diagram of AC EV charging station is shown as Fig. 4-2.

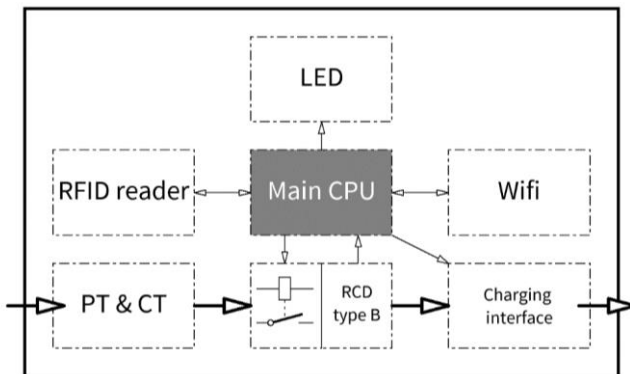

Fig. 4-2 Block diagram of products

- It is widely used in all kinds of household electric vehicle charging, as well as various charging stations, parking lots, community garages and public electric vehicle charging places.

4.2. Model number definition

The model number definition of charging station follows the rules as shown in Fig. 4-3.

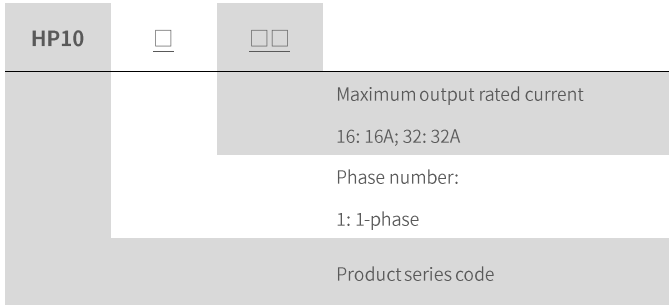

Fig. 4-3 Model number definition

4.3. Specifications

4.3.1. Electrical specifications

Model Number	HP10116	HP10132
Rated Voltage	230V, 50/60Hz	
Rated Current	16A	32A
Rated Power	3.5kW (@230V, 1-phase)	7kW (@230V, 1-phase)
Recommended power supply cable	3×4mm ² ,copper	3×6mm ² ,copper
MCB recommended	Dedicated circuit, 20A, 2-Pole	Dedicated circuit, 40A, 2-Pole
Input Terminals	L/ N/ PE	
Charging interface	IEC 62196-2, Type 2, 1-phase plug with 5m cable <i>Note: That cord extension sets are not be used</i>	

4.3.2. Functional description

Model series	HP10 1-phase series
Charging Mode	Mode 3
Charging Control	Remote: "APP-controlled" Local: "Button-controlled" or "Card-controlled"
Indicator Lights	4 LED lights; Indicate 4 statuses include standby, charging, fault and network
Networking interface	WiFi (2.4GHz / 5G Hz), and support OCPP 1.6J Protocol (Optional)
Safety Protection	Surge protection, over temperature, over/under voltage, over current, leakage fault, ground protection for TN system (TN-C, TN-S and TN-C-S)
RCD Built-in	Yes, Type B RCMU (meet IEC 62955) built-in

4.3.3. Ambient conditions

Model series	HP10 1-phase series
Altitude	≤ 2000m
Storage temperature	-40 ~ 75°C
Operation temperature	-30 ~ 55°C
Relative humidity	≤ 95%RH, no water droplet condensation
Vibration	< 0.5G, no acute vibration and impaction
Installation location	Indoor or outdoor, good ventilation, no flammable, explosive gases

4.3.4. Mechanical parameters

Model series	HP10 1-phase series
Mounting	Wall-mounted or pole-mounted (mounting pole is optional)
Net Weight	≤ 8kg
Dimension	H×W×D = 310mm × 220mm × 95mm
Color & Material	Front cover: White, PC; Back cover: Gray, PC
IP Code	IP65
IK Code	IK10

4.4. Nameplate

On the wallbox shell, there is a nameplate identifying the model and specification of the charging station, the content is shown as Fig. 4-4.

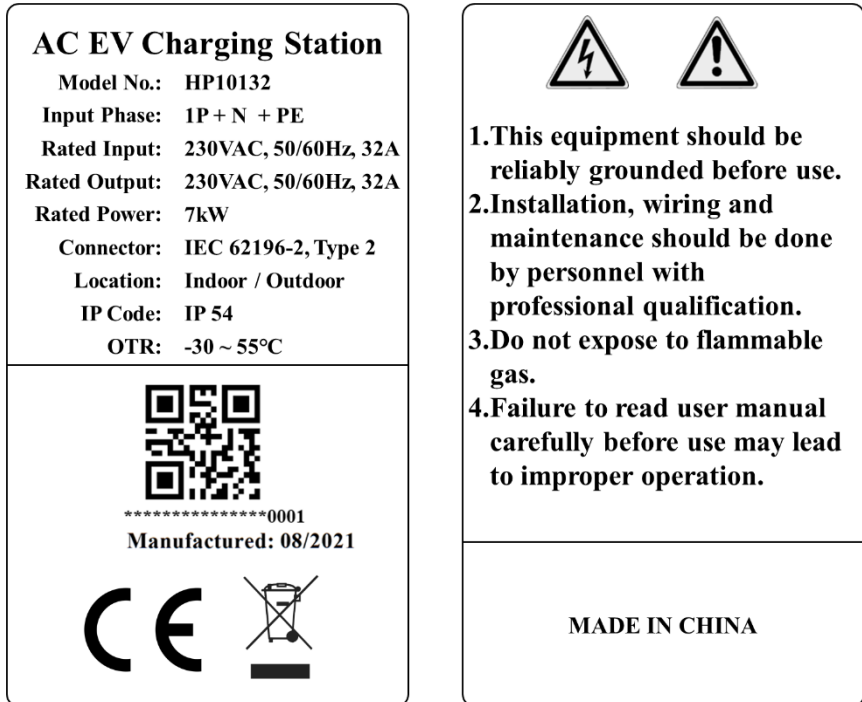

Fig. 4-4 The location and content of the nameplate

5. INSTALLATION

5.1. Unpacking

5.1.1. Packing list

Package	Quantity
AC EV Charging Station	1 pc
Empty socket	1 pc
RFID card	2 pcs
Wall-mounting accessories (including A+B+C+D as Fig. 5-1 shown)	1 set
User manual	1 pc
Quality certificate	1 pc

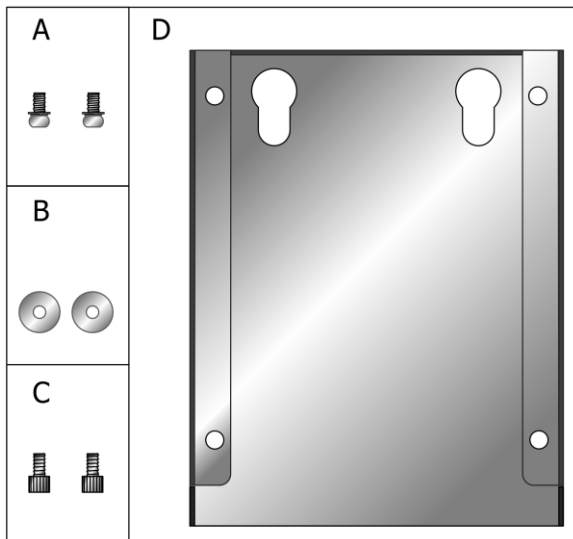

Fig. 5-1 Wall-mounting accessories

5.1.2. Inspection & confirm

When unpacking, please carefully confirm the following points:

- Whether the accessories are missing according to the packing list.

- Whether there is any damage during transportation.
- Whether the model and specification of the machine's nameplate are consistent with the order requirements.



▷ If any damage or missing parts are found, please do not start the machine and contact the supplier as soon as possible.

▷ Please keep the packing box and packing materials 1 month for future handling.



▷ The paper packaging is recyclable.

5.2. Prepare

- When transporting or moving the charging station, pay attention to the following points to ensure product safety:



▷ This product is electrical equipment. It should be handled with care to avoid violent vibration and impact.

▷ The charging station shall not be transported by dragging the charging connector and the charging cable.

- In order to ensure the long-term stable operation of the product, it is recommended to avoid installing charging stations in extreme weather as far as possible, especially low or high ambient temperature may affect the installation effect due to thermal expansion and cold contraction.
- The electrical power supply cable must be prepared. Please refer to Clause 4.3.1 to select the power cable.
- Space requirement: When the charging station is fixed on the wall, the minimum space requirements are shown in Fig. 5-2.

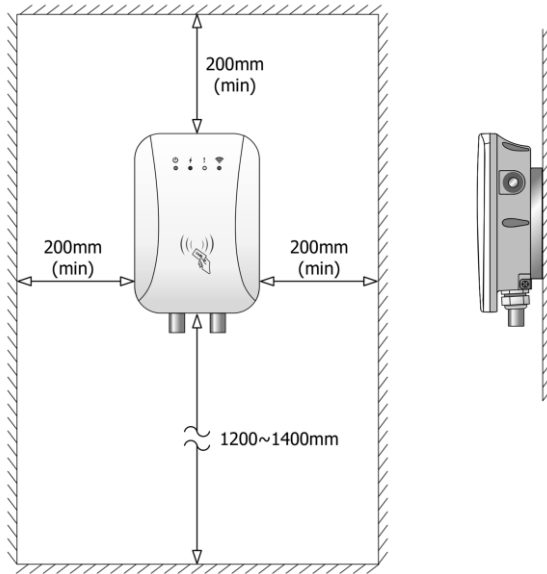









Fig. 5-2 Minimum space requirements for wall mounting

- It is suggested that the charging station should be installed in a place with good ventilation, no direct sunlight and shelter from wind and rain. In order to ensure good ventilation condition, you should mount the charging station vertically and leave enough space.
- Tools for installation

Prepare the following tools at least before installing the AC EV charging station.

Sr No.	Tools' Name	Schematic Picture	Main Uses
1	Multimeter		Check the electrical connection and measure the voltage
2	Electric Impact drill		Drill fixing holes in the wall

3	Wrench		Fastening bolt
4	Diagonal plier		Cut the cable
5	Wire stripper		Peeling cables
6	Crimping plier		Pressed cable terminal
7	Cross screwdriver		Fastening screw

5.3. Power supply system

HP10 series products are suitable for installation in TN power supply system.

a) TN-S power supply system wiring mode

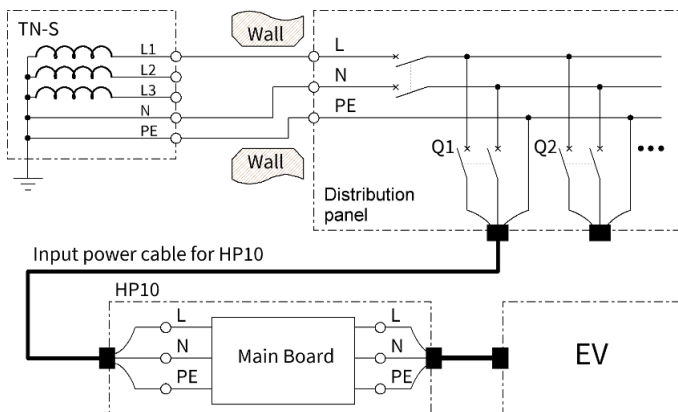

Fig. 5-3 HP10 work in TN-S system

b) TN-C power supply system wiring mode

Earth rod should be installed as far as possible to ensure that household electrical equipment can be effectively protected zero connection. The Fig.5-4 shows the TN-C power supply system with earth rod.

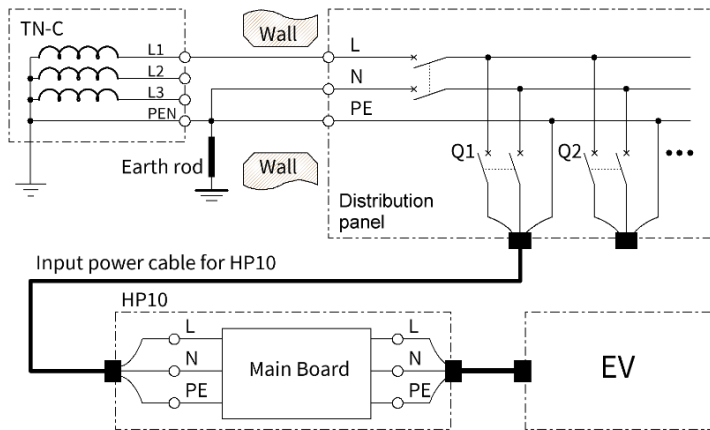

Fig. 5-4 HP10 work in TN-C system with earth rod

In TN-C, for local earth rod where there is no condition to install, a series of circuits are set inside HP10 to protect safety. Even if leakage fault occurs when PEN is disconnected or three-phase voltage is unbalanced, HP10 can quickly interrupt charging and protect the personal safety of users.

c) TN-C-S power supply system wiring mode

The connection method is the same as that of TN-S power supply system.

5.4. Installation steps

Install the Charging station on the wall follow the steps as below.

- Step 1: Mount the accessories-D

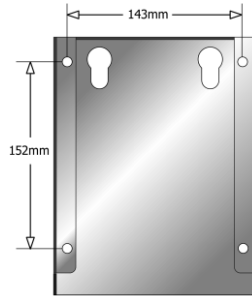

Fig. 5-5 The fixing holes of accessories-D

Drill 4 holes with diameter of 10mm and depth of at least 50mm on the wall with spacing of 143mm × 152mm, and secure the accessories-D to the wall with expansion screws.

■ Step 2: Wiring

As shown in Fig. 5-6, unscrew the total 6 screws with mark [A] to open the front cover of wallbox before wiring; no need to unscrew the 4 screws with mark "×".

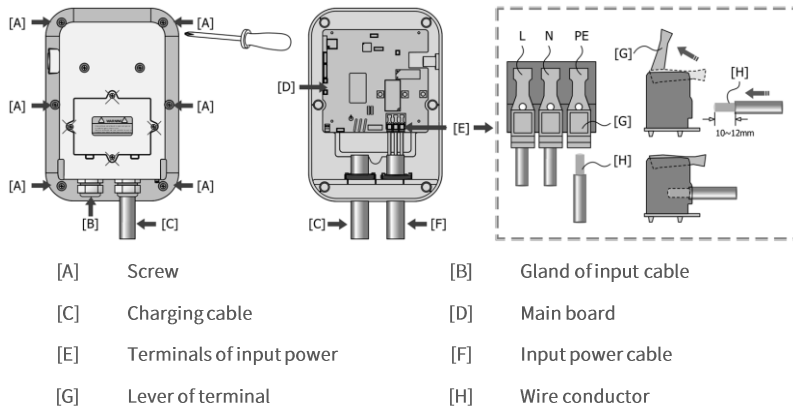

Fig. 5-6 Open the wallbox and wiring

- Loosen the gland [B], pass the prepared power cable through it.
- Remove 10~12 mm of insulation from the wire conductor [H].
- Pull up the lever [G] to open the terminal, plug the wire conductors into each terminal, press down the lever[G] to make sure every wire conductor is reliable connect with terminal.
- Screw the total 6 screws with mark [A] to reset the front cover of wallbox.

- Tighten the gland of input cable.

■ Step3: Fixed the wallbox

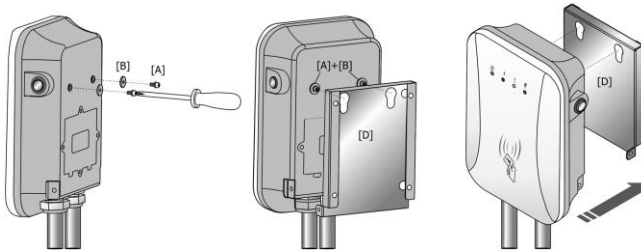

Fig. 5-7 Mounting the wallbox on the accessories-D

As shown in Fig. 5-7, secure mounting accessories[A]+[B] to the charging station; follow the arrow, and hold the wallbox on accessories [D].

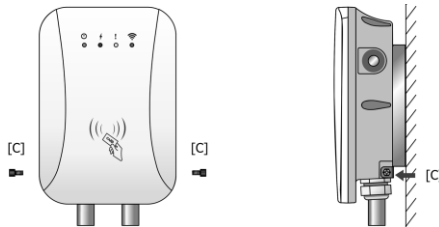

Fig. 5-8 Fixed the wallbox

Tighten the accessories [C] on the left and right ends to fixed the wallbox as Fig.5-8 shown.

5.5. Empty socket

HP10 series AC EV charging station config a type 2 charging connector. When the charging station is in standby state, please plug the charging connector in the empty connector socket in order to protect the charging connector. Please use expansion screws to fix this empty socket at a suitable position beside the charging station.



Fig. 5-9 Empty socket

6. OPERATION

6.1. Power on

After the charging station has been installed and confirmed, switch on the power supply. The  indicator light lights up and the charging station switches to standby state.

6.2. Human-Machine Interface

6.2.1. Overview

As shown in Fig. 6-1, HP10 series product is configured with multiple human-machine interfaces.

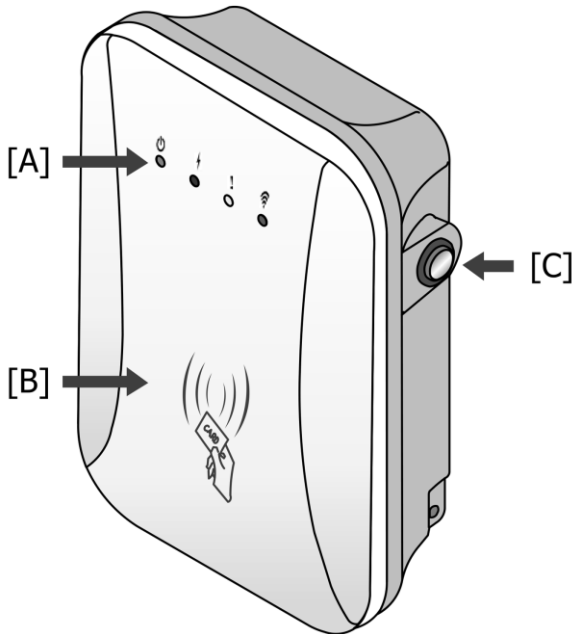





- [A] 4 LED lights: Indicate 4 statuses, include standby, charging, fault, and network
- [B] Swipecard area: Swipe the RFID card to charging
- [C] Charging control button: Start or stop charging by press for Button-controlled charging

Fig. 6-1 HMI of AC EV Charging Station

6.2.2. LED indicators

The LED indicators on the panel are used to indicate the status of the charging station and the various combinations of indicators are described as below.

No.	Icon	Indicator Color	Indicator Status	Connotation
1		Green	ON	Standby status
			Twinkle	Ground fault status
2		Red	ON	connected to an EV
			BLN control	Charging status
3		Yellow	Twinkle	Fault status Twinkle frequency indicates the fault code
			OFF	Unconnected network
4		Blue	ON	Connected to the network
			Slow twinkle	Exchange data with CMS via network.
			Fast twinkle	Configure WiFi network status

6.2.3. RFID reader

In general, the charging station is equipped with RFID card reader as standard, and the charging process can be started and stopped by using the RFID card (shown as Fig. 6-2) configured with the host. The special customized card swiping function is not separately described here.

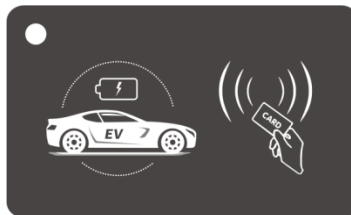

Fig. 6-2 RFID card

6.2.4. Charging control button

You can press the button to control charging, when HP10 work in button-controlled mode.

- Start charging: plug the charging connector into EV socket, press button to start charging.
- Stop charging: press button again will end the charging, when EV is in charging.

6.3. Configure parameters

Taking the configuration of charging station parameters by laptop as an example, it is introduced as follows (the method of setting parameters by mobile phone is similar and will not be repeated):

- Step 1: connect to WiFi hotspot

Keep your laptop in a state where it can connect to WiFi hotspots. Within two minutes after power on, the charging station provides a WiFi hotspot as the access entrance for parameter configuration. Connect a WiFi hotspot with a name is similar to "EVSE-12345678" in the "WiFi network" of the laptop. It is no password to connect the hotspot.

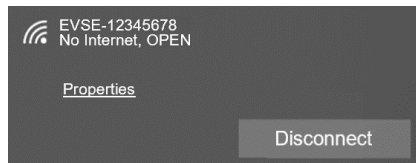

Fig. 6-3 Connect the WiFi in Windows OS

- Step 2: login to setting

Enter 192.168.4.1 in the address bar of Google Chrome or Microsoft Edge, you can access the EVSE CONFIGURATION shown in Fig. 6-4, and Microsoft IE cannot access this IP address.

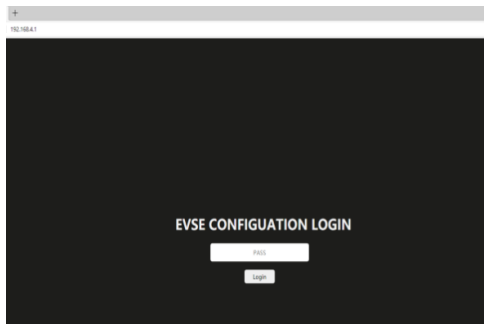

Fig. 6-4 Login of EVSE CONFIGURATION

■ Step 3: Config your EV Charging station

Enter the correct login password to enter the page shown in Fig. 6-5. Please contact the supplier for the login password and change anew password at the first time. As shown in Fig. 6-8, set the parameters on this page.

EVSE CONFIGURATION

User Options

WiFi SSID: Enter your WiFi name

WiFi password: Enter your WiFi password

Button controlled: Select the start charging mode:
 YES- Button-controlled
 NO - Card-controlled or APP-controlled

Advanced Options

Only change these if you are qualified to install this product.

Serial Number: Serial number displayed on screen
 No need to change it

OCPP server: URL of your own OCPP server

OCPP version: Version of OCPP communication
 NO - Not use OCPP communication

OCPP Authpass: OCPP Auth password

Access point name: Enter a new name of Wifi hotspot

Alternative server: Exchange data with supplier backstage
 YES - Permit; NO - Not permit

Charging current: Set the maximum charging current

Login password: Change a new login password

Change a new login password

Restart button for settings take effect

Web version: V1.2 Firmware AC_DUL_2.22AT

Fig. 6-5 Set parameters to config the EV charging station

After setting, click the “SAVE” button to save the settings, and click the “RESTART” button to restart charging station for settings take effect. Enter your WiFi name and password in the page. After it takes effect, the charging station can access Internet via your WiFi.

6.4. Start Charging

- a) Park your EV into place, turn off, and put the EV under braking.

- b) Pick off the charging connector form empty socket of EV charging station.
- c) As shown in Fig.6-6, plug the charging connector into the AC charging socket of the EV.
- d) For the charging control mode of “Button-controlled” , press the button after EV connector plug in, the charging will start automatically.



Fig. 6-6 Plug into EV socket

- e) For the charging control mode of “Card-controlled” or “APP-controlled” , you can control charging process by swipe RFID card or APP after charging connector plug in.



- ▷ If you want to scan QR code on the screen to start charging, please download and install the *WE E-Charge* APP on your smart phone.



WE E-Charge

- ▷ For Android phone, scan the QR code on the right, and click “Android Download” button to download and install the APP.



- ▷ For iPhone, search “WE E-Charge” in APP Store or scan the QR code on the right to install APP.



- ▷ The user manual of APP please refer to the FAQ of APP.

6.5. Normally stop charging

- a) The charging station will automatically stop when the electric vehicle is fully charged.

- b) For the charging control mode of “Button-controlled” , you can stop charging by press button again, when EV is in charging.
- c) For the charging control mode of “Card-controlled” , you can stop charging by swipe your RFID card again, when EV is in charging.
- d) For the charging control mode of “APP-controlled” , click the stop button on your APP, the charging will stop.
- e) When the charging is end, please unplug the charging connector and plug back to the empty socket of charging station.

6.6. Abnormally stop charging

- a) Forced fault stop: A fault stop initiated by the onboard charger of vehicle.
- b) Automatic fault stop: A fault stop initiated by the charging station.

7. FAULT HANDLING AND MAINTENANCE

7.1. Fault Handling

The charging station is automatically protected in the event of the fault. The fault information and handling methods are as follows.

LED indicator information	Fault code	Handling method
All LED are not on	—	<ul style="list-style-type: none"> ● Check whether the power supply and distribution are normal; ● Check whether the branch breaker is tripped, and close the breaker after troubleshooting; ● Check whether the connection is correct, if the cable comes off, should be properly connected to tighten the cable.
<p>! LED flashes:</p> <ul style="list-style-type: none"> ● 1×slow, 1×fast 	<p>Fault code 11:</p> <p>CP voltage anomaly</p>	<ul style="list-style-type: none"> ● Check the connection of charging connector and EV socket. ● Disconnect and reconnect the charging connector.
<p>! LED flashes:</p> <ul style="list-style-type: none"> ● 1×slow, 3×fast 	<p>Fault code 13:</p> <p>Undervoltage input</p>	<ul style="list-style-type: none"> ● Check whether the input cable is reliably connected. ● Check whether the input voltage is abnormal.
<p>! LED flashes:</p> <ul style="list-style-type: none"> ● 1×slow, 4×fast 	<p>Fault code 14:</p> <p>Overvoltage input</p>	<ul style="list-style-type: none"> ● Check whether the input cable is connected correctly. ● Check whether the input voltage is abnormal.
<p>! LED flashes:</p> <ul style="list-style-type: none"> ● 1×slow, 5×fast 	<p>Fault code 15:</p> <p>Over-temperature protection</p>	<ul style="list-style-type: none"> ● Check whether the charging station is covered or installed in a high temperature environment.

LED indicator information	Fault code	Handling method
<p>! LED flashes:</p> <ul style="list-style-type: none"> ● 1×slow, 6×fast 	<p>Fault code 16: Metering fault</p>	<ul style="list-style-type: none"> ● Power off and restart the device.
<p>! LED flashes:</p> <ul style="list-style-type: none"> ● 1×slow, 7×fast 	<p>Fault code 17: Leakage protection</p>	<ul style="list-style-type: none"> ● Check whether the charging connector and its cable are damaged or wet. ● Recover after pulling out the adapter.
<p>! LED flashes:</p> <ul style="list-style-type: none"> ● 1×slow, 8×fast 	<p>Fault code 18: Output shortage</p>	<ul style="list-style-type: none"> ● Check whether the charging adapter and its cables are damaged or wet.
<p>! LED flashes:</p> <ul style="list-style-type: none"> ● 1×slow, 9×fast 	<p>Fault code 19: Output overcurrent</p>	<ul style="list-style-type: none"> ● Check whether the charging connector is correctly connected. ● Check whether the OBC is normal. ● Check the set of output current.
<p>! LED flashes:</p> <ul style="list-style-type: none"> ● 2×slow, 1×fast 	<p>Fault code 21: EV response timeout</p>	<ul style="list-style-type: none"> ● Battery of EV is full. Or the charging connector is not properly connected. ● Disconnect and reconnect the charging connector.
<p>! LED flashes:</p> <ul style="list-style-type: none"> ● 2×slow, 2×fast 	<p>Fault code 22: EV not supported</p>	<ul style="list-style-type: none"> ● This EV does not meet the IEC standards and cannot be charged.
<p>! LED flashes:</p> <ul style="list-style-type: none"> ● 2×slow, 3×fast 	<p>Fault code 23: Relay sticking</p>	<ul style="list-style-type: none"> ● The device is damaged and needs to be returned to the factory for repair.
<p>! LED flashes:</p> <ul style="list-style-type: none"> ● 2×slow, 4×fast 	<p>Fault code 24: ● RCD fault</p>	<ul style="list-style-type: none"> ● The RCD is damaged and needs to be returned to the factory for repair.
<p>! LED flashes:</p> <ul style="list-style-type: none"> ● 2×slow, 5×fast 	<p>Fault code 25: Ground fault</p>	<ul style="list-style-type: none"> ● Charging station is not grounded; input power cable needs to be checked.

7.2. Maintenance

To ensure the long-term stable operation of the equipment, please maintain the equipment regularly (usually every month) according to the operating environment.

- a) The equipment is maintained by professionals.
- b) Check whether the equipment is well grounded and safe.
- c) Check whether there are potential safety hazards around the charging pile, such as whether there are high temperature, corrosion or inflammable and explosive articles close to the charging station.
- d) Check whether the join point of the input terminal is in good contact and whether there is any abnormality. Check whether other terminal points are loose.

WARRANTY AGREEMENT

1. The scope of warranty refers to the product itself.
2. The warranty period is 12 months. During the warranty period, the company will repair the product free of charge in case of failure or damage (determined by the company's technical personnel) under normal use.
3. The starting time of warranty period is the date of product manufacture.
4. Even in the warranty period, a certain maintenance fee will be charged in case of the following situations.
 - ① Equipment failure caused by not following the user's manual.
 - ② Equipment damage caused by fire, flood, abnormal voltage, etc.
 - ③ Equipment damage caused by using the product for abnormal functions.
 - ④ Equipment damage caused by foreign matter entering.
 - ⑤ Equipment damage caused by other human external factors.
5. The service fee shall be calculated according to the actual cost. If there is another contract, the contract shall prevail.
6. Please be sure to keep this card and show it to the maintenance personnel during the warranty period.
7. If you have any questions, please contact the agent or our company directly.

After sales service center

DECLARATION OF CONFORMITY(DOC)

We, declare that the construction of the device described in the following complies with the relevant stated below.

Relevant EC directives: Directive 2014/53/EU on radio equipment and telecommunications terminal equipment (RED Directive 2014/53/EU).

Harmonized EN basic and engineering standards: IEC 61851-21-2, EN 301489-1/-17, EN 300328, EN 300330, EN 61000-3-11/-12.



COMPLIANCE STATEMENT OF WEEE

This product cannot be discarded at will when it is abandoned. It must be collected separately for special treatment.



**We provide customers
with all-round technical support.**



Any change without prior notice.