



Turbo MV2 series battery charger

Operation Manual



Model	# 12V Output	Max. Output	Battery System (DC)			
			12V	24V	36V	48V
Turbo M212V2	2	12 Amps	✓	✓		
Turbo M220V2	2	20 Amps	✓	✓		
Turbo M320V2	3	20 Amps	✓	✓	✓	
Turbo M230V2	2	30 Amps	✓	✓		
Turbo M330V2	3	30 Amps	✓	✓	✓	
Turbo M430V2	4	30 Amps	✓	✓	✓	✓
Turbo M240V2	2	40 Amps	✓	✓		
Turbo M340V2	3	40 Amps	✓	✓	✓	
Turbo M440V2	4	40 Amps	✓	✓	✓	✓

This manual contains important safety, operation, and installation instructions. Please read all instructions before using your Powermania Turbo MV2 onboard battery charger.



WARNING: CHECK BATTERY TYPE

This charger is designed to charge only Lead Acid type 12V DC batteries; Flooded Lead-Acid, AGM (Absorbent Glass Mat), and GEL (Gelled Electrolyte Lead-Acid). Use of this product to charge other types of batteries may cause batteries to burst and result in personal injuries. If you are unsure about the type of battery, please consult with battery manufacturers.



WARNING: RISK OF EXPLOSIVE GASES!

Working in the vicinity of lead acid batteries is dangerous. Batteries generate explosive gases during normal operation. For this reason it is extremely important to follow the safety instructions each time you use the charger.



WARNING: DO NOT USE 2-PIN AC ADAPTER/EXTENSION CORD

Do NOT use the charger with a 2-pin AC adapter or extension cord. Do NOT cut or make any modification to the factory equipped AC power cord. Doing so can result in serious personal injury.



CAUTION: CONNECT ONLY TO PROPERLY GROUNDED OUTLET

The charger MUST ONLY be connected to a properly grounded AC outlet that is protected by Ground Fault Circuit Interrupter (GFCI) breaker.



DANGER: ALWAYS UNPLUG AC POWER CORD BEFORE MAKING ANY DC WIRING CONNECTION

The AC power cord MUST be UNPLUGGED from the outlet BEFORE connecting any DC wires to the batteries or making any DC wiring connection change. Failure to do so may cause electrical shock resulting in serious personal injury or death.

Introduction3
Personal safety precautions.....3
Precautions prior to charge battery3
Box contents.....4
Specifications.....5
Feature Highlights8
Installing the charger.....10
Select battery type11
Connect the DC cables.....12
Operating the charger.....17
LED indicator descriptions17
Troubleshooting.....18
Fuse replacement instruction19
Maintaining the charger20
Warranty and service information20
Contact information20
Warranty card.....22

INTRODUCTION

Thank you and congratulations on your new purchase of the Powermania Turbo MV2 series onboard battery charger. This charger is waterproof, corrosion-resistant and shock-resistant—ideal for recharging and maintaining 12V DC batteries in various marine applications and other harsh environments.

Featuring Automatic 3-Stage Smart Charge and Battery Selector, this charger is designed to charge and maintain various types of 12V DC batteries using full automation. Our charging process has been proven to bring out the batteries' full potential charge after each charging session while also extending the lifespan at the same time.

The Turbo MV2 also comes equipped with extensive safety features and intuitive LED indicators to help protect your investment. Please visit our website www.powermaniausa.com for the latest product updates and information.

PERSONAL SAFETY PRECAUTIONS

1. Someone should be within range of your voice or close enough to come to your aid when working near a Lead-acid battery.
2. Always work in a well-ventilated area away from ignition sources.
3. Have plenty of fresh water and soap nearby in case battery acid comes in contact with skin, clothes, or eyes.
4. Wear complete eye protection and protective clothing. Avoid touching your eyes while working near batteries.
5. If battery acid contacts your skin or clothing, wash them immediately with soap and water. If acid enters eyes, immediately flood the eyes with running cold water for at least ten (10) minutes and get medical attention.
6. Never smoke or allow an open flame near batteries.
7. Do not drop any type of metal tool onto battery terminals as that may cause a spark or short-circuit which may result in an explosion or fire.
8. Remove all personal metal items such as rings, bracelets, necklaces, and watches when working near batteries. A battery can cause short circuit currents that are high enough to weld metals and cause serious burns.

PRECAUTIONS PRIOR TO CHARGING BATTERY

- Do not charge outside of battery manufacturer's recommended temperature conditions.
- Do not use this charger to charge dry cell batteries for home appliances.
- Do not operate the charger if any of the prewired cables or LED's are damaged.
- Make sure all onboard connected electronic devices are powered off.
- If a battery needs to be removed from the vehicle or boat to be charged, always remove the

grounded negative terminal from the battery first.

- Be sure to have enough open space around the battery for good ventilation during charge. Gas fumes can be vented and blown away by using a piece of cardboard or other non-metallic material as a fan.
- Wear full eye protection when cleaning battery terminals to prevent corrosive materials from coming in contact with eyes.
- Add distilled water in each cell until battery acid reaches levels specified by battery manufacturer. Do not overfill. For batteries without cell caps, follow the recharging instructions provided by battery manufacturers.
- If necessary, use only industrial grade, UL approved extension cord that connects to the charger. When using an extension cord, connect the charger end first before you plug the extension cord to a power outlet. When unplugging, unplug the end connecting to power outlet first, and then unplug the end connects to the charger.
- Make sure the AC power outlet you are connecting the charger to is GFCI (Ground Fault Circuit Interrupt) protected.

BOX CONTENTS

- Turbo MV2 series charger prewired with one AC power cord and DC output cables
- Operation manual / Registration card
- 4 installation screws

SPECIFICATIONS

	M212V2	M220V2	M320V2	M230V2
Manufacturer's P/N	58201	58203	58204	58205
Max. Input Current (@120V AC)	3.0 Amps	4.7 Amps	4.7 Amps	7.0 Amps
# 12V Output (Prewired)	2	2	3	2
Maximum Output	12 Amps	20 Amps	20 Amps	30 Amps
Output Voltage Configuration	12/24V DC	12/24V DC	12/24/36V DC	12/24V DC
Weight	6.5 lb.	7.7 lb.	8.2 lb.	13.0 lb.
Dimension (Inch)	8 ¹ / ₄ x 5 ³ / ₄ x 2 ³ / ₄	8 ¹ / ₄ x 5 ³ / ₄ x 2 ³ / ₄	8 ¹ / ₄ x 5 ³ / ₄ x 2 ³ / ₄	10 ³ / ₄ x 7 x 3 ¹ / ₄
Cooling Fan	No	Yes	Yes	Yes

M330V2	M430V2	M240V2	M340V2	M440V2
58206	58207	58208	58209	58210
7.0 Amps	7.0 Amps	9.3 Amps	9.3 Amps	9.3 Amps
3	4	2	3	4
30 Amps	30 Amps	40 Amps	40 Amps	40 Amps
12/24/36V DC	12/24/36/48V DC	12/24V DC	12/24/36V DC	12/24/36/48V DC
13.5 lb.	14.0 lb.	13.5 lb.	14.0 lb.	14.5 lb.
10 ^{3/4} x 7 x 3 ^{1/4}	10 ^{3/4} x 7 x 3 ^{1/4}	10 ^{3/4} x 7 x 3 ^{1/4}	10 ^{3/4} x 7 x 3 ^{1/4}	10 ^{3/4} x 7 x 3 ^{1/4}
Yes	Yes	Yes	Yes	Yes

SPECIFICATIONS (All models)

Nominal input voltage:	120/240V AC
Nominal input frequency:	50/60Hz
Nominal output voltage/bank:	12V DC
Battery type setting:	1. Flooded (Lead-Acid) / AGM 2. GEL 3. AGM+
Max. Absorption time:	4 hours
Output cable length:	6 feet / 182 cm
Power cord length:	6 feet / 182 cm
LED indicators (top):	1. Power 2. Monitor 3. Over-voltage indicator 4. Overheat indicator 5. AGM+ charge mode 6. GEL (Gel Cell) charge mode 7. Flooded (Lead-Acid)/AGM charge mode
LED indicators (bottom):	Charge status / DC connection check
Feature highlights:	Adaptive Loading 3-Stage Smart Charge Battery Type Selector
Safety features:	Ignition Protection Overheat Protection Over-Current Protection Over-Voltage Protection Reverse Polarity Protection Short Circuit Protection
Design standard & Compliances:	FCC Part 15 Class A IP65 (Splash-proof) Marine UL 1236 CSA C22.2 No. 107.2 California Energy Commission (CEC)

FEATURE HIGHLIGHT: Adaptive Loading



USER BENEFIT:	Fully charges all connected batteries in the shortest time.
----------------------	---



The Adaptive Loading feature adjusts the charger’s output level dynamically on each output bank. This allows more charging power to automatically go to the more depleted battery and less power goes to the battery that is closer to a full charge.

In Scenario 1 (left side), the two batteries have similar charge levels. Adaptive Loading allocates approximately 50 percent of its total output equally to each battery. In Scenario 2 (right side), the first battery’s is close to full charge, and the second battery is nearly depleted. In this case, Adaptive Loading allocates 10 percent to the first battery and 90 percent to the discharged one.

Note that in both scenarios the charger uses its full output so that, unlike chargers with fixed output-per-bank, the Turbo MV2 charges all connected batteries in the shortest possible time.

FEATURE HIGHLIGHT: 3-Stage Smart Charge



USER BENEFIT:	Maximizes battery potential and prolongs battery life.
----------------------	---

Turbo MV2 charges a battery in three sequential stages: Bulk, Absorption, and Float. This method is proven to bring a battery to its fullest charge, as well as maintain a fully charged battery's from self discharge.

At the first stage (Bulk), the charger provides its maximum constant current for fast charging. The battery's voltage increases as it absorbs the charge. When the battery voltage reaches 14.5V (flooded /AGM mode), it's approximately 80% recharged. The charger then moves to the second stage.

At the second stage (Absorption), the charger continues to charge the battery at 14.5V (flooded / AGM mode). The charging current drops slowly as the battery charges up to 100%. When the battery is fully charged, the charger then moves to the third stage.

At the third stage (Float), the charger voltage now drops to 13.4V (flooded / AGM mode). At this point, it is safe to keep the charger connected to the battery indefinitely to maintain the battery's full charge. Once the battery begins to losing charge from use, the charger will start a new recharge cycle.

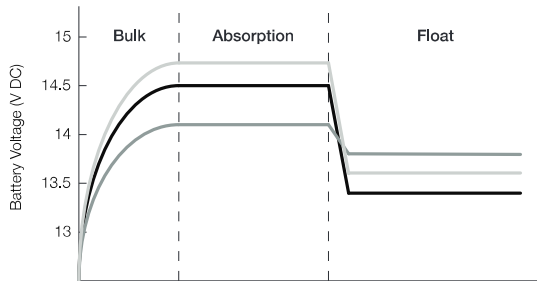

Line	Charge Mode	Voltage (Absorption)	Voltage (Float)
	Flood Lead-Acid / AGM	14.5 V	13.4 V
	GEL Mode	14.1 V	13.8 V
	AGM+ Mode	14.7 V	13.6 V

INSTALLING THE CHARGER

The Powermania Turbo MV2 series charger is designed to be mounted onboard a vehicle or watercraft. The chart below shows the proper orientation of the mounting position. The top row LED lights line up horizontally at the top and the output cables at the bottom of the charger. This orientation optimises air ventilation during operation. Follow these instructions for a proper charger installation:

1. Select a well-ventilated area where there are at least 8 inches of clear air space around the charger.
2. Make sure the charger's DC output cables can reach all batteries from the mounting location.
3. If the DC cables are not long enough, they may be extended by splicing and soldering 12 AWG (for 12 Amp and 20 Amp models) or 10 AWG (for 30 Amp and 40 Amp) wires. Each splice should be covered by adhesive lined / dual wall heat shrink tube to prevent corrosion at the joints. The splicing should be made between the fork of the cable and the fuse holder so that the fuse stays within 6" of the battery terminals. Do not add more than 12' of DC cable extension. **Please note that the warranty will be void by cutting the DC cables.**
4. Do not mount the charger on carpeted, upholstered, or varnished surfaces.
5. Make sure the mounting surface can firmly support the charger with the provided screws.
6. Support the charger and position it on the tentative mounting area. Use a pencil to mark position of each mounting hole.
7. Use 1/8" drill bit to drill on the marked position.
8. Align the charger to the drilled holes, and then secure the charger with the four provided screws.

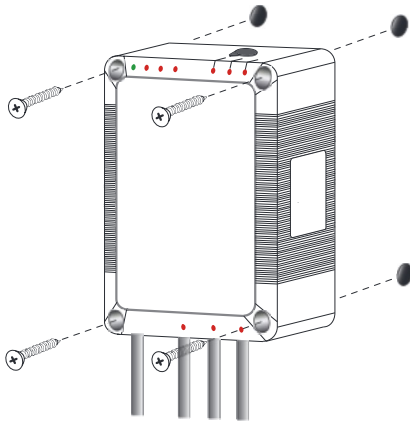

SELECT BATTERY TYPE

The Battery Selector's tip point can be switched in three positions: Refer to the illustration below. From left to right, the first position (factory setting) is for charging Flooded Lead-Acid type and AGM type batteries. The middle position is for charging GEL (Gel Cell) type battery, and the right position (AGM+) is for charging high-performance AGM type battery (Odyssey and Optima brands AGM).

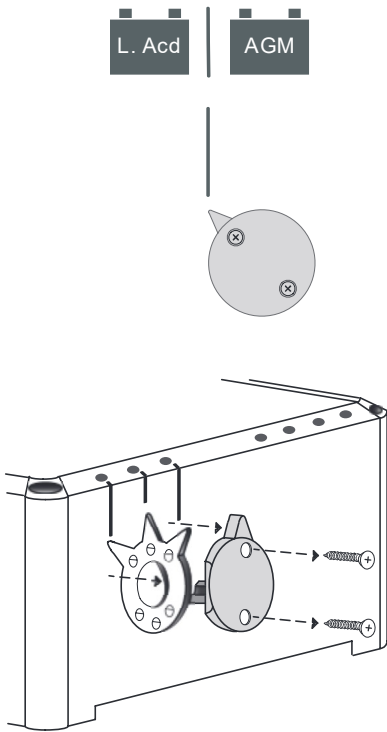

To switch to a different charge mode:

1. Make sure the charger's power cord is unplugged from the power outlet.
2. Loosen the screws from the battery selector.
3. Carefully pull the battery selector straight out from the charger.
4. Place the battery selector back to the charger with the desired battery type position.
5. Secure the screws back to the battery selector.



CAUTION: RISK OF PERSONAL INJURY

The screws used to secure the battery selector must be 10mm or shorter. If the screws are longer than 10mm, the charger could be damaged and could result in serious personal injury.



EACH DC OUTPUT CABLE MUST BE CONNECTED TO A BATTERY TERMINAL TO PREVENT SPARKS.

CONNECT THE DC CABLES

The following pages demonstrate proper DC wiring configurations for Powermania Turbo MV2 series chargers. When making DC connections, make sure each set of output cables (one positive and one negative) is connected to the same battery set of terminals. The red wires are positive (shown as grey color on the diagrams) and the black ones are negative. Never connect a black wire (negative) to a terminal that is connected with a red wire (positive).

ALL charger's output cables must be connected to the battery terminal(s). **Never leave any set of output cables unconnected.**

It is recommend to **connect the charger's first output set (output 1) to main house battery.**

The first output set is located next to the AC cord.

Please refer to the connector legend reference diagram which is used for all of the connection diagrams:

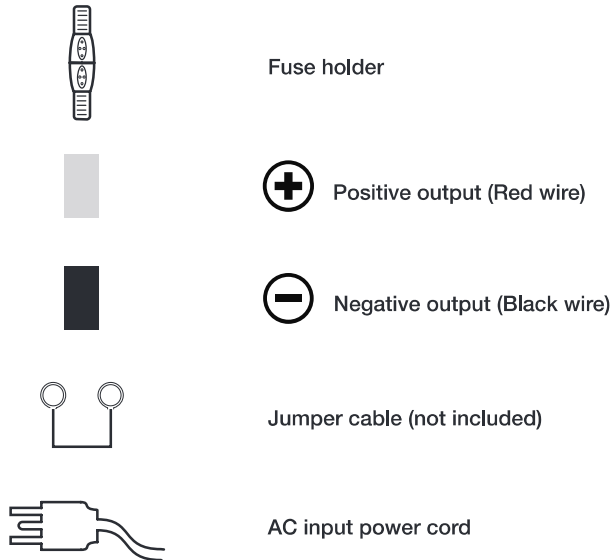

Connecting a dual output charger to one 12V battery

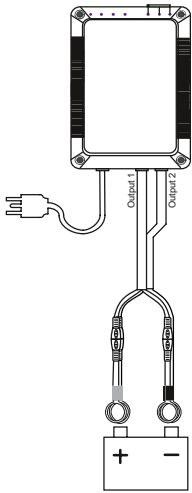

Connect both sets of DC outputs to the same battery's terminal.

Connecting a 12V output to two 6V batteries linked in series

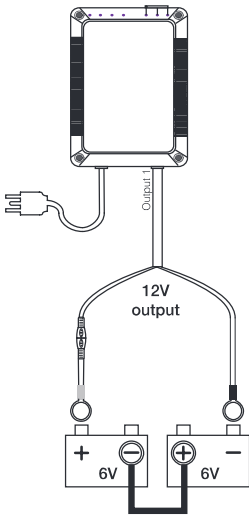

If a 12V system is composed of two 6V batteries, connect the output's positive terminal ring to battery #1's positive terminal and the same output's negative ring terminal to battery #2's negative terminal.

Connecting a dual output charger to two serial-connected 12V batteries (24V system)

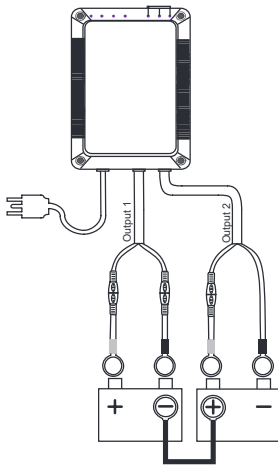

Connect one set of output to each 12V battery. The jumper can be left connected between the two batteries during charging.

Connecting a dual output charger to two parallel-connected 12V batteries

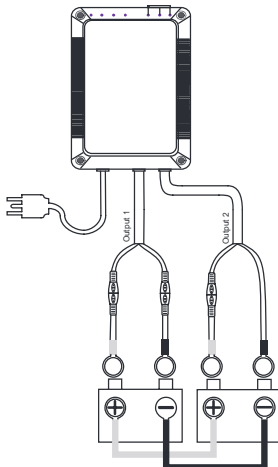

Connect one set of output to each 12V battery. The jumper can be left connected between the two batteries during charging.

Combining two chargers to a single bank

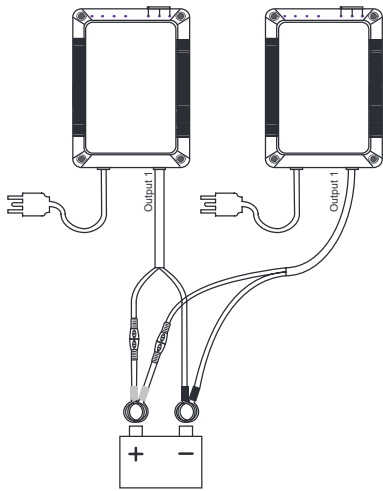

Combine multiple Turbo MV2 chargers to form a more powerful charging system by connecting both chargers' outputs to the same battery bank.

Connecting a 12V output to parallel-linked batteries

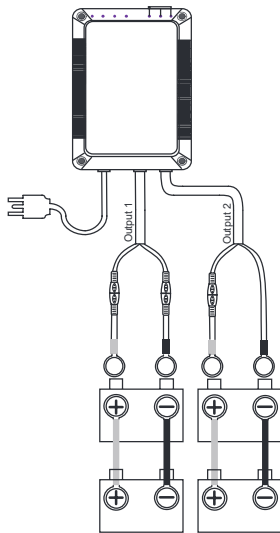

Two or more parallel-linked 12V batteries may be connected to a single output.

Connecting a triple output charger to three 12V batteries

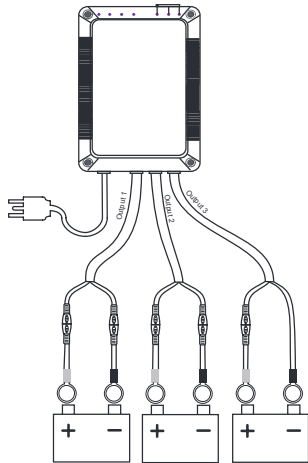

The batteries could be independent, serial-connected or parallel-connected.

Connecting a quad output charger to four 12V batteries

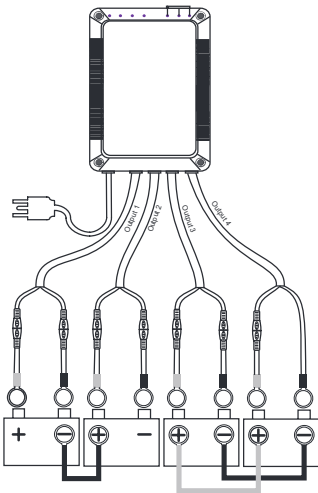









The batteries could be independent, serial-connected, parallel-connected, or mix-and-matched.

OPERATING THE CHARGER

1. Install the charger and make appropriate DC wiring connections as per the wiring diagrams.
2. Choose an appropriate setting on the Battery Selector (page 11).
3. Plug in AC power cord to properly grounded outlet.
4. The Power indicator LED will display green, indicating the presence of AC power.
5. The charger will go through a brief test cycle if all the DC outputs are properly connected to a 12V bank.
6. The charger will start a new charge cycle on the outputs that have proper DC connections.
7. For models equipped with a cooling fan, the fan could power on and off automatically based on the charger's and ambient temperature.
8. When a recharge cycle is completed, the charger will go into monitor mode and continue to trickle charge the batteries at float voltage. It is safe to leave the charger's power on and connected to the batteries indefinitely. If the battery loses charge from use, the charger will start a new recharge cycle.

LED INDICATOR DESCRIPTION

Icon	Indicator	Description
	Power	Power on
	Monitor Mode:	Monitor mode on
	Over-Voltage Warning	DC Voltage exceeds range (Refer to solution in Troubleshooting)
	Overheat Warning	Temperature exceeds range (Refer to solution in Troubleshooting)
	AGM+ Charge Mode	AGM+ Charge Mode (for Odyssey & Optima AGM batteries)
	GEL Charge Mode	GEL Charge Mode
	Flood lead-acid & AGM Charge Mode	Flood lead-acid & AGM Charge Mode (for most brand's lead-acid / AGM batteries)
	Charge Status / Connection Check	Red: Charging Green: Ready Amber: DC connection fault



DANGER: ALWAYS DISCONNECT AC POWER CORD PRIOR TO MAKING ANY DC WIRING CONNECTION CHANGE OR WHEN CHECKING FUSES.

TROUBLESHOOTING

Problem	Possible Cause	Solution
Power indicator is not on.	No AC input.	Check AC input connection. Make sure AC power is present.
	Short circuit at DC output.	Check and correct battery wiring connection (Refer to wiring connection charts). Replace broken fuse if necessary.
Over-Voltage warning indicator is on (amber)	Battery voltage exceeds safe range.	Check and correct battery wiring connection. (Refer to wiring connection charts.) Make sure each output is connected to one 12V battery. Wait at least 30 seconds before plugging in AC power again. If Over-Voltage LED continues to be on even with correct wiring connections, unplug the charger's AC power input and stop using the charger to avoid possible damage to the battery and/or connected devices.
Overheat warning indicator LED is on (amber)	Ambient temperature exceeds safe range.	Remove objects obstructing airflow around the charger. If the charger was operated under direct sunlight, move it away from direct sunlight exposure. Charger will wait for the temperature to come down, then automatically start again.
Charge Status / Connection Check LED displays amber	The output cable is not connected to a 12V battery.	Properly connect the DC output to a 12V battery. Refer to wiring connection charts.
	Fuse failure.	Check for blown fuses on the output cables. Replace damaged fuses.
	Faulty terminal connections.	Clean battery terminal and tighten all wiring connections.
	Reverse polarity on DC wiring connections.	Make sure connections have a matching polarity. Check fuses on output cables and replace any damaged fuses.
	Damaged battery.	Perform battery test. Replace damaged batteries.

FUSE REPLACEMENT INSTRUCTION

- Make sure the charger’s AC power cord is unplugged, and all the DC outputs are disconnected from batteries.
- For cylinder style fuse holders used in 12 Amp and 20 Amp models, use a towel or clothe to enhance grip to pull open the fuse holder. Twist and then turn while pulling, but do not bend the fuse holder as it will break the fuse inside.
- For matchbox style fuse holder used in 30 Amp and 40 Amp models, open the cap.
- Remove the blown fuse by pulling it straight up and out. Do not apply excessive squeezing force as it can break the fuse. If the fuse is broken inside the fuse holder, use long nose pliers to remove the broken pieces.
- For cylinder style fuse holder, use pliers to gently press the rubber enclosure as illustrated in the drawing below. When installed properly the round metal plate will be securely tightened inside the fuse holder. Do not apply excessive force as it could bend the inner metal plate which makes it difficult when inseting the new fuse.
- For the matchbox style fuse holder, use long nose pliers to gently push in the U-shaped section of the metal plate to form a horseshoe shape. This will maximize the conducting area between the fuse and the holder and provides for proper connection and heat dissipation.

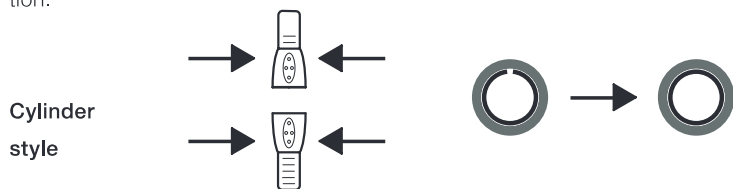

- Always replace a new fuse of the same rating. Use the following table for the correct fuse rating for your particular model.

Style	Model	Fuse Rating
Cylinder	M212V2	15 Amp
Cylinder	M220V2 / M320V2	25 Amp
Matchbox	M230V2 / M330V2 / M430V2 / M240V2 / M340V2 / M440V2	45 Amp

- Make sure the new fuse is pushed into the holder securely.
- Ensure to secure the the cap/holder together.

MAINTAINING THE CHARGER

The Powermania Turbo MV2 charger requires no specific maintenance. However, it is recommended to do the following to ensure reliable and optimal performance from your battery:

- Regularly clean battery terminals and charger's output ring terminals with baking soda and tighten all DC wiring connections.
- Regularly check and maintain proper battery electrolyte level following battery manufacturer's instructions.

It is recommended that you keep the charger's power on to maintain a proper charge level in the connected batteries during long storage periods. This method has been proven to extend battery life and optimal performance.

WARRANTY AND SERVICE INFORMATION

Powermania, at its discretion, provides 2-year limited warranty on Turbo MV2 chargers against defects in material or workmanship under normal use. The warranty coverage period is calculated as follows:

- If customer provides a valid purchase receipt, the 2-year period is calculated from the date of purchase.
- If customer cannot provide a valid purchase receipt, the 2-year period is calculated from the manufacture date based on serial number.

The following conditions are NOT covered under warranty:

- Physical damage
- Normal wear and tear
- Damage caused by accidents, misuse, or alteration of the product including cutting or splicing AC/DC cables.

You may contact Powermania directly for service or warranty inquiry. Please note that customer is responsible for paying the cost of shipping the defective product to Powermania.

CONTACT INFORMATION

Powermania, Inc.

2932 Scott Blvd

Santa Clara, CA 95054

Tel: 888.581.8168 / 408.228.4868

Fax: 408.228.4878

email: support@powermaniausa.com

www.powermaniausa.com

Register online at www.powermaniausa.com

Model number: _____

Serial number: _____

First & Last name: _____

Address: _____

City: _____ State: _____ Zip: _____

Email: _____ Telephone: _____

Date of Purchase (mm/dd/yyyy): _____

Purchased from (Dealer): _____

Type of application: _____

Comments: _____

www.powermaniausa.com

Place
Stamp
Here

Powermania, Inc.
2932 Scott Blvd
Santa Clara, CA 95054
USA

POWERMANIA[®]

UNLEASH THE POWER

RWV2-1404 Rev A