

198 Kezhu Road, Sciencetech Park, Guangzhou Economic & Technological
Development District, Guangzhou, China 510663
Telephone: +86 (0) 20 82155555
Fax: +86 (0) 20 82075058
Email: ee.guangzhou@sgs.com

VERIFICATION OF EMC COMPLIANCE

Verification No.: GZEM1910016526HSV
Applicant: ORIGINS ULTIMATE
Address of Applicant: # 60 KHUBA PLOTS GULBARGA - 585102
Manufacturer: The same as Applicant
Address of Manufacturer: The same as Applicant
Factory: Foshan Shunde JNOD Electrical Appliance Co., Ltd.
Address of Factory: 5th Building Wisdom Creates Wealth Industrial Park, No.8
Second Ring Road, Xingtan, Shunde, Foshan, Guangdong PRC.
Product Description: INSTANT ELECTRIC WATER HEATER
Model No.: FD68P, FD55P
Sufficient samples of the product have been tested and found to be in conformity with
Test Standard(s): EN 55014-1:2017
EN 55014-2:2015
EN IEC 61000-3-2:2019
EN 61000-3-3:2013

As shown in the
Test Report Number(s): GZEM191001652601

This verification of EMC Compliance has been granted to the applicant based on the results of the tests, performed by laboratory of SGS-CSTC Standards Technical Services Co., Ltd. on the sample of the above-mentioned product in accordance with the provisions of the relevant specific standards under Directive 2014/30/EU.

The CE mark as shown below can be used, under the responsibility of the manufacturer, after completion of an EU Declaration of Conformity and compliance with all relevant EU Directives.

Kobe Jian
EMC Laboratory Manager



Date: 2020-01-17



Unless otherwise agreed in writing, this document is issued by the Company subject to its General Conditions of Service printed overleaf, available on request or accessible at <http://www.sgs.com/en/Terms-and-Conditions.aspx> and, for electronic format documents, subject to Terms and Conditions for Electronic Documents at <http://www.sgs.com/en/Terms-and-Conditions/Terms-e-Documents.aspx>. Attention is drawn to the limitation of liability, indemnification and jurisdiction issues defined therein. Any holder of this document is advised that information contained hereon reflects the Company's findings at the time of its intervention only and within the limits of Client's instructions, if any. The Company's sole responsibility is to its Client and this document does not exonerate parties to a transaction from exercising all their rights and obligations under the transaction documents. This document cannot be reproduced except in full, without prior written approval of the Company. Any unauthorized alteration, forgery or falsification of the content or appearance of this document is unlawful and offenders may be prosecuted to the fullest extent of the law. Unless otherwise stated the results shown in this test report refer only to the sample(s) tested and such sample(s) are retained for 30 days only.

Attention: To check the authenticity of testing /inspection report & certificate, please contact us at telephone: (86-755) 8307 1443, or email: CN.Doccheck@sgs.com
SGS-CSTC Standards Technical Services Co., Ltd. | No.198 Kezhu Road, Sciencetech Park, Guangzhou Economic & Technology Development District, Guangzhou, China 510663 | t (86-20) 82155555 f (86-20) 82075058 www.sgs.com.cn
Guangzhou Branch Technical Services Co., Ltd. EMC Laboratory. | 中国·广州·经济技术开发区科学城科珠路198号 | 邮编: 510663 | t (86-20) 82155555 f (86-20) 82075058 sgs.china@sgs.com

TEST REPORT

Application No.: GZEM1910016526HS
Applicant: ORIGINS ULTIMATE
Address of Applicant: # 60 KHUBA PLOTS GULBARGA - 585102
Manufacturer: The same as Applicant
Address of Manufacturer: The same as Applicant
Factory: Foshan Shunde JNOD Electrical Appliance Co., Ltd.
Address of Factory: 5th Building Wisdom Creates Wealth Industrial Park, No.8 Second Ring Road, Xingtan, Shunde, Foshan, Guangdong PRC.

Equipment Under Test (EUT):

EUT Name: INSTANT ELECTRIC WATER HEATER
Model No.: FD68P, FD55P. □
 □ Please refer to section 2 of this report which indicates which model was actually tested and which were electrically identical.

Standards: EN 55014-1:2017
 EN 55014-2:2015
 EN IEC 61000-3-2:2019
 EN 61000-3-3:2013

Date of Receipt: 2019-10-21
Date of Test: 2019-11-28 to 2020-01-08
Date of Issue: 2020-01-17

Test Result :	Pass*
----------------------	--------------

* In the configuration tested, the EUT complied with the standards specified above.

The CE mark as shown below can be used, under the responsibility of the manufacturer, after completion of an EU Declaration of Conformity and compliance with all relevant EU Directives.

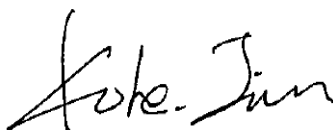
 Kobe Jian
 EMC Laboratory Manager



Unless otherwise agreed in writing, this document is issued by the Company subject to its General Conditions of Service printed overleaf, available on request or accessible at <http://www.sgs.com/en/Terms-and-Conditions.aspx> and, for electronic format documents, subject to Terms and Conditions for Electronic Documents at <http://www.sgs.com/en/Terms-and-Conditions/Terms-e-Documents.aspx>. Attention is drawn to the limitation of liability, indemnification and jurisdiction issues defined therein. Any holder of this document is advised that information contained hereon reflects the Company's findings at the time of its intervention only and within the limits of Client's instructions, if any. The Company's sole responsibility is to its Client and this document does not exonerate parties to a transaction from exercising all their rights and obligations under the transaction documents. This document cannot be reproduced except in full, without prior written approval of the Company. Any unauthorized alteration, forgery or falsification of the content or appearance of this document is unlawful and offenders may be prosecuted to the fullest extent of the law. Unless otherwise stated the results shown in this test report refer only to the sample(s) tested and such sample(s) are retained for 30 days only.
Attention: To check the authenticity of testing /inspection report & certificate, please contact us at telephone: (86-755) 8307 1443, or email: CN.Doccheck@sgs.com

Revision Record				
Version	Chapter	Date	Modifier	Remark
00		2020-01-17		Original

Authorized for issue by:			
Tested By			2019-11-28 to 2020-01-08
	Roy Su /Project Engineer		Date
Checked By			2020-01-11
	Cherie Luo /Reviewer		Date



Unless otherwise agreed in writing, this document is issued by the Company subject to its General Conditions of Service printed overleaf, available on request or accessible at <http://www.sgs.com/en/Terms-and-Conditions.aspx> and, for electronic format documents, subject to Terms and Conditions for Electronic Documents at <http://www.sgs.com/en/Terms-and-Conditions/Terms-e-Documents.aspx>. Attention is drawn to the limitation of liability, indemnification and jurisdiction issues defined therein. Any holder of this document is advised that information contained hereon reflects the Company's findings at the time of its intervention only and within the limits of Client's instructions, if any. The Company's sole responsibility is to its Client and this document does not exonerate parties to a transaction from exercising all their rights and obligations under the transaction documents. This document cannot be reproduced except in full, without prior written approval of the Company. Any unauthorized alteration, forgery or falsification of the content or appearance of this document is unlawful and offenders may be prosecuted to the fullest extent of the law. Unless otherwise stated the results shown in this test report refer only to the sample(s) tested and such sample(s) are retained for 30 days only.
Attention: To check the authenticity of testing /inspection report & certificate, please contact us at telephone: (86-755) 8307 1443, or email: CN.Doccheck@sgs.com

2 Test Summary

Emission Part				
Item	Standard	Method	Requirement	Result
Conducted Disturbance at Mains Terminals (150kHz-30MHz)	EN 55014-1:2017	CISPR 16-2-1	N/A	Pass**
Disturbance Power	EN 55014-1:2017	CISPR 16-2-2	N/A	Pass
Discontinuous Disturbance (150kHz-30MHz)	EN 55014-1:2017	EN 55014-1:2017	N/A	Pass*
Harmonic Current Emission	EN IEC 61000-3-2: 2019	EN IEC 61000-3-2: 2019	Class A	Pass
Voltage Fluctuations and Flicker	EN 61000-3-3:2013	EN 61000-3-3:2013	Clause 5 of EN 61000-3-3	Pass

N/A: Not applicable

* Please refer to Section 6.3 of this report for details.

** The EUT passed Conducted Disturbance at Mains Terminals test after modification.



Unless otherwise agreed in writing, this document is issued by the Company subject to its General Conditions of Service printed overleaf, available on request or accessible at <http://www.sgs.com/en/Terms-and-Conditions.aspx> and, for electronic format documents, subject to Terms and Conditions for Electronic Documents at <http://www.sgs.com/en/Terms-and-Conditions/Terms-e-Documents.aspx>. Attention is drawn to the limitation of liability, indemnification and jurisdiction issues defined therein. Any holder of this document is advised that information contained hereon reflects the Company's findings at the time of its intervention only and within the limits of Client's instructions, if any. The Company's sole responsibility is to its Client and this document does not exonerate parties to a transaction from exercising all their rights and obligations under the transaction documents. This document cannot be reproduced except in full, without prior written approval of the Company. Any unauthorized alteration, forgery or falsification of the content or appearance of this document is unlawful and offenders may be prosecuted to the fullest extent of the law. Unless otherwise stated the results shown in this test report refer only to the sample(s) tested and such sample(s) are retained for 30 days only.

Attention: To check the authenticity of testing /inspection report & certificate, please contact us at telephone: (86-755) 8307 1443, or email: CN.Doccheck@sgs.com

Immunity Part				
Item	Standard	Method	Requirement	Result
Electrostatic Discharge	EN 55014-2:2015	EN 61000-4-2:2009	4kV Contact Discharge 8kV Air Discharge	Pass
Electrical Fast Transients/Burst at Power Port and Signal lines	EN 55014-2:2015	EN 61000-4-4:2012	AC cable: $\pm 1.0kV$ Signal lines: $\pm 0.5kV$ 5/50ns Tr/Th 5kHz Repetition Frequency	Pass
Surge at Power Port	EN 55014-2:2015	EN 61000-4-5:2014	1.2/50 μs Tr/Th 1kV Line to Line 2kV Line to Ground	Pass
Conducted Immunity at Power Port and Signal lines(150kHz-230MHz)	EN 55014-2:2015	EN 61000-4-6:2014	AC: 3V r.m.s (emf), Signal lines: 1V r.m.s (emf), 80%, 1kHz Amp. Mod.	Pass**
Voltage Dips and Interruptions	EN 55014-2:2015	EN 61000-4-11:2004	0 % UT for 0.5per 40 % UT for 10per 70 % UT for 25per UT is Supply Voltage	Pass
			0 % UT for 0.5per 40 % UT for 12per 70 % UT for 30per UT is Supply Voltage	

** : The EUT passed Conducted Immunity at Power Port test after modification.

Declaration of EUT Family Grouping:

Model No.: FD68P, FD55P.

According to the declaration from the applicant, the electrical circuit design, layout, components used and internal wiring were identical for all models, with only difference on the rated power.

Details were shown as below:

Model No.	Rated power
FD68P	6800W
FD55P	5500W

Therefore only one model **FD68P** was tested in this report.



Unless otherwise agreed in writing, this document is issued by the Company subject to its General Conditions of Service printed overleaf, available on request or accessible at <http://www.sgs.com/en/Terms-and-Conditions.aspx> and, for electronic format documents, subject to Terms and Conditions for Electronic Documents at <http://www.sgs.com/en/Terms-and-Conditions/Terms-e-Documents.aspx>. Attention is drawn to the limitation of liability, indemnification and jurisdiction issues defined therein. Any holder of this document is advised that information contained hereon reflects the Company's findings at the time of its intervention only and within the limits of Client's instructions, if any. The Company's sole responsibility is to its Client and this document does not exonerate parties to a transaction from exercising all their rights and obligations under the transaction documents. This document cannot be reproduced except in full, without prior written approval of the Company. Any unauthorized alteration, forgery or falsification of the content or appearance of this document is unlawful and offenders may be prosecuted to the fullest extent of the law. Unless otherwise stated the results shown in this test report refer only to the sample(s) tested and such sample(s) are retained for 30 days only.

3 Contents

	Page
1 Cover Page	1
2 Test Summary	3
3 Contents	5
4 General Information.....	7
4.1 Details of E.U.T.	7
4.2 Description of Support Units	7
4.3 Measurement Uncertainty	7
4.4 Test Location.....	8
4.5 Test Facility	9
4.6 Deviation from Standards.....	10
4.7 Abnormalities from Standard Conditions.....	10
4.8 Monitoring of EUT for All Immunity Test	10
5 Equipment List.....	11
6 Emission Test Results	14
6.1 Conducted Disturbance at Mains Terminals (150kHz-30MHz).....	14
6.1.1 E.U.T. Operation.....	14
6.1.2 Test Setup Diagram	14
6.1.3 Measurement Data	15
6.2 Disturbance Power.....	17
6.2.1 E.U.T. Operation.....	17
6.2.2 Test Setup Diagram	17
6.2.3 Measurement Data	18
6.3 Discontinuous Disturbance (150kHz-30MHz)	19
6.4 Harmonic Current Emission	20
6.4.1 E.U.T. Operation.....	20
6.4.2 Test Setup	20
6.4.3 Measurement Data	21
6.5 Voltage Fluctuations and Flicker	22
6.5.1 E.U.T. Operation.....	22
6.5.2 Test Setup Diagram	22
6.5.3 Measurement Data	23
7 Immunity Test Results	24
7.1 Performance Criteria Description in EN 55014-2:2015	24
7.2 Electrostatic Discharge	25
7.2.1 E.U.T. Operation.....	25
7.2.2 Test Setup Diagram	25
7.2.3 Test Results:.....	26
7.3 Electrical Fast Transients/Burst at Power Port.....	27
7.3.1 E.U.T. Operation.....	27
7.3.2 Test Setup Diagram	27
7.3.3 Test Results:.....	27



Unless otherwise agreed in writing, this document is issued by the Company subject to its General Conditions of Service printed overleaf, available on request or accessible at <http://www.sgs.com/en/Terms-and-Conditions.aspx> and, for electronic format documents, subject to Terms and Conditions for Electronic Documents at <http://www.sgs.com/en/Terms-and-Conditions/Terms-e-Documents.aspx>. Attention is drawn to the limitation of liability, indemnification and jurisdiction issues defined therein. Any holder of this document is advised that information contained hereon reflects the Company's findings at the time of its intervention only and within the limits of Client's instructions, if any. The Company's sole responsibility is to its Client and this document does not exonerate parties to a transaction from exercising all their rights and obligations under the transaction documents. This document cannot be reproduced except in full, without prior written approval of the Company. Any unauthorized alteration, forgery or falsification of the content or appearance of this document is unlawful and offenders may be prosecuted to the fullest extent of the law. Unless otherwise stated the results shown in this test report refer only to the sample(s) tested and such sample(s) are retained for 30 days only.

Attention: To check the authenticity of testing /inspection report & certificate, please contact us at telephone: (86-755) 8307 1443, or email: CN.Doccheck@sgs.com

7.4	Surge at Power Port.....	28
7.4.1	E.U.T. Operation.....	28
7.4.2	Test Setup Diagram.....	28
7.4.3	Test Results:.....	29
7.5	Conducted Immunity at Power Port (150kHz-230MHz).....	30
7.5.1	E.U.T. Operation.....	30
7.5.2	Test Setup Diagram.....	30
7.5.3	Test Results:.....	31
7.6	Voltage Dips and Interruptions.....	32
7.6.1	E.U.T. Operation.....	32
7.6.2	Test Setup Diagram.....	32
7.6.3	Test Results:.....	33
8	Photographs.....	34
8.1	EUT Constructional Details.....	34



Unless otherwise agreed in writing, this document is issued by the Company subject to its General Conditions of Service printed overleaf, available on request or accessible at <http://www.sgs.com/en/Terms-and-Conditions.aspx> and, for electronic format documents, subject to Terms and Conditions for Electronic Documents at <http://www.sgs.com/en/Terms-and-Conditions/Terms-e-Documents.aspx>. Attention is drawn to the limitation of liability, indemnification and jurisdiction issues defined therein. Any holder of this document is advised that information contained hereon reflects the Company's findings at the time of its intervention only and within the limits of Client's instructions, if any. The Company's sole responsibility is to its Client and this document does not exonerate parties to a transaction from exercising all their rights and obligations under the transaction documents. This document cannot be reproduced except in full, without prior written approval of the Company. Any unauthorized alteration, forgery or falsification of the content or appearance of this document is unlawful and offenders may be prosecuted to the fullest extent of the law. Unless otherwise stated the results shown in this test report refer only to the sample(s) tested and such sample(s) are retained for 30 days only.

Attention: To check the authenticity of testing /inspection report & certificate, please contact us at telephone: (86-755) 8307 1443, or email: CN.Doccheck@sgs.com

4 General Information

4.1 Details of E.U.T.

Power Supply:	AC 230V, 50/60Hz
Test Voltage:	AC 230V, 50Hz
Cable:	3 wires about 1.2m unscreened AC mains cable

4.2 Description of Support Units

The EUT has been tested with incandescent lamp provided by customer.

4.3 Measurement Uncertainty

No.	Item	Measurement Uncertainty
1	Conducted Disturbance	3.63dB (9kHz to 150kHz)
		3.22dB (150kHz to 30MHz)
2	Disturbance Power	3.78dB
3	Radiated Disturbance	5.0dB (30MHz-1GHz)
		5.0dB (1GHz-6GHz)
4	Radiated Immunity	2.18dB
5	Conducted Immunity	3.5dB
6	ESD	6 %
7	EFT (Electrical Fast Transients)	4 %
8	Surge Immunity	6%
9	Voltage Dips and Interruptions	4 %
10	20 System	1.5dB
11	Temperature Test	0.4°C
12	Humidity Test	1.3%
13	DC power Test	0.5 %



Unless otherwise agreed in writing, this document is issued by the Company subject to its General Conditions of Service printed overleaf, available on request or accessible at <http://www.sgs.com/en/Terms-and-Conditions.aspx> and, for electronic format documents, subject to Terms and Conditions for Electronic Documents at <http://www.sgs.com/en/Terms-and-Conditions/Terms-e-Documents.aspx>. Attention is drawn to the limitation of liability, indemnification and jurisdiction issues defined therein. Any holder of this document is advised that information contained hereon reflects the Company's findings at the time of its intervention only and within the limits of Client's instructions, if any. The Company's sole responsibility is to its Client and this document does not exonerate parties to a transaction from exercising all their rights and obligations under the transaction documents. This document cannot be reproduced except in full, without prior written approval of the Company. Any unauthorized alteration, forgery or falsification of the content or appearance of this document is unlawful and offenders may be prosecuted to the fullest extent of the law. Unless otherwise stated the results shown in this test report refer only to the sample(s) tested and such sample(s) are retained for 30 days only.

Attention: To check the authenticity of testing /inspection report & certificate, please contact us at telephone: (86-755) 8307 1443, or email: CN.Doccheck@sgs.com

4.4 Test Location

All tests were performed at:

SGS-CSTC Standards Technical Services Co., Ltd., Guangzhou Branch EMC Laboratory,
198 Kezhu Road, Sciencetech Park, Guangzhou Economic & Technology Development District,
Guangzhou, China 510663

Tel: +86 20 82155555 Fax: +86 20 82075059

No tests were sub-contracted.



Unless otherwise agreed in writing, this document is issued by the Company subject to its General Conditions of Service printed overleaf, available on request or accessible at <http://www.sgs.com/en/Terms-and-Conditions.aspx> and, for electronic format documents, subject to Terms and Conditions for Electronic Documents at <http://www.sgs.com/en/Terms-and-Conditions/Terms-e-Documents.aspx>. Attention is drawn to the limitation of liability, indemnification and jurisdiction issues defined therein. Any holder of this document is advised that information contained hereon reflects the Company's findings at the time of its intervention only and within the limits of Client's instructions, if any. The Company's sole responsibility is to its Client and this document does not exonerate parties to a transaction from exercising all their rights and obligations under the transaction documents. This document cannot be reproduced except in full, without prior written approval of the Company. Any unauthorized alteration, forgery or falsification of the content or appearance of this document is unlawful and offenders may be prosecuted to the fullest extent of the law. Unless otherwise stated the results shown in this test report refer only to the sample(s) tested and such sample(s) are retained for 30 days only.

Attention: To check the authenticity of testing /inspection report & certificate, please contact us at telephone: (86-755) 8307 1443, or email: CN.Doccheck@sgs.com

4.5 Test Facility

The test facility is recognized, certified, or accredited by the following organizations:

- **NVLAP (Lab Code: 200611-0)**

SGS-CSTC Standards Technical Services Co., Ltd., Guangzhou EMC Laboratory is accredited by the National Voluntary Laboratory Accreditation Program (NVLAP/NIST). NVLAP Code: 200611-0.

The report must not be used by the client to claim product certification, approval, or endorsement by NVLAP, NIST, or any agency of the Federal Government.

- **ACMA**

SGS-CSTC Standards Technical Services Co., Ltd., EMC Laboratory can also perform testing for the Australian C-Tick mark as a result of our NVLAP accreditation.

- **SGS UK(Certificate No.: 32), SGS-TUV SAARLAND and SGS-FIMKO**

Have approved SGS-CSTC Standards Technical Services Co., Ltd., EMC Laboratory as a supplier of EMC TESTING SERVICES and SAFETY TESTING SERVICES.

- **CNAS (Lab Code: L0167)**

SGS-CSTC Standards Technical Services Co., Ltd., EMC Laboratory has been assessed and in compliance with CNAS-CL01:2018 accreditation criteria for testing laboratories (identical to ISO/IEC 17025:2017 General Requirements) for the Competence of Testing Laboratories.

- **FCC Recognized Accredited Test Firm(Registration No.: 486818)**

SGS-CSTC Standards Technical Services Co., Ltd., EMC Laboratory has been accredited and fully described in a report filed with the (FCC) Federal Communications Commission. The acceptance letter from the FCC is maintained in our files. Designation Number: CN5016, Test Firm Registration Number: 486818, Jul 13, 2017.

- **Industry Canada (Registration No.: 4620B, CAB identifier: CN0052)**

SGS-CSTC Standards Technical Services Co., Ltd., has been registered by Innovation Science and Economic Development Canada for Wireless Device Testing laboratories to test to Canadian radio equipment requirements. Registration No. 4620B, CAB identifier: CN0052.

- **VCCI (Registration No.: R-12460, C-12584, G-10449 and T-11179)**

The 10m Semi-anechoic chamber and Shielded Room of SGS-CSTC Standards Technical Services Co., Ltd. have been registered in accordance with the Regulations for Voluntary Control Measures with Registration No.: R-12460, C-12584, G-10449 and T-11179 respectively.

- **CBTL (Lab Code: TL129)**

SGS-CSTC Standards Technical Services Co., Ltd., E&E Laboratory has been assessed and fully comply with the requirements of ISO/IEC 17025:2017, the Basic Rules, IECEE 01 and Rules of procedure IECEE 02, and the relevant IECEE CB-Scheme Operational documents.



Unless otherwise agreed in writing, this document is issued by the Company subject to its General Conditions of Service printed overleaf, available on request or accessible at <http://www.sgs.com/en/Terms-and-Conditions.aspx> and, for electronic format documents, subject to Terms and Conditions for Electronic Documents at <http://www.sgs.com/en/Terms-and-Conditions/Terms-e-Documents.aspx>. Attention is drawn to the limitation of liability, indemnification and jurisdiction issues defined therein. Any holder of this document is advised that information contained hereon reflects the Company's findings at the time of its intervention only and within the limits of Client's instructions, if any. The Company's sole responsibility is to its Client and this document does not exonerate parties to a transaction from exercising all their rights and obligations under the transaction documents. This document cannot be reproduced except in full, without prior written approval of the Company. Any unauthorized alteration, forgery or falsification of the content or appearance of this document is unlawful and offenders may be prosecuted to the fullest extent of the law. Unless otherwise stated the results shown in this test report refer only to the sample(s) tested and such sample(s) are retained for 30 days only.

Attention: To check the authenticity of testing /inspection report & certificate, please contact us at telephone: (86-755) 8307 1443, or email: CN.Doccheck@sgs.com

4.6 Deviation from Standards

None

4.7 Abnormalities from Standard Conditions

The heating element was disconnected and instead by a incandescent lamp as per applicant's request, the equipment input current was below 16A, so harmonic and flicker tests were performed according to the standards of EN IEC 61000-3-2:2019 and EN 61000-3-3:2013.

The EUT passed Conducted Disturbance at Mains Terminals and Conducted Immunity at Power Port tests after modification.

4.8 Monitoring of EUT for All Immunity Test

Visual: LED display indication.

Audio: N/A



Unless otherwise agreed in writing, this document is issued by the Company subject to its General Conditions of Service printed overleaf, available on request or accessible at <http://www.sgs.com/en/Terms-and-Conditions.aspx> and, for electronic format documents, subject to Terms and Conditions for Electronic Documents at <http://www.sgs.com/en/Terms-and-Conditions/Terms-e-Documents.aspx>. Attention is drawn to the limitation of liability, indemnification and jurisdiction issues defined therein. Any holder of this document is advised that information contained hereon reflects the Company's findings at the time of its intervention only and within the limits of Client's instructions, if any. The Company's sole responsibility is to its Client and this document does not exonerate parties to a transaction from exercising all their rights and obligations under the transaction documents. This document cannot be reproduced except in full, without prior written approval of the Company. Any unauthorized alteration, forgery or falsification of the content or appearance of this document is unlawful and offenders may be prosecuted to the fullest extent of the law. Unless otherwise stated the results shown in this test report refer only to the sample(s) tested and such sample(s) are retained for 30 days only.

Attention: To check the authenticity of testing /inspection report & certificate, please contact us at telephone: (86-755) 8307 1443, or email: CN.Doccheck@sgs.com

5 Equipment List

Conducted Disturbance at Mains Terminals (150kHz-30MHz)						
No.	Test Equipment	Manufacturer	Model No.	Serial No.	Cal. date	Cal.Due date
					(YYYY-MM-DD)	(YYYY-MM-DD)
EMC0306	Shielding Room	Zhong Yu	8 x 3 x 3.8 m ²	N/A	2019-12-26	2022-12-26
EMC0118	Two-line v-netwok	R&S	ENV216	100359	2019-01-11	2020-01-10
EMC2135	Two-line v-netwok	R&S	ENV216	102259	2019-09-16	2020-09-15
EMC0203	LISN	AFJ	LS16-OPT001	116019831056	2019-01-11	2020-01-10
EMC0506	EMI Test Receiver	Rohde & Schwarz	ESCS30	100085	2019-11-18	2020-11-17
EMC0107	Coaxial Cable	SGS	2m	N/A	2018-09-20	2020-09-19
EMC0106	Voltage Probe	SGS	N/A	N/A	2018-04-04	2020-04-03
EMC2123	8 Line ISN Cat 6	SCHWARZBECK MESS-ELEKTRONIK	NTFM 8158	NTFM 8158 0151	2019-05-29	2020-05-28
EMC2124	8 Line ISN Cat 5	SCHWARZBECK MESS-ELEKTRONIK	CAT5 8158	CAT5 8158-188	2019-05-29	2020-05-28
EMC2126	8 Line ISN Cat 3	SCHWARZBECK MESS-ELEKTRONIK	CAT3 8158	CAT38158-0081	2019-05-29	2020-05-28
EMC2122	ISN S8	SCHWARZBECK MESS-ELEKTRONIK	ISN S8	57	2019-05-29	2020-05-28
EMC2121	ISN S1	SCHWARZBECK MESS-ELEKTRONIK	ISN S1	10	2019-05-29	2020-05-28
EMC2125	2 wires ISN	SCHWARZBECK MESS-ELEKTRONIK	NTFM 8131	8131-198	2019-05-29	2020-05-28
EMC2047	CDN	Elektronik- Feinmechanik	L-801:AF2	2793	2018-09-29	2020-09-27
EMC2048	CDN	Elektronik- Feinmechanik	L-801:M2/M3	2738	2018-08-13	2020-08-12
EMC2062	6dB Attenuator	HP	8491A	24487	2018-04-04	2020-04-03
EMC0167	Conical metal housing	SGS-EMC	N/A	N/A	2018-04-19	2020-04-18

Disturbance Power						
No.	Test Equipment	Manufacturer	Model No.	Serial No.	Cal. date	Cal.Due date
					(YYYY-MM-DD)	(YYYY-MM-DD)
EMC0306	Shielding Room	Zhong Yu	8 x 3 x 3.8 m ²	N/A	2019-12-26	2022-12-26
EMC2040	Absorbing Clamp	Beijing Dazhe Co. Ltd.	ZN23201	N/A	2019-01-15	2020-01-14
EMC0303	7m Coaxial Cable	SGS	7m	N/A	2019-06-28	2021-06-27
EMC0506	EMI Test Receiver	Rohde & Schwarz	ESCS30	100085	2019-11-18	2020-11-17
EMC2062	6dB Attenuator	HP	8491A	24487	2018-04-04	2020-04-03
EMC0305	Slide Bar Controller	HD-GmbH	HD50	050/490	N/A	N/A
EMC0103	Slide Bar RP	HD-GmbH	KMS560	560/392	N/A	N/A



Unless otherwise agreed in writing, this document is issued by the Company subject to its General Conditions of Service printed overleaf, available on request or accessible at <http://www.sgs.com/en/Terms-and-Conditions.aspx> and, for electronic format documents, subject to Terms and Conditions for Electronic Documents at <http://www.sgs.com/en/Terms-and-Conditions/Terms-e-Documents.aspx>. Attention is drawn to the limitation of liability, indemnification and jurisdiction issues defined therein. Any holder of this document is advised that information contained hereon reflects the Company's findings at the time of its intervention only and within the limits of Client's instructions, if any. The Company's sole responsibility is to its Client and this document does not exonerate parties to a transaction from exercising all their rights and obligations under the transaction documents. This document cannot be reproduced except in full, without prior written approval of the Company. Any unauthorized alteration, forgery or falsification of the content or appearance of this document is unlawful and offenders may be prosecuted to the fullest extent of the law. Unless otherwise stated the results shown in this test report refer only to the sample(s) tested and such sample(s) are retained for 30 days only.

Attention: To check the authenticity of testing /inspection report & certificate, please contact us at telephone: (86-755) 8307 1443, or email: CN.Doccheck@sgs.com

Harmonics / Flicker test						
No.	Test Equipment	Manufacturer	Model No.	Serial No.	Cal. date	Cal.Due date
					(YYYY-MM-DD)	(YYYY-MM-DD)
EMC0608	AC Power Source	California	50001iX	56627	2018-04-01	2020-03-31
EMC0607	Power Analyzer	California	PACS	72400	2018-04-01	2020-03-31

Electrostatic Discharge						
No.	Test Equipment	Manufacturer	Model No.	Serial No.	Cal. date	Cal.Due date
					(YYYY-MM-DD)	(YYYY-MM-DD)
EMC2071	ESD Simulator	TESEQ AG	NSG 435	6739	2019-07-04	2020-07-03
EMC0804	ESD Ground Plane	SGS	3m x3m	N/A	N/A	N/A
EMC0078	Temperature, & Humidity	Shanghai Meteorological Instrument factory Co., Ltd.	ZJ1-2B	0709131	2019-07-05	2020-07-04

Electrical Fast Transients/Burst at Power Port, Surge at Power Port and Voltage Dips and Interruptions						
No.	Test Equipment	Manufacturer	Model No.	Serial No.	Cal. date	Cal.Due date
					(YYYY-MM-DD)	(YYYY-MM-DD)
EMC2059	Modular Impulse Surge Generator	EMC PARTNER	MIG0603EN	259	2019-01-07	2020-01-08
EMC2060	High speed signal Surge CDN	EMC PARTNER	CDN-UTP	CDN-UTP0089	2019-01-07	2020-01-08
EMC2072	EMC Immunity Test System	TESEQ AG	NSG 3060 CDN3061 INA 6502 CIB CDN3425	1580 1466 222	2019-01-07	2020-01-08
EMC2055	Oscilloscope 500MHz	Tektronix	TDS3052C	C011815	2019-01-07	2020-01-08



Unless otherwise agreed in writing, this document is issued by the Company subject to its General Conditions of Service printed overleaf, available on request or accessible at <http://www.sgs.com/en/Terms-and-Conditions.aspx> and, for electronic format documents, subject to Terms and Conditions for Electronic Documents at <http://www.sgs.com/en/Terms-and-Conditions/Terms-e-Documents.aspx>. Attention is drawn to the limitation of liability, indemnification and jurisdiction issues defined therein. Any holder of this document is advised that information contained hereon reflects the Company's findings at the time of its intervention only and within the limits of Client's instructions, if any. The Company's sole responsibility is to its Client and this document does not exonerate parties to a transaction from exercising all their rights and obligations under the transaction documents. This document cannot be reproduced except in full, without prior written approval of the Company. Any unauthorized alteration, forgery or falsification of the content or appearance of this document is unlawful and offenders may be prosecuted to the fullest extent of the law. Unless otherwise stated the results shown in this test report refer only to the sample(s) tested and such sample(s) are retained for 30 days only.

Attention: To check the authenticity of testing /inspection report & certificate, please contact us at telephone: (86-755) 8307 1443, or email: CN.Doccheck@sgs.com

Conducted Immunity at Power Port and Signal lines(150kHz-230MHz)						
No.	Test Equipment	Manufacturer	Model No.	Serial No.	Cal. date	Cal.Due date
					(YYYY-MM-DD)	(YYYY-MM-DD)
EMC2115	TEST SYSTEM OF CI	TESEQ AG	NSG 4070B-80	46144	2019-07-04	2020-07-03
EMC2116	6dB Attenuator	TESEQ AG	ATN 6075	45823	2018-07-24	2020-07-23
EMC1101	Signal Generator	Rohde & Schwarz	SMY01	825675/016	2019-05-29	2020-05-28
EMC1102	Amplifier 0.15-230MHz	SCHAFFNER	GRF5048	1003	2019-05-29	2020-05-28
EMC1103	Power Meter	Rohde & Schwarz	NRVS	825770/079	2018-12-13	2020-12-12
EMC2113	CDN S502A	TESEQ	CDN S502A	46206	2017-06-19	2020-06-18
EMC2112	CDN ST08A	TESEQ	CDN ST08A	36631	2017-07-03	2020-07-02
EMC2114	CDN USB3.0	TESEQ	CDN USB3.0	45777	2017-06-19	2020-06-18
EMC2169	CDN M1	TESEQ	CDN M1	0004	2019-06-15	2021-06-14
EMC1105	Dual Directional coupler	Werlatone Inc.	C1795	6635	2019-05-29	2020-05-28
EMC2055	Oscilloscope 500MHz	Tektronix	TDS3052C	C011815	2019-01-11	2020-01-10
EMC2048	CDN	Elektronik- Feinmechanik	L-801:M2/M3	2738	2018-08-13	2020-08-12
EMC2169	Coupling Decoupling Network	TESEQ	CDN M016	46989	2018-08-10	2021-08-20
EMC1107	CDN M2	Schaffner Chase	CDN-M2-16	9863	2017-10-26	2020-10-25
EMC1116	Current Probe	Schaffner Chase	CIP9136	1155	2017-10-26	2020-10-25
EMC1117	Current Probe	Schaffner Chase	CSP8445	18	2017-10-26	2020-10-25

General used equipment						
No.	Test Equipment	Manufacturer	Model No.	Serial No.	Cal. date	Cal.Due date
					(YYYY-MM-DD)	(YYYY-MM-DD)
EMC0006	DMM	Fluke	73	70681569	2019-07-16	2020-07-15
EMC0007	DMM	Fluke	73	70671122	2019-07-16	2020-07-15



Unless otherwise agreed in writing, this document is issued by the Company subject to its General Conditions of Service printed overleaf, available on request or accessible at <http://www.sgs.com/en/Terms-and-Conditions.aspx> and, for electronic format documents, subject to Terms and Conditions for Electronic Documents at <http://www.sgs.com/en/Terms-and-Conditions/Terms-e-Documents.aspx>. Attention is drawn to the limitation of liability, indemnification and jurisdiction issues defined therein. Any holder of this document is advised that information contained hereon reflects the Company's findings at the time of its intervention only and within the limits of Client's instructions, if any. The Company's sole responsibility is to its Client and this document does not exonerate parties to a transaction from exercising all their rights and obligations under the transaction documents. This document cannot be reproduced except in full, without prior written approval of the Company. Any unauthorized alteration, forgery or falsification of the content or appearance of this document is unlawful and offenders may be prosecuted to the fullest extent of the law. Unless otherwise stated the results shown in this test report refer only to the sample(s) tested and such sample(s) are retained for 30 days only.

Attention: To check the authenticity of testing /inspection report & certificate, please contact us at telephone: (86-755) 8307 1443, or email: CN.Doccheck@sgs.com

6 Emission Test Results

6.1 Conducted Disturbance at Mains Terminals (150kHz-30MHz)

Test Requirement:	EN 55014-1:2017
Test Method:	CISPR 16-2-1
Frequency Range:	150kHz to 30MHz
Limit:	
0.15MHz-0.5MHz	66dB(μV)-56dB(μV) quasi-peak, 59dB(μV)-46dB(μV) average
0.5MHz-5MHz	56dB(μV) quasi-peak, 46dB(μV) average
5MHz-30MHz	60dB(μV) quasi-peak, 50dB(μV) average
Detector:	Peak for pre-scan (9kHz resolution bandwidth) 150KHz to 30MHz

6.1.1 E.U.T. Operation

Operating Environment:

Temperature: 24 °C Humidity: 52 % RH Atmospheric Pressure: 1015 mbar

Test Mode: a: Test the EUT in simulating the normal working condition under applicant's requirements.

6.1.2 Test Setup Diagram

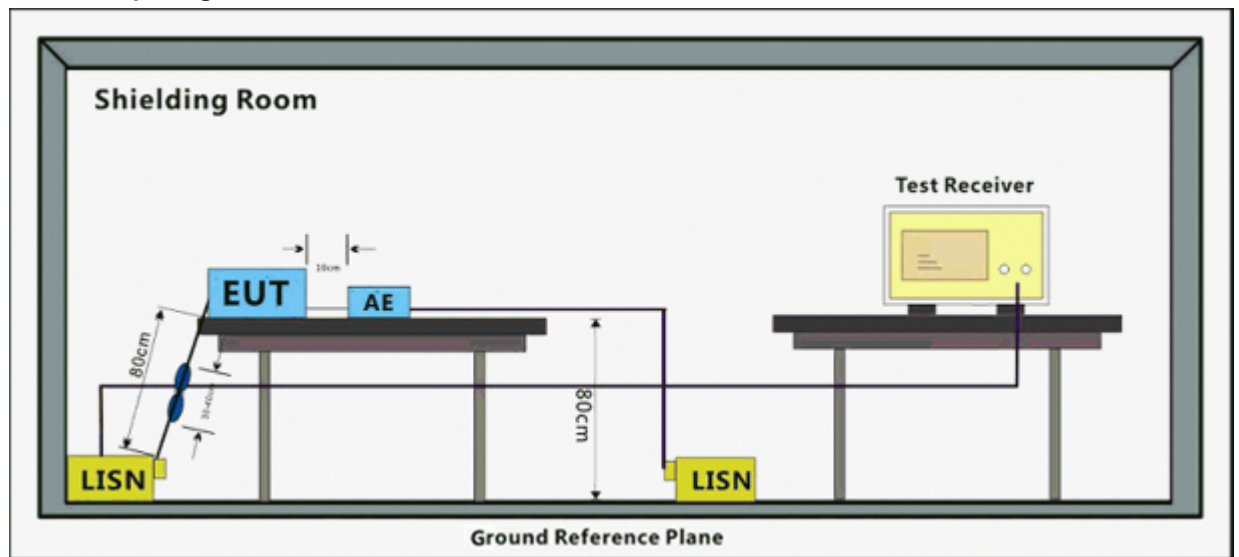

Unless otherwise agreed in writing, this document is issued by the Company subject to its General Conditions of Service printed overleaf, available on request or accessible at <http://www.sgs.com/en/Terms-and-Conditions.aspx> and, for electronic format documents, subject to Terms and Conditions for Electronic Documents at <http://www.sgs.com/en/Terms-and-Conditions/Terms-e-Documents.aspx>. Attention is drawn to the limitation of liability, indemnification and jurisdiction issues defined therein. Any holder of this document is advised that information contained hereon reflects the Company's findings at the time of its intervention only and within the limits of Client's instructions, if any. The Company's sole responsibility is to its Client and this document does not exonerate parties to a transaction from exercising all their rights and obligations under the transaction documents. This document cannot be reproduced except in full, without prior written approval of the Company. Any unauthorized alteration, forgery or falsification of the content or appearance of this document is unlawful and offenders may be prosecuted to the fullest extent of the law. Unless otherwise stated the results shown in this test report refer only to the sample(s) tested and such sample(s) are retained for 30 days only.

Attention: To check the authenticity of testing /inspection report & certificate, please contact us at telephone: (86-755) 8307 1443, or email: CN.Doccheck@sgs.com

6.1.3 Measurement Data

An initial pre-scan was performed with peak detector. Quasi-Peak or Average measurement were performed at the frequencies with maximized peak emission were detected.

Live Line
 Level (dBμV)

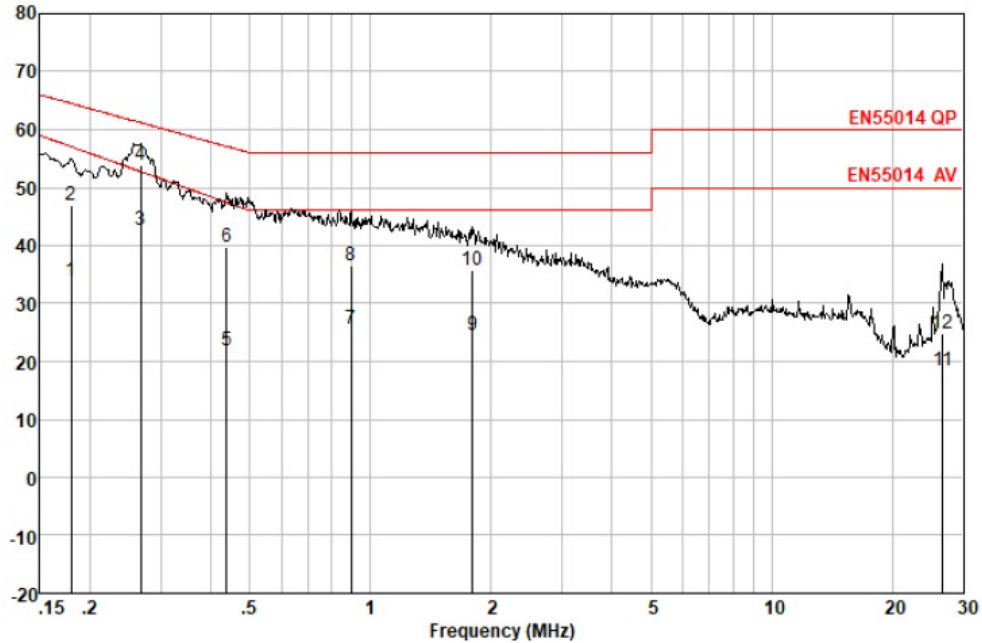

Read Freq	Read Level	LISN Factor	Cable Loss	Limit Level	Over Limit	Remark
MHz	dBuV	dB	dB	dBuV	dB	
0.180	24.09	9.67	0.00	33.76	57.05	-23.29 Average
0.180	37.28	9.67	0.00	46.95	64.50	-17.55 QP
0.267	32.90	9.69	0.00	42.59	52.76	-10.17 Average
0.267	44.28	9.69	0.00	53.97	61.20	-7.23 QP
0.437	12.11	9.70	0.00	21.81	47.44	-25.63 Average
0.437	30.05	9.70	0.00	39.75	57.11	-17.36 QP
0.894	16.04	9.68	0.01	25.73	46.00	-20.27 Average
0.894	26.74	9.68	0.01	36.43	56.00	-19.57 QP
1.800	14.83	9.70	0.04	24.57	46.00	-21.43 Average
1.800	25.90	9.70	0.04	35.64	56.00	-20.36 QP
26.699	7.87	10.28	0.30	18.45	50.00	-31.55 Average
26.699	14.19	10.28	0.30	24.77	60.00	-35.23 QP



Unless otherwise agreed in writing, this document is issued by the Company subject to its General Conditions of Service printed overleaf, available on request or accessible at <http://www.sgs.com/en/Terms-and-Conditions.aspx> and, for electronic format documents, subject to Terms and Conditions for Electronic Documents at <http://www.sgs.com/en/Terms-and-Conditions/Terms-e-Documents.aspx>. Attention is drawn to the limitation of liability, indemnification and jurisdiction issues defined therein. Any holder of this document is advised that information contained hereon reflects the Company's findings at the time of its intervention only and within the limits of Client's instructions, if any. The Company's sole responsibility is to its Client and this document does not exonerate parties to a transaction from exercising all their rights and obligations under the transaction documents. This document cannot be reproduced except in full, without prior written approval of the Company. Any unauthorized alteration, forgery or falsification of the content or appearance of this document is unlawful and offenders may be prosecuted to the fullest extent of the law. Unless otherwise stated the results shown in this test report refer only to the sample(s) tested and such sample(s) are retained for 30 days only.

Neutral Line
 Level (dB μ V)

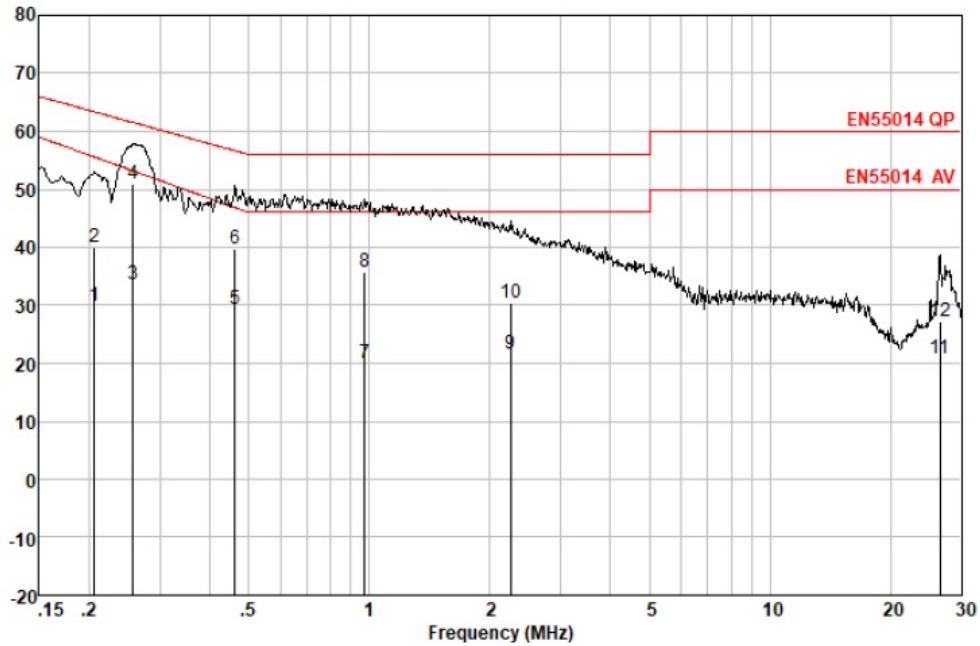

Freq	Read Level	LISN Factor	Cable Loss	Level	Limit Line	Over Limit	Remark
MHz	dB μ V	dB	dB	dB μ V	dB μ V	dB	
0.206	20.26	9.69	0.00	29.95	55.57	-25.62	Average
0.206	30.24	9.69	0.00	39.93	63.36	-23.43	QP
0.258	23.92	9.72	0.00	33.64	53.16	-19.52	Average
0.258	41.33	9.72	0.00	51.05	61.51	-10.46	QP
0.461	19.46	9.75	0.01	29.22	46.87	-17.65	Average
0.461	30.00	9.75	0.01	39.76	56.67	-16.91	QP
0.974	10.33	9.74	0.01	20.08	46.00	-25.92	Average
0.974	26.06	9.74	0.01	35.81	56.00	-20.19	QP
2.249	11.83	9.75	0.05	21.63	46.00	-24.37	Average
2.249	20.72	9.75	0.05	30.52	56.00	-25.48	QP
26.558	9.89	10.49	0.30	20.68	50.00	-29.32	Average
26.558	16.44	10.49	0.30	27.23	60.00	-32.77	QP



Unless otherwise agreed in writing, this document is issued by the Company subject to its General Conditions of Service printed overleaf, available on request or accessible at <http://www.sgs.com/en/Terms-and-Conditions.aspx> and, for electronic format documents, subject to Terms and Conditions for Electronic Documents at <http://www.sgs.com/en/Terms-and-Conditions/Terms-e-Documents.aspx>. Attention is drawn to the limitation of liability, indemnification and jurisdiction issues defined therein. Any holder of this document is advised that information contained hereon reflects the Company's findings at the time of its intervention only and within the limits of Client's instructions, if any. The Company's sole responsibility is to its Client and this document does not exonerate parties to a transaction from exercising all their rights and obligations under the transaction documents. This document cannot be reproduced except in full, without prior written approval of the Company. Any unauthorized alteration, forgery or falsification of the content or appearance of this document is unlawful and offenders may be prosecuted to the fullest extent of the law. Unless otherwise stated the results shown in this test report refer only to the sample(s) tested and such sample(s) are retained for 30 days only.

Attention: To check the authenticity of testing /inspection report & certificate, please contact us at telephone: (86-755) 8307 1443, or email: CN.Doccheck@sgs.com

6.2 Disturbance Power

Test Requirement: EN 55014-1:2017
 Test Method: CISPR 16-2-2
 Frequency Range: 30MHz to 300MHz
 Limit:
 30MHz- 300MHz 45dB(pw)-55dB(pw) quasi-peak, 35dB(pw)-45dB(pw) average
 Detector: Peak for pre-scan (120kHz resolution bandwidth) 30MHz to 300MHz

6.2.1 E.U.T. Operation

Operating Environment:
 Temperature: 24 °C Humidity: 52 % RH Atmospheric Pressure: 1015 mbar
 Test Mode: a: Test the EUT in simulating the normal working condition under applicant's requirements.

6.2.2 Test Setup Diagram

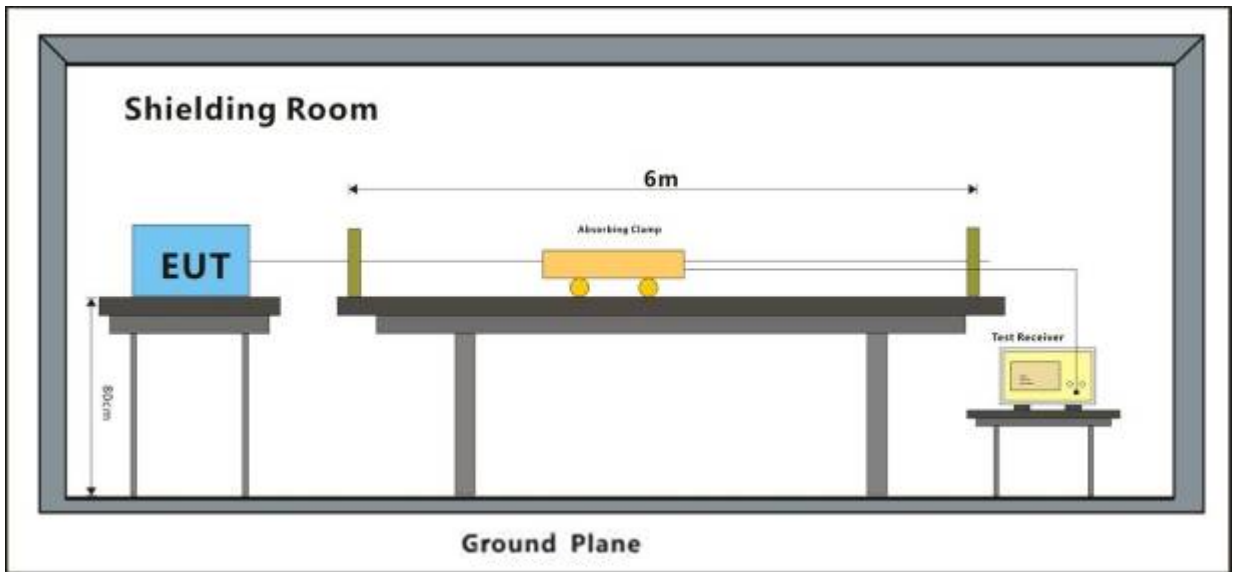

Unless otherwise agreed in writing, this document is issued by the Company subject to its General Conditions of Service printed overleaf, available on request or accessible at <http://www.sgs.com/en/Terms-and-Conditions.aspx> and, for electronic format documents, subject to Terms and Conditions for Electronic Documents at <http://www.sgs.com/en/Terms-and-Conditions/Terms-e-Documents.aspx>. Attention is drawn to the limitation of liability, indemnification and jurisdiction issues defined therein. Any holder of this document is advised that information contained hereon reflects the Company's findings at the time of its intervention only and within the limits of Client's instructions, if any. The Company's sole responsibility is to its Client and this document does not exonerate parties to a transaction from exercising all their rights and obligations under the transaction documents. This document cannot be reproduced except in full, without prior written approval of the Company. Any unauthorized alteration, forgery or falsification of the content or appearance of this document is unlawful and offenders may be prosecuted to the fullest extent of the law. Unless otherwise stated the results shown in this test report refer only to the sample(s) tested and such sample(s) are retained for 30 days only.

6.2.3 Measurement Data

An initial pre-scan was performed with peak detector. Quasi-Peak or Average measurement were performed at the frequencies with maximized peak emission were detected.

Level (dBpW)

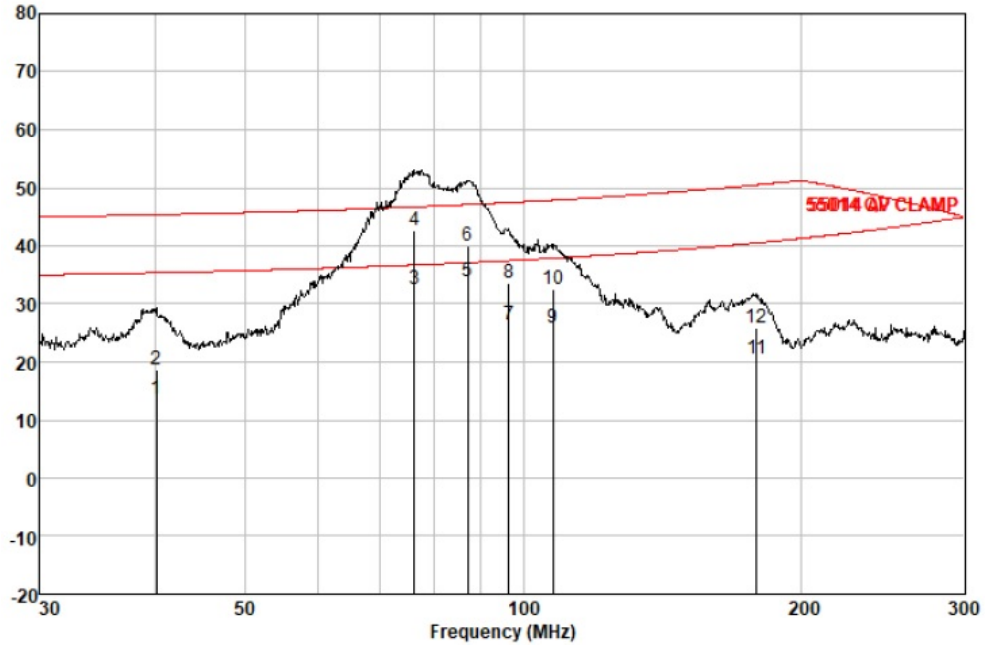

Frequency MHz	Read Level dBuV	Clamp Factor dB	Cable Loss dB	Measured Level dBuV	Limit Line dBuV	Over limit dB	Remark
40.10	9.64	2.66	1.36	13.66	35.37	-21.71	Average
40.10	14.67	2.66	1.36	18.69	45.37	-26.68	QP
76.21	30.40	0.18	2.02	32.60	36.71	-4.11	Average
76.21	40.50	0.18	2.02	42.70	46.71	-4.01	QP
87.14	31.92	-0.28	2.15	33.79	37.12	-3.33	Average
87.14	38.05	-0.28	2.15	39.92	47.12	-7.20	QP
96.41	24.69	-0.61	2.38	26.46	37.46	-11.00	Average
96.41	31.89	-0.61	2.38	33.66	47.46	-13.80	QP
107.68	22.55	0.67	2.63	25.85	37.88	-12.03	Average
107.68	29.28	0.67	2.63	32.58	47.88	-15.30	QP
178.70	19.21	-1.93	3.26	20.54	40.51	-19.97	Average
178.70	24.61	-1.93	3.26	25.94	50.51	-24.57	QP



Unless otherwise agreed in writing, this document is issued by the Company subject to its General Conditions of Service printed overleaf, available on request or accessible at <http://www.sgs.com/en/Terms-and-Conditions.aspx> and, for electronic format documents, subject to Terms and Conditions for Electronic Documents at <http://www.sgs.com/en/Terms-and-Conditions/Terms-e-Documents.aspx>. Attention is drawn to the limitation of liability, indemnification and jurisdiction issues defined therein. Any holder of this document is advised that information contained hereon reflects the Company's findings at the time of its intervention only and within the limits of Client's instructions, if any. The Company's sole responsibility is to its Client and this document does not exonerate parties to a transaction from exercising all their rights and obligations under the transaction documents. This document cannot be reproduced except in full, without prior written approval of the Company. Any unauthorized alteration, forgery or falsification of the content or appearance of this document is unlawful and offenders may be prosecuted to the fullest extent of the law. Unless otherwise stated the results shown in this test report refer only to the sample(s) tested and such sample(s) are retained for 30 days only.

Attention: To check the authenticity of testing /inspection report & certificate, please contact us at telephone: (86-755) 8307 1443, or email: CN.Doccheck@sgs.com

6.3 Discontinuous Disturbance (150kHz-30MHz)

Test Requirement: EN 55014-1:2017

Test Method: EN 55014-1:2017

Frequency Range: 150kHz to 30MHz

Remark:

Not applicable. The EUT belongs to exceptions from the click definition in clause 4.2.3.1,

“4.2.3.1 Individual switching operations

The disturbance from individual switching operations, caused directly or indirectly, manually or by similar activities on a switch or a control which is included in an appliance or otherwise to be used for:

a) the purpose of mains connection or disconnection only;

b) the purpose of programme selection only;

c) the control of energy or speed by switching between a limited number of fixed positions;

d) the changing of the manual setting of a continuously adjustable control such as a variable speed device for water extraction or electronic thermostats, is to be disregarded for the purpose of testing the appliance for compliance with the limits of radio disturbance set out in this standard.

Examples of switches included in this subclause are the on/off switches for apparatus (including foot activated), for instance the switch for an electric typewriter, manual switches for heat and air flow control in fan heaters and hair dryers, as well as the indirectly operated switch in a cupboard, wardrobe or refrigerator, and sensor-operated switches, etc. Switches which usually will be repeatedly operated are not included in this subclause, e.g. for sewing machines, calculating machines, soldering equipment, etc. (see 7.2.3. and 7.3.2.4.c).

Also the disturbance caused by the operation of any switching device or control which is included in an appliance for the purpose of mains disconnection for safety only, is to be disregarded for the purpose of testing the appliance for compliance with the limits of radio disturbance as described in this standard.”



Unless otherwise agreed in writing, this document is issued by the Company subject to its General Conditions of Service printed overleaf, available on request or accessible at <http://www.sgs.com/en/Terms-and-Conditions.aspx> and, for electronic format documents, subject to Terms and Conditions for Electronic Documents at <http://www.sgs.com/en/Terms-and-Conditions/Terms-e-Documents.aspx>. Attention is drawn to the limitation of liability, indemnification and jurisdiction issues defined therein. Any holder of this document is advised that information contained hereon reflects the Company's findings at the time of its intervention only and within the limits of Client's instructions, if any. The Company's sole responsibility is to its Client and this document does not exonerate parties to a transaction from exercising all their rights and obligations under the transaction documents. This document cannot be reproduced except in full, without prior written approval of the Company. Any unauthorized alteration, forgery or falsification of the content or appearance of this document is unlawful and offenders may be prosecuted to the fullest extent of the law. Unless otherwise stated the results shown in this test report refer only to the sample(s) tested and such sample(s) are retained for 30 days only.

Attention: To check the authenticity of testing /inspection report & certificate, please contact us at telephone: (86-755) 8307 1443, or email: CN.Doccheck@sgs.com

6.4 Harmonic Current Emission

Test Requirement: EN IEC 61000-3-2:2019
 Test Method: EN IEC 61000-3-2:2019
 Frequency Range: 100Hz to 2kHz

6.4.1 E.U.T. Operation

Operating Environment:
 Temperature: 23 °C Humidity: 54 % RH Atmospheric Pressure: 1010 mbar
 Test Mode: a: Test the EUT in simulating the normal working condition under applicant's requirements.

6.4.2 Test Setup

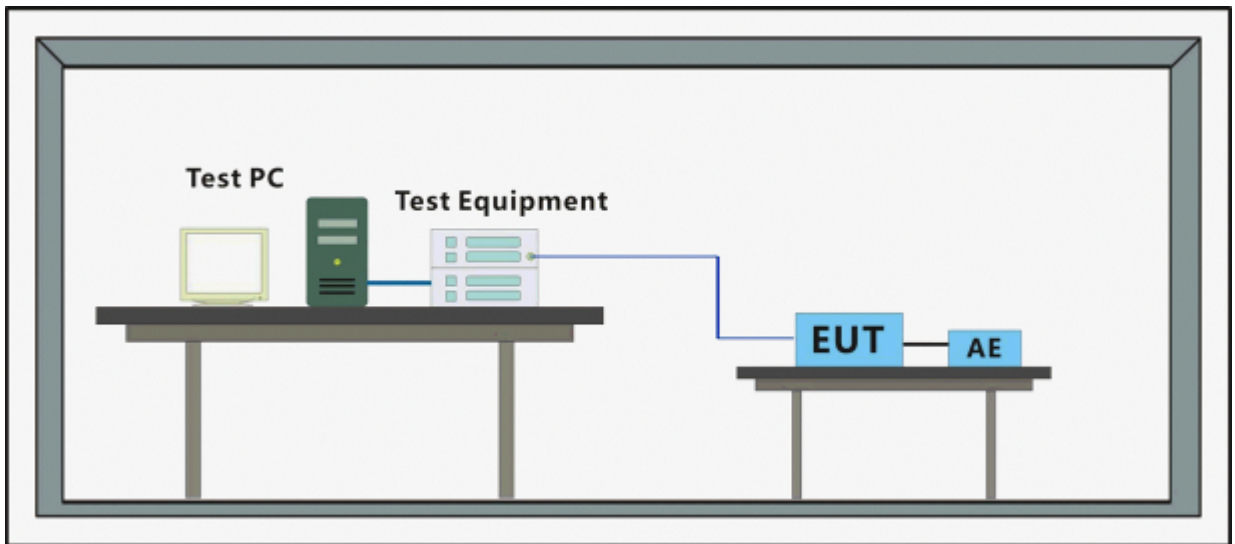

Unless otherwise agreed in writing, this document is issued by the Company subject to its General Conditions of Service printed overleaf, available on request or accessible at <http://www.sgs.com/en/Terms-and-Conditions.aspx> and, for electronic format documents, subject to Terms and Conditions for Electronic Documents at <http://www.sgs.com/en/Terms-and-Conditions/Terms-e-Documents.aspx>. Attention is drawn to the limitation of liability, indemnification and jurisdiction issues defined therein. Any holder of this document is advised that information contained hereon reflects the Company's findings at the time of its intervention only and within the limits of Client's instructions, if any. The Company's sole responsibility is to its Client and this document does not exonerate parties to a transaction from exercising all their rights and obligations under the transaction documents. This document cannot be reproduced except in full, without prior written approval of the Company. Any unauthorized alteration, forgery or falsification of the content or appearance of this document is unlawful and offenders may be prosecuted to the fullest extent of the law. Unless otherwise stated the results shown in this test report refer only to the sample(s) tested and such sample(s) are retained for 30 days only.

6.4.3 Measurement Data

Harmonics – Class-A per Ed. 4.0 (2014)(Run time)

Current Test Result Summary (Run time)

Test Result: Pass Source qualification: Normal
 THC(A): 0.093 I-THD(%): 18.4 POHC(A): 0.000 POHC Limit(A): 0.251
 Highest parameter values during test:
 V_{RMS} (Volts): 229.86 Frequency(Hz): 50.00
 I_{Peak} (Amps): 0.732 I_{RMS} (Amps): 0.506
 I_{Fund} (Amps): 0.503 Crest Factor: 1.447
 Power (Watts): 115.7 Power Factor: 0.995

Harm#	Harms(avg)	100%Limit	%of Limit	Harms(max)	150%Limit	%of Limit	Status
2	0.015	1.080	1.4	0.018	1.620	1.1	Pass
3	0.023	2.300	1.0	0.025	3.450	0.7	Pass
4	0.043	0.430	10.0	0.046	0.645	7.1	Pass
5	0.032	1.140	2.8	0.036	1.710	2.1	Pass
6	0.028	0.300	9.3	0.031	0.450	6.9	Pass
7	0.016	0.770	2.1	0.019	1.155	1.7	Pass
8	0.014	0.230	6.1	0.016	0.345	4.6	Pass
9	0.036	0.400	9.0	0.038	0.600	6.3	Pass
10	0.022	0.184	12.0	0.026	0.276	9.4	Pass
11	0.018	0.330	5.5	0.022	0.495	4.4	Pass
12	0.014	0.153	9.2	0.016	0.230	7.0	Pass
13	0.023	0.210	11.0	0.028	0.315	8.9	Pass
14	0.025	0.131	19.1	0.038	0.197	19.3	Pass
15	0.012	0.150	8.0	0.016	0.225	7.1	Pass
16	0.000	0.115	N/A	0.000	0.173	N/A	Pass
17	0.003	0.132	N/A	0.008	0.198	N/A	Pass
18	0.000	0.102	N/A	0.000	0.153	N/A	Pass
19	0.004	0.118	N/A	0.005	0.178	N/A	Pass
20	0.000	0.092	N/A	0.000	0.138	N/A	Pass
21	0.002	0.107	N/A	0.007	0.161	N/A	Pass
22	0.000	0.084	N/A	0.000	0.125	N/A	Pass
23	0.003	0.098	N/A	0.004	0.147	N/A	Pass
24	0.000	0.077	N/A	0.000	0.115	N/A	Pass
25	0.002	0.090	N/A	0.002	0.135	N/A	Pass
26	0.000	0.071	N/A	0.000	0.107	N/A	Pass
27	0.002	0.083	N/A	0.002	0.125	N/A	Pass
28	0.000	0.066	N/A	0.000	0.099	N/A	Pass
29	0.001	0.078	N/A	0.002	0.116	N/A	Pass
30	0.000	0.061	N/A	0.000	0.092	N/A	Pass
31	0.002	0.073	N/A	0.003	0.109	N/A	Pass
32	0.000	0.058	N/A	0.000	0.086	N/A	Pass
33	0.002	0.068	N/A	0.004	0.102	N/A	Pass
34	0.000	0.054	N/A	0.000	0.081	N/A	Pass
35	0.001	0.064	N/A	0.002	0.096	N/A	Pass
36	0.000	0.051	N/A	0.000	0.077	N/A	Pass
37	0.001	0.061	N/A	0.004	0.091	N/A	Pass
38	0.000	0.048	N/A	0.000	0.073	N/A	Pass
39	0.002	0.058	N/A	0.002	0.087	N/A	Pass
40	0.000	0.046	N/A	0.000	0.069	N/A	Pass



Unless otherwise agreed in writing, this document is issued by the Company subject to its General Conditions of Service printed overleaf, available on request or accessible at <http://www.sgs.com/en/Terms-and-Conditions.aspx> and, for electronic format documents, subject to Terms and Conditions for Electronic Documents at <http://www.sgs.com/en/Terms-and-Conditions/Terms-e-Documents.aspx>. Attention is drawn to the limitation of liability, indemnification and jurisdiction issues defined therein. Any holder of this document is advised that information contained hereon reflects the Company's findings at the time of its intervention only and within the limits of Client's instructions, if any. The Company's sole responsibility is to its Client and this document does not exonerate parties to a transaction from exercising all their rights and obligations under the transaction documents. This document cannot be reproduced except in full, without prior written approval of the Company. Any unauthorized alteration, forgery or falsification of the content or appearance of this document is unlawful and offenders may be prosecuted to the fullest extent of the law. Unless otherwise stated the results shown in this test report refer only to the sample(s) tested and such sample(s) are retained for 30 days only.

6.5 Voltage Fluctuations and Flicker

Test Requirement: EN 61000-3-3:2013
 Test Method: EN 61000-3-3:2013

6.5.1 E.U.T. Operation

Operating Environment:

Temperature: 23 °C Humidity: 52 % RH Atmospheric Pressure: 1010 mbar

Test Mode: a: Test the EUT in simulating the normal working condition under applicant's requirements.

6.5.2 Test Setup Diagram

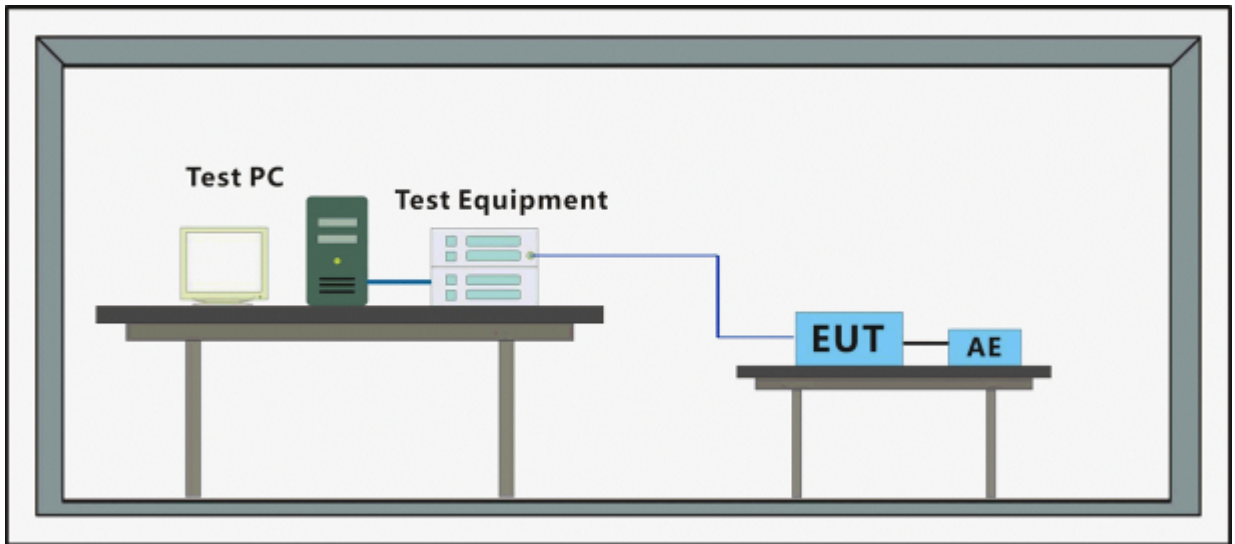

Unless otherwise agreed in writing, this document is issued by the Company subject to its General Conditions of Service printed overleaf, available on request or accessible at <http://www.sgs.com/en/Terms-and-Conditions.aspx> and, for electronic format documents, subject to Terms and Conditions for Electronic Documents at <http://www.sgs.com/en/Terms-and-Conditions/Terms-e-Documents.aspx>. Attention is drawn to the limitation of liability, indemnification and jurisdiction issues defined therein. Any holder of this document is advised that information contained hereon reflects the Company's findings at the time of its intervention only and within the limits of Client's instructions, if any. The Company's sole responsibility is to its Client and this document does not exonerate parties to a transaction from exercising all their rights and obligations under the transaction documents. This document cannot be reproduced except in full, without prior written approval of the Company. Any unauthorized alteration, forgery or falsification of the content or appearance of this document is unlawful and offenders may be prosecuted to the fullest extent of the law. Unless otherwise stated the results shown in this test report refer only to the sample(s) tested and such sample(s) are retained for 30 days only.

6.5.3 Measurement Data

Flicker Test Summary per EN 61000-3-3 Ed. 3.0 (2013) (Run time)

Test Result: Pass

Status: Test Completed

Pst_i and limit line

European Limits

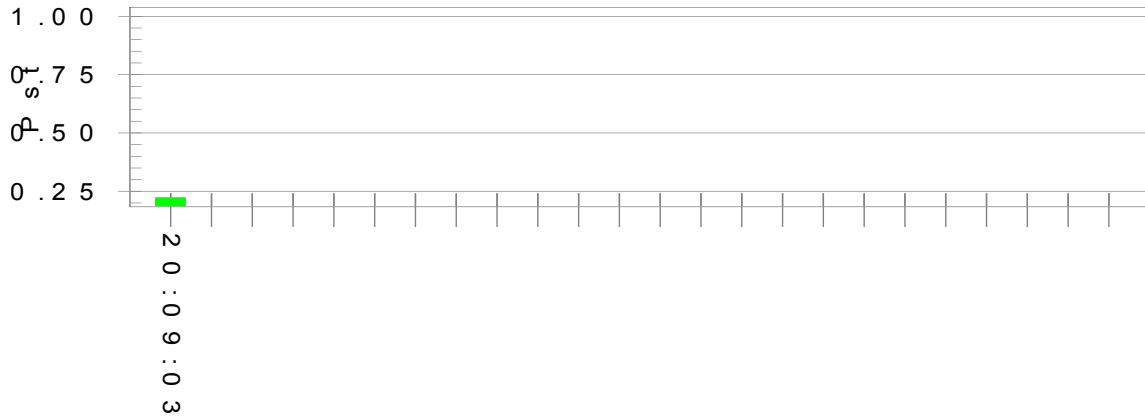

Parameter values recorded during the test:

Vrms at the end of test (Volt):	230.07			
T-max (mS):	0	Test limit (mS):	500.0	Pass
Highest dc (%):	0.78	Test limit (%):	3.30	Pass
Highest dmax (%):	0.85	Test limit (%):	4.00	Pass
Highest Pst (10 min. period):	0.228	Test limit:	1.000	Pass



Unless otherwise agreed in writing, this document is issued by the Company subject to its General Conditions of Service printed overleaf, available on request or accessible at <http://www.sgs.com/en/Terms-and-Conditions.aspx> and, for electronic format documents, subject to Terms and Conditions for Electronic Documents at <http://www.sgs.com/en/Terms-and-Conditions/Terms-e-Documents.aspx>. Attention is drawn to the limitation of liability, indemnification and jurisdiction issues defined therein. Any holder of this document is advised that information contained hereon reflects the Company's findings at the time of its intervention only and within the limits of Client's instructions, if any. The Company's sole responsibility is to its Client and this document does not exonerate parties to a transaction from exercising all their rights and obligations under the transaction documents. This document cannot be reproduced except in full, without prior written approval of the Company. Any unauthorized alteration, forgery or falsification of the content or appearance of this document is unlawful and offenders may be prosecuted to the fullest extent of the law. Unless otherwise stated the results shown in this test report refer only to the sample(s) tested and such sample(s) are retained for 30 days only.

7 Immunity Test Results

7.1 Performance Criteria Description in EN 55014-2:2015

- Criterion A** The apparatus shall continue to operate as intended during the test. No degradation of performance or loss of function is allowed below a performance level (or permissible loss of performance) specified by the manufacturer, when the apparatus is used as intended. If the minimum performance level or the permissible performance loss is not specified by the manufacturer, then either of these may be derived from the product description and documentation, and from what the user may reasonably expect from the apparatus if used as intended.
- Criterion B** The apparatus shall continue to operate as intended after the test. No degradation of performance or loss of function is allowed below a performance level (or permissible loss of performance) specified by the manufacturer, when the apparatus is used as intended. During the test, degradation of performance is allowed, however. No change of actual operating state or stored data is allowed. If the minimum performance level or the permissible performance loss is not specified by the manufacturer, then either of these may be derived from the product description and documentation and from what the user may reasonably expect from the apparatus if used as intended.
- Criterion C** Temporary loss of function is allowed, provided the function is self recoverable or can be restored by the operation of the controls, or by any operation specified in the instructions for use.



Unless otherwise agreed in writing, this document is issued by the Company subject to its General Conditions of Service printed overleaf, available on request or accessible at <http://www.sgs.com/en/Terms-and-Conditions.aspx> and, for electronic format documents, subject to Terms and Conditions for Electronic Documents at <http://www.sgs.com/en/Terms-and-Conditions/Terms-e-Documents.aspx>. Attention is drawn to the limitation of liability, indemnification and jurisdiction issues defined therein. Any holder of this document is advised that information contained hereon reflects the Company's findings at the time of its intervention only and within the limits of Client's instructions, if any. The Company's sole responsibility is to its Client and this document does not exonerate parties to a transaction from exercising all their rights and obligations under the transaction documents. This document cannot be reproduced except in full, without prior written approval of the Company. Any unauthorized alteration, forgery or falsification of the content or appearance of this document is unlawful and offenders may be prosecuted to the fullest extent of the law. Unless otherwise stated the results shown in this test report refer only to the sample(s) tested and such sample(s) are retained for 30 days only.

Attention: To check the authenticity of testing / inspection report & certificate, please contact us at telephone: (86-755) 8307 1443, or email: CN.Doccheck@sgs.com

7.2 Electrostatic Discharge

Test Requirement: EN 55014-2:2015
 Test Method: EN 61000-4-2:2009
 Performance Criterion: B
 Discharge Impedance: 330Ω/150pF
 Number of Discharge: Minimum 10 times at each test point
 Discharge Mode: Single Discharge
 Discharge Period: 1 second minimum

7.2.1 E.U.T. Operation

Operating Environment:

Temperature: 23 °C Humidity: 40 % RH Atmospheric Pressure: 1021 mbar

a: Test the EUT in simulating the normal working condition under applicant's requirements.

b: Test the EUT in idle mode.

7.2.2 Test Setup Diagram

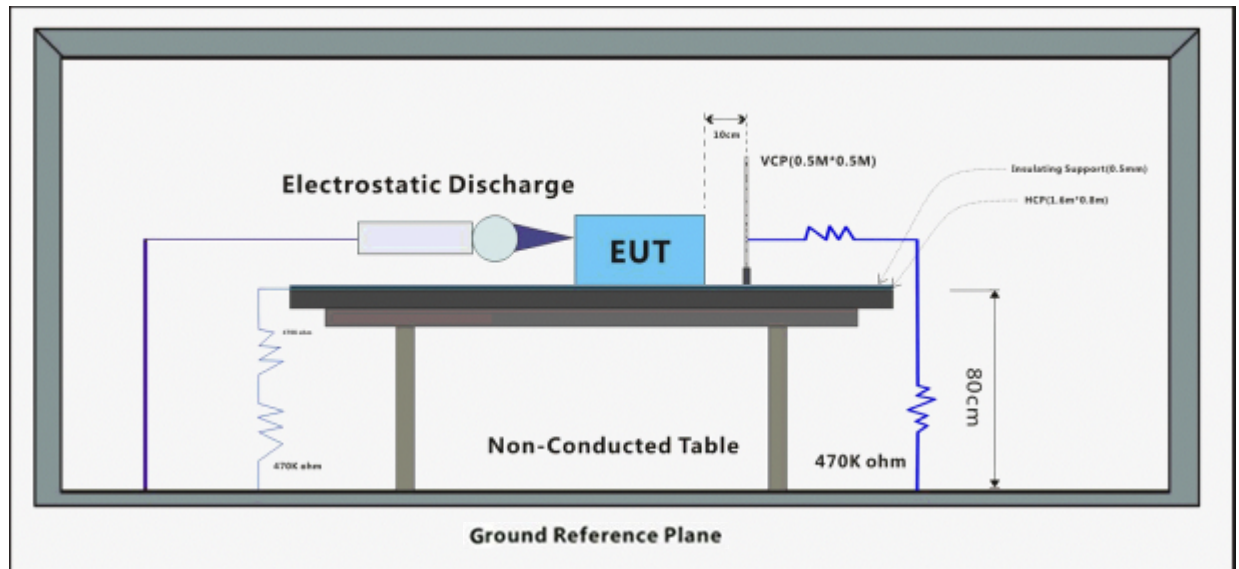

Unless otherwise agreed in writing, this document is issued by the Company subject to its General Conditions of Service printed overleaf, available on request or accessible at <http://www.sgs.com/en/Terms-and-Conditions.aspx> and, for electronic format documents, subject to Terms and Conditions for Electronic Documents at <http://www.sgs.com/en/Terms-and-Conditions/Terms-e-Documents.aspx>. Attention is drawn to the limitation of liability, indemnification and jurisdiction issues defined therein. Any holder of this document is advised that information contained hereon reflects the Company's findings at the time of its intervention only and within the limits of Client's instructions, if any. The Company's sole responsibility is to its Client and this document does not exonerate parties to a transaction from exercising all their rights and obligations under the transaction documents. This document cannot be reproduced except in full, without prior written approval of the Company. Any unauthorized alteration, forgery or falsification of the content or appearance of this document is unlawful and offenders may be prosecuted to the fullest extent of the law. Unless otherwise stated the results shown in this test report refer only to the sample(s) tested and such sample(s) are retained for 30 days only.

Attention: To check the authenticity of testing /inspection report & certificate, please contact us at telephone: (86-755) 8307 1443, or email: CN.Doccheck@sgs.com

7.2.3 Test Results:

Observations: Test Point:

Test points:

1. All insulated enclosure and seams.
2. All accessible metal parts of the enclosure.
3. All side

Discharge type	Level (kV)	Polarity	Test Point	Result / Observations
Air Discharge	8	+	1	A
Air Discharge	8	-	1	A
Contact Discharge	4	+	2	A
Contact Discharge	4	-	2	A
Horizontal Coupling	4	+	3	A
Horizontal Coupling	4	-	3	A
Vertical Coupling	4	+	3	A
Vertical Coupling	4	-	3	A

Results:

A: No degradation in the performance of the EUT was observed.



Unless otherwise agreed in writing, this document is issued by the Company subject to its General Conditions of Service printed overleaf, available on request or accessible at <http://www.sgs.com/en/Terms-and-Conditions.aspx> and, for electronic format documents, subject to Terms and Conditions for Electronic Documents at <http://www.sgs.com/en/Terms-and-Conditions/Terms-e-Documents.aspx>. Attention is drawn to the limitation of liability, indemnification and jurisdiction issues defined therein. Any holder of this document is advised that information contained hereon reflects the Company's findings at the time of its intervention only and within the limits of Client's instructions, if any. The Company's sole responsibility is to its Client and this document does not exonerate parties to a transaction from exercising all their rights and obligations under the transaction documents. This document cannot be reproduced except in full, without prior written approval of the Company. Any unauthorized alteration, forgery or falsification of the content or appearance of this document is unlawful and offenders may be prosecuted to the fullest extent of the law. Unless otherwise stated the results shown in this test report refer only to the sample(s) tested and such sample(s) are retained for 30 days only.

Attention: To check the authenticity of testing / inspection report & certificate, please contact us at telephone: (86-755) 8307 1443, or email: CN.Doccheck@sgs.com

7.3 Electrical Fast Transients/Burst at Power Port

Test Requirement: EN 55014-2:2015
 Test Method: EN 61000-4-4:2012
 Performance Criterion: B
 Repetition Frequency: 5kHz
 Burst Period: 300ms
 Test Duration: 2 minute per level & polarity

7.3.1 E.U.T. Operation

Operating Environment:

Temperature: 22 °C Humidity: 55 % RH Atmospheric Pressure: 1010 mbar

a: Test the EUT in simulating the normal working condition under applicant's requirements.

b: Test the EUT in idle mode.

7.3.2 Test Setup Diagram

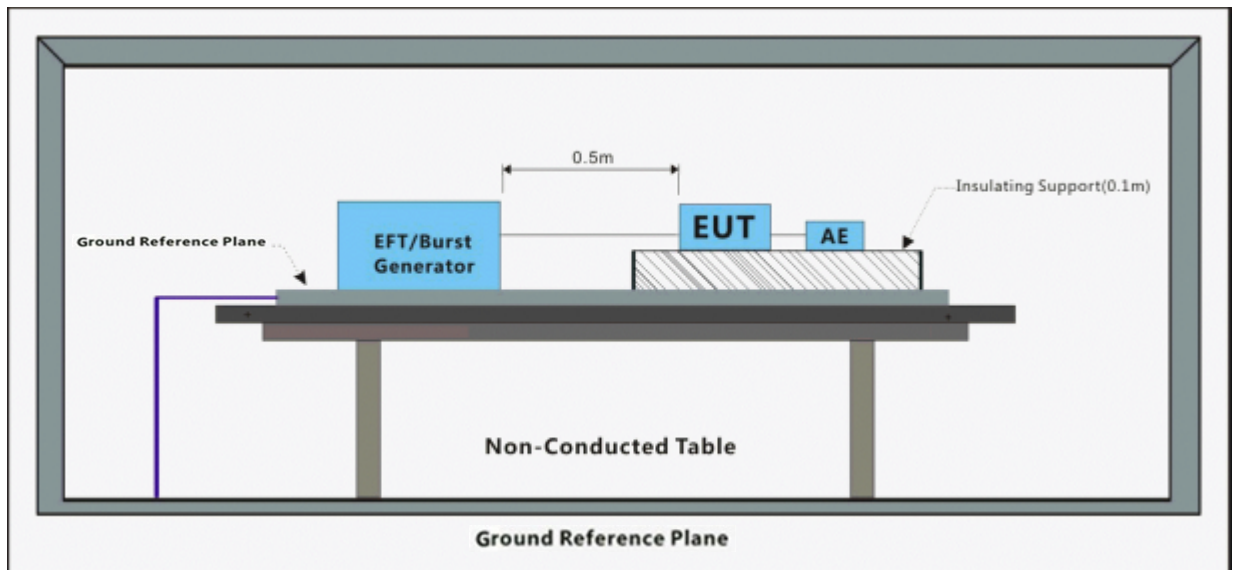

7.3.3 Test Results:

Test Line	Level (kV)	Polarity	Direct/Coupling	Result / Observations
AC power port	1	+	Direct	A
AC power port	1	-	Direct	A

Results:

A: No degradation in the performance of the EUT was observed.



Unless otherwise agreed in writing, this document is issued by the Company subject to its General Conditions of Service printed overleaf, available on request or accessible at <http://www.sgs.com/en/Terms-and-Conditions.aspx> and, for electronic format documents, subject to Terms and Conditions for Electronic Documents at <http://www.sgs.com/en/Terms-and-Conditions/Terms-e-Documents.aspx>. Attention is drawn to the limitation of liability, indemnification and jurisdiction issues defined therein. Any holder of this document is advised that information contained hereon reflects the Company's findings at the time of its intervention only and within the limits of Client's instructions, if any. The Company's sole responsibility is to its Client and this document does not exonerate parties to a transaction from exercising all their rights and obligations under the transaction documents. This document cannot be reproduced except in full, without prior written approval of the Company. Any unauthorized alteration, forgery or falsification of the content or appearance of this document is unlawful and offenders may be prosecuted to the fullest extent of the law. Unless otherwise stated the results shown in this test report refer only to the sample(s) tested and such sample(s) are retained for 30 days only.

7.4 Surge at Power Port

Test Requirement: EN 55014-2:2015
 Test Method: EN 61000-4-5:2014
 Performance Criterion: B
 Interval: 60s between each surge
 No. of surges: 5 positive at 90°, 5 negative at 270°.

7.4.1 E.U.T. Operation

Operating Environment:
 Temperature: 22 °C Humidity: 55 % RH Atmospheric Pressure: 1010 mbar
 a: Test the EUT in simulating the normal working condition under applicant's requirements.
 Test Mode: requirements.
 b: Test the EUT in idle mode.

7.4.2 Test Setup Diagram

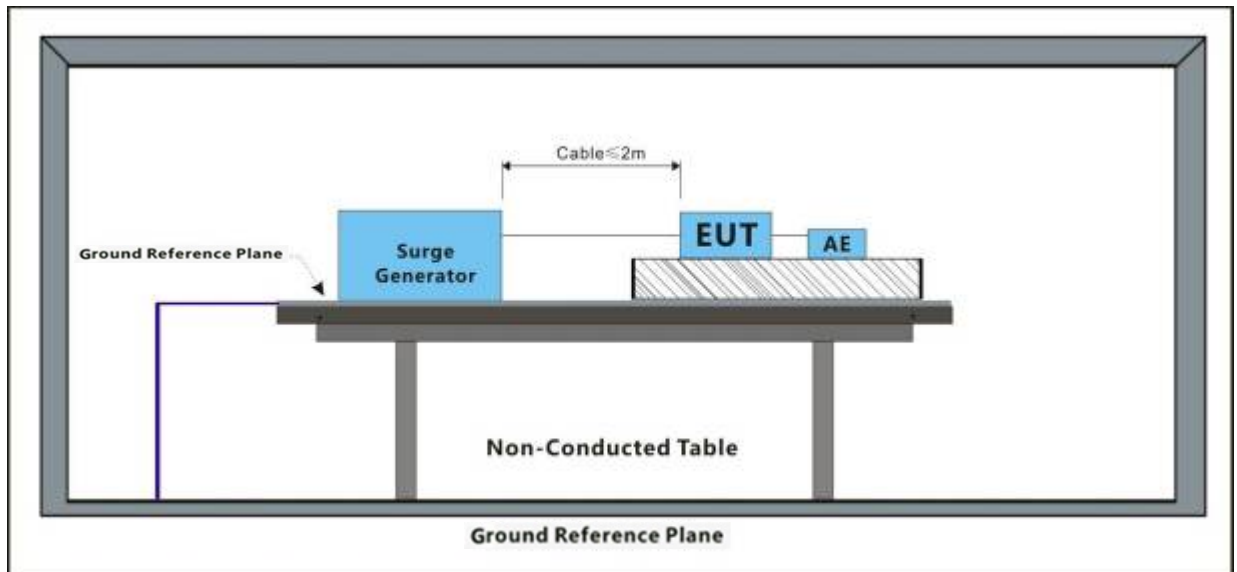

Unless otherwise agreed in writing, this document is issued by the Company subject to its General Conditions of Service printed overleaf, available on request or accessible at <http://www.sgs.com/en/Terms-and-Conditions.aspx> and, for electronic format documents, subject to Terms and Conditions for Electronic Documents at <http://www.sgs.com/en/Terms-and-Conditions/Terms-e-Documents.aspx>. Attention is drawn to the limitation of liability, indemnification and jurisdiction issues defined therein. Any holder of this document is advised that information contained hereon reflects the Company's findings at the time of its intervention only and within the limits of Client's instructions, if any. The Company's sole responsibility is to its Client and this document does not exonerate parties to a transaction from exercising all their rights and obligations under the transaction documents. This document cannot be reproduced except in full, without prior written approval of the Company. Any unauthorized alteration, forgery or falsification of the content or appearance of this document is unlawful and offenders may be prosecuted to the fullest extent of the law. Unless otherwise stated the results shown in this test report refer only to the sample(s) tested and such sample(s) are retained for 30 days only.

7.4.3 Test Results:

Test Line	Level (kV)	Polarity	Phase (deg)	Result / Observations
L-N	1	+	90°	A
L-N	1	-	270°	A
L-PE	2	+	90°	A
L-PE	2	-	270°	A
N-PE	2	+	90°	A
N-PE	2	-	270°	A

Results:

A: No degradation in the performance of the EUT was observed.



Unless otherwise agreed in writing, this document is issued by the Company subject to its General Conditions of Service printed overleaf, available on request or accessible at <http://www.sgs.com/en/Terms-and-Conditions.aspx> and, for electronic format documents, subject to Terms and Conditions for Electronic Documents at <http://www.sgs.com/en/Terms-and-Conditions/Terms-e-Documents.aspx>. Attention is drawn to the limitation of liability, indemnification and jurisdiction issues defined therein. Any holder of this document is advised that information contained hereon reflects the Company's findings at the time of its intervention only and within the limits of Client's instructions, if any. The Company's sole responsibility is to its Client and this document does not exonerate parties to a transaction from exercising all their rights and obligations under the transaction documents. This document cannot be reproduced except in full, without prior written approval of the Company. Any unauthorized alteration, forgery or falsification of the content or appearance of this document is unlawful and offenders may be prosecuted to the fullest extent of the law. Unless otherwise stated the results shown in this test report refer only to the sample(s) tested and such sample(s) are retained for 30 days only.

Attention: To check the authenticity of testing / inspection report & certificate, please contact us at telephone: (86-755) 8307 1443, or email: CN.Doccheck@sgs.com

7.5 Conducted Immunity at Power Port (150kHz-230MHz)

Test Requirement: EN 55014-2:2015
 Test Method: EN 61000-4-6:2014
 Performance Criterion: A
 Frequency Range: 0.15MHz to 230MHz
 Modulation: 80%, 1kHz Amplitude Modulation
 Step Size: 1%

7.5.1 E.U.T. Operation

Operating Environment:

Temperature: 23 °C Humidity: 52 % RH Atmospheric Pressure: 1010 mbar

a: Test the EUT in simulating the normal working condition under applicant's requirements.

Test Mode: b: Test the EUT in idle mode.

7.5.2 Test Setup Diagram

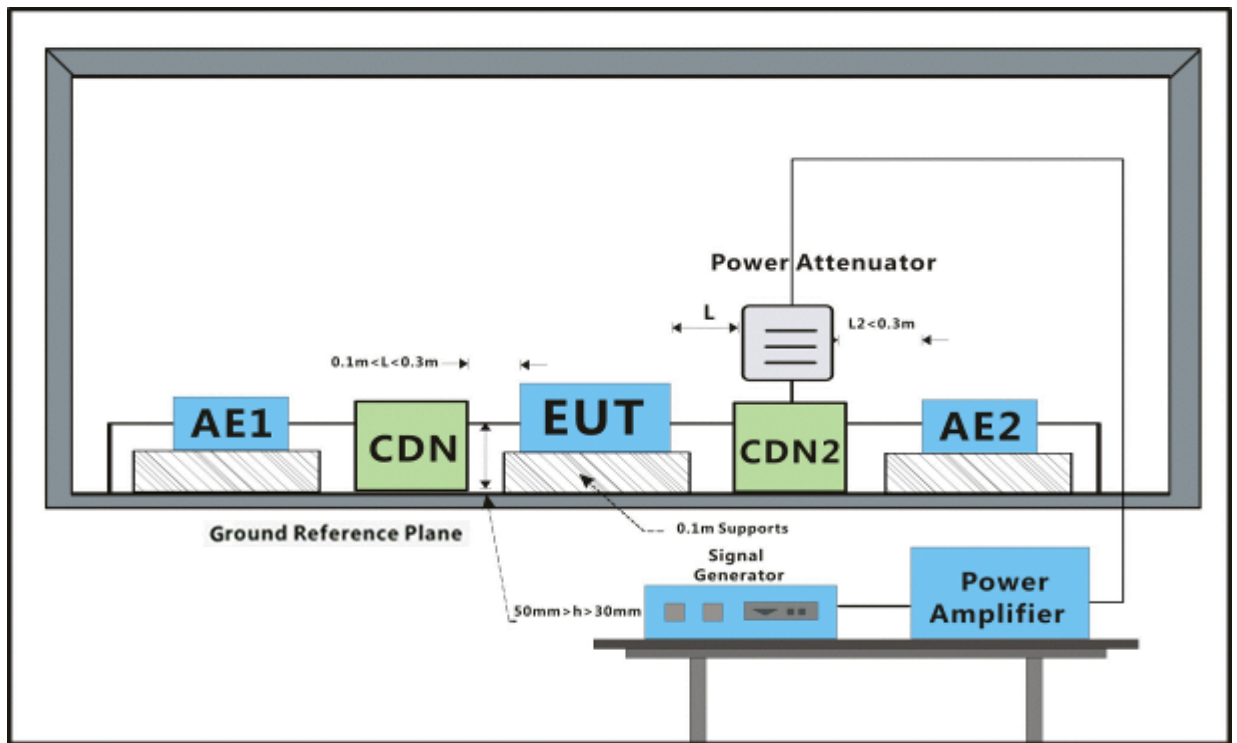

Unless otherwise agreed in writing, this document is issued by the Company subject to its General Conditions of Service printed overleaf, available on request or accessible at <http://www.sgs.com/en/Terms-and-Conditions.aspx> and, for electronic format documents, subject to Terms and Conditions for Electronic Documents at <http://www.sgs.com/en/Terms-and-Conditions/Terms-e-Documents.aspx>. Attention is drawn to the limitation of liability, indemnification and jurisdiction issues defined therein. Any holder of this document is advised that information contained hereon reflects the Company's findings at the time of its intervention only and within the limits of Client's instructions, if any. The Company's sole responsibility is to its Client and this document does not exonerate parties to a transaction from exercising all their rights and obligations under the transaction documents. This document cannot be reproduced except in full, without prior written approval of the Company. Any unauthorized alteration, forgery or falsification of the content or appearance of this document is unlawful and offenders may be prosecuted to the fullest extent of the law. Unless otherwise stated the results shown in this test report refer only to the sample(s) tested and such sample(s) are retained for 30 days only.

7.5.3 Test Results:

Cable port	Level (Vrms)	Direct/Coupling	Dwell time	Result / Observations
AC power port	3	Direct	2s	A

Results:

A: No degradation in the performance of the EUT was observed.



Unless otherwise agreed in writing, this document is issued by the Company subject to its General Conditions of Service printed overleaf, available on request or accessible at <http://www.sgs.com/en/Terms-and-Conditions.aspx> and, for electronic format documents, subject to Terms and Conditions for Electronic Documents at <http://www.sgs.com/en/Terms-and-Conditions/Terms-e-Documents.aspx>. Attention is drawn to the limitation of liability, indemnification and jurisdiction issues defined therein. Any holder of this document is advised that information contained hereon reflects the Company's findings at the time of its intervention only and within the limits of Client's instructions, if any. The Company's sole responsibility is to its Client and this document does not exonerate parties to a transaction from exercising all their rights and obligations under the transaction documents. This document cannot be reproduced except in full, without prior written approval of the Company. Any unauthorized alteration, forgery or falsification of the content or appearance of this document is unlawful and offenders may be prosecuted to the fullest extent of the law. Unless otherwise stated the results shown in this test report refer only to the sample(s) tested and such sample(s) are retained for 30 days only.
Attention: To check the authenticity of testing / inspection report & certificate, please contact us at telephone: (86-755) 8307 1443, or email: CN.Doccheck@sgs.com

7.6 Voltage Dips and Interruptions

Test Requirement:	EN 55014-2:2015
Test Method:	EN 61000-4-11:2004
Performance Criterion:	
For 50Hz	0% of UT (Supply Voltage) for 0.5 Periods: C; 40% of UT for 10 Periods: C; 70% of UT for 25 Periods: C
For 60Hz	0% of UT (Supply Voltage) for 0.5 Periods: C; 40% of UT for 12 Periods: C; 70% of UT for 30 Periods: C
No. of Dips / Interruptions:	3 per Level
Time between dropout	10s

7.6.1 E.U.T. Operation

Operating Environment:

Temperature: 22 °C Humidity: 53 % RH Atmospheric Pressure: 1010 mbar

a: Test the EUT in simulating the normal working condition under applicant's requirements.

b: Test the EUT in idle mode.

7.6.2 Test Setup Diagram

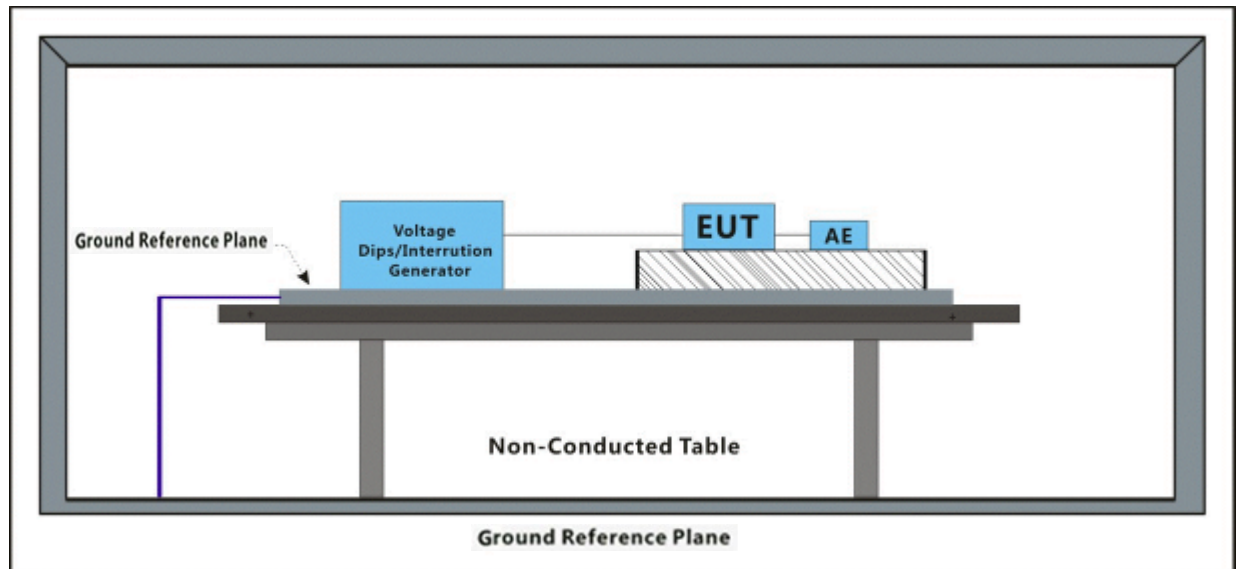

Unless otherwise agreed in writing, this document is issued by the Company subject to its General Conditions of Service printed overleaf, available on request or accessible at <http://www.sgs.com/en/Terms-and-Conditions.aspx> and, for electronic format documents, subject to Terms and Conditions for Electronic Documents at <http://www.sgs.com/en/Terms-and-Conditions/Terms-e-Documents.aspx>. Attention is drawn to the limitation of liability, indemnification and jurisdiction issues defined therein. Any holder of this document is advised that information contained hereon reflects the Company's findings at the time of its intervention only and within the limits of Client's instructions, if any. The Company's sole responsibility is to its Client and this document does not exonerate parties to a transaction from exercising all their rights and obligations under the transaction documents. This document cannot be reproduced except in full, without prior written approval of the Company. Any unauthorized alteration, forgery or falsification of the content or appearance of this document is unlawful and offenders may be prosecuted to the fullest extent of the law. Unless otherwise stated the results shown in this test report refer only to the sample(s) tested and such sample(s) are retained for 30 days only.

Attention: To check the authenticity of testing /inspection report & certificate, please contact us at telephone: (86-755) 8307 1443, or email: CN.Doccheck@sgs.com

7.6.3 Test Results:

For 50Hz

Level % UT	Phase (deg)	Duration	No. of Dips / Interruptions	Result / Observations
0	0°	0.5 Periods	3	A
0	180°	0.5 Periods	3	A
40	0°	10 Periods	3	A
40	180°	10 Periods	3	A
70	0°	25 Periods	3	A
70	180°	25 Periods	3	A

Results:

A: No degradation in the performance of the EUT was observed.

For 60Hz

Level % UT	Phase (deg)	Duration	No. of Dips / Interruptions	Result / Observations
0	0°	0.5 Periods	3	A
0	180°	0.5 Periods	3	A
40	0°	12 Periods	3	A
40	180°	12 Periods	3	A
70	0°	30 Periods	3	A
70	180°	30 Periods	3	A

Results:

A: No degradation in the performance of the EUT was observed.



Unless otherwise agreed in writing, this document is issued by the Company subject to its General Conditions of Service printed overleaf, available on request or accessible at <http://www.sgs.com/en/Terms-and-Conditions.aspx> and, for electronic format documents, subject to Terms and Conditions for Electronic Documents at <http://www.sgs.com/en/Terms-and-Conditions/Terms-e-Documents.aspx>. Attention is drawn to the limitation of liability, indemnification and jurisdiction issues defined therein. Any holder of this document is advised that information contained hereon reflects the Company's findings at the time of its intervention only and within the limits of Client's instructions, if any. The Company's sole responsibility is to its Client and this document does not exonerate parties to a transaction from exercising all their rights and obligations under the transaction documents. This document cannot be reproduced except in full, without prior written approval of the Company. Any unauthorized alteration, forgery or falsification of the content or appearance of this document is unlawful and offenders may be prosecuted to the fullest extent of the law. Unless otherwise stated the results shown in this test report refer only to the sample(s) tested and such sample(s) are retained for 30 days only.

8 Photographs

8.1 EUT Constructional Details

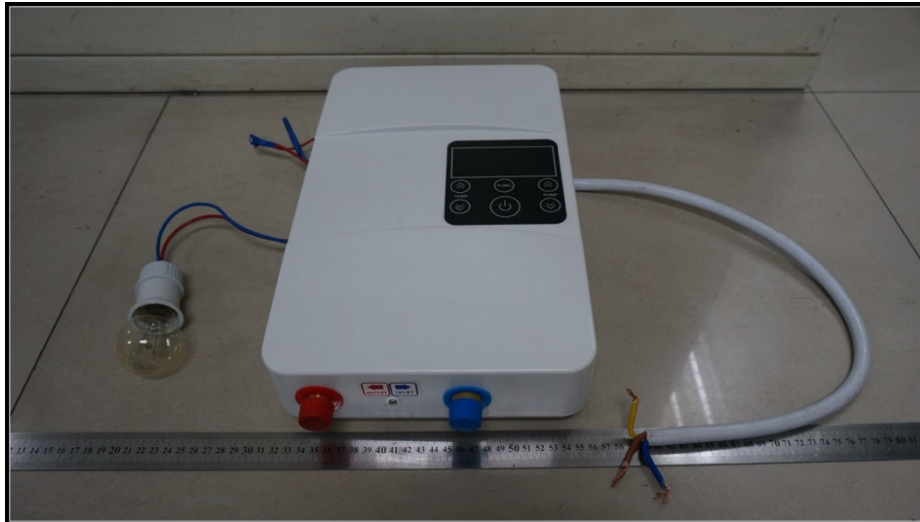

Unless otherwise agreed in writing, this document is issued by the Company subject to its General Conditions of Service printed overleaf, available on request or accessible at <http://www.sgs.com/en/Terms-and-Conditions.aspx> and, for electronic format documents, subject to Terms and Conditions for Electronic Documents at <http://www.sgs.com/en/Terms-and-Conditions/Terms-e-Documents.aspx>. Attention is drawn to the limitation of liability, indemnification and jurisdiction issues defined therein. Any holder of this document is advised that information contained hereon reflects the Company's findings at the time of its intervention only and within the limits of Client's instructions, if any. The Company's sole responsibility is to its Client and this document does not exonerate parties to a transaction from exercising all their rights and obligations under the transaction documents. This document cannot be reproduced except in full, without prior written approval of the Company. Any unauthorized alteration, forgery or falsification of the content or appearance of this document is unlawful and offenders may be prosecuted to the fullest extent of the law. Unless otherwise stated the results shown in this test report refer only to the sample(s) tested and such sample(s) are retained for 30 days only.

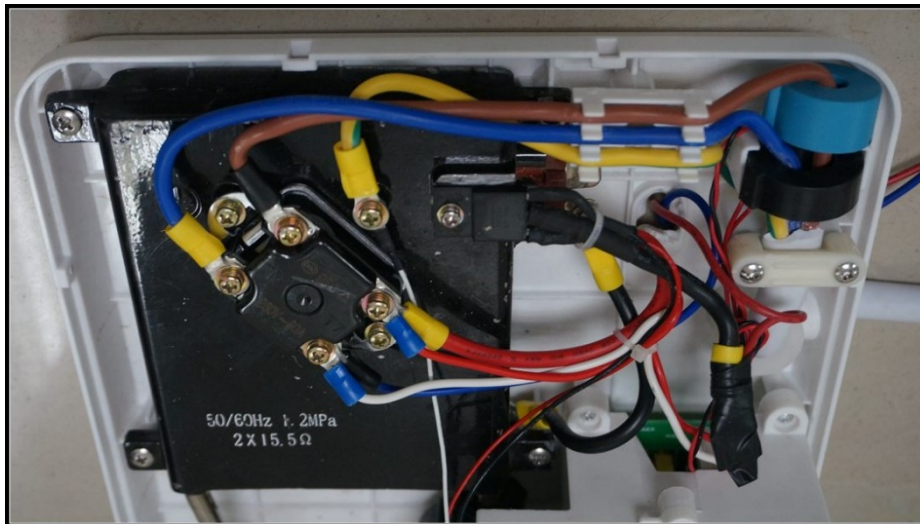
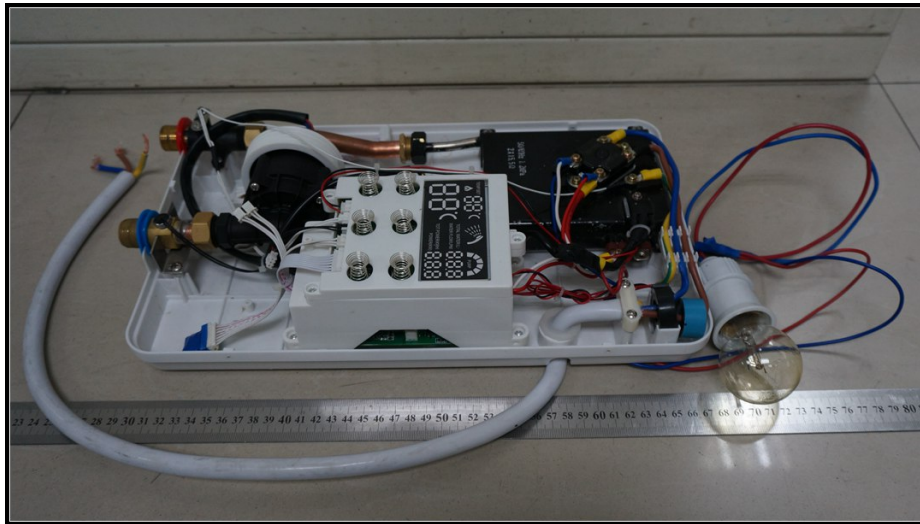

Unless otherwise agreed in writing, this document is issued by the Company subject to its General Conditions of Service printed overleaf, available on request or accessible at <http://www.sgs.com/en/Terms-and-Conditions.aspx> and, for electronic format documents, subject to Terms and Conditions for Electronic Documents at <http://www.sgs.com/en/Terms-and-Conditions/Terms-e-Documents.aspx>. Attention is drawn to the limitation of liability, indemnification and jurisdiction issues defined therein. Any holder of this document is advised that information contained hereon reflects the Company's findings at the time of its intervention only and within the limits of Client's instructions, if any. The Company's sole responsibility is to its Client and this document does not exonerate parties to a transaction from exercising all their rights and obligations under the transaction documents. This document cannot be reproduced except in full, without prior written approval of the Company. Any unauthorized alteration, forgery or falsification of the content or appearance of this document is unlawful and offenders may be prosecuted to the fullest extent of the law. Unless otherwise stated the results shown in this test report refer only to the sample(s) tested and such sample(s) are retained for 30 days only.

Attention: To check the authenticity of testing /inspection report & certificate, please contact us at telephone: (86-755) 8307 1443, or email: CN.Doccheck@sgs.com

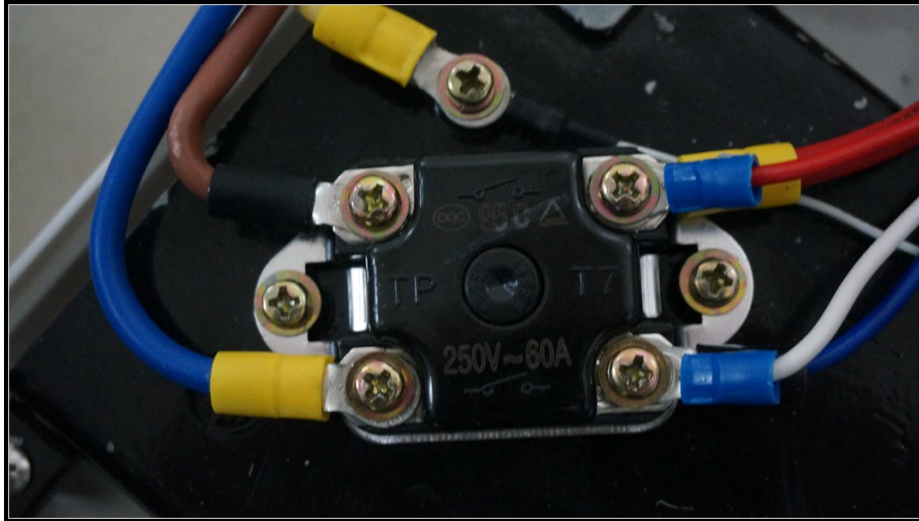

Unless otherwise agreed in writing, this document is issued by the Company subject to its General Conditions of Service printed overleaf, available on request or accessible at <http://www.sgs.com/en/Terms-and-Conditions.aspx> and, for electronic format documents, subject to Terms and Conditions for Electronic Documents at <http://www.sgs.com/en/Terms-and-Conditions/Terms-e-Documents.aspx>. Attention is drawn to the limitation of liability, indemnification and jurisdiction issues defined therein. Any holder of this document is advised that information contained hereon reflects the Company's findings at the time of its intervention only and within the limits of Client's instructions, if any. The Company's sole responsibility is to its Client and this document does not exonerate parties to a transaction from exercising all their rights and obligations under the transaction documents. This document cannot be reproduced except in full, without prior written approval of the Company. Any unauthorized alteration, forgery or falsification of the content or appearance of this document is unlawful and offenders may be prosecuted to the fullest extent of the law. Unless otherwise stated the results shown in this test report refer only to the sample(s) tested and such sample(s) are retained for 30 days only.

Attention: To check the authenticity of testing /inspection report & certificate, please contact us at telephone: (86-755) 8307 1443, or email: CN.Doccheck@sgs.com



Unless otherwise agreed in writing, this document is issued by the Company subject to its General Conditions of Service printed overleaf, available on request or accessible at <http://www.sgs.com/en/Terms-and-Conditions.aspx> and, for electronic format documents, subject to Terms and Conditions for Electronic Documents at <http://www.sgs.com/en/Terms-and-Conditions/Terms-e-Documents.aspx>. Attention is drawn to the limitation of liability, indemnification and jurisdiction issues defined therein. Any holder of this document is advised that information contained hereon reflects the Company's findings at the time of its intervention only and within the limits of Client's instructions, if any. The Company's sole responsibility is to its Client and this document does not exonerate parties to a transaction from exercising all their rights and obligations under the transaction documents. This document cannot be reproduced except in full, without prior written approval of the Company. Any unauthorized alteration, forgery or falsification of the content or appearance of this document is unlawful and offenders may be prosecuted to the fullest extent of the law. Unless otherwise stated the results shown in this test report refer only to the sample(s) tested and such sample(s) are retained for 30 days only.

Attention: To check the authenticity of testing /inspection report & certificate, please contact us at telephone: (86-755) 8307 1443, or email: CN.Doccheck@sgs.com



Unless otherwise agreed in writing, this document is issued by the Company subject to its General Conditions of Service printed overleaf, available on request or accessible at <http://www.sgs.com/en/Terms-and-Conditions.aspx> and, for electronic format documents, subject to Terms and Conditions for Electronic Documents at <http://www.sgs.com/en/Terms-and-Conditions/Terms-e-Documents.aspx>. Attention is drawn to the limitation of liability, indemnification and jurisdiction issues defined therein. Any holder of this document is advised that information contained hereon reflects the Company's findings at the time of its intervention only and within the limits of Client's instructions, if any. The Company's sole responsibility is to its Client and this document does not exonerate parties to a transaction from exercising all their rights and obligations under the transaction documents. This document cannot be reproduced except in full, without prior written approval of the Company. Any unauthorized alteration, forgery or falsification of the content or appearance of this document is unlawful and offenders may be prosecuted to the fullest extent of the law. Unless otherwise stated the results shown in this test report refer only to the sample(s) tested and such sample(s) are retained for 30 days only.
Attention: To check the authenticity of testing /inspection report & certificate, please contact us at telephone: (86-755) 8307 1443, or email: CN.Doccheck@sgs.com

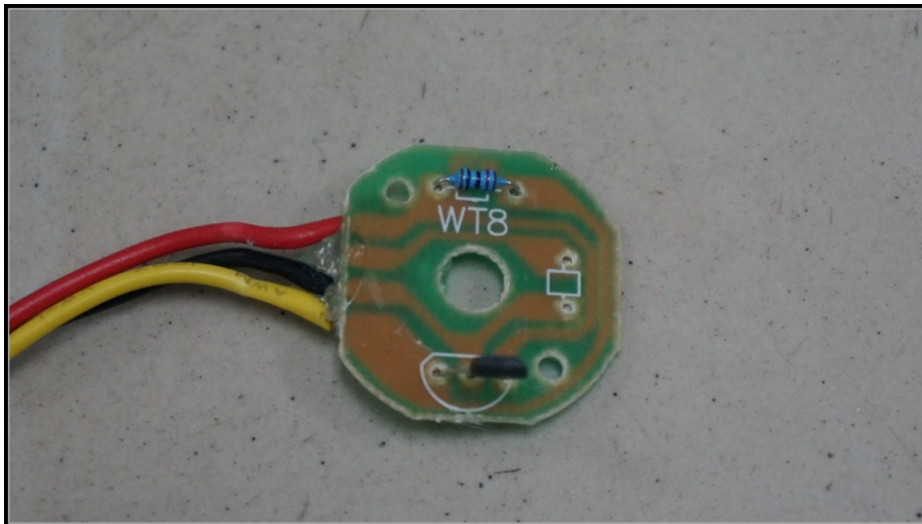

Unless otherwise agreed in writing, this document is issued by the Company subject to its General Conditions of Service printed overleaf, available on request or accessible at <http://www.sgs.com/en/Terms-and-Conditions.aspx> and, for electronic format documents, subject to Terms and Conditions for Electronic Documents at <http://www.sgs.com/en/Terms-and-Conditions/Terms-e-Documents.aspx>. Attention is drawn to the limitation of liability, indemnification and jurisdiction issues defined therein. Any holder of this document is advised that information contained hereon reflects the Company's findings at the time of its intervention only and within the limits of Client's instructions, if any. The Company's sole responsibility is to its Client and this document does not exonerate parties to a transaction from exercising all their rights and obligations under the transaction documents. This document cannot be reproduced except in full, without prior written approval of the Company. Any unauthorized alteration, forgery or falsification of the content or appearance of this document is unlawful and offenders may be prosecuted to the fullest extent of the law. Unless otherwise stated the results shown in this test report refer only to the sample(s) tested and such sample(s) are retained for 30 days only.

Attention: To check the authenticity of testing /inspection report & certificate, please contact us at telephone: (86-755) 8307 1443, or email: CN.Doccheck@sgs.com

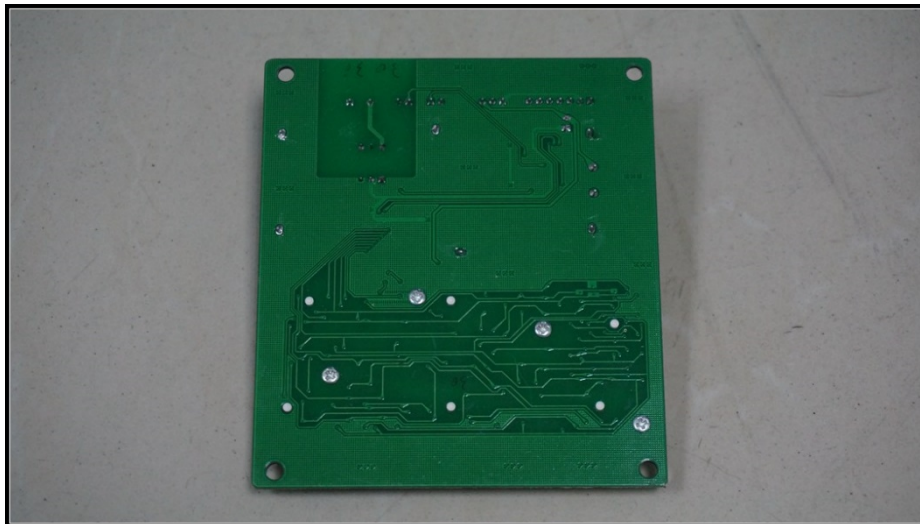

Unless otherwise agreed in writing, this document is issued by the Company subject to its General Conditions of Service printed overleaf, available on request or accessible at <http://www.sgs.com/en/Terms-and-Conditions.aspx> and, for electronic format documents, subject to Terms and Conditions for Electronic Documents at <http://www.sgs.com/en/Terms-and-Conditions/Terms-e-Documents.aspx>. Attention is drawn to the limitation of liability, indemnification and jurisdiction issues defined therein. Any holder of this document is advised that information contained hereon reflects the Company's findings at the time of its intervention only and within the limits of Client's instructions, if any. The Company's sole responsibility is to its Client and this document does not exonerate parties to a transaction from exercising all their rights and obligations under the transaction documents. This document cannot be reproduced except in full, without prior written approval of the Company. Any unauthorized alteration, forgery or falsification of the content or appearance of this document is unlawful and offenders may be prosecuted to the fullest extent of the law. Unless otherwise stated the results shown in this test report refer only to the sample(s) tested and such sample(s) are retained for 30 days only.

Attention: To check the authenticity of testing /inspection report & certificate, please contact us at telephone: (86-755) 8307 1443, or email: CN.Doccheck@sgs.com

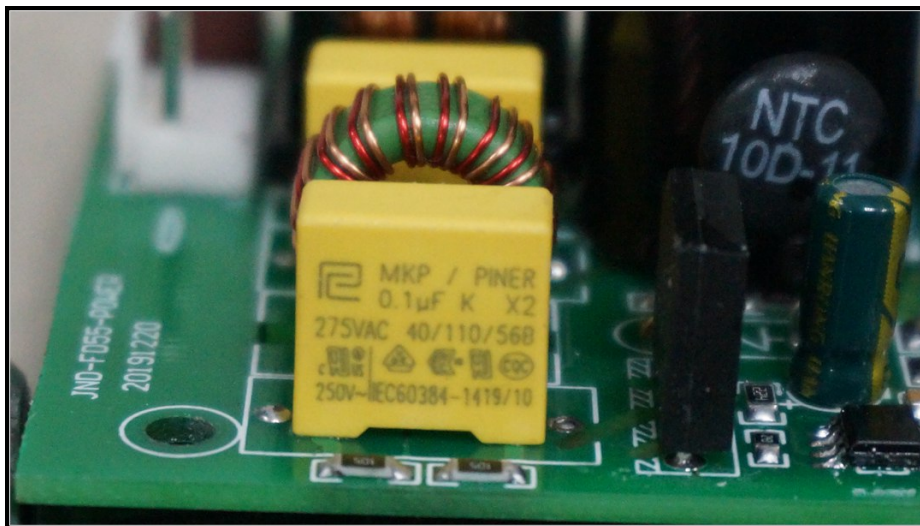
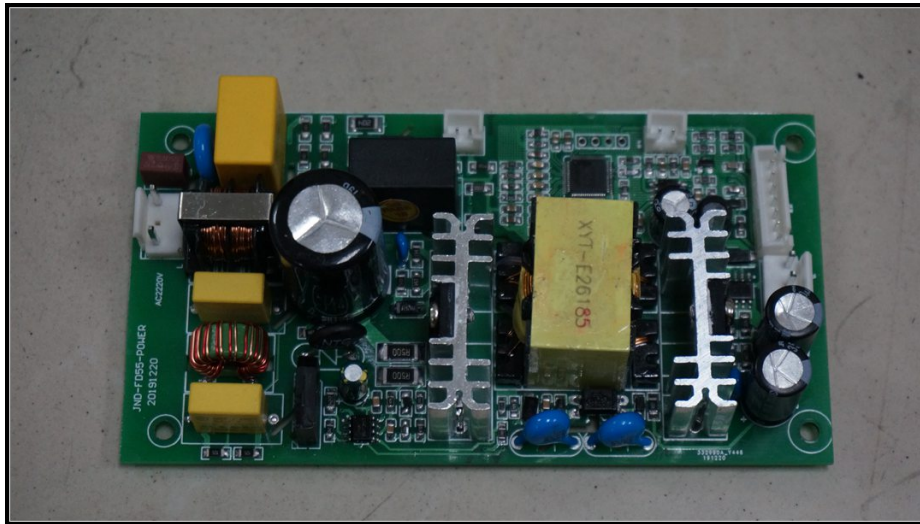

Unless otherwise agreed in writing, this document is issued by the Company subject to its General Conditions of Service printed overleaf, available on request or accessible at <http://www.sgs.com/en/Terms-and-Conditions.aspx> and, for electronic format documents, subject to Terms and Conditions for Electronic Documents at <http://www.sgs.com/en/Terms-and-Conditions/Terms-e-Documents.aspx>. Attention is drawn to the limitation of liability, indemnification and jurisdiction issues defined therein. Any holder of this document is advised that information contained hereon reflects the Company's findings at the time of its intervention only and within the limits of Client's instructions, if any. The Company's sole responsibility is to its Client and this document does not exonerate parties to a transaction from exercising all their rights and obligations under the transaction documents. This document cannot be reproduced except in full, without prior written approval of the Company. Any unauthorized alteration, forgery or falsification of the content or appearance of this document is unlawful and offenders may be prosecuted to the fullest extent of the law. Unless otherwise stated the results shown in this test report refer only to the sample(s) tested and such sample(s) are retained for 30 days only.

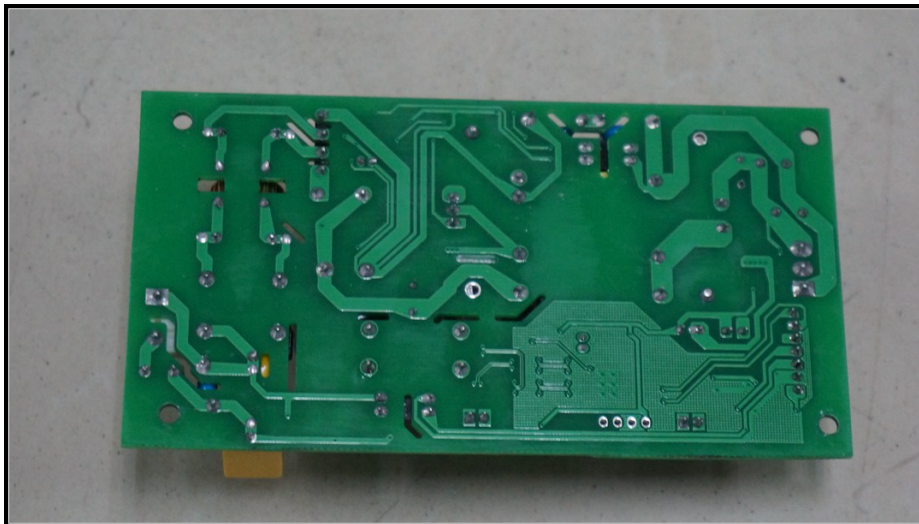

--End of Report--



Unless otherwise agreed in writing, this document is issued by the Company subject to its General Conditions of Service printed overleaf, available on request or accessible at <http://www.sgs.com/en/Terms-and-Conditions.aspx> and, for electronic format documents, subject to Terms and Conditions for Electronic Documents at <http://www.sgs.com/en/Terms-and-Conditions/Terms-e-Documents.aspx>. Attention is drawn to the limitation of liability, indemnification and jurisdiction issues defined therein. Any holder of this document is advised that information contained hereon reflects the Company's findings at the time of its intervention only and within the limits of Client's instructions, if any. The Company's sole responsibility is to its Client and this document does not exonerate parties to a transaction from exercising all their rights and obligations under the transaction documents. This document cannot be reproduced except in full, without prior written approval of the Company. Any unauthorized alteration, forgery or falsification of the content or appearance of this document is unlawful and offenders may be prosecuted to the fullest extent of the law. Unless otherwise stated the results shown in this test report refer only to the sample(s) tested and such sample(s) are retained for 30 days only.

Attention: To check the authenticity of testing /inspection report & certificate, please contact us at telephone: (86-755) 8307 1443, or email: CN.Doccheck@sgs.com