

Instructions for magnet money clip wallet

Parts

- 1) 2 Needles
- 2) Thread

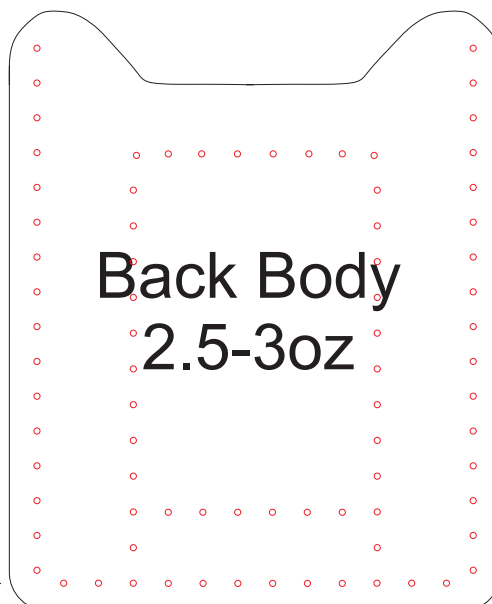
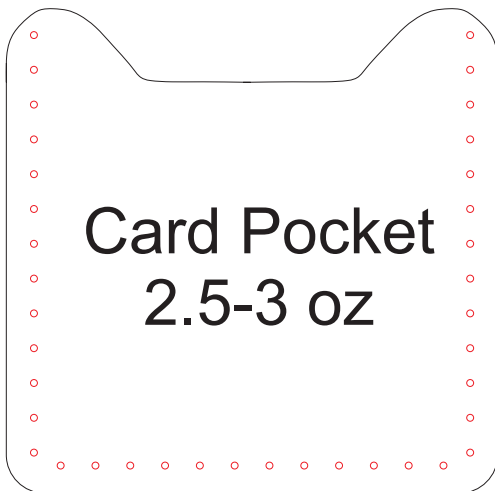
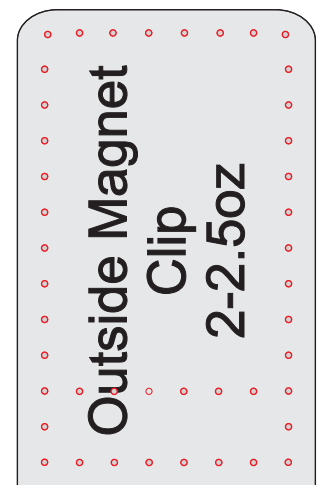
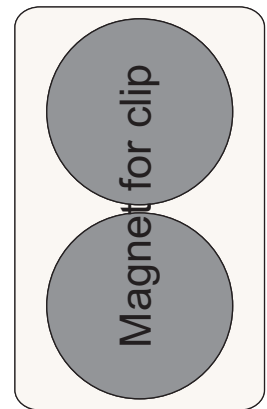
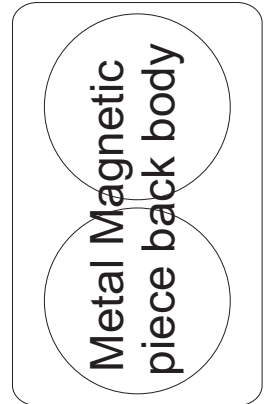

Step 1

Inside Magnet
Clip cover
<1.5oz

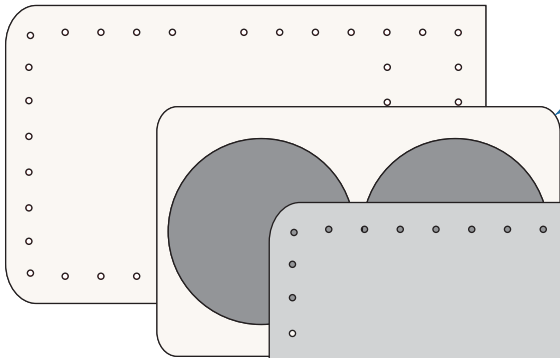

Magnet for clip

Outside Magnet
Clip
2-2.5oz

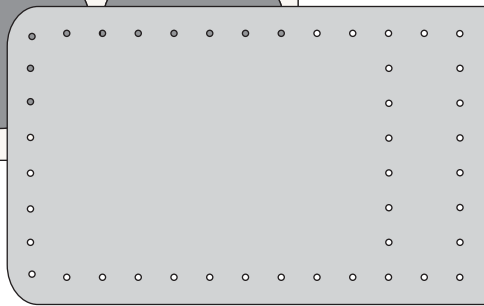

Step 2

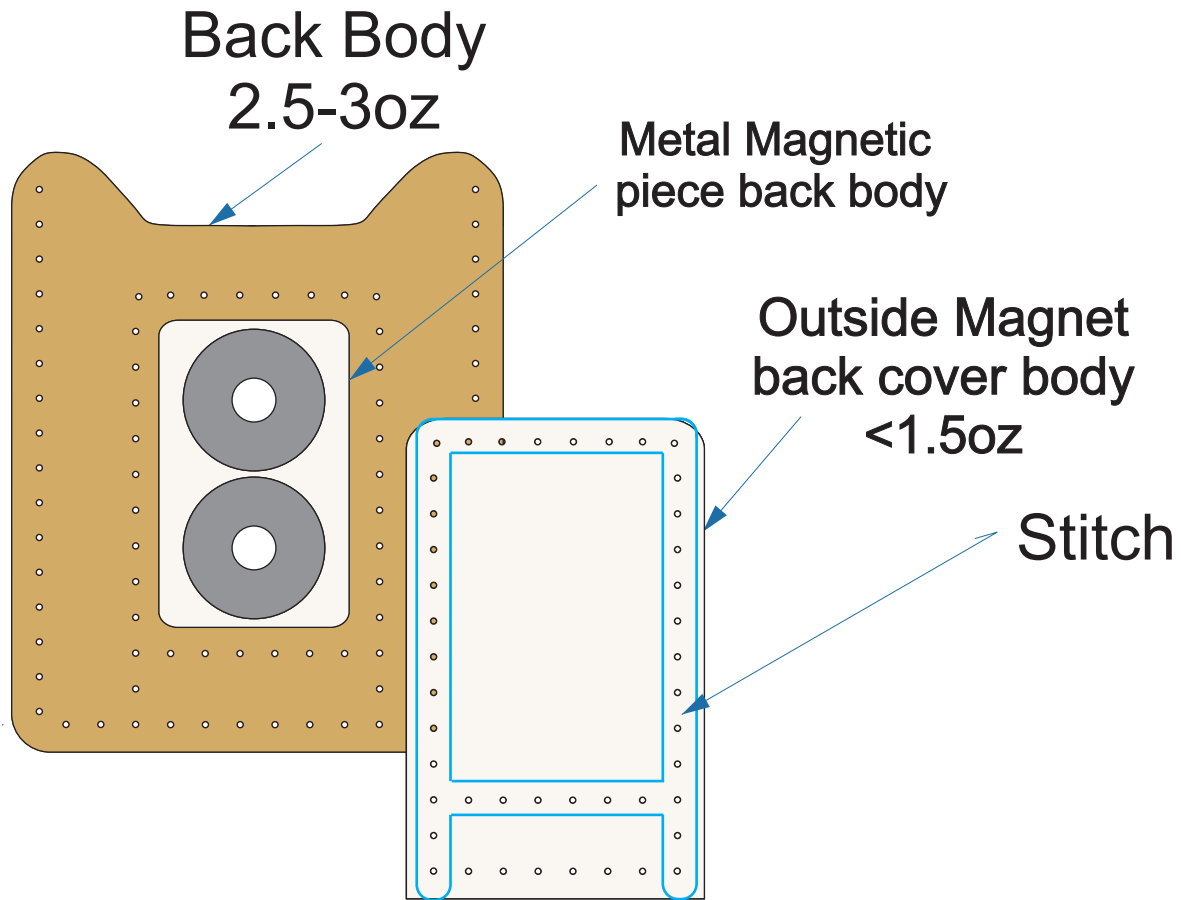

Step 3

1) Assemble the remaining pieces as pictured

