

10Gb/s XFP 40km BIDI Tx1330/Rx1270 Optical Transceiver

Product Features

- Supports 8.0Gb/s to 11.1Gb/s bit rates
- Hot-pluggable XFP footprint, Built-in digital diagnos
- Maximum link length of 40km with SMF
- 1330nm DFB laser and PIN photodiode
- XFP MSA package with duplex LC connector
- No reference clock required
- Single +3.3V power supply
- Power dissipation <1.5W
- Compatible with RoHS
- Temperature range : 0 to +70° C

Applications

- SONET OC-192&SDH STM-64 at 9.953Gbps
- 10GBASE-LR/LW 10G Ethernet
- 1200-SM-LL-L 10G Fibre Channel
- 10GE over G.709 at 11.09Gbps
- OC192 over FEC at 10.709Gbps
- Other optical links, up to 11.1Gbps

This product is compliant with the 10G Small Form-Factor Pluggable (XFP) Multi-Source Agreement (MSA), supporting data-rate of 8.0~11.1Gbps, and transmission distance up to 40km on SMF.

The transceiver module comprises a transmitter with 1330nm DFB laser and a receiver with a PIN photodiode. Transmitter and receiver are separate within a wide temperature range and offers optimum heat dissipation and excellent electromagnetic shielding thus enabling high port densities for 10 GbE systems.

Ordering Information

Part Number	Description
AC-B-XFPBI40-32-xx	XFP 10G BIDI Tx1330nm/Rx1270nm 40km optical transceiver

Regulatory Compliance

Feature	Standard	Performance
Electromagnetic Interference (EMI)	FCC Part 15 Class B EN 55022:2010, Class B	Compatible with standards
Electromagnetic susceptibility (EMS)	EN 55024:2010	Compatible with standards
Laser Eye Safety	FDA 21CFR 1040.10 and 1040.11 EN60950, EN (IEC) 60825-1,2	Compatible with Class I laser product

Absolute Maximum Ratings

The operation in excess of any absolute maximum ratings might cause permanent damage to this module.

Parameter	Symbol	Min	Max	Unit	Notes
Storage Temperature	TS	-40	85	degC	
Power Supply Voltage	VCC	-0.5	4.5	V	
Relative Humidity (non-condensation)	RH	5	85	%	

Recommended Operating Conditions and Power Supply Requirements

Parameter	Symbol	Min	Typical	Max	Unit	Notes
Operating Case Temperature	TOP	0		70	degC	
Power Supply Voltage	VCC	3.135	3.3	3.465	V	
Data Rate, each Lane		8.0		11.1	Gb/s	
Power Supply Current	Icc			500	mA	

Optical Characteristics

Parameter	Symbol	Min	Typical	Max	Unit	Notes
Transmitter						
Centre Wavelength	λ_c	1320	1330	1340	nm	
Spectral Width (-20dB)	$\Delta\lambda$			1	nm	
Side-Mode Suppression Ratio	SMSR	30			dB	
Average Output Power	P _{out}	-1		+5	dBm	1
Extinction Ratio	ER	3.5			dB	
Data Input Swing Differential	V _{IN}	180		950	mV	2
Input Differential Impedance	Z _{IN}	90	100	110	Ω	
TX Disable	Disable	2.0		Vcc	V	

Enable		0		0.8	V	
Receiver						
Centre Wavelength	λ_c	1260	1270	1280	nm	
Receiver Sensitivity				-15	dBm	3
Receiver Overload		0.5			dBm	3
LOS De-Assert	LOS _D			-16	dBm	
LOS Assert	LOS _A	-26			dBm	
LOS Hysteresis		0.5		4	dB	
Data Output Swing Differential	V _{out}	400	600	800	mV	2
LOS	High	2.0		V _{cc}	V	
	Low			0.8	V	

Notes:

1. The optical power is launched into SMF.
2. Internally AC-coupled.
3. Measured with a PRBS 2³¹-1 test pattern @9953Mbps, BER $\leq 1 \times 10^{-12}$.

Digital Diagnostic Functions

The following digital diagnostic characteristics are defined over the normal operating conditions unless otherwise specified.

Parameter	Symbol	Min	Max	Unit	Notes
Temperature monitor absolute error	DMI_Temp	-3	3	degC	Over operating temp
Supply voltage monitor absolute error	DMI_VCC	-0.1	0.1	V	Full operating range
Channel RX power monitor absolute error	DMI_RX	-3	3	dB	Per channel
Channel Bias current monitor	DMI_Ibias	-10%	10%	mA	Per channel
Channel TX power monitor absolute error	DMI_TX	-3	3	dB	Per channel

Mechanical Dimension

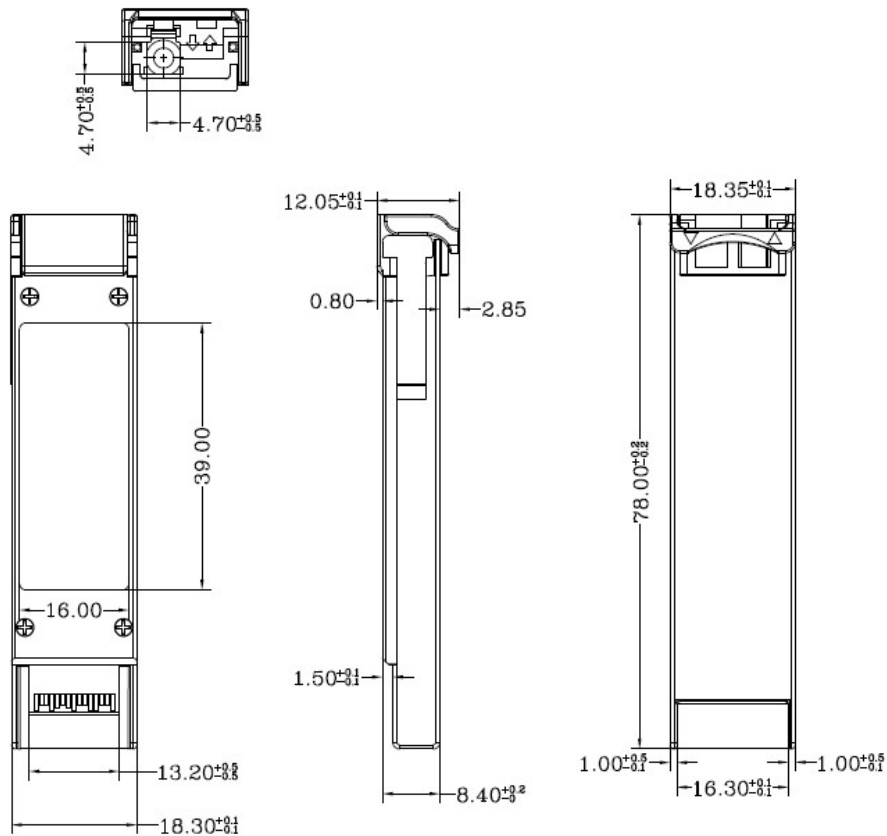

(Unit: mm [inch])

Recommended High-speed Interface Circuit

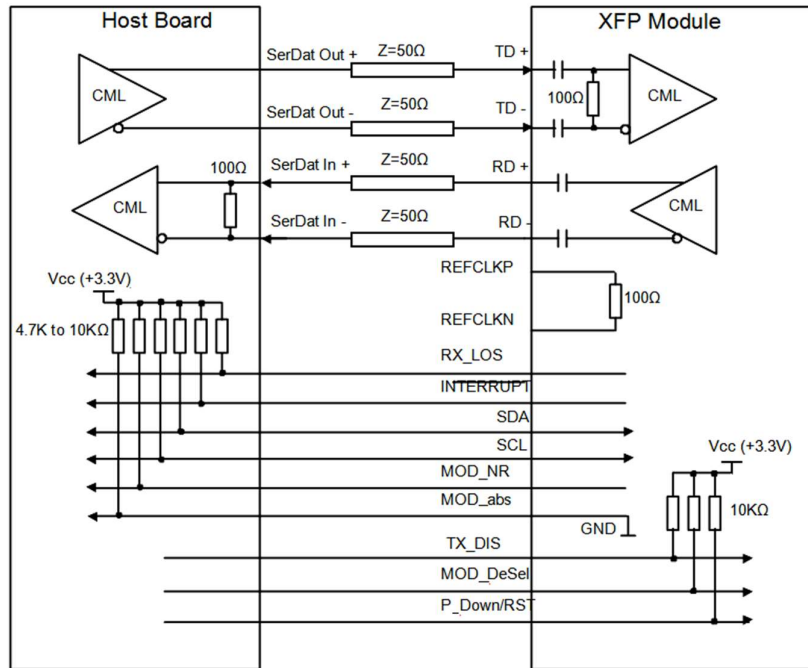

Pin Assignment and Description

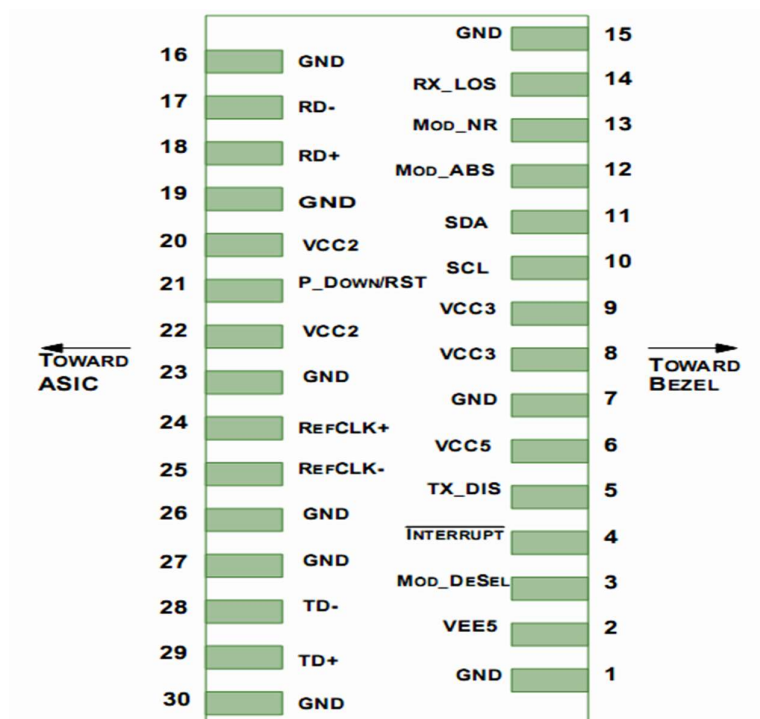

Pin Assignment

Pin	Logic	Symbol	Name/Description	Ref
1		GND	Module Ground	1
2		VEE5	Optional –5.2 Power Supply – Not required	
3	LVTTTL-I	Mod-Desel	Module De-select; When held low allows the module to, respond to 2-wire serial interface commands	
4	LVTTTL-O	Interrupt	Interrupt (bar); Indicates presence of an important condition which can be read over the serial 2-wire interface	2
5	LVTTTL-I	TX_DIS	Transmitter Disable; Transmitter laser source turned off	
6		VCC5	+5 Power Supply – Not required	
7		GND	Module Ground	1
8		VCC3	+3.3V Power Supply	
9		VCC3	+3.3V Power Supply	
10	LVTTTL-I	SCL	Serial 2-wire interface clock	2
11	LVTTTL-	SDA	Serial 2-wire interface data line	2
12	LVTTTL-O	Mod_Abs	Module Absent; Indicates module is not present. Grounded in the module.	2
13	LVTTTL-O	Mod_NR	Module Not Ready;	2
14	LVTTTL-O	RX_LOS	Receiver Loss of Signal indicator	2
15		GND	Module Ground	1
16		GND	Module Ground	1
17	CML-O	RD-	Receiver inverted data output	
18	CML-O	RD+	Receiver non-inverted data output	
19		GND	Module Ground	1
20		VCC2	+1.8V Power Supply – Not required	
21	LVTTTL-I	P_Down/RS T	Power Down; When high, places the module in the low power stand-by mode and on the falling edge of P_Down initiates a module reset	
			Reset; The falling edge initiates a complete reset of the module including the 2-wire serial interface, equivalent to a power cycle.	
22		VCC2	+1.8V Power Supply – Not required	
23		GND	Module Ground	1
24	PECL-I	RefCLK+	Reference Clock non-inverted input, AC coupled on the host board – Not required	3
25	PECL-I	RefCLK-	Reference Clock inverted input, AC coupled on the host board – Not required	3
26		GND	Module Ground	1
27		GND	Module Ground	1
28	CML-I	TD-	Transmitter inverted data input	
29	CML-I	TD+	Transmitter non-inverted data input	
30		GND	Module Ground	1

Notes:

1. Module circuit ground is isolated from module chassis ground within the module.
2. Open collector, should be pulled up with 4.7k – 10k ohms on host board to a voltage between 3.15V and 3.6V.
3. A Reference Clock input is not required.