

# Generative Structural Analysis



## **Overview**

Conventions

## **What's New**

## **Getting Started**

Entering the Generative Structural Analysis Workbench

Creating a Surface Slider Restraint

Creating a Distributed Force Load

Computing a Static Case Solution

Viewing Displacements Results

Inserting a Frequency Analysis Case

Creating an Iso-static Restraint

Creating a Non-Structural Mass

Computing a Frequency Case Solution

Viewing Frequency Results

## **User Tasks**

Before You Begin

Analysis Cases

Creating a Finite Element Model

Inserting a New Static Case

Inserting a New Static Constrained Case

Inserting a New Frequency Case

Inserting a New Buckling Case

Inserting a New Combined Case

Inserting a Harmonic Dynamic Response Case

Inserting a Transient Dynamic Response Case

Modulation

Creating White Noise Modulation

Importing Frequency Modulation

Importing Time Modulation

Dynamic Response Sets

Defining a Load Excitation Set

Defining a Restraint Excitation Set

Defining a Damping Set

Model Manager

Creating 3D Mesh Parts

Creating 2D Mesh Parts

Creating 1D Mesh Parts

Creating Local Mesh Sizes

Creating Local Mesh Sags

- Creating 3D Properties
- Creating 2D Properties
- Importing Composite Properties
- Creating 1D Properties
- Creating Imported Beam Properties
- Changing Element Type
- Creating a User Material
- Modifying Material Physical Properties
- Editing a User Isotropic Material
- Checking the Model

#### Adaptivity

- Creating Global Adaptivity Specifications
- Creating Local Adaptivity Specifications
- Computing with Adaptivity

#### Groups

- Grouping Points
- Grouping Lines
- Grouping Surfaces
- Grouping Bodies
- Box Group
- Sphere Group
- Grouping Points by Neighborhood
- Grouping Lines by Neighborhood
- Grouping Surfaces by Neighborhood
- Updating Groups
- Analyze Group

#### Analysis Connections

- General Analysis Connection
- Point Analysis Connection
- Point Analysis Connection Within one Part
- Line Analysis Connection
- Line Analysis Connection Within one Part
- Surface Analysis Connection
- Surface Analysis Connection Within one Part

#### Connection Properties

- About Connection Properties
- Creating Slider Connection Properties
- Creating Contact Connection Properties
- Creating Fastened Connection Properties
- Creating Fastened Spring Connection Properties
- Creating Pressure Fitting Connection Properties
- Creating Bolt Tightening Connection Properties
- Creating Rigid Connection Properties
- Creating Smooth Connection Properties
- Creating Virtual Rigid Bolt Tightening Connection Properties
- Creating Virtual Spring Bolt Tightening Connection Properties
- Creating User-Defined Connection Properties
- Creating Spot Welding Connection Properties
- Creating Seam Weld Connection Properties

## Creating Surface Weld Connection Properties

### Analysis Assembly

- About Analysis Assembly
- Analysis Assembly Methodology
- Analysis Assembly 2D Viewer

### Virtual Parts

- Creating Rigid Virtual Parts
- Creating Smooth Virtual Parts
- Creating Contact Virtual Parts
- Creating Rigid Spring Virtual Parts
- Creating Smooth Spring Virtual Parts
- Creating Periodicity Conditions

### Mass Equipment

- Creating Distributed Masses
- Creating Line Mass Densities
- Creating Surface Mass Densities
- Inertia on Virtual Part

### Restraints

- Creating Clamps
- Creating Surface Sliders
- Creating Ball Joints
- Creating Sliders
- Creating Pivots
- Creating Sliding Pivots
- Creating Advanced Restraints
- Creating Iso-static Restraints

### Loads

- Creating Pressures
- Creating Distributed Forces
- Creating Moments
- Creating a Bearing Load
- Importing Forces
- Importing Moments
- Creating Line Force Densities
- Creating Surface Force Densities
- Creating Volume Force Densities
- Creating Force Density
- Creating Accelerations
- Creating Rotation Forces
- Creating Enforced Displacements
- Creating Temperature Field
- Importing Temperature Field from Thermal Solution

### Sensors

- Creating Global Sensors
- Creating Local Sensors
- Creating Reaction Sensors
- Displaying Values of Sensors

### Results Computation

- Specifying External Storage

- Clearing External Storage
- Specifying Temporary External Storage
- Computing Objects Sets
- Computing Static Solutions
- Computing Static Constrained Solutions
- Computing Frequency Solutions
- Computing Buckling Solutions
- Computing Harmonic Dynamic Response Solutions
- Computing Transient Response Solutions
- Computing Using a Batch

#### Results Visualization

- Visualizing Deformations
- Visualizing Von Mises Stresses
- Visualizing Displacements
- Visualizing Principal Stresses
- Visualizing Precisions
- Reporting
- Advanced Reporting
- Reading a Historic of Computation
- Elfini Listing
- Animating Images
- Cut Plane Analysis
- Amplification Magnitude
- Extrema Creation
- Editing the Color Palette
- Information
- Images Layout
- Simplifying Representation
- Generating Images
- Editing Images
- Saving an Image As New Template
- Generating 2D Display Visualization
  - Generating a 2D Display for Modulation
  - Generating 2D Display for Dynamic Response Solution
  - Generating a 2D Display for Sensor
  - Editing 2D Display Parameters
- Export Data

#### **Analysis Application Interoperability**

- VPM Navigator Interoperability
  - Retrieving Pointed Documents of an Analysis File
  - Data-Mapping
  - Analysis Impact Graph
  - Synchronizing Documents with Versioned Parts or Products
- ENOVIAVPM / CATIA V5 Analysis Integration

#### **Workbench Description**

- Generative Structural Analysis Menu Bar
- Model Manager Toolbar
- Adaptivity Toolbar



Modulation Toolbar  
Groups Toolbar  
Analysis Connections Toolbar  
Connection Toolbar  
Analysis Assembly Toolbar  
Virtual Part Toolbar  
Mass Toolbar  
Restraint Toolbar  
Load Toolbar  
Compute Toolbar  
Solver Tools Toolbar  
Image Toolbar  
Analysis Tools Toolbar  
Analysis Results Toolbar  
Analysis Symbol

## **Customizing**

General  
Graphics  
Post Processing  
Quality  
External Storage

## **Reference Information**

Image Edition  
Advanced Edition for Images and Local Sensors  
Filtering Mesh Parts  
Integration with Product Engineering Optimization

## **Frequently Asked Questions**

Entering the Generative Structural Analysis Workbench  
Associativity  
Connection  
Data Mapping  
Dynamic Response Analysis  
Solver Computation  
Post-processing and Visualization  
Frequent Error Messages  
Licensing  
Integration with Product Engineering Optimization

## **Glossary**

## **Index**

# Overview

Welcome to the *Generative Structural Analysis User's Guide*. This guide is intended for users who need to become quickly familiar with the Generative Structural Analysis Version 5 workbench.

This overview provides the following information:

- [Generative Structural Analysis in a Nutshell](#)
- [Before Reading this Guide](#)
- [Getting the Most Out of this Guide](#)
- [Accessing Sample Documents](#)
- [Conventions Used in this Guide](#)



## Generative Structural Analysis in a Nutshell

Generative Structural Analysis  allows you to rapidly perform first order mechanical analysis for 3D systems.

This workbench is composed of the following products:

- The **Generative Part Structural Analysis (GPS)** product is intended for the casual user. Indeed, its intuitive interface offers the possibility to obtain mechanical behavior information with very few interactions. The dialog boxes are self explanatory and require practically no methodology, all defining steps being commutative.
- The **ELFINI Structural Analysis (EST)** product is a natural extensions of both above mentioned products, fully based on the V5 architecture. It represents the basis of all future mechanical analysis developments.
- The **Generative Assembly Structural Analysis (GAS)** product has been designed as an integrated extension to Generative Part Structural Analysis enabling the study of the mechanical behavior of a whole assembly. The product has been conceived with the same "easy to learn" and "fun to use" ergonomics principles.
- The **Generative Dynamic Analysis (GDY)** product will let you work in a dynamic response context.

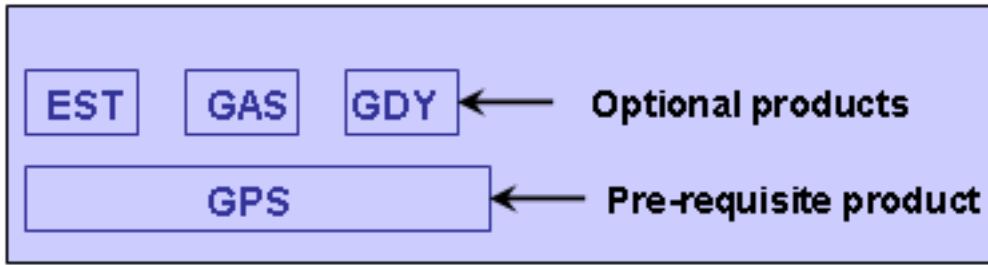

The *Generative Structural Analysis User's Guide* has been designed to show you how to analyze a system consisting of single parts or of assemblies of parts, operating within a specified environment. There are several ways for undergoing a part to external actions.



## Before Reading this Guide

Before reading this guide, the user should be familiar with the basic Version 5 concepts such as document windows, standard and view toolbars. We therefore recommend that you read the *Infrastructure User's Guide* that describes generic capabilities common to all Version 5 products. We also recommend that you read the *Finite Element Reference Guide*.

You may also like to read the following complementary product guides, for which the appropriate license is required:

- *Part Design User's Guide*
- *Assembly Design User's Guide*
- *Real Time Rendering User's Guide*
- *Generative Shape Design, Optimizer, Developed Shapes & BiW Design User's Guide*
- *Automotive Body in White Fastening User's Guide*



## Getting the Most Out of this Guide

To get the most out of this guide, we suggest that you start performing the step-by-step [Getting Started](#) section.

Once you have finished, you should move on to the [User Tasks](#) section.

At any time, you can access the [Frequently Asked Questions](#) section and the [Reference Information](#) section.

The [Workbench Description](#) section, which describes the Generative Structural Analysis workbench, and the [Customizing](#) section, which explains how to set up the options, will also certainly prove useful.



## Accessing Sample Documents

To perform the scenarios, you will be using sample documents contained in the [online/estug/samples](#) folder.

For more information about this, please refer to Accessing Sample Documents in the *Infrastructure User's Guide*.



## Conventions Used in this Guide

To learn more about the conventions used in this guide, please refer to [Conventions](#) section.

In addition to these conventions, you can find the following icons in the *Generative Structural Analysis User's Guide*:

**This icon ... Means that the functionality is only available with ...**



the **ELFINI Structural Analysis (EST)** product



the **Generative Assembly Structural Analysis (GAS)** product



the **Generative Dynamic Analysis (GDY)** product

# Conventions

Certain conventions are used in CATIA, ENOVIA & DELMIA documentation to help you recognize and understand important concepts and specifications.

## Graphic Conventions

The three categories of graphic conventions used are as follows:

- [Graphic conventions structuring the tasks](#)
- [Graphic conventions indicating the configuration required](#)
- [Graphic conventions used in the table of contents](#)

## Graphic Conventions Structuring the Tasks

Graphic conventions structuring the tasks are denoted as follows:

### **This icon...**



### **Identifies...**

estimated time to accomplish a task

a target of a task

the prerequisites

the start of the scenario

a tip

a warning

information

basic concepts

methodology

reference information

information regarding settings, customization, etc.

the end of a task



functionalities that are new or enhanced with this release

allows you to switch back to the full-window viewing mode

## Graphic Conventions Indicating the Configuration Required

Graphic conventions indicating the configuration required are denoted as follows:

**This icon...**



**Indicates functions that are...**

specific to the P1 configuration



specific to the P2 configuration



specific to the P3 configuration

## Graphic Conventions Used in the Table of Contents

Graphic conventions used in the table of contents are denoted as follows:

**This icon...**



**Gives access to...**

Site Map

Split View mode

What's New?

Overview

Getting Started

Basic Tasks

User Tasks or the Advanced Tasks

Workbench Description

Customizing

Reference

Methodology

Glossary



## Text Conventions

The following text conventions are used:

- The titles of CATIA, ENOVIA and DELMIA documents *appear in this manner* throughout the text.
- **File** -> **New** identifies the commands to be used.
- Enhancements are identified by a blue-colored background on the text.

## How to Use the Mouse

The use of the mouse differs according to the type of action you need to perform.

**Use this mouse button... Whenever you read...**



- Select (menus, commands, geometry in graphics area, ...)
- Click (icons, dialog box buttons, tabs, selection of a location in the document window, ...)
- Double-click
- Shift-click
- Ctrl-click
- Check (check boxes)
- Drag
- Drag and drop (icons onto objects, objects onto objects)



- Drag
- Move



- Right-click (to select contextual menu)

# What's New?

## New Functionalities

### Model Manager

#### Importing Composite Property

You can import a composite property.

#### Creating a User Material

You can create a user material in the analysis context.

#### Modifying Material Physical Properties

You can modify physical properties of a material.

#### Changing Element Type

You can change the type of 1D and 2D elements.

### Groups

#### Creating Point Group by Neighborhood

You can create a proximity point group.

#### Creating Line Group by Neighborhood

You can create a proximity line group.

#### Creating Surface Group by Neighborhood

You can create a proximity surface group.

### Analysis Connections

#### Surface Analysis Connection

You can create a surface analysis connection (adhesive connection).

#### Surface Analysis Connection within one Part

You can create a surface analysis connection (adhesive connection) within one part.

### Connection Properties

#### Surface Weld Connection Properties

You can create a surface weld connection property.

### Analysis Assembly

#### About Analysis Assembly

Give general information about the Analysis Assembly context.

#### Methodology

Methodology in assembly analysis.

#### Analysis Assembly 2D Viewer

Gives you the analysis document structure.



## Loads

### Importing Temperature Field from Thermal Solution

Import temperature from thermal solution.

## Sensors

### Integration with Product Engineering Optimization

Gives you information about the analysis sensors used in the derivatives computation.

## Interoperability

### Analysis Impact Graph

Gives you information about the Impact Graph of Analysis document.

### Synchronizing Analysis Document with Versioned Parts or Products

Gives you information about the synchronization of analysis document with versioned parts or products.

## Enhanced Functionalities

## Model Manager

### Creating 1D Mesh Part

The Beam Meshing dialog box has been enhanced.

### Creating 1D Properties

Two new options as **Section** type: [Beam from surface](#) and [Bar](#).

### Editing User Isotropic Materials

You can only edit user isotropic materials that have been created in a previous release.

### Associativity

Free groups and proximity groups are allowed as support.

## Analysis Connections

### General Analysis Connection

Mesh part filter is available.

### Point Analysis Connection

Mesh part filter is available.

### Point Analysis Connection within one Part

Mesh part filter is available.

### Line Analysis Connection

You can define the connection orientation (curve-curve connection).

Mesh part filter is available.

### Line Analysis Connection within one Part

You can define the connection orientation (curve-curve connection).

Mesh part filter is available.

## Restraints

### Associativity

Free groups and proximity groups are allowed as support.

## Loads

### Associativity

Free groups and proximity groups are allowed as support.

### Bearing Load

You can choose the distribution orientation.

## Masses

### Associativity

Free groups and proximity groups are allowed as support.

## Results Visualization

### Images Layout

You can define a distance between two images to enhance the visualization.

### Editing Images

The Image Edition dialog box has been enhanced.

### Generating Images

New images are available under the [analysis solution](#) and the [properties](#) set.

### Generating 2D Display Visualization

The [2D Display for dynamic solutions](#) has been enhanced.

The [edition of the 2D Display parameters](#) has been enhanced.

## Customizing Settings

### Post-processing

You can now deactivate the automatic preview mode in the image edition functionality.

### External Storage

Option names have been changed.

# Getting Started

This tutorial will guide you step-by-step through your first ELFINI and Generative Part Structural Analysis session, allowing you to get acquainted with the product. You just need to follow the instructions as you progress.

## Entering the Generative Structural Analysis Workbench

Creating a Surface Slider Restraint

Creating a Distributed Force Load

Computing a Static Case Solution

Viewing Displacements Results

Inserting a Frequency Analysis Case

Creating an Iso-static Restraint

Creating a Non-Structural Mass

Computing a Frequency Case Solution

Viewing Frequency Results



These tasks should take about 20 minutes to complete.

# Entering the Generative Structural Analysis Workbench



This first task will show you how to load a .CATPart document (and display the corresponding specification tree) by entering the Generative Structural Analysis workbench and defining that you will create a Static Analysis case.

Creating a *static analysis case* means that you will analyze the static boundary conditions of the CATAnalysis document one after the other.



## Before you begin:

- **Note:**  
In this example, a material has been previously assigned to the part you will open. In the case no material has been previously assigned to the part, before entering the Generative Structural Analysis workbench, you should proceed as follows:
  1. Select the part in the specification tree.
  2. Click the **Apply Material** icon  .  
The Material library appears.
  3. Select a material family, then select the desired material from the displayed list, then click **OK**.  
The material is applied.

You can visualize the material properties and its analysis characteristics by selecting the material in the specification tree and using **Edit -> Properties -> Analysis**.

If you select **Start->Analysis & Simulation -> Generative Structural Analysis** from a CATPart document containing a part without any material assigned, the material library will appear directly for an easy material selection.

- **Warning:**  
Avoid having CATAnalysis documents automatically saved. For this, go to **Tools->Options->General** (menu bar) and select the **No automatic backup** option. Otherwise, on some models, each computation will be followed by a **Save** operation, thus making temporary data become persistent data.



**1. Open the CATPart Document.**

For this, select **File -> Open**, then select the desired .CATPart file.

In this tutorial, you will open CATPart named [sample01.CATPart](#).

This opens a **Part Design** document containing the selected part.

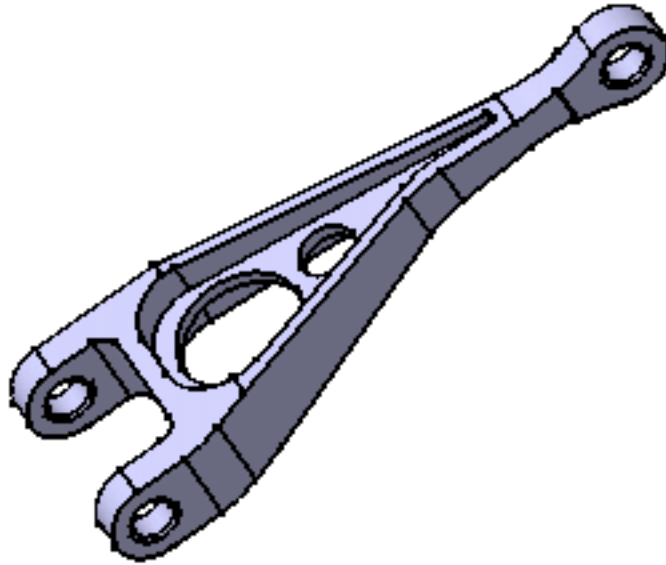

**2. Define the View Mode.**

For this, select the **View -> Render Style -> Customize View** menu.

The Custom View Modes dialog appears: activate the **Shading** option and then the **Materials** option in the Custom View Modes dialog box.

**3. Enter Generative Structural Analysis Workbench.**

Select **Start -> Analysis & Simulation -> Generative Structural Analysis** from the menu bar.



The New Analysis Case dialog box appears with **Static Analysis** as default option.

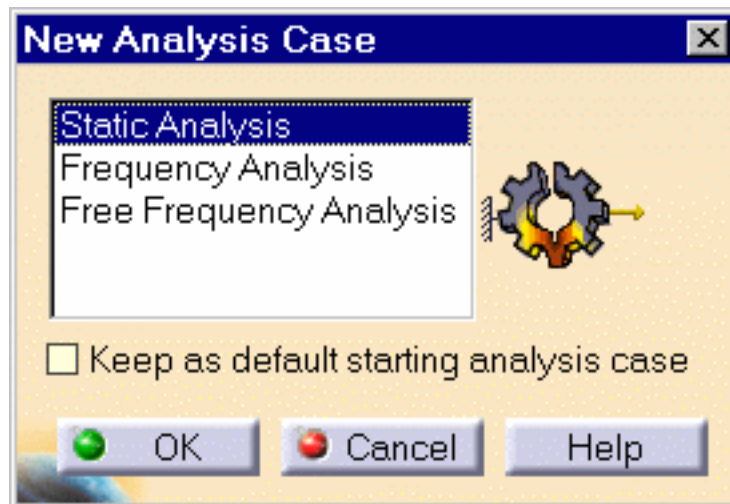

- **Static Analysis** means that you will analyze the static boundary conditions of the CATAnalysis document one after the other.
- **Frequency Analysis** means that you will analyze the dynamic boundary conditions of the CATAnalysis document .
- **Free Frequency Analysis** means that you will analyze the buckling dynamic conditions of the CATAnalysis document.
- **Keep as default starting analysis case** means that when you next open the **Generative Structural Analysis** workbench from the menu bar, the selected case appears as default.

**4.** Select an Analysis Case type in the New Analysis Case dialog box.

In this particular case, also keep **Static Analysis** type selected.

**5.** Click **OK** in the New Analysis Case dialog box to enter the workbench.

The CATAnalysis document now opens. It is named **Analysis1**. You will now perform different operations in this document.

A link exist between the CATPart and the CATAnalysis document.

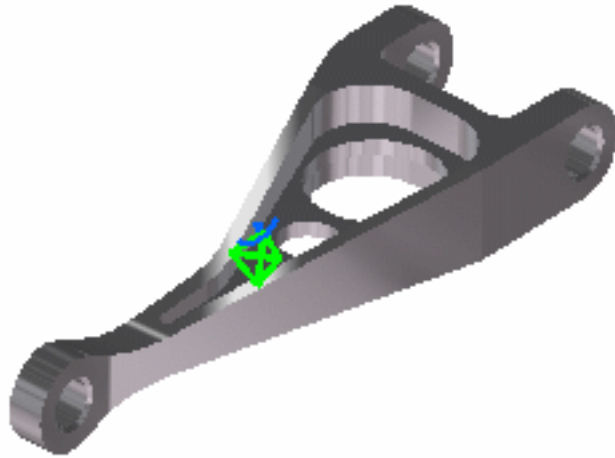

Double-clicking on the green symbol allows displaying mesh specifications or setting meshing parameters.

The standard structure of the Analysis **specification tree** is displayed.

As you can see below, the **Finite Element Model** contains a **Static Case**, which contains empty **Restrains** and **Loads** objects sets, along with an empty **Static Case Solution.1** object set. All along this tutorial, you will assign a Restraint and a Load to the **CATAnalysis** document and then compute the Static Case Solution.



# Creating a Surface Slider Restraint



This task will show you how to restrain several faces of your part in such a way that it can only slide along their tangent planes (geometry supports). You will create a surface slider restraint on a **Finite Element Model** containing a Static Analysis Case.



1. Select the **Restraints.1** object in the specification tree to make it active.

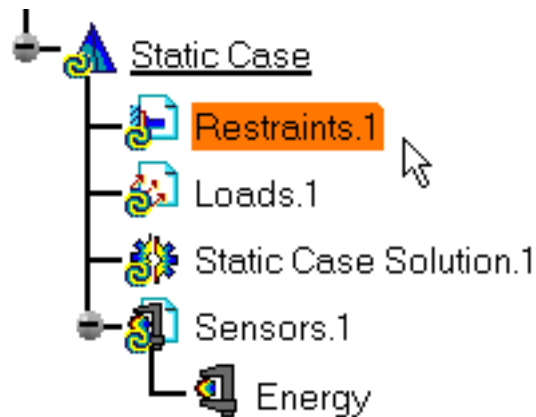

2. Click the **Surface Slider** icon .

The Surface Slider dialog box appears.



3. Select in sequence the four faces as indicated.



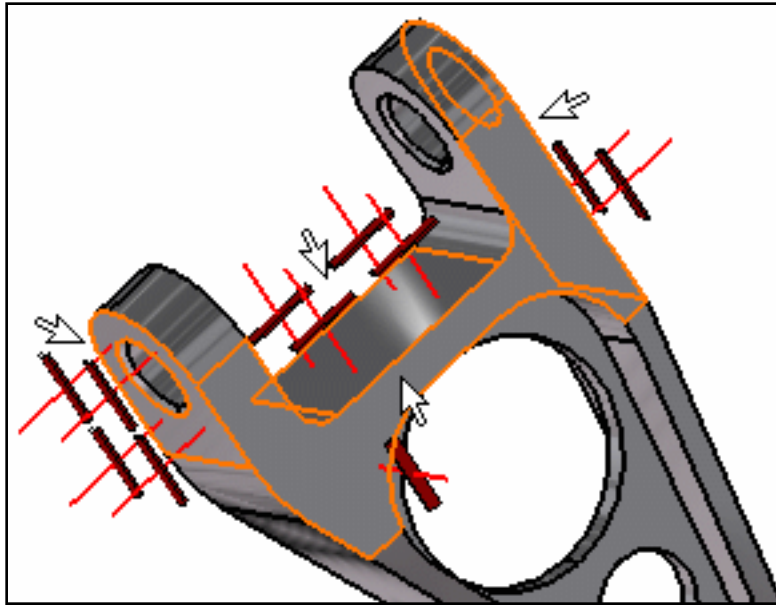

Symbols representing the surface sliders appear as you select the four faces. The elements supporting the surface slider are automatically displayed in the Surface Slider dialog box.



4. Click **OK** in the Surface Slider dialog box to actually create this surface slider.

In the specification tree, the **Surface Slider.1** object has been inserted under the **Restraints.1** object.

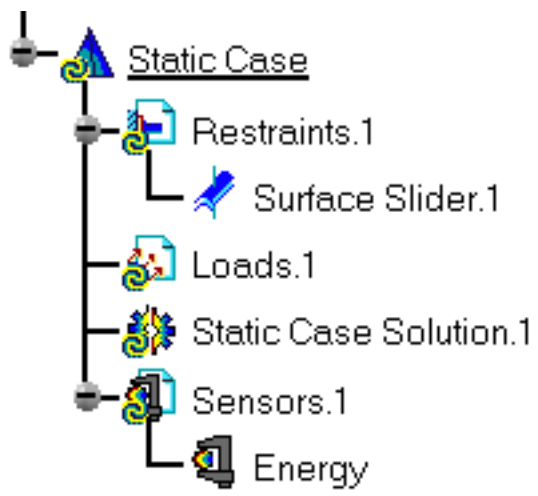

# Creating a Distributed Force Load



This task will show you how to distribute on a face of your part a resultant force. You will create a Distributed Force on a **Finite Element Model** containing a Static Analysis Case.

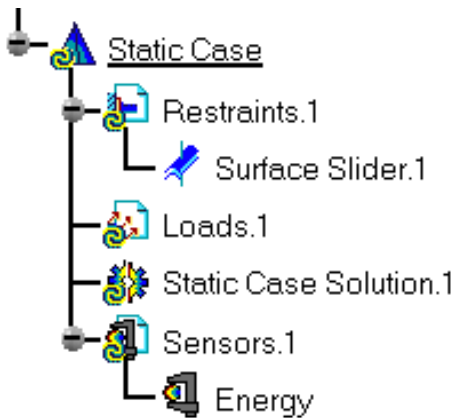

1. Select the **Loads.1** object in the specification tree to make it active.

2. Select the **Distributed Force** icon  .

The Distributed Force dialog box appears.

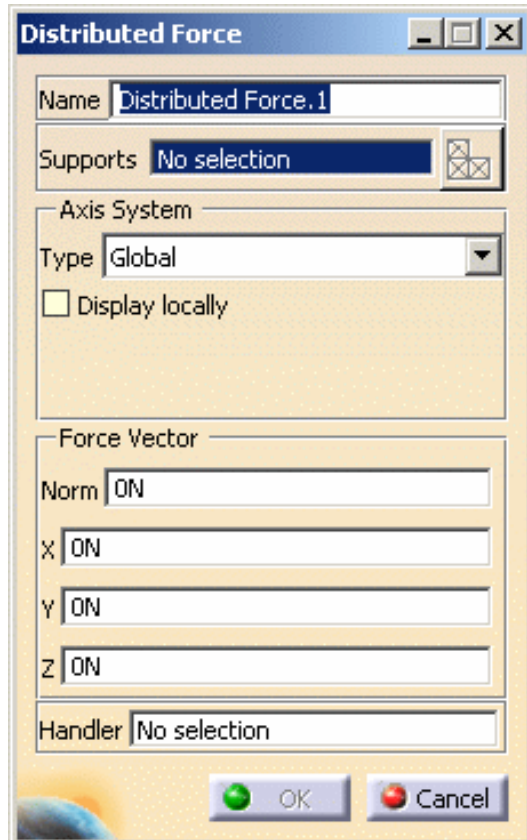

You will distribute on a face of your part a resultant force of **50N** parallel to the global z-direction applied at the centroid of the face. For this:

3. Enter **-50N** value in **Z** field (**Force Vector**).

The resultant **Force Vector Norm** field is automatically updated.

4. Select the part face as indicated below.

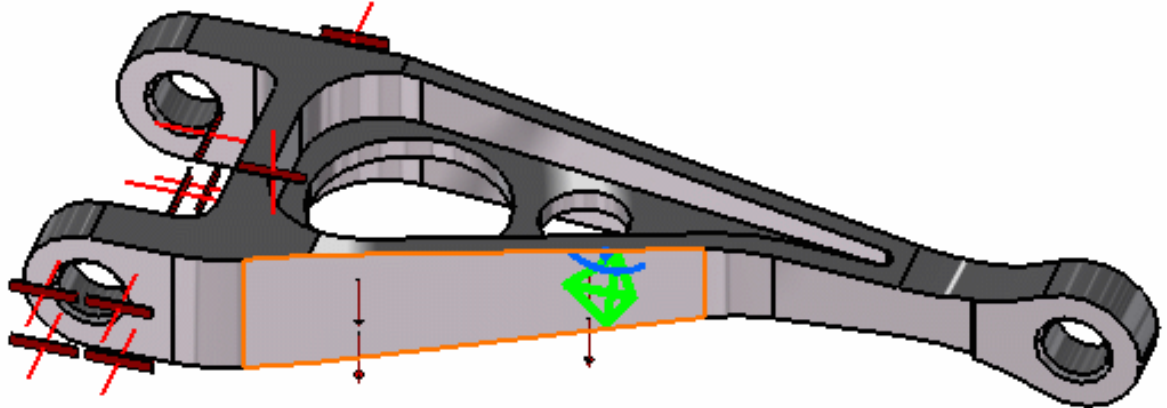

A symbol (arrow) representing the distributed force is displayed.

5. Click **OK** in the Distributed Force dialog box.

The **Distributed Force.1** object has been inserted under the **Loads.1** objects set in the specification tree.

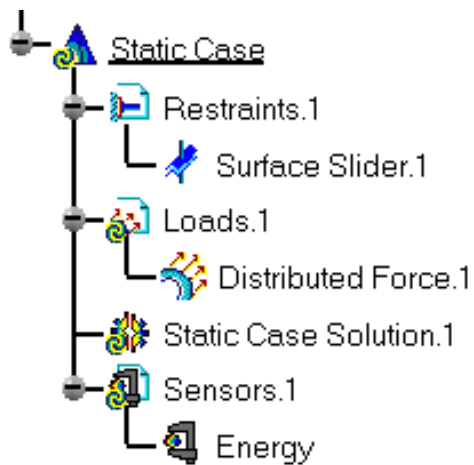

# Computing a Static Case Solution



This task will show you how to compute the Static Case Solution of a **Finite Element Model** on which you previously created a **Restraint** object and a **Load** object. You will store the results in a given directory.



1. Select the **External Storage** icon .

The External Storage dialog box appears.

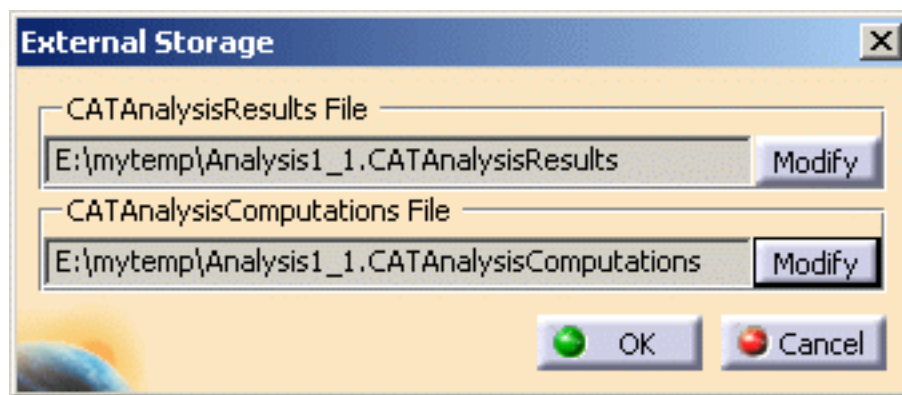

The Results and Computation Data are stored in one single file with given extensions:

- **xxx.CATAnalysisResults**
  - **xxx.CATAnalysisComputations**
2. If needed, change the path of the **Result Data** and/or **Computation Data** directories.
  3. Click **OK** in the External Storage dialog box.
  4. Select the **Compute** icon .

The Compute dialog box appears.

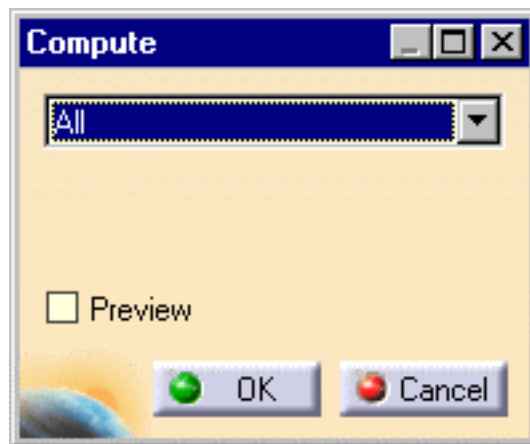

5. Select the **All** default value proposed for defining which are the objects sets to be updated.
6. Click **OK** in the Compute dialog box to launch the computation.

The Progress Bar dialog box provides a series of status messages (**Meshing**, **Factorization**, **Solution**) that inform you of the degree of advancement of the computation process.

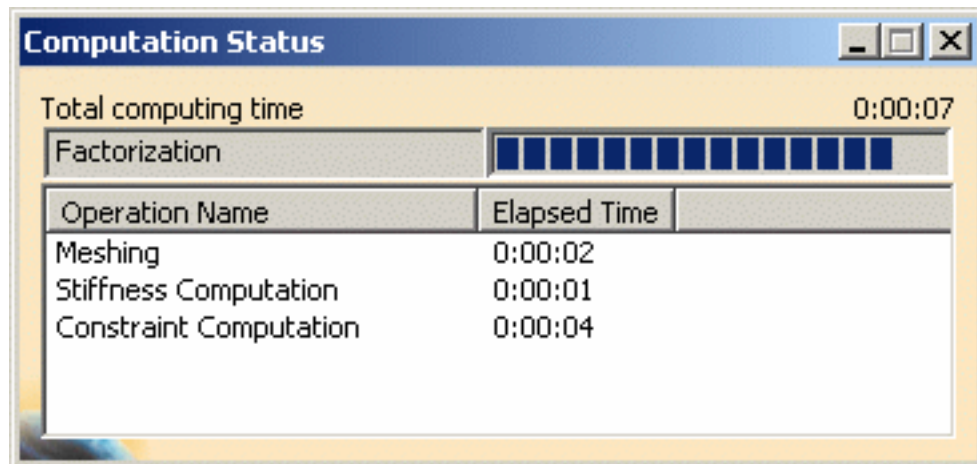

Upon successful completion of the computation, the status of all objects in the analysis specification tree up to the **Static Case Solution.1** objects set is changed to valid. In other words, the  symbol appears no more.

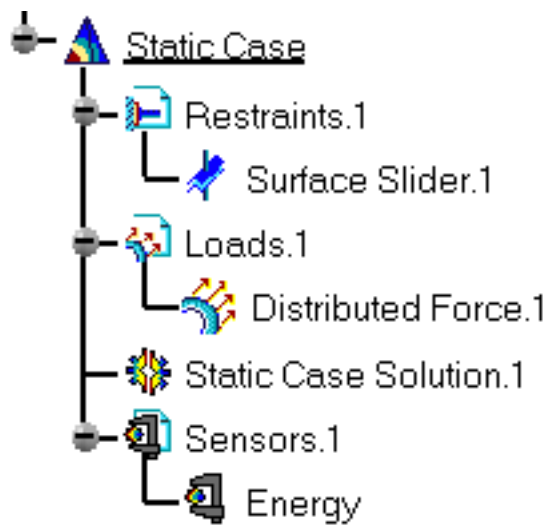

The color change of the Restraints and Loads symbols to blue, also reflecting the fact that the Static Case Solution computation was successful.

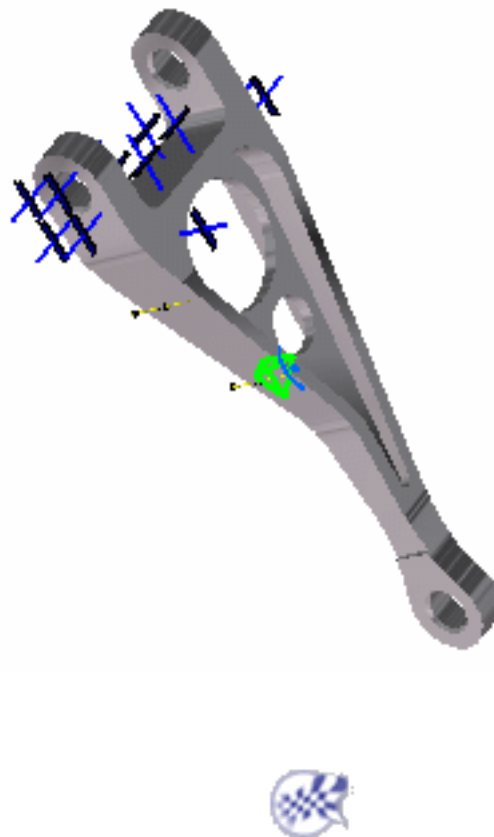

# Viewing Displacements Results



This task will show you how to visualize the displacements of the CATAnalysis according to the restraints and load you assigned to this CATAnalysis. You previously launched the computation of the Static Analysis Case and will now generate a Report with computations of the displacements you are going to perform:

- Displacement
- Stress Von Mises



1. Click the **Displacement** icon  in the **Image** toolbar.

A plot of the displacement field is displayed with arrow symbols. If you go over the plot with the cursor, you can visualize the nodes. The computed displacement field can now be used to compute other results such as strains, stresses, reaction forces and so forth.

*Arrows representing the displacement:*

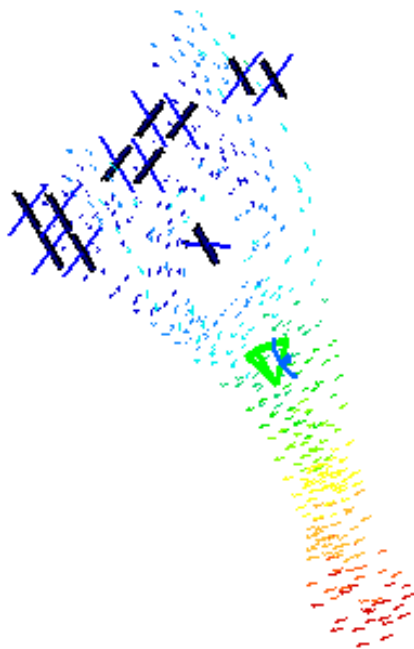

*Zoomed arrows:*



2. Click the **Stress Von Mises** icon  in the **Image** toolbar.



Go to **View -> Render Style -> Customize View** and make sure the **Materials** option is active in the Custom View Modes dialog box.

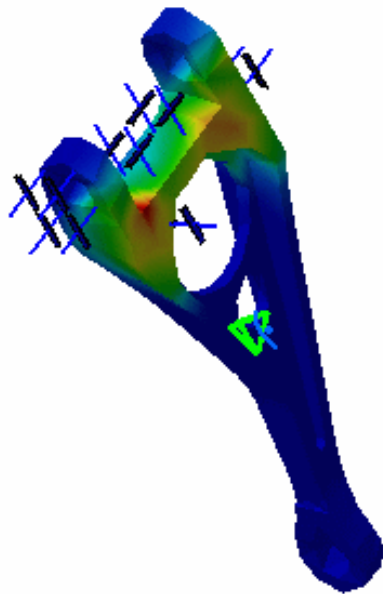

Both a **Translational displacement vector** image object and a **Von Mises Stress (nodal value)** image object appear in the specification tree under the **Static Case Solution.1** objects set.

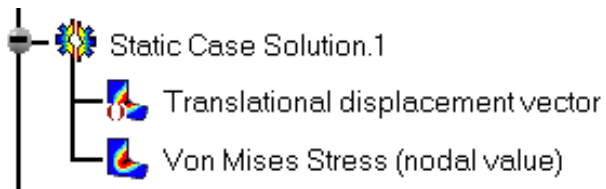

You can choose to have both **Translational displacement vector** and **Von Mises Stress (nodal value)** deformed mesh displayed. For this, right-click on **Translational displacement vector** in the specification tree and select the **Activate/Deactivate** option that is displayed in the contextual menu.

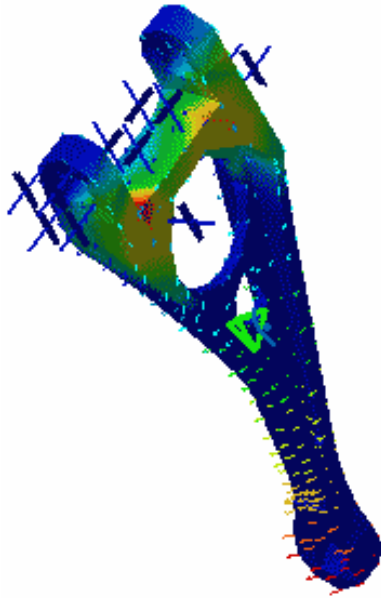

3. Double-click the **Von Mises Stress (nodal value)** object in the specification tree to edit the image.

The Image Edition dialog box appears.



- o Color value:  
The Color Palette enables you to modify the color distribution and to focus on specific values.

Von Mises Stress (nodal value)

N\_m2

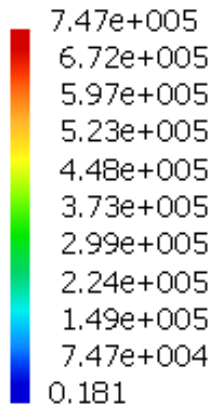

On Boundary

For more details on this functionality, please refer to [Editing the Color Palette](#).

- o Internal von Mises stress field values  
To visualize internal von Mises stress field values in a plane section through the part, click the **Cut Plane Analysis** icon  in the **Analysis Tools** toolbar. You can handle the compass with the mouse in order to rotate or translate the Cutting Plane (to do so, select an edge of the compass and drag the mouse). To exit this view, click **Close** in the Cut Plane Analysis dialog box that appeared.

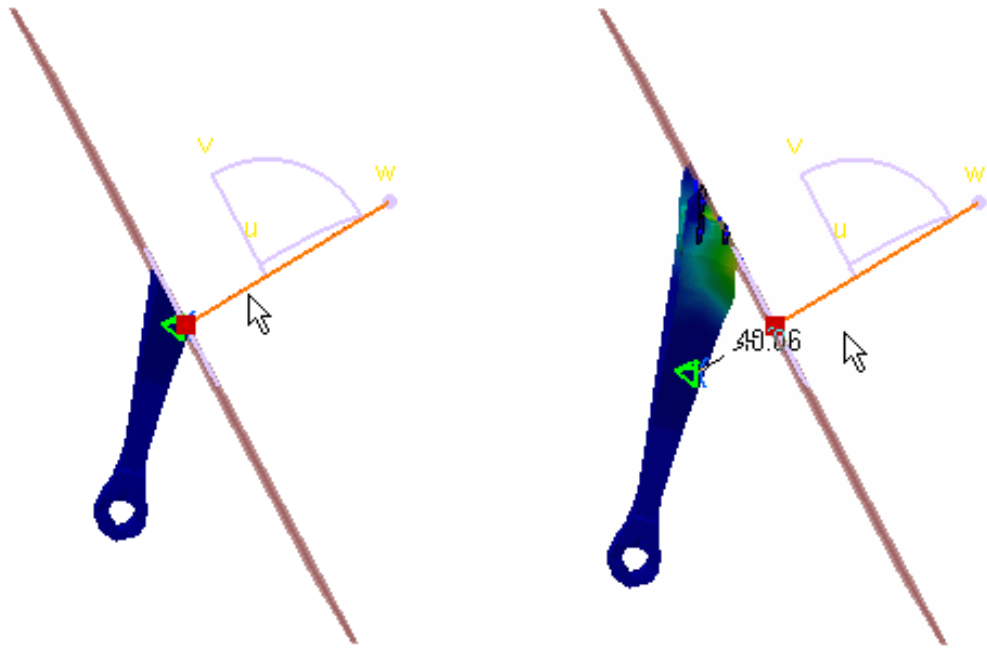

For more details about this functionality, please refer to [Cut Plane Analysis](#).

4. Click the **Image Extrema** icon  in the **Analysis Tools** toolbar to obtain local and global extrema values of the von Mises stress field magnitude.

The Extrema Creation dialog box appears.

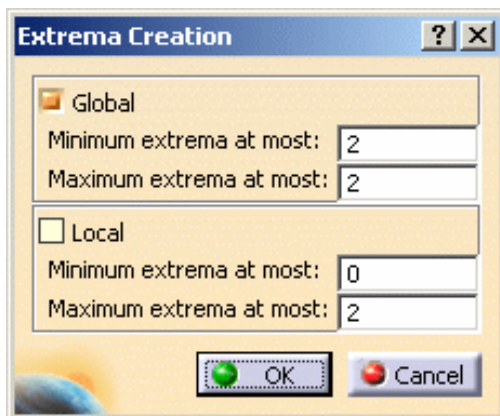

Click **OK** once you have defined the number of the extrema you need. In this particular case, you will define that you need two Absolute extrema.

Locations of the global maxima and minima are indicated on the image, and the **Extrema** object appears in the specification tree under the **Static Case Solutions** objects set.



As you can see above, the values are not satisfying for our static case: you need more distributed force so that the Stress Von Mises values might be more significant. You will therefore save the document, modify the values and re-compute the static case in the following task.



# Inserting a Frequency Analysis Case



This task will show you how to insert a Frequency Analysis Case. Creating a *frequency analysis case* means that you will analyze the dynamic boundary conditions of the CATAnalysis document.



## Before you begin:

Remember that we use the Materials view mode. If needed, go to **View -> Render Style -> Customize View** option from the toolbar and activate the **Materials** option from the displayed Custom View Modes dialog box.



1. Select **Insert -> Frequency Case** from the menu bar.

The Frequency Case dialog box appears with the possibility to either use the existing Analysis case as Reference or create a Frequency case with New feature.

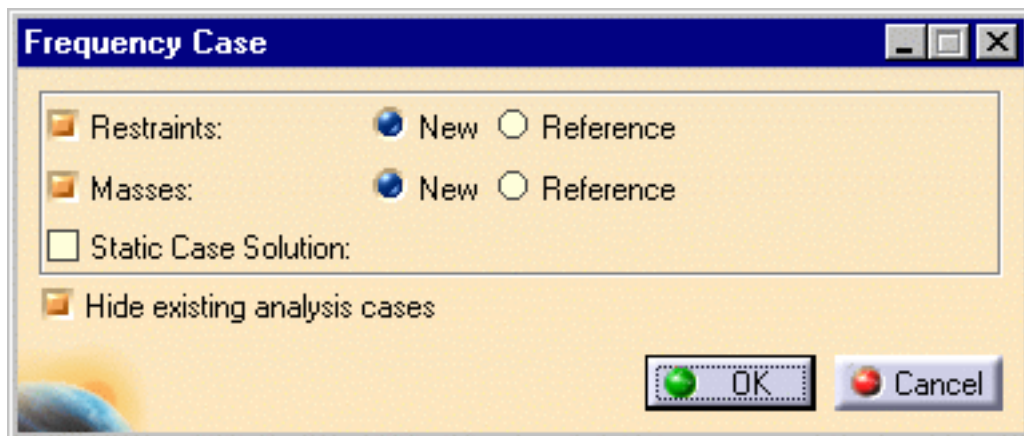

2. Click **OK**.

A new Analysis solution and the standard structure of Analysis specification tree is displayed.

The Finite Element Model contains a Frequency Case, which contains empty Restraints and Masses object sets, along with an empty **Frequency Case Solution.1** object set.

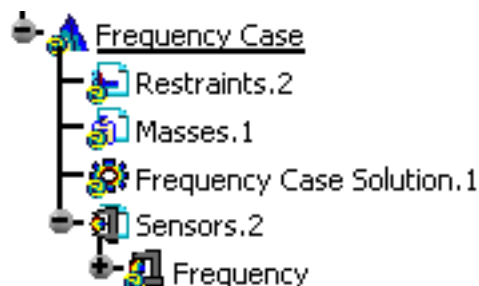



Remember that if you selected **Start->Analysis & Simulation -> New Generative Analysis** from a CATPart document containing the part without any material, the material library will appear directly for an easy material selection.



# Creating an Iso-static Restraint



This task will show you how to create an Iso-static Restraint on a part. In other words, you will apply statically definite restraints allowing you to simply support a body.



1. Select the **Restraints.2** object in the specification tree to make it active.



2. Click the **Isostatic Restraint** icon .

The Isostatic Restraint dialog box appears.



You can see that an **Isostatic.1** object has been inserted under the **Restraints.2** objects set in the specification tree.

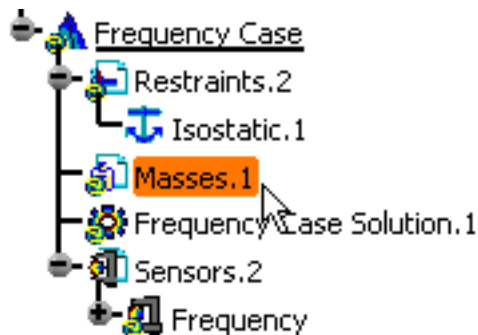

You will restrain your part in such a way that it is statically definite and all rigid-body motion is impossible. The program will automatically determine the restrained points and directions.

3. Click **OK** in the Isostatic Restraint dialog box to create the Iso-static Restraint.

The Isostatic symbol appears on the part.

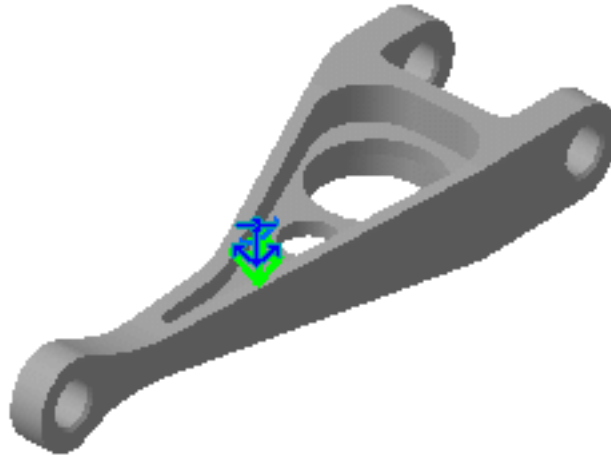



# Creating a Non-Structural Mass



This task will show you how to create a Mass Surface Density on the surface geometry supports. In this example, you will distribute a mass density of 50kg/m<sup>2</sup> on several faces of your part.



1. Select the **Masses.1** objects set in the specification tree to make it active.

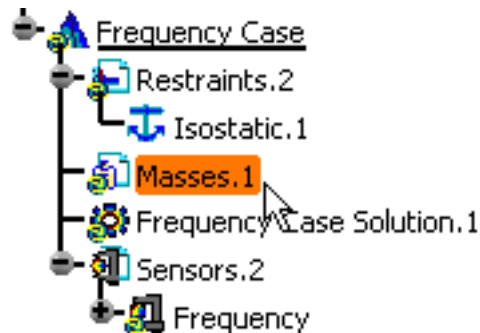

2. Click the **Surface Mass Density** icon .

The Surface Mass Density dialog box appears.

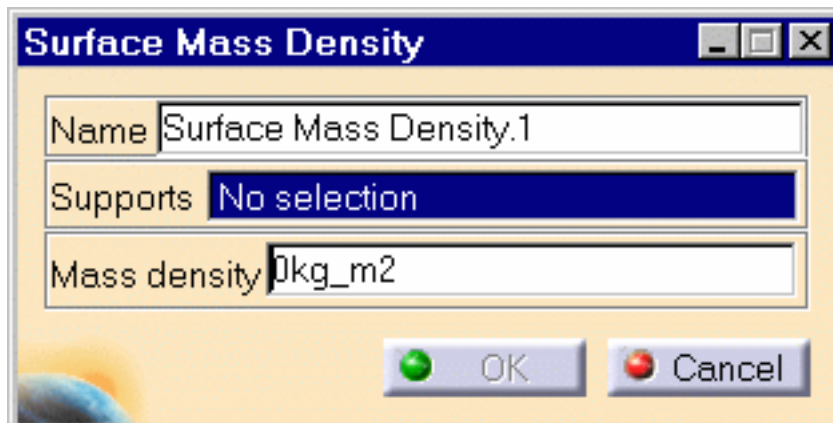

You can see that a **Surface Mass Density.1** object is now inserted under the **Masses.1** object set in the specification tree.

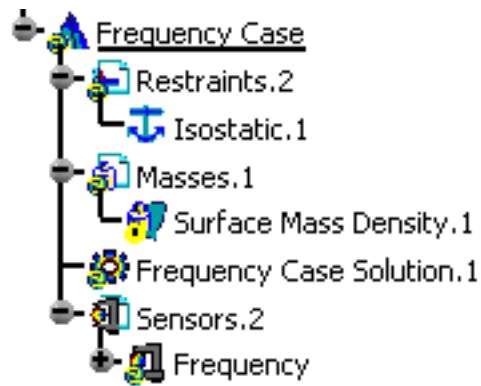

3. Select the faces on which you will distribute a mass density.

Red symbols representing the Mass Surface Density are displayed.

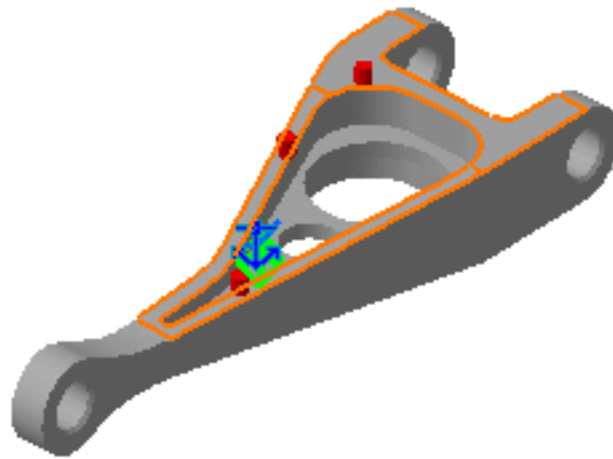

4. Enter a new **Mass Density** in the Surface Mass Density dialog box. In this particular case, enter **50kg\_m2**.

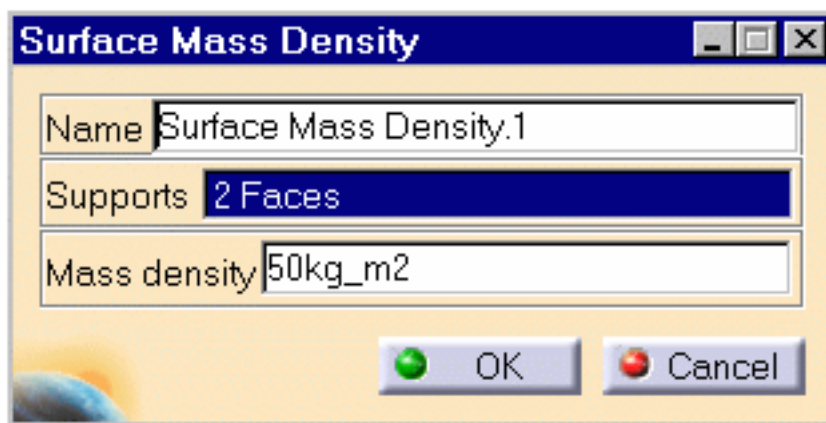

5. Click **OK** in the Surface Mass Density dialog box.

Note that the invalid symbol has disappeared in the specification tree.



# Computing a Frequency Case Solution



This task will show you how to compute a Frequency Case Solution on which you previously created a **Restraint** object and optionally a **Mass** object.



1. Click the **External Storage** icon .

The External Storage dialog box appears.

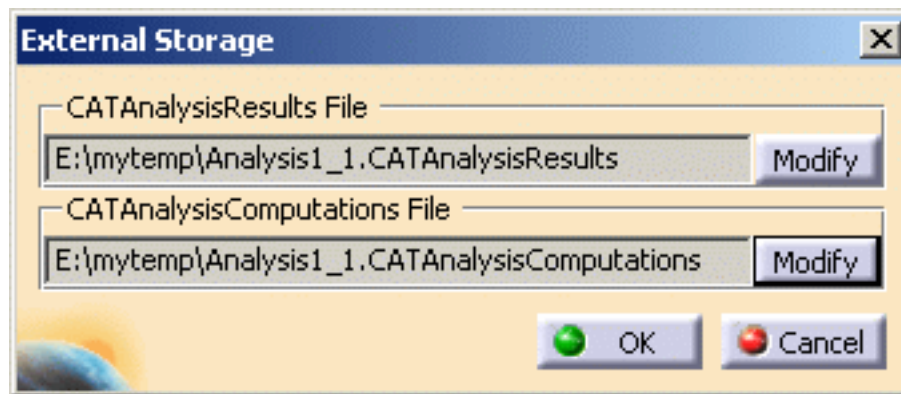

Optionally change the path of the External Storage directory to another directory and then click **OK** in the External Storage dialog box.



The results and computation data are stored in one single file with given extensions:

- o **xxx.CATAnalysisResults**
- o **xxx.CATAnalysisComputations**

2. Click the **Compute** icon .

The Compute dialog box appears.

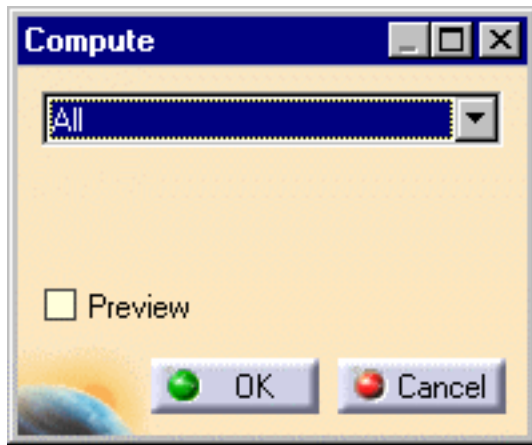

Take the default (**All**) proposed for the objects sets to update.

3. Click **OK** to perform the computation.

The Progress Bar dialog box provides a series of status messages (**Meshing**, **Factorization**, **Solution**) that inform you of the degree of advancement of the computation process.

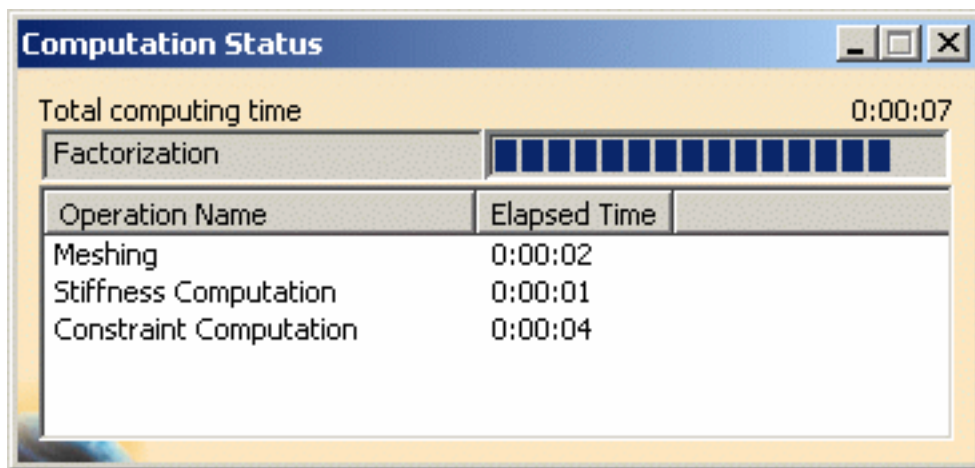

Upon successful completion of the computation, the status of the Frequency Case Solutions objects set is changed to valid in the specification tree. In other words, the  symbol appears no more.

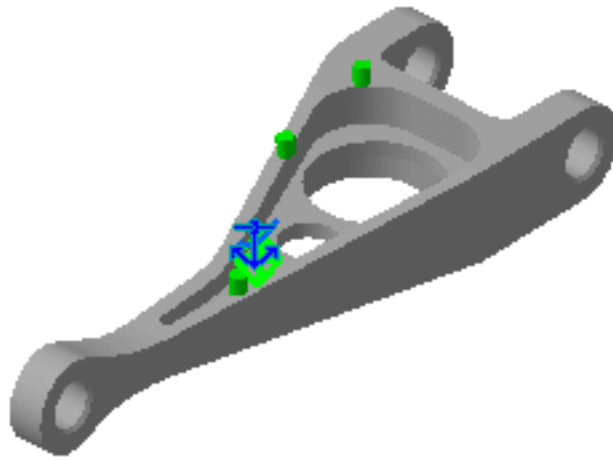

 Note the green color change of the Restraints and Masses symbols, reflecting the fact that the Frequency Case Solution computation was successful.



# Viewing Frequency Results



This task will show you how to visualize Vibration Modes after computing the Frequency Analysis Case and how to generate a Report.



1. Click the **Deformation** icon .

An image of the deformation corresponding to the first vibration mode is displayed, and a **Deformed Mesh** image object appears in the specification tree under the **Frequency Case Solution.1** objects set.

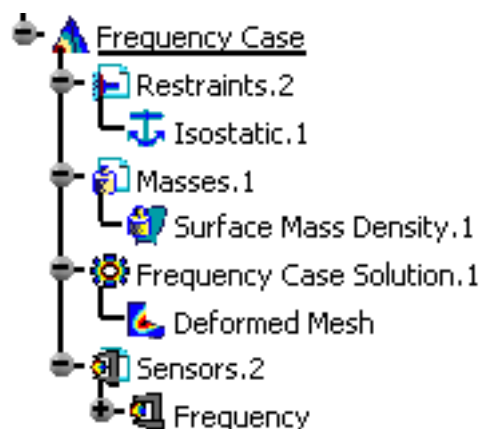
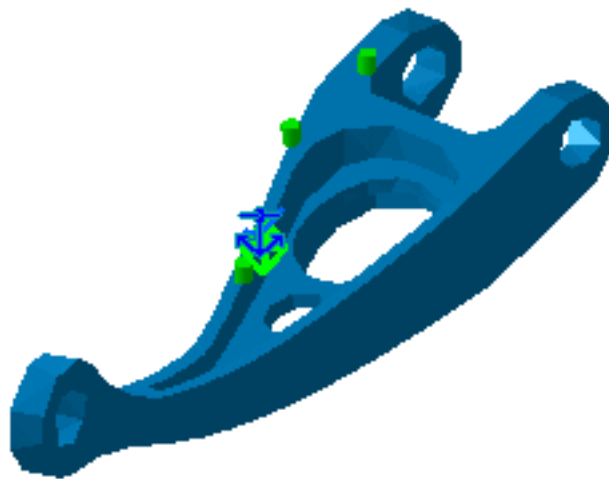

2. Double-click the **Deformed Mesh** object in the specification tree to edit the image.

The Image Edition dialog box, containing the list of vibration modes with the corresponding frequency occurrences is visualized. You can visualize any mode by clicking it in this multi-occurrence list.

3. Select the **Occurrences** tab in the Image Edition dialog box and select the seventh mode.

The selected mode is visualized:

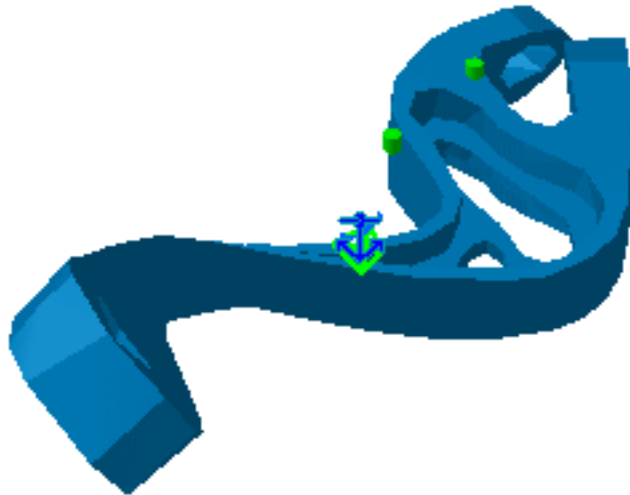

4. Click **OK** in the dialog box.



- You can further manage your results by using the Results Management action icons on the bottom of your screen.  
For more details, please refer to [Results Visualization](#).
- In addition to standard information, the Report for a Frequency Case Solution contains modal participation factors information, which allows you to evaluate the validity of the modal truncation to the first 10 modes.
- You can modify the number of computed modes by double-clicking the Solution and editing the Solution Definition dialog box.



# User Tasks

The tasks you will perform in the Generative Structural Analysis workbench are mainly specifications of analysis features that you will use for the mechanical analysis of your system (part or assembly of parts) subjected to environmental actions.

Once the required specifications are defined, you need to compute and visualize the results.

The User Tasks section will explain and illustrate how to create physical attributes (which include system attributes and environment attributes), specify computation parameters and visualize results.

You can make extensive use of the CAD-CAE associativity concept.

Associativity means that any part modifications occurring outside the Analysis workbench are automatically reflected when performing tasks within the Analysis workbench. In particular, any parametric changes on the parts are automatically accounted for. So, you don't have to worry about updating the part specifications.

The workbench provides generative capabilities: you do not have to tell the program explicitly all the necessary steps to perform a mechanical analysis. In fact, all you need to enter are the specifications about the system and the way in which the system is subjected to its environment. The program captures your design-analysis intent, then produces the desired results by automatically generating the intermediate steps.

The Basic Tasks can be grouped as follows:

- **FEM Model Definition**
  - Analysis Cases: specifying a computational procedure for a set of environmental factors.
- **System Definition**
  - Connections: specifying the way in which subsystems are to be connected.
  - Virtual Parts: specifying bodies for which no geometric support exists.
  - Mass Equipment: specifying the way in which non-structural mass is distributed.
- **Environment Definition**
  - Restraints: specifying essential (displacement-type) boundary conditions.
  - Loads: specifying natural (force-type) boundary conditions.
- **Results**
  - Computation: generating finite elements solutions.
  - Visualization: displaying and analyzing results.

[Before You Begin](#)  
[Analysis Cases](#)  
[Modulation](#)  
[Dynamic Response Sets](#)  
[Model Manager](#)



Adaptivity  
Groups  
Analysis Connections  
Connection Properties  
Analysis Assembly  
Virtual Parts  
Mass Equipment  
Restraints  
Loads  
Sensors  
Results Computation  
Results Visualization

# Before You Begin



Before you begin you should be familiar with the following basic concepts:

- What Type of Analysis for What Type of Design?
- What Types of Hypotheses are Used for Analysis?
- About Supports...
- Launching the Solver
- Improving Performances on Multi-Processor Computers
- Loading / Unloading Documents
- Miscellaneous



## What Type of Analysis for What Type of Design?

You will find here below three methodological cases for generating mesh, depending on the type of the geometry.



**GPS:** Generative Part Structural Analysis workbench



**FMS/FMD:** Advanced Meshing Tools workbench



**GSD:** Generative Shape Design workbench



**PRT:** Part Design workbench

Analyzing in "Generative Part Structural Analysis" Workbench (GPS) After Meshing in "Advanced Meshing Tools workbench" (FMS/FMD)



The selected FMS mesh part will be used for analysis.

This mesh contains triangle and quadrangle shell elements. Those elements can be linear (three nodes - four nodes) or parabolic (six nodes - eight nodes). They have six degrees of freedom per node (three translations and three rotations) to take into account membrane and bending effects.

The thickness of the part needs to be specified by double-clicking on **Material Property** in the specification tree.

All the preprocessing specifications (Loads, Restraints, Masses) will have to be applied to the geometries that were selected in FMS workbench (by clicking the Surface Mesh  icon).

## Analyzing in "Generative Part Structural Analysis" (GPS) Workbench Surface Geometry Designed in "Generative Shape Design" (GSD) Workbench



### 1. First case

You first indicated in GSD which geometry you want to be analyzed by going into **Tools** -> **External View** commands from the menu bar.

The following will be generated: mesh parts and shell properties.

A 2D Octree mesh Part is automatically created when starting GPS.

This mesh part will generate triangle shell elements. Those elements can be linear (three nodes) or parabolic (six nodes). They have six degrees of freedom per node (three translations and three rotations) to take into account membrane and bending effects.

### 2. Second case

You did not indicate in GSD which geometry you want to be analyzed.  
You will have to use Mesh Part commands to generate Mesh Parts and properties commands to generate properties.

## Notes

- You can edit, delete or re-create mesh parts and properties at any time.  
In case of inconsistencies, use the Check command .

- All the specifications (Loads, Restraints, Masses) will have to be applied to a geometry on which a Mesh part and property was created.

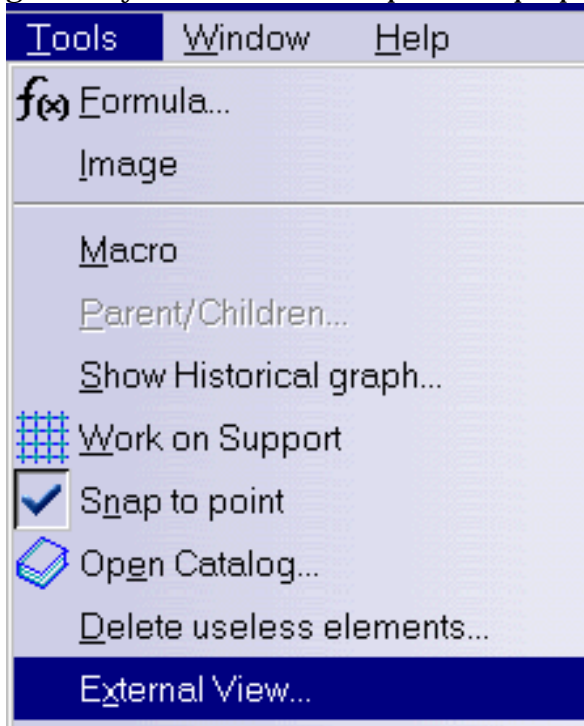

### Analyzing in "Generative Part Design" (GPS) Workbench Solid Geometry Designed in Part Design (PRT)



- A 3D OCTREE mesh Part is automatically created.
- This mesh part will generate tetrahedron elements. Those elements can be linear (four nodes) or parabolic (ten nodes). They have three degrees of freedom per node (three translation).
- All the preprocessing specifications (Loads, Restraints, Masses) will be applied to the Part Body geometry.



# What Type of Hypotheses are Used for Analysis?

You will find here below **three types of hypotheses** used when working in Analysis workbench.

1. Small displacement (translation and rotation)
2. Small strain
3. Linear constitutive law: linear elasticity

For static case solutions, one can say that:

- If there is no contact feature (either virtual or real), no pressure fitting property and no bolt tightening (either virtual or real) feature, then the problem is **linear**, that is to say, the displacement is a linear function of the load.
- If there is at least one contact feature (being virtual or not) or pressure fitting property or bolt tightening (being virtual or not) feature, then the problem is **non linear**, that is to say, the displacement is a non linear function of the load.

## About Supports ...

Analysis specifications can be applied to different types of supports (or features):

- Geometrical Feature
  - Point/Vertex (except GSM points)
  - Curve/Edge
  - Surface/Face
  - Volume/Part
  - Groups (points, curves, surfaces, parts)
- Mechanical Feature
- Analysis Feature

For more details about the Supports, please refer to [Associativity](#) the *Frequently Asked Questions* section.

When you select a mechanical feature, the analysis specification is actually applied on the resulting associated geometry. If this geometry is not an authorized geometrical supports (see table below), you will not be able to select the mechanical feature. For example, selecting a fillet for a Line Force Density will not be allowed because the resulting geometry of a fillet are surfaces while the authorized geometrical entities for Line Force Density are line or edges.



To apply a restraint, a load or a connection to one extremity of a beam, you need to first put the point that were possibly created at the extremity of this beam, in order to build the wireframe, into the **Hide** mode. As result, to apply the above mentioned specifications, you will select the extremity of the wireframe and not the hidden point (small cross in the 3D view) as this point is not linked to the mesh.



## Launching the Solver

The below capability is only available with the **ELFINI Structural Analysis (EST)** product.

The kernels steps of the solver are launched transparently on a different process.

This concerns the steps that are consuming a lot of memory. The slave process will benefit from small contiguous available memory for computation.

It is strongly recommended that you extend the memory of the used machine with extended paginated memory. The master process will automatically paginate its own data on this paging memory.

## Improving Performances on Multi-Processor Computers

- On Windows platforms: the ElfiniSolver is multithreaded if more than one processor is found.
- On SGI machines: you have to specify the number of processor to be used with the UNIX command:  
**export ELF\_NUM\_THREADS=2** (if you want to use two processors)  
By default, one processor will be used.
- On AIX machines: you may specify the number of processors to be used with the UNIX command:  
**export XLSMPOPTS="parthds=2"** (if you want to use two processors)  
By default, all the available processors will be used.

# Loading / Unloading Documents

You can unload geometry document (CATPart, CATProduct) using the **File->Desk** menu.

Unloading a document allows you to liberate memory while working on large models (post-processing and computation). Moreover, specifications you have defined are kept up-to-date.

In the FileDesk workbench, right-click the CATPart or CATProduct document you want to unload and select the **Unload** contextual menu:

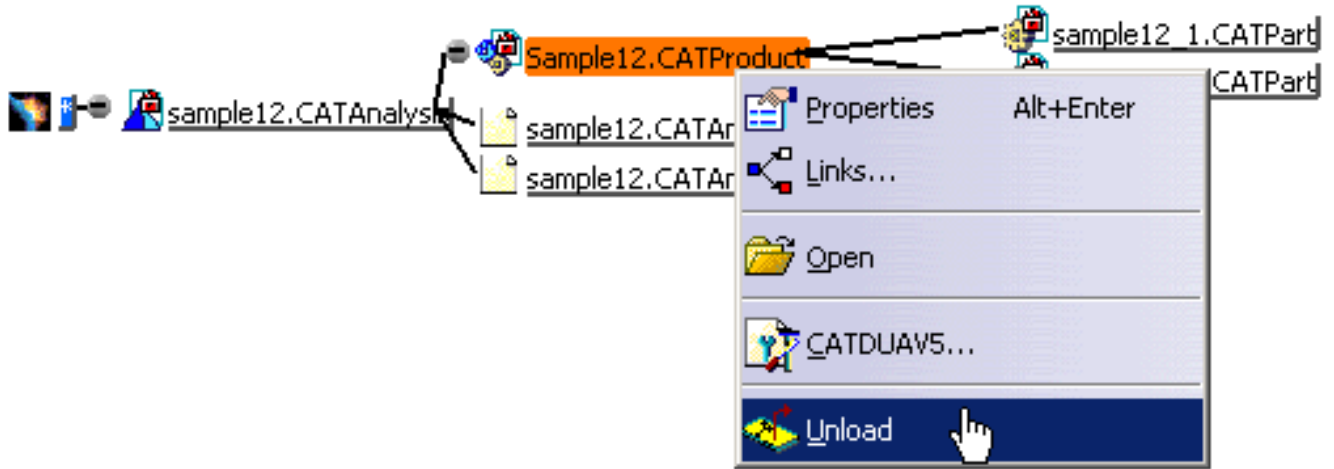

In this example, the pointed documents (two CATPart files) are also unloaded.

For more details, please refer to [Using the FileDesk Workbench](#) in the *Infrastructure User's Guide*.

## Miscellaneous

**DMU Space Analysis** workbench:

Any CATAnalysis document that will be imported into a product needs to be updated if you wish to use it in DMU Space Analysis workbench.



# Analysis Cases



A new Analysis Case is a set of objects sets (a template) corresponding to a new set of specifications of simultaneous environmental actions on a given system.

## Create a Finite Element Model

Generate a Finite Element Model, optionally containing an empty Static of Frequency Analysis Case.

## Inserting Analysis Cases



### Insert a New Static Case

Generate a Static Analysis Case objects set.



### Insert a New Static Constrained Case

Generate a Static Constrained Analysis Case objects set.



### Insert a New Frequency Case

Generate a Frequency Analysis Case objects set.



### Insert a New Buckling Case:

Generate a Buckling Analysis Case objects set.



### Insert a New Combined Case

Generate a Combined Analysis Case objects set.



### Insert a Harmonic Dynamic Response Case

Generate a Harmonic Dynamic Response Analysis Case objects set.



### Insert a Transient Dynamic Response Case

Generate a Transient Dynamic Response Analysis Case objects set.





# Creating a Finite Element Model



This task shows you how to create a Finite Element Model, and optionally an Analysis Case.



*Finite Element Models* are representations used for performing computer-aided engineering analysis (CAEA) of products. They are complementary to computer-aided design (CAD) models, which are mainly geometric representations of products.

A Finite Element Model consists of:

- a **system** representation, consisting of:
  - a Mesh objects set (containing Node and Element objects)
  - a Properties objects set (containing Property-type objects)
  - a Materials objects set (containing Material-type objects)
  - an Axis objects set (containing Axis-type objects)
- various **environment actions** representations, each consisting of:
  - an Analysis Case object sets, defining implicitly the type of analysis (solution procedure) expected, and possibly containing:
    - a Restraints objects set (containing Restraint-type objects)
    - a Loads objects set (containing Load-type objects)
    - a (NS) Masses objects set (containing Mass-type objects)
  - for each Analysis Case, a Solution objects set, defining the type of results sought:
    - images
    - analyses
    - reports
    - graphs...

The Finite Element Model can initiate a solution process when a sufficient amount of specifications have been captured in the objects constituting the representations of the model.

At the creation of a Finite Element Model, the program automatically generates the system representation template, and proposes to also generate an Analysis Case template for the environment representation and also for indicating the type of solution procedure sought.



If you do not have the ELFINI Structural Analysis product license, your Finite Element Model can simultaneously contain at most one Static Analysis Case and one Frequency Analysis Case.



You can use the [sample01.CATPart](#) document from the samples directory for this task.



1. Select **Start -> Analysis & Simulation -> Generative Structural Analysis.**

The New Analysis Case dialog box appears.

You can create several types of template:

- o **Static Analysis Case**
- o **Frequency Analysis Case**
- o **Free Frequency Analysis Case**

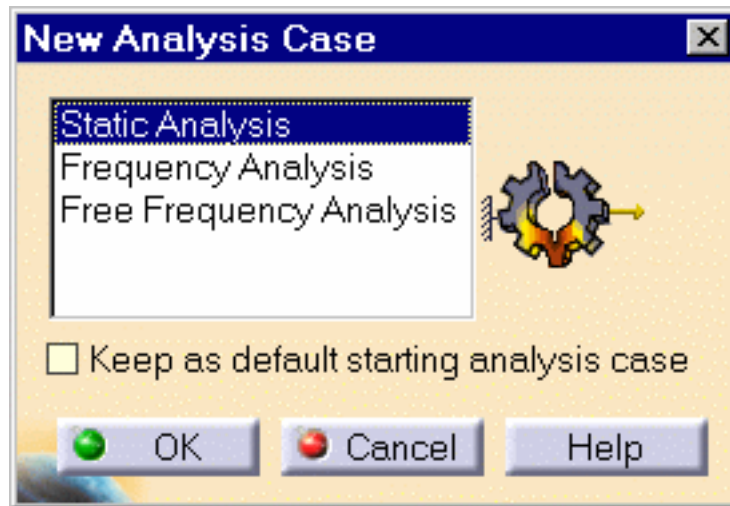

2. Select the desired **Analysis Case** in the list.

The Finite Element Model specification tree template shows the standard system representation objects sets.

The Analysis Case representation contains the following empty object sets:

- **Restraints**
- **Loads**
- **Masses**
- **Solution**
- **Sensors**

- 3.** Select the **Keep As Default** option in the New Analysis Case dialog box if you want to set the current choice as the default choice.
- 4.** Click **OK** in the New Analysis Case dialog box.



When you have the ELFINI Structural Analysis product installed, the Finite Element Model can contain an arbitrary number of (Static and/or Frequency) Analysis Cases.



# Inserting a New Static Case



This task shows you how to insert a Static Case.

Inserting a new Static Case allows you to create objects sets for the new environmental specifications, and to implicitly require a static solution procedure for the computation of the system response to applied static loads under given restraints.



Only available with the **ELFINI Structural Analysis (EST)** product.



You can use the [sample00.CATAnalysis](#) document from the samples directory for this task.



1. Select **Insert -> Static Case** menu .

The Static Case dialog box is displayed.

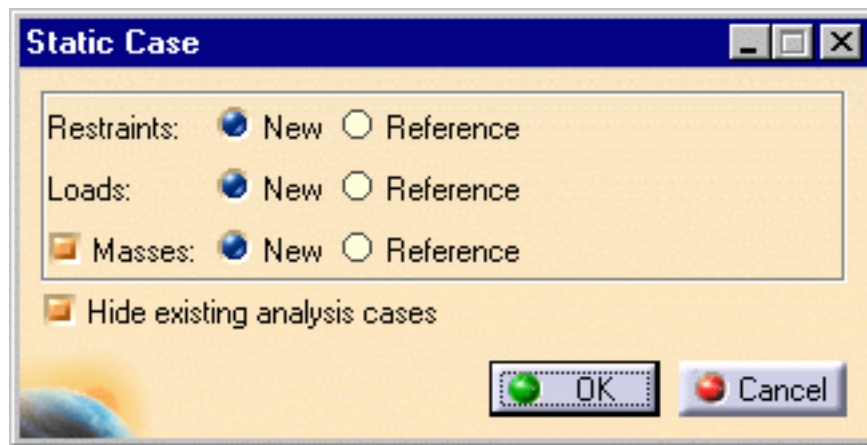

For each type of objects set (**Restrains**, **Loads**, **Masses**), you can require that your new Static Case contains either an empty objects set or an objects set existing in a previously defined Analysis Case.

The **New** and **Reference** switches for **Restrains**, **Loads** and **Masses** objects sets allow you to choose between these two options:

- **New:** the new objects set is empty.
- **Reference:** the new objects set is a copy of an objects set existing in a previously defined Analysis Case.

2. Set the options for each type of objects set.

In this particular example:

- select **New** as **Restraints** and **Loads** options
- deactivate the **Masses** option

**3.** Click **OK** in the Static Case dialog box.

A new **Static Case** objects set appears in the Finite Element Model specification tree.



The new Static Analysis Case representation consists of the following object sets:

- **Restraints**
- **Loads**
- **Solution**

**4.** You can edit the static case. For this, double-click the **Static Case Solution.1** object in the specification tree.

The Static Solution Parameters dialog box appears:

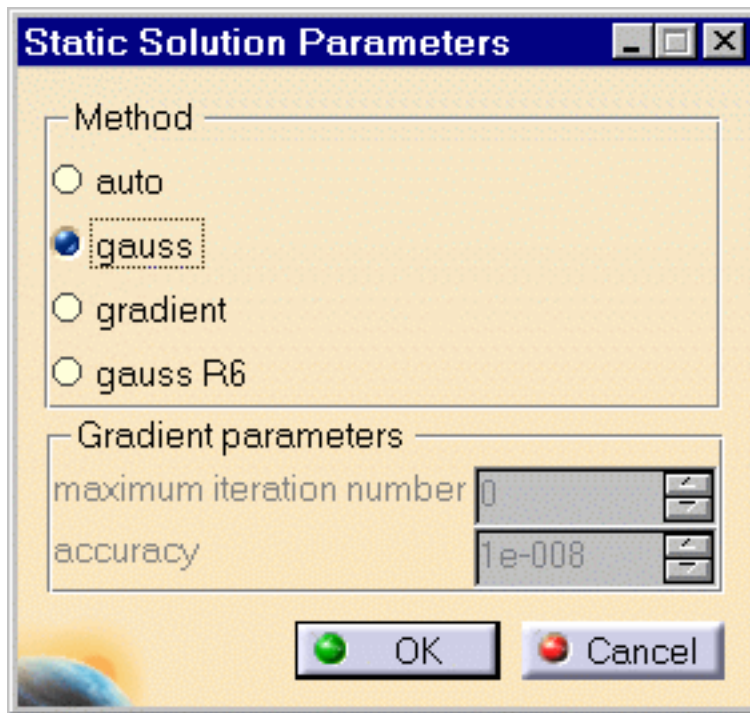

### Method

- **auto**: one of the three methods below is automatically computed
- **gauss**: direct method, recommended for computing small/medium models
- **gradient**: solving iterative method which is memory saving but not CPU time saving, recommended for computing huge models
- **gauss R6**: fast Gauss method recommended for computing large size models

### Gradient parameters

- **maximum iteration number**
- **accuracy**



### Products Available in Analysis Workbench

If you deactivate the **Hide existing analysis cases** option in the Static Case dialog box, the symbols of objects created in previous Analysis Cases will remain displayed.

By default, the last created (inserted) Analysis Case is set as current, and the corresponding objects set is underlined in the analysis features tree.

A right mouse click (key 3) on a Static Case objects set further allows the following action:

**Set as Current**: allows you to define the Static Analysis Case as being the currently

active one.

The Static Case is then underlined in the features tree and all subsequent actions refer to it.

Once a New Analysis Case has been inserted, its Definition parameters cannot be changed.

To modify the Analysis Case Definition parameters you can only replace it (delete followed by insert) in the analysis features tree.



If you do not have the ELFINI Structural Analysis product license, your Finite Element Model can simultaneously contain at most one Static Analysis Case and one Frequency Analysis Case.



# Inserting a New Static Constrained Case



This task shows you how to insert a new Static Constrained Case.

Inserting a *New Static Constrained Case* allows you to create a restraint set (new or reference to an existing one).



Only available with the **ELFINI Structural Analysis (EST)** product.



You can use the [sample04.CATAnalysis](#) document from the samples directory.



1. Select the **Insert -> Static Constrained Modes**  menu.

The Static Constrained Modes dialog box appears.

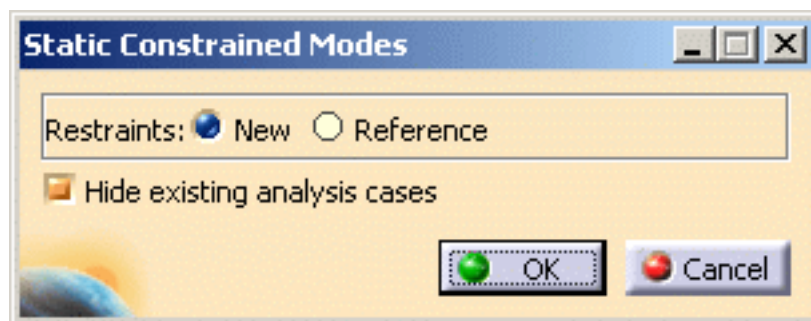

- **Restrains:**
  - **New:** allows you to create a new restraints set that will be empty.
  - **Reference:** allows you to choose an existing restraints set as reference.
- **Hide existing analysis cases:** allows you to hide the analysis cases that have been previously created.

2. Click **OK** in the Static Constrained Modes dialog box.

A **Static Constrained Modes** feature appears in the specification tree.

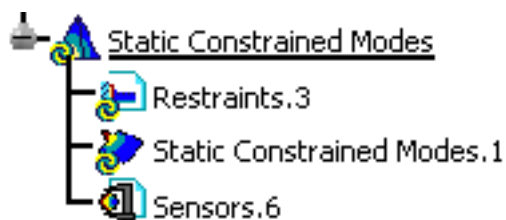



# Inserting a New Frequency Case



This task shows you how to insert a new Frequency Case.



This capability is only available with the ELFINI Structural Analysis product (except for inserting a first Frequency Analysis Case).

Inserting a *new Frequency Case* allows you to create objects sets for the new environmental specifications, and to implicitly require a normal modes solution procedure for the computation of the system vibration frequencies and normal modes for a given non-structural mass distribution under given restraints.



Remember that if you do not have the **ELFINI Structural Analysis** product license, your Finite Element Model can simultaneously contain at most one Static Analysis Case and one Frequency Analysis Case.



You can use the [sample00.CATAnalysis](#) document from the samples directory for this task.



1. Select **Insert -> Frequency Case** .

The Frequency Case dialog box is displayed.

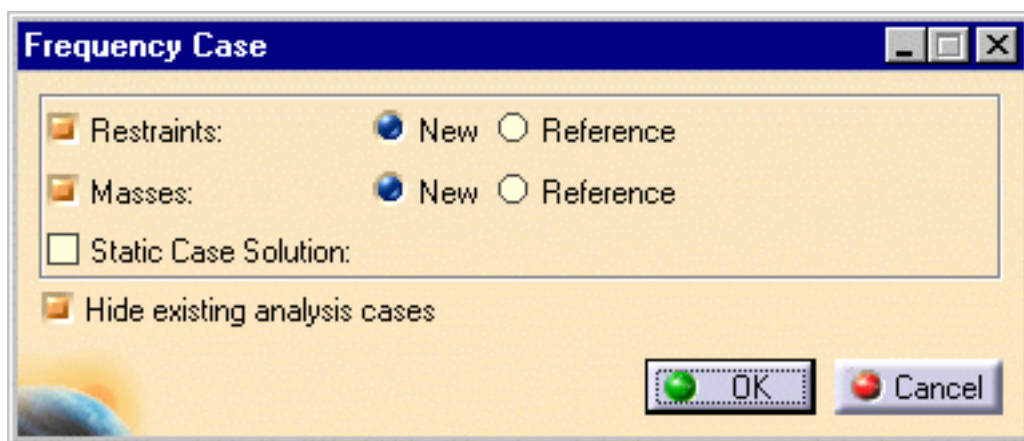

For each type of objects set (**Restrains**, **Masses**, **Static Case Solution**), you can require that your new Frequency Case contains either an empty objects set or an objects set existing in a previously defined Analysis Case.

The **New** and **Reference** switches for **Restraints** and **Masses** objects sets allow you to choose between these two options:

- **New:** the new objects set is empty.
- **Reference:** the new objects set is a copy of an objects set existing in a previously defined Analysis Case.
- **Static Case Solution** option allows you to perform a pre-loaded frequency computation by selecting a static solution. The frequency computation will then take the corresponding loads into account and generate a (non-linear, load-dependent) pre-loaded frequency computation.



This capability is only available with the **ELFINI Structural Analysis (EST)** product.

2. Set the switch for each type of objects set and click **OK**.

A new Frequency Case template (objects sets set) appears in the Finite Element Model specification tree template displayed on the left.



The new Frequency Analysis Case representation consists of the following (empty) object sets:

- **Restraints**
- **Masses**
- **Solution**

You can edit the frequency case, by double-clicking on the **Frequency Case Solution** object in the specification tree.

The following dialog box will appear:

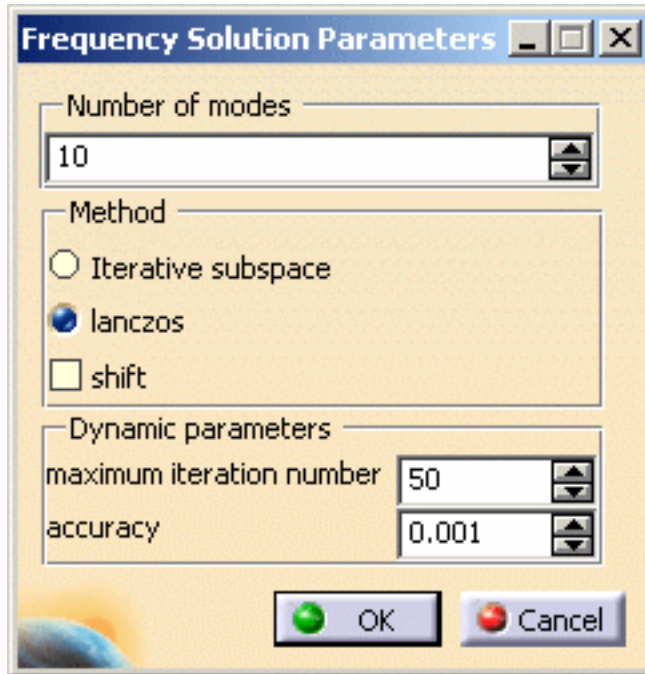

- **Number of modes**
- **Method (Iterative subspace, lanczos)** (only available if you have ELFINI Structural Analysis product installed, otherwise, the default method is **Iterative subspace**).

If you select the **lanczos** Method, the **Shift** option appears: compute the modes beyond a given value: **Auto**, **1Hz**, **2Hz** and so forth. **Auto** means that the computation is performed on a structure that is partially free.

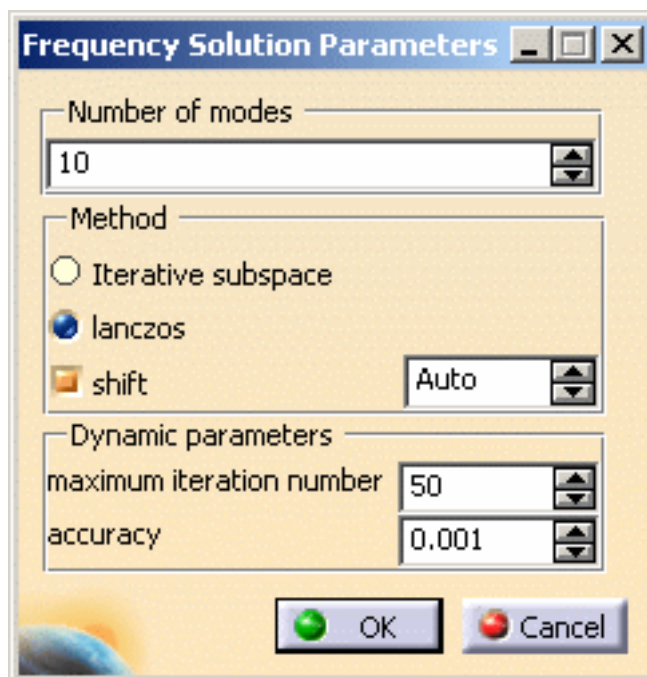

- **Dynamic parameters (maximum iteration number, accuracy)**



By default, the last created (inserted) Analysis Case is set as current, and the corresponding objects set is underlined in the analysis features tree.

A right mouse click (key 3) on a Frequency Case objects set further allows the following action:

**Set as Current:** allows you to define the Frequency Analysis Case as being the currently active one. The Frequency Case is then underlined in the features tree and all subsequent actions refer to it.

If you inactivate the **Hide Existing Analysis Cases** switch in the Frequency Case dialog box, the symbols of objects created in previous Analysis Cases will remain displayed.

Once a New Analysis Case has been inserted, its **Definition parameters** cannot be changed.

To modify the Analysis Case Definition parameters you can only replace it (**Delete** followed by **Insert**) in the analysis specification tree.

To compute free vibration modes, you need a Frequency Analysis Case containing no Restraints objects set. This means that you must insert a new Frequency Analysis Case without Restraints.



To compute free vibration modes, you need a Frequency Analysis Case containing no Restraints objects set. This means that you must first delete the existing Frequency Analysis Case and insert a new Frequency Analysis Case without Restraints.

To subsequently compute supported (non-free) vibration modes, you must delete the previous, Restraints-less (free vibration modes) Frequency Analysis Case and insert a new (supported) Frequency Analysis Case with Restraints.



# Inserting a New Buckling Case



This task shows you how to insert a Buckling Case.

Inserting a *New Buckling Case* allows you to require a buckling modes solution procedure for the computation of the system buckling critical loads and buckling modes for a given [Static Analysis Case](#).



Only available with the **ELFINI Structural Analysis (EST)** product.



You can use the [sample00.CATAnalysis](#) document from the samples directory for this task.



1. Select **Insert -> Buckling Case** .

The Buckling Case dialog box appears.

2. Select the **Static Case Solution (Reference)** field to which you will associate your new Buckling Case.

You can associate your new Buckling Case either to an existing Static Case or to a new one.

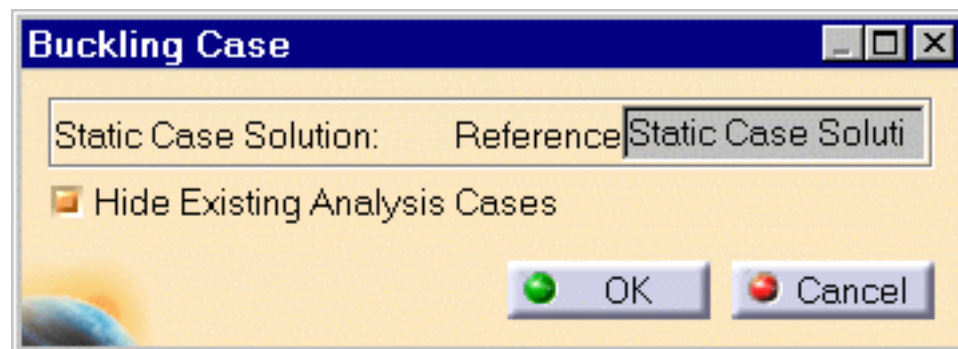

The **Hide Existing Analysis Cases** option allows you to hide all symbols representing physical attributes applied to your part.

A new Buckling Case template (objects sets set) appears in the Finite Element Model specification tree template displayed on the left.

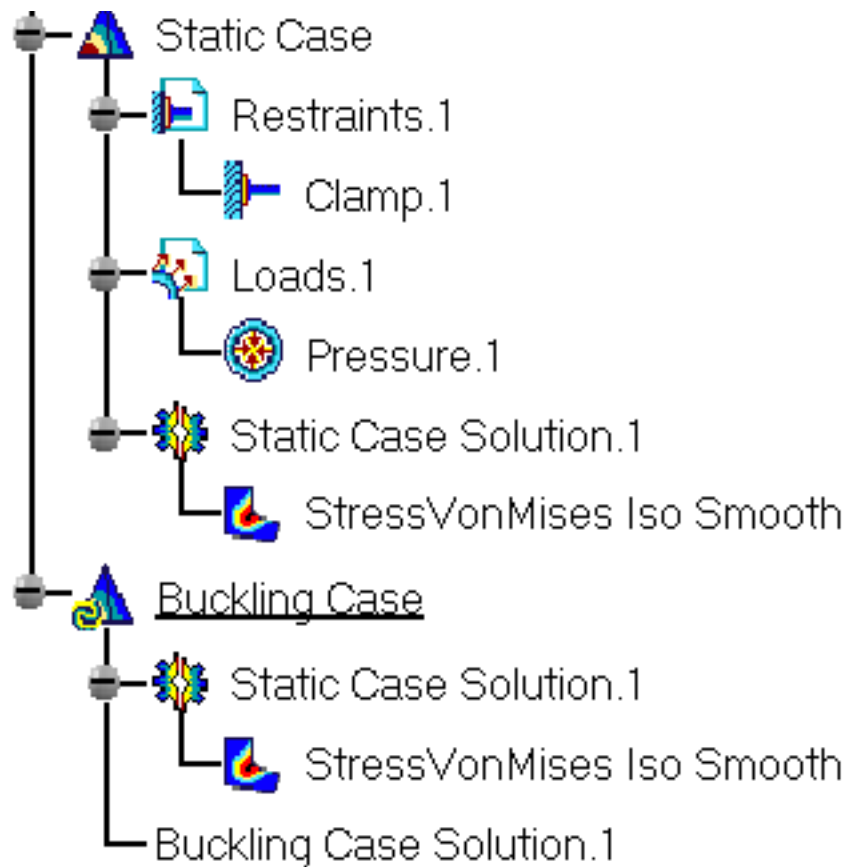

The new Buckling Analysis Case representation consists of the following (empty) object sets:

- **Static Case Solution**
- **Buckling Case Solution**

**3.** Click **OK** in the Buckling Case dialog box.



### Products Available in Analysis Workbench

By default, the last created (inserted) Analysis Case is set as current, and the corresponding objects set is underlined in the analysis features tree.

Once a New Analysis Case has been inserted, its Definition parameters cannot be changed.

To modify the Analysis Case Definition parameters you can only replace it (delete followed by insert) in the analysis specification tree.



# Inserting a New Combined Case



This task shows you how to insert a new Combined Case.

Inserting a Combined Case allows you to specify reference [Static Analysis Cases](#) and associated coefficients when editing.

You can now compute a small number of static cases and perform lots of combinations when performing post-processing analyses.



Only available with the **ELFINI Structural Analysis (EST)** product.



You can use the [sample03.CATAnalysis](#) document from the samples directory.



1. Select **Insert -> Combined Case** .

The **Combined Static Case Solution.1** feature appears in the specification tree.

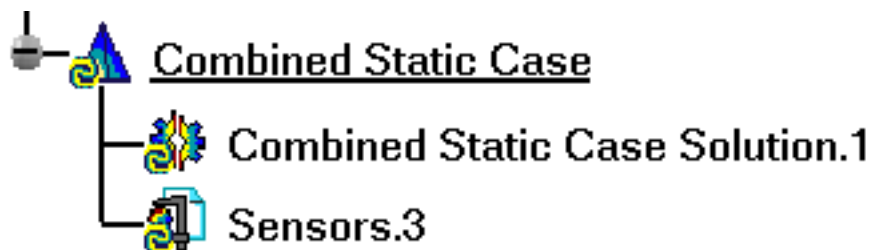

2. Double-click on the **Combined Static Case Solution.1** in the specification tree.

The Combined Solution dialog box appears: you can now select the static cases to be combined.

Once the Combined Solution dialog box below appears, you will select in the specification tree the static cases to be combined and, if needed, the **Coefficient** associated to each solution. In this particular case, select both **Static Case Solution.1** and **Static Case Solution.2**. and leave the coefficient to **1** for both solutions.

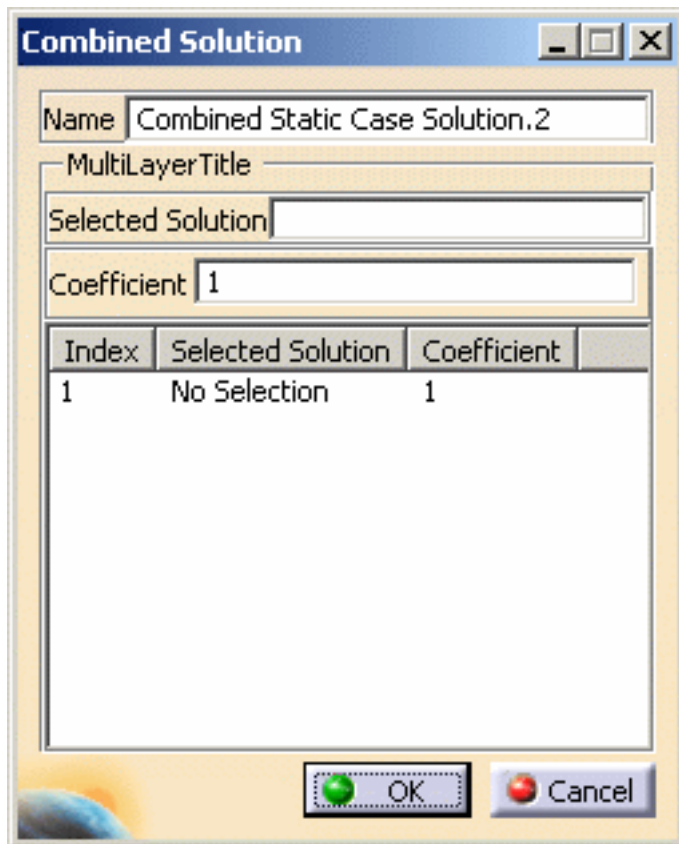

3. Select the first static case: **Static Case Solution.1**.
4. Right-click the solution that has just been added (**Static Case Solution.1**) and then select the **Add** contextual menu.



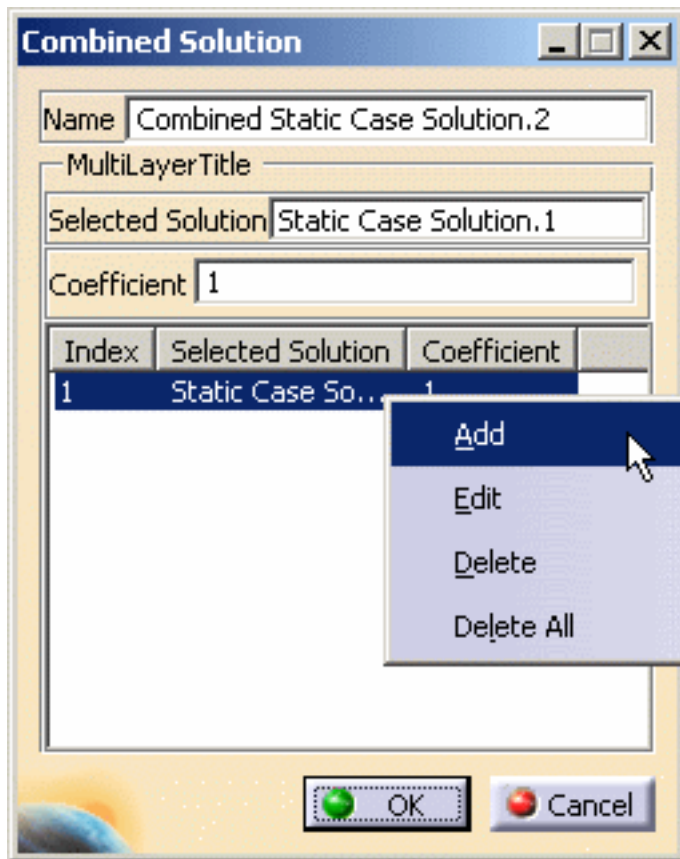

Note that using this contextual menu, you can also edit, delete one or all the solutions.

5. Select the second static case: **Static Case Solution.2**.

The features corresponding to the selected solutions are automatically highlighted in the specification tree.

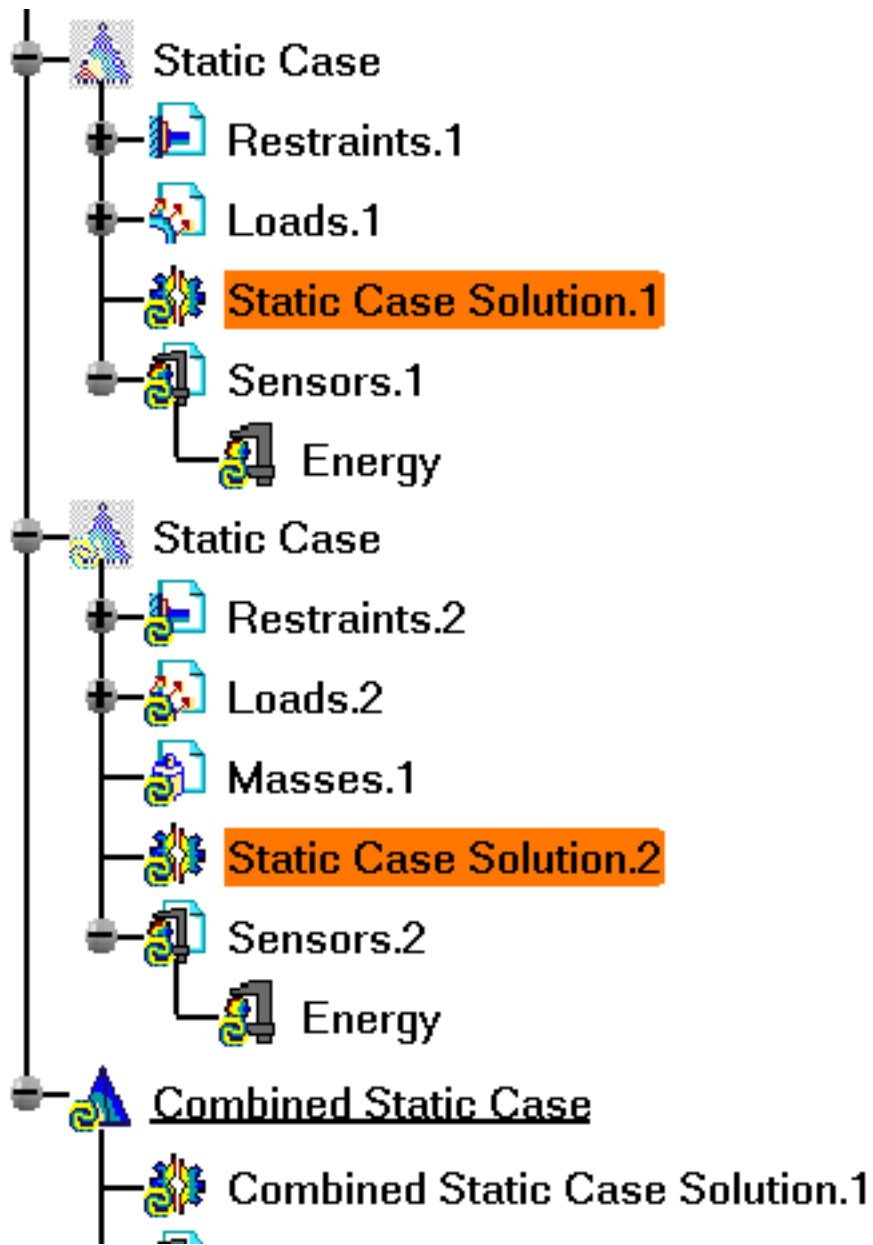

The Combined Solution dialog box is updated.

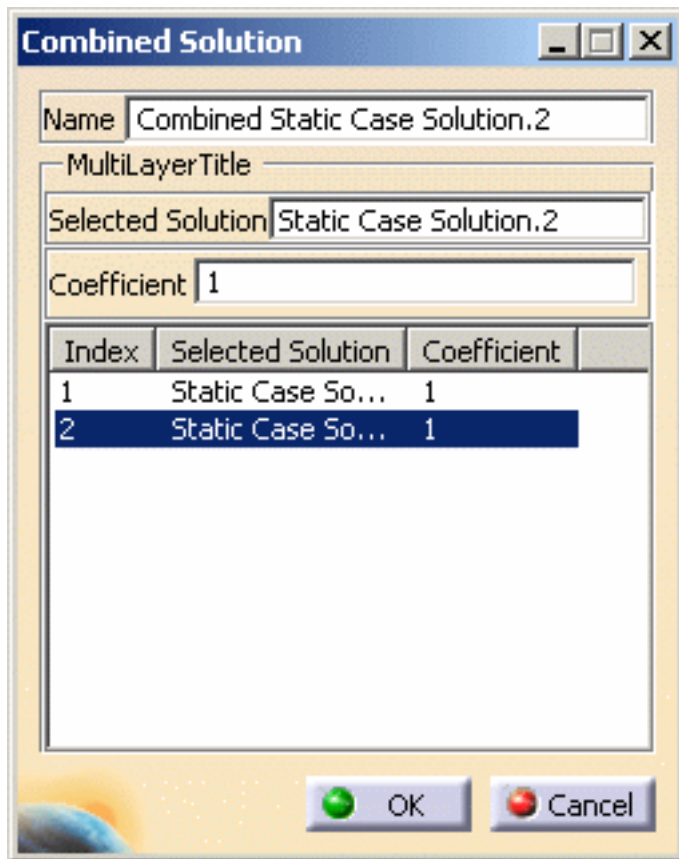

6. Click **OK** in the Combined Static Solution dialog box when you are satisfied with the selected solutions.



At any time, you can double-click on the **Combined Static Case Solution.1** in the specification tree and perform the desired operations (see above described contextual menu).



# Inserting a Harmonic Dynamic Response Case



This task shows you how to insert a Harmonic Dynamic Response Case containing an excitation (load excitation or restraint excitation) and a damping.

Inserting a Harmonic Dynamic Response Case allows you to create objects sets and to set up a harmonic dynamic solution where loads or restraint will be excited.



Only available with the **Generative Dynamic Response Analysis (GDY)** product.



To insert a Harmonic Dynamic Response Case:

- a Frequency Case must be defined.  
For more details, please refer to [Inserting a Frequency Case](#).
- a Static Case must be defined only if you choose a load excitation set.  
For more details, please refer to [Inserting a Static Case](#).



Open the [sample56.CATAnalysis](#) document from the samples directory.

In this particular example, a static case and a frequency case have been previously defined.

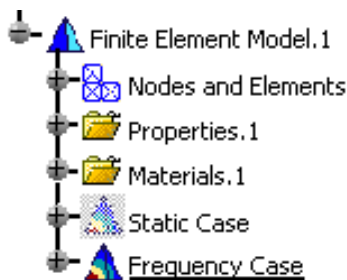

1. Select the **Insert -> Harmonic Dynamic Response Case**  menu.

The Harmonic Dynamic Response Case dialog box appears.

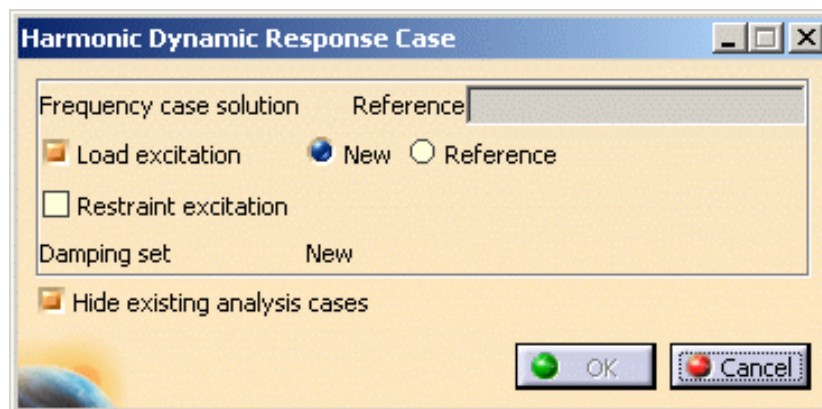

- **Reference:** allows you to choose a reference solution case.

- **Excitation set:** lets you choose the excitation set.



A load excitation set and a restraint excitation set cannot be created simultaneously.

- **Load excitation set:** allows you to choose to create a new load excitation set or to reference an existing one.
  - **New:** allows you to create a new load excitation set that will be empty.
  - **Reference:** allows you to choose an existing load excitation set as reference.
- **Restraint excitation set:** allows you to choose to create a new restraint excitation set or to reference an existing one.
  - **New:** allows you to create a new restraint excitation set that will be empty.
  - **Reference:** allows you to choose an existing restraint excitation set as reference.
- **Damping set:** informs you that a new Damping set will be created.
- **Hide existing analysis cases:** allows you to hide the analysis cases that have been previously created.

**2.** Select the **Frequency Case Solution.1** solution as **Frequency Case Solution** reference.

**3.** Choose the desired excitation set.

For this, activate the desired option in the Harmonic Dynamic Response Case dialog box.

- Activate the **Load excitation** option if you want to apply a load excitation set (for a dynamic load).

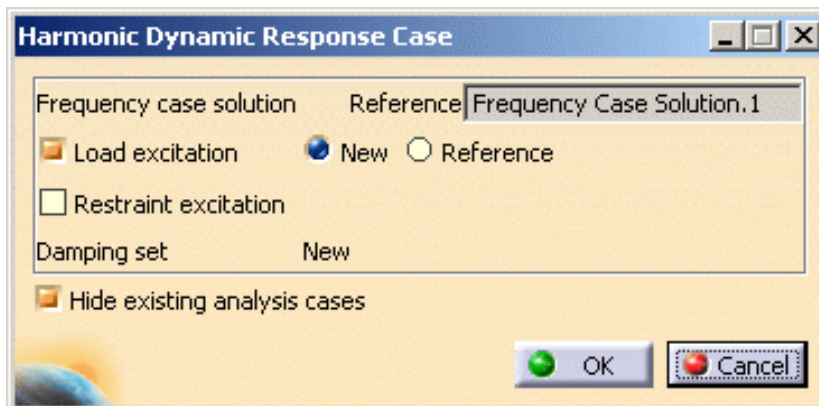

- Activate the **Restraint excitation** option if you want to apply a restraint excitation set (for an imposed motion of the support).

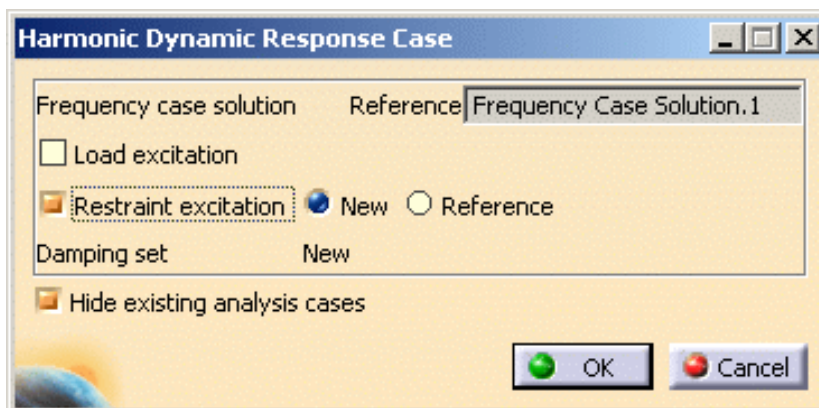

**4.** Click **OK** in the Harmonic Dynamic Response Case dialog box.

The **Harmonic Dynamic Response Case** feature appears in the specification tree.

**Load excitation option activated:**

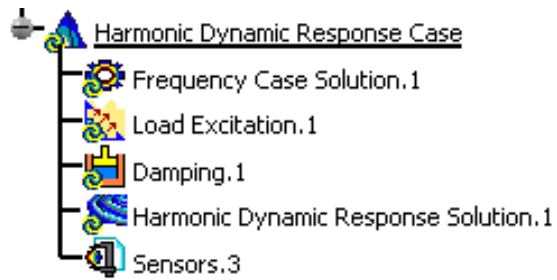

**Restraint excitation option activated:**

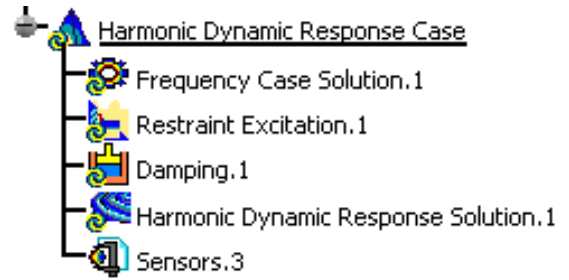

You now have to define the excitation (Load or Restraint) how you will excite the part as well as the damping of this part.

For this, please refer to [Modulation](#) and [Dynamic Response Sets](#) chapters in this guide.



# Inserting a Transient Dynamic Response Case



This task shows you how to insert a Transient Dynamic Response Case containing an excitation (load excitation or restraint excitation) and a damping.

Inserting a Transient Dynamic Response Case allows you to create objects sets and to set up a dynamic solution where loads or restraint will be excited.



Only available with the **Generative Dynamic Response Analysis (GDY)** product.



To insert a Transient Dynamic Response Case:

- a Frequency Case must be defined.  
For more details, please refer to [Inserting a Frequency Case](#).
- a Static Case must be defined only if you choose a load excitation set.  
For more details, please refer to [Inserting a Static Case](#).



Open the [sample56.CATAnalysis](#) document from the samples directory.

In this particular example, a static case and a frequency case have been previously defined.

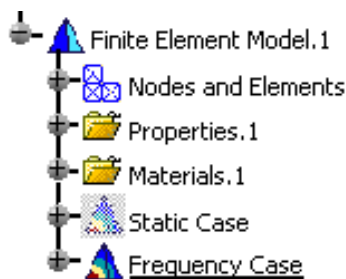

1. Select the **Insert -> Transient Dynamic Response Case**  menu.

The Transient Dynamic Response Case dialog box appears.

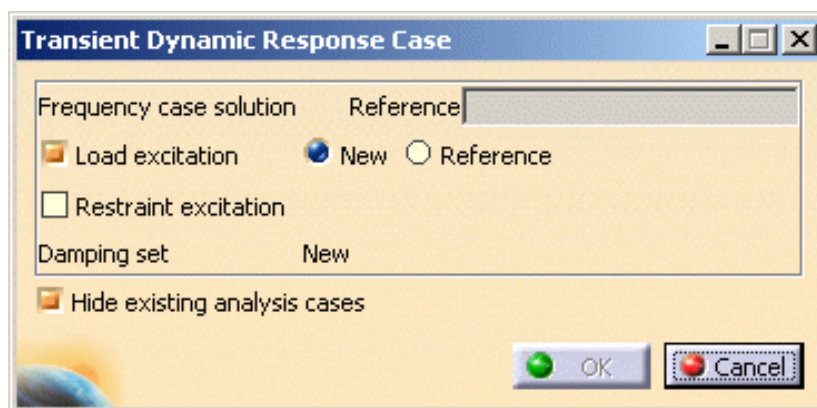

- **Reference:** allows you to choose a reference solution case.



- **Excitation set:** lets you choose the excitation type.



A load excitation set and a restraint excitation set cannot be created simultaneously.

- **Load excitation set:** allows you to choose to create a new load excitation set or to reference an existing one.
  - **New:** allows you to create a new load excitation set that will be empty.
  - **Reference:** allows you to choose an existing load excitation set as reference.
- **Restraint excitation set:** allows you to choose to create a new restraint excitation set or to reference an existing one.
  - **New:** allows you to create a new restraint excitation set that will be empty.
  - **Reference:** allows you to choose an existing restraint excitation set as reference.
- **Damping set:** informs you that a new damping set will be created.
- **Hide existing analysis cases:** allows you to hide the analysis cases that have been previously created.

**2.** Select the **Frequency Case Solution.1** solution as **Frequency Case Solution** reference.

**3.** Choose the desired excitation set.

For this, activate the desired option in the Transient Dynamic Response Case dialog box.

- Activate the **Load excitation** option if you want to apply a load excitation set (for a dynamic load).

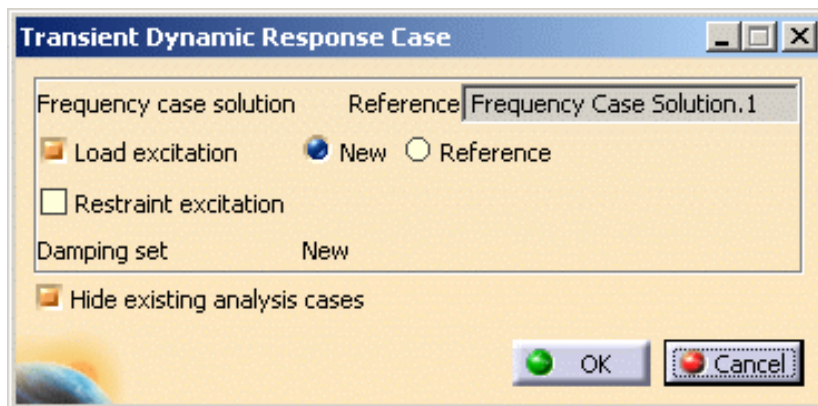

- Activate the **Restraint excitation** option if you want to apply a restraint excitation set (for an imposed motion of the support).

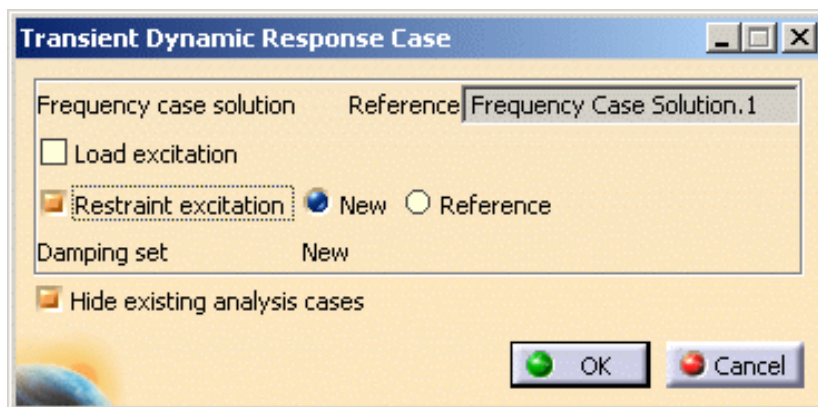

**4.** Click **OK** in the Transient Dynamic Response Case dialog box.

The **Transient Dynamic Response Case** feature appears in the specification tree.



**Load excitation option activated:**

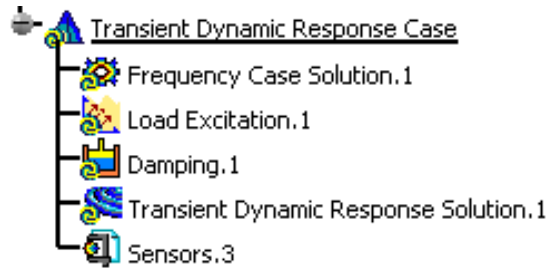

**Restraint excitation option activated:**

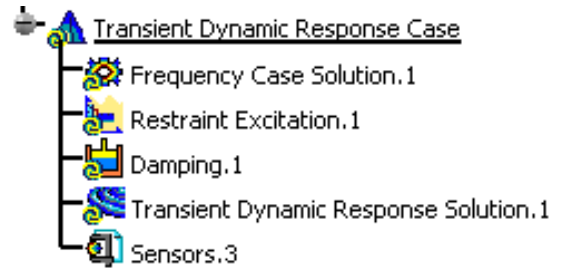

You now have to define the excitation (Load or Restraint) how you will excite the part as well as the damping of this part.

For this, please refer to [Modulation](#) and [Dynamic Response Sets](#) chapters in this guide.



# Modulation



Only available with the **Generative Dynamic Response Analysis (GDY)** product.



## Create White Noise Modulation

Create a constant modulation (equal to one).



## Import Frequency Modulation

Import a frequency modulation from an existing xls or txt file.



## Import Time Modulation

Import a time modulation from an existing xls or txt file.

# Creating White Noise Modulation



This task will show you how to create a white noise modulation.

A White Noise Modulation is a constant modulation (equal to one).



- This functionality is only available if you installed the **Generative Dynamic Response Analysis (GDY)** product.
- A Dynamic Response Case must have been previously inserted.



Open the [sample56\\_1.CATAnalysis](#) document from the samples directory.



1. Click the **White Noise** icon .

The White Noise Modulation dialog box appears.

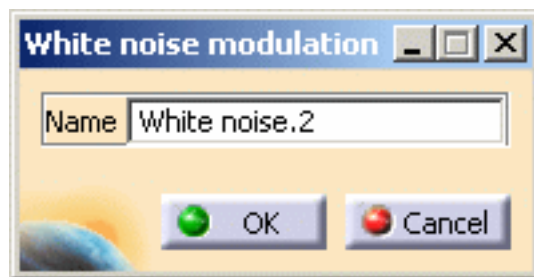

A **Modulations.1** set has been created in the specification tree under the **Finite Element Model.1** set.

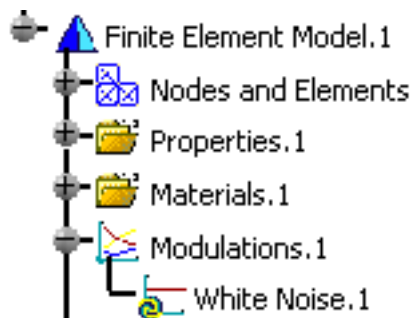

2. Modify the name of modulation you just have created, if needed.
3. Click **OK** in the White Noise Modulation dialog box.



- You can now define the load excitation set or the restraint excitation set. For this, please refer to the [Dynamic Response Sets](#) chapter in this guide.
- You can have several modulation objects (white noise modulation or imported modulation) in the modulation set.

To know how to import a modulation from an existing file, please refer to [Importing Frequency Modulation](#) or [Import Time Modulation](#) in this guide.



# Importing Frequency Modulation



This task will show you how to import frequency modulation values from a previously created file (.xls or .txt file).



- This functionality is only available if you installed the **Generative Dynamic Response Analysis (GDY)** product.
- A Dynamic Response Case must have been previously inserted.
- A file containing modulation values must have been previously created. The file must contain the **(Hz)** or **(kHz)** characters.  
The file format can be:
  - **.xls** (two columns Excel file): on Windows
  - **.txt** (Text): on Windows and on Unix



Open the [sample56\\_1.CATAnalysis](#) document from the samples directory.



1. Click the **Frequency Modulation** icon .

The Frequency Modulation dialog box appears.

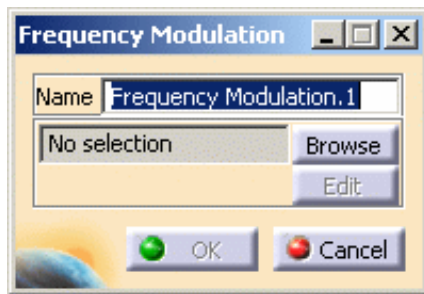

A **Modulations.1** set is created (if it does not already exist) under the **Finite Element Model.1** set.

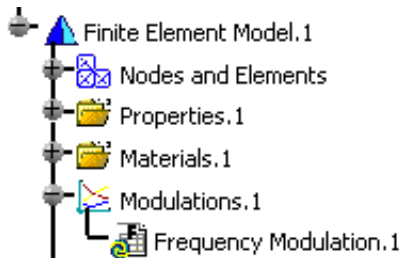

2. Click the **Browse** button to select the file that contains the modulation values. This file can be an excel (.xls) file on Windows or a text (.txt) file on Unix.

The File Selection dialog box appears and lets you select the file you need.

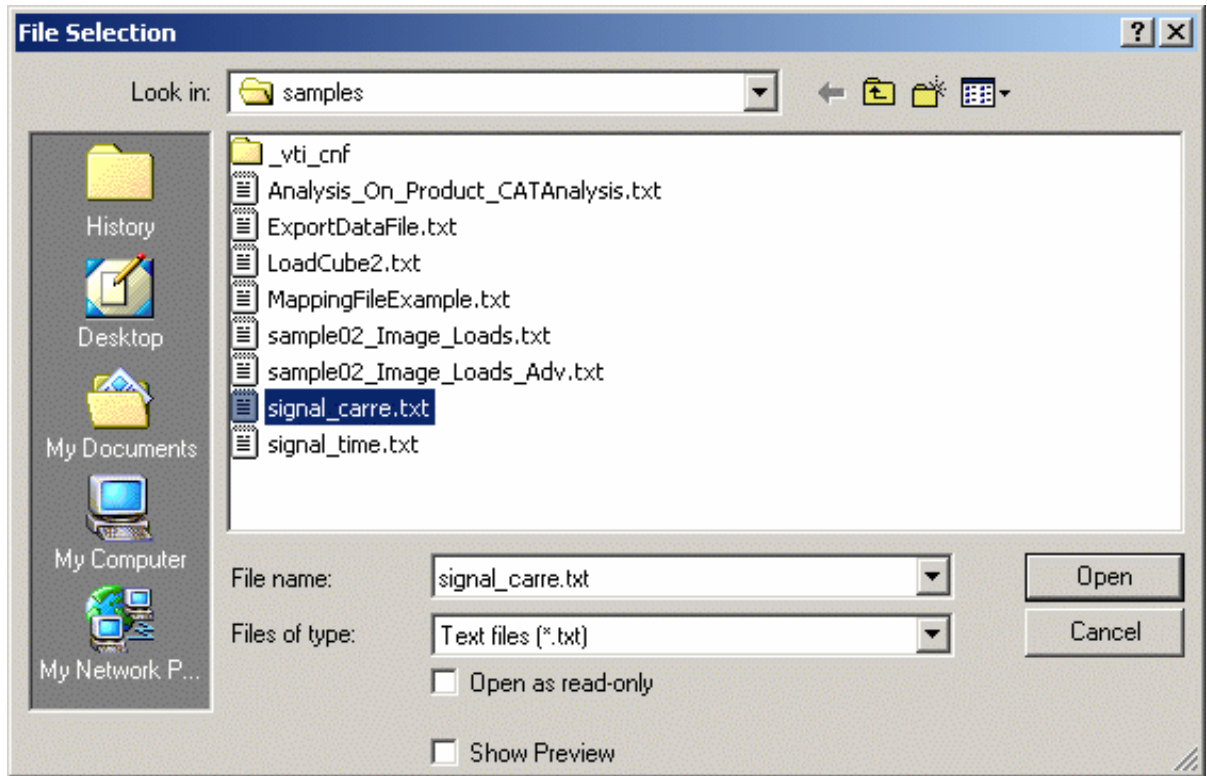

In this particular case, you can select the **signal\_carre.txt** file from the sample directory.

3. Click **Open** in the File Selection dialog box.

The Frequency Modulation dialog box is updated and the path directory of the imported file is displayed.

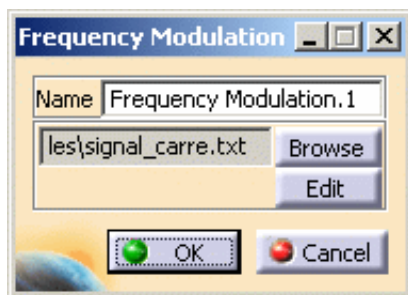

4. Click the **Edit** button to visualize the parameters defined in the file you just have imported.

The Imported Table dialog box appears.

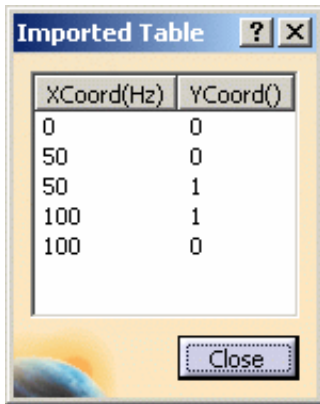

5. Click **Close** in the Imported Table dialog box.
6. Click **OK** in the Frequency Modulation dialog box.



- You can now define the load excitation set or the restraint excitation set.  
For this, please refer to the [Dynamic Response Sets](#) chapter in this guide.
- You can have several modulation objects (white noise modulation or imported modulation) in the modulation set.  
To know more, please refer to [Creating White Modulation](#) or [Importing Time Modulation](#) in this guide.
- You can create a 2D Display document to visualize the modulation.  
For more details, please refer to [Generating 2D Display Visualization](#).



# Importing Time Modulation



This task will show you how to import time modulation values from a previously created file (.xls or .txt file).



- This functionality is only available if you installed the **Generative Dynamic Response Analysis (GDY)** product.
- A dynamic response case must have been previously inserted.
- A file containing modulation values must have been previously created. The file must contain the **(s)** (or other time units supported by CATIA) characters.  
The file format can be:
  - **.xls** (two columns Excel file): on Windows
  - **.txt** (Text): on Windows and on Unix



Open the [sample56\\_1.CATAnalysis](#) document from the samples directory.



1. Click the **Time Modulation** icon .

The Time Modulation dialog box appears.

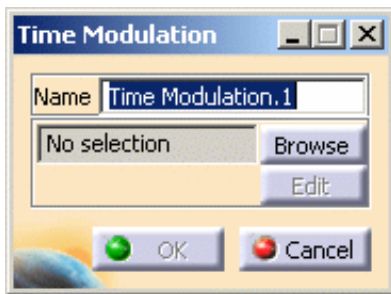

A **Modulations.1** set and a **Time Modulation.1** object are created (if it does not already exist) under the **Finite Element Model.1** set.

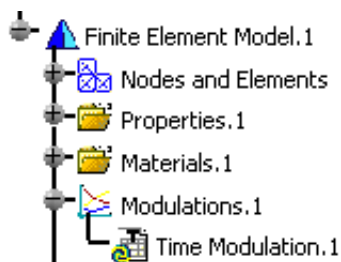

2. Click the **Browse** button to select the file that contains the time modulation values. This file can be an excel (.xls) file on Windows or a text (.txt) file on Unix.



The File Selection dialog box appears and lets you select the file you need.

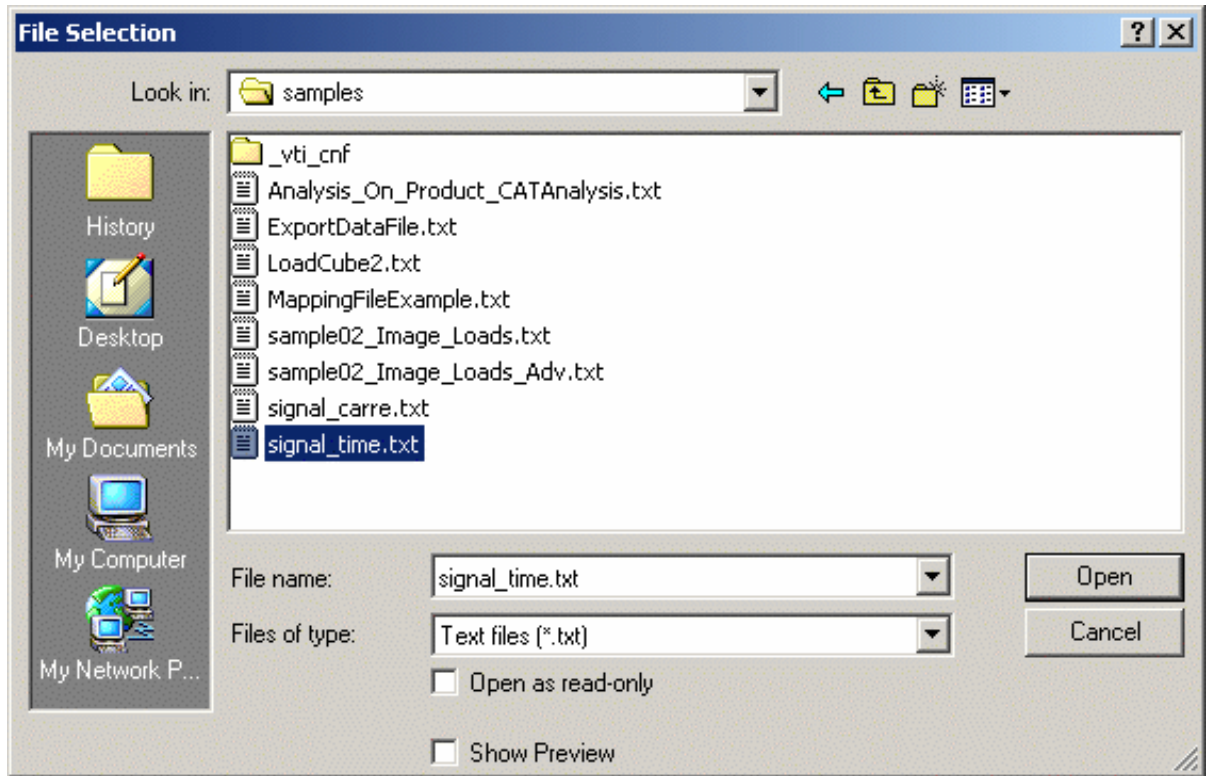

In this particular case, you can select the **signal\_time.txt** file from the sample directory.

3. Click **Open** in the File Selection dialog box.

The Modulation dialog box is updated and the path directory of the imported file is displayed.

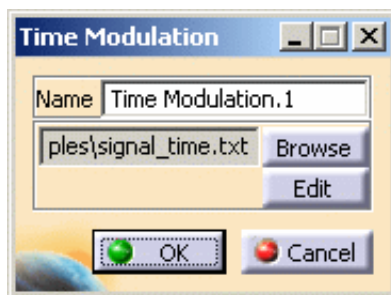

4. Click the **Edit** button to visualize the parameters defined in the file you just have imported.

The Imported Table dialog box appears.

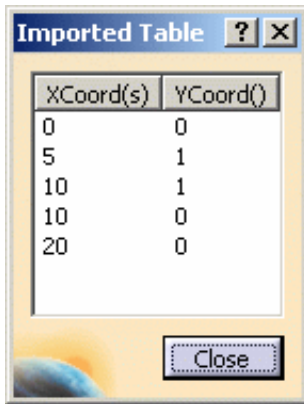

5. Click **Close** in the Imported Table dialog box.

6. Click **OK** in the Time Modulation dialog box.



- You can now define the load excitation set or the restraint excitation set.  
For this, please refer to the [Dynamic Response Sets](#) chapter in this guide.
- You can have several modulation objects (white noise modulation or imported modulation) in the modulation set.  
To know more, please refer to [Creating White Modulation](#) or [Importing Frequency Modulation](#) in this guide.
- You can create a 2D Display document to visualize the modulation.  
For more details, please refer to [Generating 2D Display Visualization](#).



# Dynamic Response Sets



Only available with the **Generative Dynamic Response Analysis (GDY)** product.

When you insert a Dynamic Response Analysis case (harmonic or transient), you have to define the load excitation set and the damping set.

## Define a Load Excitation Set

Apply a modulation to the load that is supposed to excite the part.

## Define a Restraint Excitation Set

Apply a modulation to the restraint that is supposed to excite the part.

## Define a Damping Set

Define the resulting damping of a part once a force has been applied on this part.

# Defining a Load Excitation Set



This task will show you how to define the load excitation set in a:

- [harmonic dynamic response analysis case](#)
- [transient dynamic response analysis case](#)

Defining a load excitation set allows you to define the force type load you will apply.

## Harmonic Dynamic Response Case



Open the [sample57.CATAnalysis](#) document from the samples directory.

### Before You Begin

- insert a [Harmonic Dynamic Response Analysis Case](#) (and choose a load excitation set)
- define a [white noise modulation](#) or define a [frequency modulation](#)

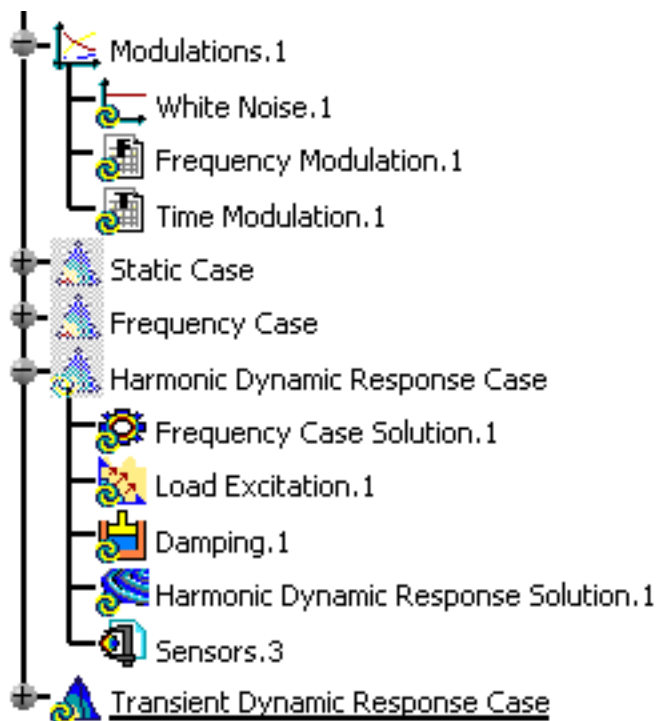



1. Double-click the load excitation set from the specification tree.

In this particular case, double-click the **Load Excitation.1** object of the **Harmonic Dynamic Response Case set**. The Load Excitation Set dialog box appears.

Index	Load	Modulation	Factor	Phase
1	No Selection	No Selection	1	0 (deg)

- o **Name:** gives the name of the excitation set. You can modify it.
- o **Selection:**
  - **Selected load:** lets you select the load you want to excite.
  - **Selected modulation:** lets you select a white noise modulation or a frequency modulation.
    -  You cannot select a time modulation.
  - **Selected factor:** lets you select the factor that will multiply the modulation.
  - **Selected phase:** lets you associate a phase component of a dynamic load excitation (load, modulation and factor).

2. Set the desired parameters in the Load Excitation Set dialog box.

In this particular example, you can:

- o select **Pressure.1** as **Selected load**
- o select **Frequency Modulation.1** as **Selected modulation**
- o enter **1** as **Selected factor** value
- o enter **2deg** as **Selected phase** value

3. Press **Enter** to update the Load Excitation Set dialog box.

The Load Excitation Set dialog box appears as shown below:

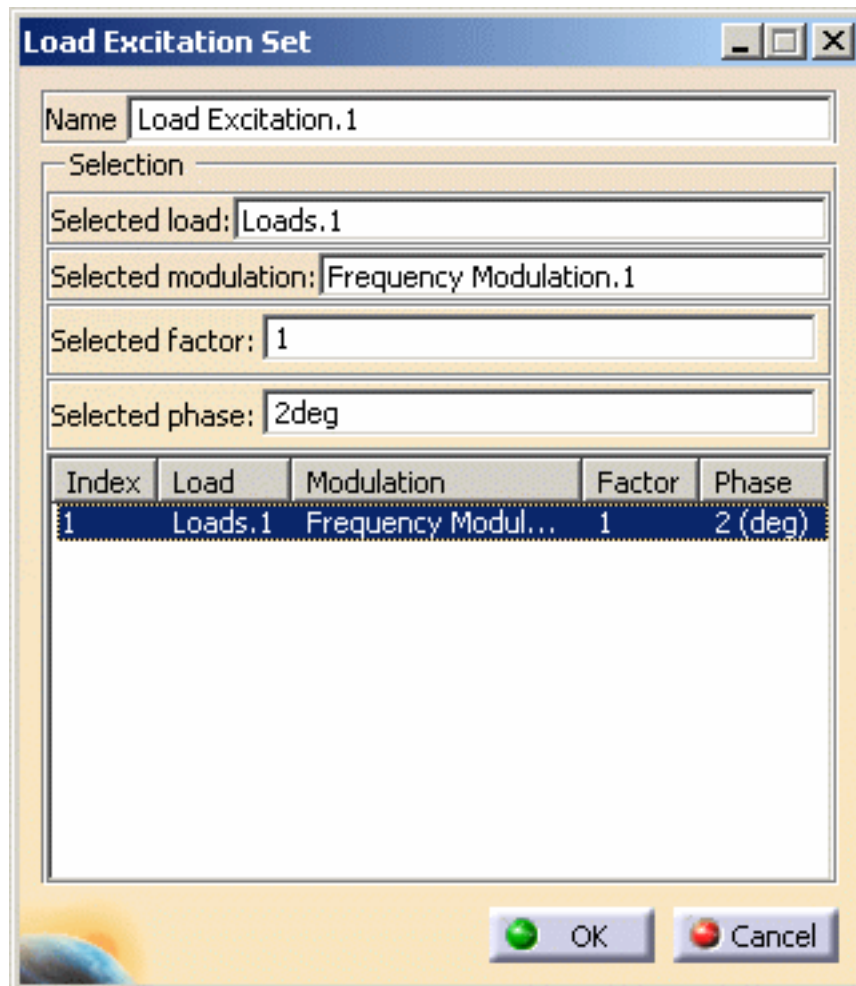

You can add or delete load excitation parameters using contextual menus in the Load Excitation Set dialog box.

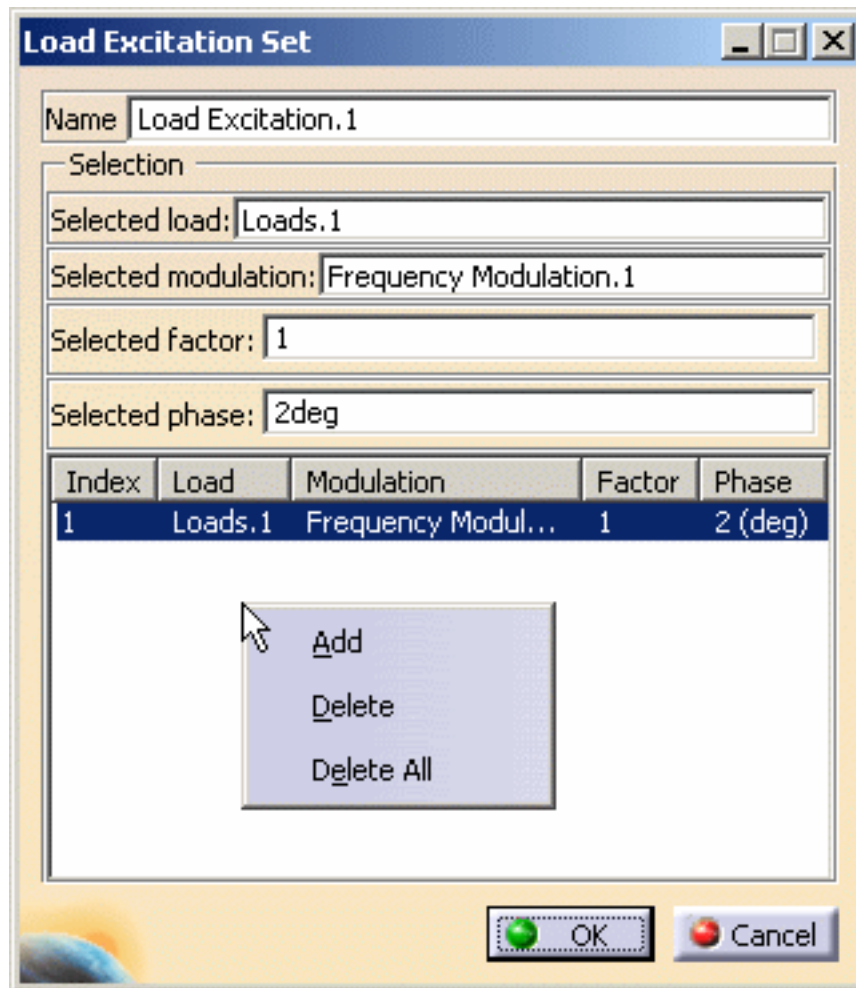

The available contextual menus are:

- **Add**: lets you add a load excitation
- **Delete**: lets you delete a load excitation
- **Delete All**: lets you delete all the load excitations you have previously defined

4. Right-click in the frame and select the **Add** contextual menu.

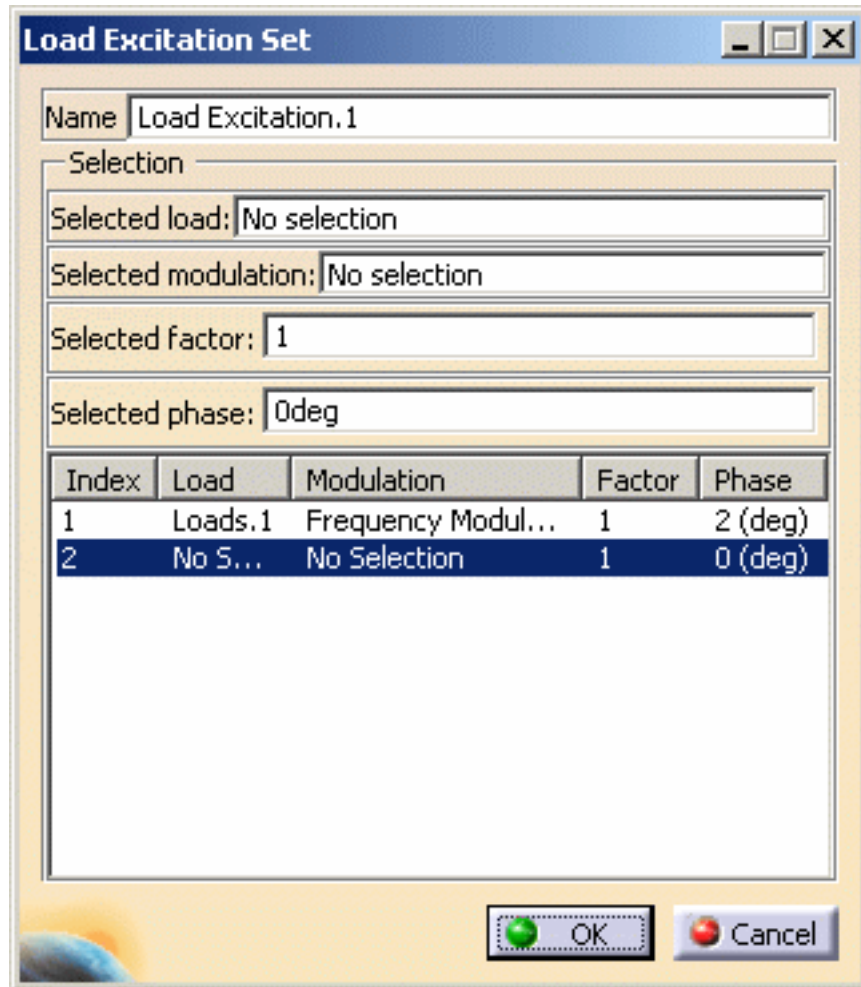

5. Select the desired load, modulation, factor and phase.

In this particular example, you can:

- select the **Loads.1** set as **Selected load**
- select the **White noise.1** as **Selected modulation**
- enter **2** as **Selected factor** value
- enter **1** as **Selected phase** value



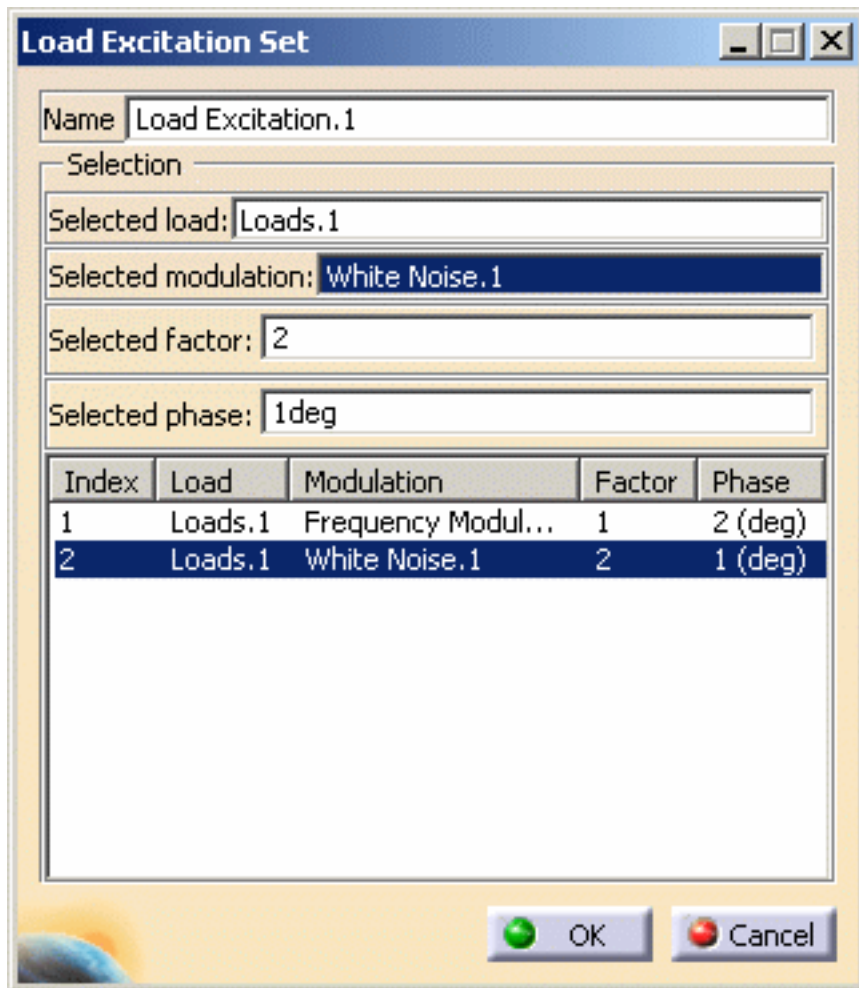

6. Right-click the second line and select the **Delete** contextual menu.
7. Click **OK** in the Load Excitation Set dialog box.



## Transient Dynamic Response Case



Open the [sample57.CATAnalysis](#) document from the samples directory.

### Before You Begin

- insert a [Transient Dynamic Response Analysis Case](#) (and choose a load excitation set)
- define a [time modulation](#)

In this particular example, a transient dynamic response case and a modulation set have been already inserted.

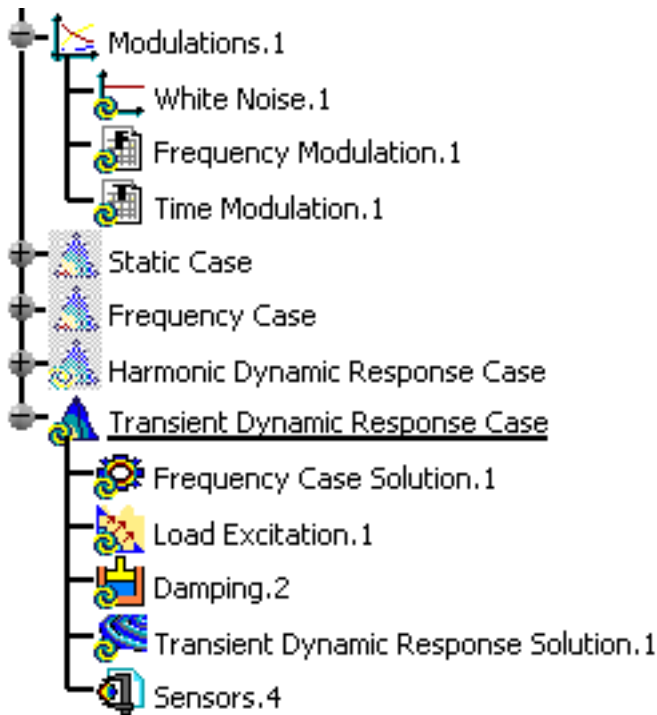

1. Double-click the load excitation set from the specification tree.

In this particular case, double-click the **Load Excitation.1** feature. The Load Excitation Set dialog box appears.

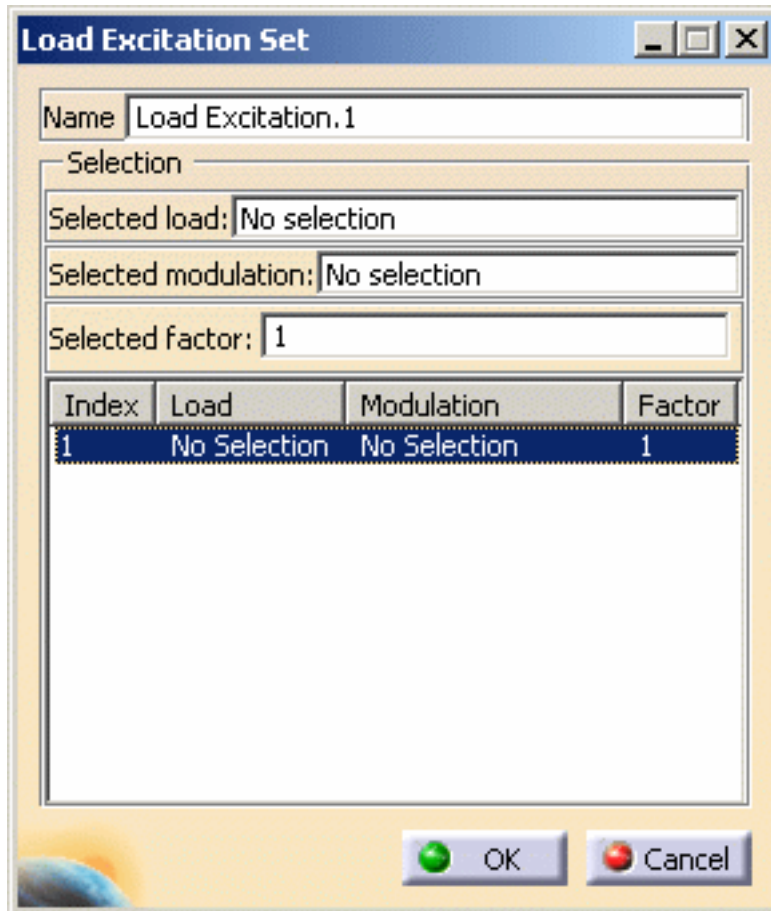

- **Name:** gives the name of the excitation set. You can modify it.
- **Selection:**
  - **Selected load:** lets you select the load you want to excite.
  - **Selected modulation:** lets you select a time modulation.
    - ⚠ You cannot select a frequency modulation.
  - **Selected factor:** lets you select the factor that will multiply the modulation.

**2.** Select the load you want to excite in the specification tree.

In this particular example, you can:

- select **Pressure.1** as **Selected load**
- select **Time Modulation.1** as **Selected modulation**
- enter **1** as **Selected factor** value

**3.** Press **Enter** to update the Load Excitation Set dialog box.

The Load Excitation Set dialog box appears as shown below:

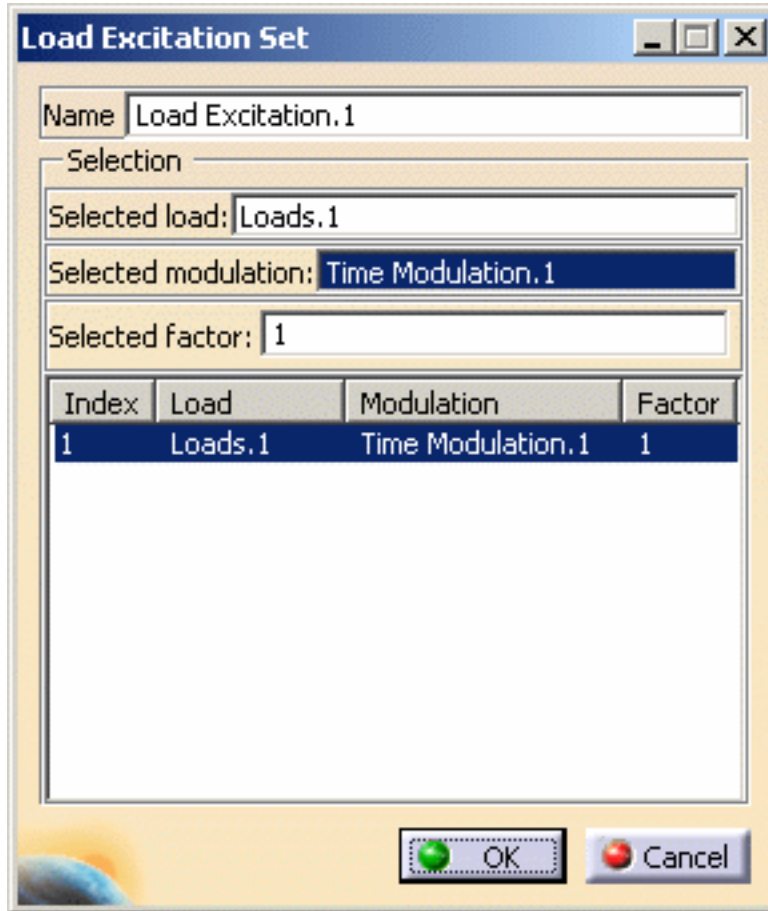

You can add or delete load excitation parameters using [contextual menus](#) in the Load Excitation Set dialog box.

4. Click **OK** in the Load Excitation Set dialog box.



# Defining a Restraint Excitation Set



This task will show you how to define the restraint excitation set in a:

- [harmonic dynamic response analysis case](#)
- [transient dynamic response analysis case](#)

Defining a restraint excitation set allows you to define an imposed motion of the support in the frequency domain or in the time domain.

## Harmonic Dynamic Response Case



Open the [sample57\\_1.CATAnalysis](#) document from the samples directory.

### Before You Begin

- insert a [Harmonic Dynamic Response Analysis Case](#) (and choose a restraint excitation set)
- define a [white noise modulation](#) or define a [frequency modulation](#)

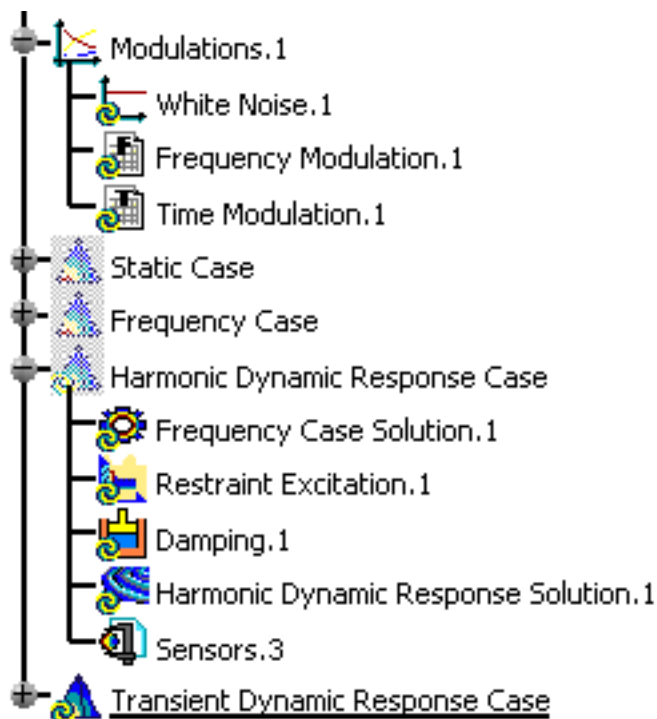



1. Double-click the restraint excitation object belonging to the harmonic dynamic response case.

In this particular case, double-click the **Restraint Excitation.1** feature.

The Restraint Excitation Set dialog box appears.

Degree	Modulation	Acceleration	Phase
TX	No Selection	1 (m_s2)	0 (deg)
TY	No Selection	1 (m_s2)	0 (deg)
TZ	No Selection	1 (m_s2)	0 (deg)
RX	No Selection	1 (rad_s2)	0 (deg)
RY	No Selection	1 (rad_s2)	0 (deg)
RZ	No Selection	1 (rad_s2)	0 (deg)

- o **Name:** gives the name of the restraint excitation set. If needed, you can modify it.
- o **Axis System:**
  - **Type:**
    - **Global:** if you select the Global Axis system, the components field will be interpreted as relative to the fixed global rectangular coordinate system.
    - **User:** if you select a User-defined Axis system, the components will be interpreted as relative to the specified rectangular coordinate system.

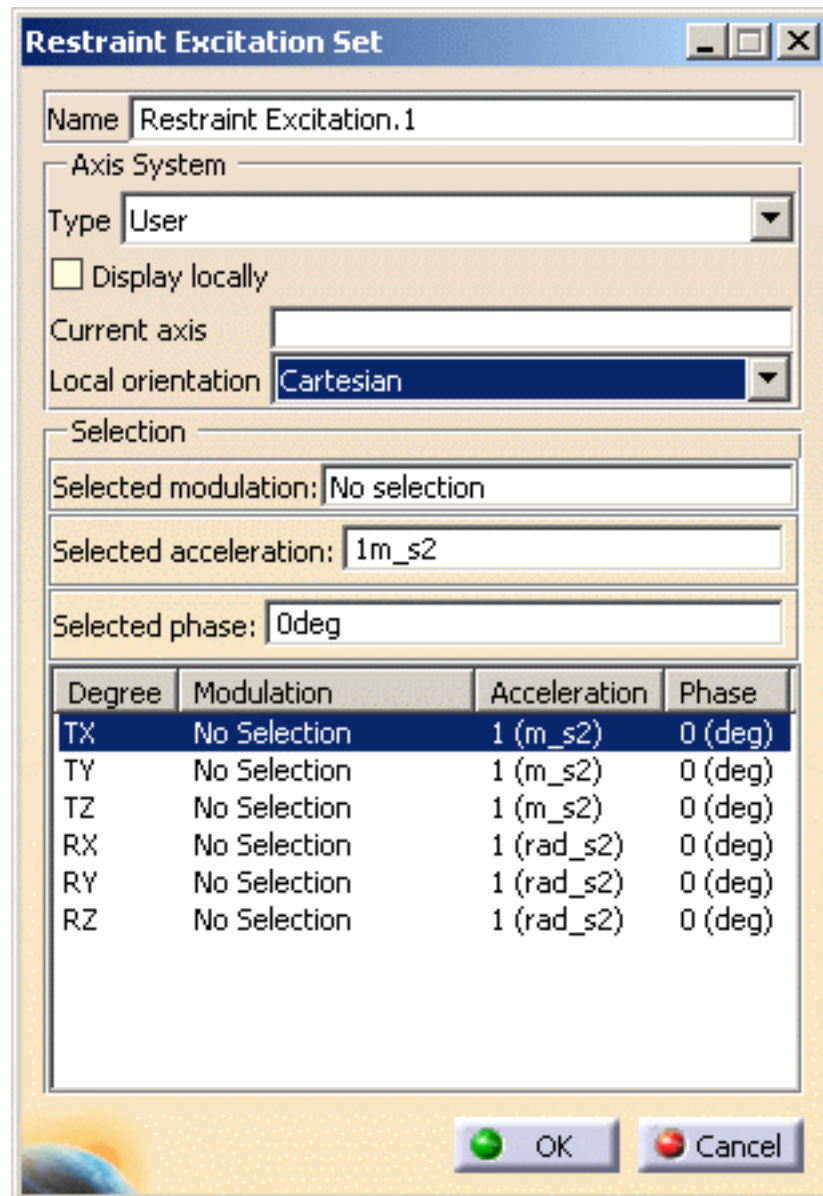

- **Current axis:** lets you select the desired axis system
  - **Local orientation: (Cartesian)** the components are interpreted as relative to a fixed rectangular coordinate system aligned with the Cartesian coordinate directions of the User-defined Axis.
- **Display locally:** lets you display the axis system locally on the geometry.
- **Selection:**
  - **Selected modulation:** lets you select a white noise modulation or a frequency modulation.
  -  You cannot select a time modulation in a harmonic dynamic response analysis case.
  - **Selected acceleration:** lets you select the acceleration that will be modulated.

- **Selected phase:** lets you specify the phase value.
  - **Degrees of freedom:** gives you the list of the degrees of freedom, the associated modulation, acceleration and phase (**T** for translation and **R** for Rotation)
- 2.** Set the desired parameters in the Restraint Excitation Set dialog box.

In this particular example, you can:

- select the **Global** option as **Axis System Type**
  - if needed, select the **Display locally** option
  - select **Frequency Modulation.1** as **Selected modulation**
  - enter **1m\_s2** as **Selected acceleration**
  - enter **1deg** as **Selected phase**
- 3.** Press **Enter** to update the Restraint Excitation Set dialog box.

The **TX** degree of freedom is defined and the Restraint Excitation Set dialog box appears as shown bellow:



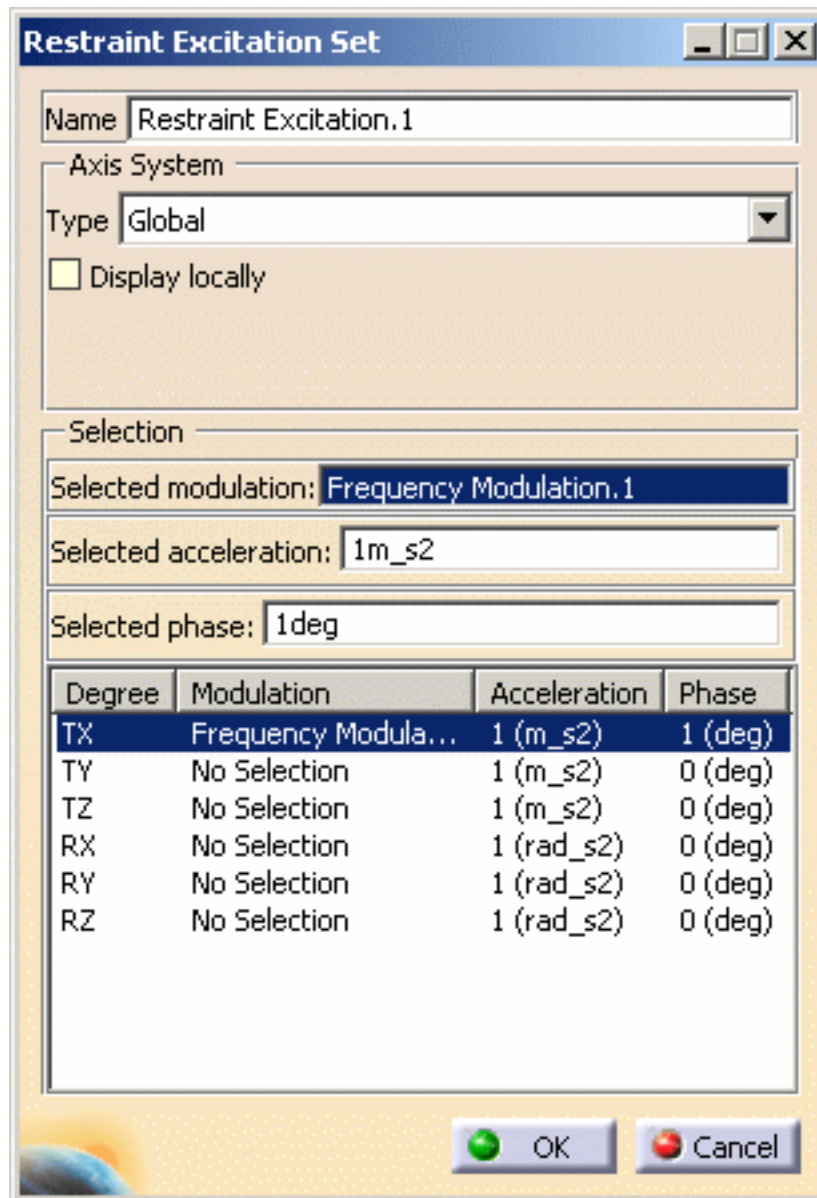

You can define other degrees of freedom.

For this:

4. Select an other degree of freedom.

In this particular example, select the **RY** degree of freedom.

5. Set the different parameters (associated modulation, acceleration and phase).

In this particular example:

- select the **White Noise.1** modulation as **Selected modulation**
- enter **3rad\_s2** as **Selected acceleration**
- enter **2deg** as **Selected phase**

6. Press **Enter** to update the Restraint Excitation Set dialog box.

The **RY** degree of freedom is defined and the Restraint Excitation Set dialog box appears as shown below:

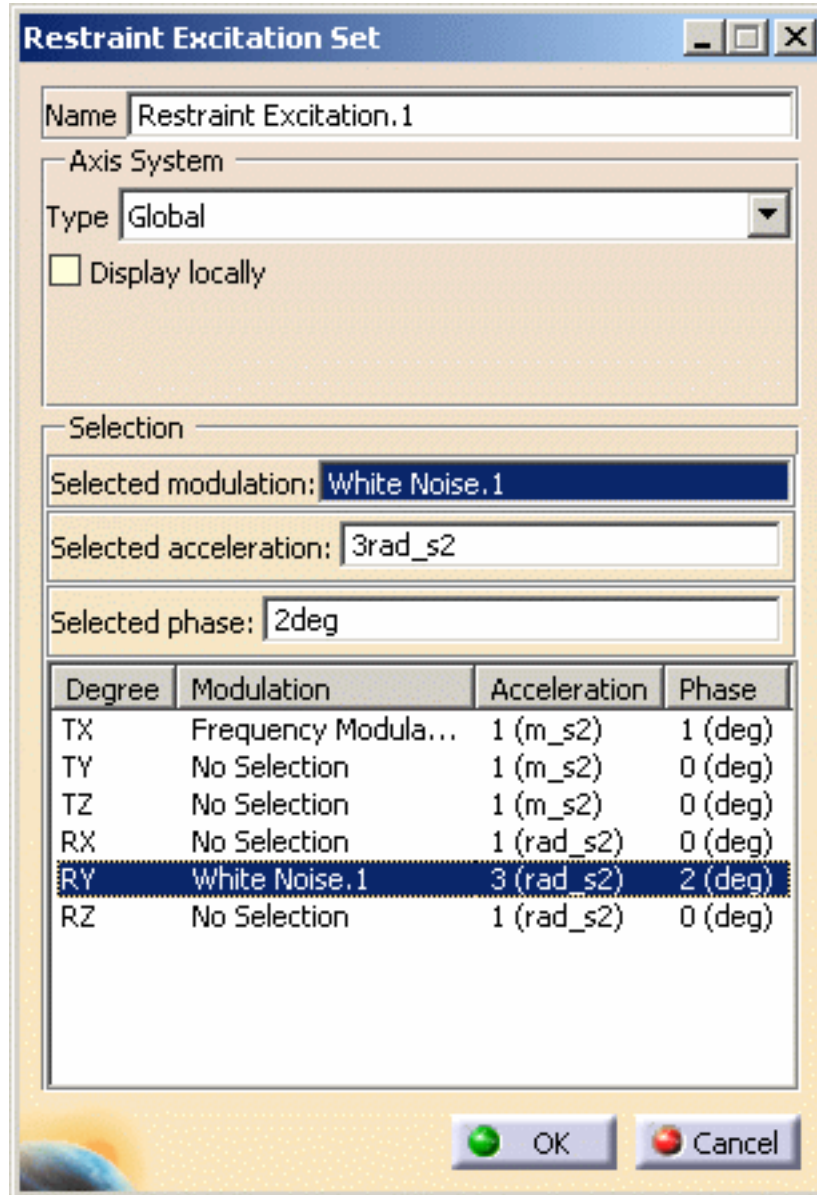

7. Click **OK** in the Restraint Excitation Set dialog box.



## Transient Dynamic Response Case



Open the [sample57\\_1.CATAnalysis](#) document from the samples directory.

### Before You Begin

- insert a [Transient Dynamic Response Analysis Case](#) (and choose a restraint excitation set)
- define a [time modulation](#)

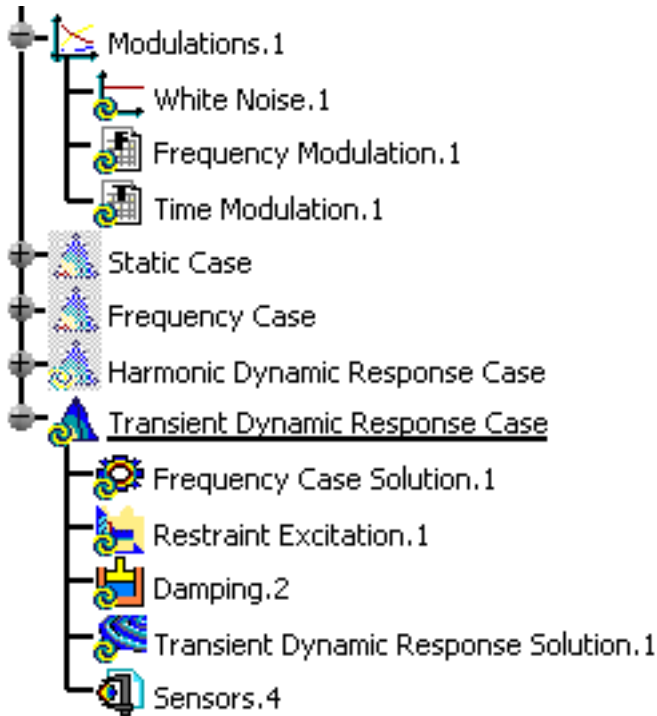

1. Double-click the restraint excitation belonging to a transient dynamic response case.

In this particular case, double-click the **Restraint Excitation.1** feature. The Restraint Excitation Set dialog box appears.

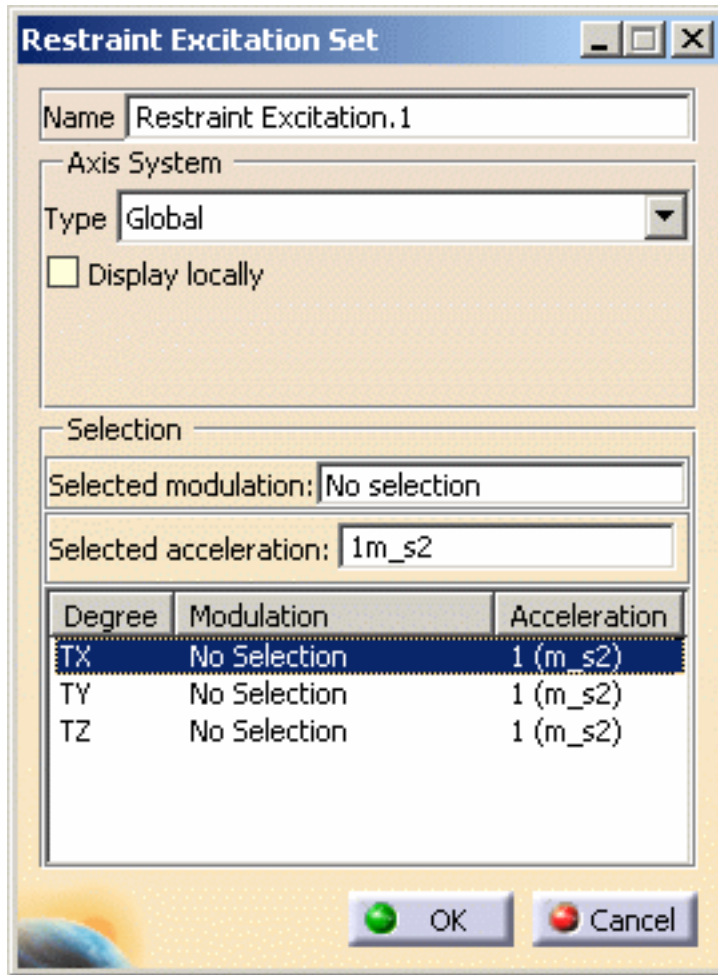

- **Name:** gives the name of the restraint excitation set. If needed, you can modify it.
- **Axis System:**
  - **Type:**
    - **Global:** if you select the Global Axis system, the components field will be interpreted as relative to the fixed global rectangular coordinate system.
    - **User:** if you select a User-defined Axis system, the components will be interpreted as relative to the specified rectangular coordinate system.

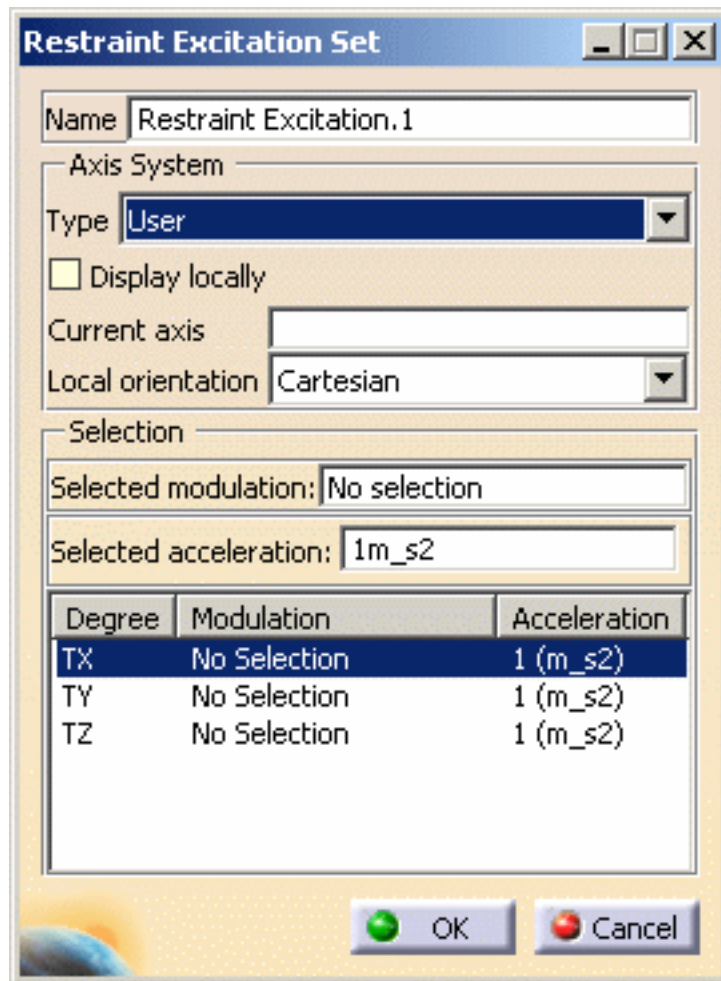

- **Current axis:** lets you select the desired axis system
- **Local orientation: (Cartesian)** the components are interpreted as relative to a fixed rectangular coordinate system aligned with the Cartesian coordinate directions of the User-defined Axis.
- **Display locally:** lets you display the axis system locally on the geometry.
- **Selection:**
  - **Selected modulation:** lets you select a time modulation.
    - ⚠ You cannot select a frequency modulation.
  - **Selected acceleration:** lets you select the acceleration that will be modulated.
- **Degrees of freedom:** gives you the list of the degrees of freedom, the associated modulation, acceleration (T for translation)

2. Set the desired parameters in the Restraint Excitation Set dialog box.

In this particular example, you can:

- select the **Global** option as **Axis System Type**
- if needed, select the **Display locally** option
- select **Time Modulation.1** as **Selected modulation**
- enter **1m\_s2** as **Selected acceleration**

**3.** Press **Enter** to update the Restraint Excitation Set dialog box.

The Restraint Excitation Set dialog box appears as shown below:

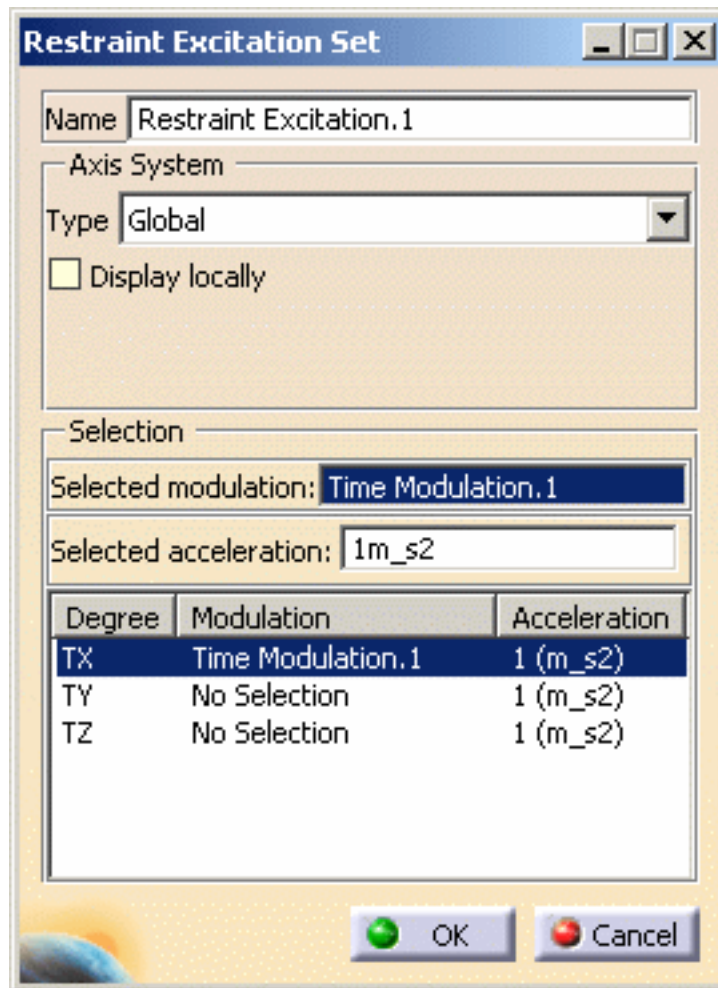

You can define other degrees of freedom.

For this:

**4.** Select an other degree of freedom.

In this particular example, select the **TY** degree of freedom.

**5.** Set the different parameters (associated modulation and acceleration).

In this particular example:

- select the **White Noise.1** modulation as **Selected modulation**
- enter **3rad\_s2** as **Selected acceleration**

**6.** Press **Enter** to update the Restraint Excitation Set dialog box.

The **TY** degree of freedom is defined and the Restraint Excitation Set dialog box appears as shown bellow:

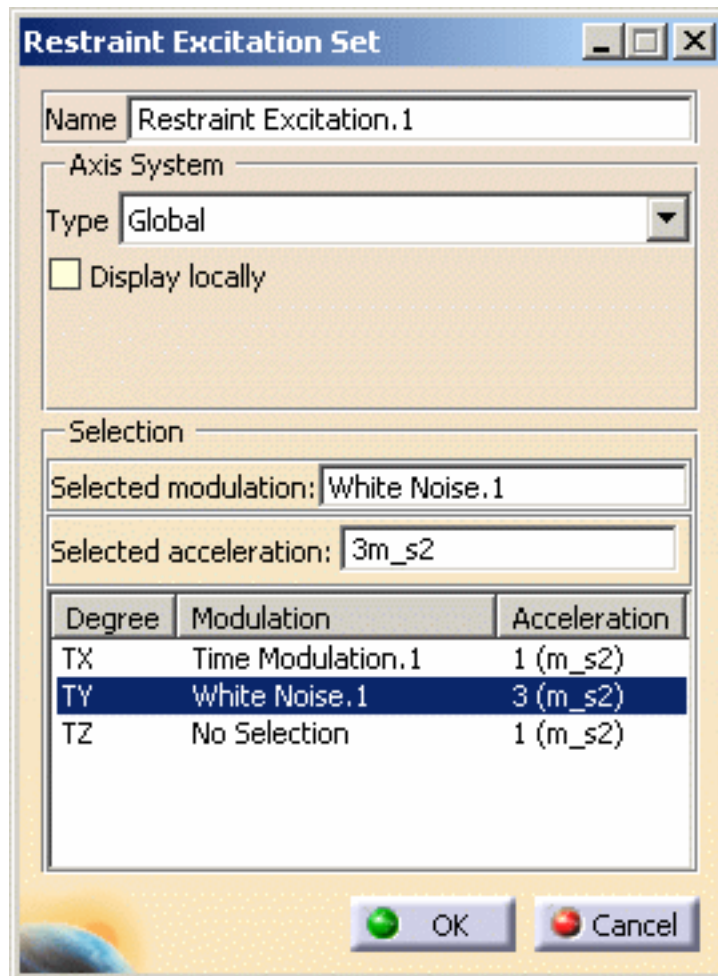

**7.** Click **OK** in the Restraint Excitation Set dialog box.



# Defining a Damping Set



This task will show you how to define the damping set in a Dynamic Response Analysis case.



Defining a *Damping Set* allows you to define the resulting damping of the part once the force has been applied to this part.

You can choose between two damping types: Modal or Rayleigh.  
By default, the damping is modal.



## Before You Begin

- insert a [Dynamic Response Analysis Case](#)
- define a [white noise excitation](#) or define an [imported modulation](#)

Open the [sample57.CATAnalysis](#) document from the samples directory.

In this particular example, a dynamic response case and a modulation set have been already inserted.

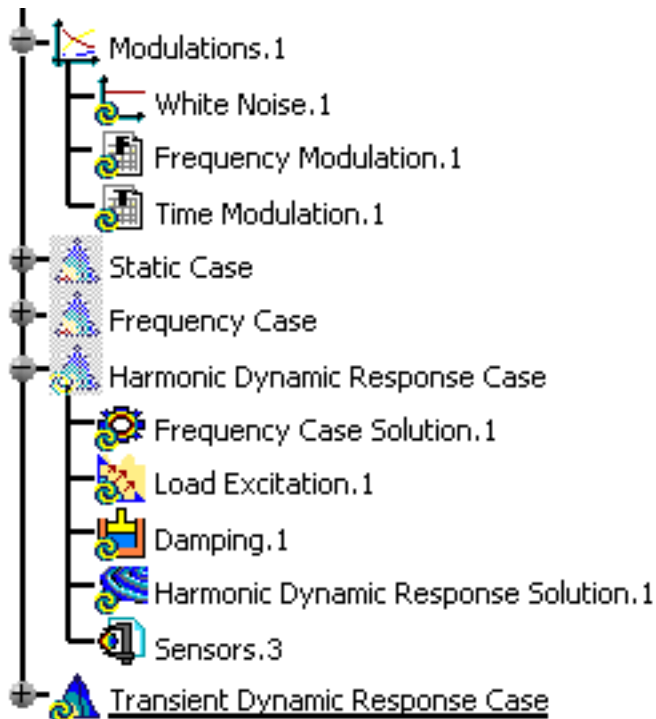





1. Double-click the damping set from the specification tree.

In this particular case, double-click the **Damping.1** object.

The Damping Choice dialog box appears.

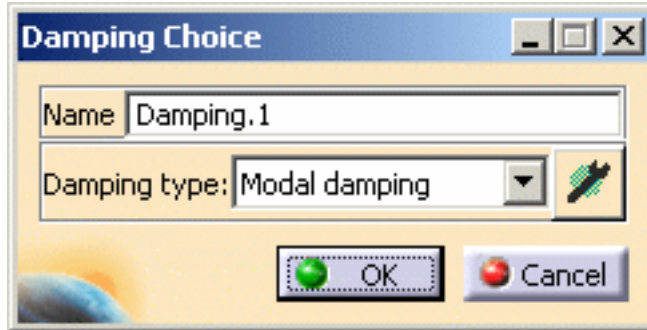

- **Name:** if needed, you can change the name of the damping set.
- **Damping type:**
  - **Modal damping**
  - **Rayleigh damping**

2. Select the desired **Damping type**.



### Modal Damping Type

The modal damping is a fraction of the critical damping.  
The critical damping is computed as follow:

$$C_r = 2\sqrt{mk}$$

where **m** is the mass of the system and **k** the stiffness of the system.



### Rayleigh Damping Type

The Rayleigh damping is defined as follow:

$$[C] = \alpha[M] + \beta[K]$$

where **[M]** is the mass matrix, **[K]** is the stiffness matrix.

3. Compute the frequency solution.

For more details, please refer to [Computing Frequency Solutions](#).



You have to compute the frequency solution before defining the damping parameters.



4. Click the Component edition button to define the damping parameters.

The Damping Definition dialog box appears.

## Modal Damping Definition

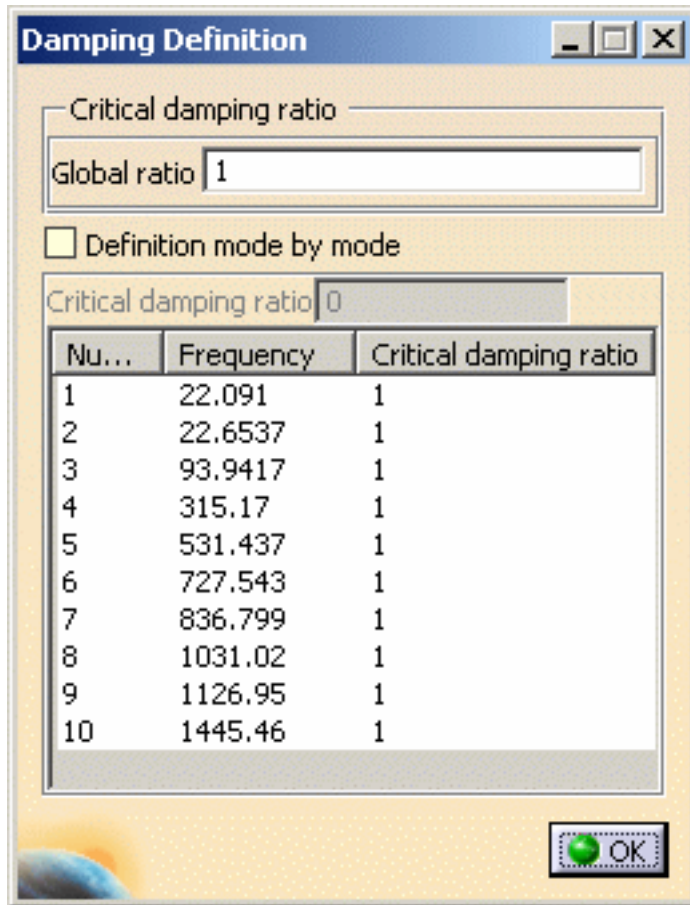

- **Global ratio:** lets you define the factor of the critical damping for all the modes (in %).
- **Definition mode by mode:** lets you define the critical damping ratio (in %) independently for each mode. Multi-selection is available in this case.

## Rayleigh Damping Definition

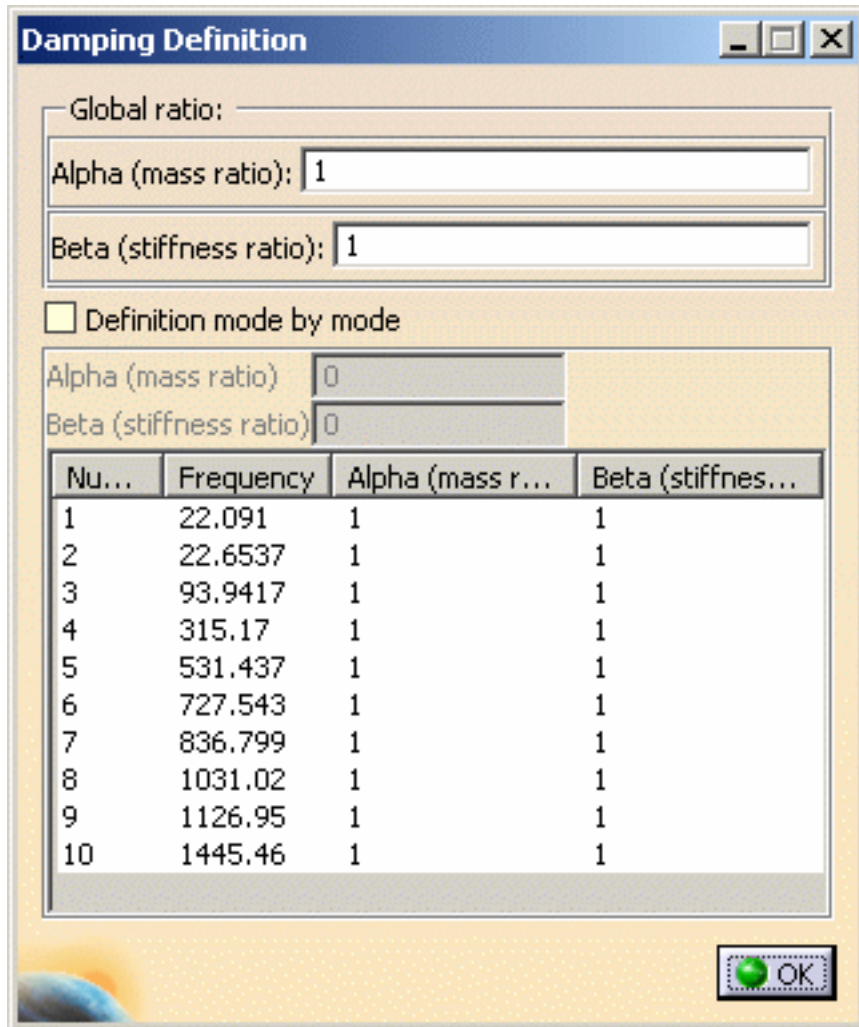

- **Global ratio:** lets you define the **Alpha (mass ratio)** and/or **Beta (stiffness ratio)** coefficients for all the modes.
    - **Alpha (mass ratio):** lets you define the factor of the mass ratio (in %).
    - **Beta (stiffness ratio):** lets you define the factor of the stiffness ratio (in %).
  - **Definition mode by mode:** lets you define the **Alpha (mass ratio)** and/or **Beta (stiffness ratio)** coefficients (in %) independently for each selected mode.  
Multi-selection is available in this case.
5. Define the desired damping parameters and click **OK** in the Damping Choice dialog box.
  6. Click **OK** in the Damping Definition dialog box.



# Model Manager

## Mesh Creation



### Create 3D Mesh Part

Delete and/or add OCTREE tetrahedron mesh



### Create 2D Mesh Part

Delete and/or add OCTREE triangle mesh



### Create 1D Mesh Part

Create beam mesher

## Element Type



### Create Local Mesh Sizes

Generate local element sizes.



### Element Type

Specify the element type.



### Create Local Mesh Sags

Generate local element sags.

## Mesh Property Creation



### Create 3D Property

Create 3D properties.



### Create 2D Property

Create 2D properties globally and, if needed, locally.



### Import Composite Property

Import composite property.



### Create 1D Property

Create 1D properties globally and, if needed, locally.



### Create Imported Beam Property

Create beam properties globally and, if needed, locally.

### Changing Element Type

Change the type of 1D or 2D element.



### Creating a User Material

Create an analysis material without specifying a geometrical support.

### Modifying Material Physical Properties

Modify the physical properties of a material.

### Editing a User Isotropic Material

Edit a user isotropic material that has been created in the previous releases.

## Mesh Check



### Check the Model

Check whether mesh part, properties and material were properly applied. Check can be performed on bodies, connection and/or others (specifications).

# Creating 3D Mesh Parts



This task shows you how to add 3D mesh part.



*3D mesh* can be deleted and/or added to parts manually.



Open the [sample39.CATAnalysis](#) document from the samples directory.

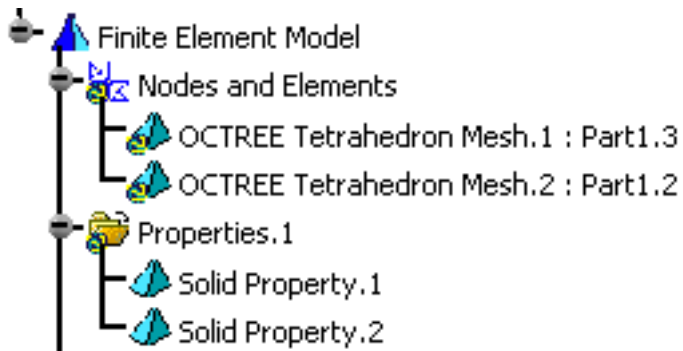
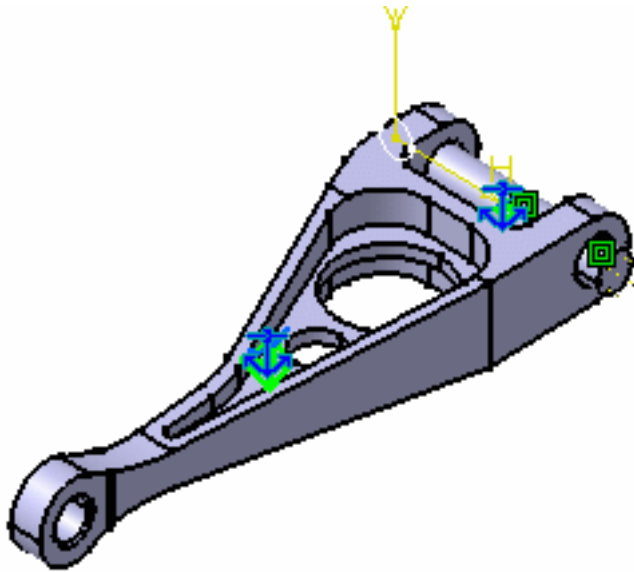



**1. Delete OCTREE Tetrahedron Mesh.2: Part1.2.**

For this, right-click on the feature in the specification tree and select the **Delete** option from the displayed contextual menu.

The specification tree appears as shown here:

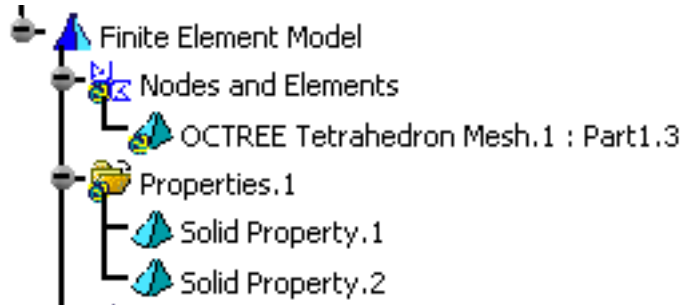

**2. Click the Octree Tetrahedron Mesher icon .**

**3. Select the part you want to assign a new Mesh part. In this particular case, select PartBody.**

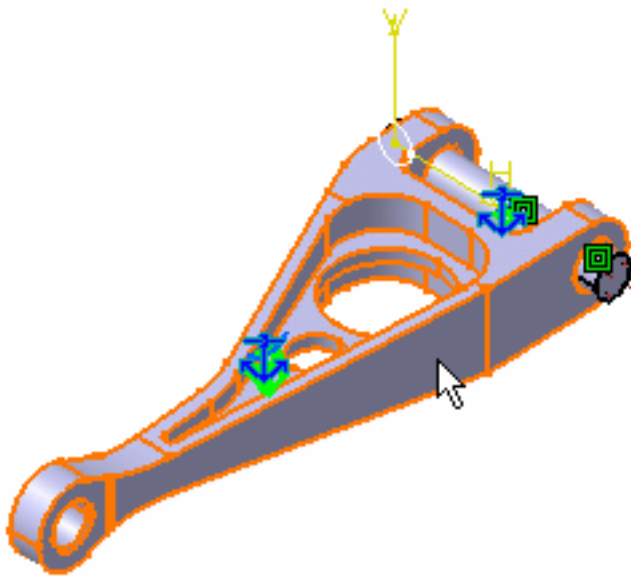

The OCTREE Tetrahedron Mesh dialog box appears.

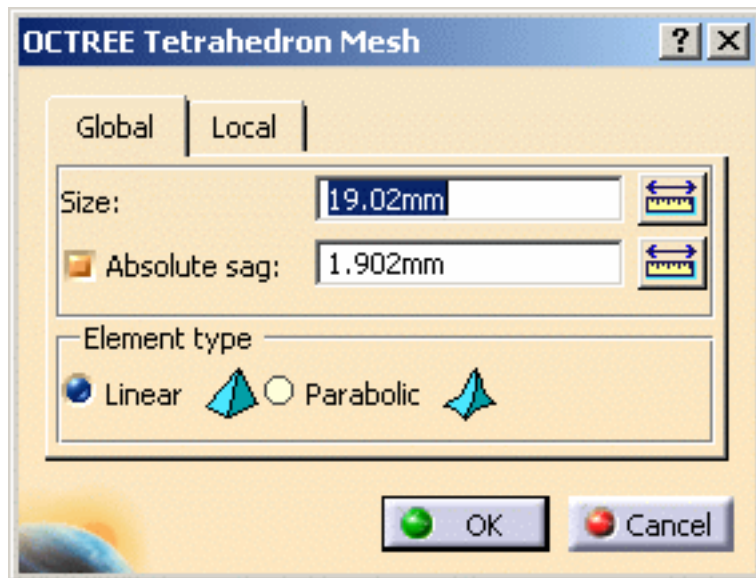

**Global tab:** change global parameters

- **Size**
- **Absolute sag**
- **Element type**
  - **Linear**
  - **Parabolic**

**Local tab:** create local parameters

- **Local size**
- **Local sag**
- **Imposed points**

4. Enter the desired options in the OCTREE Tetrahedron Mesh dialog box. In this case, change the **Size** to **24mm**.



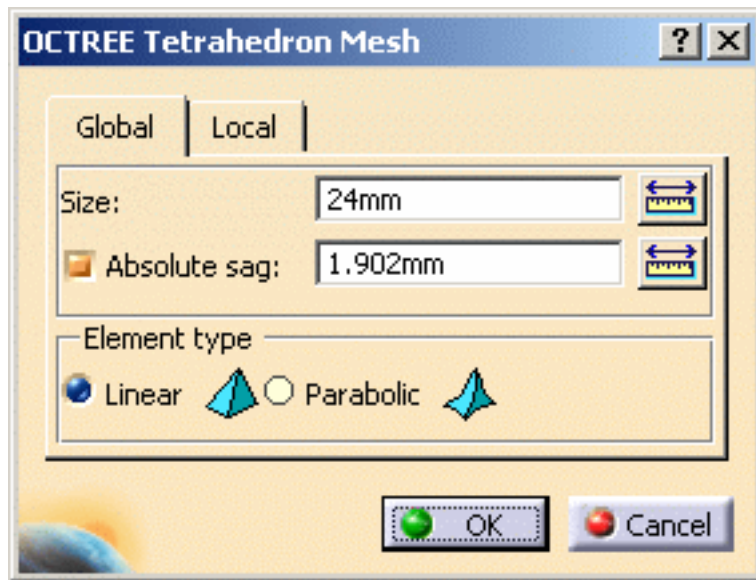

5. Click **OK** in the OCTREE Tetrahedron Mesh dialog box.

The new mesh has been created manually and the specification tree is updated.

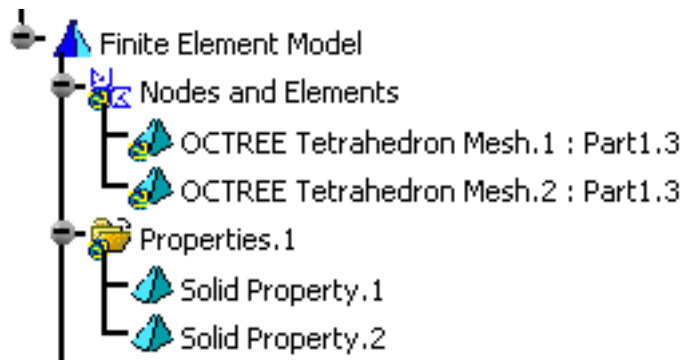

To know more about the Element Type you have to choose in the OCTREE Tetrahedron Mesh dialog box, see [Linear Tetrahedron](#) and [Parabolic Tetrahedron](#) in the *Finite Element Reference Guide*.



# Creating 2D Mesh Parts



This task shows you how to add 2D mesh part.



*2D mesh* can be deleted and/or added to parts manually.



Open the [sample40.CATAnalysis](#) document from the samples directory.

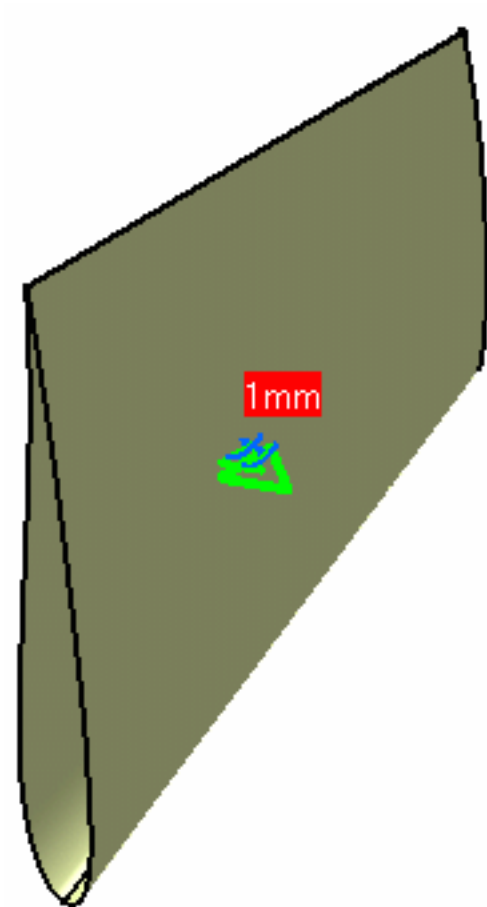



1. Click the **Octree Triangle Mesher** icon .
2. Select the 2D element.

The OCTREE Triangle Mesh dialog box appears.

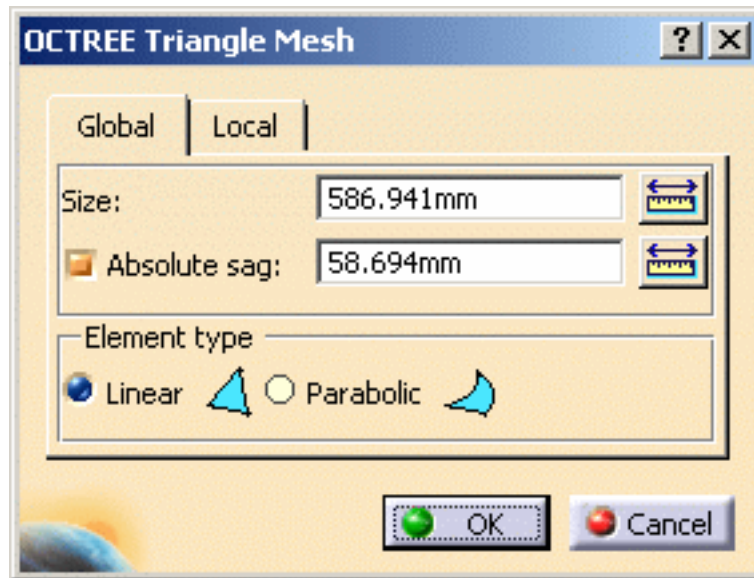

**Global** tab: change global parameters

- **Size**
- **Absolute sag**
- **Element type**
  - **Linear**
  - **Parabolic**



To know more about the **Element Type** you have to choose in the OCTREE Tetrahedron Mesh dialog box, please refer to [Linear Triangle](#) and [Parabolic Triangle](#) in the *Finite Element Reference Guide*.

**Local** tab: create local parameters

- **Local size**
- **Local sag**
- **Imposed points**

3. If needed, modify the option in the OCTREE Triangle Mesh dialog box. In this particular case, keep the default options.

4. Click **OK** in the OCTREE Triangle Mesh dialog box.

The **OCTREE Triangle Mesh.2** feature now appears in the specification tree.

Note that now the corresponding 2D Property is missing. For more details on how to add this missing 2D property, see task called [Creating 2D Property](#).

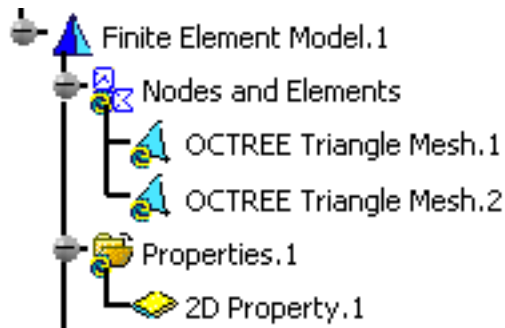

You can change the physical property of 2D mesh element you just created using the [Changing Element Type](#) contextual menu.



At any time, you can delete the Mesh feature. For this, right-click on the feature in the specification tree and select the **Delete** contextual menu.



# Creating 1D Mesh Parts



This task shows you how to add beam mesh to a *Generative Shape Design* CATPart.



- You cannot select a sketch geometry.
- You cannot mesh 1D body belonging to hybrid body.



Open the [sample47.CATAnalysis](#) document from the sample directory.



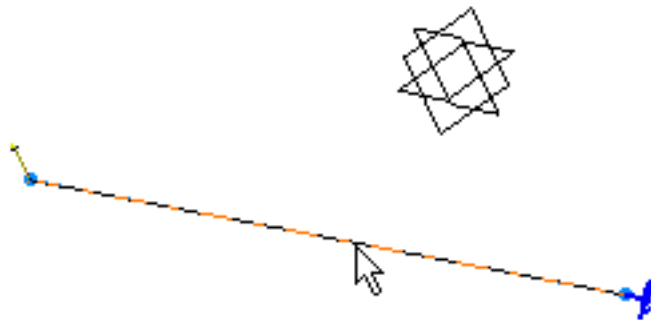

1. Click the **Beam Mesher** icon .
2. Select the beam to be meshed.



The Beam Meshing dialog box appears.



- **Element Type:** lets you choose the 1D element type:
  -  (linear): 1D element without intermediate node. By default, this element is a beam but you can work with linear bar element using the [Change Element Type](#) contextual menu. For more details about these elements, please refer to [Beam](#) and [Linear Bar](#) in the *Finite Element Reference Guide*.
  -  (parabolic): 1D element with an intermediate node. This element can only be a parabolic bar. For more details about this element, please refer to [Parabolic Bar](#) in the *Finite Element Reference Guide*.
- **Element size:** lets you specify the element size.
- **Sag control:**
  - **Sag:** lets you define the distance between the mesh elements and the geometry.
  - **Min size:** lets you define the minimum element size.

**3. Select the desired **Element Type**.**

In this particular example, select linear by clicking the  button.

**4. Enter the desired **Element size** value in the Beam Meshing dialog box.**

In this particular case, enter **3mm**.

**5. Activate the **Sag control** option in the Beam Meshing dialog box.**

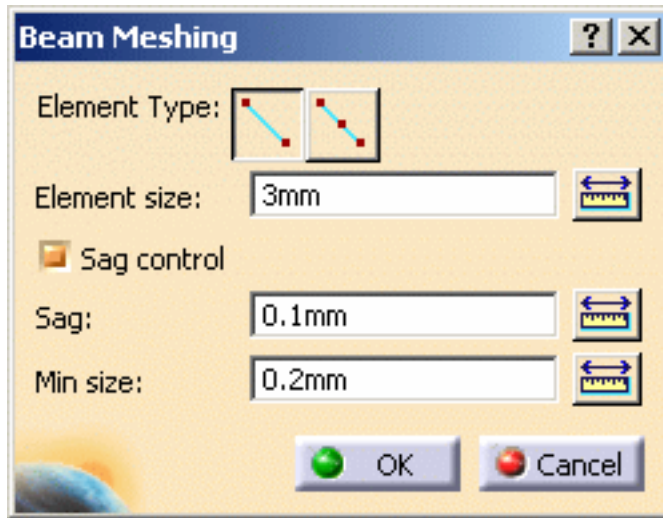

6. Modify the **Sag control** parameters if needed.
7. Click **OK** in the Beam Meshing dialog box.

The **1D Mesh.1** feature now appears in the specification tree. Note that now the corresponding Beam Property is missing.

For more details on how to add this Beam Property, see task called [Creating Beam Property](#).

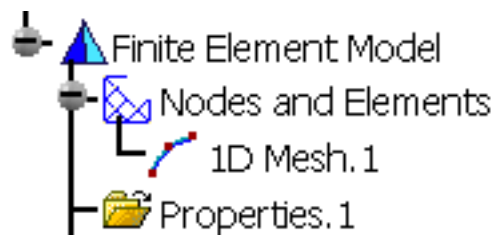

- To apply a restraint, a load or a connection to one extremity of a beam, you need to first put the point that were possibly created at the extremity of this beam, in order to build the wireframe, into the **Hide** mode. As result, to apply the above mentioned specifications, you will select the extremity of the wireframe and not the hidden point (small cross in the 3D view) as this point is not linked to the mesh.
- You cannot apply beam properties and 1D mesh parts on geometry included in a sketch.



*1D or beam mesh* can be deleted and/or added to parts manually.



# Creating Local Mesh Sizes



This task will show you how to create a Local Mesh Size specification on a Mesh Part and how to specify element type.



The *Mesh Part* objects set contains all user specifications relative to the Mesh. In particular, global size and sag specifications, as well as global element order specifications.

*Local Mesh Sizes* are local specifications relative to the size of the elements constituting the finite element mesh.



You can use the [sample00.CATAnalysis](#) document from the samples directory for this task.

## Before You Begin

Go to **View -> Render Style -> Customize View** and make sure the **Shading, Outlines** and **Materials** options are active in the Custom View Modes dialog box.



1. Click the **Local Mesh Size** icon .

The Local Mesh Size dialog box is displayed.

In the case of an assembly, you will select from the specification tree the Mesh object which you want to modify the size (**Nodes and Elements** feature).

You can change the name of the Local Size by editing the **Name** field.



2. Enter an element size in the **Value** field.



You can use the ruler button on the right of the field to enter a distance between two supports by selecting them in sequence.

The smallest element size which can be used to generate a mesh is **0.1mm**. In order to avoid geometrical problems in the mesher, the smallest size of an element is set to 100 times the geometrical model tolerance. This tolerance is actually set to **0.001mm** and cannot be modified whatever the dimension of the part. This is why the mesh global size must be bigger than **0.1mm**.

3. Select a geometry for applying a local size.

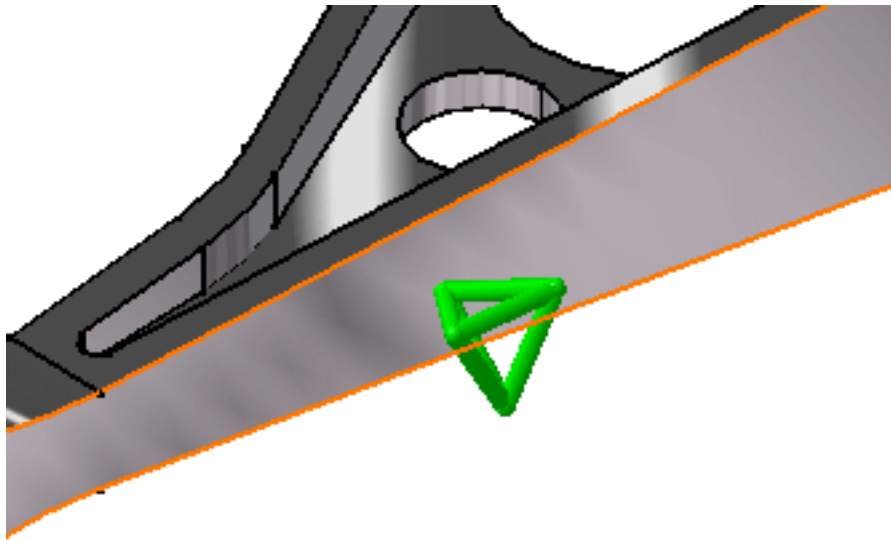

4. Click **OK** to create the Local Size.

A symbol representing the Local Size is visualized on the support.

A Local Size object appears in the specification tree under the active Mesh Part objects set.

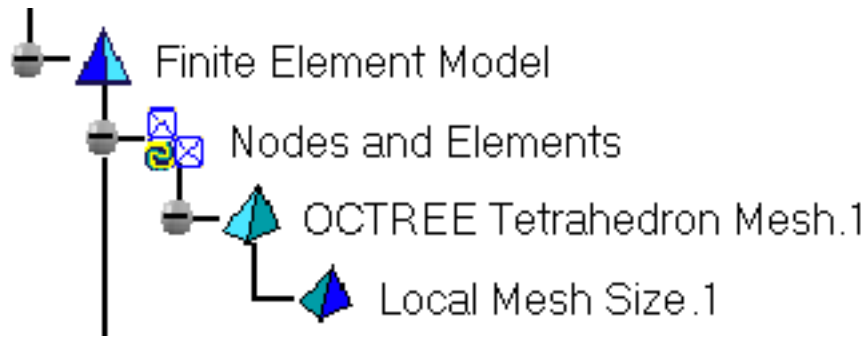

- You can select several geometry supports to apply the Local Size to all simultaneously.
- To edit the Mesh Part objects set, simply right-click on the Mesh Part objects set (key 3) and select **.object -> Definition**, or double-click the Mesh Part symbol.

## Element Type

You can specify the element type.

For this, click the **Element Type** icon  from the **Model Manager** toolbar.

The Element Type dialog box lets you modify the type of the element.

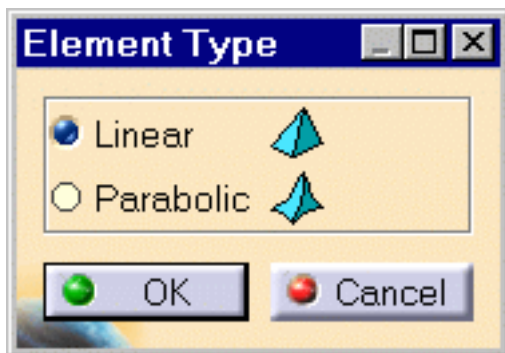

To know more about the Element Type you have to choose in the OCTREE Tetrahedron Mesh dialog box, see [Linear Tetrahedron](#) and [Parabolic Tetrahedron](#) in the *Finite Element Reference Guide*.

# Edit the Tetrahedron Mesh Specifications

You can edit the Tetrahedron Mesh specifications.

For this, double-click the **OCTREE Tetrahedron Mesh.1** feature in the specification tree.

The OCTREE Tetrahedron Mesh dialog box appears.

**Global** tab:

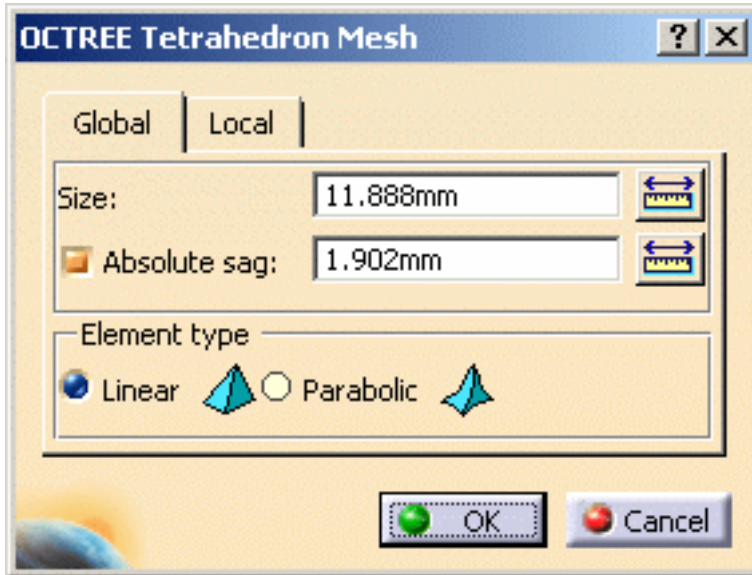

- **Size**
- **Absolute sag**
- **Element type**
  - **Linear**
  - **Parabolic**

**Local** tab:



- **Local size**
- **Local sag**
- **Imposed points**

The local size actions described above are all accessible in this alternate way, by setting the specification and pressing the **Add** button.

You can apply in sequence several Local Size specifications to the system. A separate object will be created for each specification in the specification tree.



# Creating Local Mesh Sags



This task shows how to create a Local Mesh Sag specification on a Mesh Part.



The *Mesh Part* objects set contains all user specifications relative to the Mesh. In particular, global size and sag specifications, as well as global element order specifications.

*Local Mesh Sags* are local specifications relative to the maximum distance between the element boundaries and the boundary of the system.



You can use the [sample00.CATAnalysis](#) document from the samples directory for this task.

## Before You Begin

Go to **View -> Render Style -> Customize View** and make sure the **Shading, Outlines** and **Materials** options are active in the Custom View Modes dialog box.



1. Click the **Local Mesh Sag** icon .

The Local Mesh Sag dialog box appears.

In the case of an assembly, you will select from the specification tree the Mesh object of which you want to modify the sag (**Nodes and Elements** feature).



You can change the name of the Local Sag by editing the **Name** field.

2. Enter an element sag in the **Value** field.

You can use the ruler button on the right of the field to enter a distance between two supports by selecting them in sequence.

3. Select a geometry for applying a local sag.

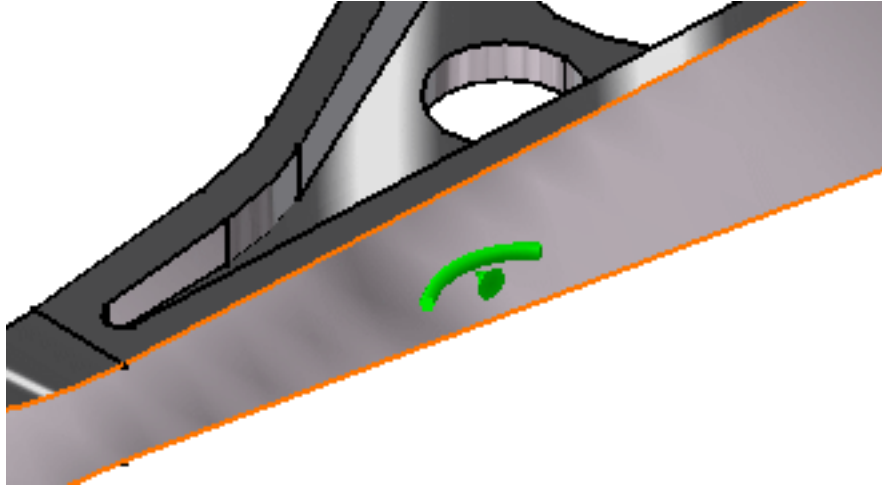

4. Click **OK** to create the Local Sag.

A symbol representing the Local Sag is visualized on the support.

A Local Sag object appears in the features tree under the active Mesh Part objects set.

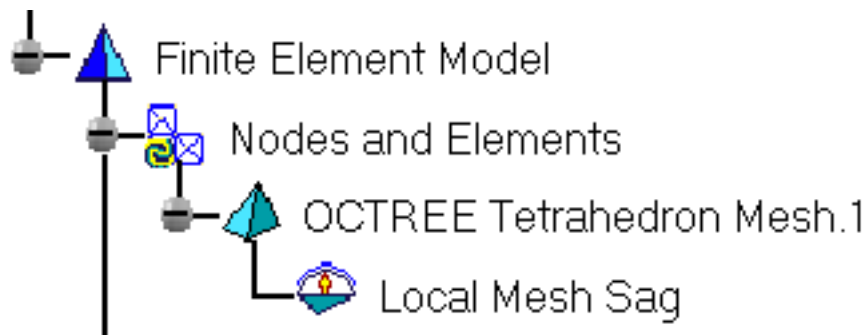

- You can select several geometry supports to apply the Local Sag to all simultaneously.
- To edit the Mesh Part objects set, simply right-click on the Mesh Part objects set and select **.object -> Definition**, or double-click the Mesh Part symbol in the features tree.
- To edit the global and local characteristics of the OCTREE tetrahedron mesh, simply right-click on the **OCTREE Tetrahedron Mesh.1** feature and select **.object -> Definition**, or double-click the **OCTREE Tetrahedron Mesh.1** feature in the specification tree.  
The OCTREE Tetrahedron Mesh dialog box appears.

You can edit the following global characteristics in the **Global** tab of the dialog box:

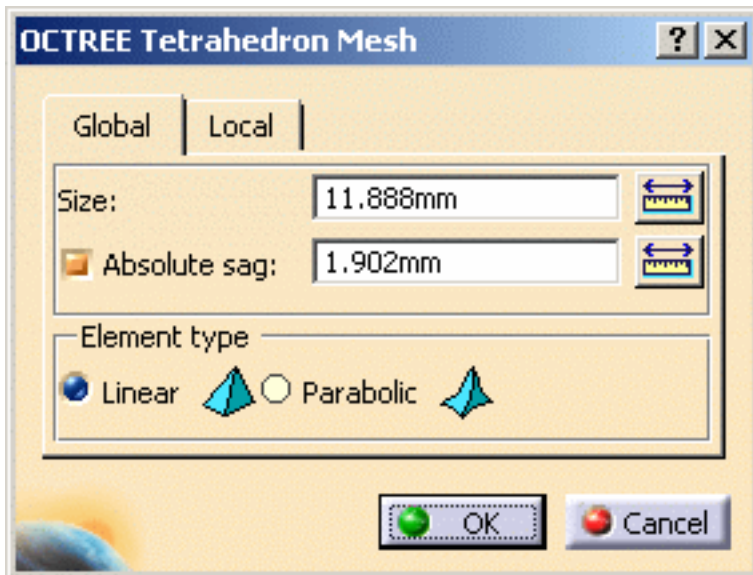

- **Size**
- **Absolute sag**
- **Element type**
  - **Linear**
  - **Parabolic**

You can further edit the following local characteristics by pressing the **Local** tab of the dialog box:

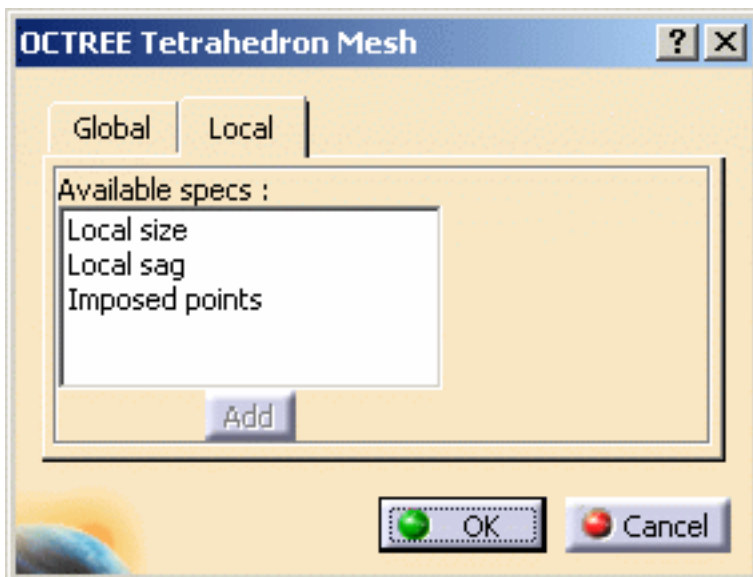

- **Local size**
- **Local sag**
- **Imposed points**

The local sag actions described above are all accessible in this alternate way, by setting the specification and pressing the **Add** button.

You can apply in sequence several Local Sag specifications to the system. A separate object will be created for each specification in the features tree.



To know more about the Element Type you have to choose in the OCTREE Tetrahedron Mesh dialog box, see [Linear Tetrahedron](#) and [Parabolic Tetrahedron](#) in the *Finite Element Reference Guide*.





# Creating 3D Properties



This task shows you how to add 3D physical properties to a body, on the condition a mesh part was previously created.



A 3D property is a physical property assigned to a 3D part. A solid property references a material assigned to this 3D part. A solid property is associative to the geometry this property points at.

To know more about this property, see [Solid Property](#) in the *Finite Element Reference Guide*.



Open the [sample41.CATAnalysis](#) document from the samples directory.

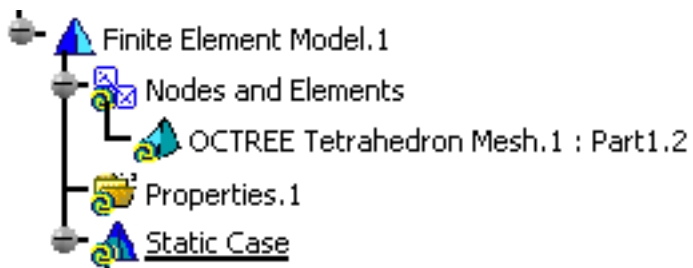
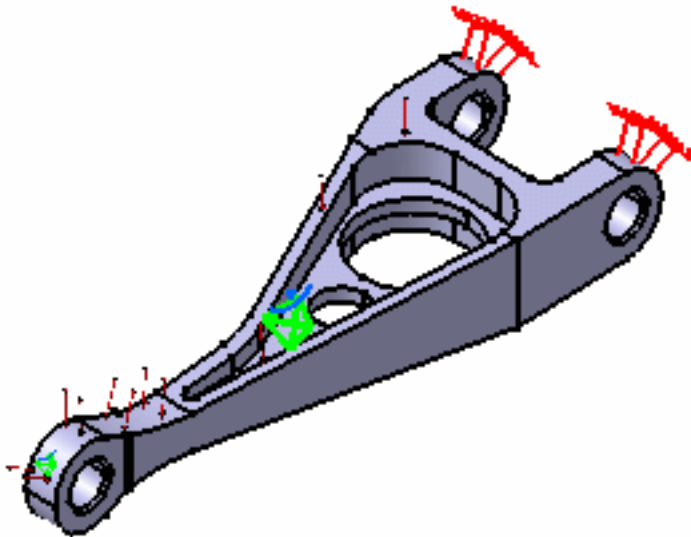



1. Click the **3D Property** icon .

The **3D Property** dialog box appears.

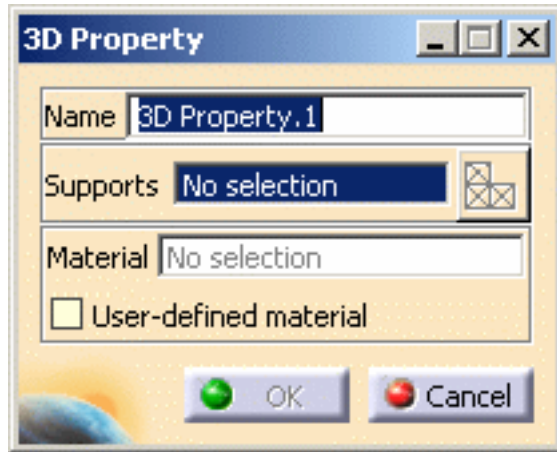

- **Name:** lets you change the name of the property.
- **Support:** lets you select a support.
- **Select Mesh Parts:** this button is only available if you have selected a support.
- **Material:** indicates that a material has been applied on the selected support.
- **User-defined material:** lets you select an user isotropic material on condition that it has been previously created.

For more details, please refer [Creating an User Material](#).

2. Select the part to be applied a 3D property.

The **3D Property** dialog box now appears as shown here:

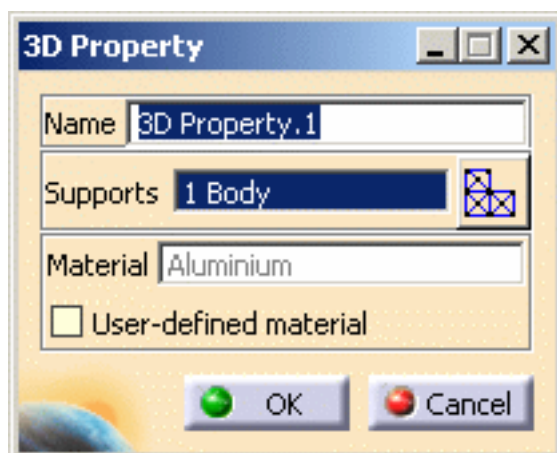

3. Click **OK** in the 3D Property dialog box.

The 3D property is created.

The specification tree is updated: the **3D Property.1** feature is displayed.

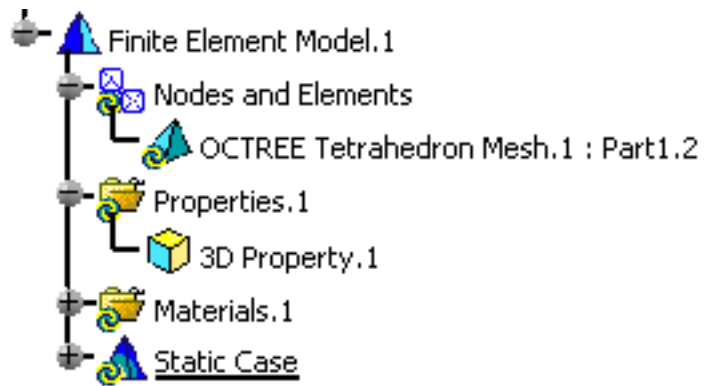

 You can manually add and delete 3D properties.



# Creating 2D Properties



This task shows you how to:

- [add 2D physical properties to a modified product](#)
- [create local 2D properties](#) (on the condition a shell property was previously added to the part)



A 2D property is a physical property assigned to a surface part. A 2D property references a material assigned to the surface Part and describes a thickness associated to this surface Part. A 2D property is associative to the geometry this property points at. You can also associate a local thickness to a piece of the geometry.

To know more about this property, see [Shell Property](#) in the *Finite Element Reference Guide*.



Open the [sample51.CATAnalysis](#) document.

In this particular case, a mesh part has been previously created.

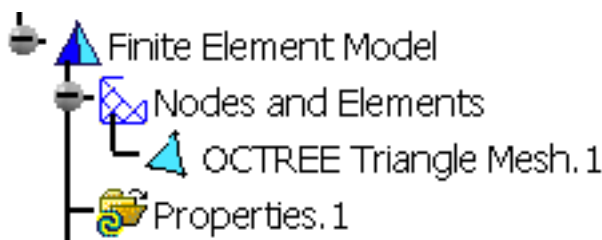
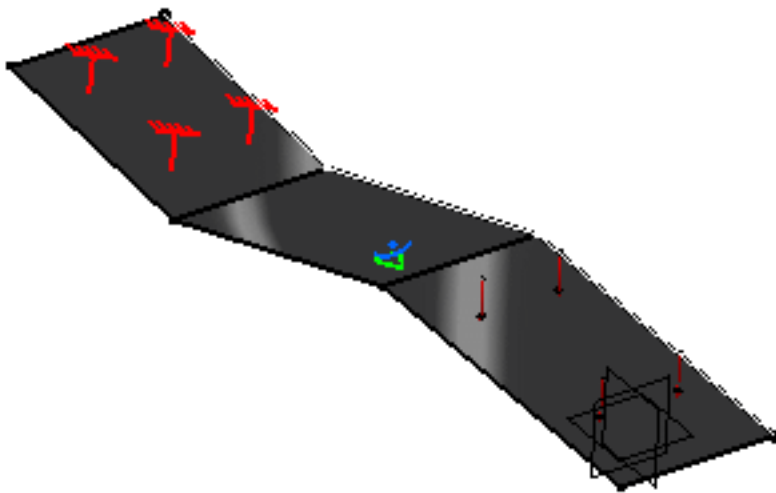

## Before You Begin:

Be aware that the default thickness corresponds to the thickness that was possibly previously defined in Generative Shape Design workbench (**Tools->Thin Parts Attributes** option in the menu bar). Associativity exists between the thickness of the part and the corresponding

CATAnalysis shell property. Of course, you can modify this thickness as necessary using Analysis workbench, afterwards.

## Add 2D Physical Properties

You can add 2D physical properties to a body.



1. Click the **2D Property** icon .

The 2D Property dialog box appears.

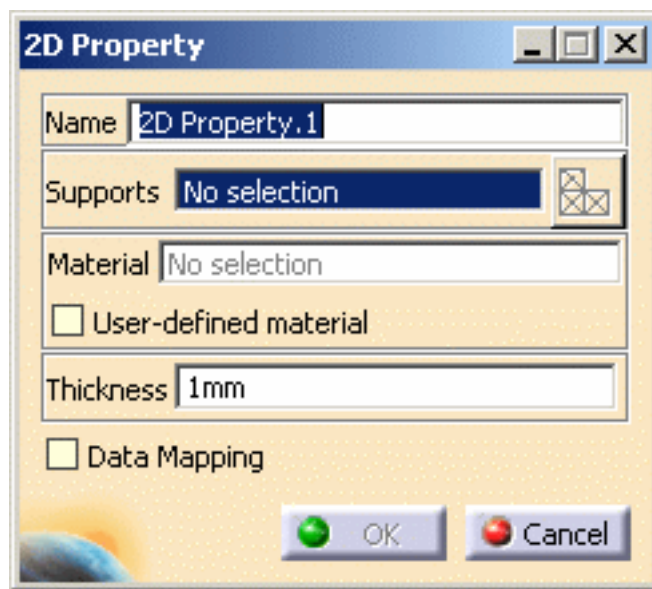

- **Name:** lets you modify the name of the property
- **Supports:** lets you select a support
- **Select Mesh Parts:** this button is only available if you have selected a support
- **Material:** indicates you that a material has been applied on the selected support
- **User-defined material:** lets you select an user isotropic material on condition that it has been previously created

For more details, please refer [Creating an User Material..](#)

- **Thickness:** lets you change the value of the thickness
- **Data Mapping**



You can re-use data (**Data Mapping**) that are external from this version (experimental data or data coming from in-house codes or procedures). For more details, see [Data Mapping](#) (only available if you installed the **ELFINI Structural Analysis (EST)** product).

2. Select the support to be applied a 2D property.

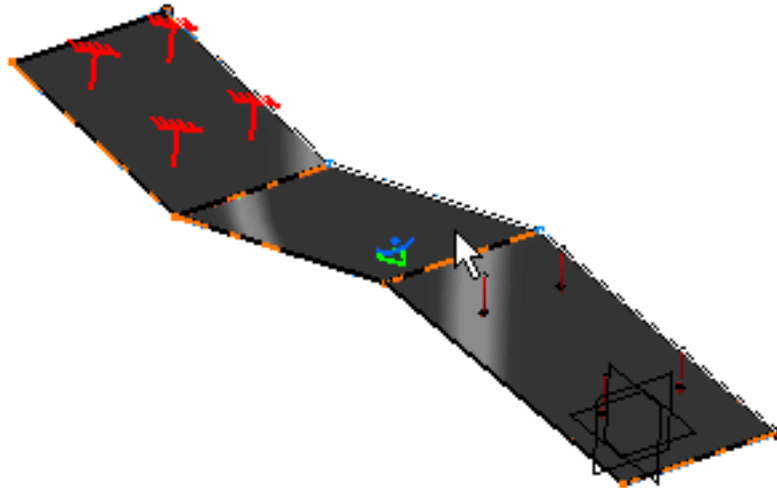

The 2D Property dialog box is updated as shown here:

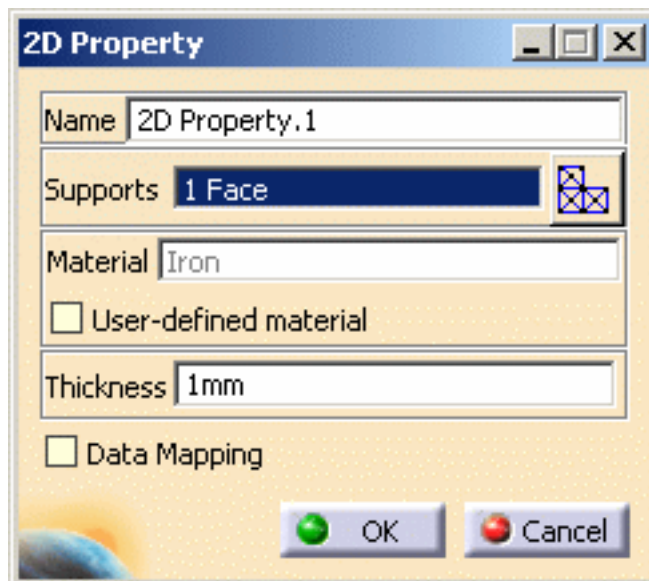

3. Enter **2mm** as **Thickness** value.
4. Click **OK** in the 2D Property dialog box.

The 2D Property is created and a symbol appears on the geometry:

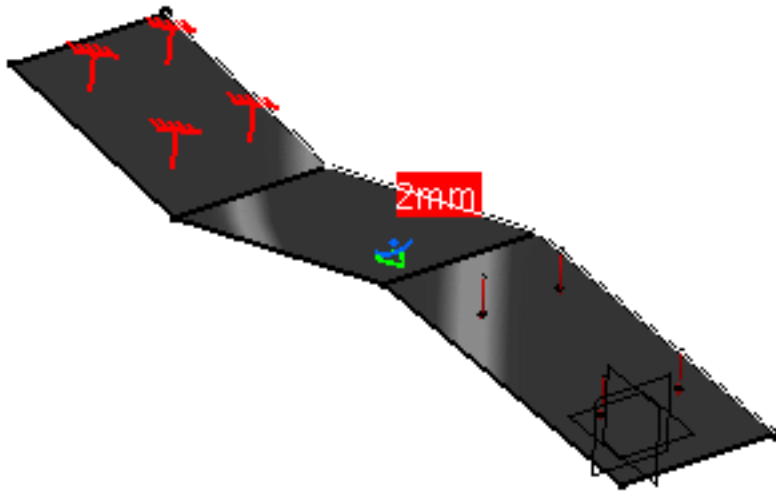

A **2D Property.1** feature appears in the specification tree:

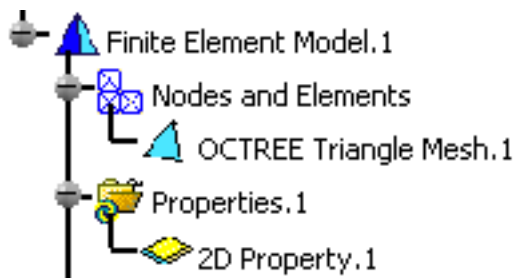

## Create Local 2D Property

You can associate a local thickness to a piece of the geometry.



This functionality is only available if you installed the **ELFINI Structural Analysis (EST)** product.



1. Right-click the **2D Property.1** feature previously created in the specification tree and select the **Local 2D Property** contextual menu .

The Local 2D Property dialog box appears.

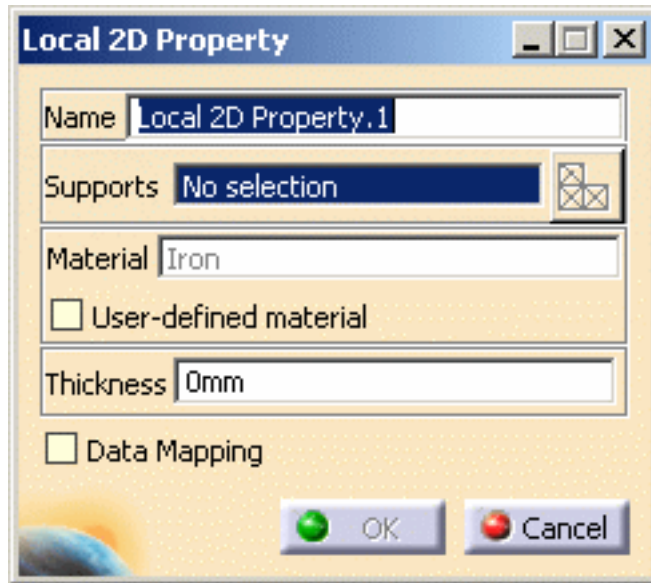

- o **Name:** you can modify the name of the property.
  - o **Supports:** you can select a support.
  - o **Select Mesh Parts:** this button is only available if you have selected a support.
  - o **Material:** indicates you that a material has been applied on the selected support.
  - o **User Defined Material:** lets you select an user isotropic material on condition that it has been previously created  
For more details, please refer [Creating an User Material](#).
  - o **Thickness:** you can change the value of the thickness.
  - o **Data Mapping:** for more details, see [Data Mapping](#).
2. Select the part of the geometry on which you want to apply a local 2D property.



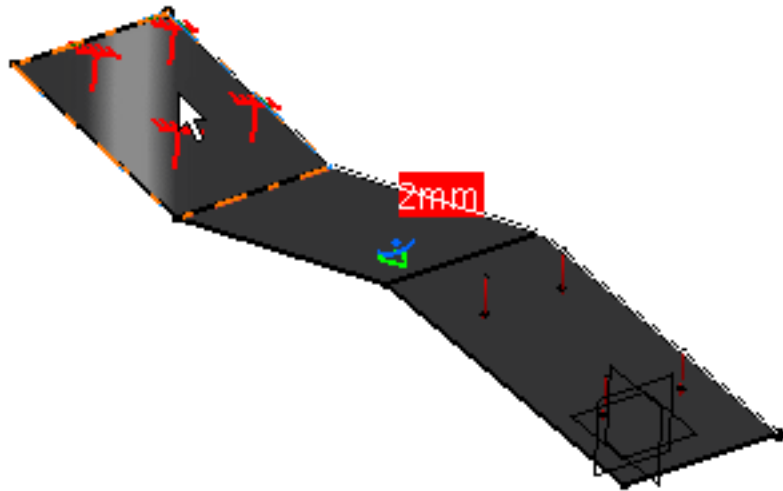

The Local 2D Property dialog box is updated as shown here:

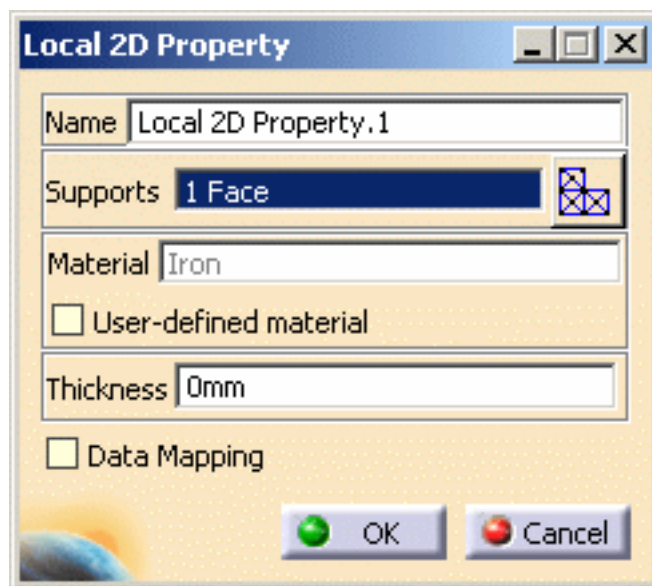

3. Enter **1mm** as **Thickness** value.
4. Click **OK** in the Local 2D Property dialog box.

The Local 2D Property is created and symbols appear on the geometry.

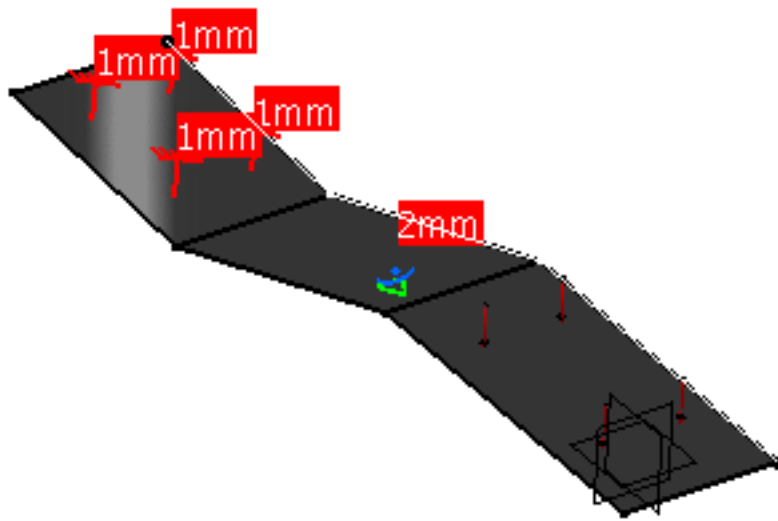

A **Local 2D Property.1** feature appears in the specification tree.

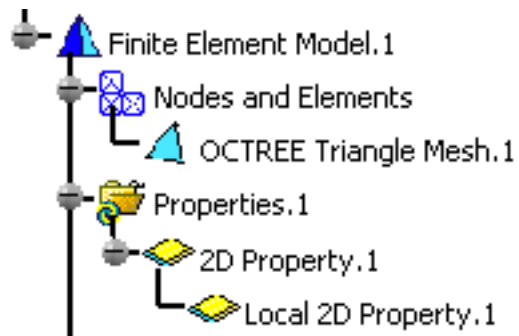

Note that you can manually edit or delete a 2D Property and a Local 2D Property.



# Importing Composite Properties



This task shows you how to import a composite property.

In the analysis context, composite properties will be applied on 2D geometries on which composite design has been defined in the **Composite Design** workbench.

For more details, please refer to the *Composite Design User's Guide*.

You will see here how to generate a composite finite element model from the design by:

- [zones](#)
- [plies](#)



Only available with the **ELFINI Structural Analysis (EST)** product.

## Definition Based on Zones



Open the [sample06.CATAnalysis](#) document.



1. Click the **Imported Composite Property** icon .

The Imported Composite Property dialog box appears.

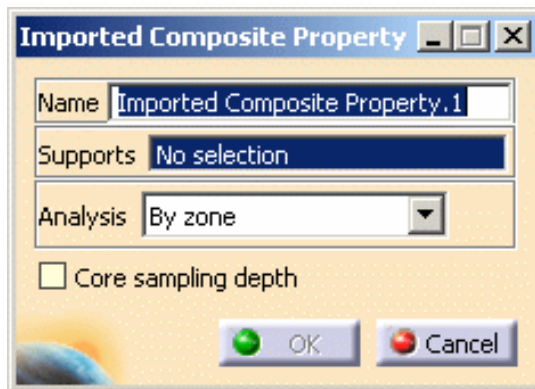

- **Name:** lets you modify the name of the property.
- **Supports:** lets you select a 2D body as support.
- **Analysis:** lets you choose the zone approach or the ply approach.
  - **By zone:** lets you choose the zone approach.
    - ⚠ **Zones** must have been defined in the *Composite Design* workbench.
    - Transition zones defined in the *Composite Design* workbench are ignored.
  - **By ply:** lets you choose the ply approach.
- **Core sampling depth:** lets you define an optional tolerance to control the number of plies or zones taken into account in the analysis context.

2. Select the support as shown bellow.

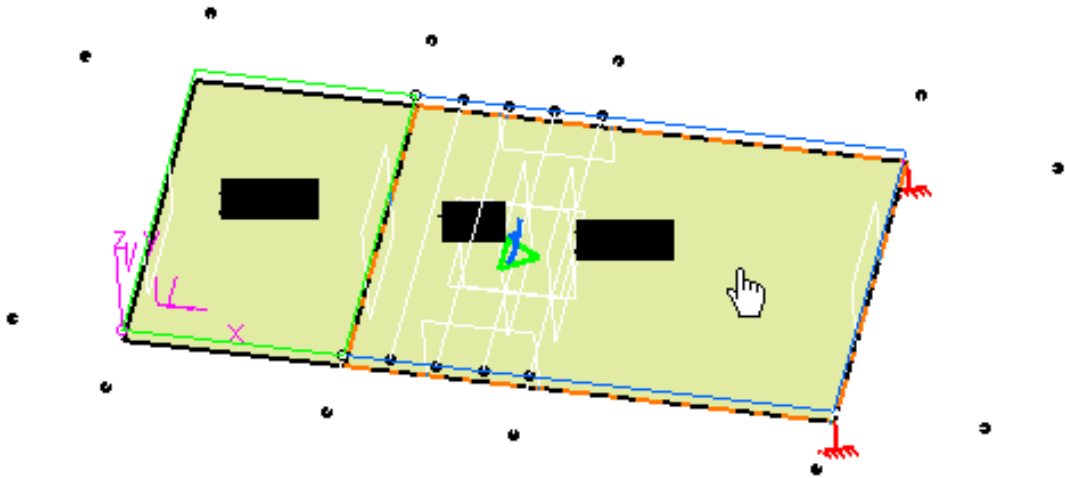

The Imported Composite Property dialog box is updated as shown below:

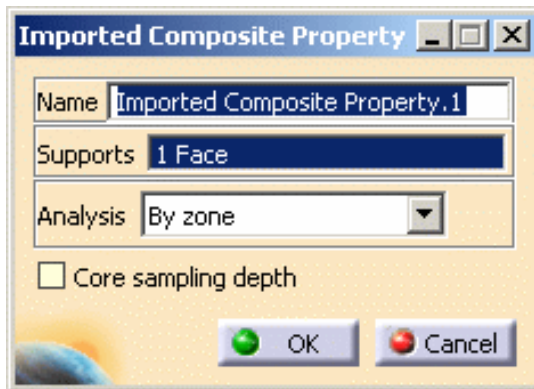

3. Select **By zone** as **Analysis** option.
4. Click **OK** in the Imported Composite Property dialog box.

An **Imported Composite Property.1** feature appears in the specification tree under the **Properties.1** set.

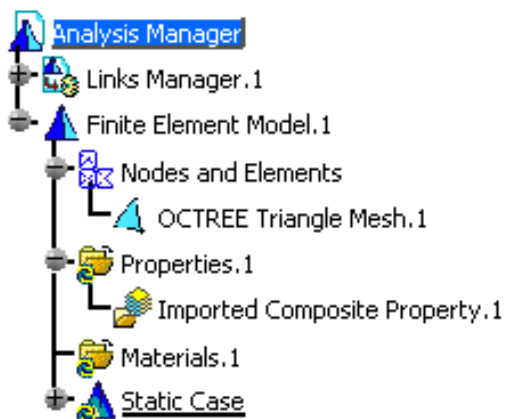

Note that the applied materials are not visible under the **Materials.1** set in the specification tree. However you can edit and change the material properties.

For this:

- a. Select the **File -> Desk** menu.
- b. Right-click the **CompositesCatalog.CATMaterial** document and select the **Open** contextual menu.
- c. Double-click a material to edit it.

The Properties dialog box appears.

- d. Change the desired parameters in the **Analysis** tab of the Properties dialog box.

For more details about this tab, please refer to [Modifying Material Physical Properties](#) in this guide.

- e. Click **OK** in the Properties dialog box.

In this particular example, do not change material physical properties.

5. Click the **Compute** icon and select **Mesh Only** in the Compute dialog box.
6. Right-click the **Properties.1** set and select the **Generate Image** contextual menu.
7. Select **Composite angle symbol** as image and click **OK** in the Image Generation dialog box.

The following image visualization is displayed:

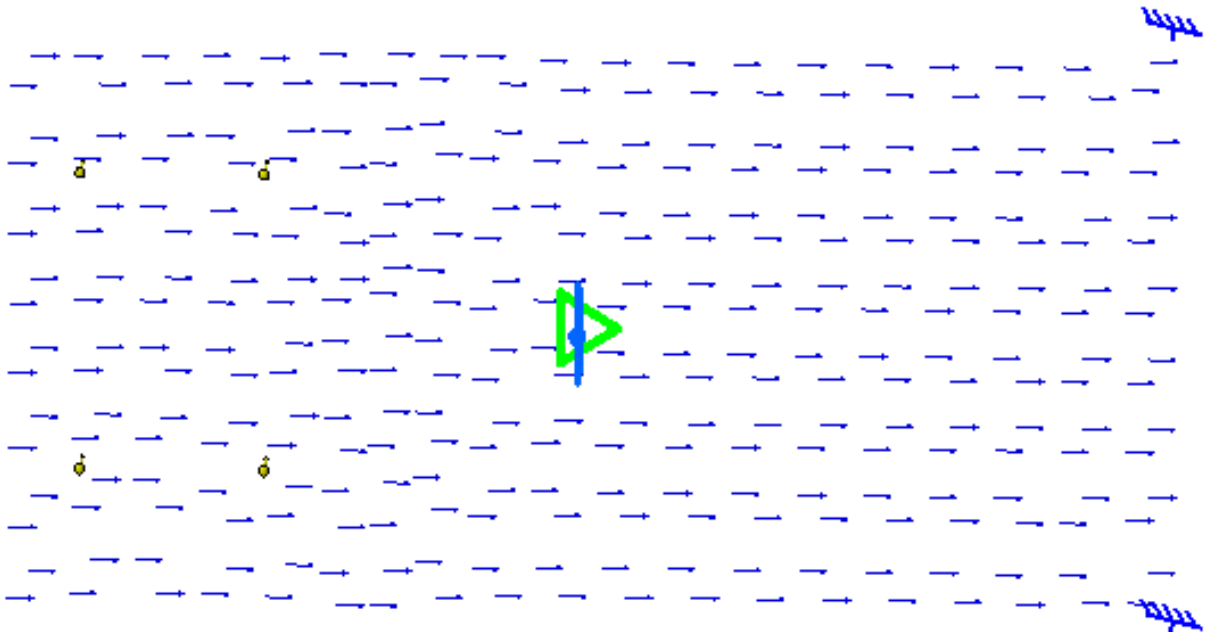

8. Edit the image you just generated.

In this particular example:

- double-click the **Composite angle symbol.1** image,
- click the **More** button to expand the Image Edition dialog box,
- enter **6** as **Lamina** value,
- click **OK** in the Image Edition dialog box.

The image visualization is updated and lets you visualize the sixth lamina:

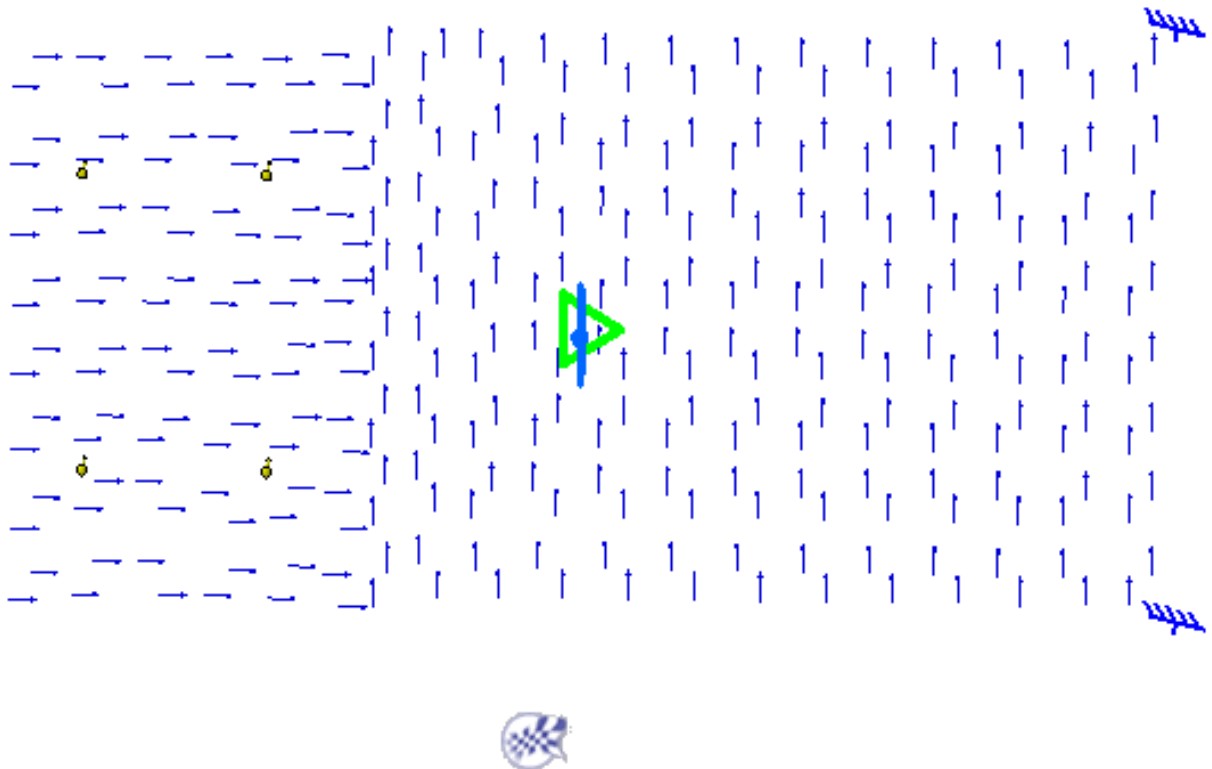

## Definition Based on Plies



Open the [sample06.CATAnalysis](#) document.



1. Click the **Imported Composite Property** icon .

The Imported Composite Property dialog box appears.

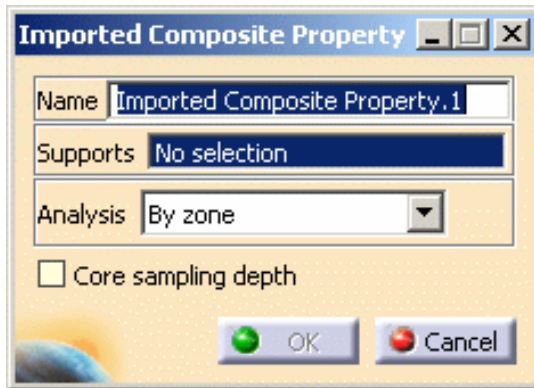

To know more about the Imported Composite Property dialog box, please click [here](#).

2. Select the support as shown below.

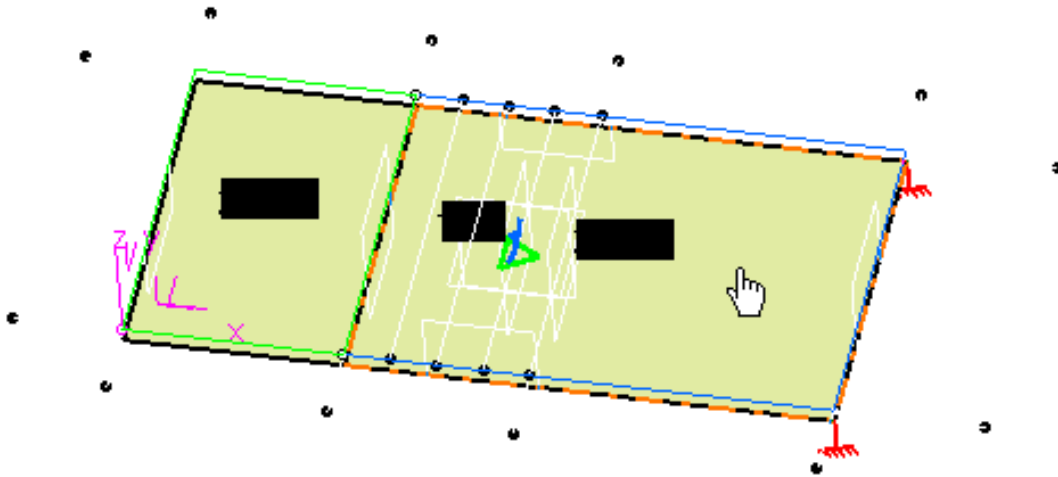

The Imported Composite Property dialog box is updated as shown below:

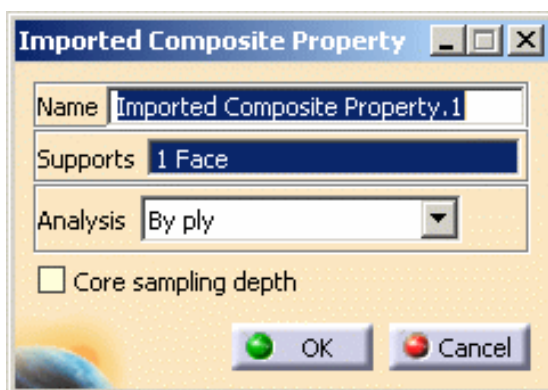

3. Select **By ply** as **Analysis** option.
4. Click **OK** in the Imported Composite Property dialog box.

An **Imported Composite Property.1** feature appears in the specification tree under the **Properties.1** set.

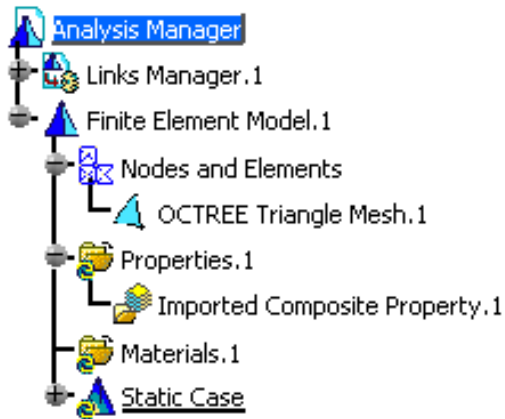

In this particular example, do not change material physical properties.

5. Click the **Compute** icon and select **Mesh Only** in the Compute dialog box.





# Creating 1D Properties



This task shows you how to:

- [add 1D physical properties](#) to a shape design by selecting a meshed wireframe geometry
- [create local 1D properties](#) (on the condition a 1D property was previously applied to the geometry)



A 1D property is a physical property assigned to a section of a part. You can also associate a local 1D property to a piece of the geometry.

To know more about this property, see [Beam Property](#) in the *Finite Element Reference Guide*.



Open the [sample52.CATAnalysis](#) document from the sample directory.

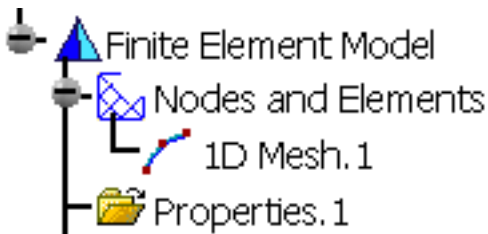

- Make sure a material was applied to the geometry and a linear 1D mesh part was assigned to the beam (it is already done in this particular case). To know more about linear 1D mesh part, please refer to [Creating 1D Mesh Parts](#) in this guide.
- You cannot apply 1D properties and 1D mesh parts on geometry included in a sketch.

## Add 1D Physical Properties

You can add 1D physical properties to a shape design by selecting a meshed wireframe geometry



1. Click the **1D Property** icon .

The 1D Property dialog box appears.

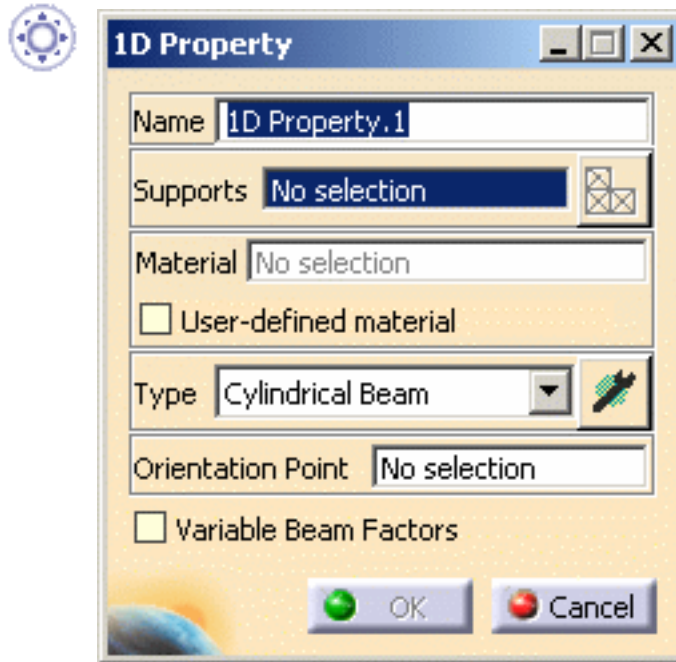

- o **Name:** lets you modify the name of the property.
- o **Supports:** lets you select a support.
- o **Select Mesh Parts:** this button is only available if you have selected a support. For more details, please click [here](#).
- o **Material:** indicates you that a material has been applied.
- o **Type:** lets you choose the type of section (and symbol) and define the parameters.

**Cylindrical  
beam:**

- **Radius:**  $R$

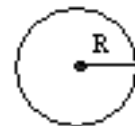

**Tubular beam:**

- **Outside Radius:**  $R_o$
- **Inside Radius:**  $R_i$



**Rectangular  
beam:**

- **Length (Y):**  $L$
- **Height (Z):**  $H$

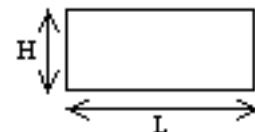

- Thin Box beam:**
- Exterior Length (Y):  $L_e$
  - Exterior Height (Z):  $H_e$
  - Interior Length (Y):  $L_i$
  - Interior Height (Z):  $H_i$

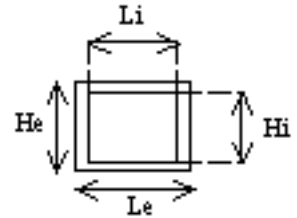

- Thin U-beam:**
- Global Length (Y):  $L$
  - Global Height (Z):  $H$
  - Global Thickness:  $T$

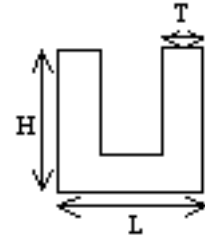

- Thin I-beam:**
- Global Length (Y):  $L$
  - Associated Thickness:  $T_l$
  - Global Height (Z):  $H$
  - Associated Thickness:  $T_h$

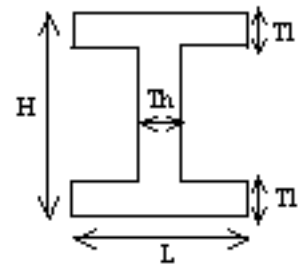

- Thin T-beam:**
- Global Length (Y):  $L$
  - Associated Thickness:  $T_l$
  - Global Height (Z):  $H$
  - Associated Thickness:  $T_h$

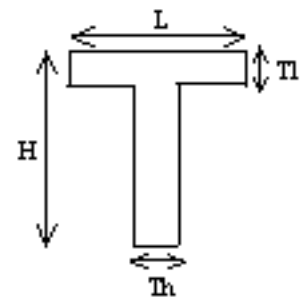

- Thin X-beam:**
- Global Length (Y):  $L$
  - Associated Thickness:  $T_l$
  - Global Height (Z):  $H$
  - Associated Thickness:  $T_h$

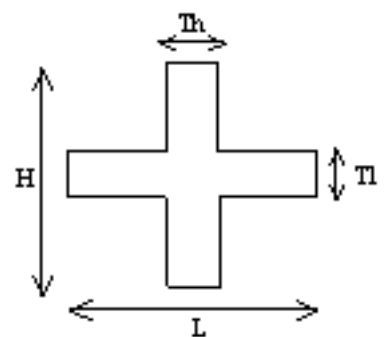

<b>User-defined beam:</b>	▪ <b>Cross-sectional Area</b>	Any section
	▪ <b>Ixx</b>	
	▪ <b>Iyy</b>	
	▪ <b>Izz</b>	
	▪ <b>Shear center (Y)</b>	
	▪ <b>Shear center (Z)</b>	
	▪ <b>Shear Factor (XY)</b>	
	▪ <b>Shear Factor (XZ)</b>	

<b>Beam from surface * :</b>	▪ <b>Arbitrary section</b>	Any surface section**
	▪ <b>Compute and display</b>	
	▪ <b>Cross-sectional Area</b>	
	▪ <b>Ixx</b>	
	▪ <b>Iyy</b>	
	▪ <b>Izz</b>	
	▪ <b>Shear center (Y)</b>	
	▪ <b>Shear center (Z)</b>	
	▪ <b>Shear Factor (XY)</b>	
	▪ <b>Shear Factor (XZ)</b>	

<b>Bar * :</b>	▪ <b>Cross-sectional Area</b>	Any section**
----------------	-------------------------------	---------------

\* : only available with the **ELFINI Structural Analysis (EST)** product.



\*\* :

- **Beam from surface** option:
  - The surface must be a 2D feature (as **Fill, Join, ...**).
  - You cannot select a sketch.
  - The surface must be plane and continue.
- **Bar** option:
 

Before launching a **Mesh only** or **All** computation with this option, make sure that the mesh element type is bar.  
For more details, please refer to [Changing Element Type](#).

If you select a geometry option, all the data of the user-defined beam are

computed.

- **Orientation Point:** the orientation point gives the orientation of the Y direction for any wire frame at any point: X is fixed tangent to the wire frame and in the direction of the oriented wire frame. After computation is performed, to visualize particular axis on each element, right-click on the property set and select the Generate Image called **Local axis symbol** (see further below for more details).



Avoid creating an orientation point that is tangent to the line or the curve. If so, you may have some problems when computing the case.

- **User-defined material:** lets you select an isotropic material that you have created. For more details, please refer [Creating an User Material](#).
- **Variable beam factors:** lets you create a linear approximation of variable cross section beams.

If you activate this option, two new fields appear in the Beam Property dialog box.

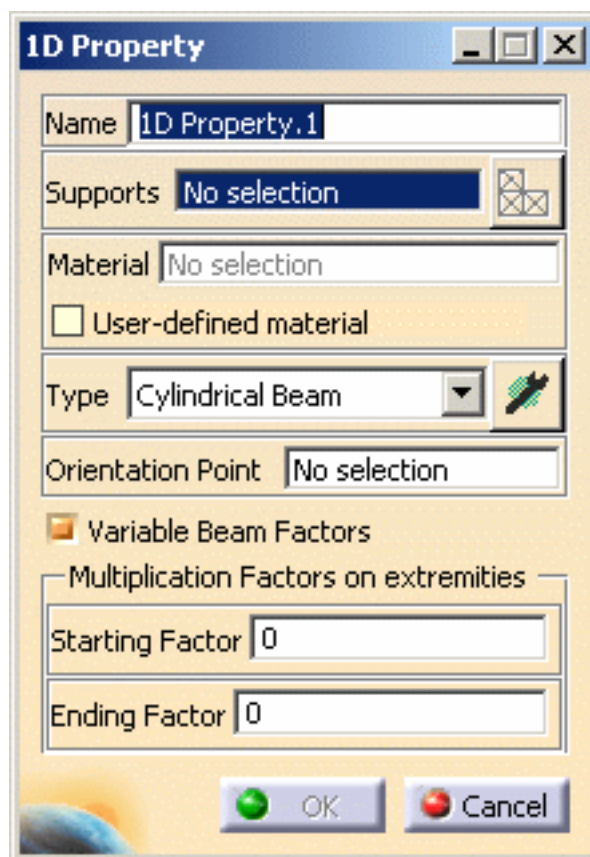

The **Multiplication Factors on extremities** frame will let you give a scaling factor on each side of the section. The beam will then be modeled as a sequence of constant section beams with linearly decreasing dimensions.

- **Starting Factor**
- **Ending Factor**

2. Select the support geometry to be applied a 1D property.



The 1D Property dialog box is updated as shown here:

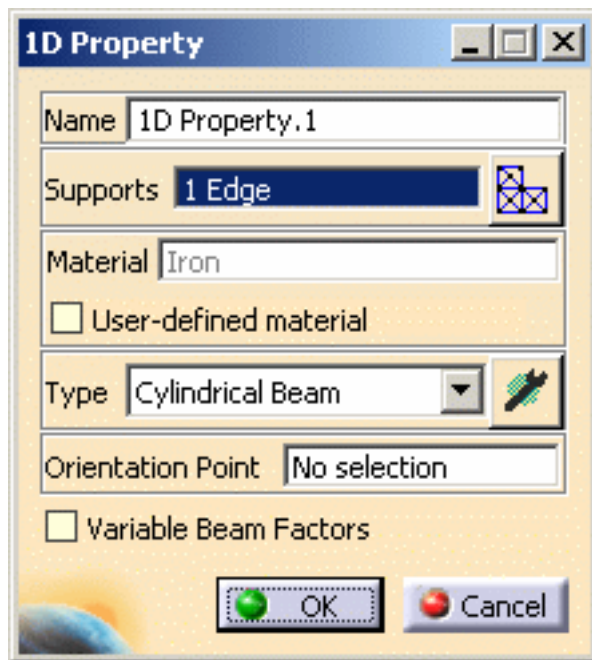

3. Select **Rectangular beam** as **Section** option.

4. Click the **Component Edition** button  in the 1D Property dialog box to define dimensions.

The Beam Definition dialog box appears.

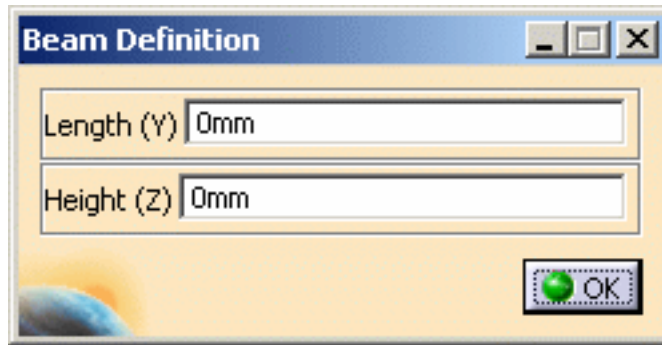

5. Enter **10 mm** in the **Length (Y)** field and **10 mm** in the **Height (Z)** field.
6. Click **OK** in the Beam Definition dialog box.

Symbols appear on the geometry to simulate the section of the beam.

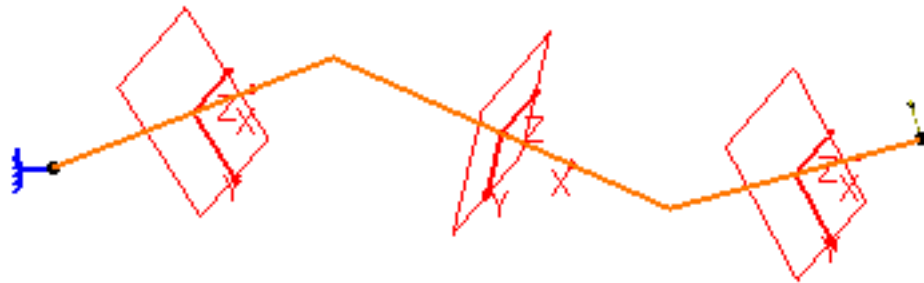

7. Activate the **Orientation Point** field and select a point.

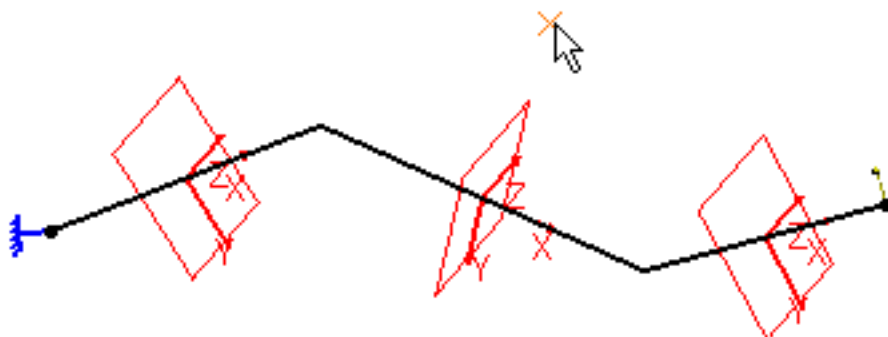

The 1D Property dialog box appears as shown here:

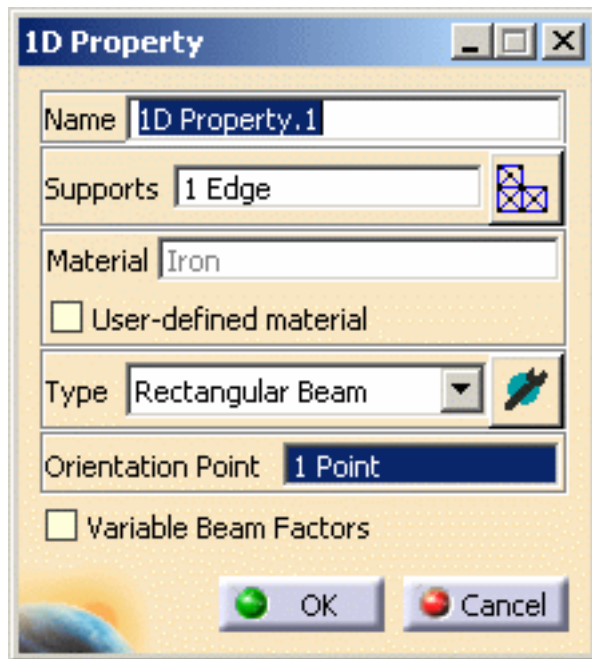

8. Click **OK** in the 1D Property dialog box.

The 1D Property is added. In this case, **1D Property.1** feature appears in the specification tree.

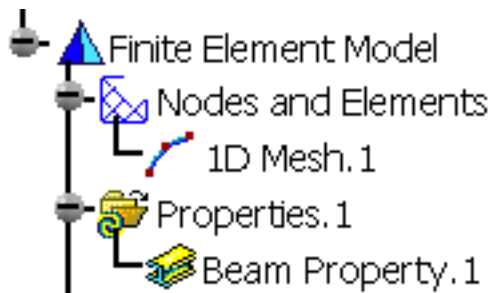





# Create Local 1D Property



This functionality is only available if you installed the **ELFINI Structural Analysis (EST)** product.

You can associate a local section to a piece of the geometry.

1. Right-click the **1D Property.1** feature previously created in the specification tree and select the **Local 1D Property** contextual menu.

The Local 1D Property dialog box appears.

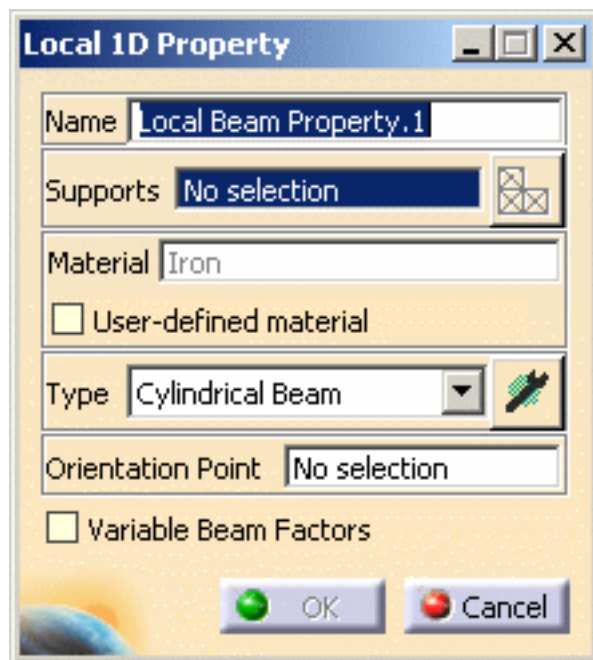

- **Name:** lets you modify the name of the property.
- **Supports:** lets you select a support.
- **Select Mesh Parts:** this button is only available if you have selected a support. For more details, please click [here](#).
- **Material:** indicates you that a material has been applied.
- **User Defined Material:** lets you select an user isotropic material on condition that it has been previously created. For more details, please refer [Creating an User Material](#).
- **Type:** lets you choose the type of section (and symbol) and define the parameters. For more details, please click [here](#).
- **Orientation Point:** the orientation point gives the orientation of the Y direction

for any wire frame at any point: X is fixed tangent to the wire frame and in the direction of the oriented wire frame. After computation is performed, to visualize particular axis on each element, right-click on the property set and select the Generate Image called **Local axis symbol** (see further below for more details).

- **Variable beam factors:** lets you create a linear approximation of variable cross section beams.

If you activate this option, two new fields appear in the Local 1D Property dialog box.

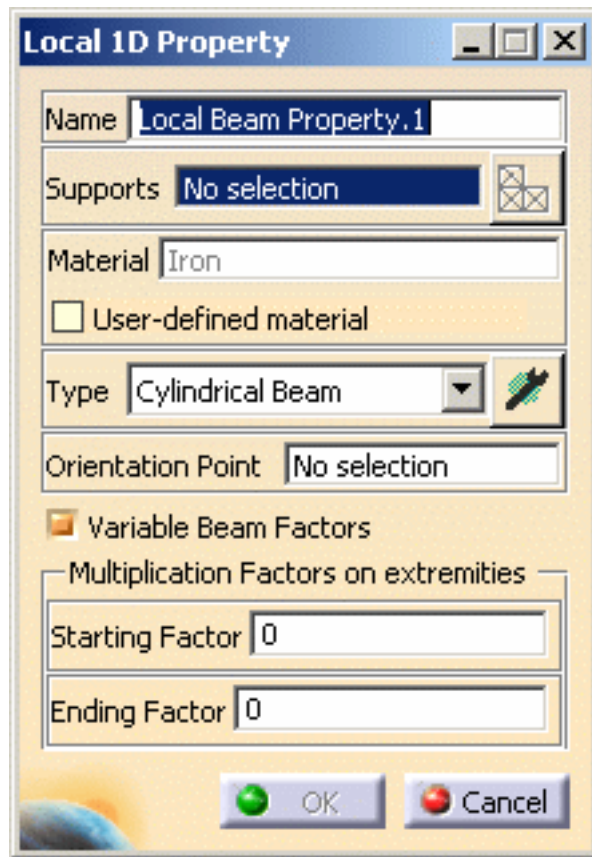

The **Multiplication Factors on extremities** frame will let you give a scaling factor on each side of the section. The local 1D will then be modeled as a sequence of constant section beams with linearly decreasing dimensions.

- **Starting Factor**
- **Ending Factor**

2. Select the part of the geometry on which you want to apply a local 1D property.

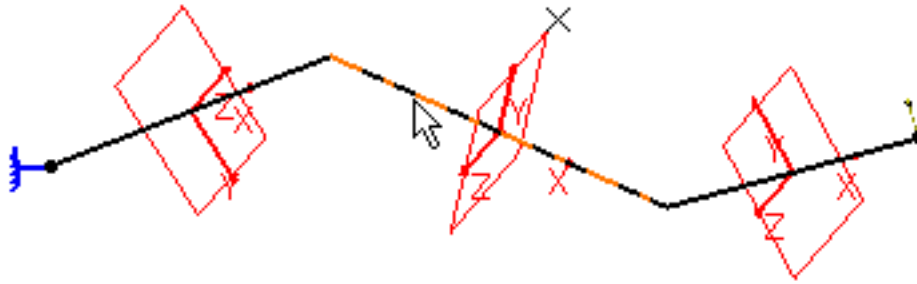

The Local 1D Property is updated as shown here:

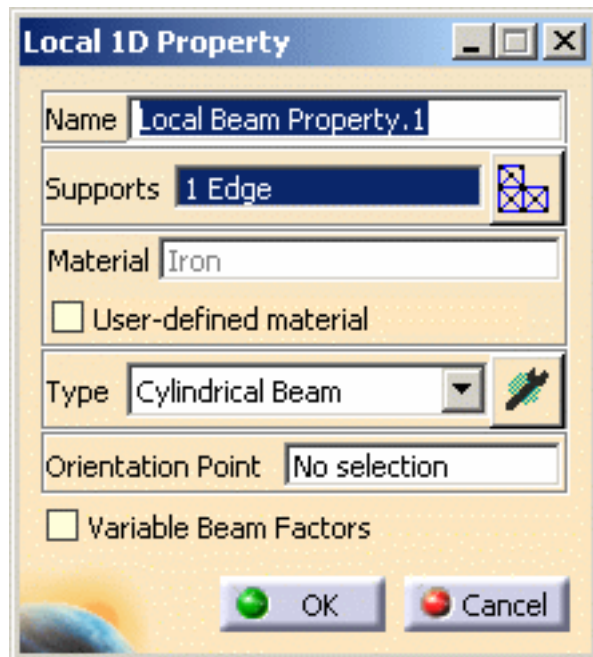

3. Change the **Type** option. In this particular case, select the **Thin box beam** option.

The geometry appears as shown here.

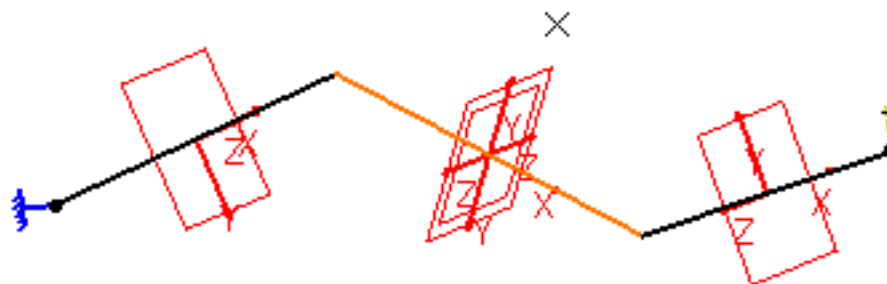

4. Click the **Component Edition** button  in the Local 1D Property dialog box to define the dimensions of the section.

The Beam Definition dialog box appears.

5. Enter the following values in the different fields of the Beam Definition dialog box.

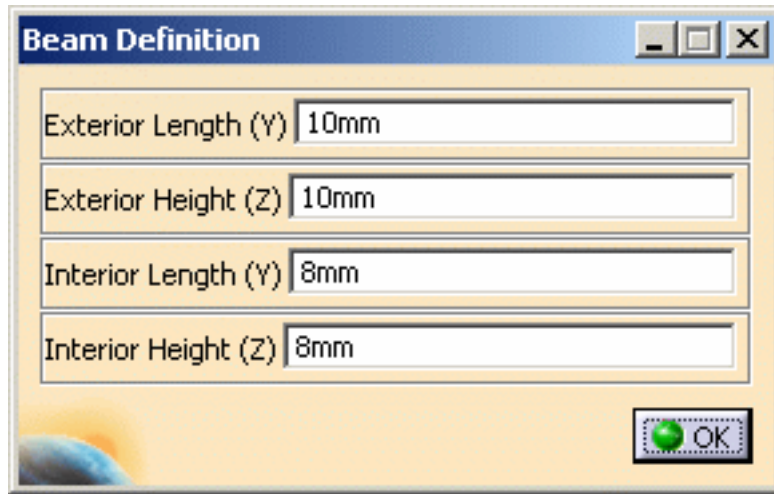

6. Click **OK** in the Beam Definition dialog box.

7. Select a point as **Orientation Point**.

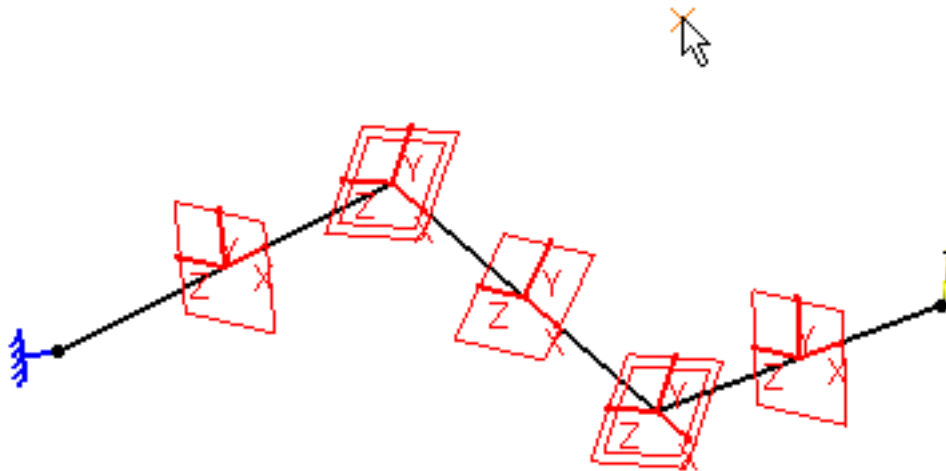

8. Click **OK** in the Local 1D Property dialog box.

A **Local 1D Property.1** feature appears in the specification tree.

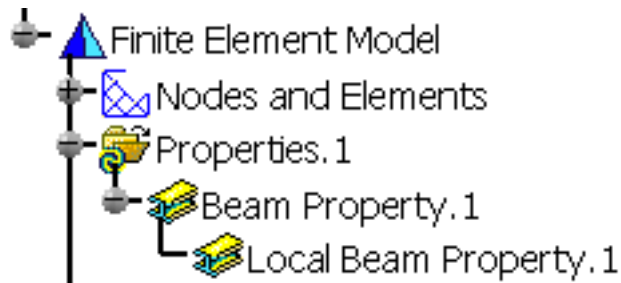

Note that you can manually edit or delete 1D properties.

# Creating Imported Beam Properties



This task will show you how to create a beam property on a beam imported from the Equipment Support Structures workbench.



The Equipment Support Structures beams will be recognized as features to 1D mesh during the transition (the wire frame along which the section of the beam is swept is the geometry that will be 1D mesh). A beam property will be created as well with mechanical properties imported from the Equipment Support Structures catalogs.



The only sections supported in the Analysis solutions are the **Standard Catalog Sections** of the *Equipment Support Structures workbench*.

The **User-defined Sections** are not supported in the Analysis solutions.

Moreover, the beam mesher will accept the selection of an Equipment Support Structures beam and a specific command lets you import the mechanical properties from the model into a beam property.

For more details about the beam creation in the Equipment Support Structures workbench, please refer to the *Equipment Support Structures User's Guide*.



Loads and restraints can be applied only on beam vertices.



You have to make a list of sections and create a member in the Equipment Support Structures workbench, then you have to enter in the Generative Structural Analysis workbench.

Open the [sample10.CATAnalysis](#) document from the sample directory.

In this example, all the pre-requisites are done. Note that:

- the **Nodes and Elements** set contains a **1D Mesh** object
- the **Properties** set contains an **Imported Beam Property** object.

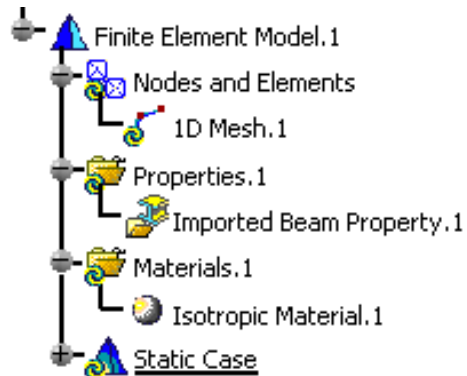



1. Double-click the **Imported Beam Property.1** object in the specification tree.

The Imported Beam Property dialog box appears.



- o **Name:** lets you change the name of the property.
- o **Supports:** lets you select the support on which the imported beam property will be applied.
- o **Select Mesh Parts:** this button is only available if you have selected a support.
- o **Material:** gives you information about the material associated to the selected support.

2. Click the **Clamp** icon.

The Clamp dialog box appears.

3. Select a vertex as **Support**.

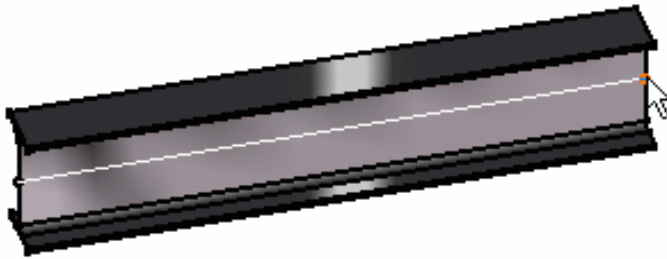

4. Click **OK** on the Clamp dialog box.

5. Click the **Distributed Force** icon.

The Distributed Force dialog box appears.

6. Select a vertex as **Support**, enter **100N** in the **Z** field.

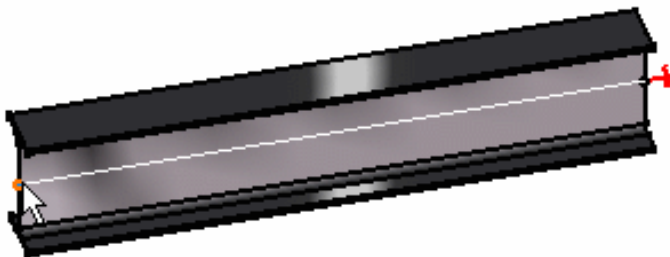

7. Click **OK** in the Distributed Force dialog box.

8. Compute the solution.

For this, click the **Compute** icon, select the **All** option in the Compute dialog box and click **OK**.

9. Click the **Deformation** icon.

You can visualize the deformation of the beam.

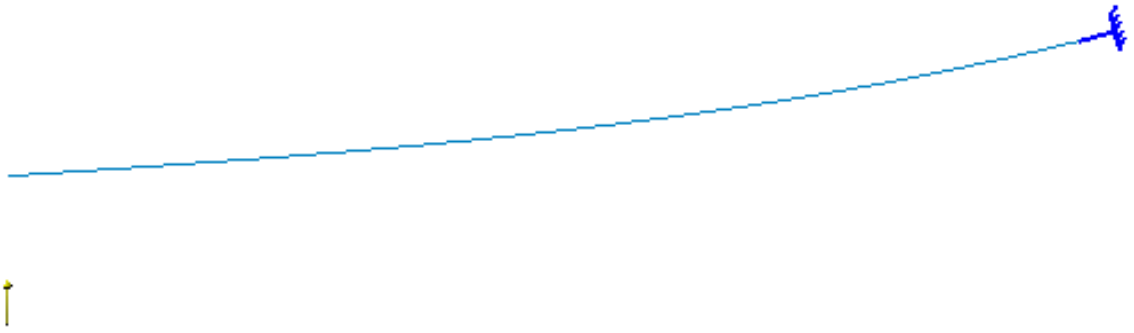

To have a better visualization of the deformation, you can use the **Animate** icon.  
For more details, please refer to [Animating Images](#).





# Changing Element Type



This task shows you how to use the **Change Type** contextual menu in the Generative Structural Analysis workbench and the Advanced Meshing Tools workbench (only with the **FEM Surface** product).

You can change the type of:

- 1D element
- the physical property associated to 2D element



Only available with the **ELFINI Structural Analysis (EST)** product.

## Changing Type of 1D Element



Open the [sample52.CATAnalysis](#) document from the sample directory.



1. Click the **1D Property** icon  and select the 1D geometry.
2. Select **Bar** as **Type** option.



A message appears to inform you that you cannot apply a bar property to beam elements.

You have to change the element type from beam to bar.

3. Click **Cancel** in the 1D Property dialog box.
4. Right-click the **1D Mesh.1** object in the specification tree (under the **Nodes and Elements** set) and select the **Change Type** contextual menu

Change Type



The Change Physical Type dialog box appears.

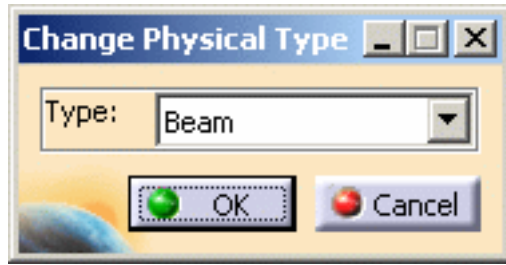

- **Type:** lets you select the desired element type.
  - **Beam:** this element type is useful for all the beam property you can select in the 1D Property dialog box.  
For more details about the beam element, please refer to [Beam](#) in the *Finite Element Reference Guide*.
  - **Bar:** this element type is recommended if you select **Bar** as 1D property type.  
For more details about the bar element, please refer to [Linear Bar](#) or [Parabolic Bar](#) in the *Finite Element Reference Guide*.

**5.** Select the desired **Type** option.

In this particular example, select **Bar** as **Type** option.

**6.** Click **OK** in the Change Physical Type dialog box.

**7.** Click the **1D Property** icon .

**8.** Set the following parameters:

- select the 1D geometry as **Support**,
- select **Bar** as **Type** option.

**9.** Click **OK** in the 1D Property dialog box.

**10.** Compute the case.

## Changing Physical Property of 2D Element



Open the [sample52.CATAnalysis](#) document from the sample directory.



1. Right-click a 2D mesh part in the specification tree (under the **Nodes and Elements** set) and select the **Change Type** contextual menu

Change Type

The Change Physical Type dialog box appears.

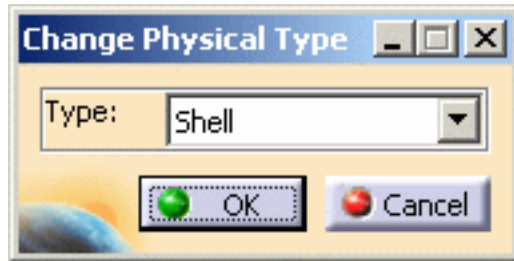

- **Type:** lets you change the physical property of 2D element mesh.
  - **Shell:** lets you associate a shell property to 2D element. For more details about the shell property, please refer to [Shell Property](#) in the *Finite Element Reference Guide*.
  - **Membrane:** lets you associate a membrane property to 2D element. For more details about the membrane property, please refer to [Membrane Property](#) in the *Finite Element Reference Guide*.
  - **Shear panel:** only available for linear smart surface (linear quadrangle) mesh part. lets you associate a shear panel property to 2D element. For more details about the shear panel property, please refer to [Shear Panel Property](#) in the *Finite Element Reference Guide*.



If you define a parabolic smart surface (parabolic quadrangle) mesh part with **Shear panel** elements, all the elements will be changed in **Membrane** elements.

2. Select the desired **Type** option.
3. Click **OK** in the Change Physical Type dialog box.





# Creating a User Material



This task shows you how to create a user material with no geometrical support.

The user material will be added under the **Material** set in the analysis context contrary to the **Apply Material** functionality.

For example, this material should be useful for properties that have mesh support.



Open the [sample51.CATAnalysis](#) document from the sample directory.

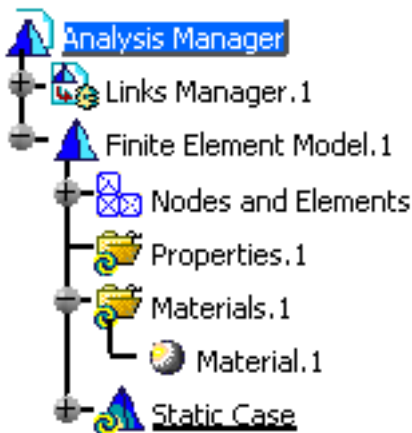

1. Click the **User Material** icon .

The Library dialog box appears.

For more details about the Library dialog box, please refer to the *Real Time Rendering User's Guide*.

2. Choose the desired material in the Library dialog box.

In this particular example, select **Aluminium** in the **Metal** tab.

3. Click **OK** in the Library dialog box.

A **User Material.1** object appears in the specification tree under the **Material.1** set.

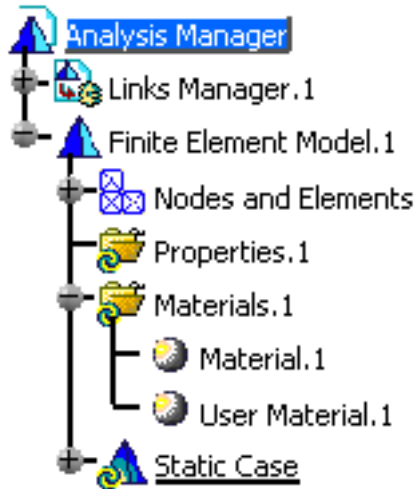

4. Double-click the **User Material.1** object in the specification tree.

 You can also right-click the **User Material.1** object and select the **Properties** contextual menu.

The Properties dialog box appears. This dialog box lets you modify the physical properties of the user material using the **Analysis** tab.

For more details about the **Analysis** tab of the Properties dialog box, please refer to [Modifying Material Physical Properties](#).

5. Select the **Analysis** tab in the Properties dialog box.

By default, the **Analysis** tab appears as shown bellow:

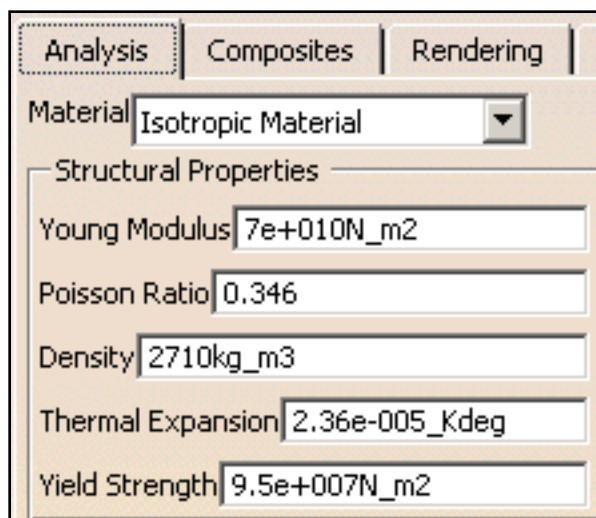

6. Modify the parameters if needed.
7. Click **OK** in the Properties dialog box.





# Modifying Material Physical Properties



This task shows you how to modify physical properties of a material belonging to a **.CATPart** or a **.CATProduct** document or a user material contained in the **Material** set of a **.CATAnalysis** document.



Open the [sample51.CATAnalysis](#) document from the sample directory.



1. Right-click a material in the specification tree and select the **Property** contextual menu or double-click a user material under the **Material** set.

In this particular example, right-click the **Iron** material under the **Part1-Geometrical Set.1-Extrude.1** object in the specification tree and select the **Properties** contextual menu.

The Properties dialog box appears.

For more details about the Properties dialog box, please refer to the *Real Time Rendering User's Guide*.

2. Select the **Analysis** tab in the Properties dialog box.

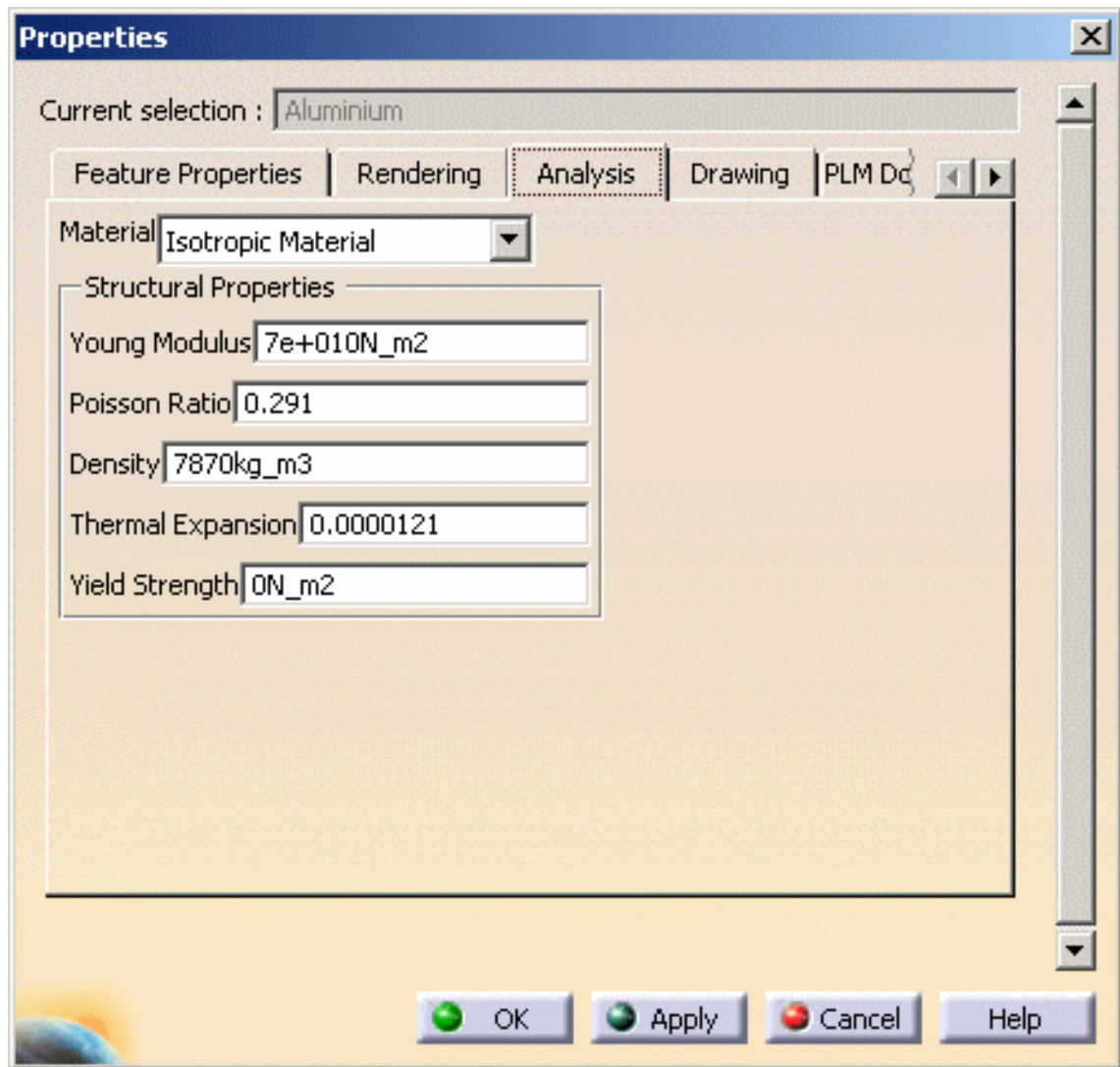

- **Material:** lets you change the material type.
- **Structural Properties:** lets you modify the physical parameters associated a material type.

The **Structural Properties** parameters depend on the selected **Material** option:

- **Isotropic material:**

Young Modulus	0N_m2
Poisson Ratio	0
Density	0kg_m3
Yield Strength	0N_m2
Thermal Expansion	0_Kdeg

- **Orthotropic material 2D:**

Longitudinal Young Modulus	0N_m2
Transverse Young Modulus	0N_m2
Poisson Ratio in XY Plane	0
Shear Modulus in XY Plane	0N_m2
Shear Modulus in XZ Plane	0N_m2
Shear Modulus in YZ Plane	0N_m2
Density	0kg_m3
Longitudinal Tensile Stress	0N_m2
Longitudinal Compressive Stress	0N_m2
Transverse Tensile Stress	0N_m2
Transverse Compressive Stress	0N_m2
Longitudinal Thermal Expansion	0_Kdeg
Transverse Thermal Expansion	0_Kdeg
Longitudinal Tensile Strain	0
Longitudinal Compressive Strain	0
Transverse Tensile Strain	0
Transverse Compressive Strain	0

- **Fiber material:**



Longitudinal Young Modulus	0N_m2
Transverse Young Modulus	0N_m2
Poisson Ratio in XY Plane	0
Shear Modulus in XY Plane	0N_m2
Shear Modulus in YZ Plane	0N_m2
Density	0kg_m3
Longitudinal Thermal Expansion	0_Kdeg
Transverse Thermal Expansion	0_Kdeg
Longitudinal Tensile Stress	0N_m2
Longitudinal Compressive Stress	0N_m2
Transverse Tensile Stress	0N_m2
Transverse Compressive Stress	0N_m2
Shear Stress Limit in XY Plane	0N_m2
Shear Stress Limit in YZ Plane	0N_m2

- o **Honey comb material:**

Normal Young Modulus	0N_m2
Shear Modulus in XZ Plane	0N_m2
Shear Modulus in YZ Plane	0N_m2
Density	0kg_m3
Shear Stress Limit in XZ Plane	0N_m2
Shear Stress Limit in YZ Plane	0N_m2
Normal Thermal Expansion	0_Kdeg

- o **Orthotropic material 3D:**

Longitudinal Young Modulus	0N_m2
Transverse Young Modulus	0N_m2
Normal Young Modulus	0N_m2
Poisson Ratio in XY Plane	0
Poisson Ratio in XZ Plane	0
Poisson Ratio in YZ Plane	0
Shear Modulus in XY Plane	0N_m2
Shear Modulus in XZ Plane	0N_m2
Shear Modulus in YZ Plane	0N_m2
Density	0kg_m3
Longitudinal Thermal Expansion	0_Kdeg
Transverse Thermal Expansion	0_Kdeg
Normal Thermal Expansion	0_Kdeg
Longitudinal Tensile Stress	0N_m2
Longitudinal Compressive Stress	0N_m2
Transverse Tensile Stress	0N_m2
Transverse Compressive Stress	0N_m2
Shear Stress Limit in XY Plane	0N_m2
Shear Stress Limit in XZ Plane	0N_m2
Shear Stress Limit in YZ Plane	0N_m2

o **Anisotropic material:**



This option is not available if you work with composite materials.

Longitudinal Shear Modulus	0N_m2
Shear Modulus in XY Plane	0N_m2
Shear Modulus in XZ Plane	0N_m2
Transverse Shear Modulus	0N_m2
Shear Modulus in YZ Plane	0N_m2
Normal Shear Modulus	0N_m2
Density	0kg_m3
Longitudinal Thermal Expansion	0_Kdeg
Transverse Thermal Expansion	0_Kdeg
Normal Thermal Expansion	0_Kdeg
Tensile Stress	0N_m2
Compressive Stress	0N_m2
Shear Stress	0N_m2

The following components lets you define the mechanical behavior of the selected material.

3. Select the desired **Material** option in the Properties dialog box.
4. Enter the desired parameters in the Properties dialog box.
5. Click **OK** in the Properties dialog box.



# Editing a User Isotropic Material



This task shows you how to edit a user isotropic material with no geometrical support.

For example, this material should be useful for properties that have mesh support.



From the V5R14 release, you cannot create a user isotropic material anymore.

You can only edit a user isotropic material that has been created in the previous releases.



Open the [sample48\\_1.CATAnalysis](#) document from the sample directory.

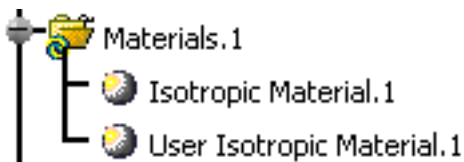

1. Double-click the **User Isotropic Material** object under the **Material.1** set in the specification tree to edit it.

The User Isotropic Material dialog box appears.

The dialog box titled "User Isotropic Material" contains the following fields and buttons:

- Name: User Isotropic Material.1
- Young Modulus: 5N\_m2
- Poisson Ratio: 1
- Density: 1kg\_m3
- Thermal Expansion: 3
- Yield Strength: 1N\_m2
- Buttons: OK (green), Cancel (red)

- o **Name:** lets you change the name of the user isotropic material.
- o The following components lets you define the mechanical behavior of the material
  - **Young Modulus** (in  $N\_m^2$ )
  - **Poisson Ratio**

- **Density** (in  $\text{kg\_m}^3$ )
- **Thermal Expansion**
- **Yield Strength** (in  $\text{N\_m}^2$ )

**2.** If needed, modify the parameters in the User Isotropic Material dialog box.

**3.** Click **OK** in the User Isotropic Material dialog box.



# Checking the Model

 This task lets you know how to check whether specification assigned to a model are consistent. You can perform check operations on:

- [Bodies](#)
- [Connections](#)
- [Others](#)

Note that this check on features considered as inconsistent is performed both via the dialog box (one line per feature and a dedicated diagnostic box) and via highlighted associated features in the specification tree.

 We advise that you perform a check before computing a case.

## Check on Bodies

Check on bodies means on all the Mesh parts (1D, 2D, 3D) as well as their properties and supports.

### Scenario1: You created a new property

For this, you selected the Solid Property command and selected pad1.

 Open the [sample37.CATAnalysis](#) document from the samples directory.

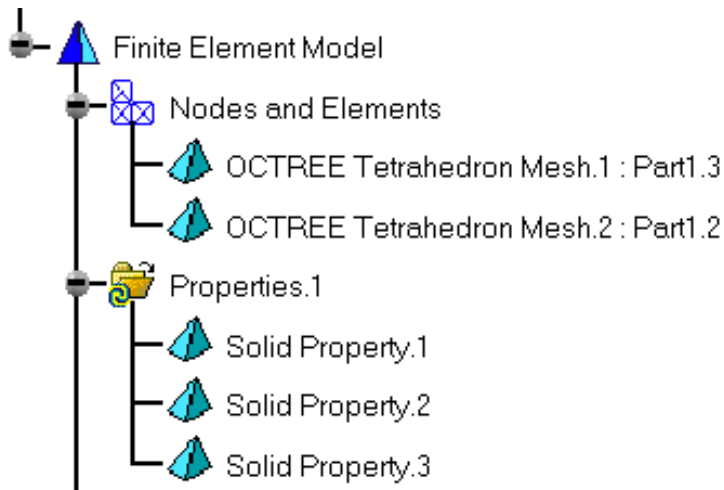

1. Click the **Model Check** icon  from the **Model Manager** toolbar.

The Model Check dialog box appears with the following tabs:

- **Bodies:** the lists of all the Mesh parts (1D, 2D, 3D) as well as their properties and supports.
- **Connections:** any connection specification
- **Others:** specification features (loads, restraints, virtual parts)

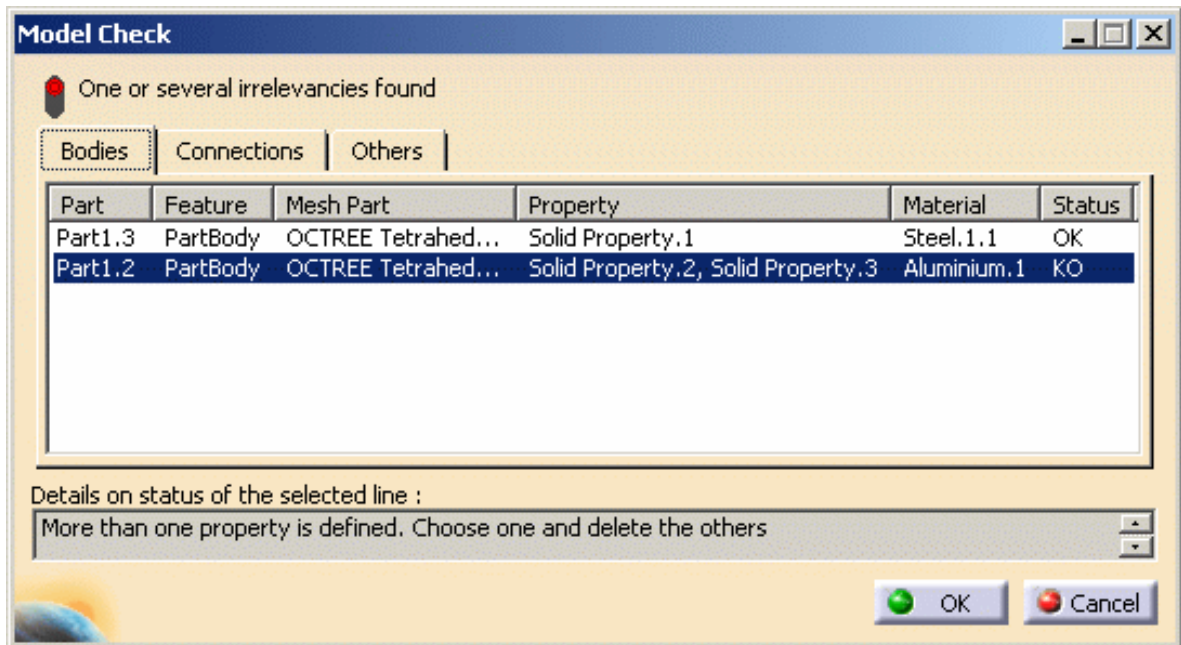

The Model Check dialog box displays all the parts (one per line in the dialog box) which are assigned at least one mesh part or property.

A status is assigned to each Mesh part you select in the dialog box, to let you know whether:

- you forgot to assign the material
- you assigned no or too many Mesh parts
- you assigned no or too many properties.

When you select a part in the table, the corresponding features in the specification tree and in the model as well as the assigned properties and material are also highlighted.

**In this particular case, more than one property has been defined.**

2. Click **OK** to leave the dialog box.
3. Delete the property you do not need and get this:
4. Click the **Model Check** icon  from the **Model Manager** toolbar.

The specifications are now consistent: all the states are set to OK.

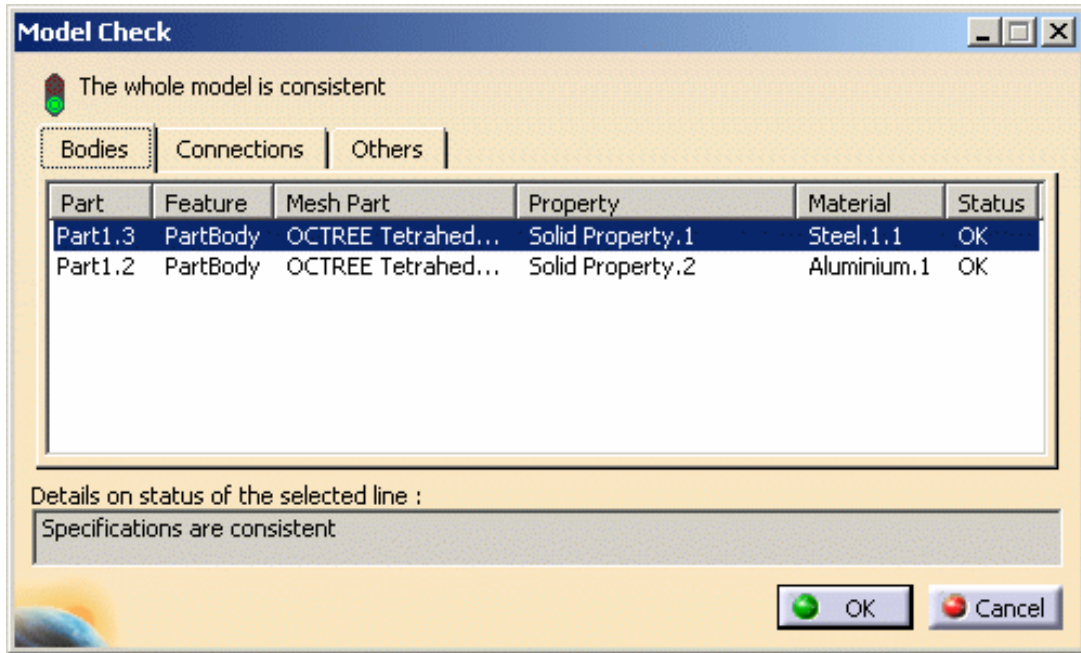

5. Click **OK** to leave the dialog box.



Scenario2: You deleted the material from an OCTREE mesh part



Open the [sample38.CATAnalysis](#) document from the samples directory.

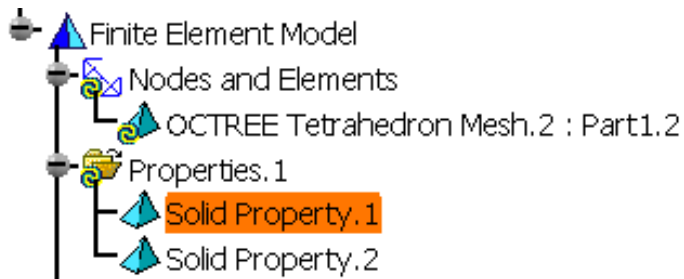

1. Click the **Model Check** icon  from the **Model Manager** toolbar.



The Model Check dialog box appears with the following tabs:

- o **Bodies:** the lists of all the Mesh parts (1D, 2D, 3D) as well as their properties and supports.
- o **Connections:** any connection specification
- o **Others:** specification features (loads, restraints, virtual parts)

The Model Check dialog box displays the lists of all the Mesh parts as well as their properties and supports.

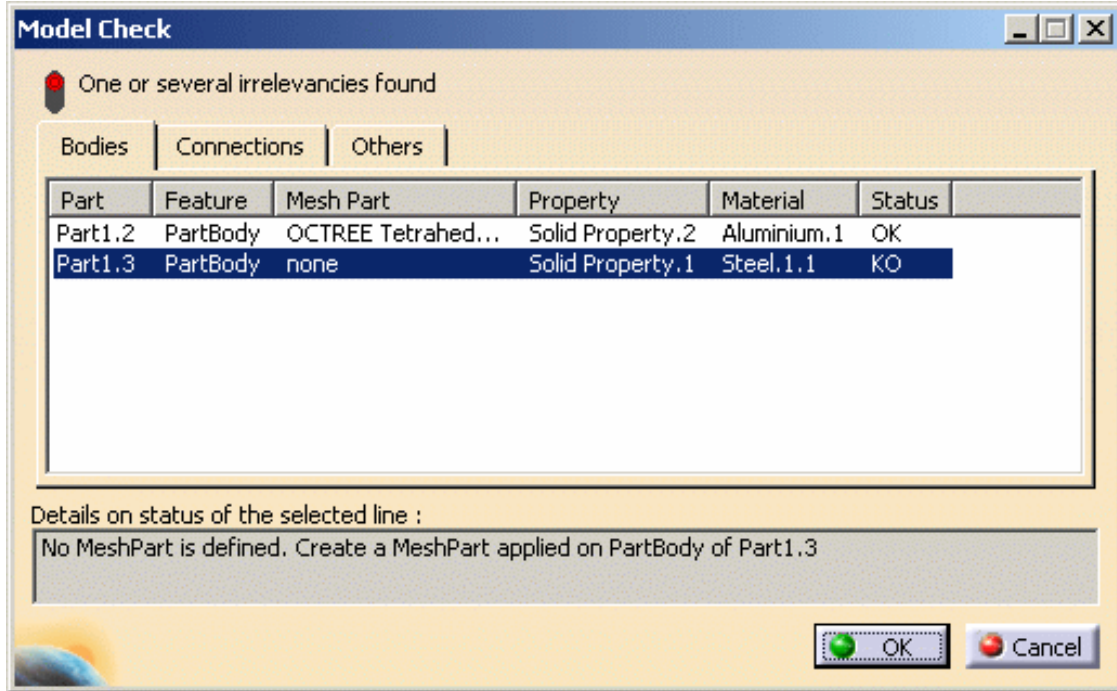

A status is assigned to each Mesh part to let you know whether:

- o you forgot to assign the material
- o you assigned no or too many Mesh parts
- o you assigned no or too many properties.

When you select a part in the table, the corresponding features in the specification tree and in the model as well as the assigned properties and material are also highlighted.

**In this particular case, No Mesh Part is defined**

2. Click **OK** to leave the dialog box.
3. Create a mesh part applied on PartBody of **Part1.3** and get this:

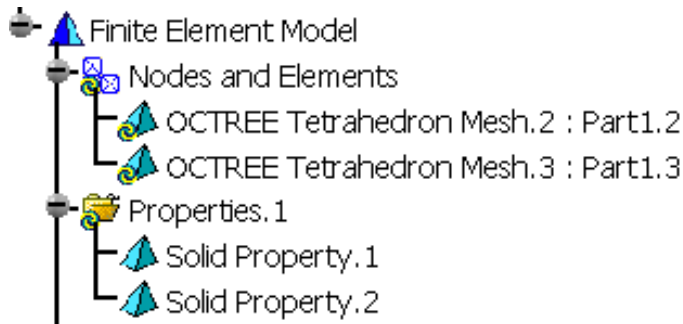

4. Click the **Model Check** icon

**The specifications are now consistent: all the states are set to OK.**

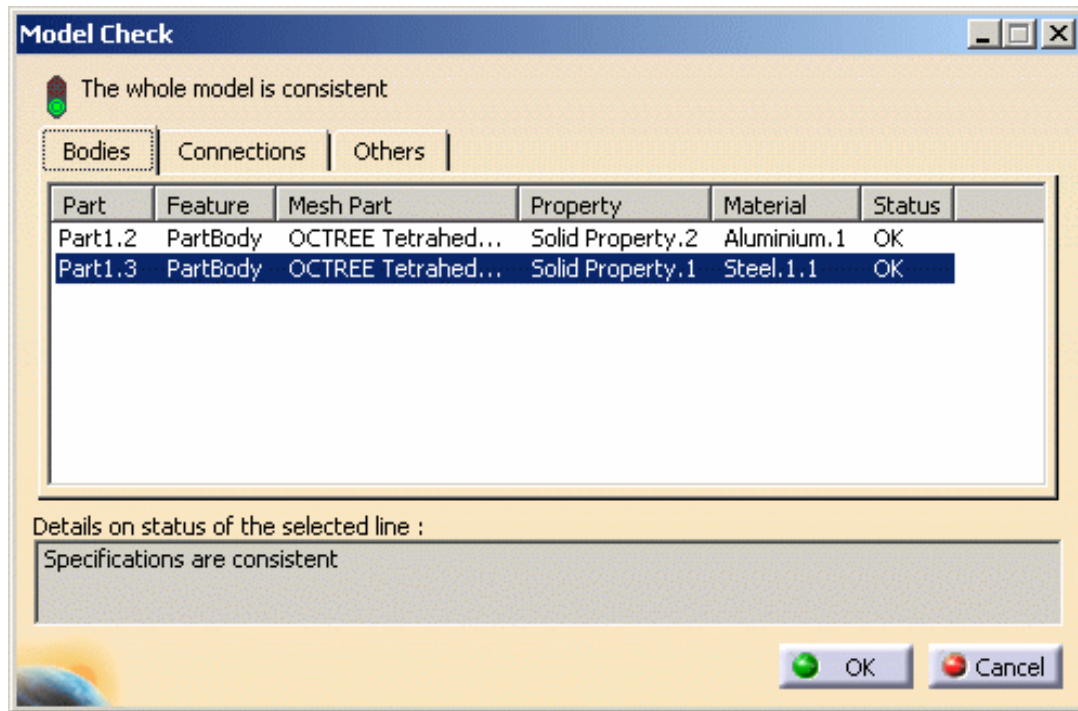

5. Click **OK** to leave the dialog box.



## Check on Connections

Check on connections means on any connection specification. In other words, you will check the consistency of the connections regarding the following: missing mesh parts, properties, materials ; connected supports with no associated mesh parts ; overlapping connections and so forth.

**Scenario:** You deleted the mesh part of a part that was connected to another



Open the [sample50.CATAnalysis](#) document from the samples directory.

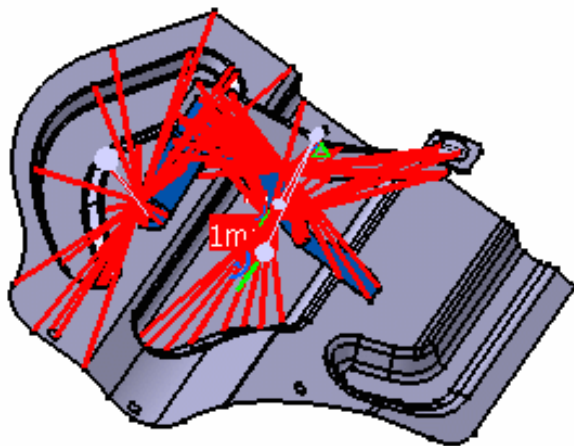
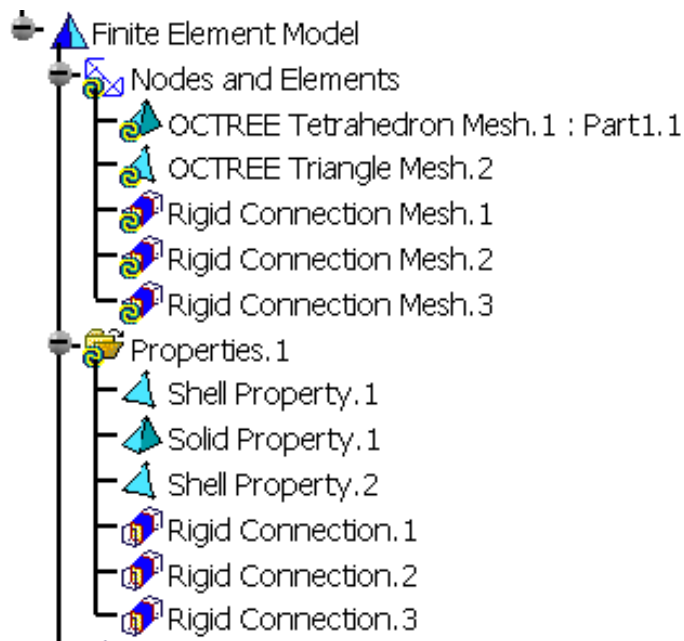

1. Click the **Model Check** icon  from the **Model Manager** toolbar.

The Model Check dialog box appears with the following tabs:

- **Bodies:** the lists of all the Mesh parts (1D, 2D, 3D) as well as their properties and supports.
- **Connections:** any connection specification
- **Others:** specification features (loads, restraints, virtual parts)

The Model Check dialog box and Connections tab display all the parts (one per line in the dialog box) which are assigned at least one connection:

- Mesh part and property assigned to this mesh part
- Connected mesh part
- Product to which the constraints was assigned
- Names of both mesh parts connected to each others
- Material (has no impact on Connection valid state).

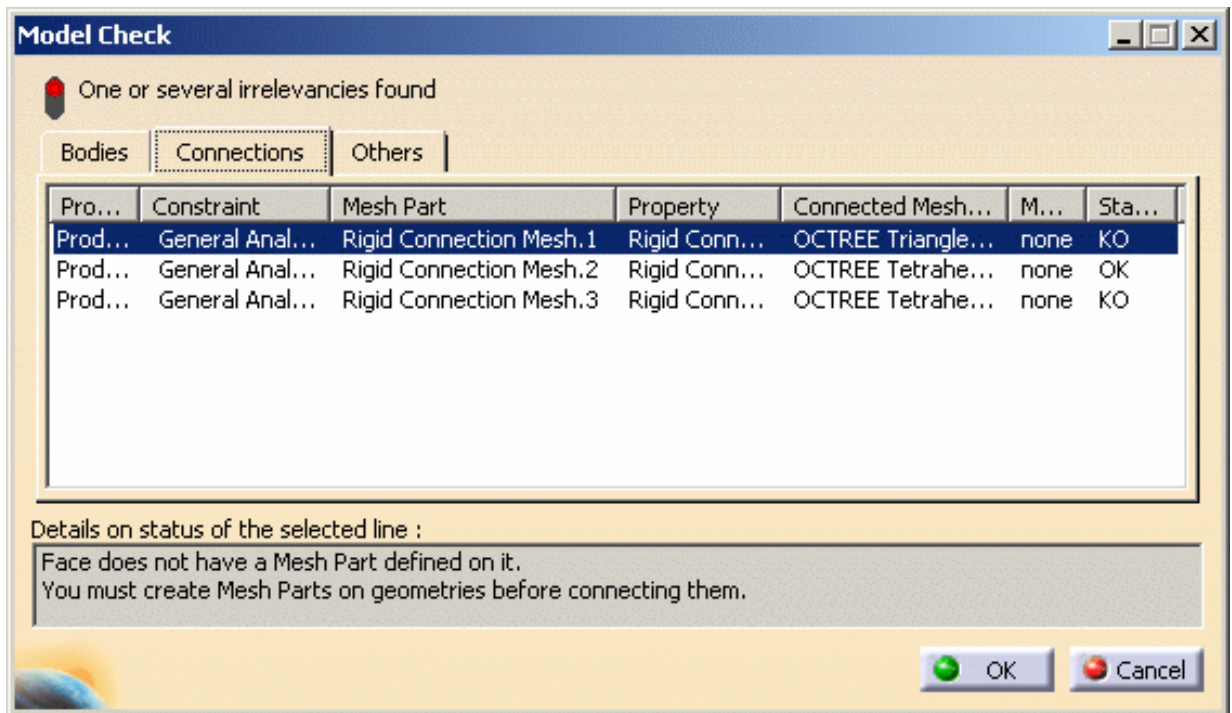

When you select a connected mesh part in the table, the corresponding features in the specification tree and in the model as well as the assigned properties, material and constraints are also highlighted.

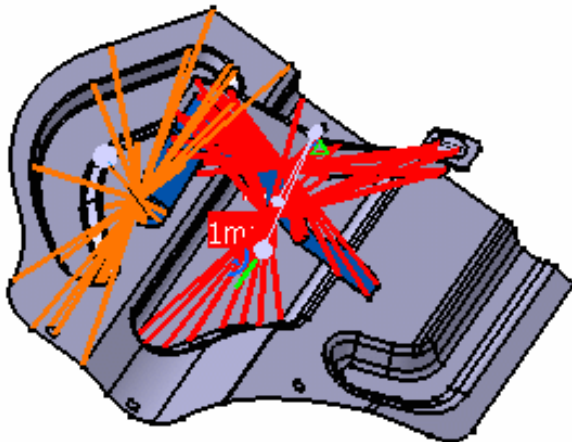

**In this particular case, Face does not have a Mesh Part defined on it.**

2. Click **OK** to leave the dialog box.
3. Create mesh parts on the geometry.



## Check on Others

Check on others means on specification features such as loads, restraints, virtual parts, masses and periodic conditions.

**Scenario:** You deleted the mesh part of a clamped part that was connected to another



Open [sample50.CATAnalysis](#) document.

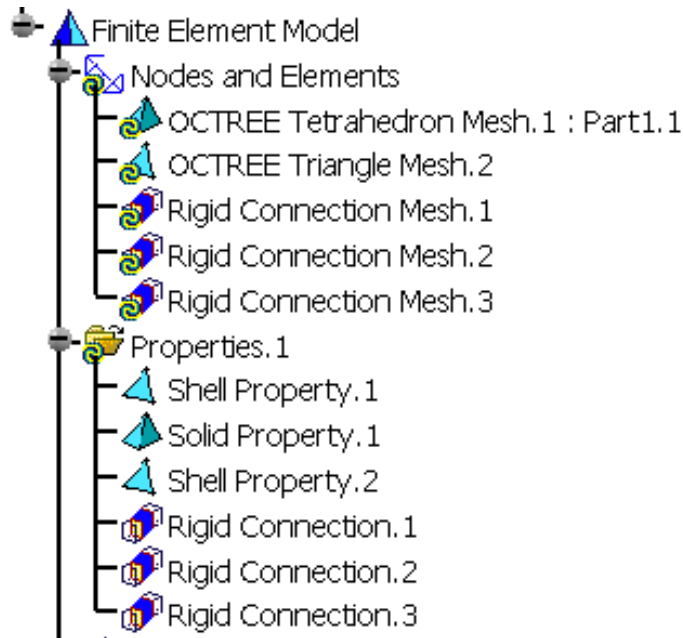

1. Click the **Model Check** icon  from the **Model Manager** toolbar.

The Model Check dialog box appears with the following tabs:

- o **Bodies:** the lists of all the Mesh parts (1D, 2D, 3D) as well as their properties and supports.
- o **Connections:** any connection specification
- o **Others:** specification features (loads, restraints, virtual parts)

2. Delete **OCTREE Tetrahedron Mesh.1 : Part1.1** feature in the specification tree.

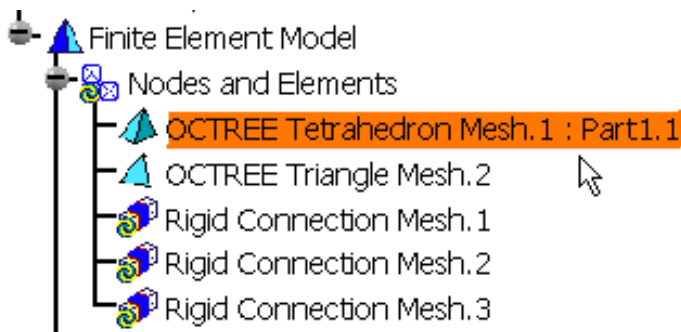

The Model Check dialog box and Others tab display all the specifications features (one per line in the dialog box) which are not correct as well as details on the status of the selected line. In this particular case, Clamp1 is KO as the part the clamp was assigned to has been deleted.

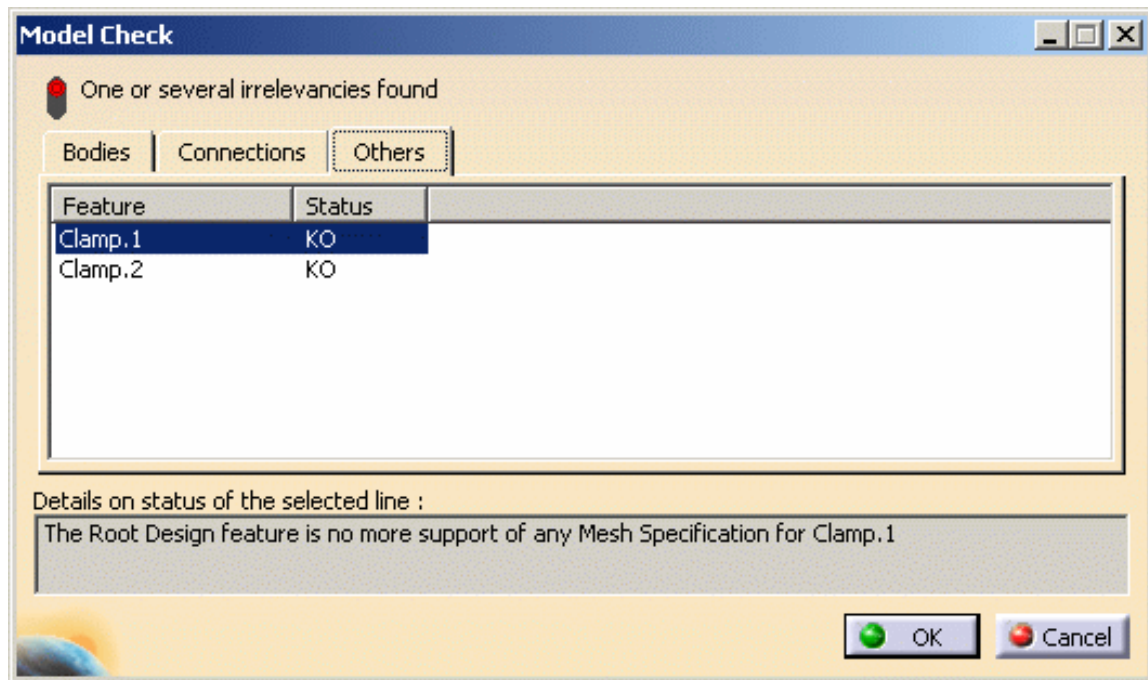

**In this particular case, the root design feature is no more support of any Mesh specification for Clamp.1 and Clamp.2.**

3. Click **OK** to leave the dialog box.

The solution is therefore to add the mesh part to the invalidated part.



# Adaptivity



The adaptive method implemented is the H-method.

At constant element order, the mesh is selectively refined (decrease element size) in such a way as to obtain a desired results accuracy. The mesh refining criteria are based on a technique called **predictive error estimation**, which consists of determining the distribution of a local error estimate field for a given Static Analysis Case.

As a result, the use of the adaptive method makes it possible to reduce the memory costs and the time costs.



Compute first the solution with parabolic elements.



[Create Global Adaptivity Specifications](#)

Generate global adaptive mesh refinement specifications.

[Create Local Adaptivity Specifications](#)

Generate a local adaptive mesh refinement specifications.

## Computing with Adaptivity



[Compute with Adaptivity](#)

Computing adaptive solutions.

# Creating Global Adaptivity Specifications



This task shows how to create an Adaptivity on a Mesh Part for a given Static Analysis Case Solution.



- The Adaptivity functionalities are only available with static analysis solution or a combined solution that references a static analysis solution.
- The former adaptivity specifications (created before V5R12) can be edited but they can not be computed with adaptativity.  
If you modify these specifications and launch a computation with adaptativity, a warning message informs you that these specifications will not be taken into account. You have to create new adaptativity specifications.



Open the [sample07.CATAnalysis](#) document from the samples directory.

## Before You Begin:

- Compute the solution.

For this:

- click the **Compute** icon 
- select the **All** option
- click **OK** in the Compute dialog box.



For more details, please refer to the [Compute Objects Sets](#).

- Optionally, you can generate an error map image to visualize the current error.

For this, click the **Precision** icon .



For more details, please refer to [Visualizing Precisions](#).

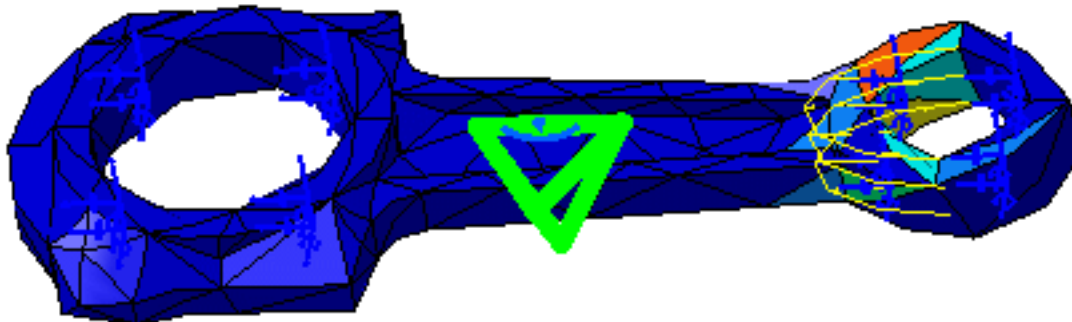





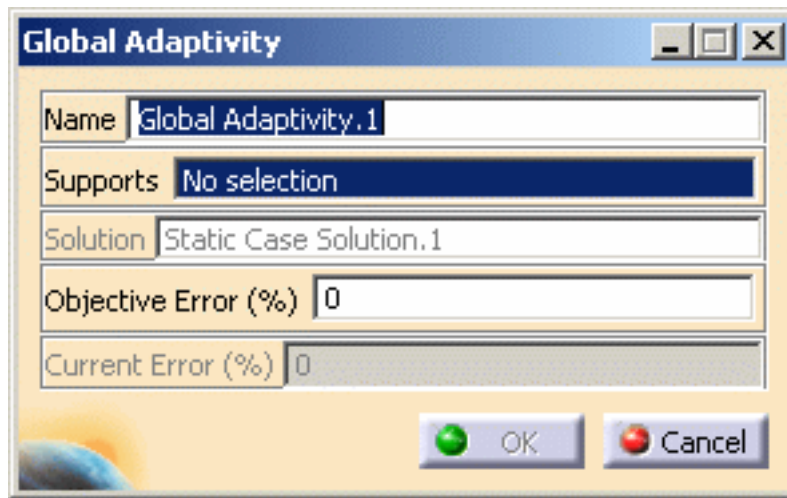

1. Click the **New Adaptivity Entity** icon .

The Global Adaptivity dialog box appears.



- **Name:** lets you change the name of the global adaptivity.
- **Supports:** lets you select the supports on which you want to refine the mesh.
  -  You can select as support one or several mesh part (Octree 2D or Octree 3D).
- **Solution:** gives you inform information on the referenced solution name.
- **Objective error (%):** lets you specify the objective error of the selected mesh part.
- **Current error (%):** gives you information on the current error of the selected mesh part.

2. Select the desired mesh part.

In this particular example, select the **OCTREE Tetrahedron Mesh.1: Part3** object under the **Nodes and Elements** set.

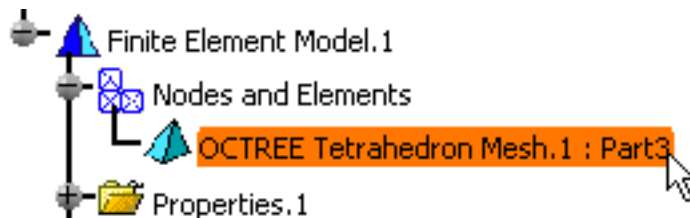

The Global Adativity dialog box is updated. You can now visualize the value (in %) of the current error.

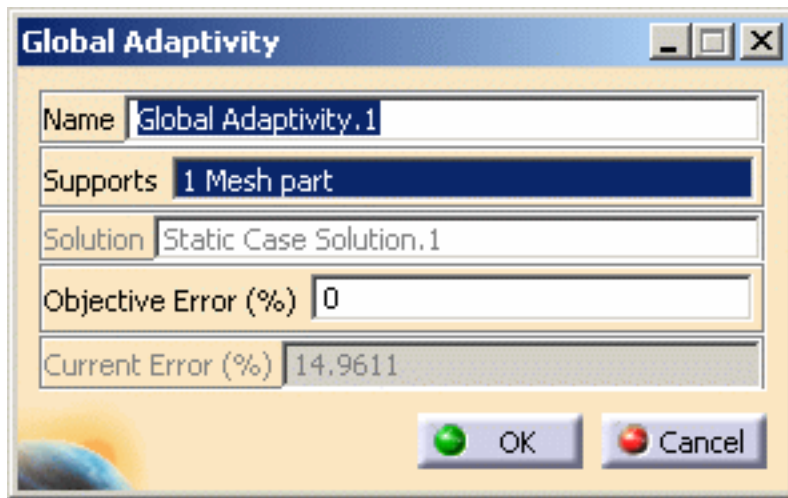

3. Enter the desired **Objective error (%)** value.

In this particular example, enter **9** as **Objective error (%)** value.

4. Click **OK** in the Global Adativity dialog box.

An **Adaptivities.1** set is created in the specification tree containing a **Global Adaptivity.1** object.

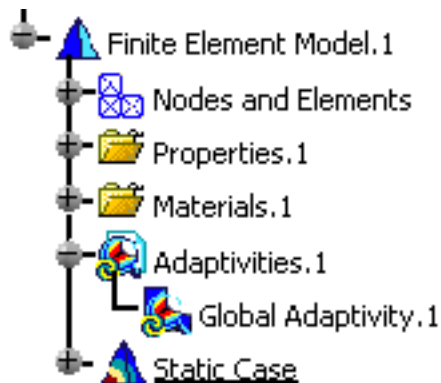

- You can edit the global adaptivity you just created. For this, double-click the **Global Adaptivity.1** object in the specification tree.
- You can create several Adaptivities objects associated to the same Static Solution and corresponding to the different mesh parts.



You can now compute the model with adaptivity (for more details, please refer to [Computing with Adpativity](#)) or create local adaptivity specifications (for more details, please refer to [Creating Local Adpativity Specifications](#)).



# Creating Local Adaptivity Specifications



This task shows how to create a local adaptivity on a Mesh Part for a given Static Analysis Case Solution.



This functionality is only available if you installed the ELFINI Structural Analysis product.



- The Adaptivity functionalities are only available with static analysis solution or a combined solution that references a static analysis solution.
- A global adaptivity must have been defined.



For more details about global adaptivity, please refer to [Creating Global Adaptivity Specifications](#).



Open the [sample07\\_1.CATAnalysis](#) document from the samples directory.  
In this particular example, a global adaptivity has been already defined.



1. Right-click the **Global Adaptivity.1** object in the specification tree and select the **Local**



Local Adaptivity

Adaptivity contextual menu

The Local Adaptivity dialog box appears.

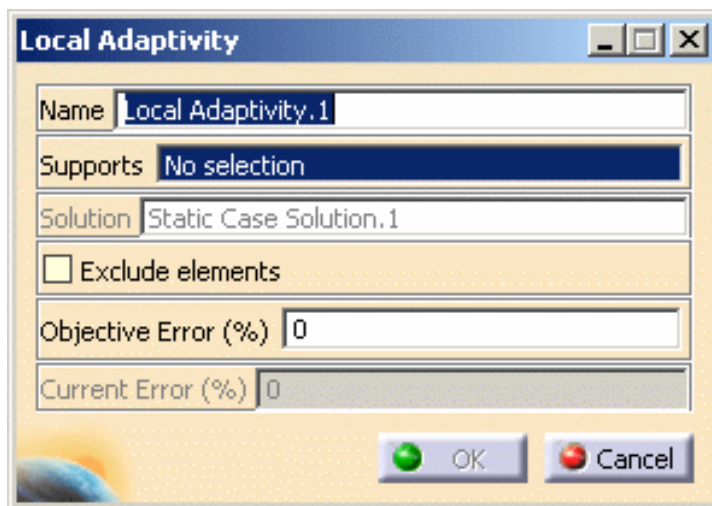

- **Name:** lets you change the name of the local adaptivity.
- **Supports:** gives you the list of the selected elements.
  - Multi-selection is available: you can select as support one or several vertices, edges, faces or group (except body group). This multi-selection may be non-homogeneous (that means that you can select two edges and three faces, as example).
- **Solution:** gives you inform information on the referenced solution.
- **Exclude elements:** if you select this option, the selected elements will not have an objective error and then, the **Objective error (%)** field will disappear. In this case, elements will not be taken into account in the re-meshing algorithm.
- **Objective error (%):** lets you specify the objective error of the selected mesh part.
  - This option is available only if the **Exclude elements** is deactivated.

- o **Current error (%)**: gives you information on the current error of the selected support.

**2.** Select the desired elements as support.

In this particular example, select one edge and two surfaces:

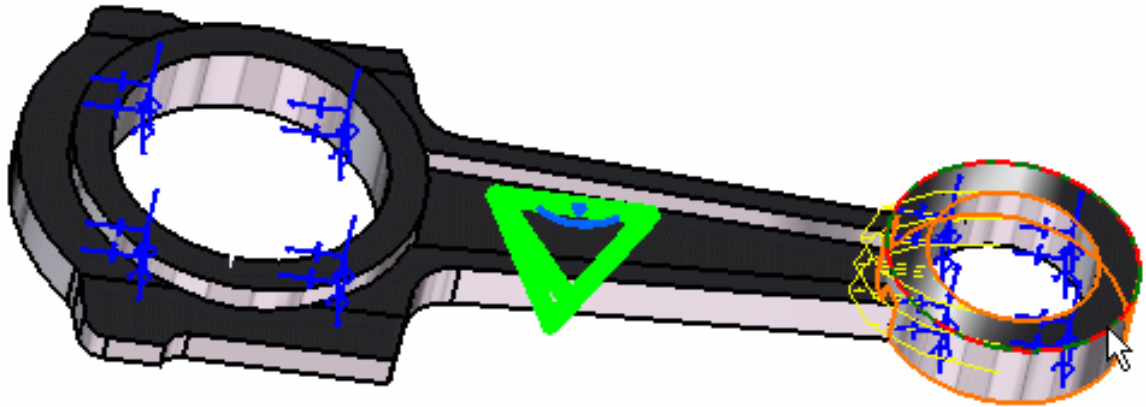

The Local Adativity dialog box is updated. You can now visualize the value (in %) of the current error (on the condition you have not activate the **Exclude elements** option).

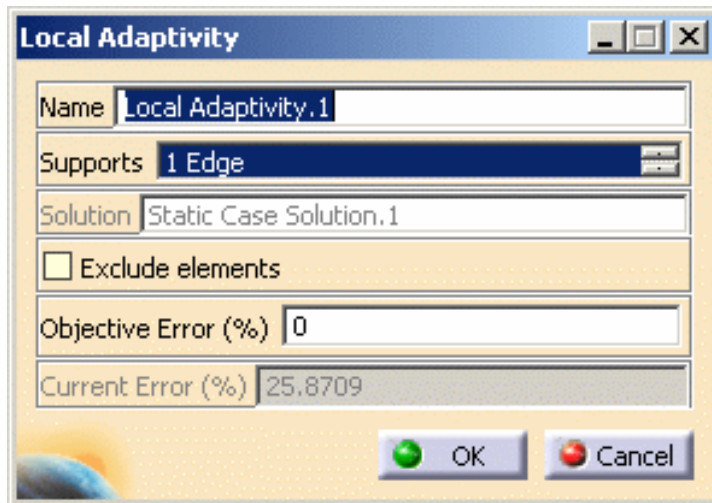

You can visualize the other selected elements of the **Supports** list by clicking the arrows as shown here:

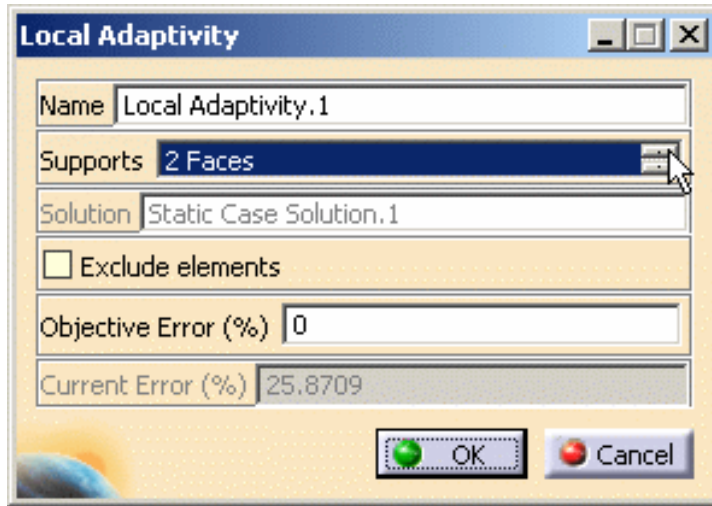

3. Enter the desired **Objective error (%)** value.

In this particular example, enter **20** as **Objective error (%)** value.

4. Click **OK** in the Local Adativity dialog box.

An **Local Adaptivity.1** object is created under the **Adaptivities.1** set in the specification tree.



You can edit the local adaptivity.

For this, double-click the **Local Adaptivity.1** object in the specification tree.



# Computing with Adaptivity



This task shows how to compute with adaptivity.

Adaptivity management consists of setting global adaptivity specifications and computing adaptive solutions.



- The Adaptivity functionalities are only available with a static analysis solution or a combined solution that references a static analysis solution.
- To compute with adaptivity, you need to update the solution(s).
- A global adaptivity and optionally a local adaptivity must have been defined.
- The former adaptivity specifications (created before V5R12) can be edited but they can not be computed with adaptivity.  
If you modify these specifications and launch a computation with adaptativity, a warning message informs you that these specifications will not be taken into account. You have to create new adaptativity specifications.



- Open the [sample07\\_2.CATAnalysis](#) document from the samples directory.

In this particular example, a global adaptivity and a local adaptivity have been already defined.

- Compute the static solution.



1. Activate the **Estimated local error** image to visualize the quality elements.

For this, right-click the **Estimated local error** image in the specification tree and select the **Activate/Deactivate** contextual menu.

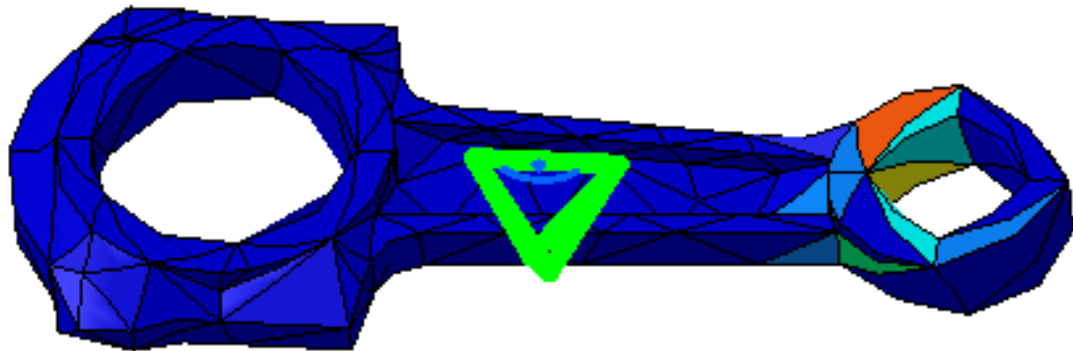

2. Double-click the **Global Adaptivity.1** object in the specification tree to visualize the current error.

The Global Adaptivity appears.

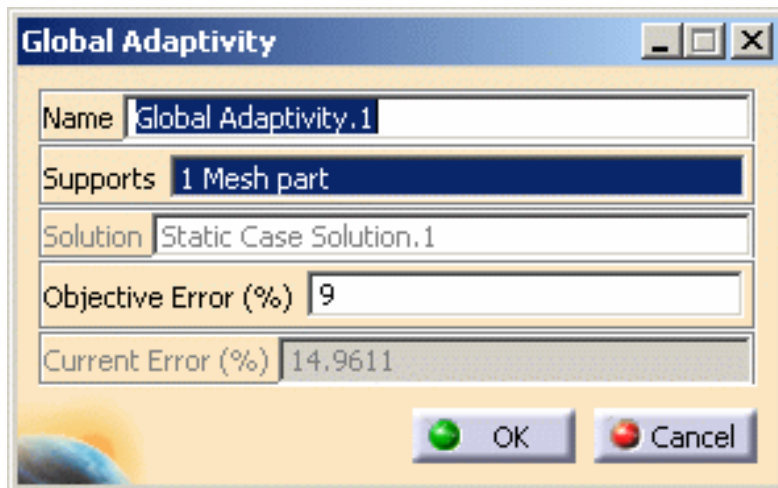

Click **Cancel** to close the Global Adaptivity dialog box.

3. Double-click the **Local Adaptivity.1** object in the specification tree.

The Local Adaptivity appears.

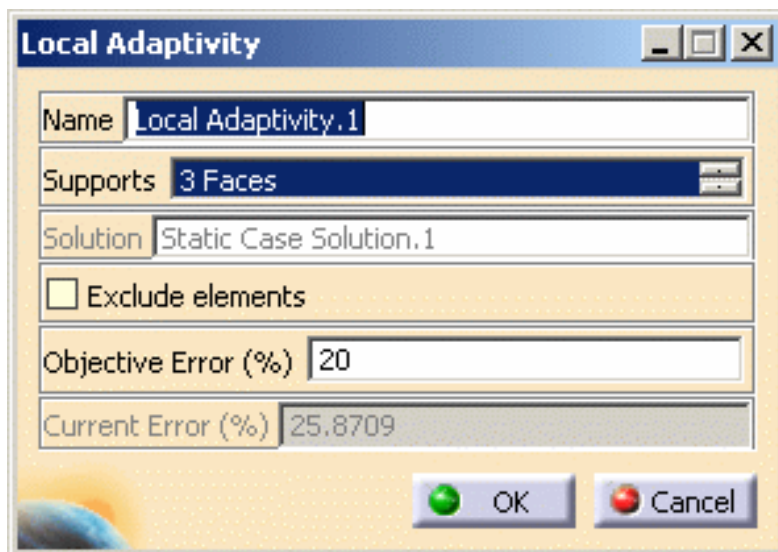

Click **Cancel** to close the Local Adaptivity dialog box.

4. Click the **Compute with Adaptivity** icon .

The Adaptivity Process Parameters dialog box appears.

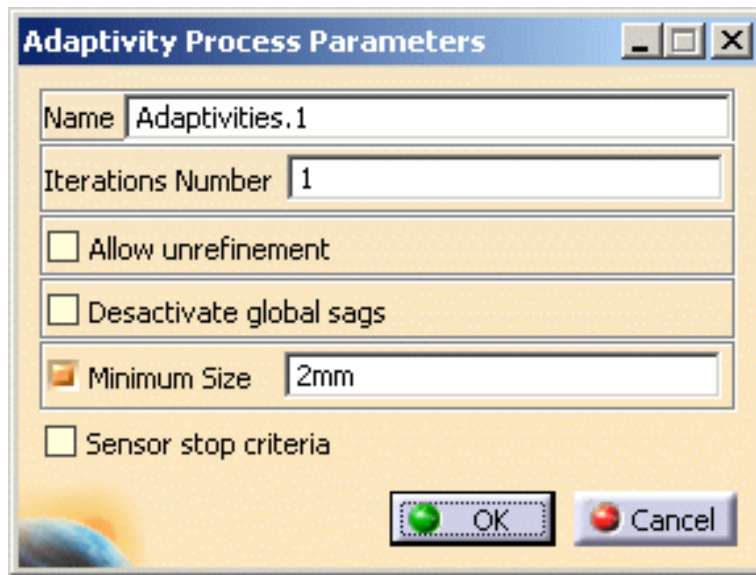

- **Name:** gives you the name of the adaptivity set you want to compute.
- **Iterations Number:** lets you specify the maximum number of iterations you want to perform to reach the objective error you have defined.
- **Allow unrefinement:** lets you choose to allow refinement or not.
  - ⚠ If you allow unrefinement, the global sizes of the mesh parts may be modified.
- **Deactivate global sags:** lets you choose to ignore the global sags.
  - ⚠ Existing global sags will be deactivated.
- **Minimum size:** lets you specify a minimum mesh size.
  - ⚠ The objective size must be superior to the mesh size.
- **Sensor stop criteria:** lets you specify a sensor.



If you activate this option, the **Parameter Convergence** frame appears:

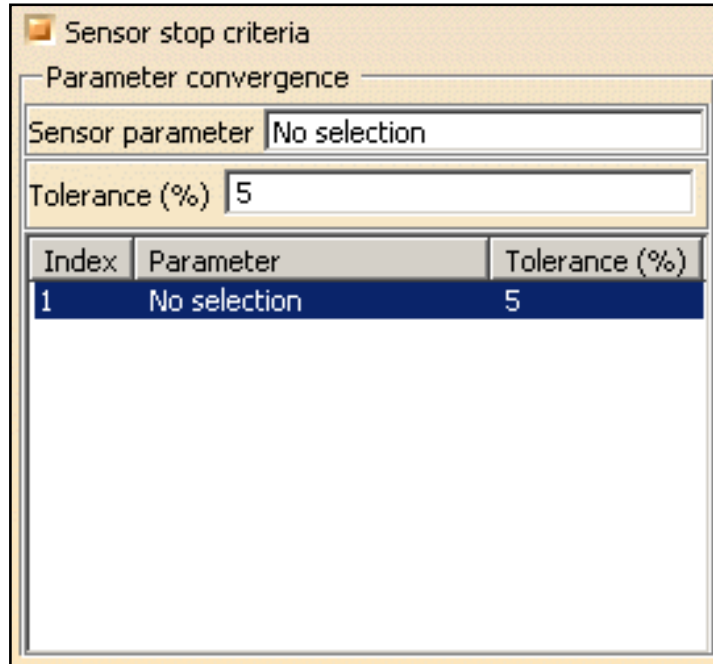

Index	Parameter	Tolerance (%)
1	No selection	5

- **Sensor parameter:** lets you select the sensors.



Multi-selection of sensor criteria is available.

- **Tolerance (%):** lets you specify the tolerance value.

To sum up, the adaptivity process stops as soon as:

- the maximum number of iterations is reached,
- or all objective errors are reached,
- or all sensors converged.

**5.** Deactivate the **Minimum size** option.

**6.** Select the **Sensor stop criteria** option in the Adaptivity Process Parameters dialog box.

**7.** Activate the **Sensor parameter** field, select a sensor and enter a **Tolerance** value (in %).

In this particular example, select the **Energy** sensor as shown bellow:

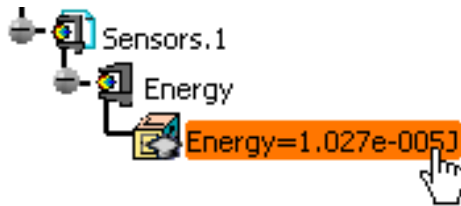

You can add other sensor criteria, delete a sensor criteria or delete all the sensor criteria.

For this, right-click a line and select the desired contextual menu: **Add**, **Delete** or **Delete All**.

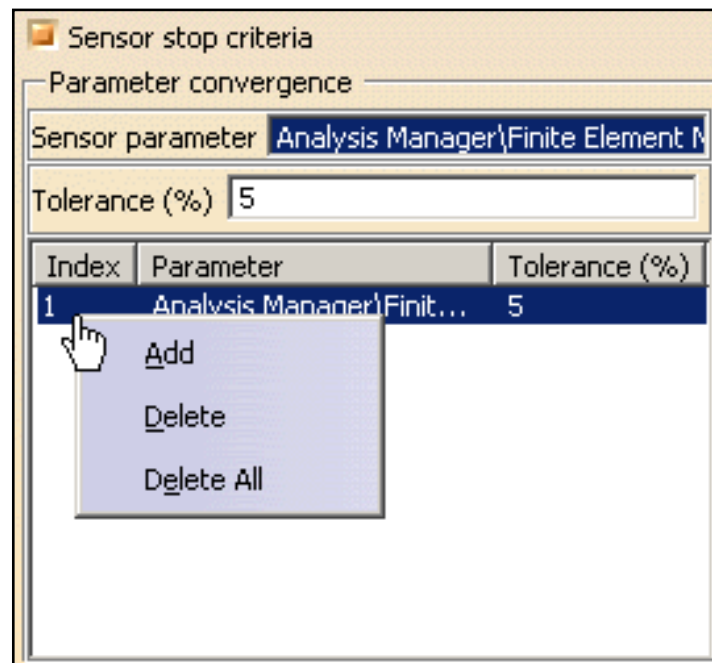

**8.** Click **OK** in the Adaptivity Process Parameters dialog box.

The Computation Status dialog box appears.

At the end of the computation, a Warnings message appears to inform you that the selected sensor has not converged and the objective error is not reached.

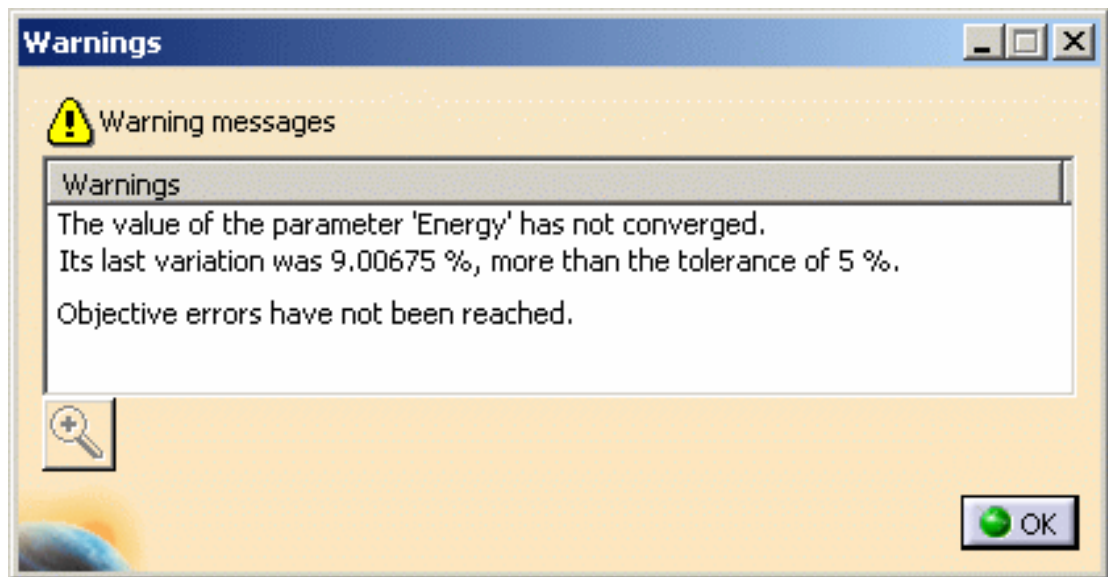

9. Click **OK** in the Warnings message.

Note that a **Local Mesh Size Map.1** object has been created under **OCTREE Tetrahedron Mesh.1 : Part3** **Tetrahedron Mesh.1** in the specification tree and that the **Adaptivities.1** set is now valid.

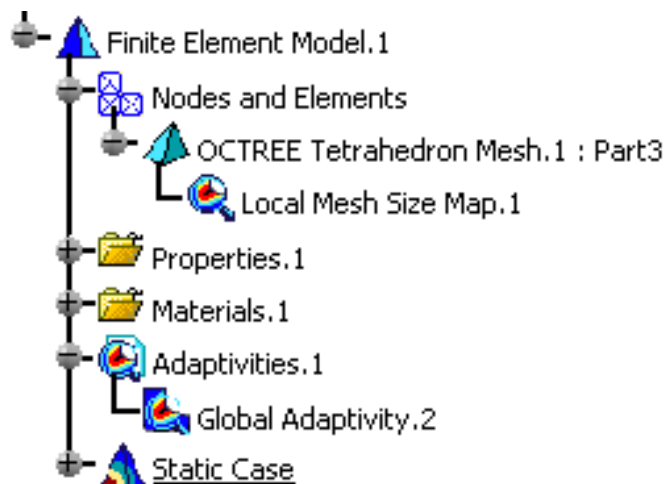

10. Activate the **Estimated local error** image to visualize the quality elements.

For this, right-click the **Estimated local error** image in the specification tree and select the **Activate/Deactivate** contextual menu.

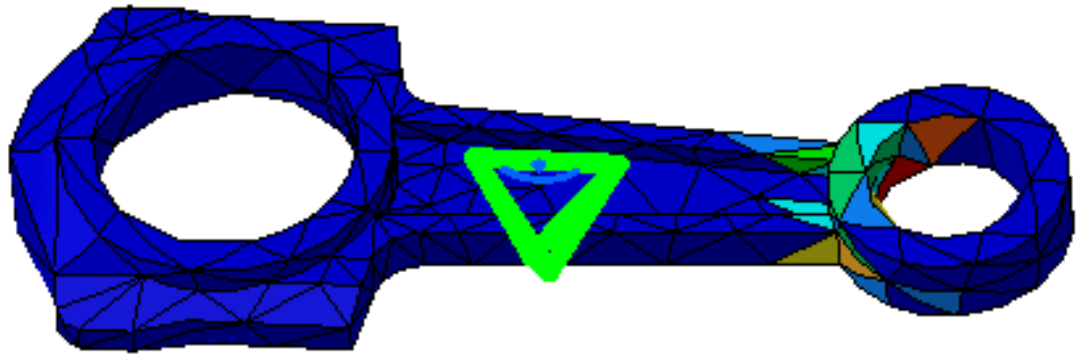

11. Double-click the **Global Adaptivity.1** object in the specification tree to visualize the current error value.

The Global Adaptivity dialog box appears.

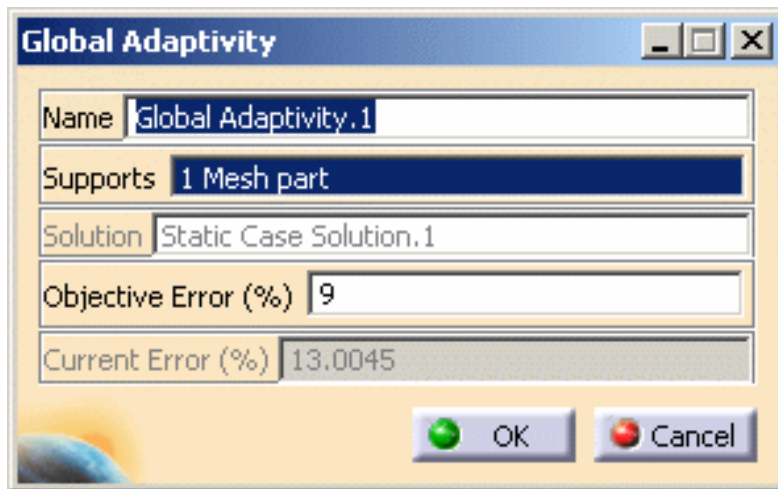

Note that: after the first iteration of computation with adaptivity, the objective error you have specified (**9%**) is not reached.

12. Click **OK** in the Global Adaptivity dialog box.

13. Click the **Compute with Adaptivity** icon .

The Adaptivity Process Parameters dialog box appears.

14. Enter **2** as **Iterations Number** value and click **OK** in the Adaptivity Process.

15. Double-click the **Global Adaptivity.1** object in the specification tree to visualize the current error value.

The Global Adaptivity dialog box appears.

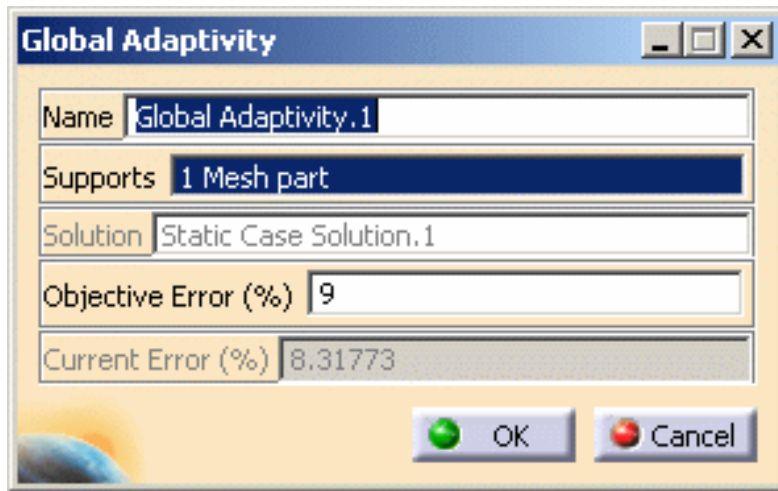

The objective global error you have specified is reached.

16. Double-click the **Local Adaptivity.1** object in the specification tree.

The Local Adaptivity appears.

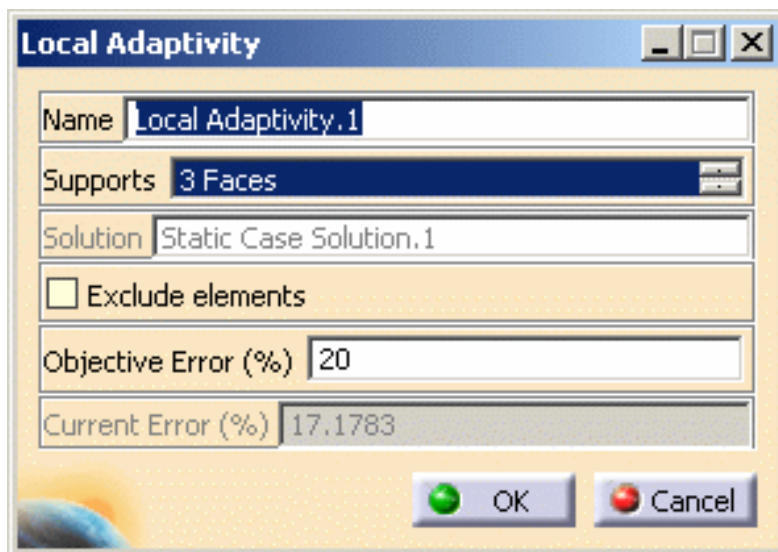

The objective local error you have specified is reached.

17. Activate the **Estimated local error** image to visualize the quality elements.

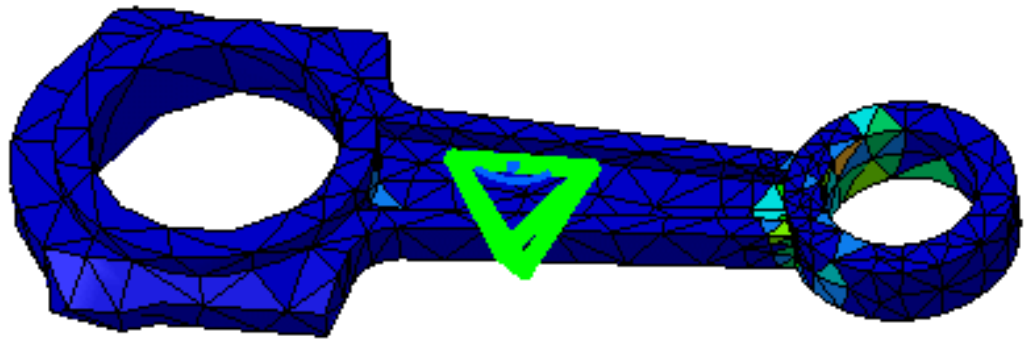

# Groups



Grouping elements allows you to apply pre-processing specifications to a pre-defined group of elements (points, lines, surfaces or bodies) and to generate images from this group.

## Geometrical Groups



### Group Points

Create groups of points. 



### Group Lines

Create groups of lines. 



### Group Surfaces

Create groups of surfaces. 



### Group Bodies

Create groups of bodies. 

## Free Groups



### Box Group

Create groups based on box. 



### Sphere Group

Create groups based on sphere. 

## Proximity Groups



### Group Point by Neighborhood

Create proximity point groups. 



### Group Line by Neighborhood

Create proximity line groups.



### Group Surface by Neighborhood

Create proximity surface groups.



## Update

### Update Groups

Update a group or a group set.

### Analyze Group

Analyze and display the nodes, elements, faces of element and edges element of a group.



# Grouping Points



This task shows how to group points and how to generate images from this group.

Grouping elements allows you to apply pre-processing specifications to a pre-defined group of elements (points, lines, surfaces or bodies) and to generate images from this group.



This functionality is only available if you installed the **ELFINI Structural Analysis (EST)** product.



Open the [sample49.CATAnalysis](#) document from the samples directory for this task.

## Before You Begin

Go to **View -> Render Style -> Customize View** and make sure the **Shading, Outlines** and **Materials** options are active in the Custom View Modes dialog box.



1. Click the **Point Group** icon .

The Point Group dialog box appears.

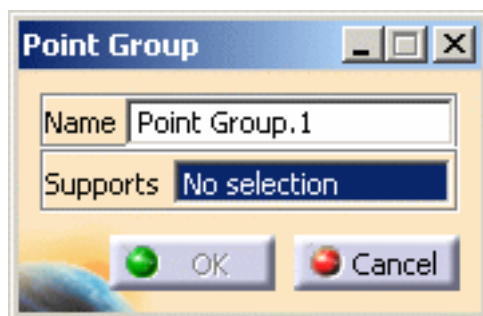

2. Select in sequence the points you want to group.

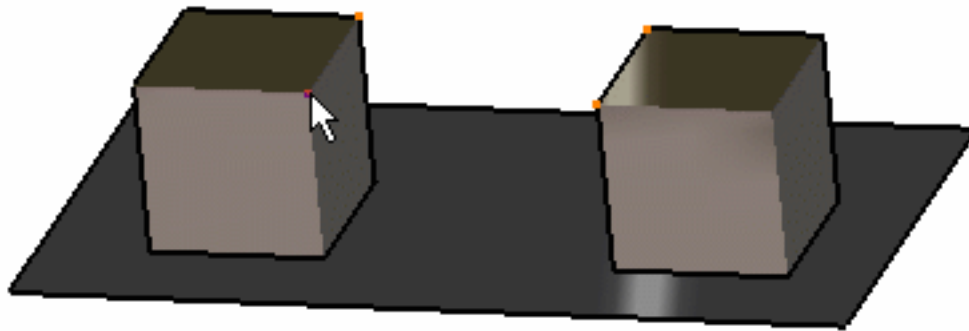

The Point Group dialog box is updated.

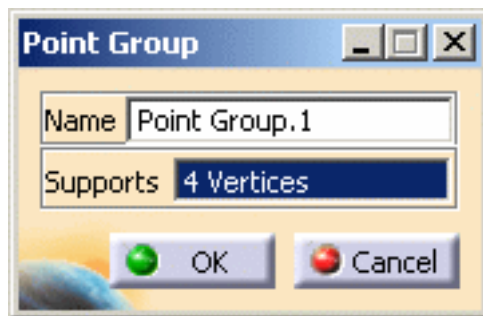

3. Click **OK** in the Point Group dialog box.

A **Point Group.1** object appears in the specification tree but it is not updated.



4. Update the Point Group.

For more details, please refer to [Updating a Group](#).

You can now visualize Deformation, Von Mises Stresses, Displacements, Principal Stresses and Precisions images, either for all the geometry or only for the selected points. The scenario is the same for the five images.

In this particular case, you will visualize the Von Mises Stresses image:

5. Activate the Von Mises Stress image.

For this, right-click the **Von Mises Stress (nodal value)** object in the specification tree and select the **Activate/Deactivate** option.

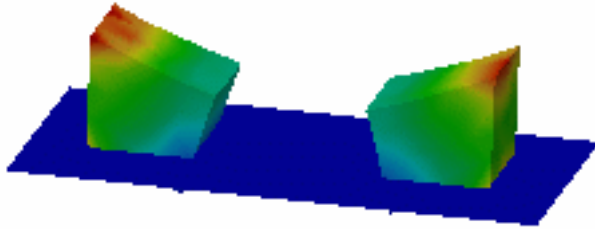

6. Double-click the **Von Mises Stress (nodal value)** object in the specification tree.

The Image Edition dialog box appears.

7. Double-click the **Point Group.1** object in the **Selections** tab and click **OK** in the Image Edition dialog box.

You will see the result only for the points belonging to the point group.



For more details about images, please refer to [Results Visualization](#) (Image Creation, Generate Images and Editing Images).



You can manually edit or delete a group.

For this, right-click the group object in the specification tree and select the desired contextual menu.



# Grouping Lines



This task shows how to group lines and how to generate images from this group.

Grouping elements allows you to apply pre-processing specifications to a pre-defined group of elements (points, lines, surfaces or bodies) and to generate images from this group.



This functionality is only available if you installed the **ELFINI Structural Analysis (EST)** product.



Open the [sample49.CATAnalysis](#) document from the samples directory for this task.

## Before You Begin

Go to **View -> Render Style -> Customize View** and make sure the **Shading, Outlines** and **Materials** options are active in the Custom View Modes dialog box.



1. Click the **Line Group** icon .

The Line Group dialog box appears.

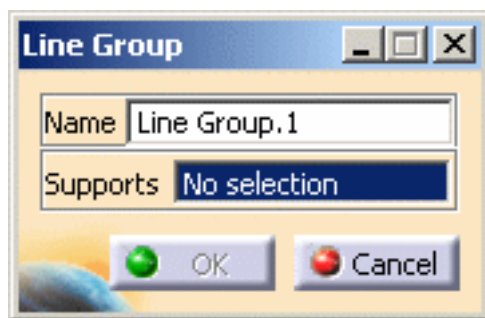

2. Select in sequence the lines you want to group.

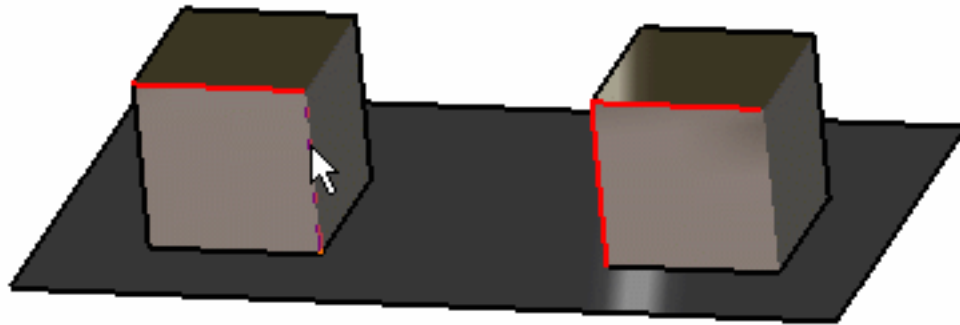

The Line Group dialog box is updated.

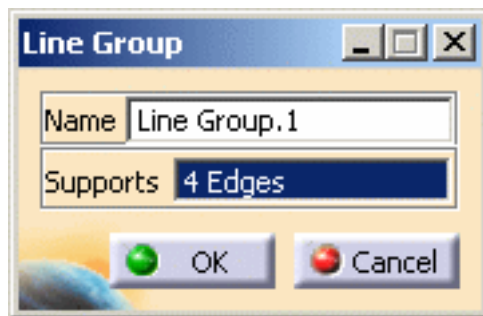

3. Click **OK** in the Line Group dialog box.

A **Line Group.1** object appears in the specification tree but it is not updated.



4. Update the Line Group.

For more details, please refer to [Updating a Group](#).

You can now visualize Deformation, Von Mises Stresses, Displacements, Principal Stresses and Precisions images, either for all the geometry or only for the selected lines. The scenario is the same for the five images.

In this particular case, you will visualize the Von Mises Stresses image:

5. Activate the Von Mises Stress image.

For this, right-click the **Von Mises Stress (nodal value)** object in the specification tree and select the **Activate/Deactivate** option.

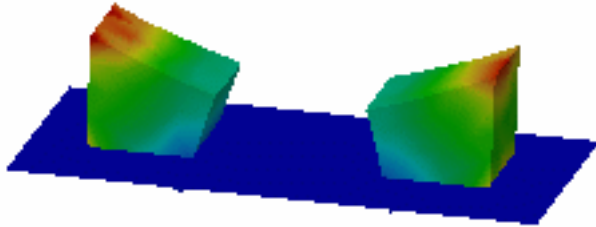

6. Double-click the **Von Mises Stress (nodal value)** object in the specification tree.

The Image Edition dialog box appears.

7. Double-click the **Line Group.1** object in the **Selections** tab and click **OK** in the Image Edition dialog box.

You will see the result only for the lines belonging to the line group.



For more details about Images, please refer to [Results Visualization](#) (Image Creation, Generate Images and Editing Images).



You can manually edit or delete a group. For this, right-click the group object in the specification tree and select the desired contextual menu.



# Grouping Surfaces



This task shows how to group surfaces and how to generate images from this group.

Grouping elements allows you to apply pre-processing specifications to a pre-defined group of elements (points, lines, surfaces or bodies) and to generate images from this group.



This functionality is only available if you installed the **ELFINI Structural Analysis (EST)** product.



Open the [sample49.CATAnalysis](#) document from the samples directory for this task.

## Before You Begin

Go to **View -> Render Style -> Customize View** and make sure the **Shading, Outlines** and **Materials** options are active in the Custom View Modes dialog box.



1. Click the **Surface Group** icon .

The Surface group dialog box appears.



2. Select in sequence the surfaces you want to group.

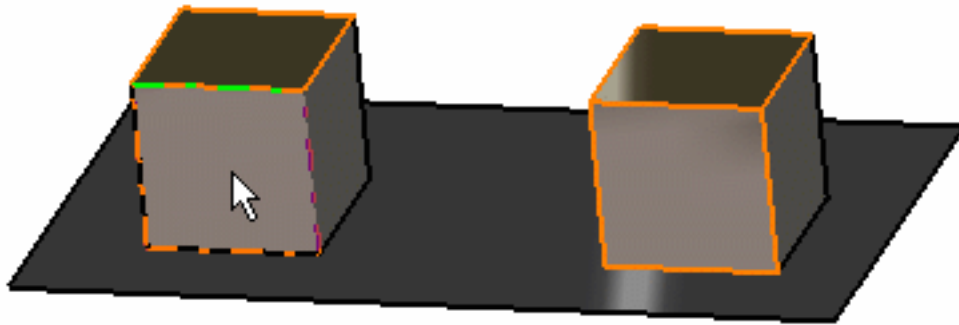

The Surface Group dialog box is updated.

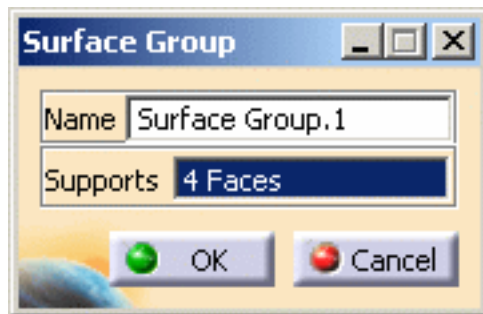

3. Click **OK** in the Surface Group dialog box.

A **Surface Group.1** object appears in the specification tree but it is not updated.



4. Update the Surface Group.

For more details, please refer to [Updating a Group](#).

You can now visualize Deformation, Von Mises Stresses, Displacements, Principal Stresses and Precisions images, either for all the geometry or only for the selected surfaces. The scenario is the same for the five images.

In this particular case, you will visualize the Von Mises Stresses image:



5. Activate the Von Mises Stress image.

For this, right-click the **Von Mises Stress (nodal value)** object in the specification tree and select the **Activate/Deactivate** option.

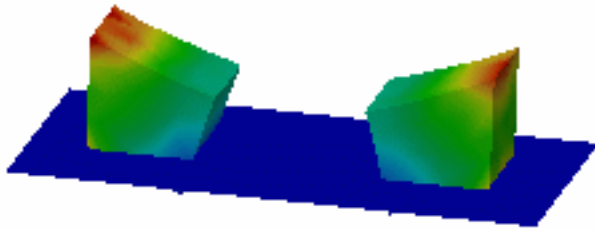

6. Double-click the **Von Mises Stress (nodal value)** object in the specification tree.

The Image Edition dialog box appears.

7. Double-click the **Surface Group.1** object in the **Selections** tab and click **OK** in the Image Edition dialog box.

You will see the result only around the surfaces belonging to the surface group.



For more details about Images, please refer to [Results Visualization](#) (Image Creation, Generate Images and Editing Images).



You can manually edit or delete a group. For this, right-click the group object in the specification tree and select the desired option in the contextual menu.



# Grouping Bodies



This task shows how to group bodies and how to generate images from this group.

Grouping elements allows you to apply pre-processing specifications to a pre-defined group of elements (points, lines, surfaces or bodies) and to generate images from this group.



This functionality is only available if you installed the **ELFINI Structural Analysis (EST)** product.



Open the [sample49.CATAnalysis](#) document from the samples directory for this task.

## Before You Begin

Go to **View -> Render Style -> Customize View** and make sure the **Shading, Outlines** and **Materials** options are active in the Custom View Modes dialog box.



1. Click the **Body Group** icon .

The Body Group dialog box appears.



2. Select in sequence the bodies you want to group.

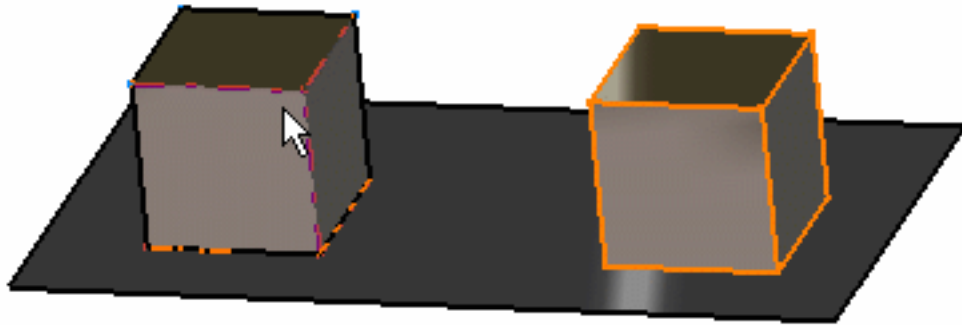

The Body Group dialog box is updated.



3. Click OK in the Body Group dialog box.

A **Body Group.1** object appears in the specification tree but it is not updated.



4. Update the Body Group.

For more details, please refer to [Updating a Group](#).

You can now visualize Deformation, Von Mises Stresses, Displacements, Principal Stresses and Precisions images, either for all the geometry or only for the selected bodies. The scenario is the same for the five images.

In this particular case, you will visualize the Von Mises Stresses image:

5. Activate the Von Mises Stress image.

For this, right-click the **Von Mises Stress (nodal value)** object in the specification tree and select the **Activate/Deactivate** option.

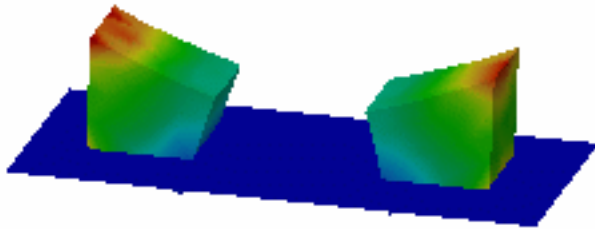

6. Double-click the **Von Mises Stress (nodal value)** object in the specification tree.

The Image Edition dialog box appears.

7. Double-click the **Body Group.1** object in the **Selections** tab and click **OK** in the Image Edition dialog box.

You will see the result only around the bodies belonging to the body group.

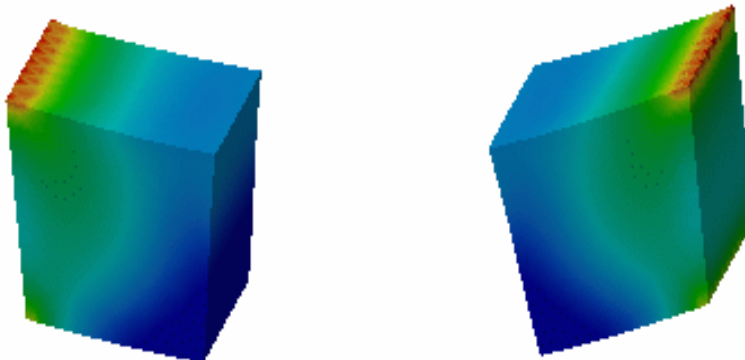

For more details about Images, please refer to [Results Visualization](#) (Image Creation, Generate Images and Editing Images).



You can manually edit or delete a group. For this, right-click the group object in the specification tree and select the desired option in the contextual menu.



# Box Group



This task shows how to group using a box and how to generate images from this group.

Grouping elements allows you to apply pre-processing specifications to a pre-defined group of elements and to generate images from this group.



This functionality is only available if you installed the **ELFINI Structural Analysis (EST)** product.



Open the [sample49.CATAnalysis](#) document from the samples directory for this task.

## Before You Begin

Go to **View -> Render Style -> Customize View** and make sure the **Shading, Outlines** and **Materials** options are active in the Custom View Modes dialog box.



1. Click the **Box Group** icon .

A box and the Box Group dialog box appear.

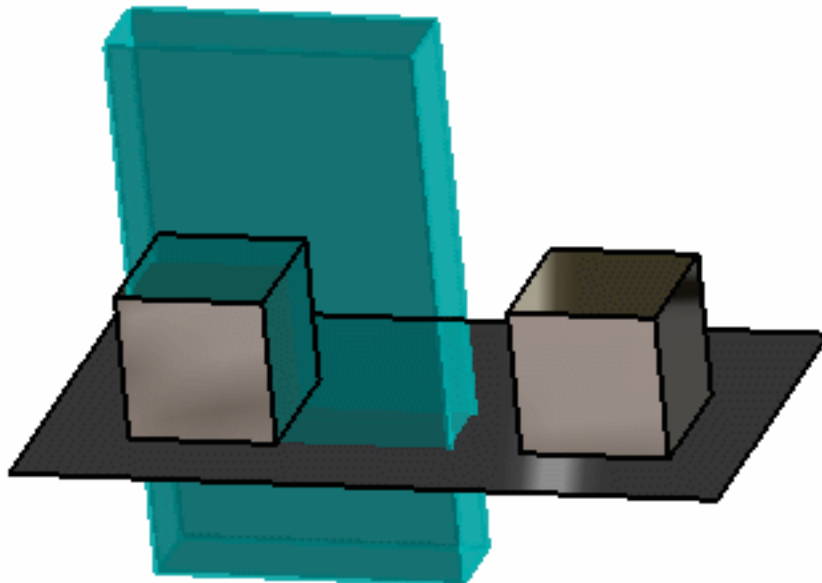



- **Name:** lets you change the name of the box group.
- **Inactive/Active box:** lets you respectively use a pre-defined box or position and resize manually a box using the compass and the manipulators.
- **Select an extremum:** lets you choose to position the box round an existing extremum.

**2.** Activate the box.

For this, select the button as shown bellow:



The status of the box position and dimension can now be edited.



The compass and manipulators (red points) are now available to let you position and resize the box.

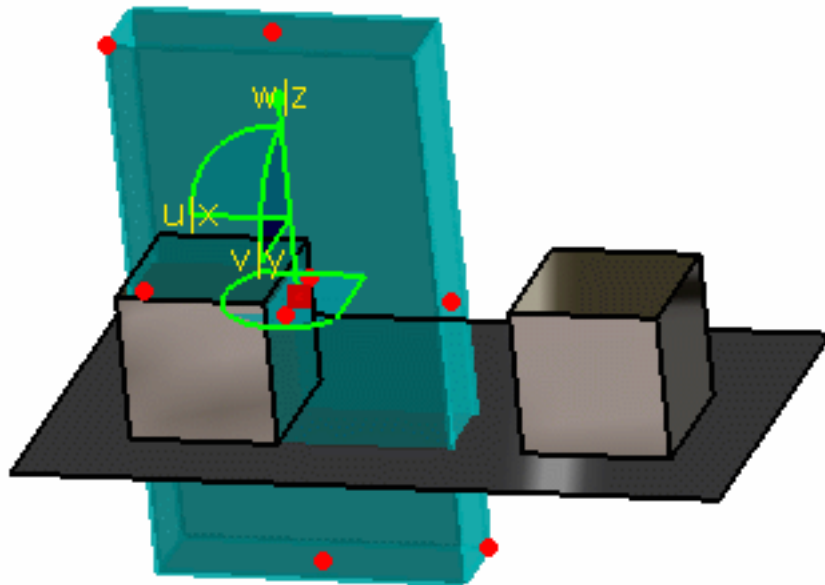

**3.** Change the position of the box.

For this, select the compass, drag and drop it to the desired position.

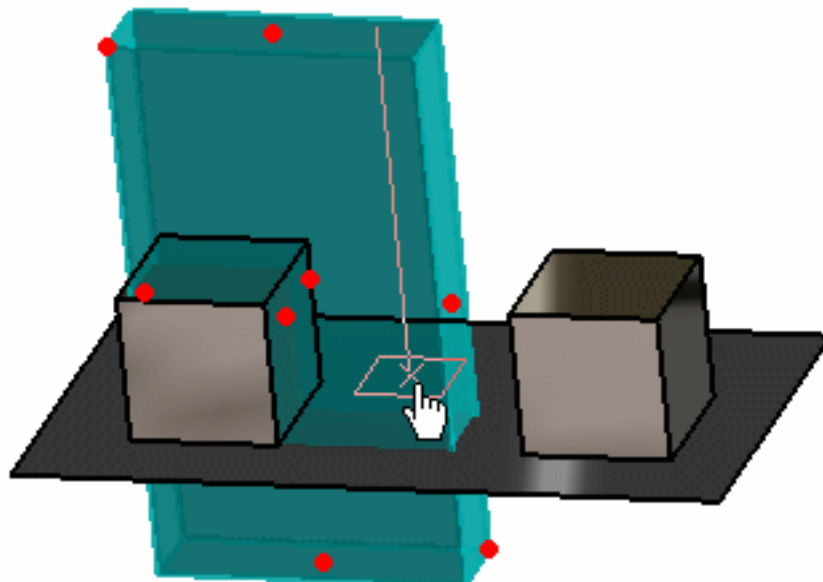

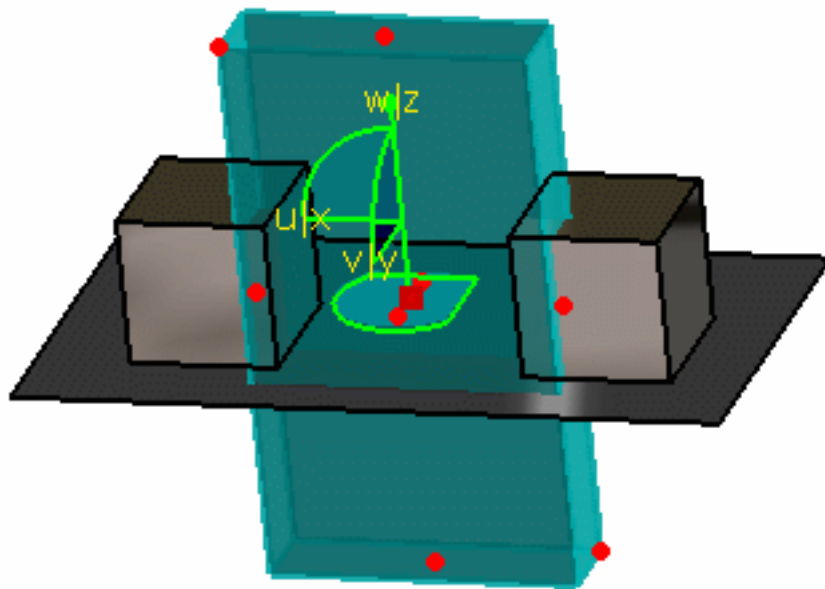

4. Resize the box.

For this, select a manipulator, drag and drop it to the desired position.

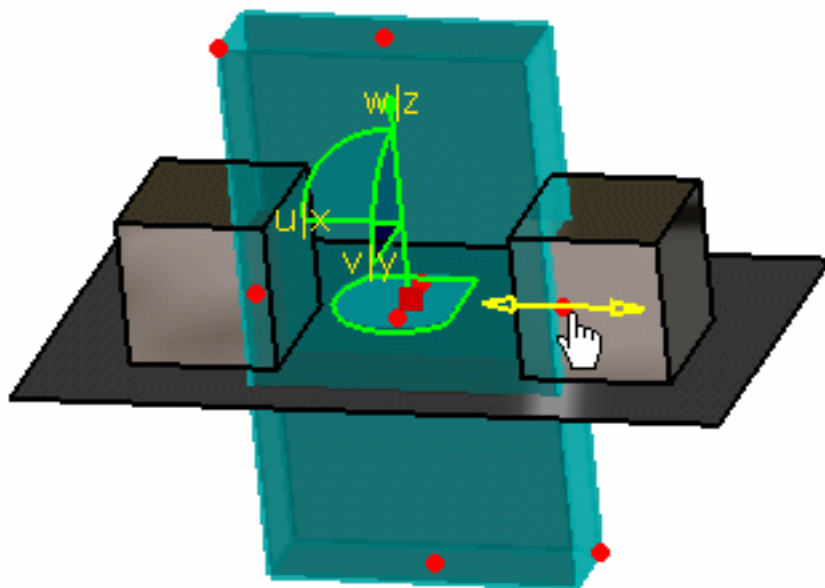



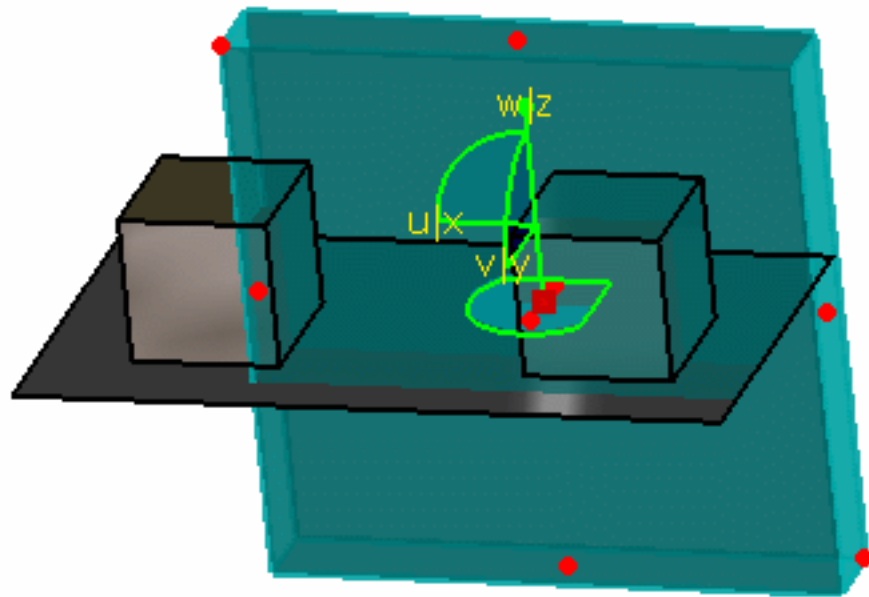

5. Click the **Select an extremum** button in the Box Group dialog box.
6. Select an existing extremum in the specification tree.

In this particular example, select the **Global Minimum.2** object.

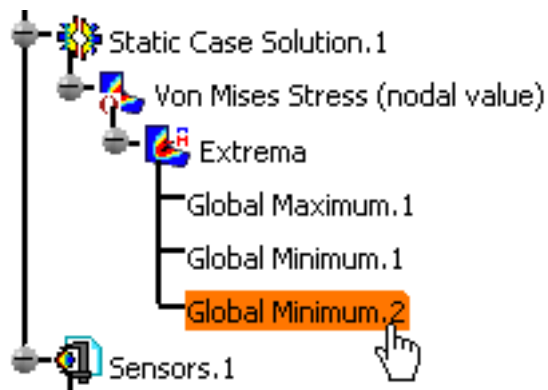

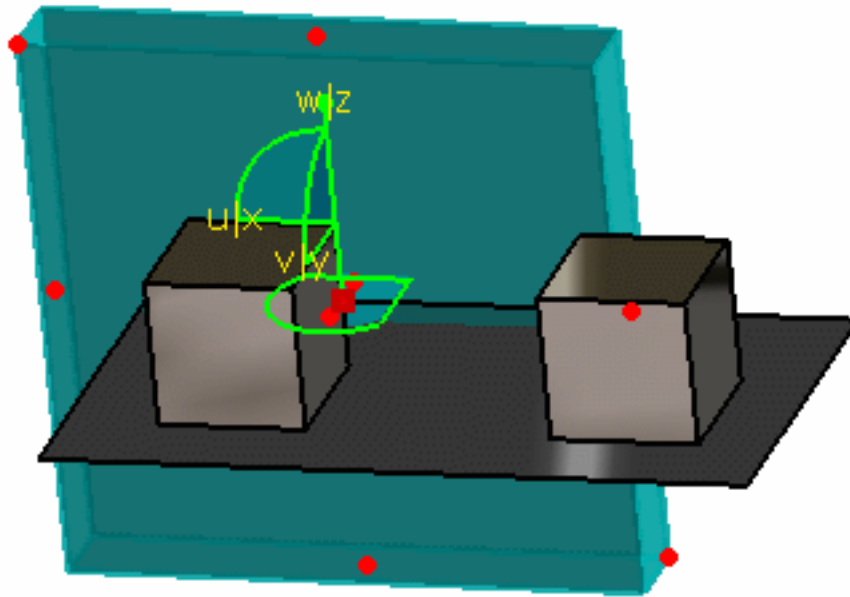

7. Click **OK** in the Box Group dialog box.

A **Box Group.1** object is displayed in the specification tree under the **Groups.1** set.



8. Update the **Box Group.1** object.

For more details, please refer to [Updating a Group](#).

You can now visualize Deformation, Von Mises Stresses, Displacements, Principal Stresses and Precisions images, either for all the geometry or only for the box group. The scenario is the same for the five images.

In this particular case, you will visualize the Von Mises Stresses image that has been previously created.

9. Activate the **Von Mises Stress (nodal value)** image.

For this, right-click the **Von Mises Stress (nodal value)** image in the specification tree and select the **Activate/Deactivate** contextual menu.

10. Double-click the **Von Mises Stress (nodal value)** image in the specification tree to edit it.

The Image Edition dialog box appears.

11. Select the **Box Group.1** object in the **Selections** tab and click **OK** in the Image Edition dialog box.

You can visualize the result only around the box group.

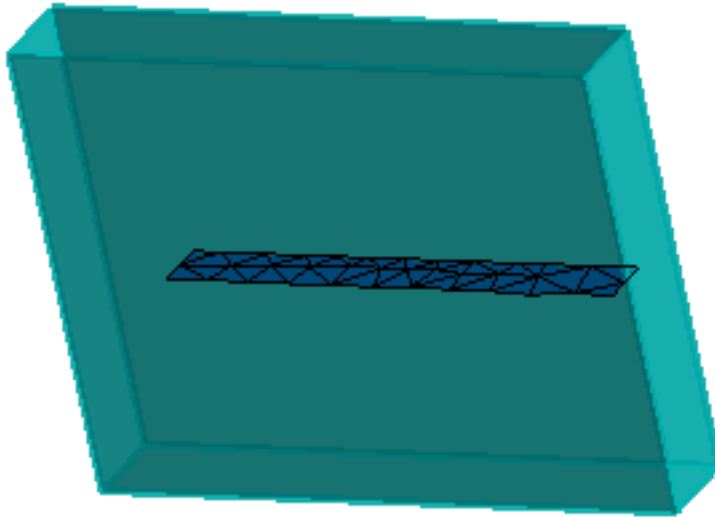

For more details about Images, please refer to [Results Visualization](#) (Image Creation, Generate Images and Editing Images).



You can manually edit or delete a group.

For this, right-click the group object in the specification tree and select the desired contextual menu.



# Sphere Group



This task shows how to group using a sphere and how to generate images from this group.

Grouping elements allows you to apply pre-processing specifications to a pre-defined group of elements and to generate images from this group.



This functionality is only available if you installed the **ELFINI Structural Analysis (EST)** product.



Open the [sample49.CATAnalysis](#) document from the samples directory for this task.

## Before You Begin

Go to **View -> Render Style -> Customize View** and make sure the **Shading, Outlines** and **Materials** options are active in the Custom View Modes dialog box.



1. Click the **Sphere Group** icon .

The Sphere Group dialog box appears.



- o **Name:** lets you change the name of the sphere group.
- o **Inactive/Active box:** lets you respectively use a pre-defined sphere or position and resize manually a sphere using the compass and the manipulators.
- o **Select an extremum:** lets you choose to position the sphere round an existing extremum.

A sphere appears on the geometry with a default size and a default position.

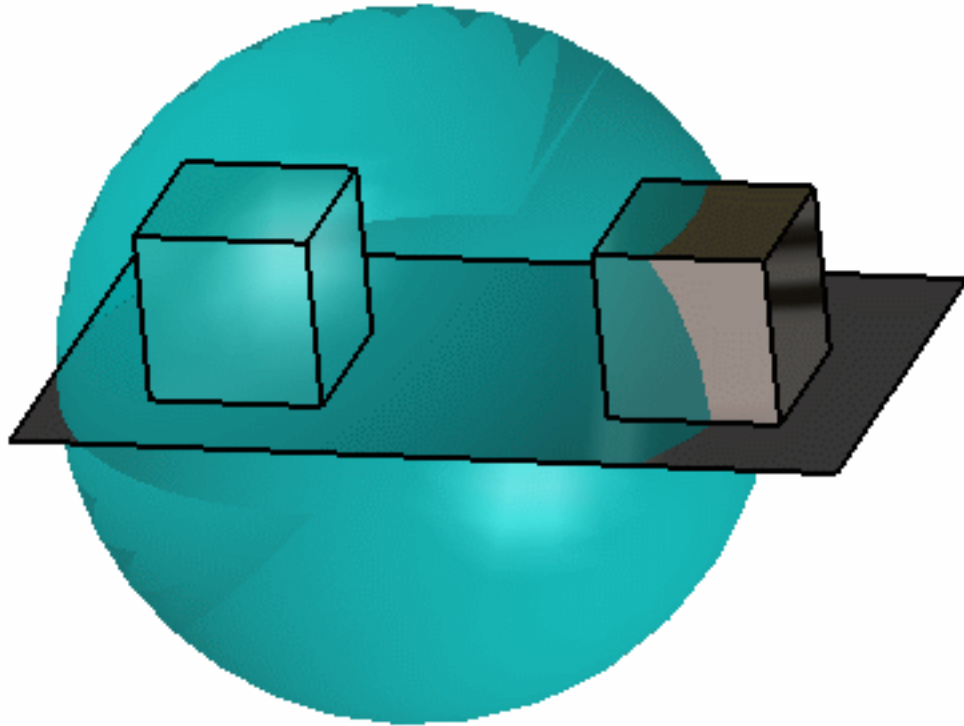

**2.** Activate the box.

For this, select the button as shown bellow:



The status of the sphere position and dimension can now be edited.



The compass and manipulators (red points) are now available to let you position and resize the box.

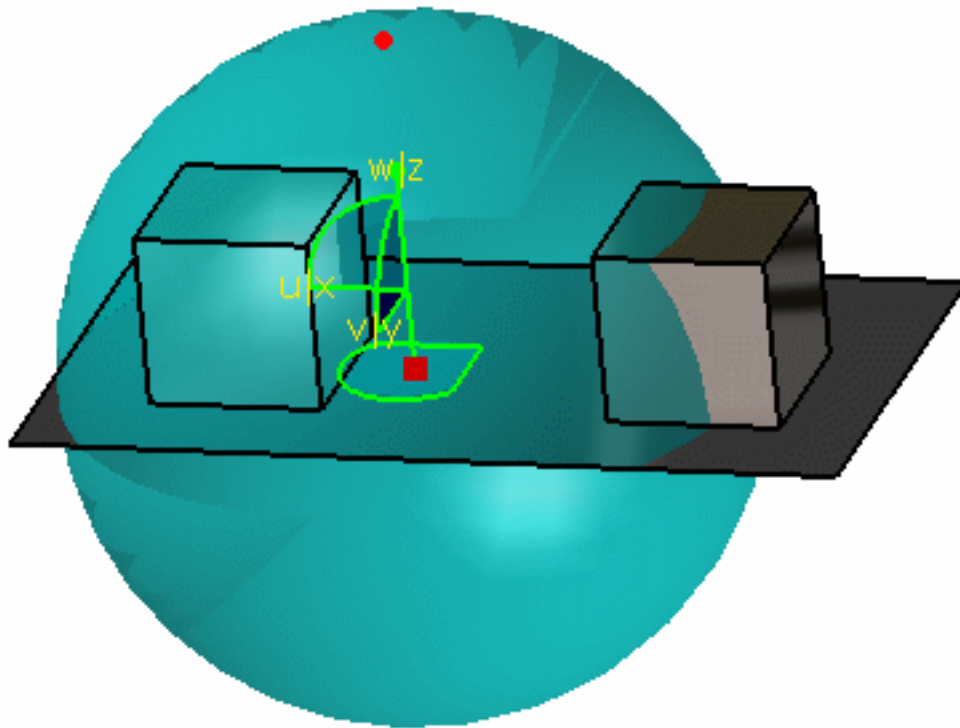

3. Change the position of the sphere.

For this, select the compass, drag and drop it to the desired position.

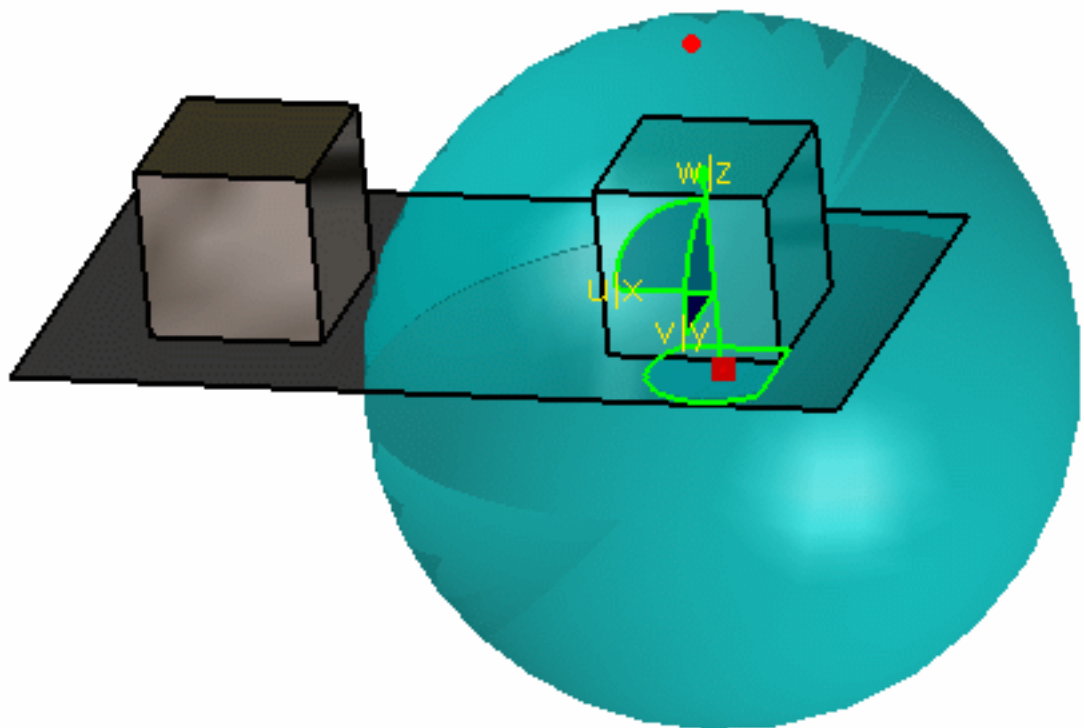
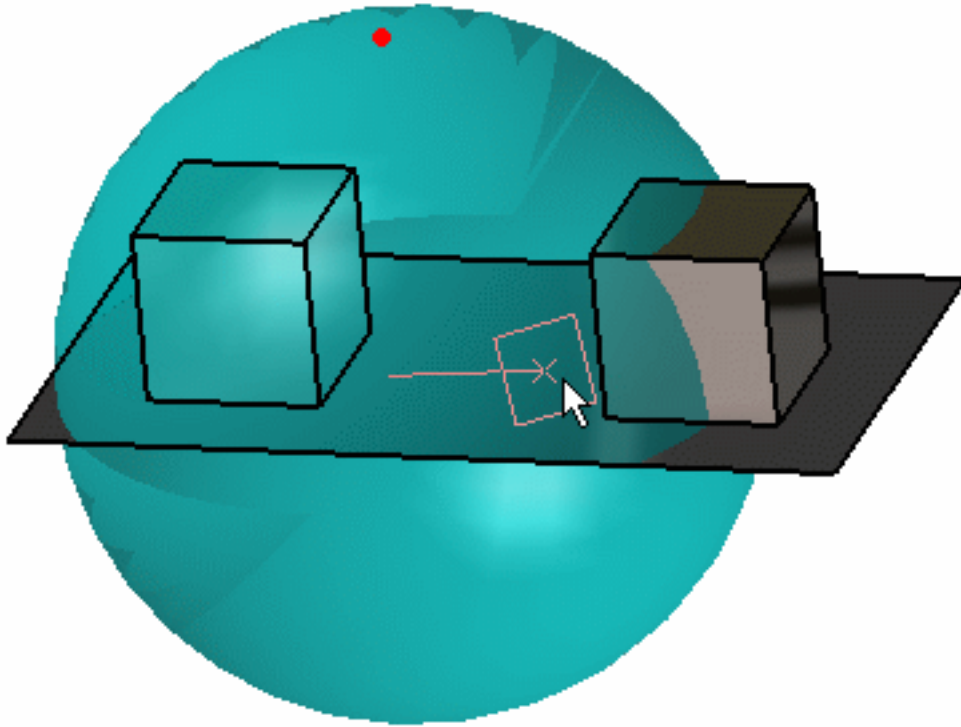

You can also define the position using the axis of the compass (select an axis of the compass, drag and drop it to the desired position).

4. Resize the sphere.

For this, select a manipulator, drag and drop it to the desired position.

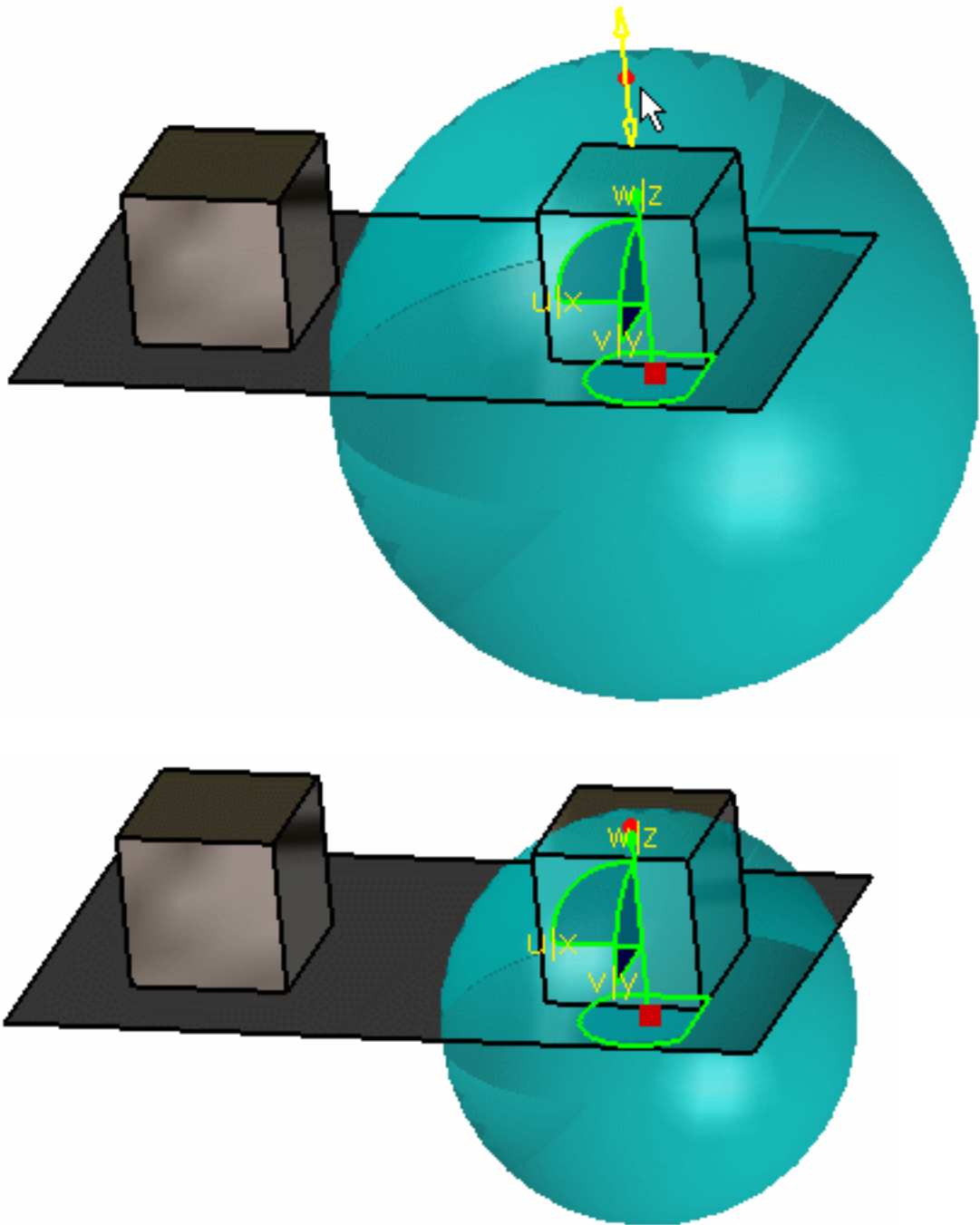

5. Click the **Select an extremum** button in the Box Group dialog box.
6. Select an existing extremum in the specification tree.



In this particular example, select the **Global Minimum.2** object.

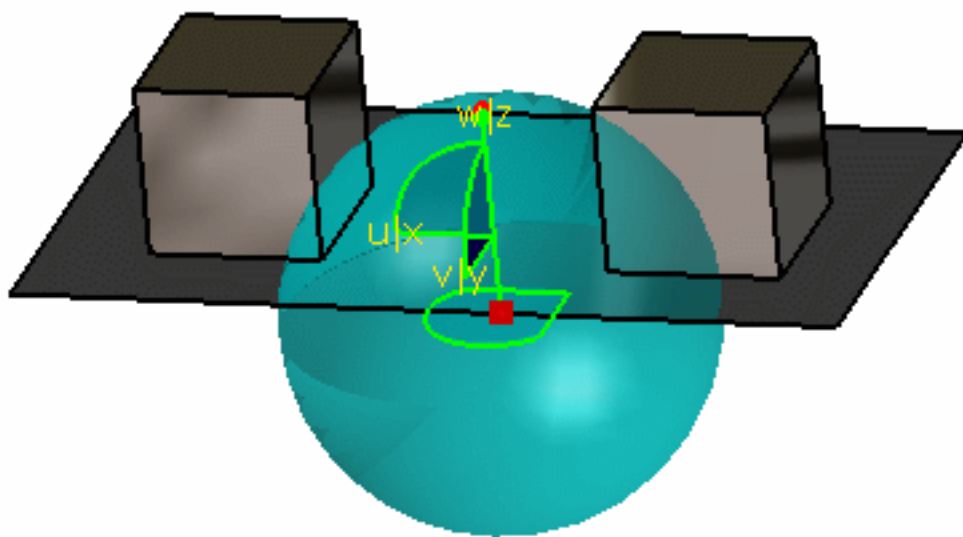
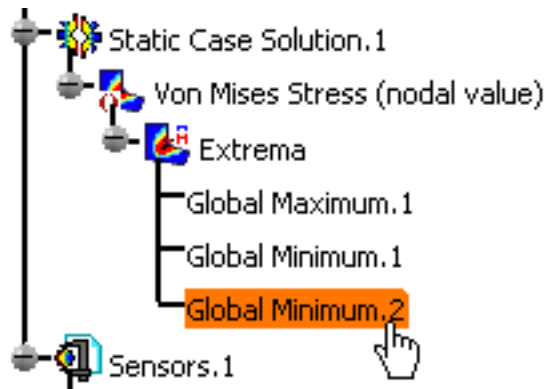

7. Click **OK** in the Sphere Group dialog box.

A **Sphere Group.1** object is displayed in the specification tree under the **Groups.1** set.



8. Update the Sphere Group.

For more details, please refer to [Updating a Group](#).

You can now visualize Deformation, Von Mises Stresses, Displacements, Principal Stresses and Precisions images, either for all the geometry or only for the sphere group. The scenario is the same for the five images.

In this particular case, you will visualize the Von Mises Stresses image that has been previously created.

9. Activate the **Von Mises Stress (nodal value)** image.

For this, right-click the **Von Mises Stress (nodal value)** image in the specification tree and select the **Activate/Deactivate** contextual menu.

10. Double-click the **Von Mises Stress (nodal value)** object in the specification tree.

The Image Edition dialog box appears.

11. Click the **Sphere Group.1** object in the **Selections** tab and click **OK** in the Image Edition dialog box.

You can visualize the result only around the sphere group.

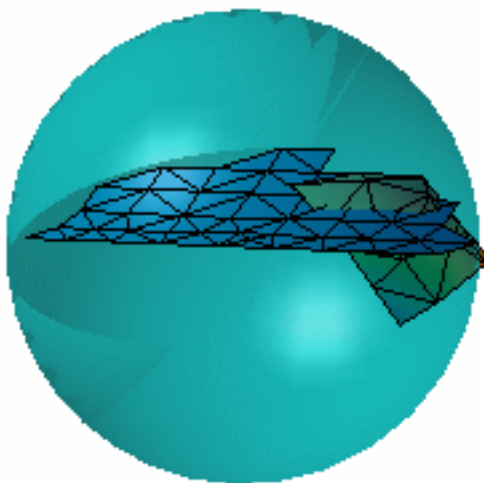

For more details about Images, please refer to [Results Visualization](#) (Image Creation, Generate Images and Editing Images).



You can manually edit or delete a group.

For this, right-click the group object in the specification tree and select the desired contextual menu.





# Grouping Points by Neighborhood



This task shows how to group points by neighborhood, that means grouping points by selecting geometry and entering a tolerance value.

Grouping elements by neighborhood allows you to apply pre-processing specifications to finite elements belonging to mesh parts without geometry support (for example: extrude mesh parts).



This functionality is only available if you installed the **ELFINI Structural Analysis (EST)** product.



Open the [sample49.CATAnalysis](#) document from the samples directory for this task.

## Before You Begin

Go to **View -> Render Style -> Customize View** and make sure the **Shading, Outlines** and **Materials** options are active in the Custom View Modes dialog box.



1. Click the **Point Group by Neighborhood** icon .

The Point Group by Neighborhood dialog box appears.

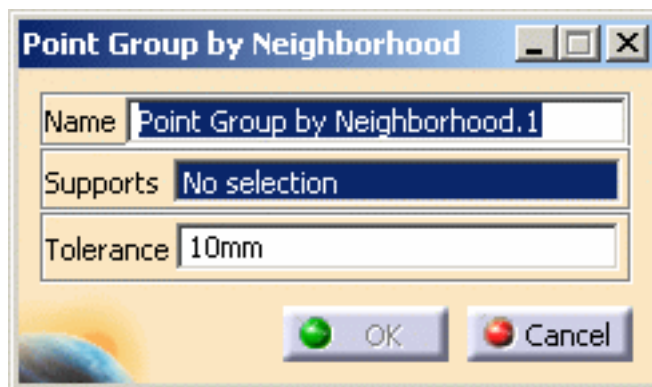

- o **Name:** lets you specify the name of the group.
- o **Supports:** lets you select the points you want to group.



- You can select only **Points** or **Vertices** as point group by neighborhood **Support**.
- This group enables to capture only proximity node elements.
- **Tolerance**: lets you define the tolerance value.

2. Select in sequence the points you want to group.

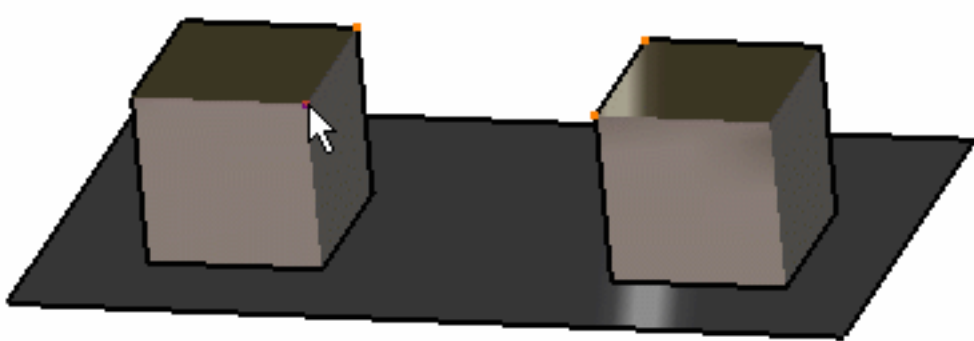

The Point Group by Neighborhood dialog box is updated:

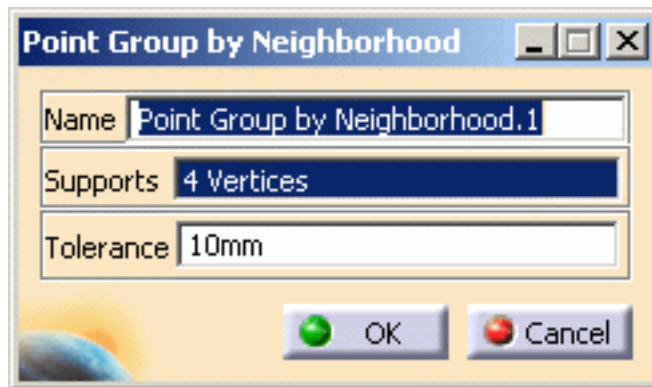

3. Enter the **Tolerance** value.

In this particular example, enter **5mm** as **Tolerance** value.

4. Click **OK** in the Point Group by Neighborhood dialog box.

A **Point Group by Neighborhood.1** object appears in the specification tree but it is not updated.



**5.** Update the proximity point group.

For more details, please refer to [Updating a Group](#).

You can now visualize Deformation, Von Mises Stresses, Displacements, Principal Stresses and Precisions images, either for all the geometry or only for the selected points. The scenario is the same for the five images.

In this particular case, you will visualize the Von Mises Stresses image:

**6.** Activate the Von Mises Stress image.

For this, right-click the **Von Mises Stress (nodal value)** object in the specification tree and select the **Activate/Deactivate** option.

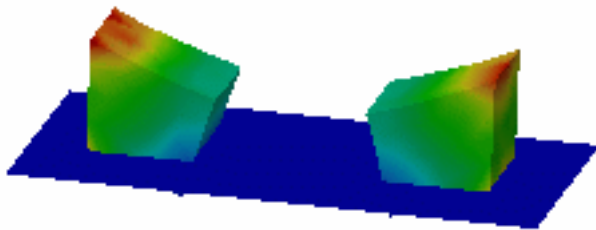

**7.** Double-click the **Von Mises Stress (nodal value)** object in the specification tree.

The Image Edition dialog box appears.

**8.** Double-click the **Point Group by Neighborhood.1** object in the **Selections** tab and click **OK** in the Image Edition dialog box.



For more details about images, please refer to [Results Visualization](#) (Image Creation, Generate Images and Editing Images).



You can manually edit or delete a group.

For this, right-click the group object in the specification tree and select the desired contextual menu.





# Grouping Lines by Neighborhood



This task shows how to group lines by neighborhood, that means grouping lines by selecting geometry and entering a tolerance value.

Grouping elements by neighborhood allows you to apply pre-processing specifications to finite elements belonging to mesh parts without geometry support (for example: extrude mesh parts).



This functionality is only available if you installed the **ELFINI Structural Analysis (EST)** product.



Open the [sample49.CATAnalysis](#) document from the samples directory for this task.

## Before You Begin

Go to **View -> Render Style -> Customize View** and make sure the **Shading, Outlines** and **Materials** options are active in the Custom View Modes dialog box.



1. Click the **Line Group by Neighborhood** icon .

The Line Group by Neighborhood dialog box appears.



- o **Name:** lets you specify the name of the group.
- o **Supports:** lets you select the lines you want to group.





- You can select only **Edges** or **1D Features** as line group by neighborhood **Support**.
- This group enables to capture proximity node elements, edge elements and all the 1D elements.
- **Tolerance**: lets you define the tolerance value.

2. Select in sequence the lines you want to group.

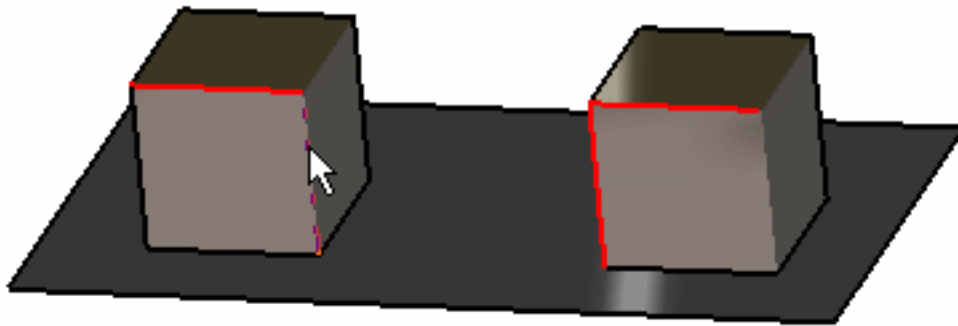

The Line Group by Neighborhood dialog box is updated:



3. Enter a **Tolerance** value.

In this particular example, enter **3mm** as **Tolerance** value.

4. Click **OK** in the Line Group by Neighborhood dialog box.

A **Line Group by Neighborhood.1** object appears in the specification tree but it is not updated.

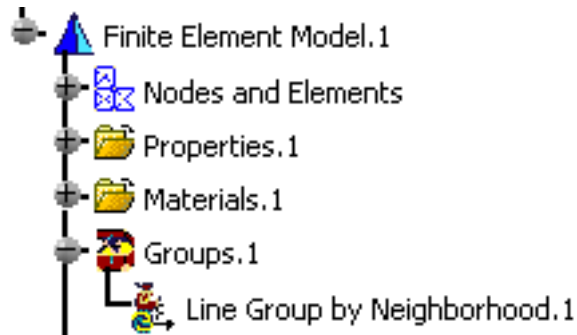

5. Update the line group by neighborhood.

For more details, please refer to [Updating a Group](#).

You can now visualize Deformation, Von Mises Stresses, Displacements, Principal Stresses and Precisions images, either for all the geometry or only for the selected lines. The scenario is the same for the five images.

In this particular case, you will visualize the Von Mises Stresses image:

6. Activate the Von Mises Stress image.

For this, right-click the **Von Mises Stress (nodal value)** object in the specification tree and select the **Activate/Deactivate** option.

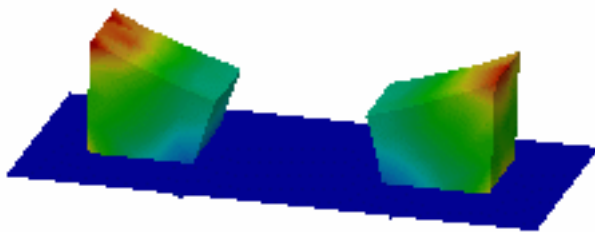

7. Double-click the **Von Mises Stress (nodal value)** object in the specification tree.

The Image Edition dialog box appears.

8. Double-click the **Line Group by Neighborhood.1** object in the **Selections** tab and click **OK** in the Image Edition dialog box.

You will see the result only around the selected lines.



For more details about Images, please refer to [Results Visualization](#) (Image Creation, Generate Images and Editing Images).



You can manually edit or delete a group. For this, right-click the group object in the specification tree and select the desired option in the contextual menu.





# Grouping Surfaces by Neighborhood



This task shows how to group surfaces by neighborhood, that means grouping surfaces by selecting geometry and entering a tolerance value.

Grouping elements by neighborhood allows you to apply pre-processing specifications to finite elements belonging to mesh parts without geometry support (for example: extrude mesh parts).



This functionality is only available if you installed the **ELFINI Structural Analysis (EST)** product.



Open the [sample49.CATAnalysis](#) document from the samples directory for this task.

## Before You Begin

Go to **View -> Render Style -> Customize View** and make sure the **Shading, Outlines** and **Materials** options are active in the Custom View Modes dialog box.



1. Click the **Surface Group by Neighborhood** icon .

The Surface Group by Neighborhood dialog box appears.

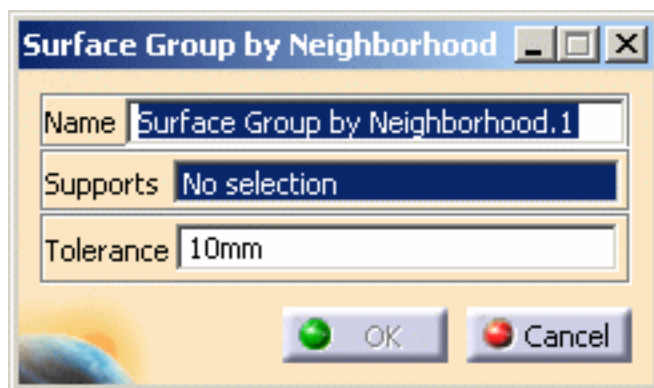

- o **Name:** lets you specify the name of the group.
- o **Supports:** lets you select the surface you want to group.



- You can select only **Surfaces** or **2D Features** as surface group by neighborhood **Support**.
- This group enables to capture proximity node elements, face elements and all the 2D elements.
- **Tolerance**: lets you define the tolerance value.

**2.** Select in sequence the surfaces you want to group.

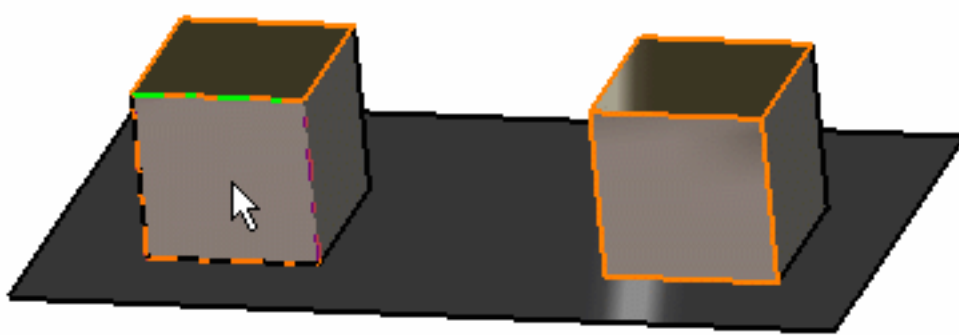

The Surface Group by Neighborhood dialog box is updated:



**3.** Enter the **Tolerance** value.

In this particular example, enter **8mm** as **Tolerance** value.

**4.** Click **OK** in the Surface Group by Neighborhood dialog box.

A **Surface Group.1** object appears in the specification tree but it is not updated.

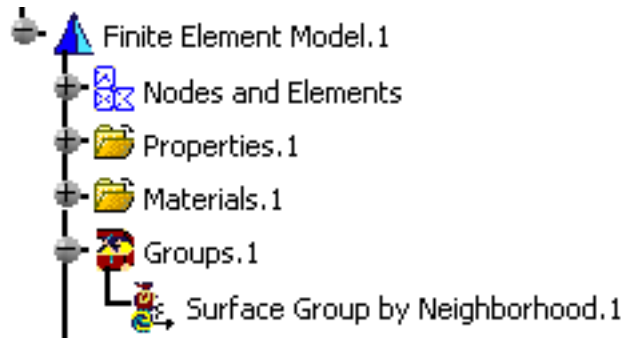

5. Update the surface group by neighborhood.

For more details, please refer to [Updating a Group](#).

You can now visualize Deformation, Von Mises Stresses, Displacements, Principal Stresses and Precisions images, either for all the geometry or only for the selected surfaces. The scenario is the same for the five images.

In this particular case, you will visualize the Von Mises Stresses image:

6. Activate the Von Mises Stress image.

For this, right-click the **Von Mises Stress (nodal value)** object in the specification tree and select the **Activate/Deactivate** option.

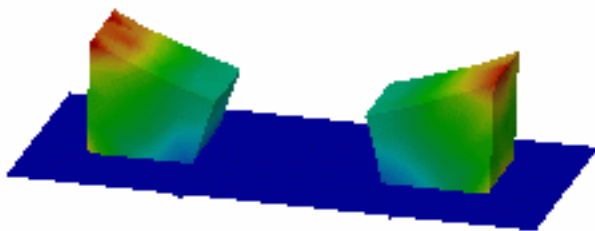

7. Double-click the **Von Mises Stress (nodal value)** object in the specification tree.

The Image Edition dialog box appears.

8. Double-click the **Surface Group by Neighborhood.1** object in the **Selections** tab and click **OK** in the Image Edition dialog box.

You will see the result only around the selected surfaces.

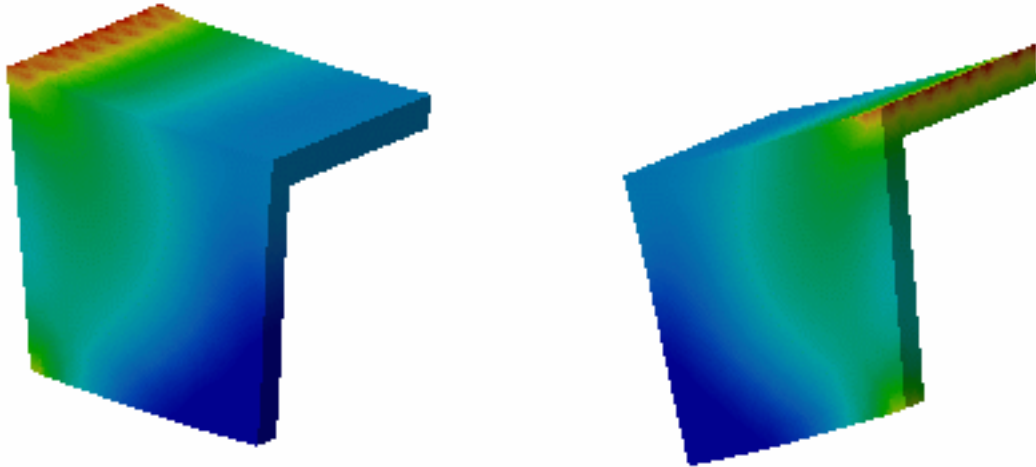

For more details about Images, please refer to [Results Visualization](#) (Image Creation, Generate Images and Editing Images).



You can manually edit or delete a group. For this, right-click the group object in the specification tree and select the desired option in the contextual menu.



# Updating Groups



This task shows how to:

- update a group you just have created or you have edited
- update all groups belonging to a same group set.



Open the [sample49\\_2.CATAnalysis](#) document from the samples directory for this task.

A line group, a surface group and a body group are already created.

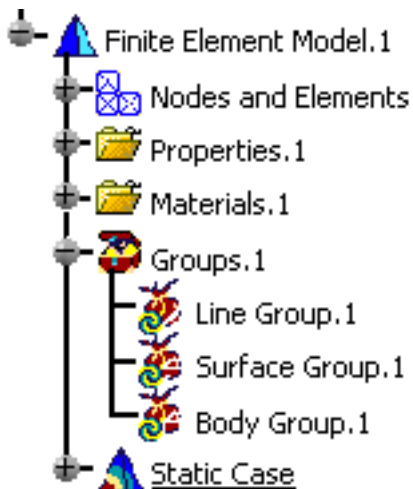

The symbol  in the specification tree shows you that the different groups are not updated.



1. Right-click the **Surface Group.1** object in the specification.

2. Select the **Update Group** contextual menu .

The symbol  disappears in the specification tree.

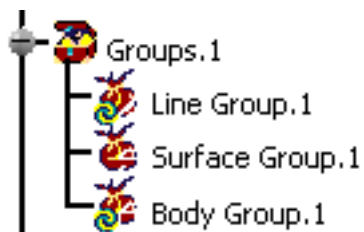

3. Edit the surface group.

For this, double-click the **Surface Group.1** object in the specification tree.



The Surface Group dialog box appears.

4. Select a surface and click **OK** in the Surface Group dialog box.

The symbol  reappears in the specification tree.

5. Right-click the **Groups.1** set in the specification tree and select the **Update All**

**Groups** contextual menu .

The symbol  disappears in the specification tree.



# Analyze Group



This task shows how to know and visualize the content of a group (nodes, elements, faces of element, edges of element).



- The group set must be updated.
- Elements belonging to connection are not taking into account by the box groups and the sphere groups.



Open the [sample49\\_1.CATAnalysis](#) document from the samples directory for this task.



1. Update the surface group.



For more details, please refer to [Updating a Group](#).

2. Right-click the surface group set in the specification tree and select the **Analyze Group**

contextual menu  **Analyze Group**

The Group Content dialog box appears.

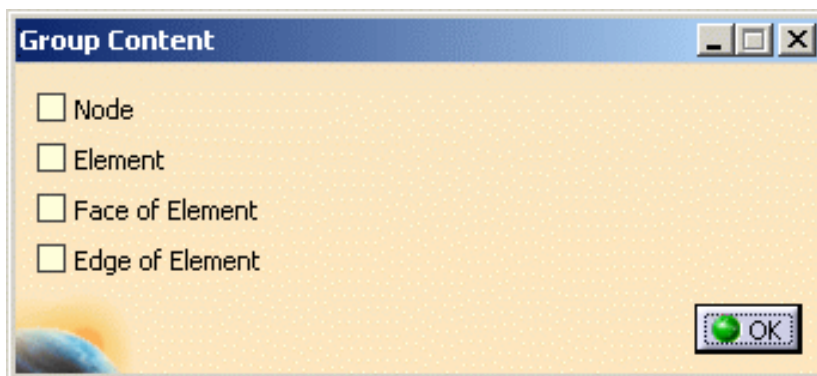

- **Node:** gives you the number of nodes belonging to the selected group and lets you visualize these nodes on the geometry.
- **Element:** gives you the number of elements belonging to the selected group and lets you visualize these elements on the geometry.
- **Face of element:** gives you the number of element faces belonging to the selected group and lets you visualize these element faces on the geometry.
- **Edge of element:** gives you the number of element edges belonging to the selected group and lets you visualize these element edges on the geometry.

3. Select the **Node** option in the Group Content dialog box.

The Group Content dialog box gives you the number of nodes belonging to the selected group.

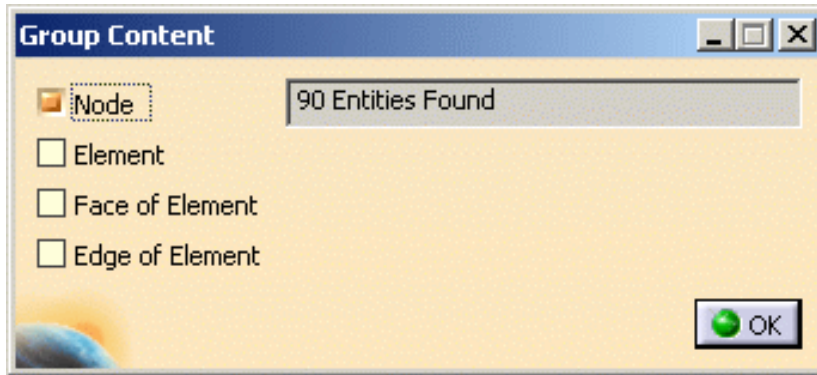

In this particular example, you can see that the select group is composed of 90 nodes.

Moreover, the nodes can be visualized on the geometry.

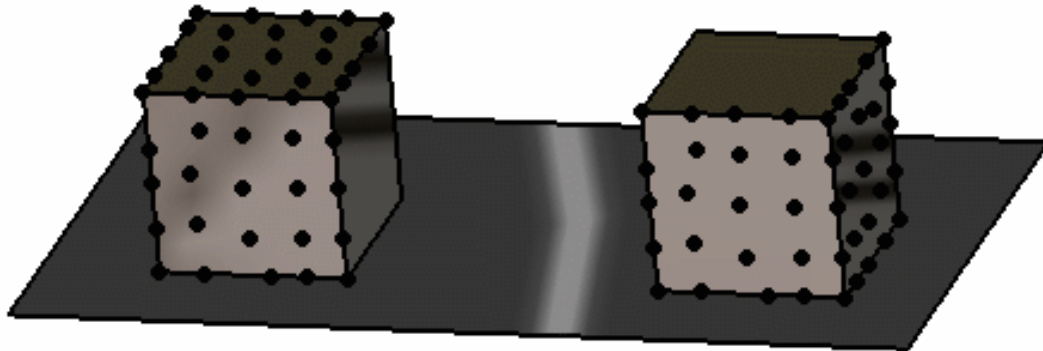

4. Select the **Face of element** option in the Group Content dialog box.

Both the Group Content dialog box and the geometry are updated.

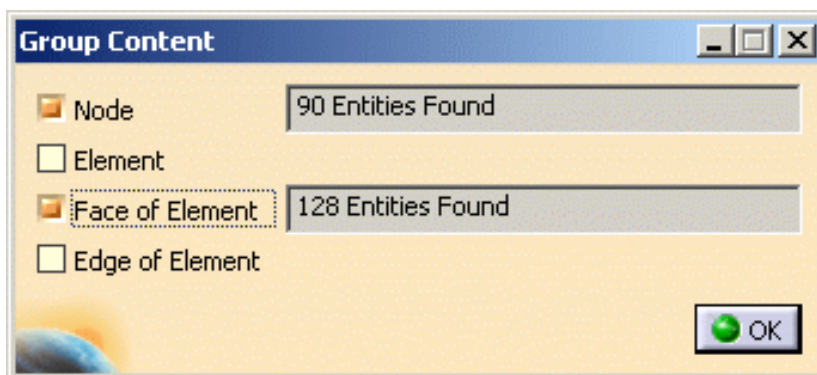

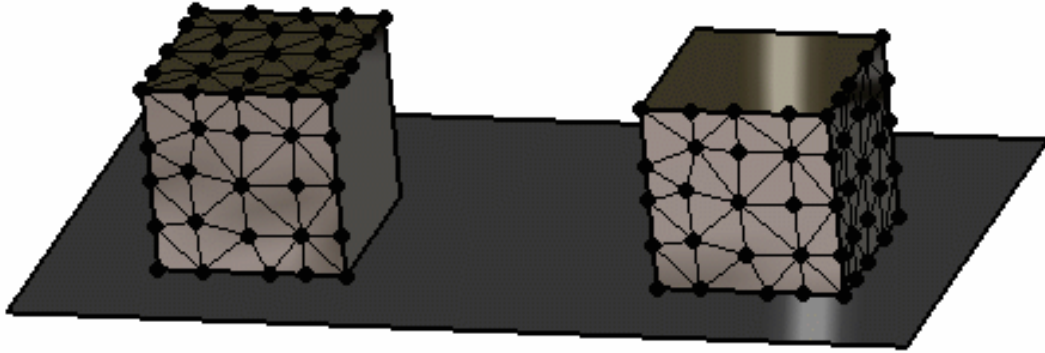

If you want to visualize only the element faces (without the nodes), deactivate the **Node** option in the Group Content dialog box.

You will obtain the following result:

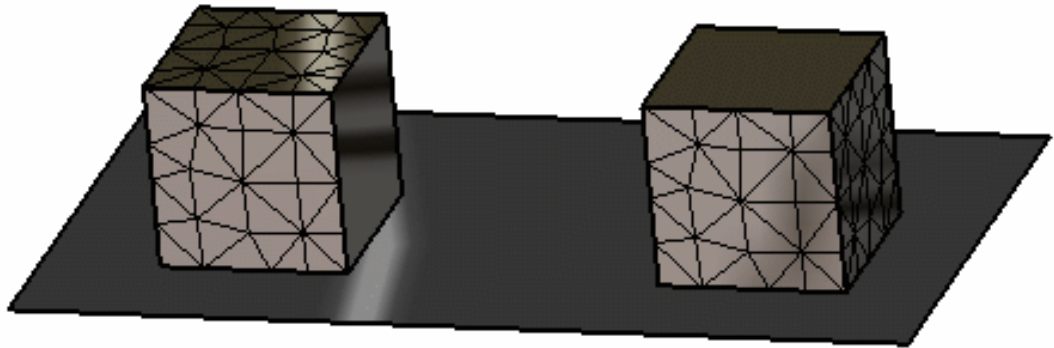

5. Click **OK** in the Group content dialog box.



# Analysis Connections



The following functionalities are only available in the **Generative Assembly Structural Analysis (GAS)** product.



## General Analysis Connection

Allow connection between points, edges, surfaces and mechanical features.



## Point Analysis Connection

Allow the connection of surfaces and the selection of one open body containing points.



## Point Analysis Connection Within One Part

Allow the connection of one surface and the selection of one open body containing points.



## Line Analysis Connection

Allow the connection of surfaces and the selection of one open body containing lines.



## Line Analysis Connection Within One Part

Allow the connection of one surface and the selection of one open body containing lines.



## Surface Analysis Connection

Allow the connection of surfaces.



## Surface Analysis Connection Within One Part

Allow the connection of one surface.

# General Analysis Connection



This task will show you how to create a General Analysis Connection.

General analysis connections are used for connecting any part from an assembly with or without handler point, on an assembly model.

This can be performed between any type of geometry.

This is very useful when you want to benefit from the representation of part without actually designing this part.



- This functionality is only available in the **Generative Assembly Structural Analysis (GAS)** product



- The connection has to connect two components.  
A component can be:
  - a vertex
  - an edge or a multi-selection of edges belonging to the same feature
  - a surface or a multi-selection of surfaces belonging to the same part body
  - a mechanical feature (i.e. sketch, pad, assemble, remove, ...)
- A connection with a vertex on one side does not accept a handler point.



Open the [sample42.CATAnalysis](#) from the samples directory.



1. Click the **General Analysis Connection** icon .

The General Analysis Connection dialog box appears.

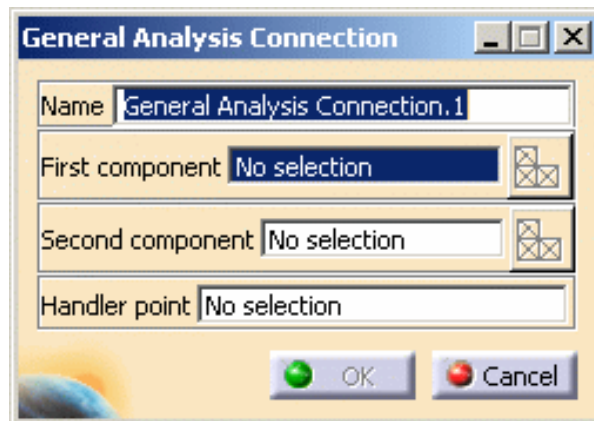

- **Name:** lets you change the name of the connection.
- **First component:** lets you select the first "side" of the part that will support the connection.
  - Multi-selection is not available for vertex and mechanical feature.
  - Multi-selection of edges or surfaces must be homogeneous and must belong to the same mesh part.



- **Select Mesh Parts:** this button is available only if a support is selected. For more details, please click [here](#).
- **Second Component:** lets you select the second "side" of the part that will support the connection.
  - ⚠ Multi-selection is not available for vertex and mechanical feature.
  - Multi-selection of edges or surfaces must be homogeneous and must belong to the same mesh part.
  - **Select Mesh Parts:** this button is available only if a support is selected. For more details, please click [here](#).
- **Handler point:** lets you specify an optional handler point.
  - ⚠ A connection with a vertex on one side does not accept a handler point.

2. Select the first component.

In this particular case, select two edges belonging to the **Part3 (Part 3.1)**.

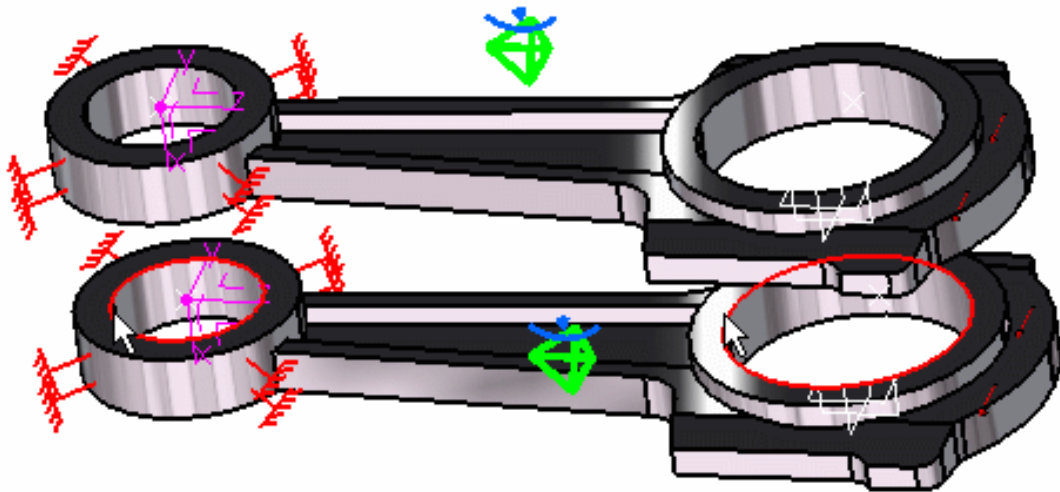

3. Activate the **Second component** field.

For this, select the **Second component** edit box as shown below:

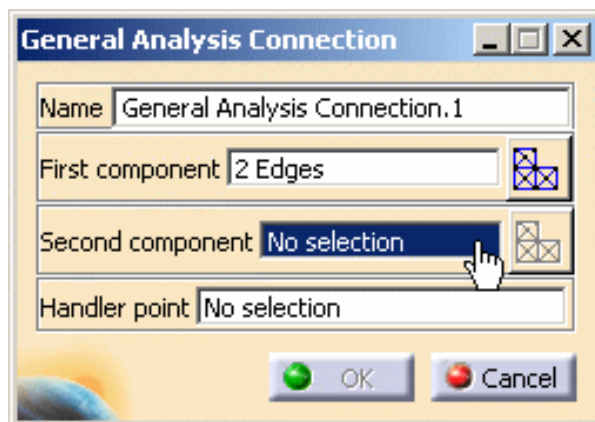

4. Select the second component.

In this particular case, select a surface belonging to the **Part3 (Part 3.2)**.

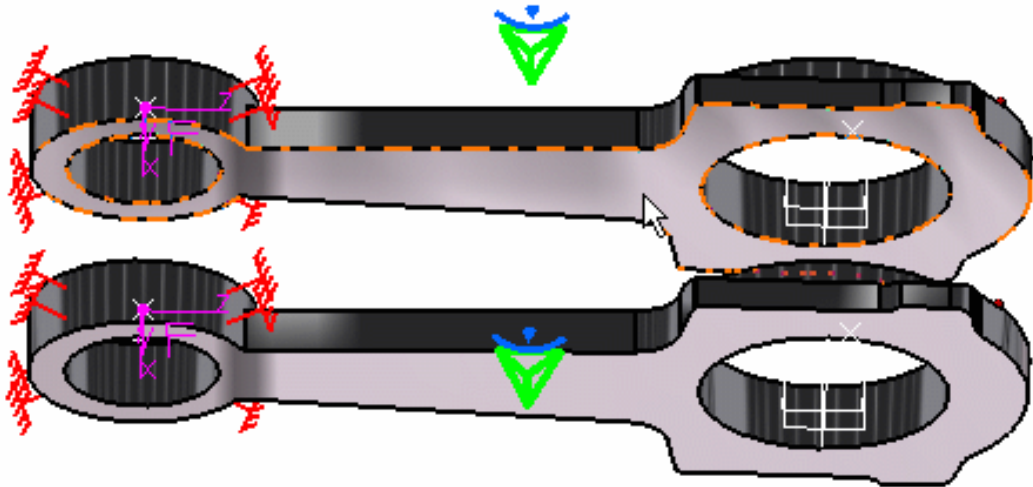

5. Optionally, you can activate the **Handler point** field by selecting the **Handler point** edit box.

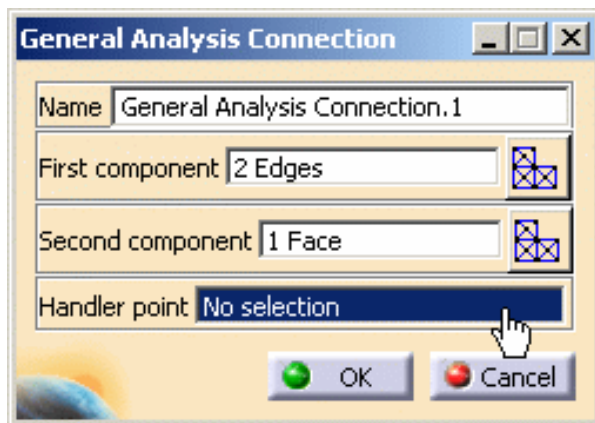

In this particular example, you do not need to select a handler point.

6. Optionally, select a point as handler point.
7. Click **OK** in the General Analysis Connection dialog box.



A symbol representing the general connection is visualized.

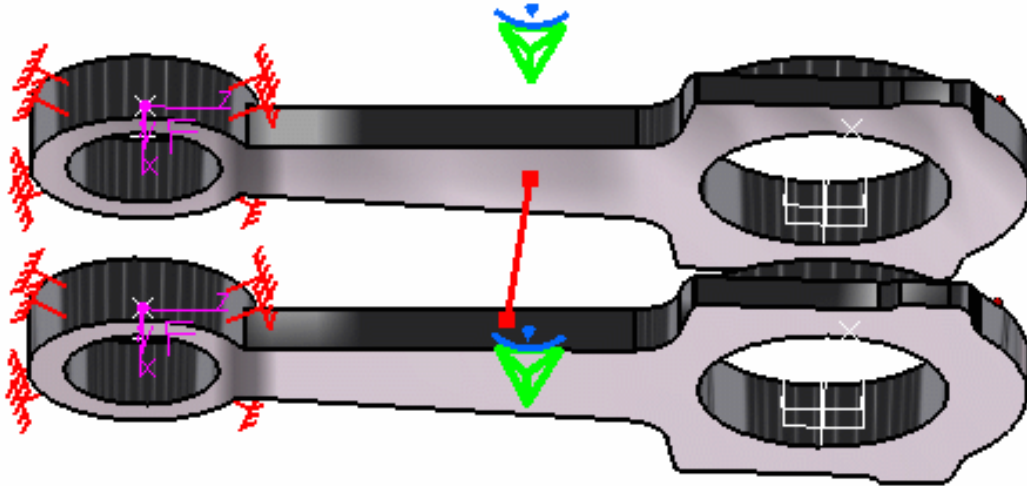

The **General Analysis Connection.1** object is displayed in the specification tree under the **Analysis Connection Manager.1** set.

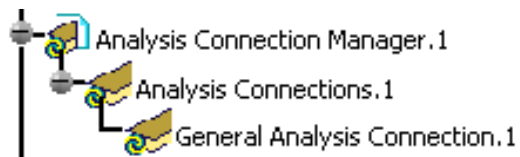

- You can update analysis connections. For this:
  - right-click the **Analysis Connection Manager.1** set in the specification tree
  - select the **Update all analysis connections** contextual menu.
- You can now apply a connection property on the connection you just have created. For more details, please refer to the [Connection Properties](#) section.



# Point Analysis Connection



This task will show you how to create a Point Analysis Connection.

Point analysis connections are used for projecting welding points onto parallel faces, on an assembly model.



- This functionality is only available in the **Generative Assembly Structural Analysis (GAS)** product .

- The connection has to connect two bodies (2D or 3D).
- Multi-selection is not available.



Open the [sample48.CATAnalysis](#) from the samples directory.



1. Click the **Point Analysis Connection** icon .

The Point Analysis Connection dialog box appears.

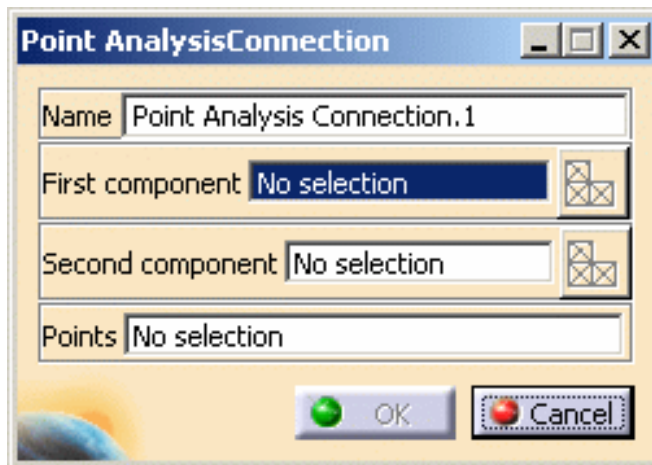

- **Name:** lets you change the name of the connection.
- **First component:** lets you select the first "side" of the part that will support the connection.



You can select one body (2D or 3D).

- **Select Mesh Parts:** this button is available only if a support is selected. For more details, please click [here](#).

- **Second Component:** lets you select the second "side" of the part that will support the connection.



You can select one body (2D or 3D).

- **Select Mesh Parts:** this button is available only if a support is selected. For more details, please click [here](#).

- **Points:** lets you select the welding points.



You can select an **Open body** containing several points.

2. Select the first component.

In this particular example, select the **Part6(Part6.1)**.

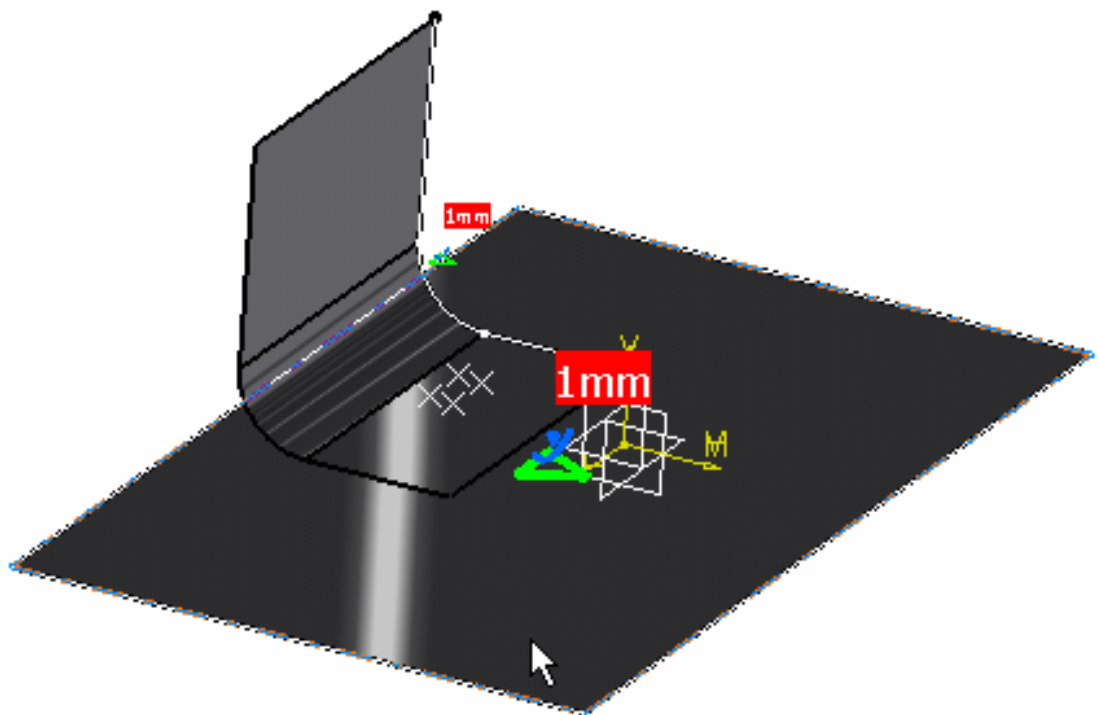

3. Activate the **Second component** field.

For this, select the **Second component** edit box as shown below:

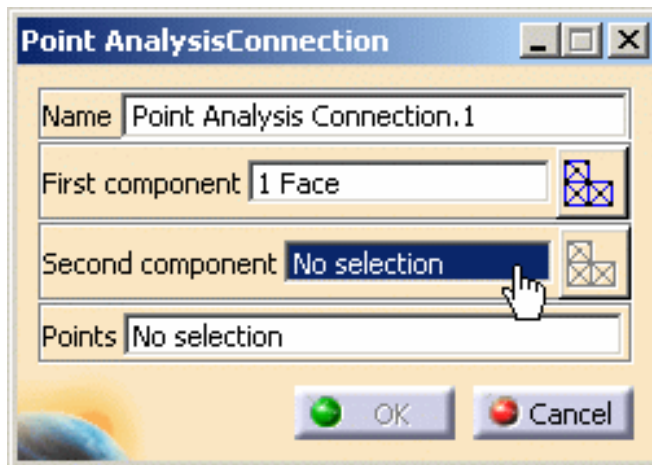

4. Select the second component.

In this particular example, select the **Part5(Part5.1)**.

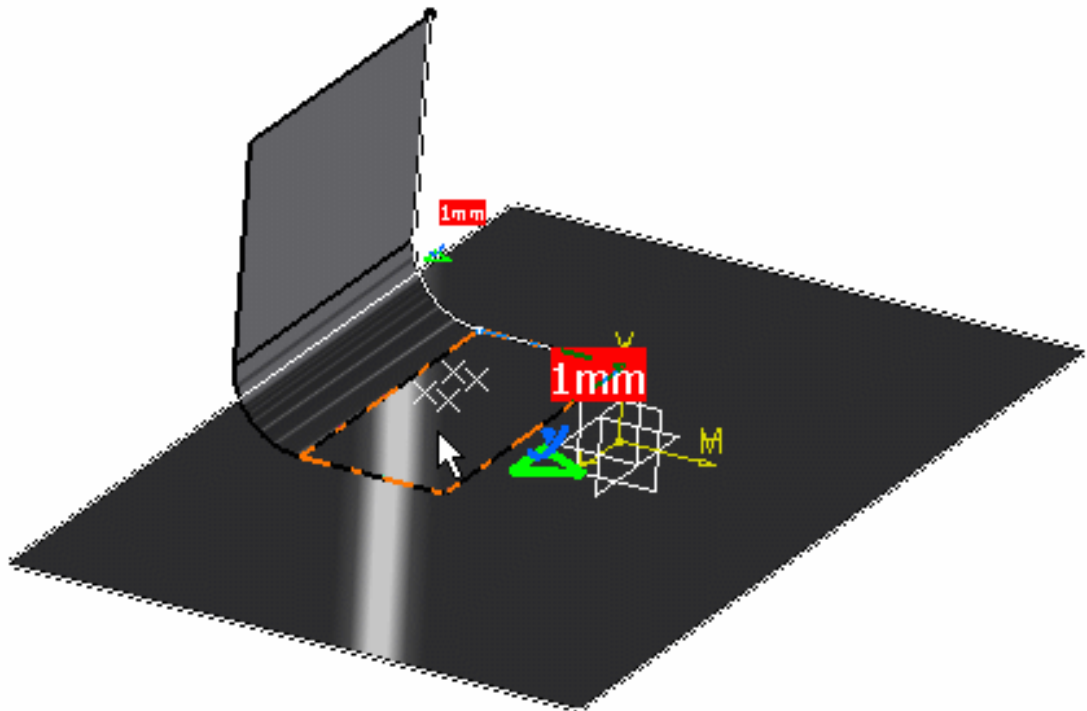

5. Activate the **Points** field.

For this, select the **Points** edit box as shown below:

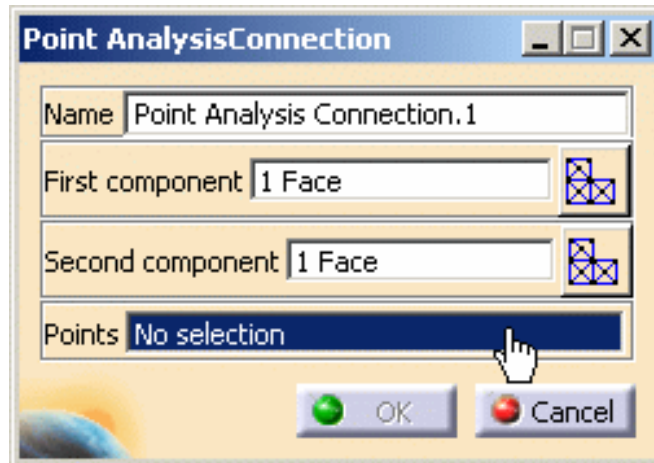

6. Select the welding points.

In this particular example, select the **Points** open body (under the Part5).

A symbol representing the point design connection appears on the assembly.

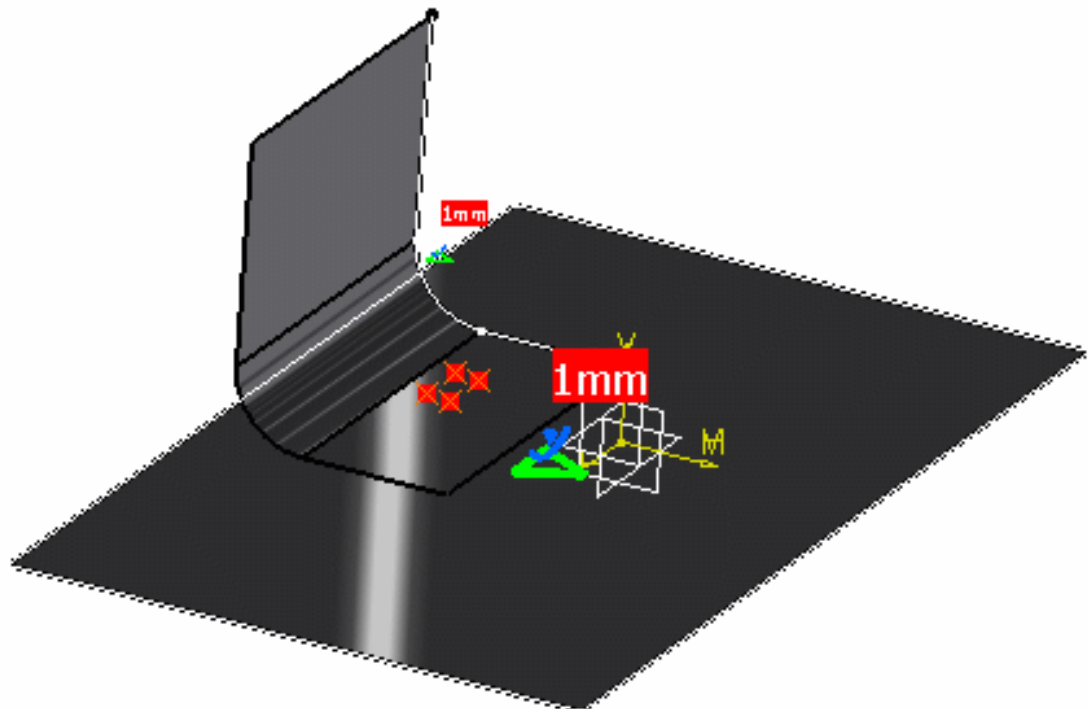

7. Click **OK** in the Point Analysis Connection dialog box.

The **Point Analysis Connection.1** is displayed in the specification tree under the **Analysis Connection Manager.1** set.

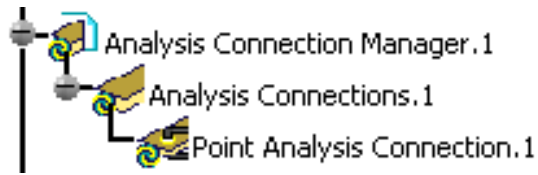

- You can update design connections. For this:
  - right-click the **Analysis Connection Manager.1** set in the specification tree
  - select the **Update all analysis connections** contextual menu.
- You can now apply a connection property on the connection you just have created. For more details, please refer to [Creating Spot Welding Connection Property](#).



# Point Analysis Connection Within One Part



This task will show you how to create a Point Connection Within One Part.

Point analysis connections within one part are used for projecting welding points onto parallel faces, belonging to the same part.



This functionality is only available in the **Generative Assembly Structural Analysis (GAS)** product.



Open the [sample09.CATAnalysis](#) from the samples directory.



1. Click the **Point Analysis Connection within one Part** icon .

The Point Analysis Connection within one Part dialog box appears.

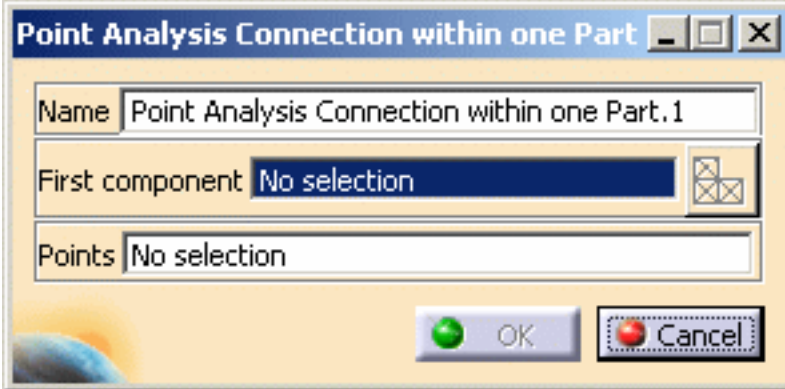

- o **Name:** lets you change the name of the connection.
- o **First component:** lets you select the part that will support the connection.



You can select one body (2D or 3D).

- **Select Mesh Parts:** this button is available only if a support is selected. For more details, please click [here](#).

- o **Points:** lets you select the welding points.



You can select an **Open body** containing several points.

2. Select the open body.

In this particular example, select the **Extrude.1** open body in the specification tree or select the geometry as shown below:

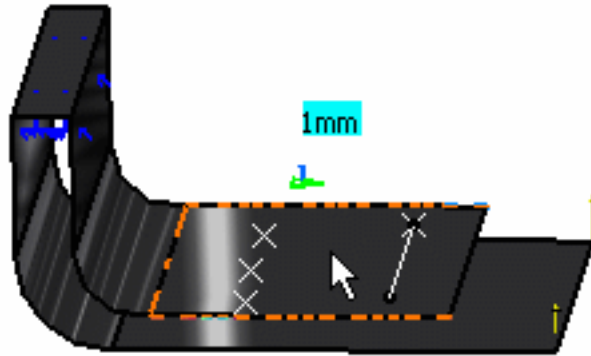

3. Activate the **Points** field.

For this, select the **Points** edit box as shown below:

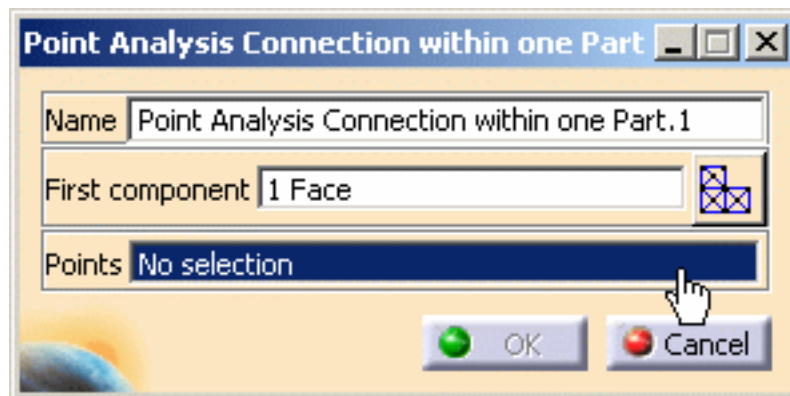

4. Select the welding points.

In this particular example, select the **Open body.2 (Points)** open body in the specification tree.

5. Click **OK** in the Point Analysis Connection within one Part dialog box.



The **Point Analysis Connection within one Part.1** is displayed in the specification tree under the **Analysis Connection Manager.1** set.

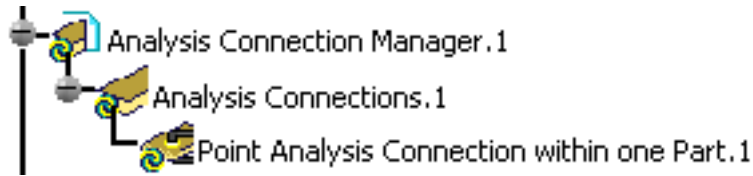

- You can update design connections. For this:
  - right-click the **Analysis Connection Manager.1** set in the specification tree
  - select the **Update all analysis connections** contextual menu.
- You can now apply a connection property on the connection you just have created. For more details, please refer to [Creating Spot Welding Connection Property](#).



# Line Analysis Connection



This task will show you how to create a Line Analysis Connection.

Line analysis connections are used for simulating welding seam onto parallel faces, on an assembly model.



- This functionality is only available in the **Generative Assembly Structural Analysis (GAS)** product .
- The connection has to connect two bodies (2D or 3D).
- Multi-selection is not available.



Open the [sample48.CATAnalysis](#) from the samples directory.



1. Click the **Line Analysis Connection** icon .

The Line Analysis Connection dialog box appears.

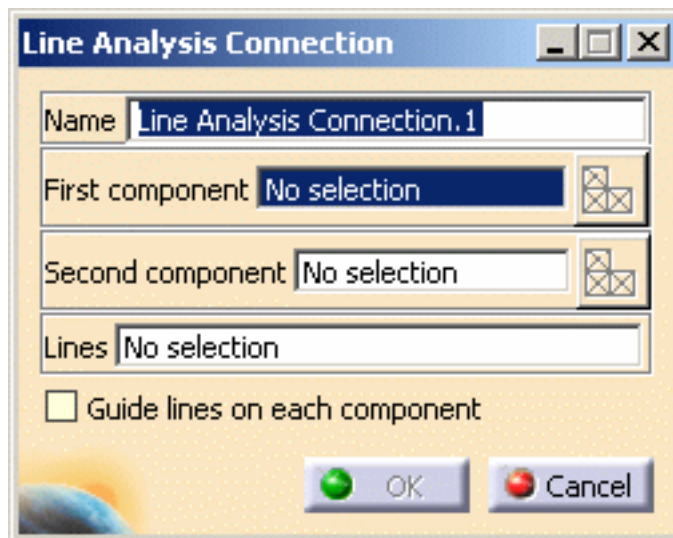

- **Name:** lets you change the name of the connection.
- **First component:** lets you select the first "side" of the part that will support the connection.



You can select one body (2D or 3D).

- **Select Mesh Parts:** this button is available only if a support is selected.

For more details, please click [here](#).

- **Second component:** lets you select the second "side" of the part that will support the connection.



You can select one body (2D or 3D).

- **Select Mesh Parts:** this button is available only if a support is selected. For more details, please click [here](#).

- **Lines:** lets you select the welding line.



- Multi-selection is not available.
- The line can be:
  - a border of the geometry
  - feature (line, curve)

- **Guide line on each component:** lets you select a second line that will guide the connection orientation.

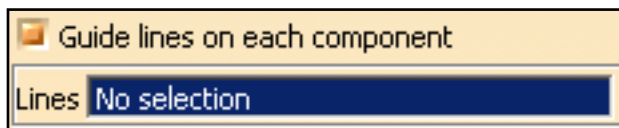

2. Select the first component.

In this particular example, select the **Fill.1** in the **Part6(Part6.1)**.

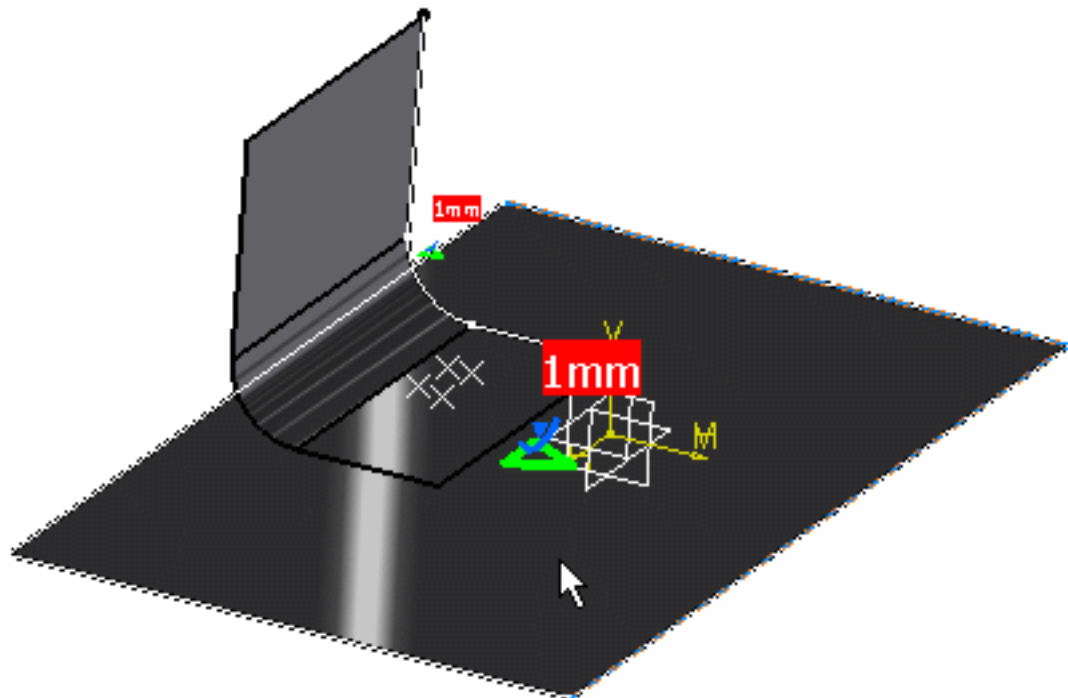

3. Activate the **Second component** field.

For this, select the **Second component** edit box as shown below:

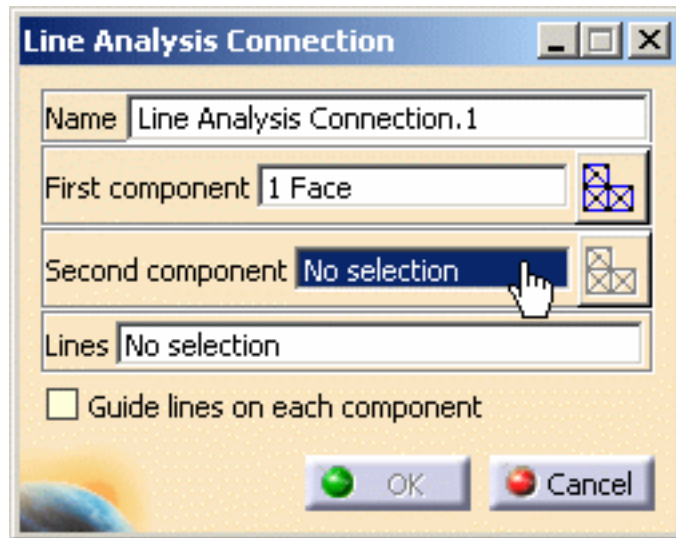

4. Select the second component.

In this particular example, select the **Extrude.1** in the **Part5(Part5.1)**.

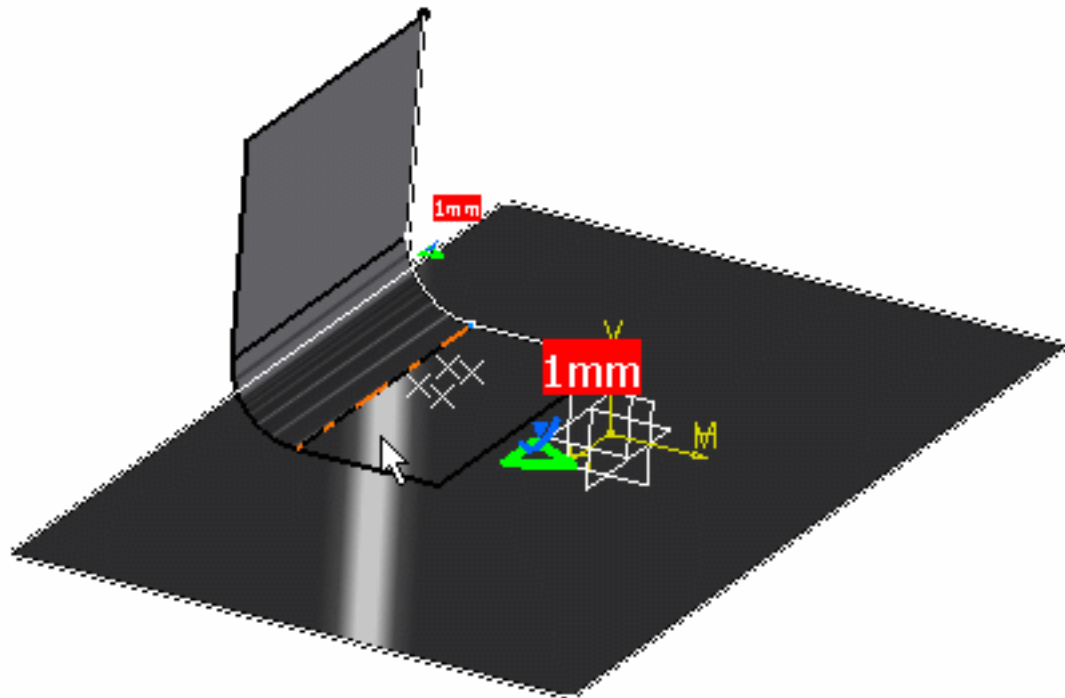

5. Activate the **Lines** field.

For this, select the **Lines** edit box as shown below:

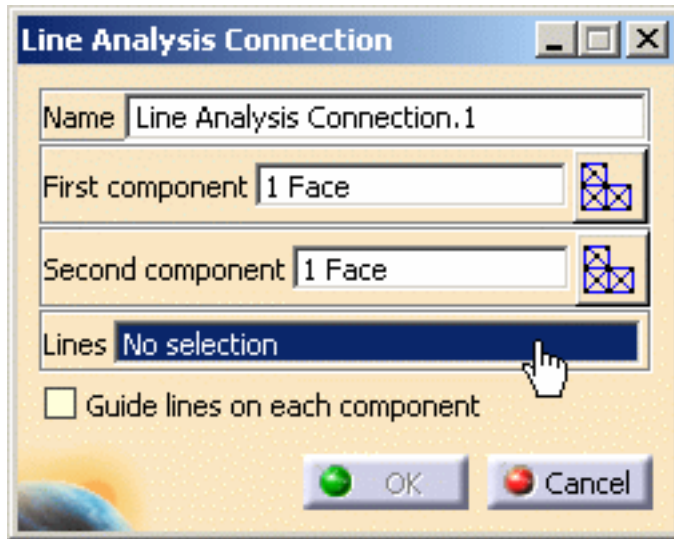

6. Select the desired line.

In this particular example, select the following edge.

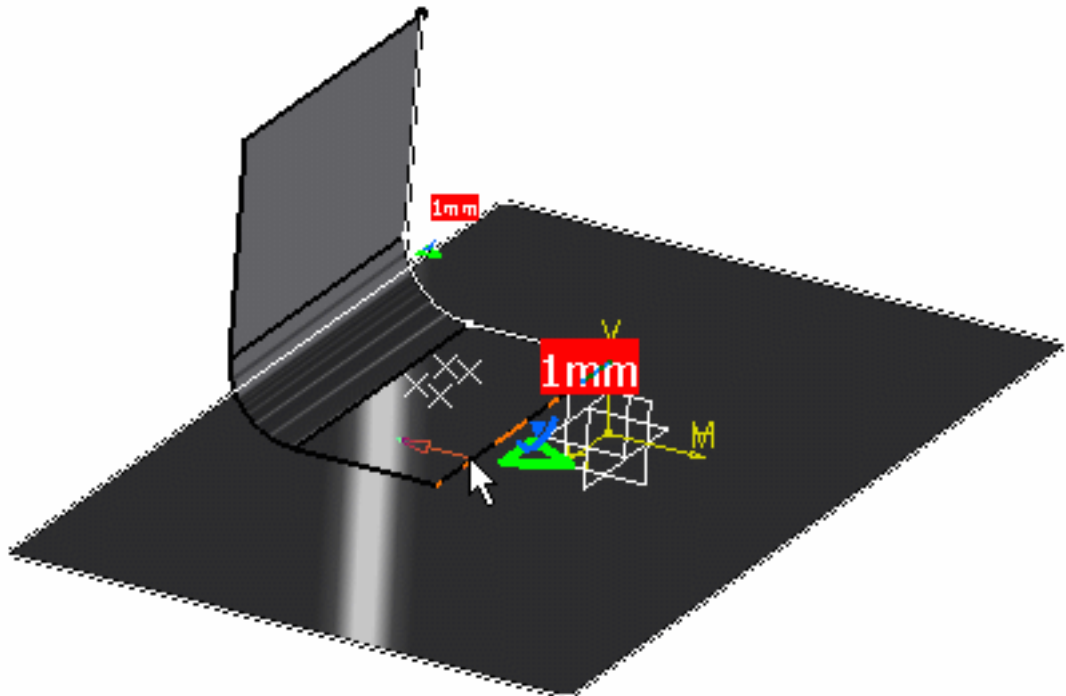

7. Click **OK** in the Line Analysis Connection dialog box.

The **Line Analysis Connection.1** object appears in the specification tree under the **Analysis Connection Manager.1** set.

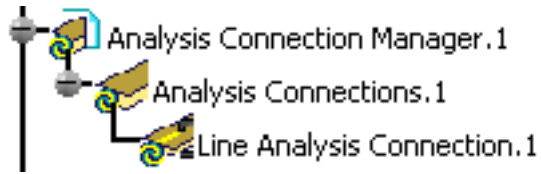

- You can update design connections. For this:
  - right-click the **Analysis Connection Manager.1** set in the specification tree
  - select the **Update all analysis connections** contextual menu.
- You can now apply a connection property on the connection you just have created. For more details, please refer to [Creating Seam Welding Connection Property](#).



# Line Analysis Connection Within One Part



This task will show you how to create a Line Analysis Connection Within One Part.

Line analysis connections within one part are used for simulating welding seam onto parallel faces, belonging to the same part.



This functionality is only available in the **Generative Assembly Structural Analysis (GAS)** product.



Open the [sample09.CATAnalysis](#) from the sample directory.



1. Click the **Line Analysis Connection within one Part** icon .

The Line Analysis Connection within one Part dialog box appears.

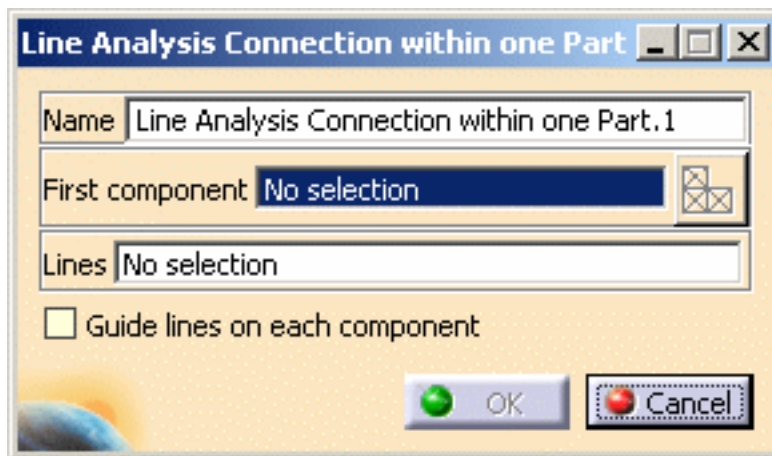

- o **Name:** lets you change the name of the connection.
- o **First component:** lets you select the part that will support the connection.



You can select one body (2D or 3D).

- **Select Mesh Parts:** this button is available only if a support is selected. For more details, please click [here](#).

- o **Lines:** lets you select the welding line.



Multi-selection is not available.

- o **Guide line on each component:** lets you select a second line that will guide the connection orientation.

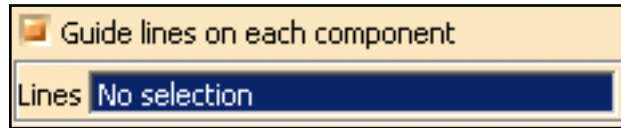

2. Select the open body.

For this particular example, select the **Extrude.1** open body.

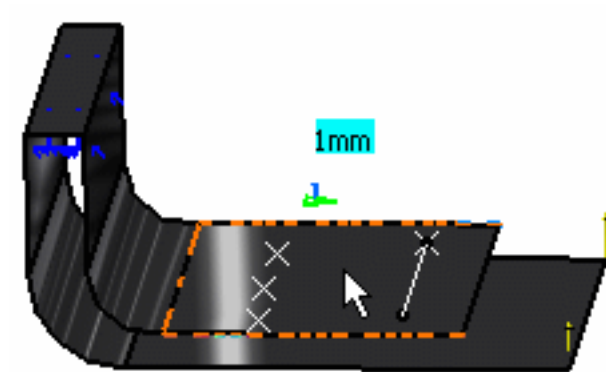

3. Activate the **Lines** field.

For this, select the **Lines** edit box as shown bellow:

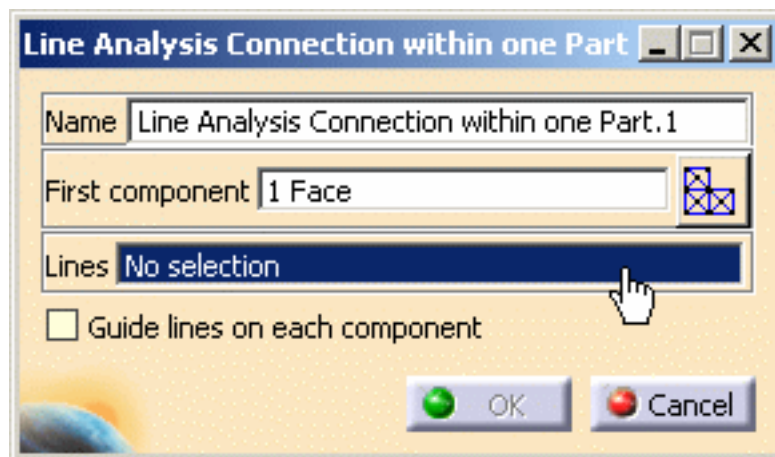

4. Select the line.



In this particular example, select the **Line.1** object under the **Open body.2 (Points)** open body.

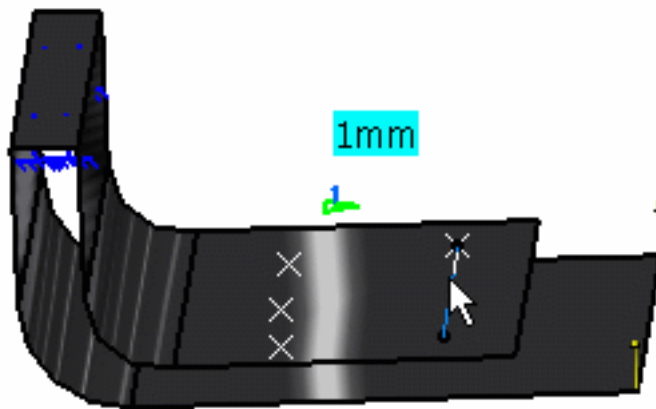

5. Click **OK** in the Line Analysis Connection within one Part dialog box.

The **Line Analysis Connection within one Part.1** object appears in the specification tree under the **Analysis Connection Manager.1** set.

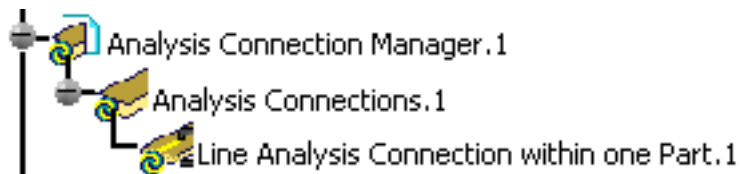

- You can update design connections. For this:
  - right-click the **Analysis Connection Manager.1** set in the specification tree
  - select the **Update all analysis connections** contextual menu.
- You can now apply a connection property on the connection you just have created. For more details, please refer to [Creating Seam Welding Connection Property](#).





# Surface Analysis Connection



This task will show you how to create a Surface Analysis Connection.

Surface analysis connections are used for simulating welding surface onto parallel faces, on an assembly model.



- This functionality is only available in the **Generative Assembly Structural Analysis (GAS)** product .
- The connection has to connect two bodies (2D or 3D).
- Multi-selection is not available.





Open the [sample11.CATAnalysis](#) from the samples directory.

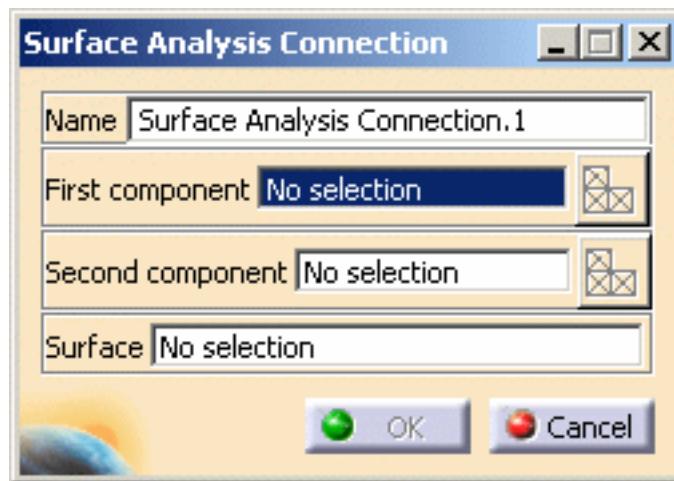

1. Click the **Surface Analysis Connection** icon .

The Surface Analysis Connection dialog box appears.



- **Name:** lets you change the name of the connection.
- **First component:** lets you select the first "side" of the part that will support the connection.
  -  Multi-selection is not available.
  - You can select a 2D body, 3D body or a mesh part as support.
  - **Select Mesh Parts:** this button is available only if a support is selected. For more details, please click [here](#).

- **Second component:** lets you select the second "side" of the part that will support the connection.
  - ⓘ
    - Multi-selection is not available.
    - You can select a 2D body, 3D body or a mesh part as support.
  - **Select Mesh Parts:** this button is available only if a support is selected. For more details, please click [here](#).
- **Surface:** lets you select the welding surface.
  - ⓘ
    - Multi-selection is not available.
    - You can only select a 2D body as adhesive surface.

**2.** Select the first component.

In this particular example, select **Support.1 - Fill.4**.

**3.** Activate the **Second component** field.

For this, select the **Second component** edit box as shown below:

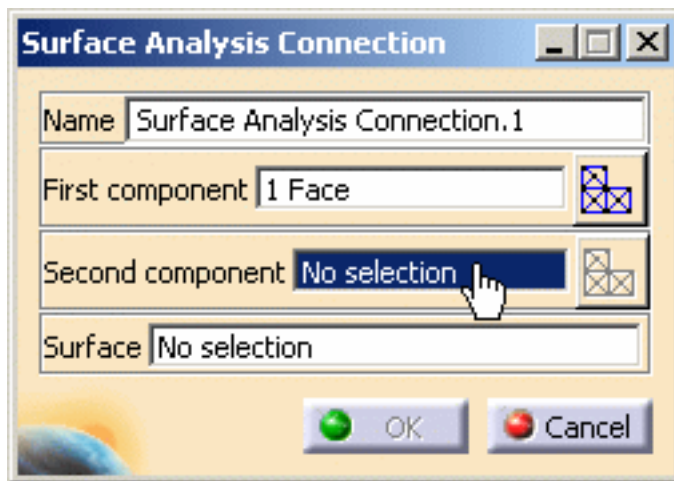

**4.** Select the second component.

In this particular example, select **Support.2 - Fill.3**.

**5.** Activate the **Surface** field.

For this, select the **Surface** edit box as shown below:

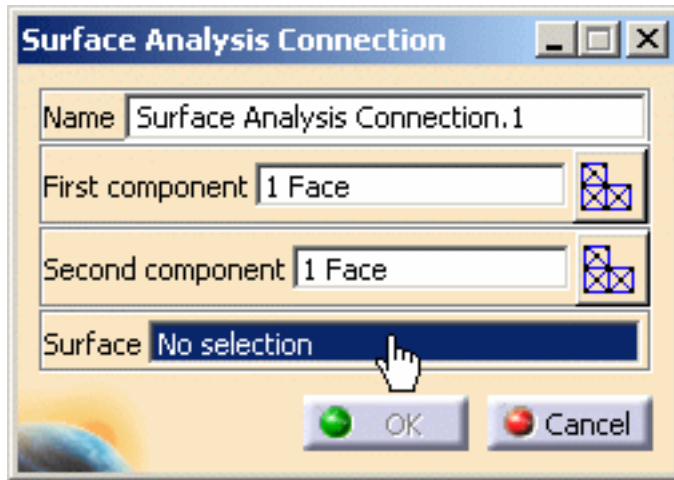

6. Select the desired surface.

In this particular example, select **Surface.1 - Fill.3** as shown below:

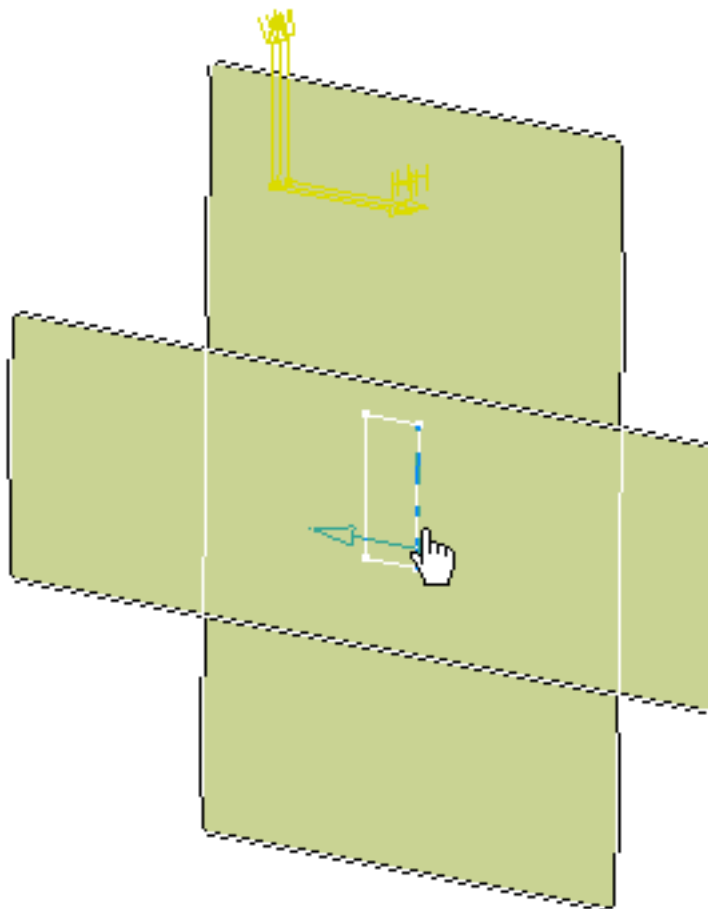

7. Click **OK** in the Surface Analysis Connection dialog box.

The **Surface Analysis Connection.1** object appears in the specification tree under the **Analysis Connection Manager.1** set.

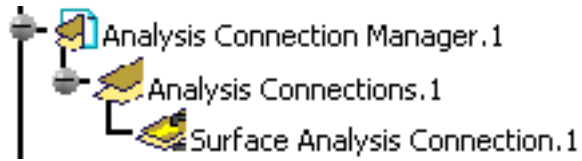

- You can update design connections. For this:
  - right-click the **Analysis Connection Manager.1** set in the specification tree
  - select the **Update all analysis connections** contextual menu.
- You can now apply a connection property on the connection you just have created. For more details, please refer to [Creating Surface Welding Connection Property](#).





# Surface Analysis Connection Within One Part



This task will show you how to create a Surface Analysis Connection Within One Part. Surface analysis connections within one part are used for simulating welding surface onto parallel faces, belonging to the same part.



This functionality is only available in the **Generative Assembly Structural Analysis (GAS)** product.





Open the [sample11.CATAnalysis](#) from the sample directory.

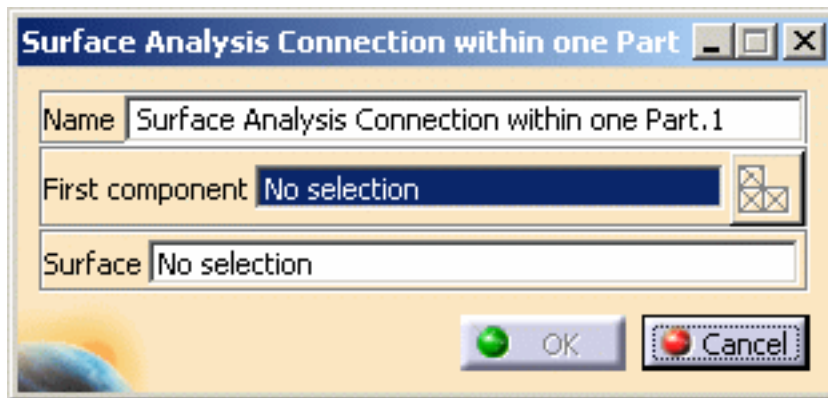

1. Click the **Surface Analysis Connection within one Part** icon .

The Surface Analysis Connection within one Part dialog box appears.



- o **Name:** lets you change the name of the connection.
- o **First component:** lets you select the part that will support the connection.
  - o  Multi-selection is not available.
  - o You can select a 2D body, 3D body or a mesh part as support.
  - o **Select Mesh Parts:** this button is available only if a support is selected. For more details, please click [here](#).
- o **Surface:** lets you select the welding surface.
  - o  Multi-selection is not available.
  - o You can only select a 2D body as adhesive surface.

2. Select the support.

In this particular example, select **OneSupport - Extrude.1** as shown bellow:

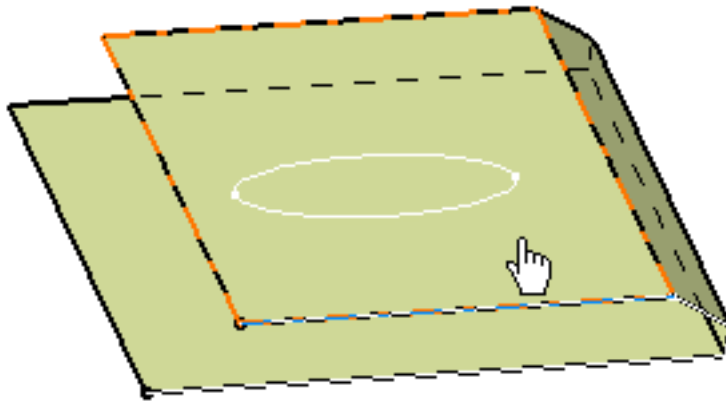

3. Activate the **Surface** field.

For this, select the **Surface** edit box as shown bellow:

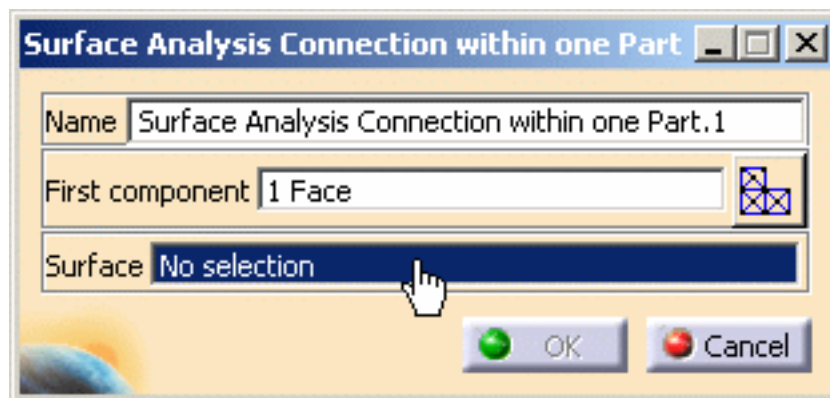

4. Select the desired surface.

In this particular example, select **Surface.2 - Fill.5** as shown bellow:

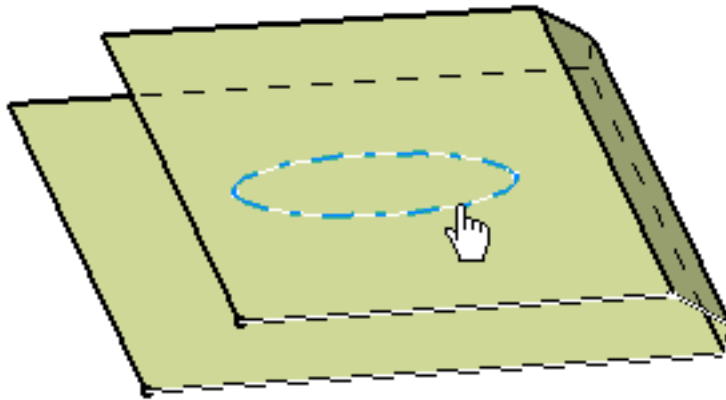

5. Click **OK** in the Surface Analysis Connection within one Part dialog box.

The **Surface Analysis Connection within one Part.1** object appears in the specification tree under the **Analysis Connection Manager.1** set.

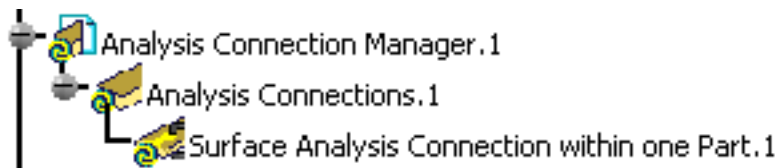

- You can update design connections. For this:
  - right-click the **Analysis Connection Manager.1** set in the specification tree
  - select the **Update all analysis connections** contextual menu.
- You can now apply a connection property on the connection you just have created. For more details, please refer to [Creating Surface Welding Connection Property](#).





# Connection Properties



The following functionalities are only available in the **Generative Assembly Structural Analysis (GAS)** product.

*Connections properties* are assembly connections used to specify the boundary interaction between bodies in an assembled system. Once the geometric assembly positioning constraints are defined at the Product level, the user can specify the physical nature of the constraints.



## About Connection Properties

Give information about connection properties.

## Face Face Connection Properties



### Create Slider Connection Properties

Fasten bodies together at their common interface in the normal direction while allowing them to slide relative to each other in the tangential directions.



### Create Contact Connection Properties

Prevent bodies from penetrating each other at a common interface.



### Create Fastened Connection Properties

Fasten bodies together at their common interface.



### Create Fastened Spring Connection Properties

Create an elastic link between two faces.



### Create Pressure Fitting Connection Properties

Prevent bodies from penetrating each other at a common interface.



### Create Bolt Tightening Connection Properties

Prevent bodies from penetrating each other at a common interface.

## Distant Connection Properties



### Create Rigid Connection Properties

Create a link between two bodies which are stiffened and fastened together at their common boundary, and will behave as if their interface was infinitely rigid.



### Create Smooth Connection Properties

Create a link between two bodies which are fastened together at their common boundary, and will behave approximately as if their interface was soft.



### Create Virtual Rigid Bolt Tightening Connection Properties

Take into account pre-tension in a bolt-tightened assembly in which the bolt is not included.



### Create Virtual Spring Bolt Tightening Connection Properties

Specify the boundary interaction between bodies in an assembled system.



### Customize User-Defined Connection Properties

Specify the types of elements as well as their associated properties included inside a distant connection.

## Weld Connection Properties



### Create Spot Welding Connection Properties

Create a link between two bodies, using analysis welding point connections.



### Create Seam Weld Connection Properties

Create a link between two bodies, using analysis seam weld connections.



### Create Surface Weld Connection Properties

Create a link between two bodies, using analysis surface weld connections.

# About Connection Properties

When you want to use the connection properties of the **Generative Assembly Structural Analysis product**, you first need to define a connection that the connection property will reference.

The connections can be created in different ways:

- in a product context:
  - **Assembly Constraints** in the *Assembly Design workbench*
  - **Welding Joints** in the *Body in White Fastener workbench*
  - **Joint Connections** in the the *Ship Structure Detail Design workbench*
  - **Analysis Connections** created before V5R12
-  The former Analysis Connections are still maintained but you cannot create them any more.
- in an analysis context:
  - **Analysis Connections** in the *Generative Structural Analysis workbench* (from V5R12)

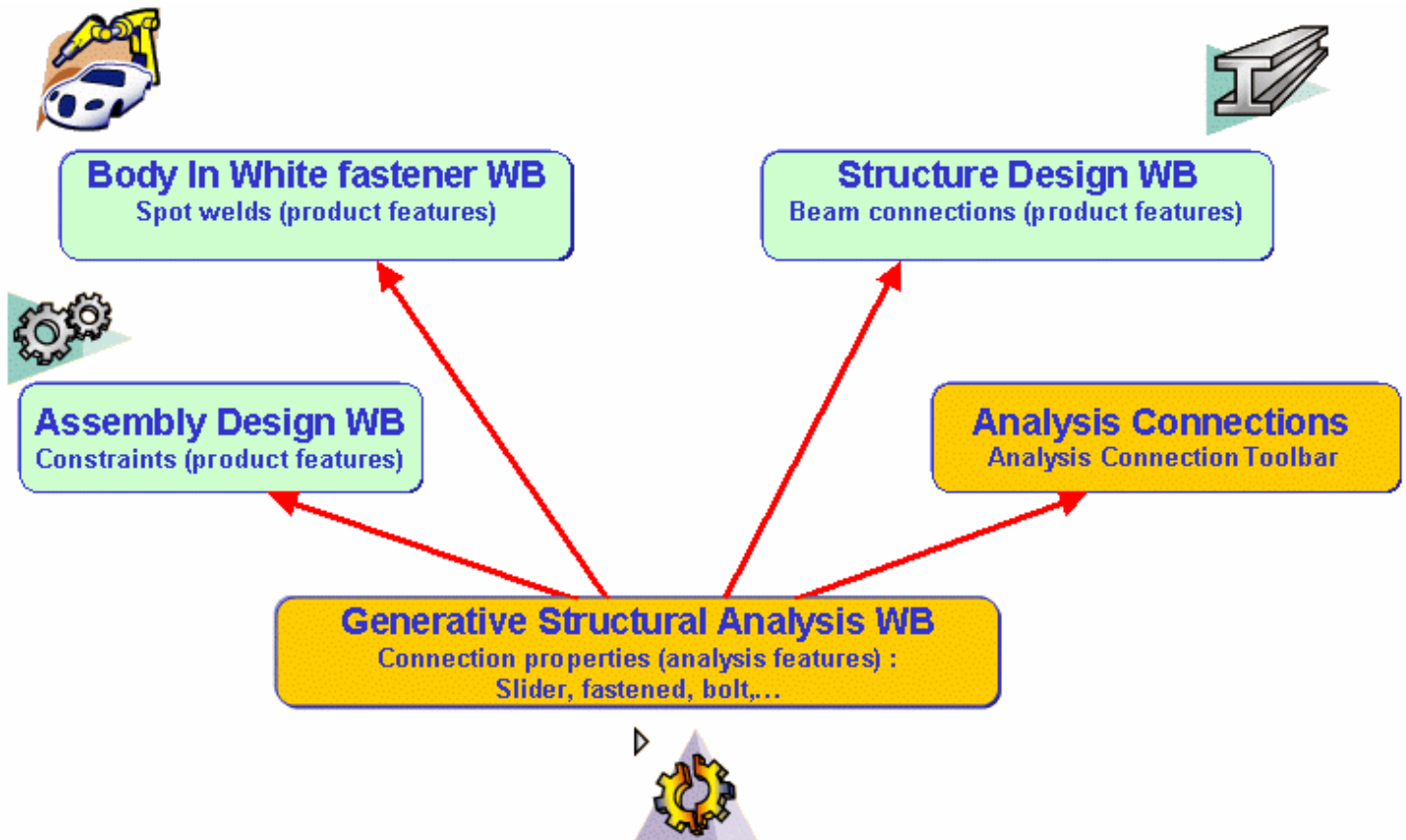

## Why you will use Connections of the Analysis Workbench?

In some cases, constraints are not sufficient to modelize connections from an Analysis viewpoint:

1. In order to support properties, users often need to define too many constraints using the *Assembly Design workbench*, leading to over-constrained models that cannot be updated.
2. It is impossible to define constraints that are not positioning constraints but connection constraints.
3. It is impossible to select several geometries to define connections in a product context.
4. It is impossible to select a mechanical feature to define connections in a product context.

In order to meet these different needs, a new **Analysis Connection** toolbar was added to the **Generative Assembly Structural Analysis** product of the *Generative Structural Analysis workbench*. This toolbar lets you create all these connections dedicated to analysis modeling.

# What Type of Hypotheses are Used for Analysis?

You will find here below three types of hypotheses used when working in Analysis workbench.

1. Small displacement (translation and rotation)
2. Small strain
3. Linear constitutive law: linear elasticity

For static case solutions, one can say that:

- If there is no contact feature (either virtual or real), no pressure fitting property and no bolt tightening (being virtual or not) feature, then the problem is **linear**, that is to say, the displacement is a linear function of the load.
- In other cases, the problem is **non linear**, that is to say, the displacement is a non linear function of the load.

# What Type of Property For What Type of Connection?

## Welding Connections Properties

- Spot Welding Connection Property:
  - **Point Analysis Connection** defined in the *Generative Structural Analysis workbench* (from V5R12)
  - **Point Analysis Connection within one Part** defined in the *Generative Structural Analysis workbench* (from V5R12)
  - **Joint Body** containing at least a (point) **Joint Element** and defined in the *Body in White Fastener workbench*
  - **Spot Welding Analysis Connection** defined (before V5R12)
- Seam Weld Connection Property:
  - **Line Analysis Connection** defined in the *Generative Structural Analysis workbench* (from V5R12)
  - **Line Analysis Connection within one Part** defined in the *Generative Structural Analysis workbench* (from V5R12)
  - **Joint Body** containing at least a (line) **Joint Element** and defined in the *Body in White Fastener workbench*
  - **Spot Welding Analysis Connection** defined (before V5R12)
- Surface Weld Connection Property:
  - **Surface Analysis Connection** defined in the *Generative Structural Analysis workbench*
  - **Surface Analysis Connection within one Part** defined in the *Generative Structural Analysis workbench*

## Other Connection Properties

When you define a connection property, you can select as support:

- **General Analysis Connection** of the *Generative Structural Analysis workbench* (from V5R12)
- Assembly Constraints (**Contact Constraint**, **Coincidence Constraint** or **Offset Constraint**) of the *Assembly Design workbench*
- **General Analysis Connection** and **Face Face Analysis Connection** created before V5R11

## General Analysis Connection (from V5R12)

Connection Properties	Point / Point	Point / Line	Point / Face	Point / Mechanical Feature	Line / Line	Line / Face	Line / Mechanical Feature	Face / Face	Face / Mechanical Feature	Mechanical Feature / Mechanical Feature
Slider		▲	▲	▲	▲	▲	▲	▲	▲	▲
Contact		▲	▲	▲	▲	▲	▲	▲	▲	▲
Fastened		▲	▲	▲	▲	▲	▲	▲	▲	▲
Fastened Spring		▲	▲	▲	▲	▲	▲	▲	▲	▲
Pressure Fitting		▲	▲		▲	▲		▲		

<b>Bolt Tightening</b>										
<b>Rigid</b>					*	*	*	*	*	*
<b>Smooth</b>					*	*	*	*	*	*
<b>Virtual Rigid Bolt Tightening</b>										
<b>Virtual Spring Bolt Tightening</b>										
<b>User-Defined</b>										
* with optional handler point										

## Assembly Constraints

	<b>Point / Point</b>	<b>Point / Line</b>	<b>Point / Face</b>	<b>Line / Line</b>	<b>Line / Face</b>	<b>Face / Face</b>
<b>Slider</b>				Contact Coincidence	Contact Coincidence	Contact Coincidence
<b>Contact</b>				Contact Coincidence	Contact Coincidence	Contact Coincidence
<b>Fastened</b>				Contact Coincidence	Contact Coincidence	Contact Coincidence
<b>Fastened Spring</b>				Contact Coincidence	Contact Coincidence	Contact Coincidence
<b>Pressure Fitting</b>				Contact Coincidence	Contact Coincidence	Contact Coincidence
<b>Bolt Tightening</b>				Contact Coincidence	Contact Coincidence	Contact Coincidence
<b>Rigid</b>		Contact	Contact	Contact *	Contact *	Contact *
<b>Smooth</b>		Contact	Contact	Contact *	Contact *	Contact *
<b>Virtual Rigid Bolt Tightening</b>		Contact Coincidence Offset	Contact Coincidence Offset	Contact Coincidence Offset	Contact Coincidence Offset	Contact Coincidence Offset
<b>Virtual Spring Bolt Tightening</b>		Contact Coincidence Offset	Contact Coincidence Offset	Contact Coincidence Offset	Contact Coincidence Offset	Contact Coincidence Offset
<b>User-Defined</b>	Contact	Contact	Contact	Contact	Contact	Contact
* with optional handler point						

## Former General Analysis Connections and Face Face Analysis Connections (before V5R12)

	<b>Point / Point</b>	<b>Point / Line</b>	<b>Point / Face</b>	<b>Line / Line</b>	<b>Line / Face</b>	<b>Face / Face</b>
<b>Slider</b>				General Face Face	General Face Face	General Face Face
<b>Contact</b>				General Face Face	General Face Face	General Face Face
<b>Fastened</b>				General Face Face	General Face Face	General Face Face
<b>Fastened Spring</b>				General Face Face	General Face Face	General Face Face
<b>Pressure Fitting</b>				Face Face	Face Face	Face Face
<b>Bolt Tightening</b>				Face Face	Face Face	Face Face
<b>Rigid</b>		General	General	General *	General *	General *
<b>Smooth</b>		General	General	General *	General *	General *
<b>Virtual Rigid Bolt Tightening</b>		General	General	General	General	General
<b>Virtual Spring Bolt Tightening</b>		General	General	General	General	General
<b>User-Defined</b>	General	General	General	General	General	General
* with optional handler point						



## Precisions and Restrictions

Here you will find precisions and restrictions for certain connection properties.

- **Slider: Slider Connection Property**

- The slider direction is defined according to the geometry on which the joins are landed.



If you select a former Face Face Analysis Connection (before V5R12) as support, the slider directions are automatically parallel or coaxial.

- **Contact: Contact Connection Property, User-Defined Distant Connection Property** (if you select Contact as **Start** or **End** option).

- Can be generated only on a geometry belonging to a 3D body.

- **Pressure Fitting: Pressure Fitting Connection Property**

- Can be generated only on a geometry belonging to a 3D body.

- The fitting direction is defined according to the geometry on which the joins are landed.



If you select a former Face Face Analysis Connection (before V5R12) as support, the slider directions are automatically parallel or coaxial.

- **Bolt: Bolt Tightening Connection Property, Virtual Bolt Tightening Connection Property, Virtual Spring Bolt Tightening Connection Property, User-Defined Distant Connection Property** (if you select Bolt as **Middle** option)

- On each side of the assembly, multi-selection of geometry is available.

In this case, if a geometry has a revolution axis, the other geometries (belonging to the same side of the assembly) must have a revolution axis that must be the same.

- Moreover, if the two sides have a revolution axis (tightening direction), this axis must be the same.

- **User-Defined: User-Defined Distant Connection Property**

- cf. **Contact**

- cf. **Bolt**

# Creating Slider Connection Properties



This task shows how to create a Slider Connection Property between two parts.



- This functionality is only available in the **Generative Assembly Structural Analysis (GAS)** product.
- To have precisions and to know restrictions, please refer to [About Connection Properties](#).



A *Slider Connection* is the link between two bodies which are constrained to move together in the local normal direction at their common boundary, and will behave as if they were allowed to slide relative to each other in the local tangential plane. Since bodies can be meshed independently, the slider connection is designed to handle incompatible meshes.

The slider connection relations take into account the elastic deformability of the interfaces.

The program proceeds as follows:

- each node of the finer surface mesh is projected parallel to the local outer normal of the first surface onto the second surface mesh.
- a projection point is located whenever possible at the intercept of the projection direction with the second surface mesh (extrapolated at the face boundary by roughly half an element width).
- if a projection point exists, the start node is connected by a kinematical spider element to all nodes of the element face on which the projection point has landed.
- a set of join-type relations (involving interpolation using element shape functions and a rig-beam relations) is computed between the start node degrees of freedom and the connected nodes degrees of freedom.
- these relations are projected on the local normal direction yielding a single scalar relation between the start node degrees of freedom and the connected nodes degrees of freedom.

Thus, the slider connection generates at most as many spider kinematical elements as there are nodes on the finer surface mesh for which a projection onto the opposite surface mesh exists.

To know more about the Slider Join element, see [Slider Join](#) in the *Finite Element Reference Guide*.



Open the [sample16.CATAnalysis](#) document: you applied constraints to the assembly (**Assembly Design** workbench).

### Before You Begin:

- Make sure you created a Finite Element Model containing a Static Analysis Case from this assembly.
- Make sure you know all you need about [what type of property you will use for what type of connection](#).



1. Click the **Slider Connection Property** icon .

The Slider Connection Property dialog box appears.

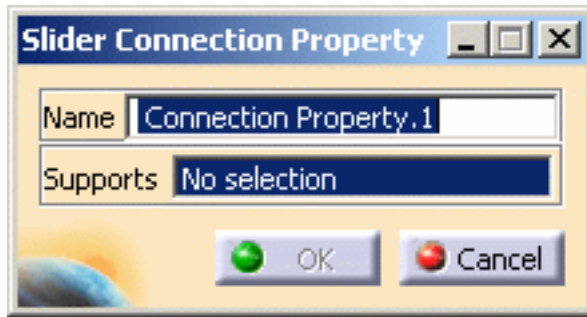

2. Select an assembly constraint previously created in the Assembly Design workbench.



The only allowed constraint type is Contact between surfaces.

A symbol representing the slider connection property is visualized on the corresponding faces.



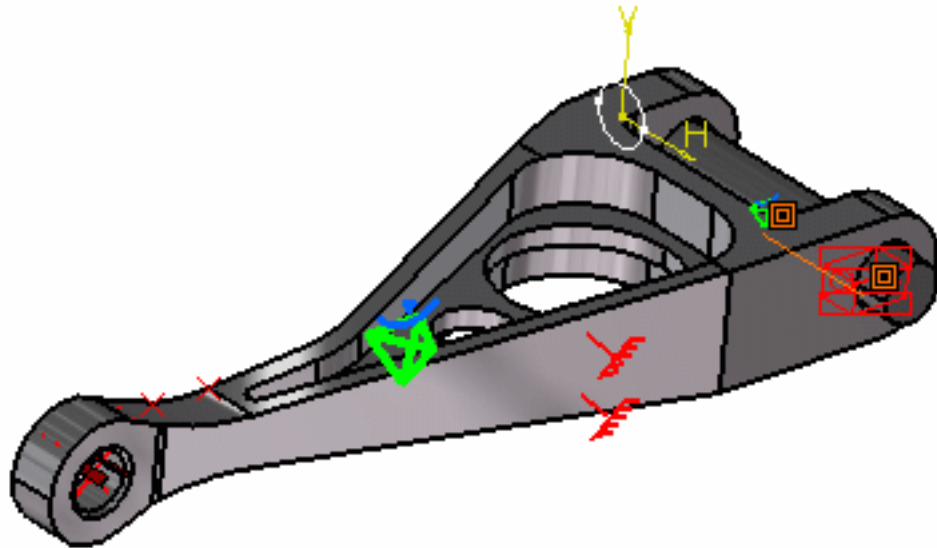

3. Click **OK** in the Slider Connection Property dialog box.

Note that two elements appear in the specification tree:

- a **Slider Connection Mesh.1** object under the **Nodes and Elements** set,
- a **Slider Connection Property.1** object appears in the specification tree under the **Properties.1** set.

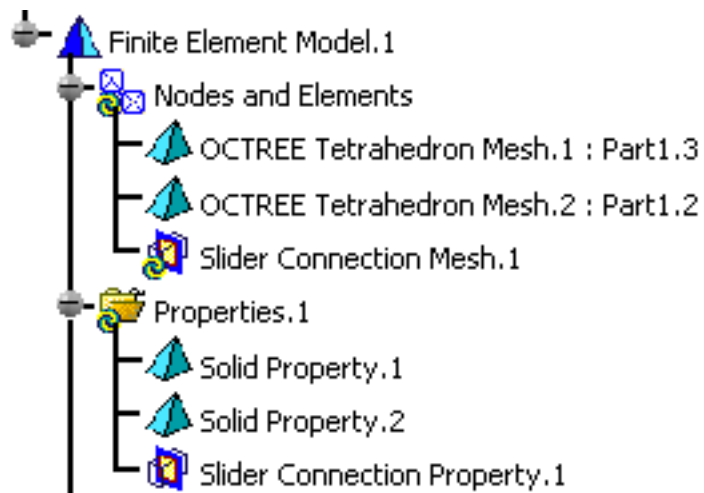

- The Finite Element Model contains two Mesh objects, one for each part of the assembly.
- The sizes of the two meshes are different as can be seen by comparing the Mesh Size symbols.



# Creating Contact Connection Properties



This task shows how to create a Contact Connection between two parts.



- The following functionality is only available in the **Generative Assembly Structural Analysis (GAS)** product .
- To have precisions and to know restrictions, please refer to [About Connection Properties](#).
- The Gradient method is not available if several Contact connections reference the same degree of freedom.  
In this case, try to choose another method type.



A *Contact Connection* is the link between two part bodies which are prevented from interpenetrating at their common boundary, and will behave as if they were allowed to move arbitrarily relative to each other as long as they do not come into contact within a user-specified normal clearance. When they come into contact, they can still separate or slide relative to each other in the tangential plane, but they cannot reduce their relative normal clearance. Since part bodies can be meshed independently, the Contact Connection is designed to handle incompatible meshes.

The Contact Connection relations take into account the elastic deformability of the interfaces.

The program proceeds as follows:

- each node of the finer body surface mesh is projected parallel to the local outer normal of the first surface onto the second surface mesh.
- a projection point is located whenever possible at the intercept of the projection direction with the second body surface mesh (extrapolated at the face boundary by roughly half an element width).
- if a projection point exists, the start node is connected by a node-to-face element with contact property to all nodes of the element face on which the projection point has landed.
- a set of join-type relations (involving interpolation using element shape functions) is computed between the projection point degrees of freedom and the degrees of freedom of the element face nodes (the projection point virtual degrees of freedom are eliminated in the process).
- rigid body kinematical relations are computed between the start node and the projection node.
- after the elimination of the projection point degrees of freedom, a contact relation is generated by projecting these relations in the local normal direction yielding a single

scalar inequality between the start node degrees of freedom and the degrees of freedom of the element face nodes, with a right-hand side equal to the user-defined clearance.

Thus, the Contact Connection generates at most as many node-to-face elements with contact property as there are nodes on the finer surface mesh for which a projection onto the opposite surface mesh exists.

To know more about the Contact Join element, see [Contact Join](#) in the *Finite Element Reference Guide*.



Open the [sample16.CATAnalysis](#) document: you applied constraints to the assembly (**Assembly Design** workbench).

### Before You Begin:

- Make sure you created a Finite Element Model containing a Static Analysis Case from this assembly.
- Make sure you know all you need about [what type of property you will use for what type of connection](#).



1. Click the **Contact Connection Property** icon .

The Contact Connection Property dialog box appears.

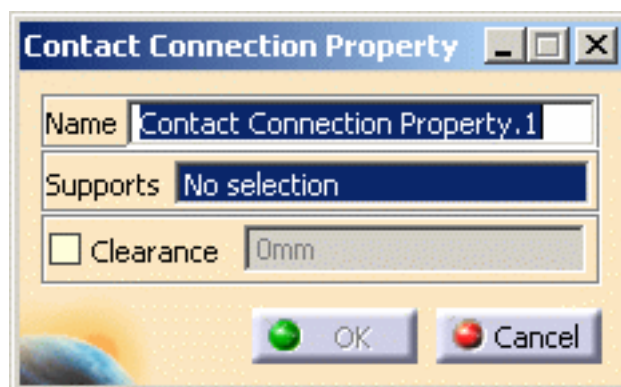

The **Clearance** field can be used to enter an algebraic value for the maximum allowed normal clearance reduction:

- a positive clearance value (used to model a known gap between the surfaces) means that the surfaces can still come closer until they come in contact.
- a negative clearance value (used for instance to model a press-fitted clamp between the surfaces) means that the surfaces are already too close, and the program will have to push them apart.
- the default value used for the clearance represents the actual geometric

spacing between surfaces.

2. Select an assembly constraint previously created in the Assembly Design workbench.

The only allowed constraint type is Contact between body surfaces.

A symbol representing the Contact Connection is visualized on the corresponding faces.

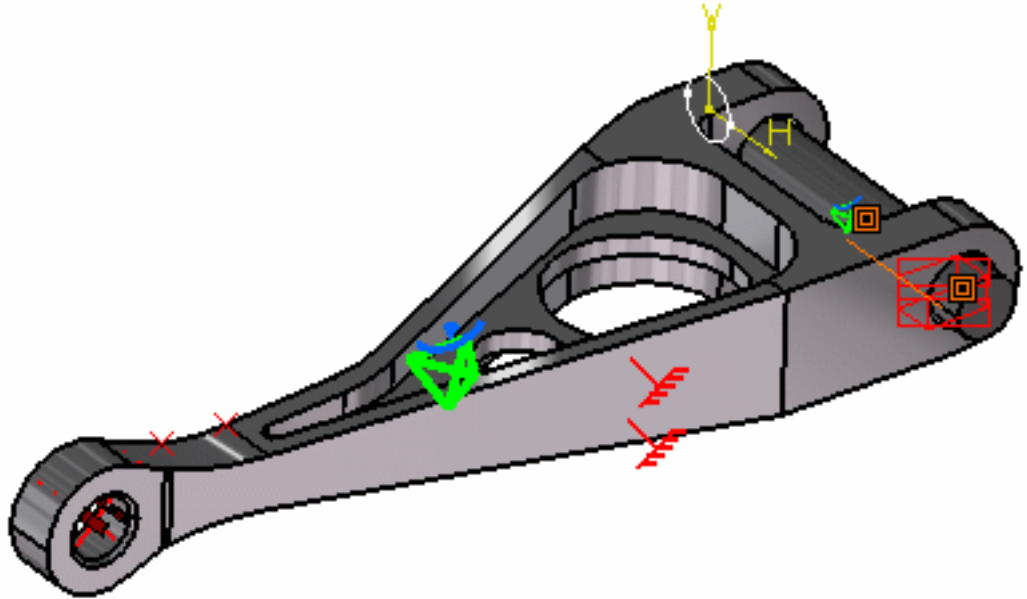

3. Optionally modify the default value of the Clearance parameter.
4. Click **OK** in the Contact Connection Property dialog box.

Note that two elements appear in the specification tree:

- a **Contact Connection Mesh.1** object under the **Nodes and Elements** set,
- a **Contact Connection Property.1** object appears in the specification tree under the **Properties.1** set.

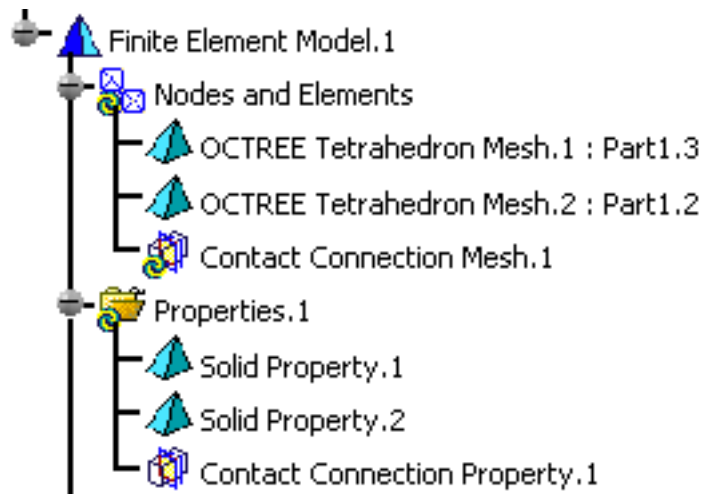

- The Finite Element Model contains two Mesh objects, one for each part of the assembly.
- The sizes of the two meshes are different as can be seen by comparing the Mesh Size symbols.



# Creating Fastened Connection Properties



This task shows how to create a Fastened Connection between two parts.



The following functionality is only available in the **Generative Assembly Structural Analysis (GAS)** product.



A *Fastened Connection* is the link between two bodies which are fastened together at their common boundary, and will behave as if they were a single body. From a finite element model viewpoint, this is equivalent to the situation where the corresponding nodes of two compatible meshes are merged together. However, since bodies can be meshed independently, the Fastened Connection is designed to handle incompatible meshes.

The Fastened Connection relations take into account the elastic deformability of the interfaces.

The program proceeds as follows:

- each node of the finer surface mesh is projected parallel to the local outer normal of the first surface onto the second surface mesh.
- a projection point is located whenever possible at the intercept of the projection direction with the second surface mesh (extrapolated at the face boundary by roughly half an element width).
- if a projection point exists, the start node is connected by a kinematical spider element to all nodes of the element face on which the projection point has landed.
- a set of join-type relations (involving interpolation using element shape functions and a rig-beam relations) is computed between the start node degree of freedom and the connected nodes degree of freedom.

Thus, the Fastened Connection generates at most as many spider kinematical elements as there are nodes on the finer surface mesh for which a projection onto the opposite surface mesh exists.

To know more about the Fastened Join element, see [Fastened Join](#) in the *Finite Element Reference Guide*.



Open the [sample16.CATAnalysis](#) document from the samples directory: you applied constraints to the assembly (**Assembly Design** workbench).

**Before You Begin:**

- Make sure you created a Finite Element Model containing a Static Analysis Case from this assembly.
- Make sure you know all you need about [what type of property you will use for what type of connection](#).



1. Click the **Fastened Connection Property** icon .

The Fastened Connection Property dialog box appears.



2. Select the assembly constraint previously created in the Assembly Design workbench.

The only allowed constraint type is Contact between surfaces.

A symbol representing the fastened connection property is visualized on the corresponding faces.

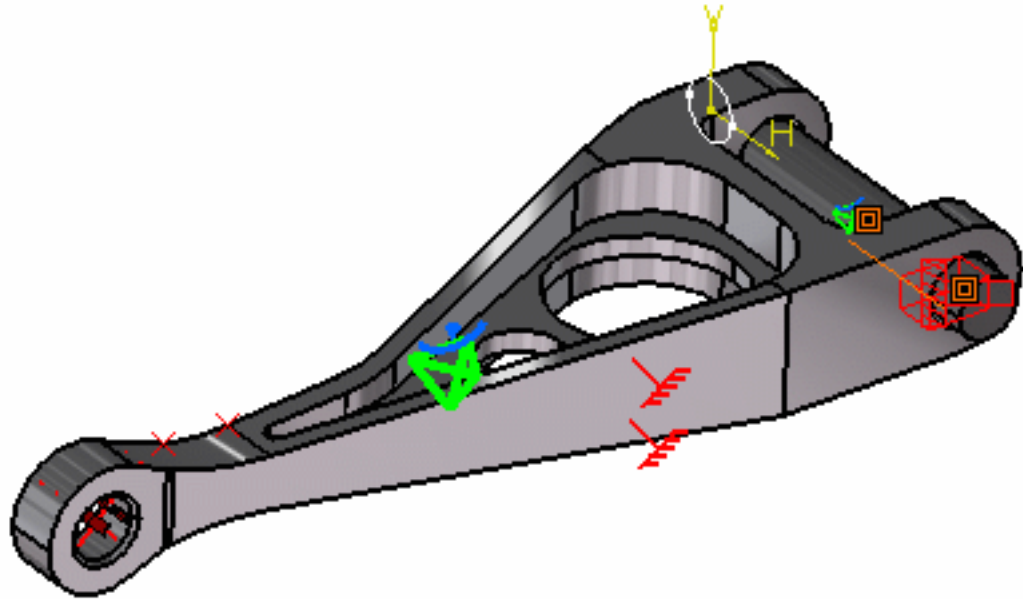

3. Click **OK** in the Fastened Connection Property dialog box.

Note that two elements appear in the specification tree:

- a **Fastened Connection Mesh.1** object under the **Nodes and Elements** set,
- a **Fastened Connection Property.1** object appears in the specification tree under the **Properties.1** set.

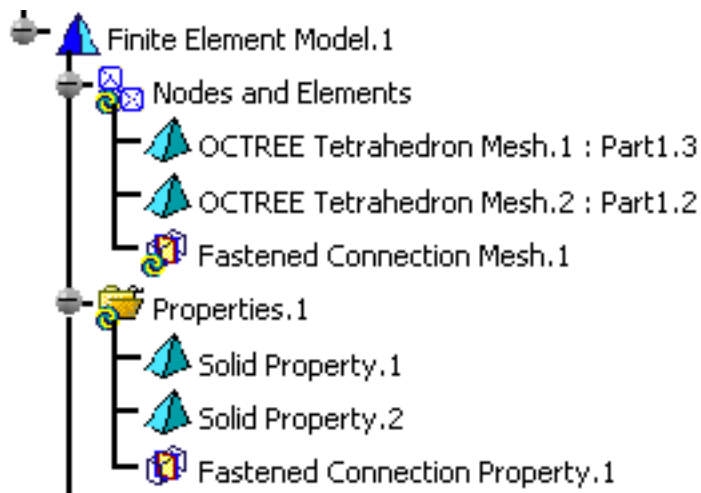

- The Finite Element Model contains two Mesh objects, one for each part of the assembly.
- The sizes of the two meshes are different as can be seen by comparing the Mesh Size symbols.





# Creating Fastened Spring Connection Properties



This task shows how to create a Fastened Spring Connection between two parts.



This functionality is only available in the **Generative Assembly Structural Analysis (GAS)** product.



A Fastened Spring Connection is an elastic link between two faces. From a finite element model viewpoint, this is equivalent to the situation where the corresponding nodes of two compatible meshes are merged together. However, since bodies can be meshed independently, the Fastened Spring Connection is designed to handle incompatible meshes.

The Fastened Spring Connection relations take into account the elastic deformability of the interfaces.

The program proceeds as follows:

- each node of the finer surface mesh is linked to a fastened spring that is itself linked to the slave node.
- rigidity is distributed on all the elements of the Fastened Spring connection. This rigidity is defined interactively.
- if a projection point exists, the start node is connected by a kinematical spider element to all nodes of the element face on which the projection point has landed.
- a set of join-type relations (involving interpolation using element shape functions and a rig-beam relations) is computed between the start node degree of freedom and the connected nodes degree of freedom.

Thus, the Fastened Connection generates at most as many spider kinematical elements as there are nodes on the finer surface mesh for which a projection onto the opposite surface mesh exists.



Open the [sample16.CATAnalysis](#) document from the samples directory: you applied constraints to the assembly (**Assembly Design** workbench).

**Before You Begin:**

- Make sure you created a Finite Element Model containing a Static Analysis Case from this assembly.
- Make sure you know all you need about [what type of property you will use for what type of connection](#).



1. Click the **Fastened Spring Connection Property** icon .

The Fastened Spring Connection Property dialog box appears.

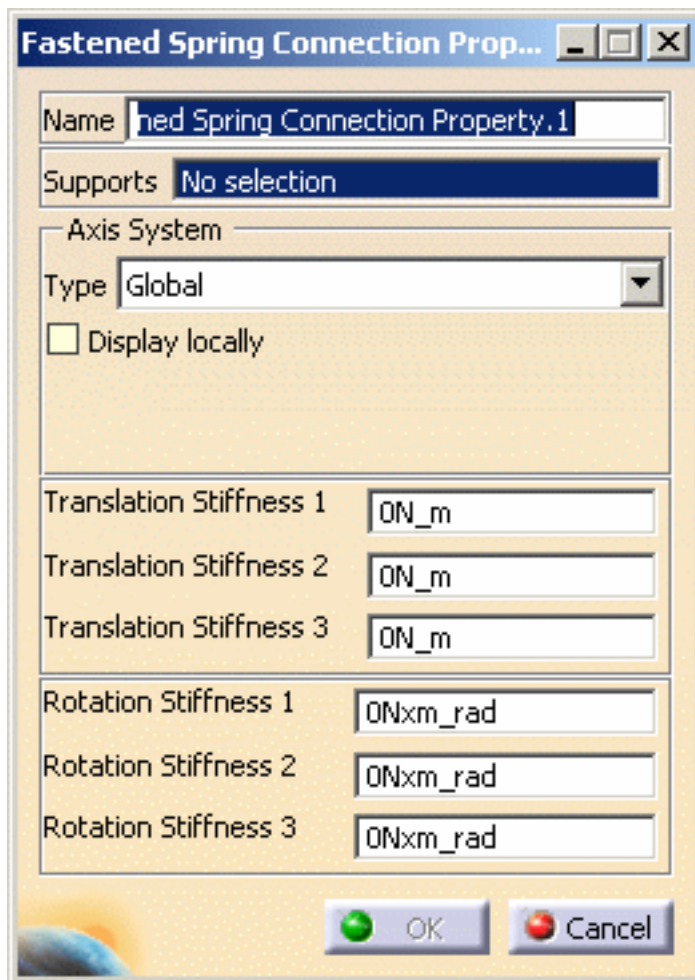

2. Select the assembly contact or coincidence constraint or joint body previously created in the Assembly Design workbench.

A symbol representing the Fastened Connection is visualized on the corresponding faces.

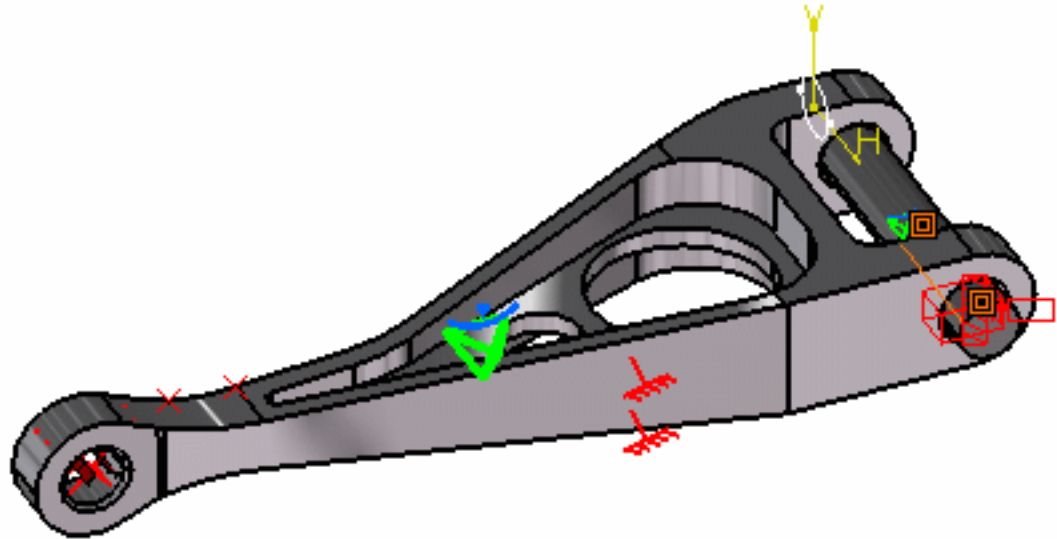

3. Enter the desired **Translation** and **Rotation** values. In this particular case, state **Translation stiffness 2** and **Translation stiffness 3** to **70N\_m**.
4. Click **OK** in the Fastened Spring Connection Property dialog box.

Note that two elements appear in the specification tree:

- o a **Spring Connection Mesh.1** object under the **Nodes and Elements** set,
- o a **Fastened Spring Connection Property.1** object appears in the specification tree under the **Properties.1** set.

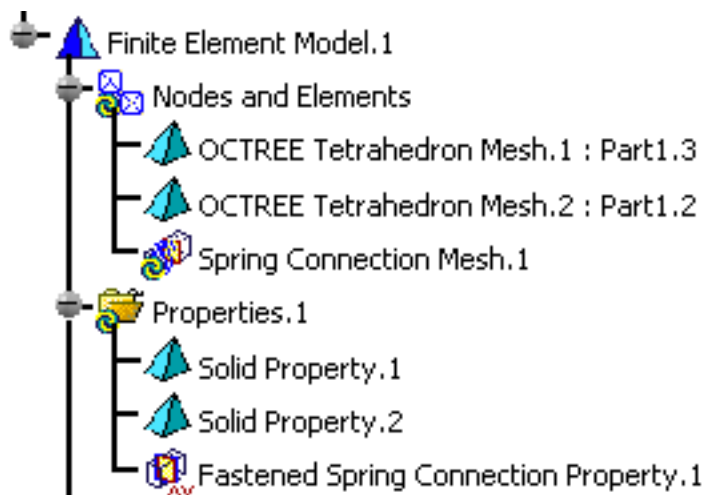

- The Finite Element Model contains two Mesh objects, one for each part of the assembly.
- The sizes of the two meshes are different as can be seen by comparing the Mesh Size symbols.



# Creating Pressure Fitting Connection Properties



This task shows how to create a Pressure Fitting Connection between two parts.



- This functionality is only available in the **Generative Assembly Structural Analysis (GAS)** product .
- To have precisions and to know restrictions, please refer to [About Connection Properties](#).
- The Gradient method is not available if several Pressure Fitting connections reference the same degree of freedom. In this case, try to choose another method type.



The pressure fitting connection uses assembly surface contact constraint as a support. A pressure fitting connection is the link between two bodies which are assembled in a Pressure Fitting configuration, more precisely when there are interferences or overlaps between both parts. Along the surface normal, the connection behaves as a [contact connection](#) with negative clearance value (positive overlap). The difference lies in the tangential directions where both parts are linked together. Since bodies can be meshed independently, the Pressure Fitting Connection is designed to handle incompatible meshes.

The Pressure Fitting Connection relations take into account the elastic deformability of the interfaces.

The program proceeds as follows:

- each node of the finer surface mesh is projected parallel to the local outer normal of the first surface onto the second surface mesh.
- a projection point is located whenever possible at the intercept of the projection direction with the second surface mesh (extrapolated at the face boundary by roughly half an element width).
- if a projection point exists, the start node is connected by a node-to-face element with contact property to all nodes of the element face on which the projection point has landed.
- a set of join-type relations (involving interpolation using element shape functions) is computed between the degrees of freedom of the start node and the degrees of freedom of element face nodes (the projection point virtual degrees of freedom are eliminated in the process).
- rigid body kinematical relations are computed between the start node and the nodes of element face.
- these relations are rotated in a coordinate system the third vector of which corresponds to the normal of the local surface.

- after the elimination of the projection point degrees of freedom, a pressure fitting relation is generated between the start node and the projected node, transforming the scalar equality relation into an inequality relation with a right-hand side equal to the minus user-defined overlap.
- two scalar equality relations are generated in the tangential plane to link the tangential displacement of the start node and its projection.

Thus, the Pressure Fitting Connection generates at most as many node-to-face elements with Pressure Fitting property as there are nodes on the finer surface mesh for which a projection onto the opposite surface mesh exists.

To know more about the generated element, see [Fitting Join](#) in the *Finite Element Reference Guide*.



Open the [sample16.CATAnalysis](#) document from the samples directory: you applied constraints to the assembly (**Assembly Design** workbench).

#### Before You Begin:

- Make sure you created a Finite Element Model containing a Static Analysis Case from this assembly.
- Make sure you know all you need about [what type of property you will use for what type of connection](#).



1. Click the **Pressure Fitting Connection Property** icon .

The Pressure Fitting Connection Property dialog box appears.

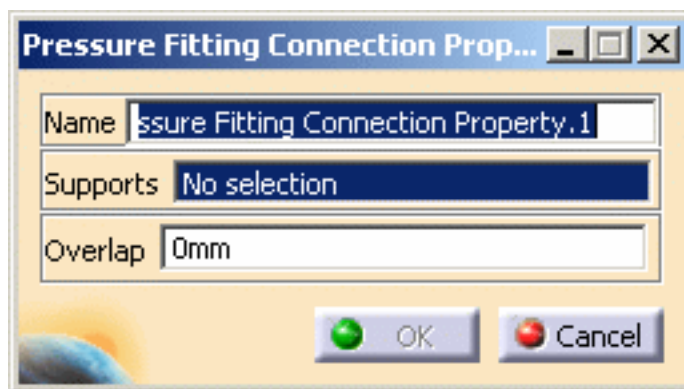

- **Name:** lets you change the name of the connection property.
- **Support:** lets you select the supports.
- **Overlap:** lets you enter an algebraic value for the maximum allowed normal clearance reduction. The overlap indicates the interference between both parts. It is intended to be positive.
  - a positive **Overlap** value (used for instance to model a press-fitted clamp)

between the surfaces) means that the surfaces are already too close, and the program will have to push them apart.

- a negative **Overlap** value (used to model a known gap between the surfaces) means that the surfaces can still come closer until they come in contact.
- the default value used for the **Overlap** represents the actual geometric spacing between surfaces.

2. Select an assembly constraint previously created in the **Assembly Design** workbench.

The only allowed constraint type is Contact between body surfaces.

A symbol representing the Pressure Fitting Connection is visualized on the corresponding faces.

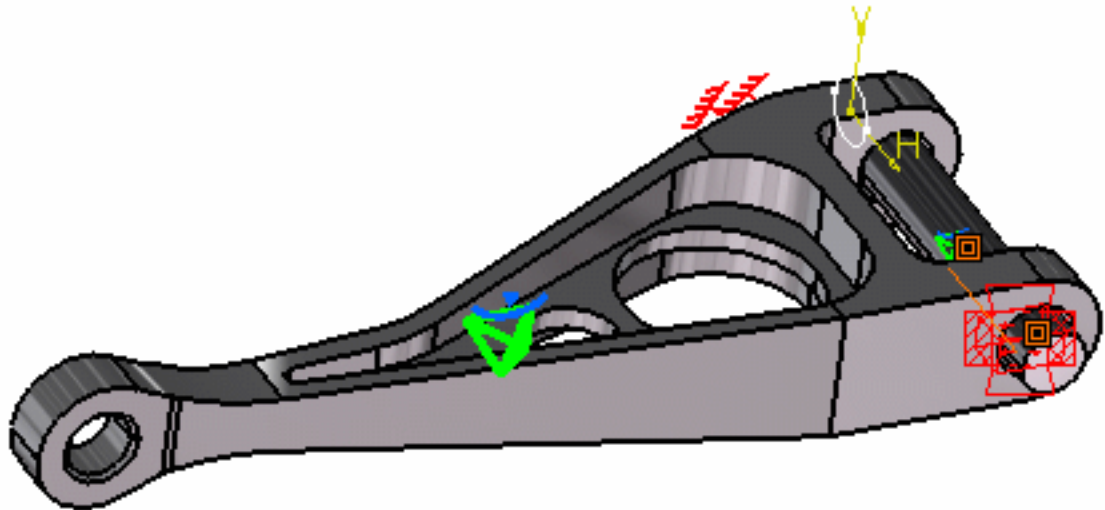

3. Optionally modify the default value of the overlap parameter. In this case, enter **0.001mm**.
4. Click **OK** in the Pressure Fitting Connection Property dialog box.

Note that two elements appear in the specification tree:

- a **Pressure Fitting Connection Mesh.1** object under the **Nodes and Elements** set,
- a **Pressure Fitting Connection Property.1** object appears in the specification tree under the **Properties.1** set.

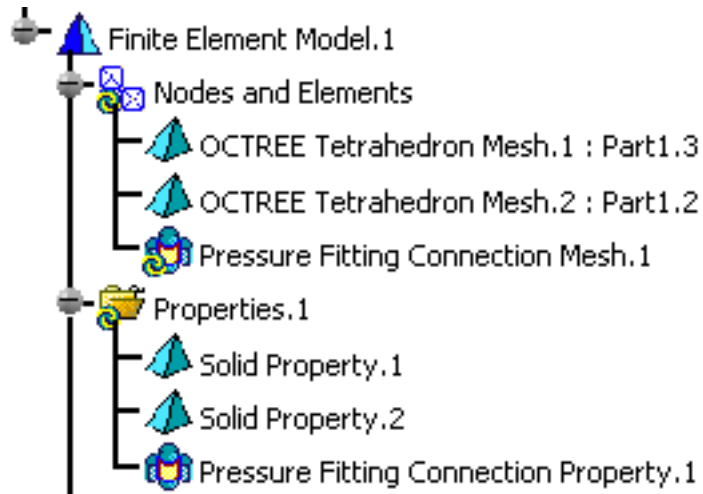

# Creating Bolt Tightening Connection Properties



This task shows how to create a Bolt Tightening Connection between two parts.



- This functionality is only available in the **Generative Assembly Structural Analysis (GAS)** product .
- To have precisions and to know restrictions, please refer to [About Connection Properties](#).
- The Gradient method is not available if several Bolt Tightening connections reference the same degree of freedom. In this case, try to choose another method type.



As a support, the bolt tightening connection requires a surface constraint of face-face type between the bolt thread and the bolt support tapping. Note that both these surfaces should be coincident.

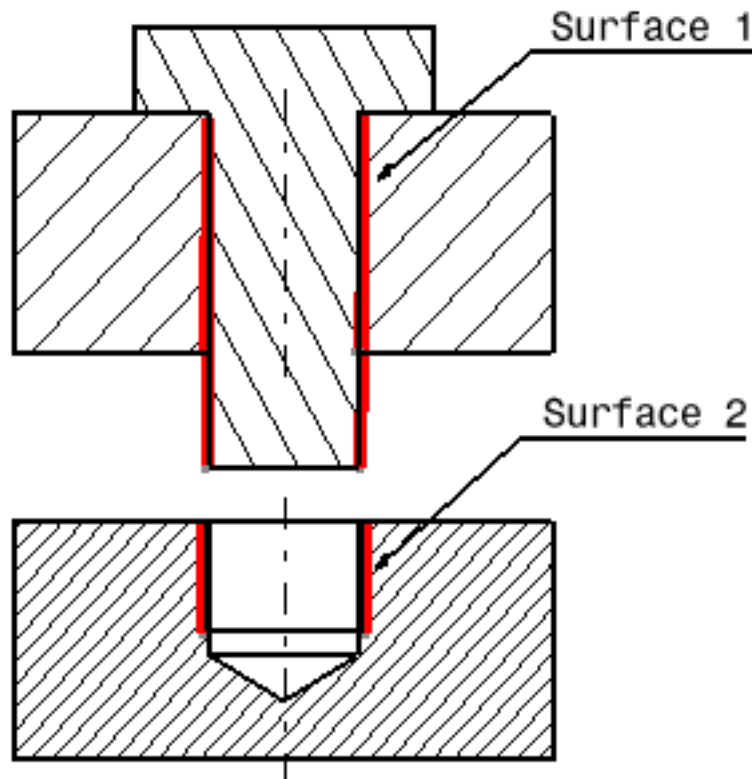

*Bolt tightening connection*



In this example, Surface 1 and Surface 2 are supports for the assembly constraint of surface contact type.

A bolt tightening connection is a connection that takes into account pre-tension in bolt-tightened assemblies. The computation is carried out according to the two-step traditional approach. In the first step of the computation, the model is submitted to tension forces relative to bolt tightening by applying opposite forces on the bolt thread and on the support tapping, respectively. Then, in the second step, the relative displacement of these two surfaces (obtained in the first step) is imposed while the model is submitted to user loads. During these two steps, the bolt and the support displacements are linked in the direction normal to the bolt axis. Since bodies can be meshed independently, the Bolt Tightening Connection is designed to handle incompatible meshes.

The Contact Connection relations take into account the elastic deformability of the interfaces.

The program proceeds as follows:

- each node of the finer surface mesh is projected parallel to the local outer normal of the first surface onto the second surface mesh.
- a projection point is located whenever possible at the intercept of the projection direction with the second surface mesh (extrapolated at the face boundary by roughly half an element width).
- if a projection point exists, the start node is connected by a node-to-face element with Bolt Tightening property to all nodes of the element face on which the projection point has landed.
- a set of join-type relations (involving interpolation using element shape functions) is computed between the degrees of freedom of the start node and the degrees of freedom of element face nodes (the projection point virtual degrees of freedom are eliminated in the process).
- rigid body kinematical relations are computed between the start node and the nodes of element face.
- after the elimination of the projection point degrees of freedom, these relations are rotated in a coordinate frame the third vector of which is aligned with the tension direction (bolt axis).
- two scalar equality relations are generated in the first two directions of the coordinate frame, in order to link the displacement of the start node and the nodes of the element face in the plane normal to the bolt axis.
- a cable relation (the reverse of a contact relation) is generated between the start node and the nodes of element face in the third direction, generating an inequality.

Thus, the Bolt Tightening Connection generates at most as many node-to-face elements with Bolt Tightening property as there are nodes on the finer surface mesh for which a

projection onto the opposite surface mesh exists.

To know more about the generated element, see [Tightening Join](#) in the *Finite Element Reference Guide*.



Open the [sample12.CATAnalysis](#) document from the samples directory.

### Before You Begin:

- Make sure you created a Finite Element Model containing a Static Analysis Case from this assembly.
- Make sure you know all you need about [what type of property you will use for what type of connection](#).



1. Click the **Bolt Tightening Connection** icon .

The Bolt Tightening Connection dialog box appears.

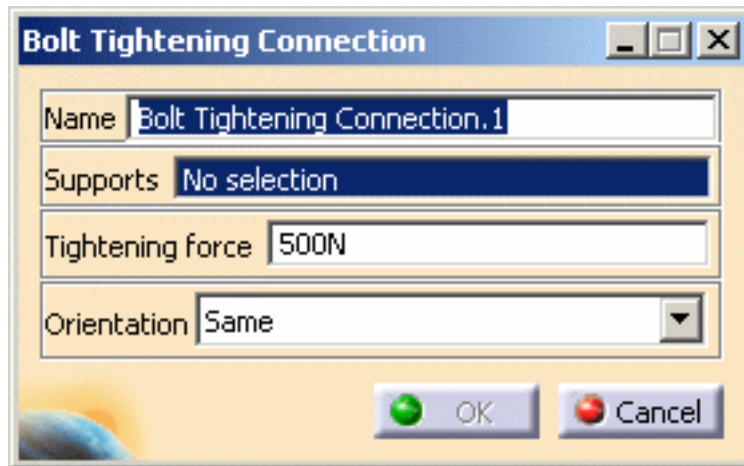

2. Select an analysis connection.

In this particular example, select the **General Analysis Connection.1** in the specification tree (under the **Analysis Connection Manager.1** set).

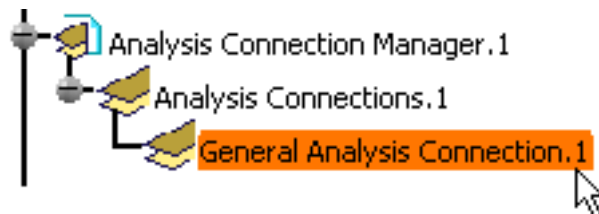

3. Optionally modify the default value of the force and orientation parameters.

Choose either the same or the opposite orientation so that the graphic representation of the Bolt Tightening Connection matches the bolt direction.

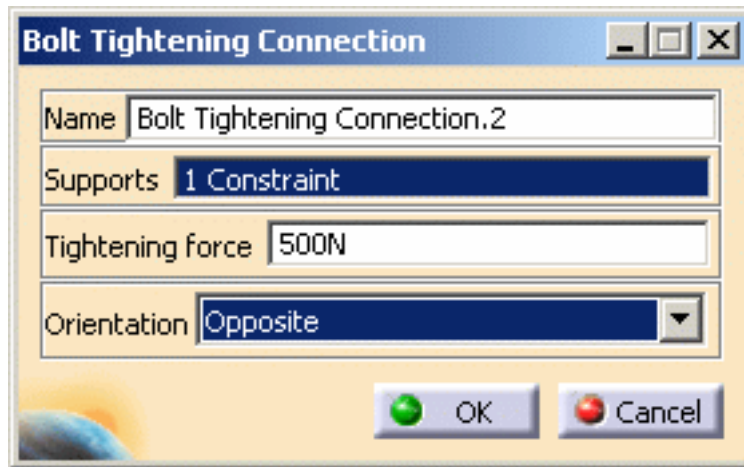

Same Orientation

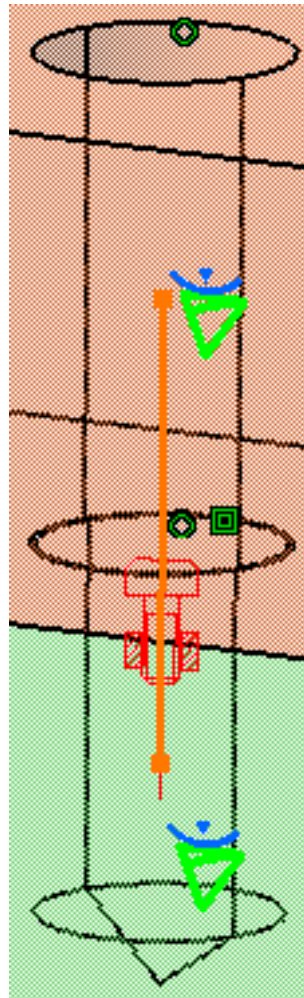

Opposite Orientation

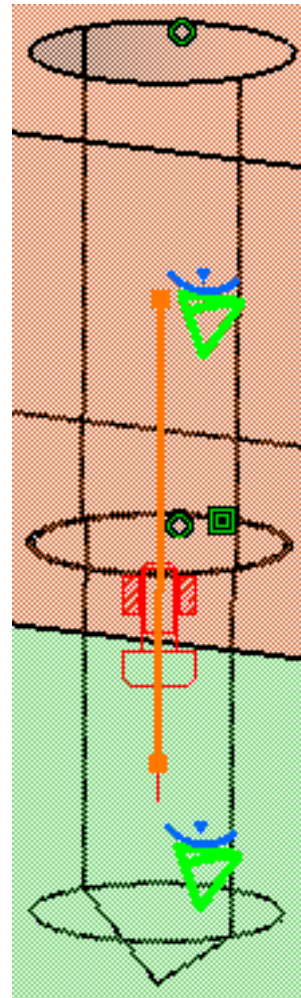

4. Click **OK** in the Bolt Tightening Connection dialog box to create the Bolt Tightening Connection.

A symbol representing the Bolt Tightening Connection is visualized on the corresponding faces.

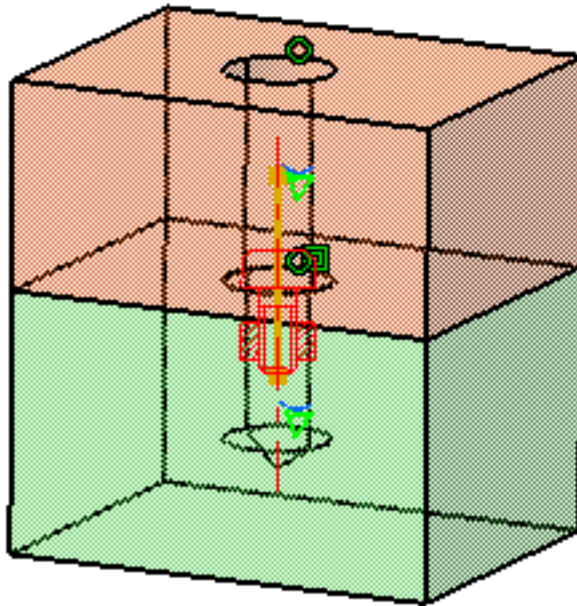

To obtain the same visualization of the assembly, select the **Shading with Edges and Hidden Edges** icon in the **View** toolbar.

Note that two elements appear in the specification tree:

- a **Tightening Connection Mesh.1** object under the **Nodes and Elements** set,
- a **Bolt Tightening Connection Property.1** object appears in the specification tree under the **Properties.1** set.

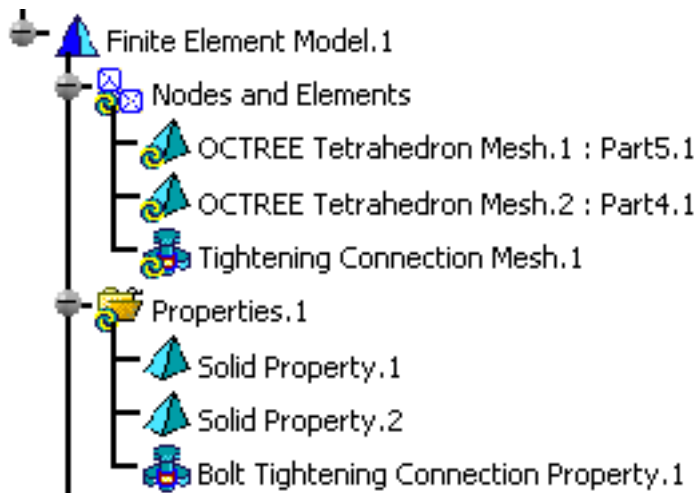

# Creating Rigid Connection Properties



This task shows how to create a Rigid Connection between two parts.



This functionality is only available in the **Generative Assembly Structural Analysis (GAS)** product.



A rigid connection is the link between two bodies which are stiffened and fastened together at their common boundary, and will behave as if their interface was infinitely rigid. Since bodies can be meshed independently, the Rigid Connection is designed to handle incompatible meshes.

The Rigid Connection relations do not take into account the elastic deformability of the interfaces.

The program proceeds as follows:

- a null-length rigid bar is created at the midpoint between the centroids of the two systems of points represented by the nodes of the two meshes (or at handler point, if specified).



In case of a **Point/Point** connection, the length of the rigid bar is non null.

- each extremity of the null-length rigid bar is connected by a rigid spider element to all nodes of the first and of the second meshes.
- a set of rig-beam relations is generated between the central node degree of freedom and the connected nodes degree of freedom.

Thus, the Rigid Connection generates as many rig-beam kinematical elements as there are nodes on the two surface meshes.

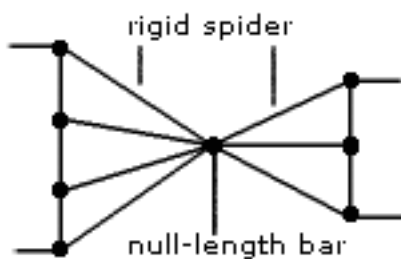

To know more about the generated element, see [Rigid Spider](#) in the *Finite Element Reference Guide*.



Open the [sample16.CATAnalysis](#) document from the samples directory.

**Before You Begin:**

- Make sure you created a Finite Element Model containing a Static Analysis Case from this assembly.
- Make sure you know all you need about [what type of property you will use for what type of connection](#).



1. Click the **Rigid Connection Property** icon .

The Rigid Connection Property dialog box appears.



2. Select an analysis connection.

In this particular example, select the **General Analysis Connection.1** in the specification tree (under the **Analysis Connection Manager.1** set).

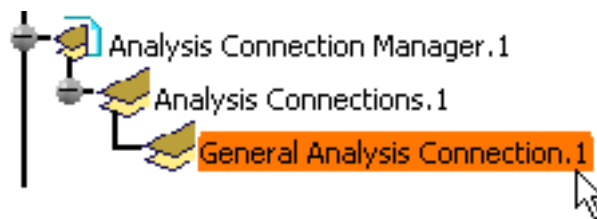



A symbol representing the Rigid Connection Property is visualized on the corresponding faces.

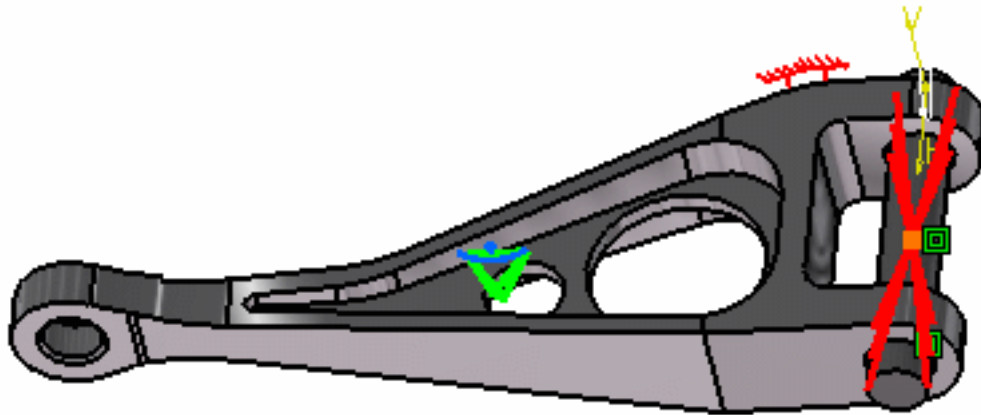

By default, if you deactivate the **Transmitted degrees of freedom** option, all the degrees of freedom are transmitted.

You can also release some degree of freedom to the distant connection, if needed. The degrees of freedom are released at the null-length element.

**Translation 1** = Translation in **x**

**Translation 2** = Translation in **y**

**Translation 3** = Translation in **z**

**Rotation 1** = Rotation in **x**

**Rotation 2** = Rotation in **y**

**Rotation 3** = Rotation in **z**

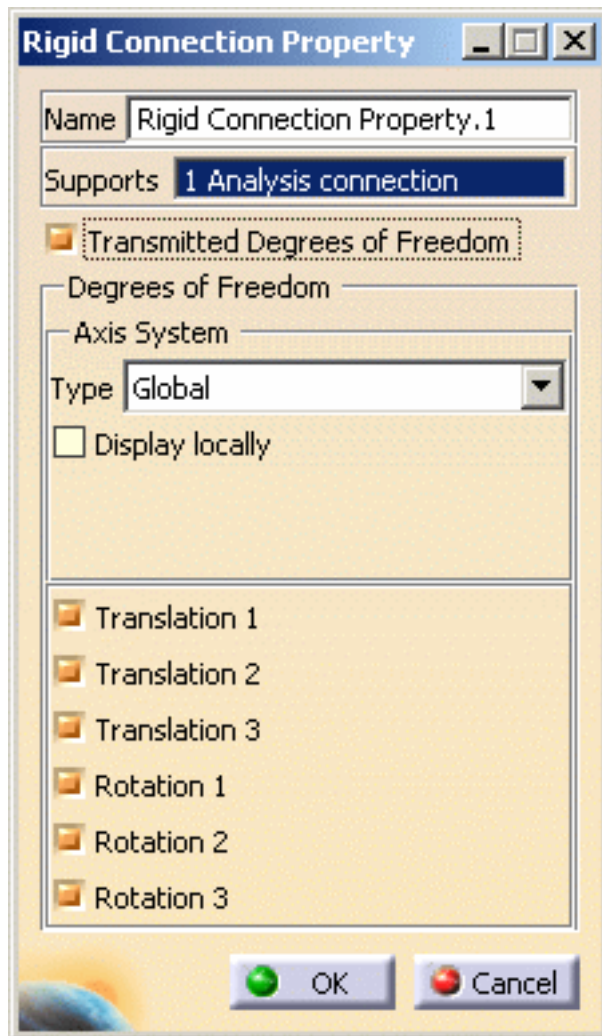

The Axis System Type combo box allows you to choose between **Global** or **User-defined** Axis systems for defining the degrees of freedom directions.

- **Global:** if you select the Global Axis system, the degree of freedom directions will be interpreted as relative to the fixed global rectangular coordinate system.
- **User:** if you select a User Axis system, the degree of freedom directions will be relative to the specified Axis system. Their interpretation will further depend on your Axis System Type choice.



The degrees of freedom are released only for the null-length element, so the **User Axis System** is defined only for the null-length element.



To select a User-defined Axis system, you must activate an existing Axis by clicking it in the features tree. Its name will then be automatically displayed in the **Current Axis** field.

If you select the User-defined Axis system, the **Local orientation** combo box further allows you to choose between **Cartesian** and **Cylindrical** Local Axis Orientations.

- **Cartesian:** the degrees of freedom directions are relative to a fixed rectangular coordinate system aligned with the cartesian coordinate directions of the User-defined Axis.
- **Cylindrical:** the degrees of freedom directions are relative to a local variable rectangular coordinate system aligned with the cylindrical coordinate directions of each point relative to the User-defined Axis.

**3.** If needed, set the Axis system.

**4.** Click **OK** in the Rigid Connection Property dialog box.

Note that two elements appear in the specification tree:

- a **Rigid Connection Mesh.1** object under the **Nodes and Elements** set,
- a **Rigid Connection Property.1** object appears in the specification tree under the **Properties.1** set.

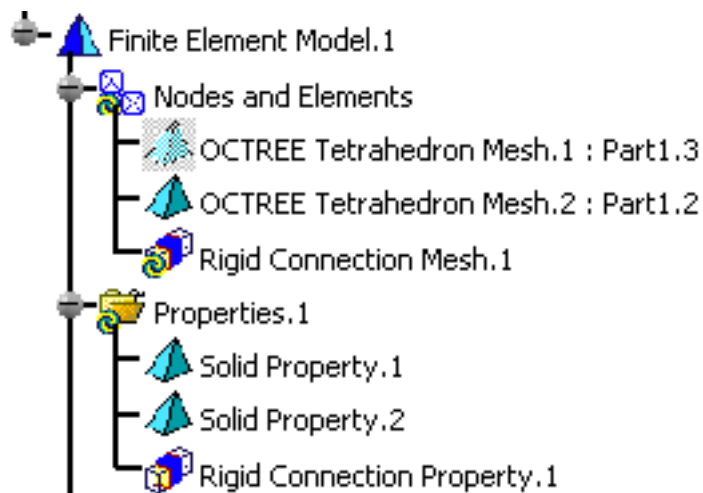



- The Finite Element Model contains two Mesh objects, one for each part of the assembly.
- The sizes of the two meshes are different as can be seen by comparing the Mesh Size symbols.



# Creating Smooth Connection Properties



This task shows how to create a Smooth Connection between two parts.



This functionality is only available in the **Generative Assembly Structural Analysis (GAS)** product.



A Smooth Connection is the link between two bodies which are fastened together at their common boundary, and will behave approximately as if their interface was soft. Since bodies can be meshed independently, the Smooth Connection is designed to handle incompatible meshes.

The Smooth Connection relations take approximately into account the elastic deformability of the interfaces. The approximation is based on a least squares fit of a slave node degree of freedom rigidly linked to the master nodes (element shape functions are ignored).

The program proceeds as follows:

- a null-length rigid bar is created at the midpoint between the centroids of the two systems of points represented by the nodes of the two meshes (or at handler point, if specified).



In case of a **Point/Point** connection, the length of the rigid bar is non null.

- each extremity of the null-length rigid bar is connected by two smooth spider elements to all nodes of the first and of the second meshes.
- a set of mean (constr-n) relations is generated between the central node degree of freedom and the connected nodes degree of freedom.

Thus, the Smooth Connection generates two spider kinematical elements.

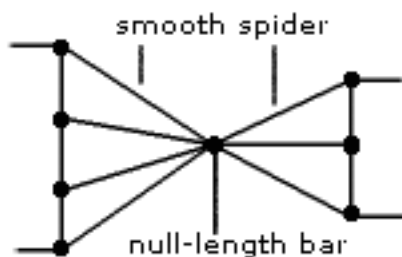

To know more about the generated element, see [Smooth Spider](#) in the *Finite Element Reference Guide*.



Open the [sample16.CATAnalysis](#) document from the samples directory.

**Before You Begin:**

- Make sure you created a Finite Element Model containing a Static Analysis Case from this assembly.
- Make sure you know all you need about [what type of property you will use for what type of connection](#).



1. Click the **Smooth Connection Property** icon .

The Smooth Connection Property dialog box appears.

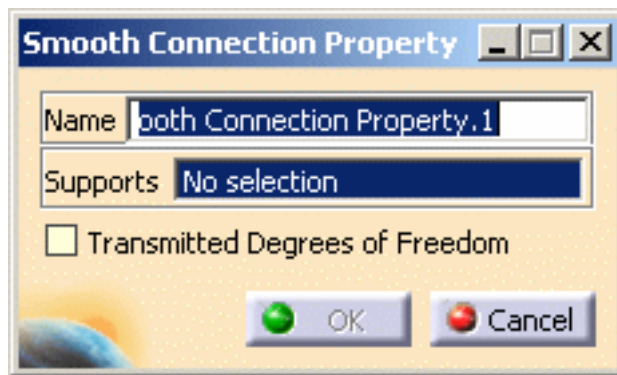

2. Select an analysis connection.

In this particular example, select the **General Analysis Connection.1** in the specification tree (under the **Analysis Connection Manager.1** set).

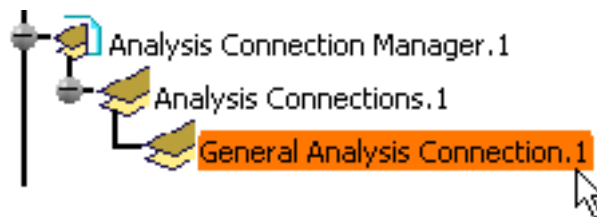

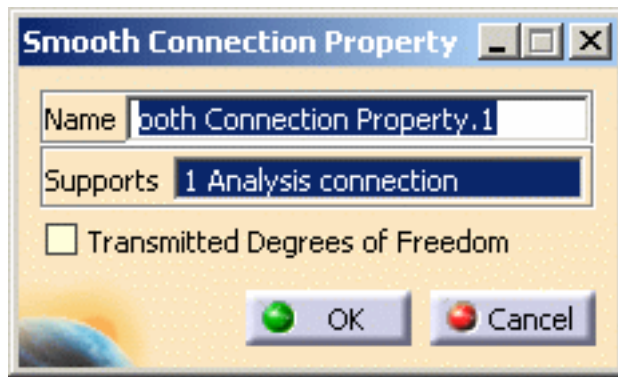

A symbol representing the Smooth Connection Property is visualized on the corresponding faces.

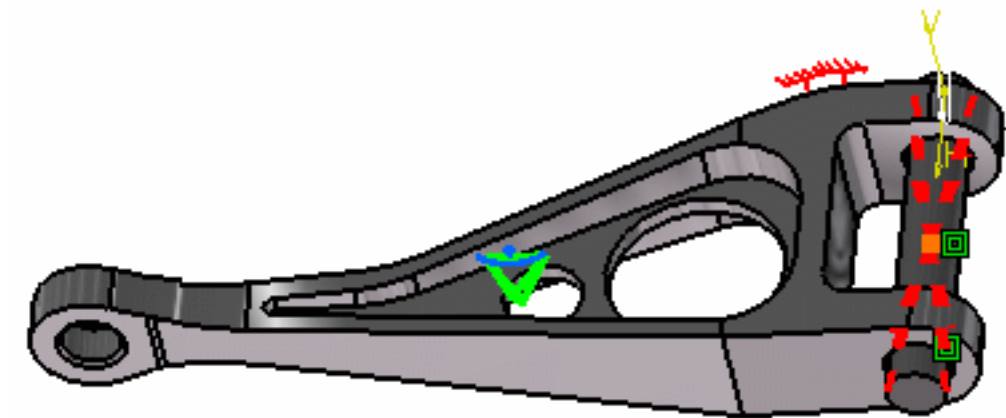

By default, if you deactivate the **Transmitted degrees of freedom** option, all the degrees of freedom are transmitted.

You can also release some degree of freedom to the distant connection, if needed. The degrees of freedom are released at the null-length element.

**Translation 1** = Translation in **x**

**Translation 2** = Translation in **y**

**Translation 3** = Translation in **z**

**Rotation 1** = Rotation in **x**

**Rotation 2** = Rotation in **y**

**Rotation 3** = Rotation in **z**

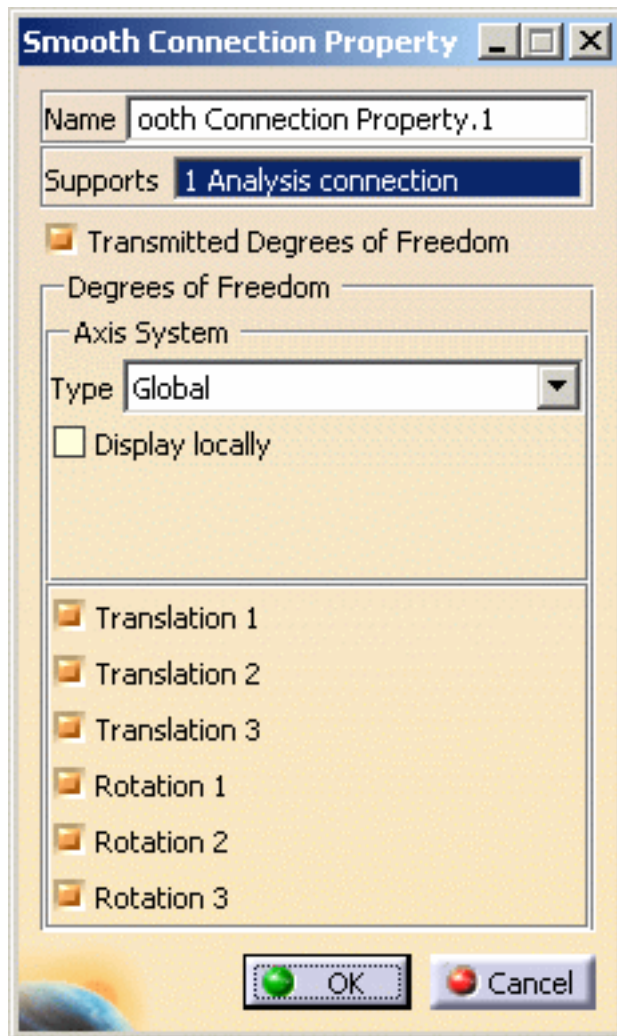

The Axis System Type combo box allows you to choose between **Global** or **User-defined** Axis systems for defining the degrees of freedom directions.

- **Global:** if you select the Global Axis system, the degree of freedom directions will be interpreted as relative to the fixed global rectangular coordinate system.
- **User:** if you select a User Axis system, the degree of freedom directions will be relative to the specified Axis system. Their interpretation will further depend on your Axis System Type choice.



The degrees of freedom are released only for the null-length element, so the **User Axis System** is defined only for the null-length element.

To select a User-defined Axis system, you must activate an existing Axis by clicking it in the features tree. Its name will then be automatically displayed in the **Current Axis** field.

If you select the User-defined Axis system, the Local orientation combo box further allows you to choose between **Cartesian** and **Cylindrical** Local Axis Orientations.

- **Cartesian:** the degrees of freedom directions are relative to a fixed rectangular coordinate system aligned with the cartesian coordinate directions of the User-defined Axis.
- **Cylindrical:** the degrees of freedom directions are relative to a local variable rectangular coordinate system aligned with the cylindrical coordinate directions of each point relative to the User-defined Axis.

3. If needed, set the Axis system.
4. Click **OK** in the Smooth Connection Property dialog box.

Note that two elements appear in the specification tree:

- a **Smooth Connection Mesh.1** object under the **Nodes and Elements** set,
- a **Smooth Connection Property.1** object appears in the specification tree under the **Properties.1** set.

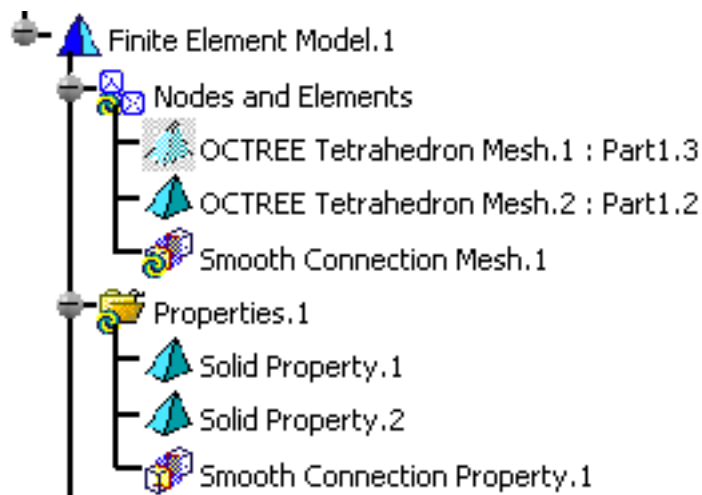

- The Finite Element Model contains two Mesh objects, one for each part of the assembly.
- The sizes of the two meshes are different as can be seen by comparing the Mesh Size symbols.



# Creating Virtual Rigid Bolt Tightening Connection Properties



This task shows how to create a Virtual Rigid Bolt Tightening Connection Property between two parts.



- This functionality is only available in the **Generative Assembly Structural Analysis (GAS)** product.
- To have precisions and to know restrictions, please refer to [About Connection Properties](#).



Virtual Rigid Bolt Tightening Connections are used to specify the boundary interaction between bodies in an assembled system. Once the geometric assembly positioning constraints are defined at the Product level, the user can specify the physical nature of the constraints. When creating this connection, both the coincidence constraints and the **Analysis Connections** workbench constraints can be selected.

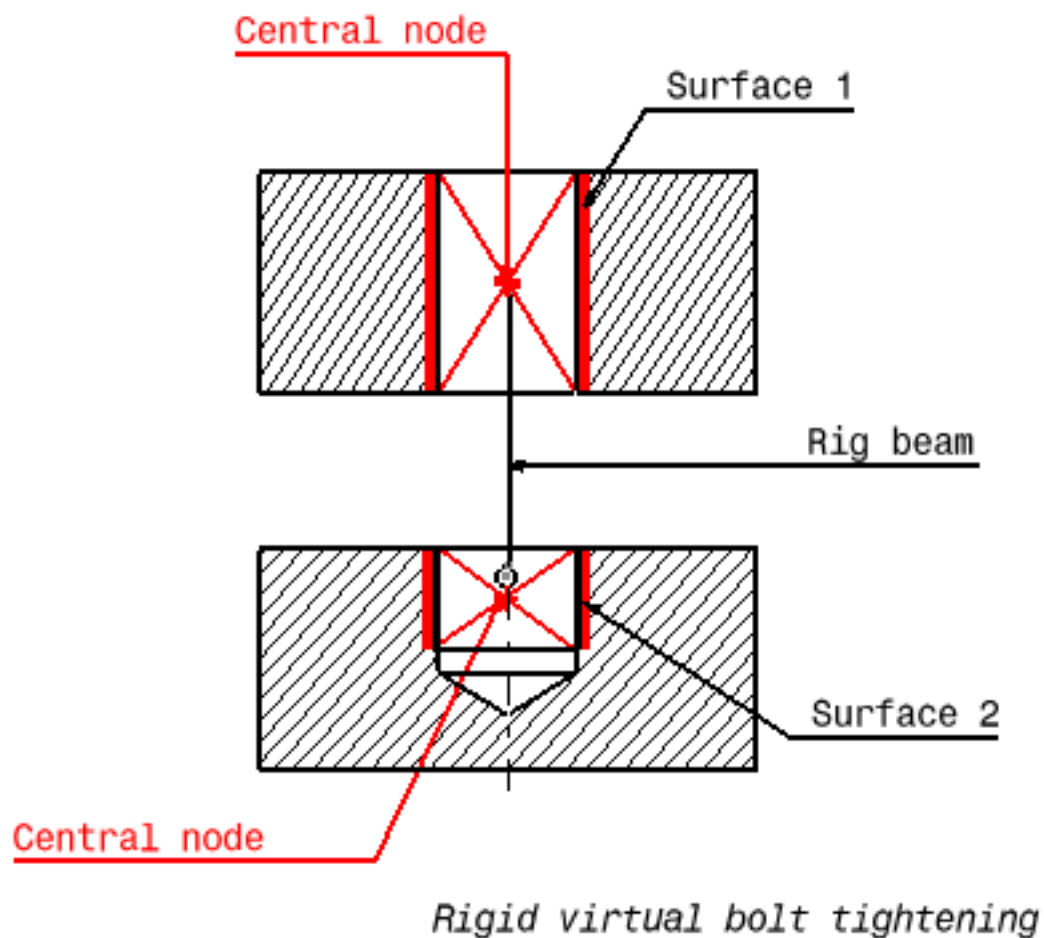



***Surface 1 and surface 2 are supports for the assembly constraints of coincidence type.***

A Virtual Rigid Bolt Tightening Connection is a connection that takes into account pre-tension in a bolt-tightened assembly in which the bolt is not included. The computation is carried out according to the two-step traditional approach. In the first step of the computation, the model is submitted to tension forces relative to bolt tightening by applying opposite forces on the first surface (S1) and the second surface (S2) of the assembly constraint, respectively. Then, in the second step, the relative displacement of these two surfaces (obtained in the first step) is imposed while the model is submitted to user loads. During these two steps, the rotations of both surfaces and the translations perpendicular to the coincidence constraint axis are linked together, while taking into account the elastic deformability of the surfaces. Since bodies can be meshed independently, the Virtual Rigid Bolt Tightening Connection is designed to handle incompatible meshes.

The program proceeds as follows:

- a central node is created at the centroid of each surface of the assembly constraint referenced as the support.
- for each surface/central node couple, a set of mean (constr-n) relations is generated to link the average displacement of the central node and the nodes of the surface.
- the first central node is linked rigidly to the duplicata of the second central node.
- the second central node is linked rigidly to its duplicata except for the translation in the direction of the coincidence constraint.
- in the direction of the coincidence constraint, a cable relation (the reverse of a contact relation) is generated between translation degrees of freedom of the second central node and its duplicata.

To know more about the generated element, see [Tightening Beam](#) and [Rigid Spider](#) in the *Finite Element Reference Guide*.



Virtual rigid bolt tightening connection property is equivalent to a user-defined distant connection property defined with the following combination:

- **Smooth** as **Start** option
- **Bolt-Rigid** as **Middle** option
- **Smooth** as **End** option

For more details about user-defined distant connection properties, please refer to [Creating User-defined Distant Connection Property](#) in this guide.



Open the [sample12.CATAnalysis](#) document from the samples directory.

### **Before You Begin:**

- Make sure you created a Finite Element Model containing a Static Analysis Case from this assembly.
- Make sure you know all you need about [what type of property you will use for what type of connection](#).



1. Click the **Virtual Bolt Tightening Connection Property** icon .

The Virtual Bolt Tightening Connection Property dialog box appears.

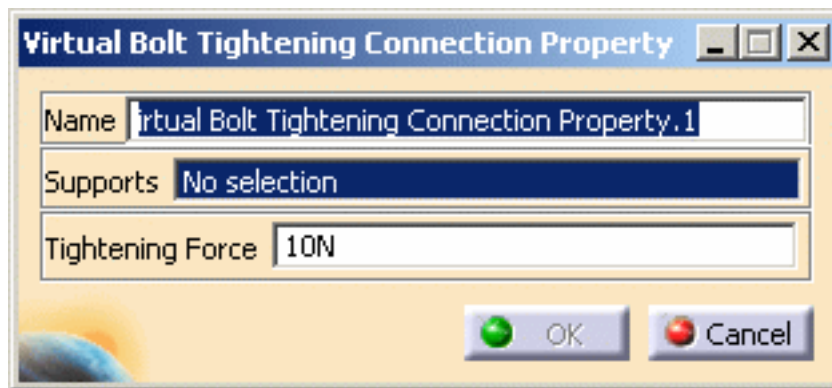

2. Select an analysis connection.

In this particular example, select the **General Analysis Connection.1** in the specification tree (under the **Analysis Connection Manager.1** set).

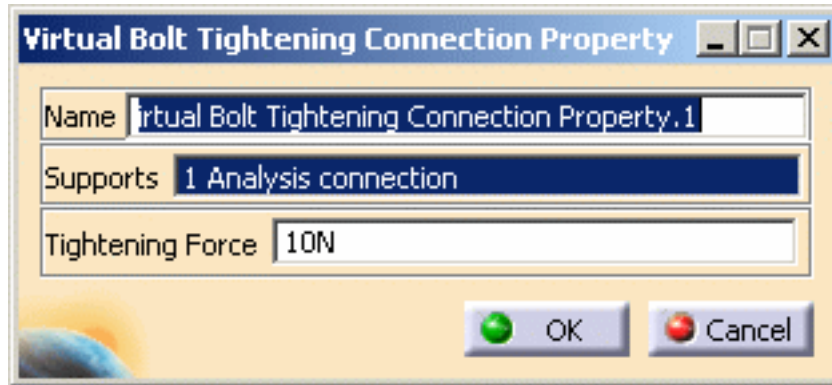
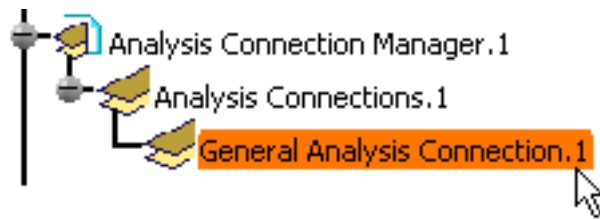

A symbol representing the Virtual Bolt Tightening Connection Property is visualized on the corresponding faces.

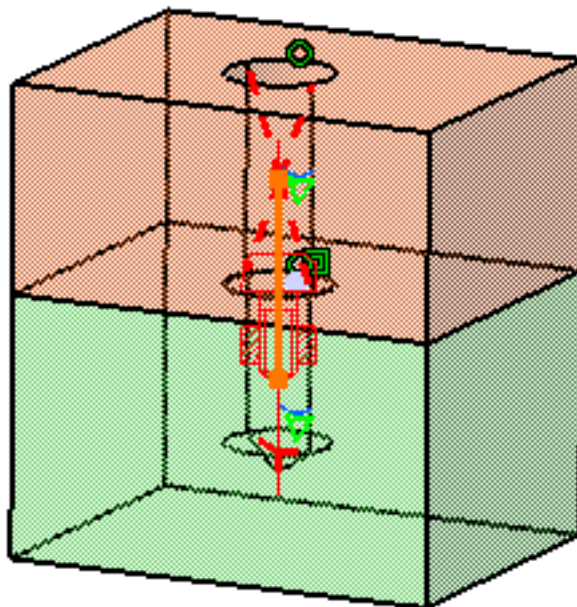

3. Optionally modify the default **Tightening Force** value.
4. Click **OK** in the Virtual Bolt Tightening Connection Property dialog box.

Note that two elements appear in the specification tree:

- a **Virtual Bolt Connection Mesh.1** object under the **Nodes and Elements** set,
- a **Virtual Bolt Tightening Connection Property.1** Connection object appears in the specification tree under the **Properties.1** set.

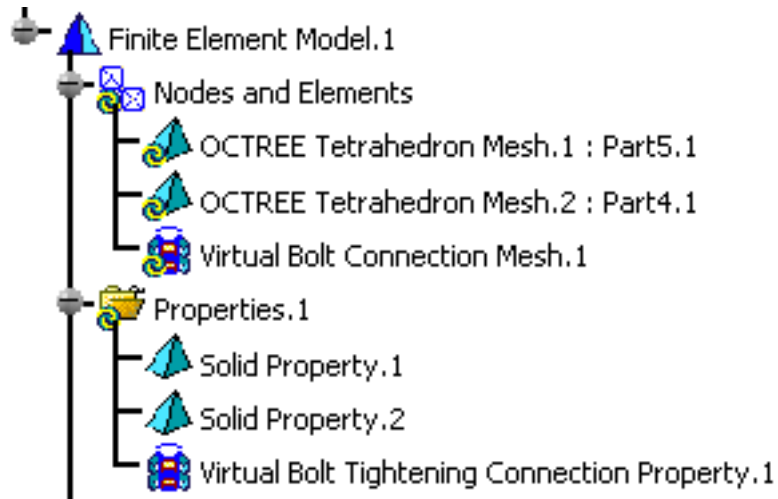

# Creating Virtual Spring Bolt Tightening Connection Properties



This task shows how to create a Virtual Spring Bolt Tightening Connection between two parts.



- This functionality is only available in the **Generative Assembly Structural Analysis (GAS)** product.
- To have precisions and to know restrictions, please refer to [About Connection Properties](#).



Virtual Spring Bolt Tightening Connections are used to specify the boundary interaction between bodies in an assembled system. Once the geometric assembly positioning constraints are defined at the Product level, the user can specify the physical nature of the constraints. When creating this connection, both the coincidence constraints and the **Analysis Connections** workbench constraints can be selected.

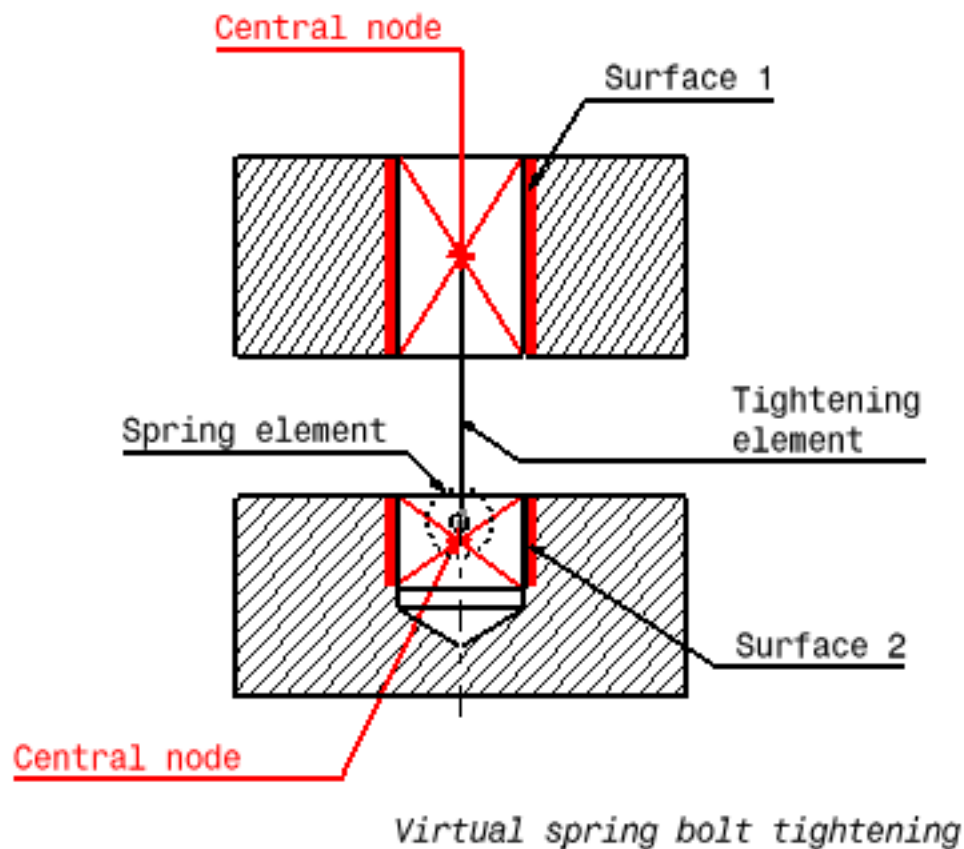

***Surface 1 and surface 2 are supports for the assembly constraints of coincidence type.***

Virtual Spring Bolt Tightening Connection is a connection that takes into account pre-tension in a bolt-tightened assembly in which the bolt is not included. The computation is carried out according to the two-step traditional approach. In the first step of the computation, the model is submitted to tension forces relative to bolt tightening by applying opposite forces on the first surface (S1) and the second surface (S2) of the assembly constraint, respectively. Then, in the second step, the relative displacement of these two surfaces (obtained in the first step) is imposed while the model is submitted to user loads. The Virtual Spring Bolt Tightening Connection takes into account the elastic deformability of the surfaces and since bodies can be meshed independently, the Virtual Spring Bolt Tightening Connection is designed to handle incompatible meshes.

The program proceeds as follows:

- a central node is created at the centroid of each surface of the assembly constraint referenced as the support.
- for each surface/central node couple, a set of mean rigid body (constr-n) relations is generated to link the average displacement of the central nodes and the nodes of the surface.
- the first central node is linked to the duplicata of the second central node using a tightening element. This element generates:
  - a set of equality relations linking both nodes according to the rigid body motion except for the translation in the direction of the element.
  - a cable inequality relation (the reverse of a contact element) in the direction of the element. This cable relation is used to enforce the relative displacement of both surfaces at the second step of the computation.
- the second central node is linked to its duplicata using a spring element the characteristics of which are defined by the user.

To know more about the generated elements, see [Tightening Beam](#), [Spring](#) and [Smooth Spider](#) in the *Finite Element Reference Guide*.



By default, when creating a virtual spring bolt tightening connection property, the stiffness rotations and translations are defined in a global axis system.

To select a user axis system, use a user-defined distant connection property defined with the following combination:

- **Smooth** as **Start** option,
- **Spring-Rigid-Bolt** as **Middle** option,
- **Smooth** as **End** option.

For more details about user-defined distant connection properties, please refer to [Creating User-defined Distant Connection Property](#) in this guide.



Open the [sample12.CATAnalysis](#) document from the samples directory.

#### **Before You Begin:**

- Make sure you created a Finite Element Model containing a Static Analysis Case from this assembly.
- Make sure you know all you need about [what type of property you will use for what type of connection](#).



1. Click the **Virtual Spring Bolt Tightening Connection Property** icon .

The Virtual Spring Bolt Tightening Connection Property dialog box appears.

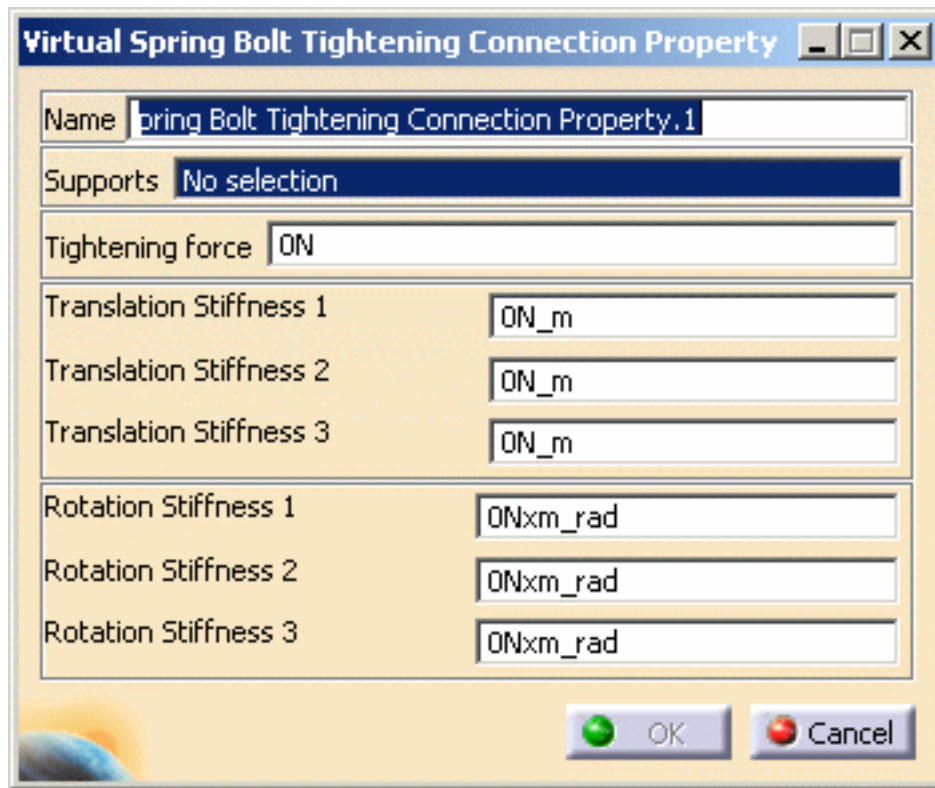

2. Select an analysis connection.

In this particular example, select the **General Analysis Connection.1** in the specification tree (under the **Analysis Connection Manager.1** set).

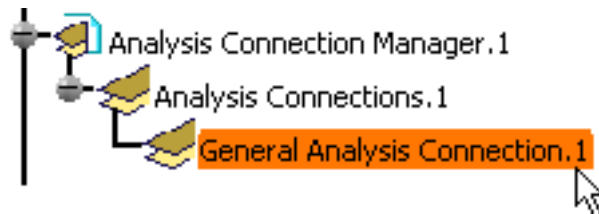



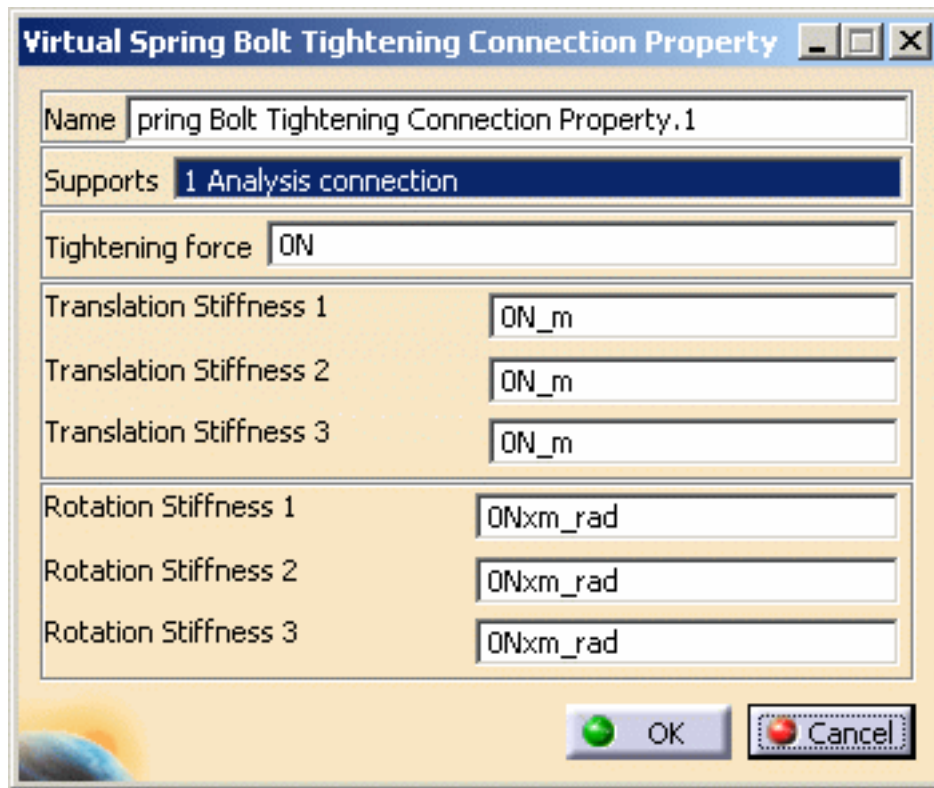

A symbol representing the Virtual Spring Bolt Tightening Connection Property is visualized on the corresponding faces.

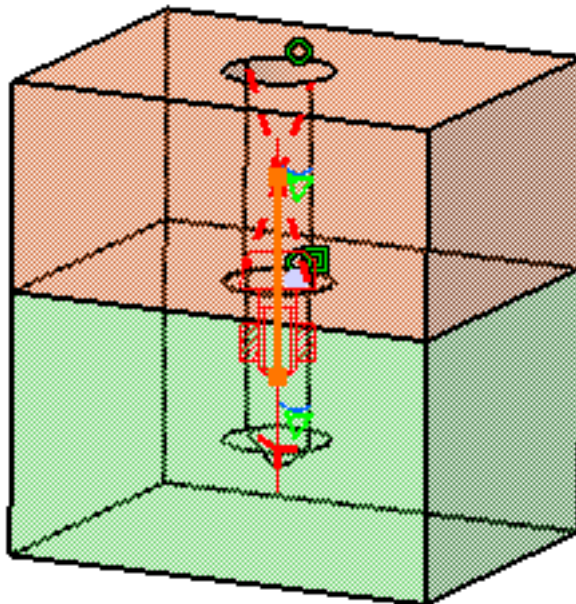

3. Optionally modify the default value of the force and stiffness parameters.
4. Click **OK** in the Virtual Spring Bolt Tightening Connection Property dialog box.

Note that two elements appear in the specification tree:

- a **Tightening Connection Mesh.1** object under the **Nodes and Elements** set,
- a **Bolt Tightening Connection Property.1** object appears in the specification tree under the **Properties.1** set.

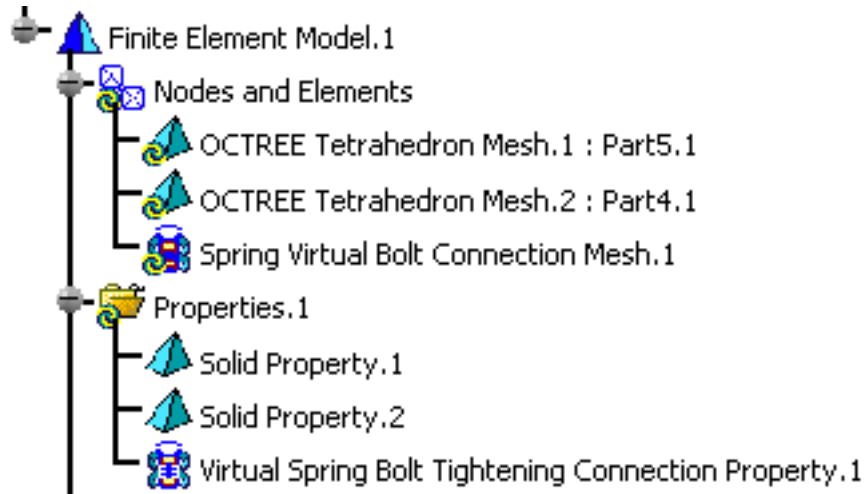

# Creating User-Defined Connection Properties



This task shows you how to create user-defined distant connection properties.



- This functionality is only available in the **Generative Assembly Structural Analysis (GAS)** product.
- To have precisions and to know restrictions, please refer to [About Connection Properties](#).



Creating user-defined distant connection properties allows you to specify the types of elements as well as their associated properties included inside a distant connection. For example:

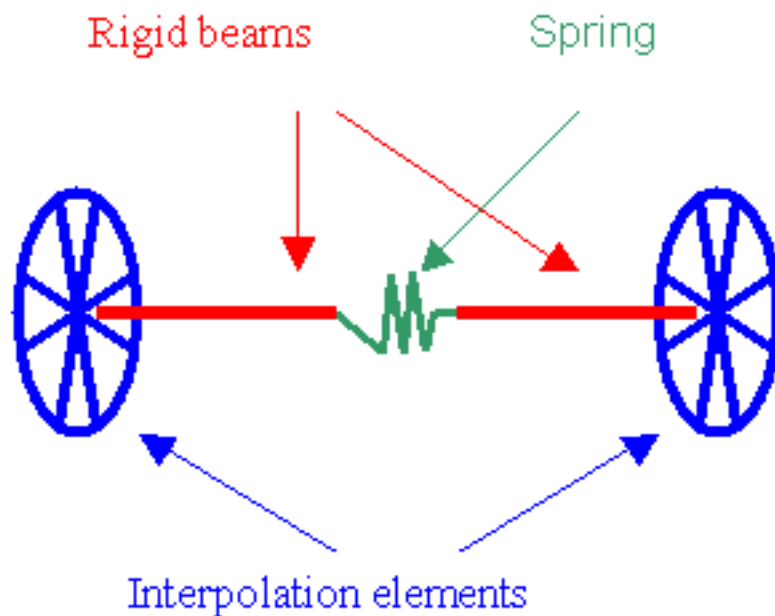

You will define which types of element will be featured in the connection. Remember that you can possibly have the following types of connected elements:

- **Surface-Point part (left part)**. It describes the way the surface is connected to the middle of the connection. The possible combinations will be:
  - Smooth
  - Rigid
  - Spring-Smooth
  - Spring-Rigid
  - Contact-Rigid



- **Middle part.** It describes the elements featuring in the middle of the connection. The possible combinations will be:

- Rigid
- Spring-Rigid-Spring
- Rigid-Spring-Rigid
- Spring-Rigid
- Rigid-Spring
- Beam
- Spring-Beam-Spring
- Beam-Spring-Beam
- Spring-Beam
- Beam-Spring
- Bolt-Rigid
- Rigid-Bolt
- Bolt-Beam
- Beam-Bolt
- Bolt-Rigid-Spring
- Spring-Rigid-Bolt



- **Point-Surface part.** It describes the way the surface is connected to the middle of the connection. The possible combinations will be:

- Smooth
- Rigid
- Smooth-Spring
- Rigid-Spring
- Rigid-Contact



Open [sample12.CATAnalysis](#) from the samples directory.

### **Before You Begin:**

- Make sure you created a Finite Element Model containing a Static Analysis Case from this assembly.
- Make sure you know all you need about [what type of property you will use for what type of connection](#).



1. Click the **User-Defined Distant Connection Property** icon .

The User-Defined Connection Property dialog box appears.



Depending on the selected combination type, the appropriate properties will be proposed: lists in sub-windows describing all the elementary properties. For example:

- If the list of elements is RIGID + SPRING and BEAM + RIGID and CONTACT
- Three sub-windows (elementary basic components) will display the properties for each of the elements: Spring, Beam and Contact.

2. Select an analysis connection as support.

In this particular example, select the **General Analysis Connection.1** in the specification tree (under the **Analysis Connection Manager.1** set).

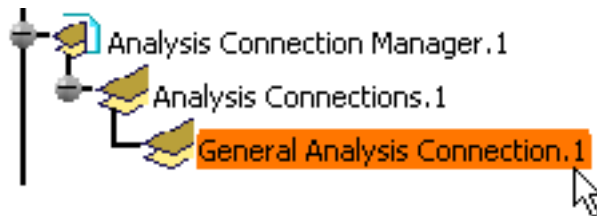

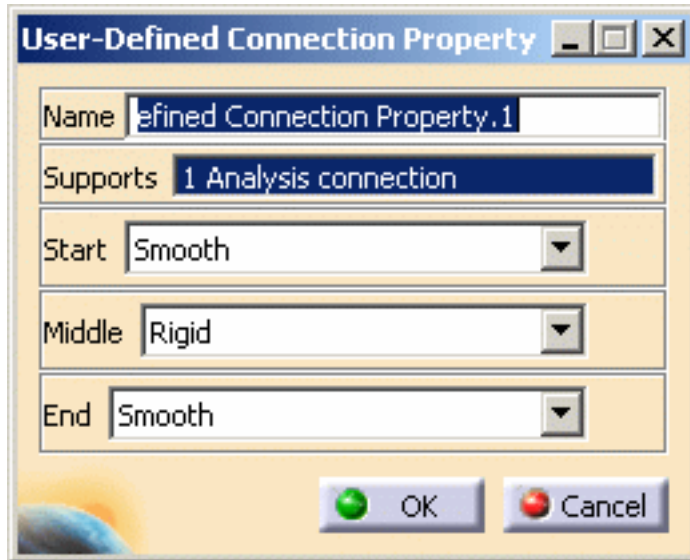

A symbol representing the User-Defined Connection Property is visualized on the corresponding faces.

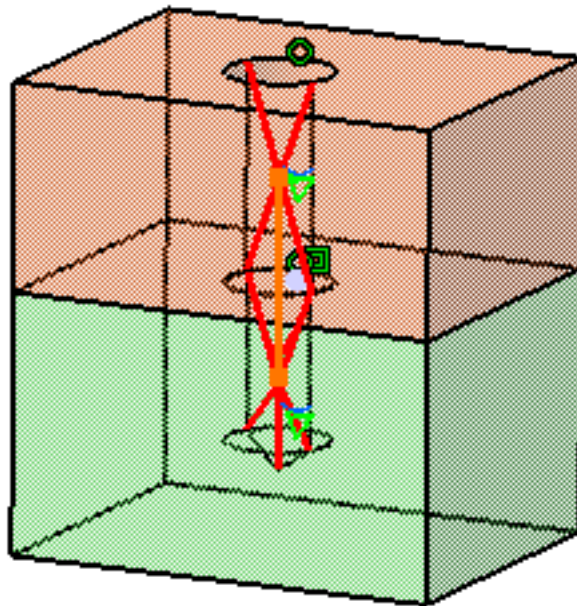

3. Define the types of the elements to be featured in the connection: **Start**, **Middle** and **End**.

Depending on the type of Start, Middle and End elements you will choose in the User-Defined Connection Property dialog box, given definition boxes and options will be available.

**This is an example:**

Set the parameters as shown bellow:



- o **Start:** if you click the **Component Edition** button , the Start Connection dialog box appears:

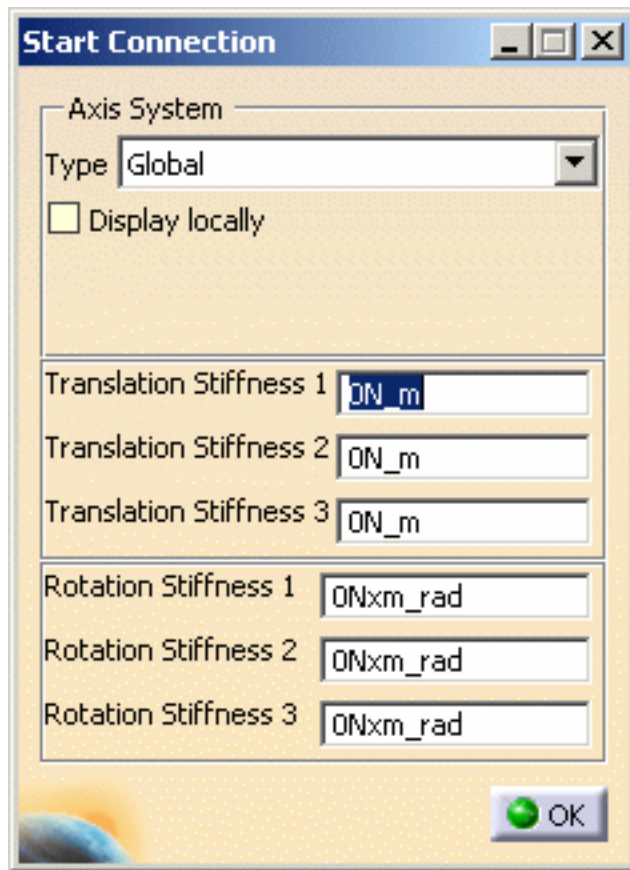

- **Axis System Type** combo box lets you to choose between **Global** or **User** Axis systems for defining the degrees of freedom directions.
  - **Global**: if you select the Global Axis system, the degree of freedom directions will be interpreted as relative to the fixed global rectangular coordinate system.
  - **User**: if you select a User Axis system, the degree of freedom directions will be relative to the specified Axis system. Their interpretation will further depend on your **Axis System Type** choice.

To select a User Axis system, you must activate an existing Axis by clicking it in the features tree. Its name will then be automatically displayed in the **Current Axis** field.

If you select the User Axis system, the **Local orientation** combo box further allows you to choose between **Cartesian**, **Cylindrical** and **Spherical** Local Axis Orientations.

- **Translation and Rotation stiffness** values.

- **Middle**: if you click the **Component Edition** button , the Middle Connection dialog box appears:



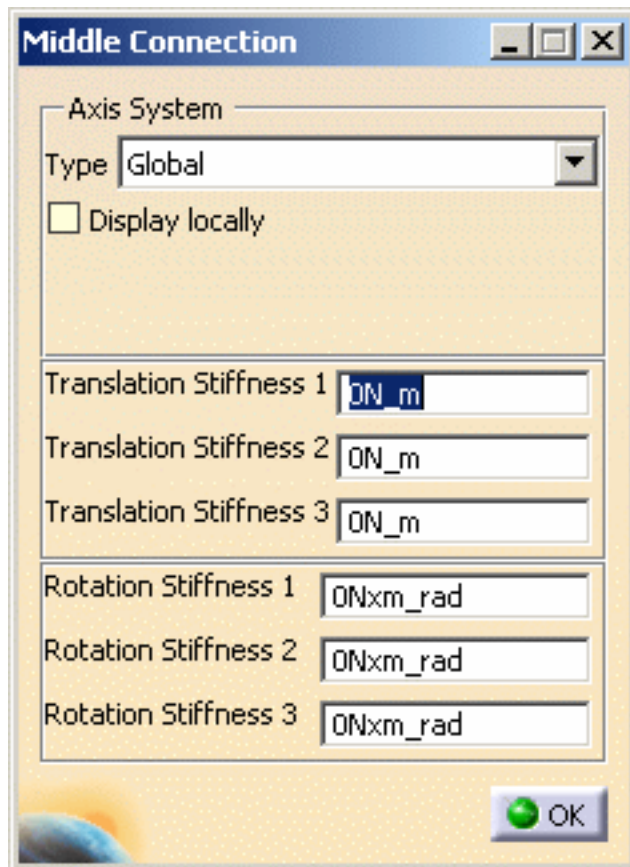

- **Axis System Type** combo box lets you to choose between **Global** or **User** Axis systems for defining the degrees of freedom directions.
  - **Global**: if you select the Global Axis system, the degree of freedom directions will be interpreted as relative to the fixed global rectangular coordinate system.
  - **User**: if you select a User Axis system, the degree of freedom directions will be relative to the specified Axis system. Their interpretation will further depend on your **Axis System Type** choice.

To select a User Axis system, you must activate an existing Axis by clicking it in the features tree. Its name will then be automatically displayed in the **Current Axis** field.

If you select the User Axis system, the **Local orientation** combo box further allows you to choose between **Cartesian**, **Cylindrical** and **Spherical** Local Axis Orientations.

- **Translation and Rotation stiffness** values.

- **End**: if you click the **Component Edition** button , the End Connection dialog box appears:

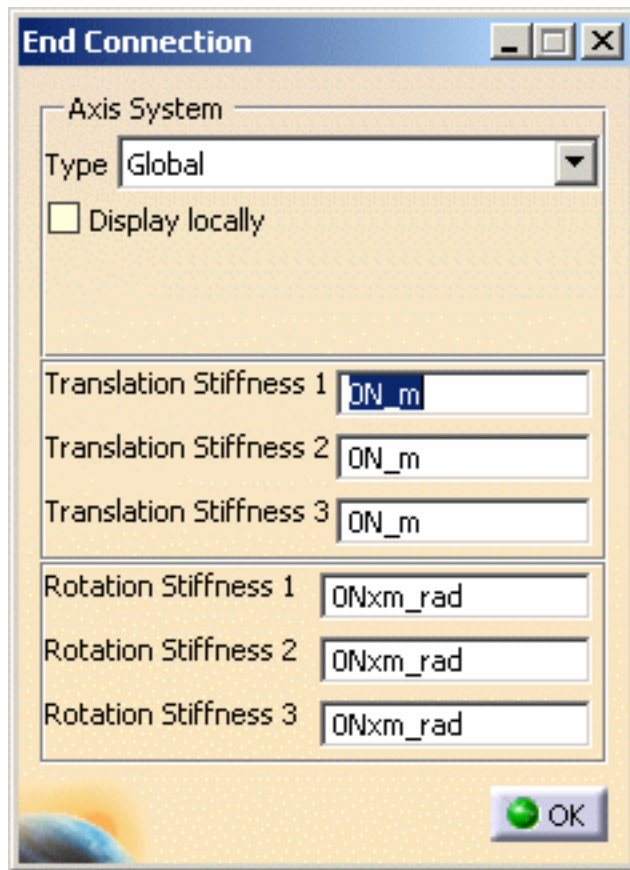

- **Axis System Type** combo box lets you to choose between **Global** or **User** Axis systems for defining the degrees of freedom directions.
  - **Global**: if you select the Global Axis system, the degree of freedom directions will be interpreted as relative to the fixed global rectangular coordinate system.
  - **User**: if you select a User Axis system, the degree of freedom directions will be relative to the specified Axis system. Their interpretation will further depend on your **Axis System Type** choice.

To select a User Axis system, you must activate an existing Axis by clicking it in the features tree. Its name will then be automatically displayed in the **Current Axis** field.

If you select the User Axis system, the **Local orientation** combo box further allows you to choose between **Cartesian**, **Cylindrical** and **Spherical** Local Axis Orientations.

- **Translation and Rotation stiffness** values.

4. If needed, click **OK** in the Start, Middle or End Connection dialog box.
5. Click **OK** in the User-Defined Connection Property dialog box.

Note that two elements appear in the specification tree:

- o a **Generic Connection Mesh.1** object under the **Nodes and Elements** set,
- o a **User-Defined Connection Property.1** object appears in the specification tree under the **Properties.1** set.

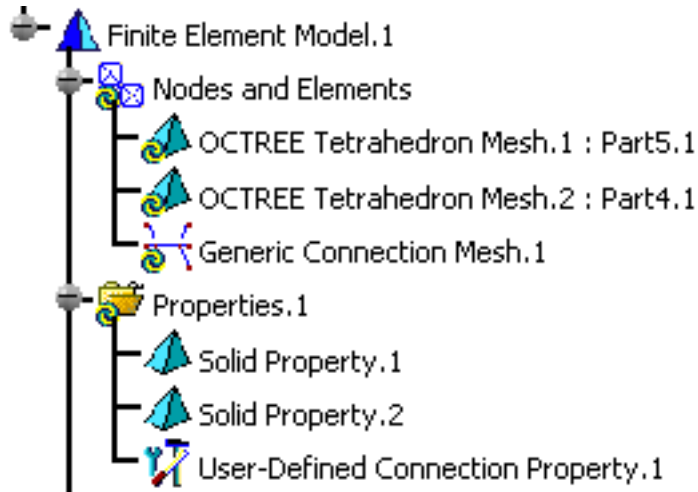

- If the support of the connection is a Face to Point connection (connecting wire-frames with solid or surface), only two of the three lists will be proposed (left part and middle part).
- If the support of the connection is Point to Point connection (connecting two wire-frames), only the middle list will be proposed.
- No handler point is proposed in that type of connection. To ensure that a Face to Face connection will respect a given point, it will be necessary to split into a Face to Point and a Point to Face connection sharing the same point. Like for virtual parts sharing the same handler point, only one single node will be generated on the associated point.



# Creating Spot Welding Connection Properties



This task shows how to create a Spot Welding Connection between two parts.

A Spot Welding Connection is the link between two bodies, using point analysis connections or point analysis connections within one part.



This functionality is only available in the **Generative Assembly Structural Analysis (GAS)** product.



- Open the [sample48\\_1.CATAnalysis](#) document from the samples directory.
- Make sure you know all you need about [what type of property you will use for what type of connection](#).



1. Click the **Spot Welding Connection Property** icon .

The Spot Welding Connection Property dialog box appears.



- **Name:** lets you change the name of the connection property.
- **Supports:** lets you select the connection you want to associate to a property.



You can apply the spot welding connection property:

- on Point Analysis Connection and Point Analysis Connection within one Part (from R12)
- on a joint body of the Body in White Fastening workbench
- on Spot Welding Connection (before R12)

For more details, please refer to [About Connection Properties](#).

○ **Type:** allows you to choose between:

- **Rigid**
- **Spring-Rigid-Spring**
- **Rigid-Spring-Rigid**
- **Beam**
- **Hexahedron**



○ If you select the **Beam**, **Spring-Rigid-Spring**, **Rigid-Spring-Rigid** or **Hexahedron** option type, the **Component edition** icon appears



○ The **Component edition** icon can have two status:

■ valid:

■ invalid:

○ If you select **Beam** or **Hexahedron** option type, you can select an user-defined material.

Material

User-defined material

For more details, please refer [Creating an User Material](#).

**2.** Select a spot welding connection.

In this particular example, select the **Point Analysis Connection.1** in the specification tree.

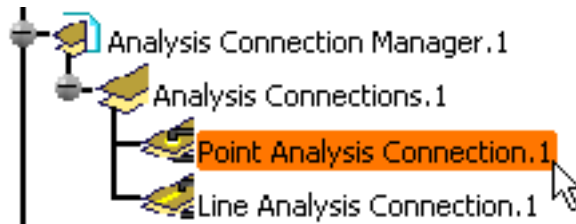

3. Select the desired **Type** option.

In this particular example, select the **Spring-Rigid-Spring** option **Type**.

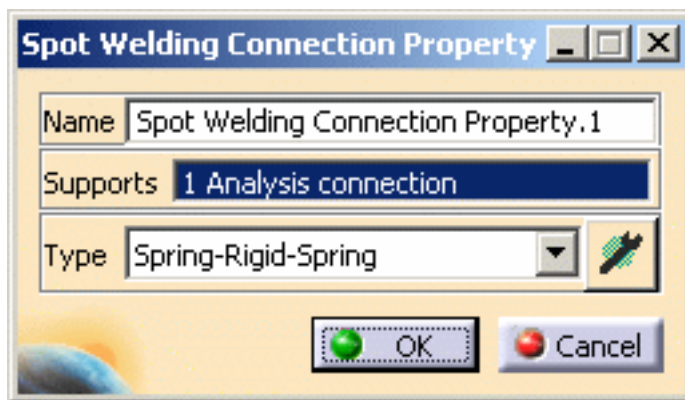

4. Click the **Component edition** icon  to specify the parameters.

The Spot Weld Definition dialog box:

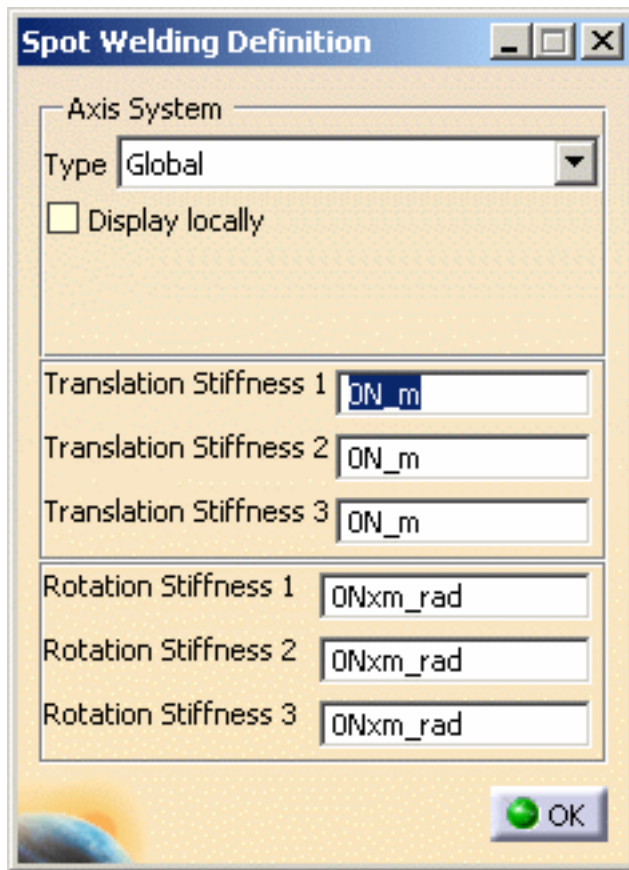

- the **Axis System Type** combo box lets you to choose between **Global** or **User** Axis systems for defining the degrees of freedom directions.
- **Translation** and **Rotation stiffness** values.
  - **Global:** if you select the Global Axis system, the degree of freedom directions will be interpreted as relative to the fixed global rectangular coordinate system.
  - **User:** if you select a User Axis system, the degree of freedom directions will be relative to the specified Axis system. Their interpretation will further depend on your **Axis System Type** choice.

To select a User Axis system, you must activate an existing Axis by clicking it in the features tree. Its name will then be automatically displayed in the **Current Axis** field.

If you select the User Axis system, the **Local orientation** combo box further allows you to choose between **Cartesian**, **Cylindrical** and **Spherical** Local Axis Orientations.

- **Cartesian:** the degrees of freedom directions are relative to a fixed rectangular coordinate system aligned with the Cartesian coordinate directions of the User Axis.

- **Cylindrical:** the degrees of freedom directions are relative to a local variable rectangular coordinate system aligned with the cylindrical coordinate directions of each point relative to the User Axis.
- **Spherical:** the degrees of freedom directions are relative to a local variable rectangular coordinate system aligned with the spherical coordinate directions of each point relative to the User Axis.

You can select six degrees of freedom per node:

1. **Translation stiffness 1** = Translation in **X**
2. **Translation stiffness 2** = Translation in **Y**
3. **Translation stiffness 3** = Translation in **Z**
4. **Rotation stiffness 1** = Rotation in **X**
5. **Rotation stiffness 2** = Rotation in **Y**
6. **Rotation stiffness 3** = Rotation in **Z**

5. Modify the desired parameters in the Spot Weld Definition dialog box.
6. Click **OK** in the Spot Weld Definition dialog box.
7. Click **OK** in the Spot Welding Connection dialog box.

A **Spot Welding Connection Property.1** object appears in the specification tree under the **Properties.1** set and a **Weld Spot Connection Mesh.1** object appears under the **Nodes and Elements** set.

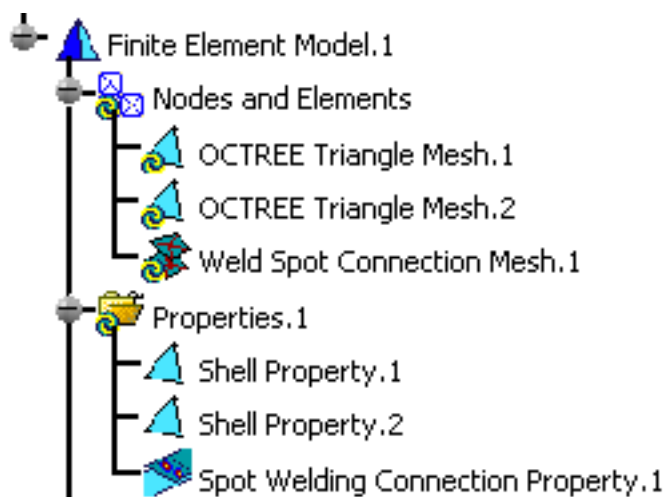





- You can edit the **Weld Spot Connection Mesh.1** object.

For this, double-click the **Weld Spot Connection Mesh.1** object in the specification tree.

The Spot Welding Connection dialog box appears.

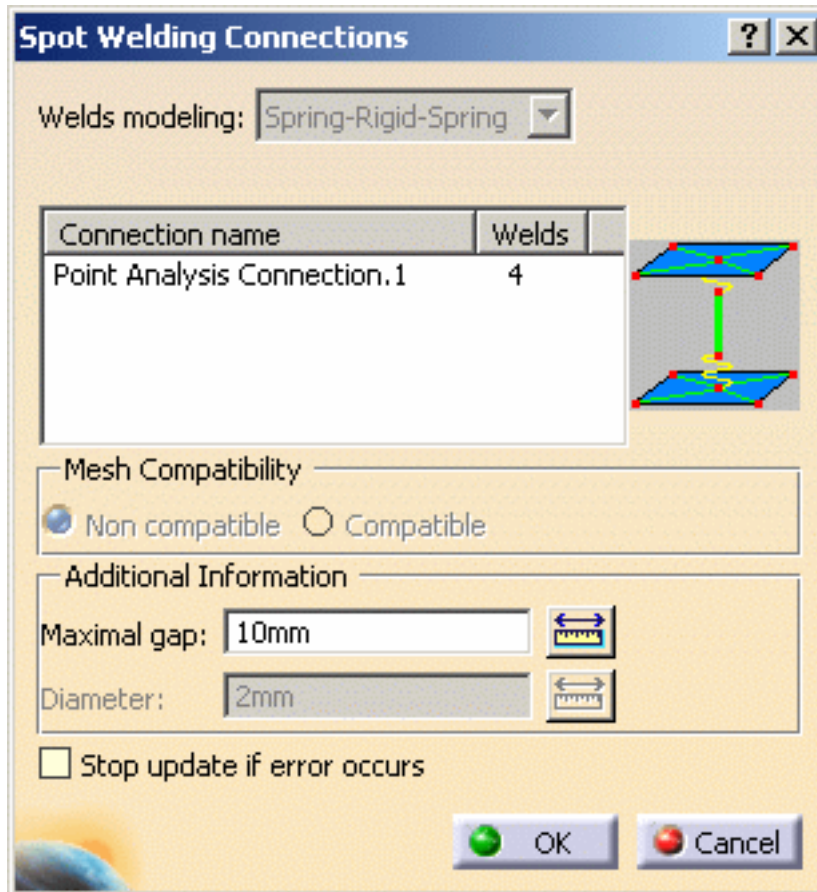

For more details about the weld spot connection mesh parts, please refer to *Meshing Spot Weld Connections* in the *Advanced Meshing Tools User's Guide*.

- You can visualize the connection mesh. For this:
  - compute the mesh only (for more details, please refer to [Computing Objects Sets](#))
  - generate a **Mesh** image (for more details, please refer to [Generating Images](#))



# Creating Seam Weld Connection Properties



This task shows how to create a Seam Weld Connection Property between two parts or within one part.

A Seam Weld Connection Property is a connection that is created from an existing Line Analysis Connection or Line Analysis Connection Within One Part.



This functionality is only available in the **Generative Assembly Structural Analysis (GAS)** product.



- Open the [sample48\\_1.CATAnalysis](#) document from the samples directory.
- Make sure you know all you need about [what type of property you will use for what type of connection](#).



1. Select the **Seam Weld Connection Property** icon .

The Seam Weld Connection Property dialog box appears.



- **Name:** lets you change the name of the connection property.
- **Support:** lets you select the connection you want to associate to a property.





You can apply the spot welding connection property:

- on Line Analysis Connection and Line Analysis Connection within one Part (from R12)
- on a joint body of the Body in White Fastening workbench
- on Seam Welding Connection (before R12)

For more details, please refer to [About Connection Properties](#).

- **Type:**
  - **Shell**
  - **Hexahedron**
  - **Rigid**
  - **Spring-Rigid-Spring**
  - **Rigid-Spring-Rigid**
  - **Contact:** only available to connect 3D geometries.
  - **Beam**



- If you select the **Shell, Hexahedron, Spring-Rigid-Spring, Rigid-Spring-Rigid, Contact** or **Beam** option type, the **Component edition** button appears .
- The **Component edition** button can have two status:
  - valid: 
  - invalid: 
- If you select **Shell, Beam** or **Hexahedron** option type, you can select an user-defined material.

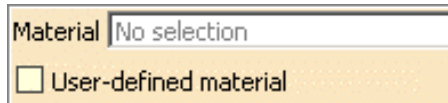

Material

User-defined material

For more details, please refer [Creating an User Material](#).

**2.** Select the seam welding connection.

In this particular example, select **Line Analysis Connection.1** object in the specification tree.

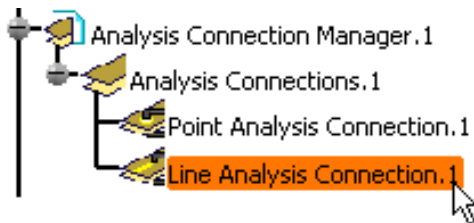

**3.** Select the desired **Type** option.

In this particular example, select the **Shell** option type.

**4.** Click the **Component edition** button  to specify the parameters.

The Seam Weld Definition dialog box appears.

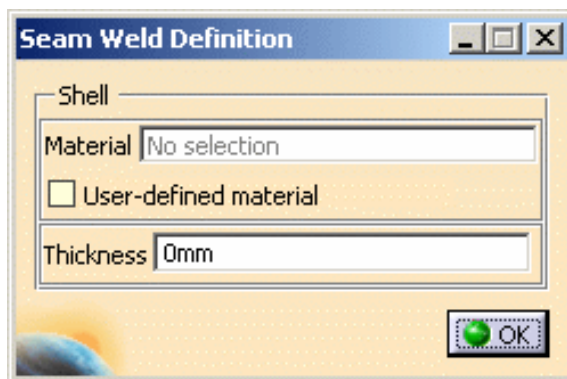

**Seam Weld Definition**

Shell

Material

User-defined material

Thickness

- **Material:** gives you information about the associated material.
- **User-defined material:** lets you select an user material.  
For more details, please refer [Creating an User Material](#).

- **Thickness:** lets you specify a thickness value.

**5.** Specify the desired parameters.

In this particular example:

- select the **User Defined Isotropic Material** option
- activate the **Material** text box
- select the **User Isotropic Material.1** object in the specification tree
- enter **1mm** as **Thickness** value

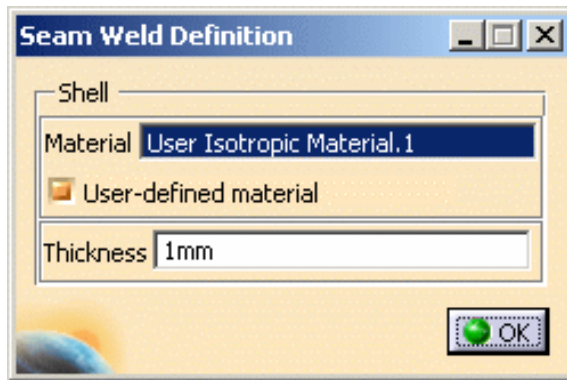

**6.** Click **OK** in the Seam Weld Definition dialog box.

Note that the **Component Edition** icon becomes valid.



**7.** Click **OK** in the Seam Weld Connection Property dialog box.

A **Seam Weld Connection Property.1** object appears in the specification tree under the **Properties.1** set and a **Weld Seam Connection Mesh.1** object appears under the **Nodes and Elements** set.

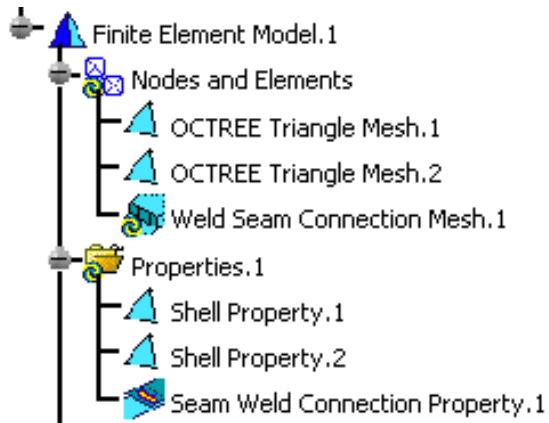

- You can edit the **Weld Seam Connection Mesh.1** object. For this, double-click the **Weld Seam Connection Mesh.1** object in the specification tree. The Seam Welding Connections dialog box appears.

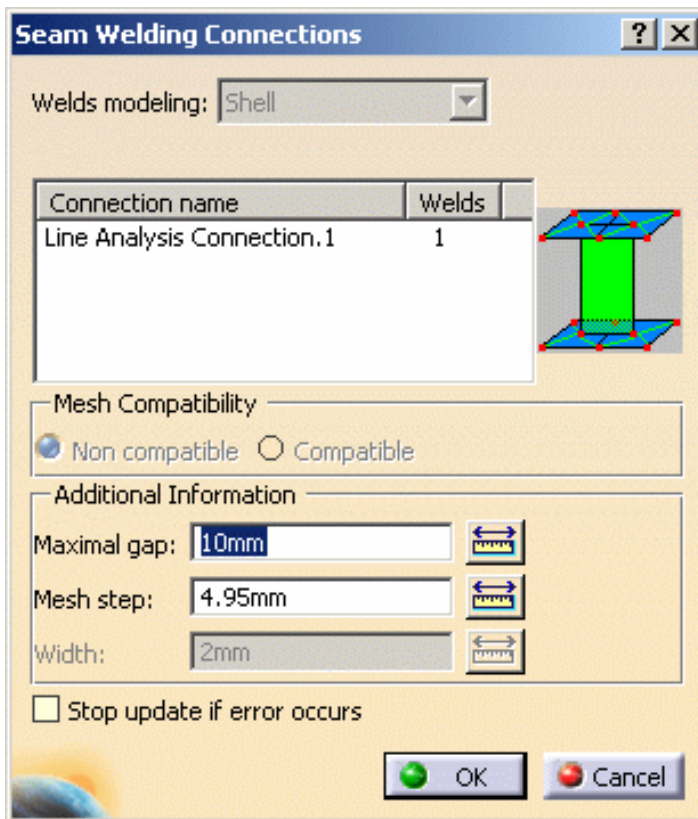

For more details about the weld seam connection mesh part, please refer to *Meshing Seam Welding Connections* in the *Advanced Meshing Tools User's Guide*.



The weld seam connection mesh part is created with a default **Step** value.

This value is computed as a ratio of the seam length.

In case this value is much smaller than the size of the connected meshes, the size of the problem to be solved is considerably increased. This may lead to an "Out of Memory" error.

You can find here a recommended methodology to avoid this error:

- 1.** Create the **Seam Weld Connection Property**.
  - 2.** Edit the **Weld Seam Connection Mesh** part in the specification tree.
  - 3.** Check that the **Step** value respects the proportion of the connected meshes (commonly used value: half of the smallest connected mesh).
  - 4.** Launch the computation.
- You can visualize the connection mesh. For this:
    - compute the mesh only (for more details, please refer to [Computing Objects Sets](#))
    - generate a **Mesh** image (for more details, please refer to [Generating Images](#))

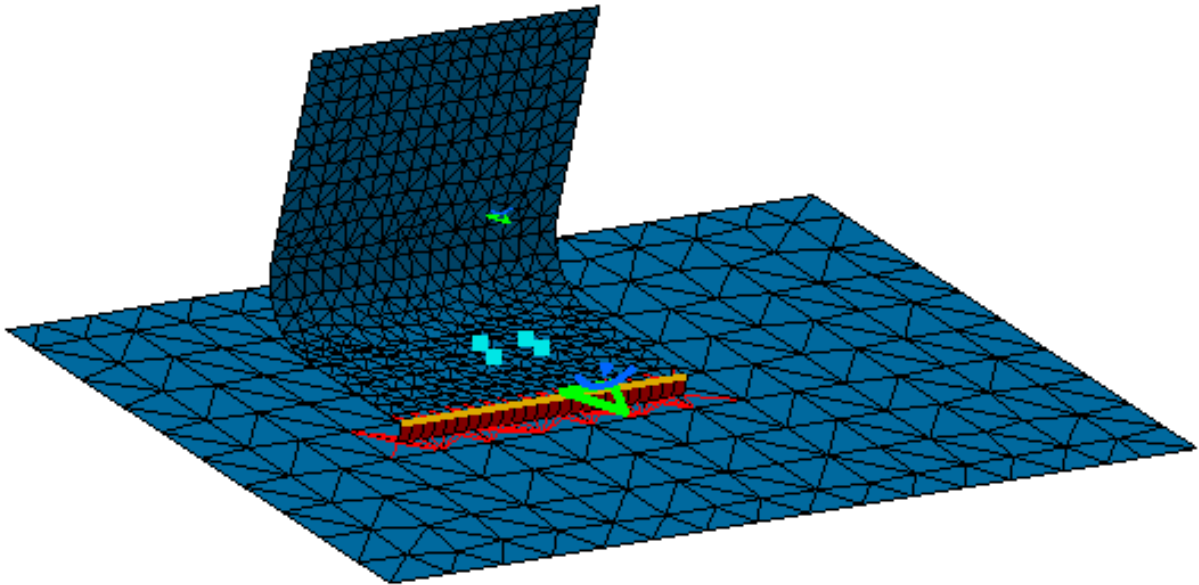



# Creating Surface Weld Connection Properties



This task shows how to create a Surface Weld Connection Property between two parts or within one part.

A surface weld connection property is a connection that is created from an existing Surface Analysis Connection or Surface Analysis Connection Within One Part.



This functionality is only available in the **Generative Assembly Structural Analysis (GAS)** product.



- Open the [sample11\\_1.CATAnalysis](#) document from the samples directory.
- Make sure you know all you need about [what type of property you will use for what type of connection](#).



1. Select the **Surface Weld Connection Property** icon .

The Surface Weld Connection Property dialog box appears.



- **Name:** lets you change the name of the connection property.
- **Supports:** lets you select the connection you want to associate to a property.



You can apply the surface welding connection property to [Surface Analysis Connection](#) and [Surface Analysis Connection within one Part](#) of the *Generative Assembly Structural Analysis (GAS)* product.

For more details, please refer to [About Connection Properties](#).

- **Type:**
  - **Hexahedron:** the connection is meshed using hexahedron elements.

- **Component Edition** : lets you specify the associated material.



The **Component Edition** button can have two status:

- valid: 

- invalid: 

2. Select the surface welding connection.

In this particular example, select **Surface Analysis Connection.1** object in the specification tree.

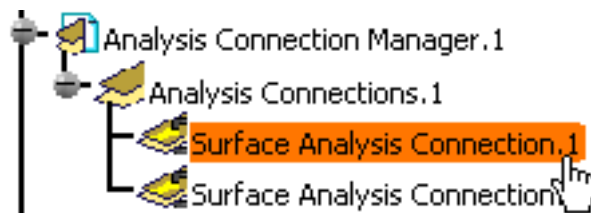

3. Click the **Component Edition** button  to specify the parameters.

The Surface Weld Definition dialog box appears.

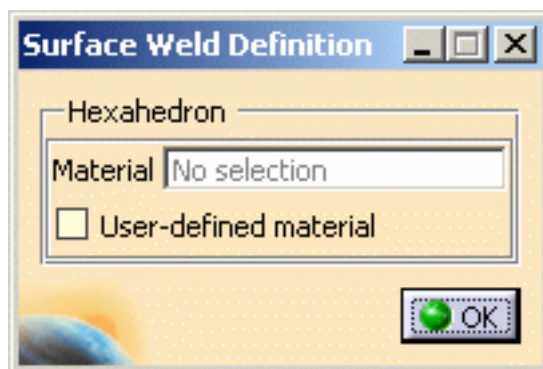

- **Material:** gives you information about the associated material.
- **User-defined material:** lets you select an user material.



For more details, please refer [Creating an User Material](#).

4. Select the **User-defined material** option in the Surface Weld Definition dialog box.
5. Activate the **Material** text box as shown bellow:

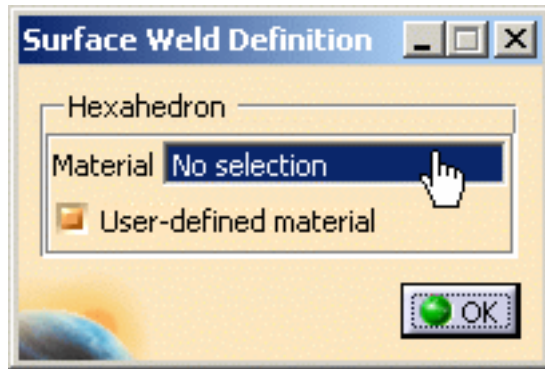

6. Select **User Material.1** as **Material**.

The Surface Weld Definition dialog box is updated:

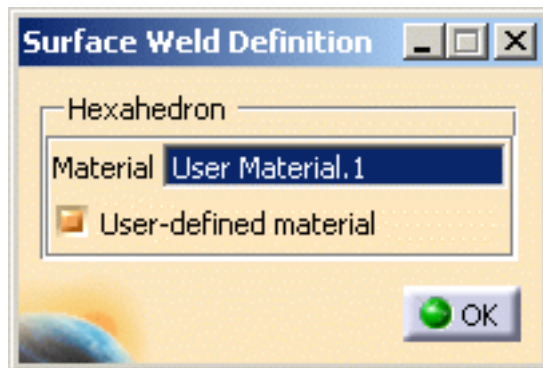

7. Click **OK** in the Surface Weld Definition dialog box.

Note that the **Component edition** icon becomes valid in the Surface Weld Connection Property dialog box:

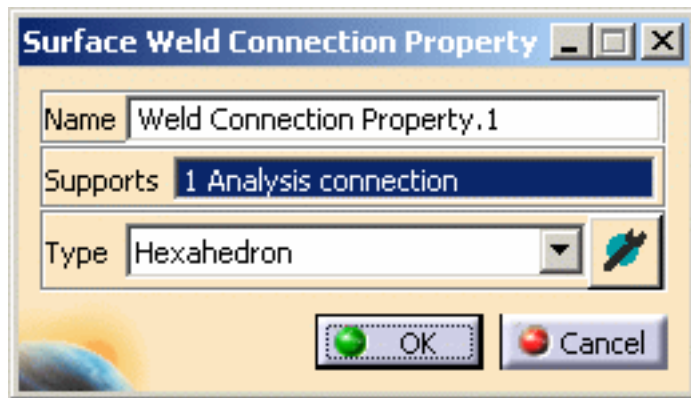

8. Click **OK** in the Surface Weld Connection Property dialog box.

A **Surface Weld Connection Property.1** object appears in the specification tree under the **Properties.1** set and a **Weld Surface Connection Mesh.1** object appears under the **Nodes and Elements** set.

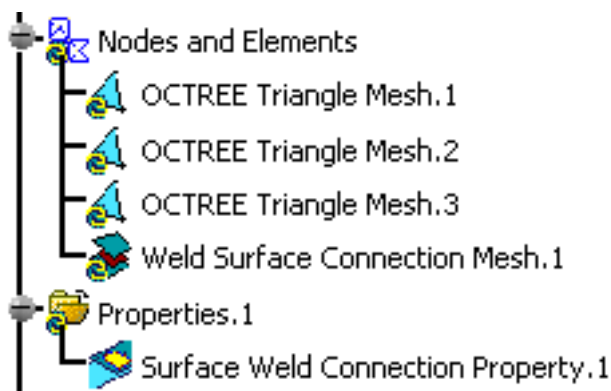

A symbol appears on the geometry:

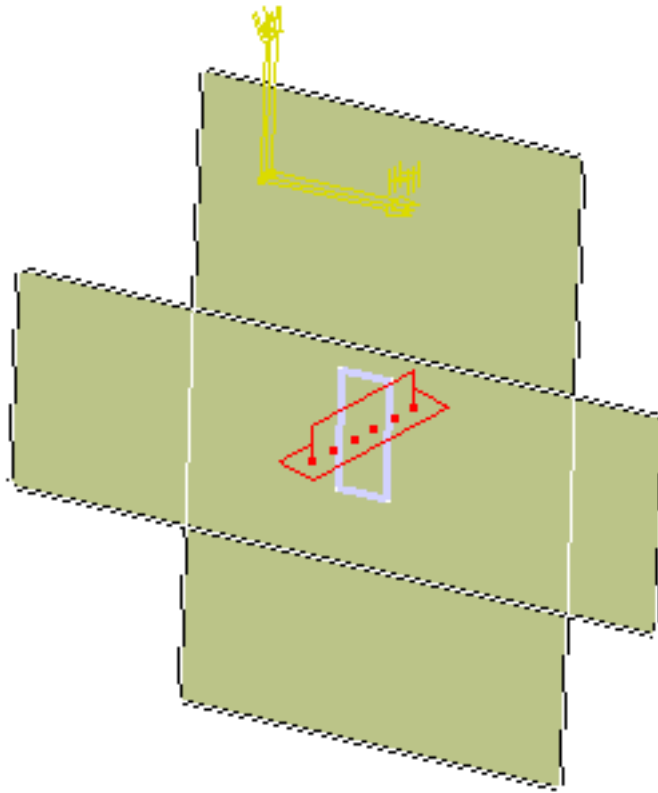

- You can edit the **Weld Surface Connection Mesh.1** object.

For this, double-click the **Weld Seam Connection Mesh.1** object in the specification tree.

The Surface Welding Connections dialog box appears.

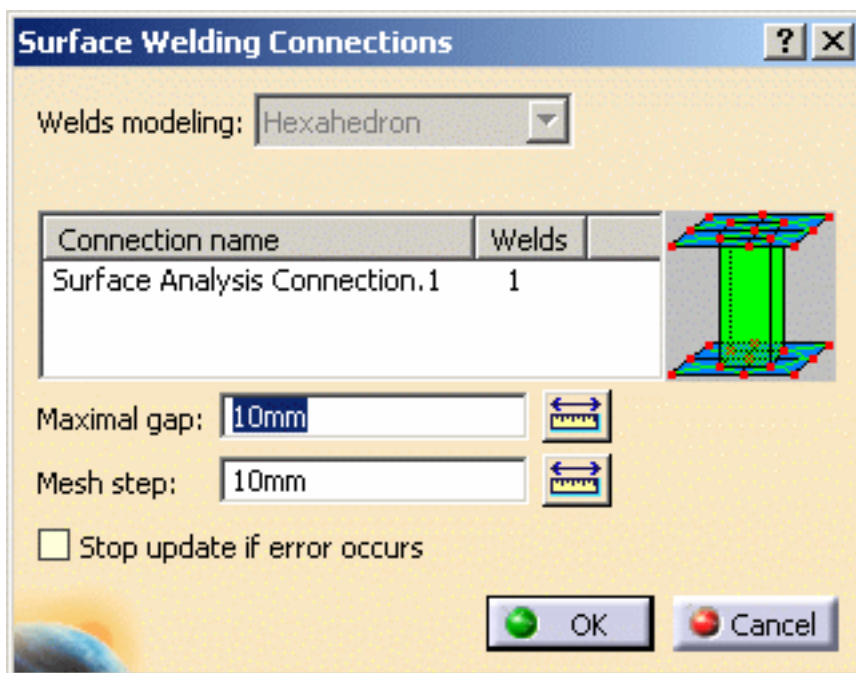

For more details about the surface weld connection mesh part, please refer to *Meshing Surface Welding Connections* in the *Advanced Meshing Tools User's Guide*.

- You can visualize the connection mesh. For this:
  - compute the mesh only (for more details, please refer to [Computing Objects Sets](#))
  - generate a **Mesh** image (for more details, please refer to [Generating Images](#))





# Analysis Assembly



The following functionalities are only available with the **Generative Assembly Structural Analysis (GAS)** product.

## [About Analysis Assembly](#)

You can find here general information about the Analysis Assembly context.

## [Analysis Assembly Methodology](#)

Methodology of work in Analysis Assembly context.



## [Analysis Assembly 2D Viewer](#)

You can visualize the analysis document structure.



# About Analysis Assembly



You will find here general information about the Analysis Assembly concept.



This functionality is only available in the **Generative Assembly Structural Analysis (GAS)** product.

Analysis assembly provides a general solution based on reusability of the analysis document (**.CATAnalysis** file). Consequently the simulation of a complex product structure can be split into several independent sub-analysis performed by several users and assembled together in a global analysis called assembled analysis.

The Analysis Assembly definition will be done in both the Generative Structural Analysis workbench and the Advanced Meshing Tools workbench.

All analysis data (such as mesh, properties and materials) are retrieved without data duplication.

You can find here the notations used in this document:

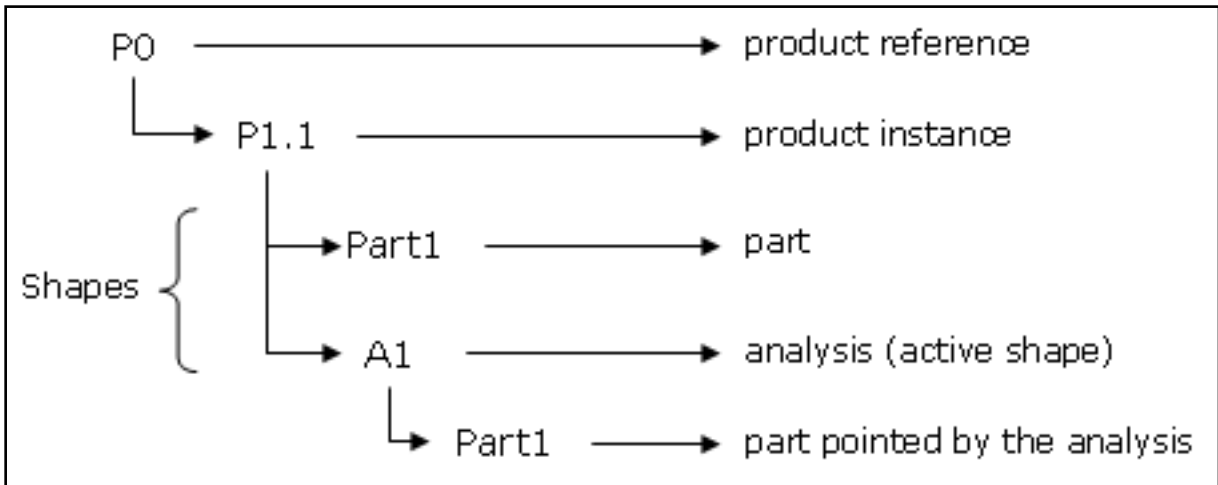

The supported product structure are:

**Product Structure:**

**Assembly of:**

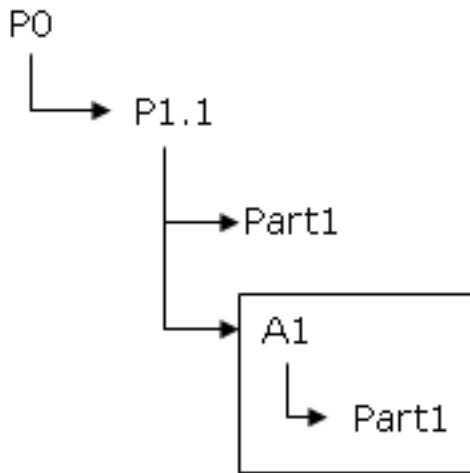

#### Analysis on Part

- The shape **A1** must be activated when creating the assembled analysis.
- The part pointed by the **A1** must be the same as **Part1**.

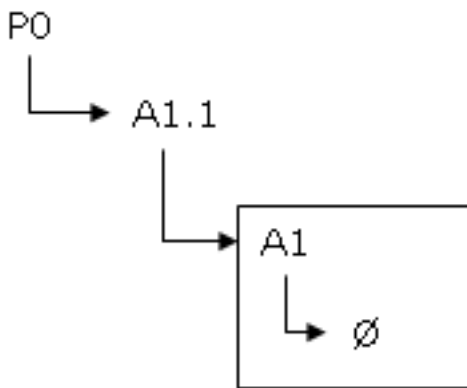

#### Orphan mesh (imported mesh)

**A1** is not pointing any geometry.

- **Finite Element Model:**

Properties and mesh parts can be defined either in the sub-analysis or in the assembled analysis but the mesh part and its associated property must be defined in the same analysis (under the same **Analysis Manager**).

- **Connection Properties:**

Only the weld connection properties (spot weld, seam weld and surface weld) are authorized in the assembled analysis. All these connections can be applied between mesh parts and geometrical bodies.

- **Pre-processing Specifications:**

The pre-processing specifications such as restraints and loads can be defined either in sub-analysis or in the assembled analysis.

The pre-processing specifications defined in a sub-analysis will be ignored in the assembled **Finite Element Model**.

All the functionalities belonging to the **Generative Part Structural Analysis (GPS)** product and the **ELFINI Structural Analysis (EST)** product are available in the assembled analysis. These specifications can be applied on any geometry and groups of the specification tree. They are automatically linked to all meshes throughout the assembly.

- **Solving Process:**

The standard simulation solving processes are supported in the analysis assembly context.

- **Post-processing Specifications:**

The result management is supported in the analysis assembly context. Finite element visualization is available on assembly, as well as sensors and reporting.







# Analysis Assembly Methodology



This task will show you how to work in Analysis Assembly context to build an assembly of:

- analysis on part
- orphan analysis



This functionality is only available in the **Generative Assembly Structural Analysis (GAS)** product.



Open the [Assembly.CATProduct](#) from the samples directory.

The product structure is the following:

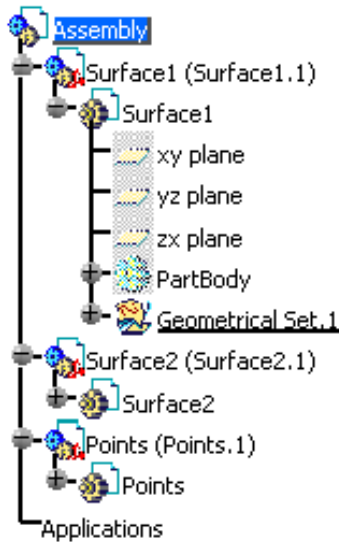

## Assembly of Analysis on Part



1. Associate one or several analysis to the **Surface1** part and activate one analysis representation.

a. Right-click the **Surface.1** part and select the **Representations -> Manage Representations...**

contextual menu 



Make sure you work in a product context.

To work in a product context, double-click the root product in the specification tree (in this particular example, double-click **Assembly**).

The Manage Representations dialog box appears.

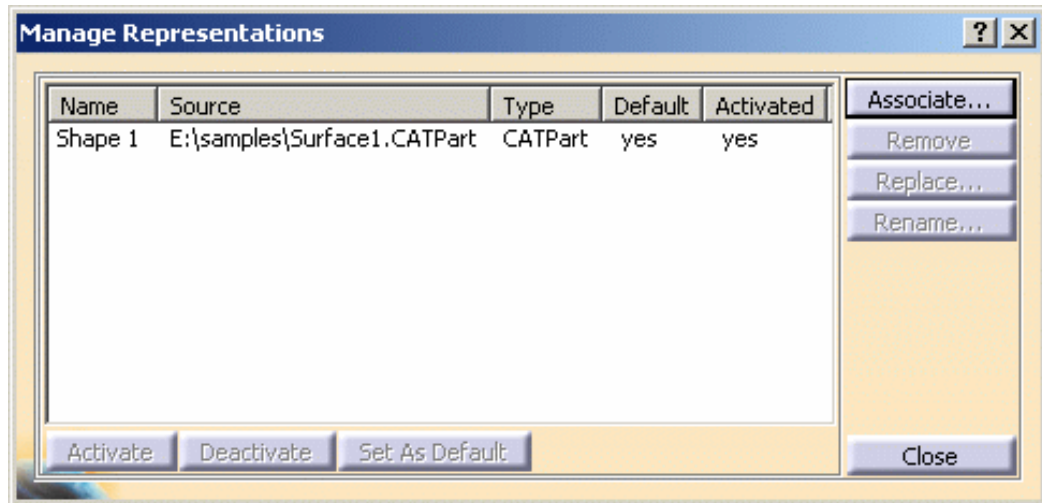

- b.** Click the **Associate...** button in the Manage Representations dialog box.

The Associate Representation dialog box appears.

- c.** Select the **AnalysisSurface11.CATAnalysis** document in the sample directory and click the **Open** button.
- d.** Click the **Associate...** button in the Manage Representations dialog box, select the **AnalysisSurface11.CATAnalysis** document in the sample directory and click the **Open** button.

The Manage Representation dialog box is updated:

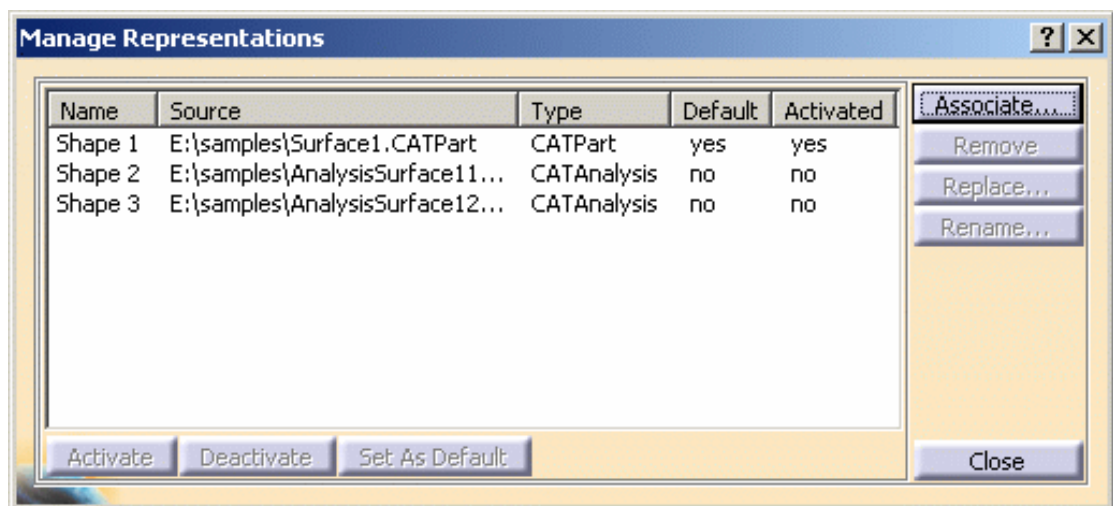

Note that:

- the two associated representations are deactivated.
  - you can remove, replace or rename a selected shape.  
For more details, please refer to *Managing Representations - Product Structure User's Guide*.
- e.** Select **AnalysisSurface11.CATAnalysis** in the Manage Representations dialog box and click the **Activate** button.

The Manage Representation dialog box is updated:

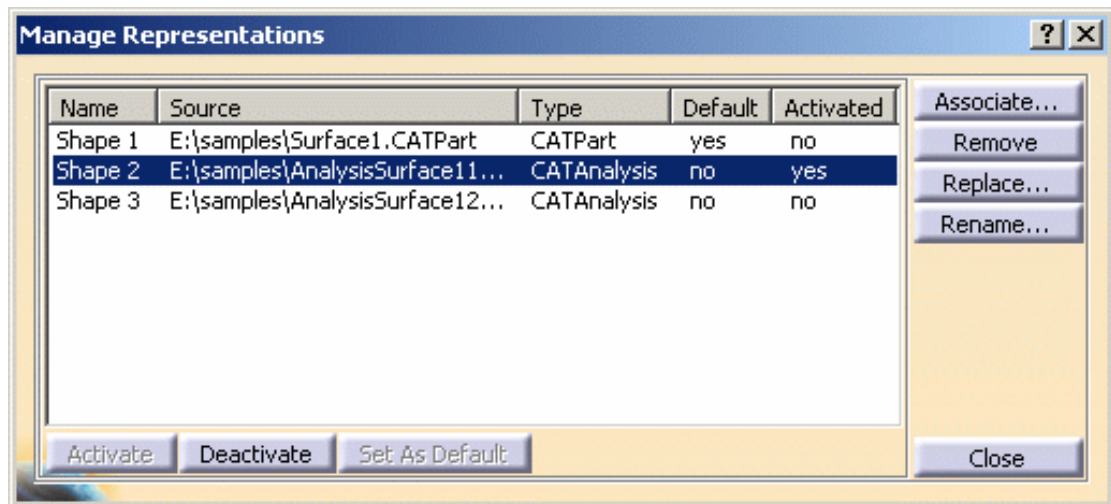

f. Click **Close** in the Manage Representations dialog box.

Note that an **Analysis Manager** appears under the **Surface1** part in the specification tree:

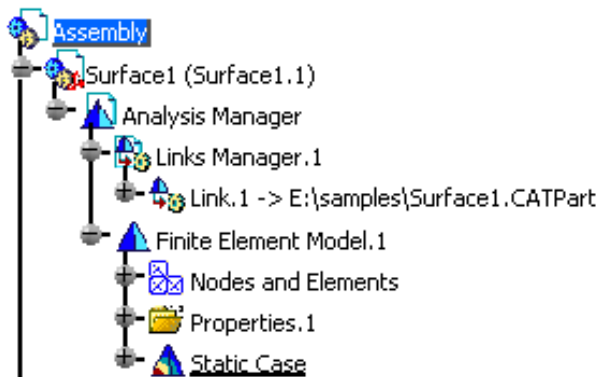

2. Associate the **AnalysisSurface2.CATAnalysis** document to the **Surface2** part and activate this representation.

The specification tree is updated as shown below:

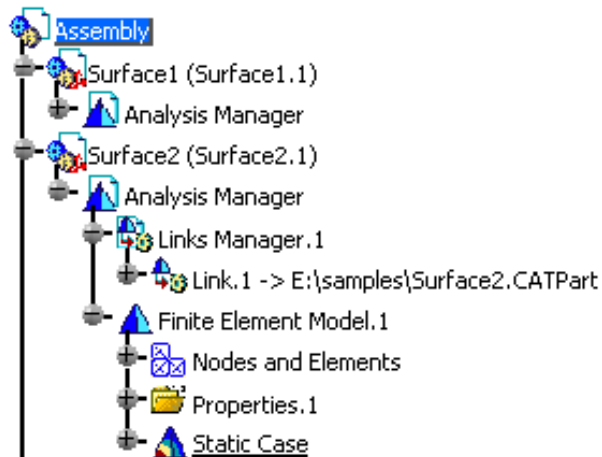

3. Enter the Generative Structural Analysis workbench.

For this, select the **Start -> Analysis and Simulation -> Generative Structural Analysis** menu.

Select **Static Case** and click **OK** in the New Analysis Case dialog box.

The specification tree is updated as shown below:

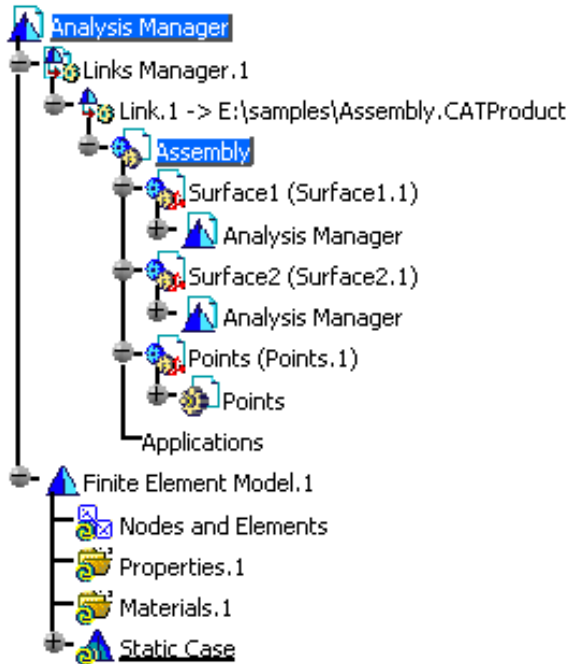

The **Nodes and Elements**, **Properties** and **Material** sets are empty in the specification tree.

The **Mesh Visualization** contextual menu is available.

4. Create the pre-processing specifications either in the sub-analysis or in the assembled analysis.



- To activate an analysis, double-click the associated **Analysis Manager**.
- At any time you can add/remove a shape, activate/deactivate an associated shape or add/remove a product component.

For more details, please refer to [Analysis Assembly 2D Viewer](#).

At this step, you can open the [sample14.CATAnalysis](#) document in which all the analysis specifications have been already defined and follow the scenario.

5. Compute the solution.

For this, click the **Compute** icon, select the **All** option and click **OK** in the Computation dialog box.

6. Define the post-processing specifications.



Any analysis shape which is not active at creation will be ignored in the assembly.

In case of several analysis shapes are associated to the same product instance, only the active shape will be taken into account in the assembled analysis.

To check the content of the assembled analysis, you can use the **Shape Management** command.

# Assembly of Orphan Analysis (Imported Mesh)

You can find here the methodology for orphan analysis creation.

1. Create an new analysis document.
2. Use the **Import Mesh** command of the *Advanced Meshing Tools* workbench to import an **.dat** file.  
For more details, please refer to the *Advanced Meshing Tools User's Guide*.
3. Complete the property set in the Generative Structural Analysis workbench.
4. Insert the orphan analysis in the product structure using the **Existing Component** command.





# Analysis Assembly 2D Viewer



This task will show you how to synchronize the analysis assembly content with the product changes.

At any time, you can add or remove a shape, activate or deactivate an existing shape and add or remove a product component in a analysis assembly context. The content of the analysis assembly is not automatically synchronize.



This functionality is only available in the **Generative Assembly Structural Analysis (GAS)** product.



Open the [sample14.CATAnalysis](#) from the samples directory.

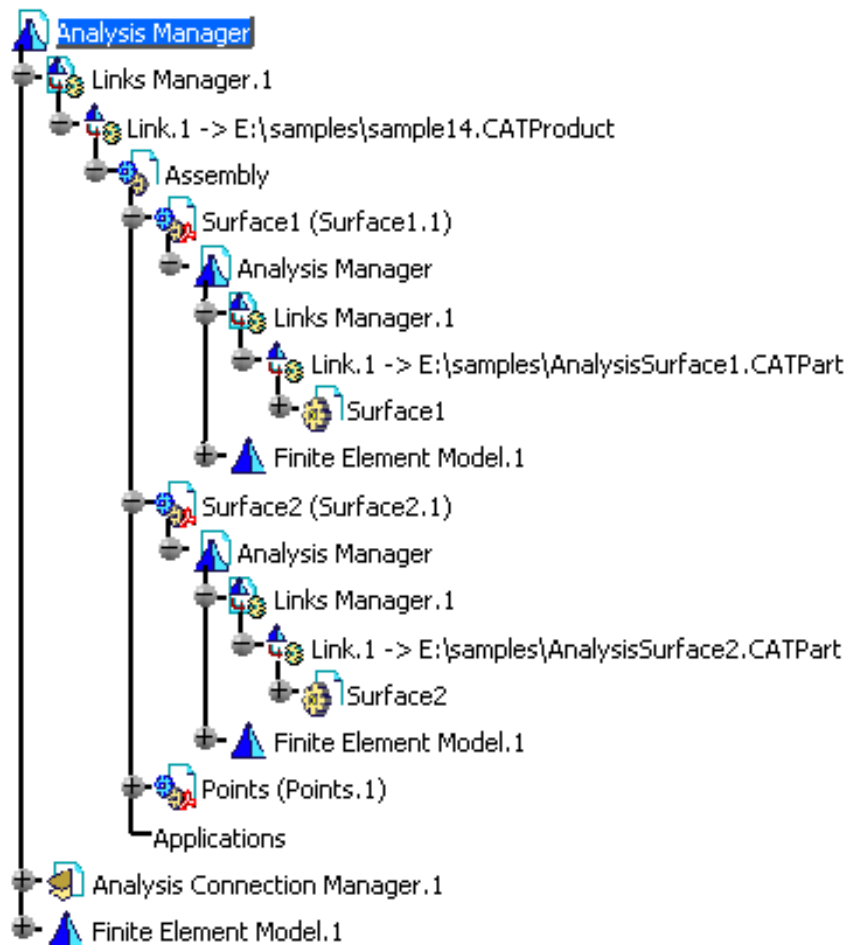



1. Click the **Analysis Assembly 2D Viewer** icon .

The Assembled Analysis Definition dialog box appears.

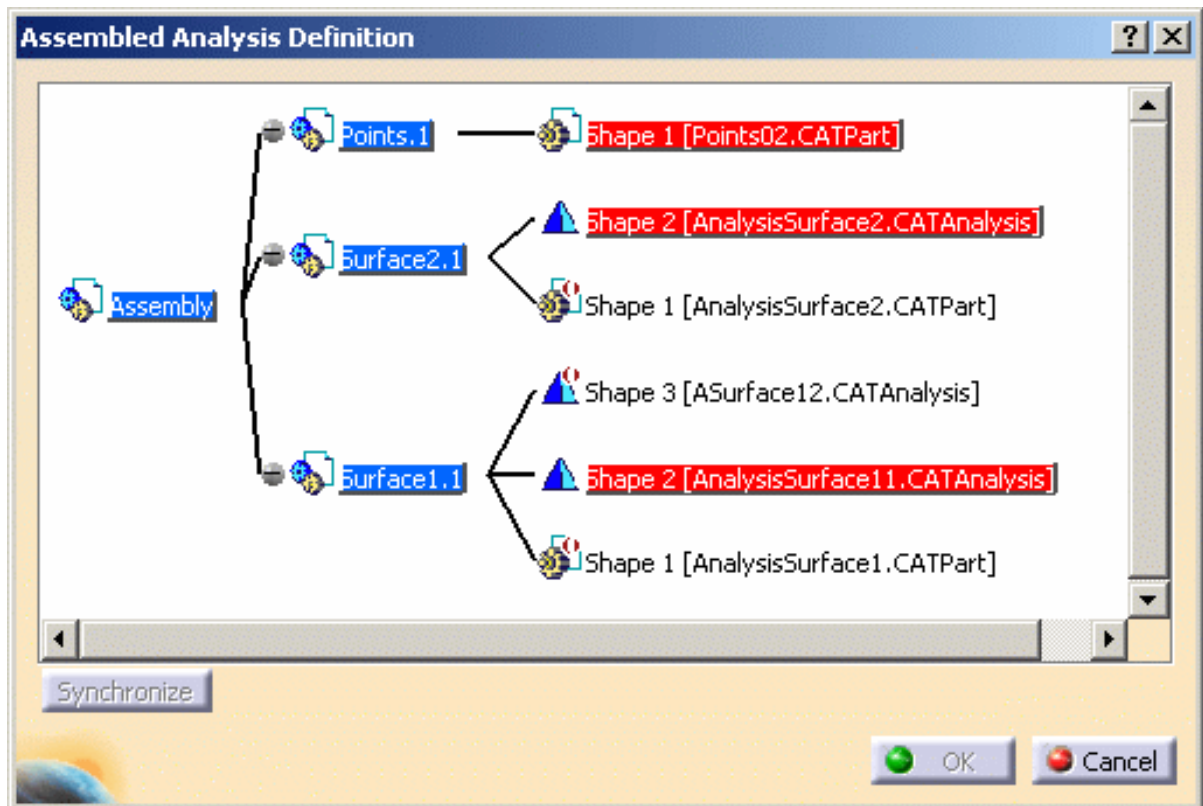

- **Graph:** lets you visualize the analysis structure.
  - The  symbol indicates that the shape is deactivate.
  - The red highlight indicates that the shape is the current active shape.
- **Synchronize:** lets you synchronize the analysis document with the activated shapes. This button is available if you modify the product structure.

2. Click **Cancel** in the Assembled Analysis Definition dialog box.

3. Change the shape associated to a sub-analysis.

In this particular example:

- a. Double-click **Assembly** in the specification tree.
- b. Right-click the **Surface.1** part and select the **Representations -> Manage Representations...** contextual menu.
- c. Select **AnalysisSurface11.CATAnalysis** in the Manage Representations dialog box and click the **Deactivate** button.
- d. Select **ASurface12.CATAnalysis** in the Manage Representations dialog box and click the **Activate** button.

- e. Click **Close** in the Manage Representations dialog box.
4. Double-click **Analysis Manager** in the specification tree to retrieve the analysis context.
5. Click the **Analysis Assembly 2D Viewer** icon .

The Assembled Analysis Definition dialog box appears as shown below:

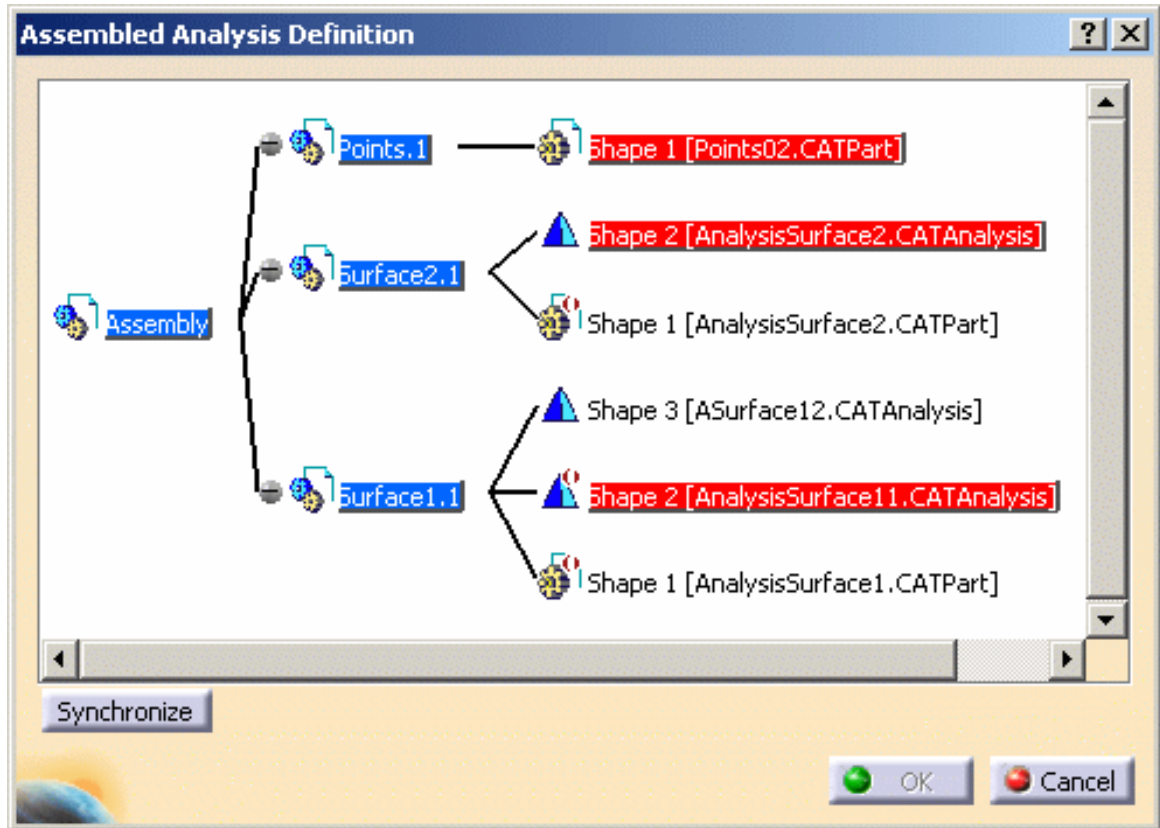

 The active shape (**Shape 3 [ASurface12.CATPart]** in this particular example) is not highlighted.

You have to synchronize the analysis document with the activated shapes.

6. Click the **Synchronize** button.

The Assembled Analysis Definition is updated.



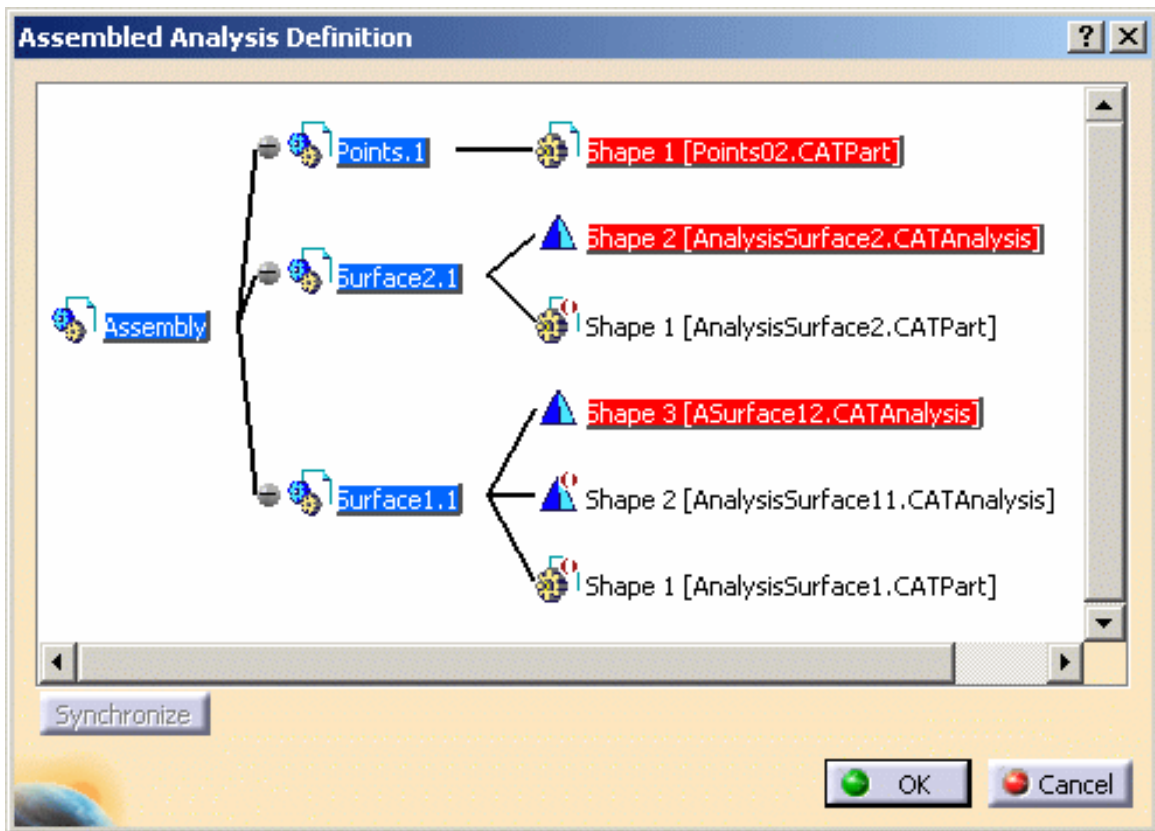

The active shape is now red-highlighted.

7. Click **OK** in the Assembled Analysis Definition dialog box.



You can find here the specification tree of an assembly of orphan analysis:

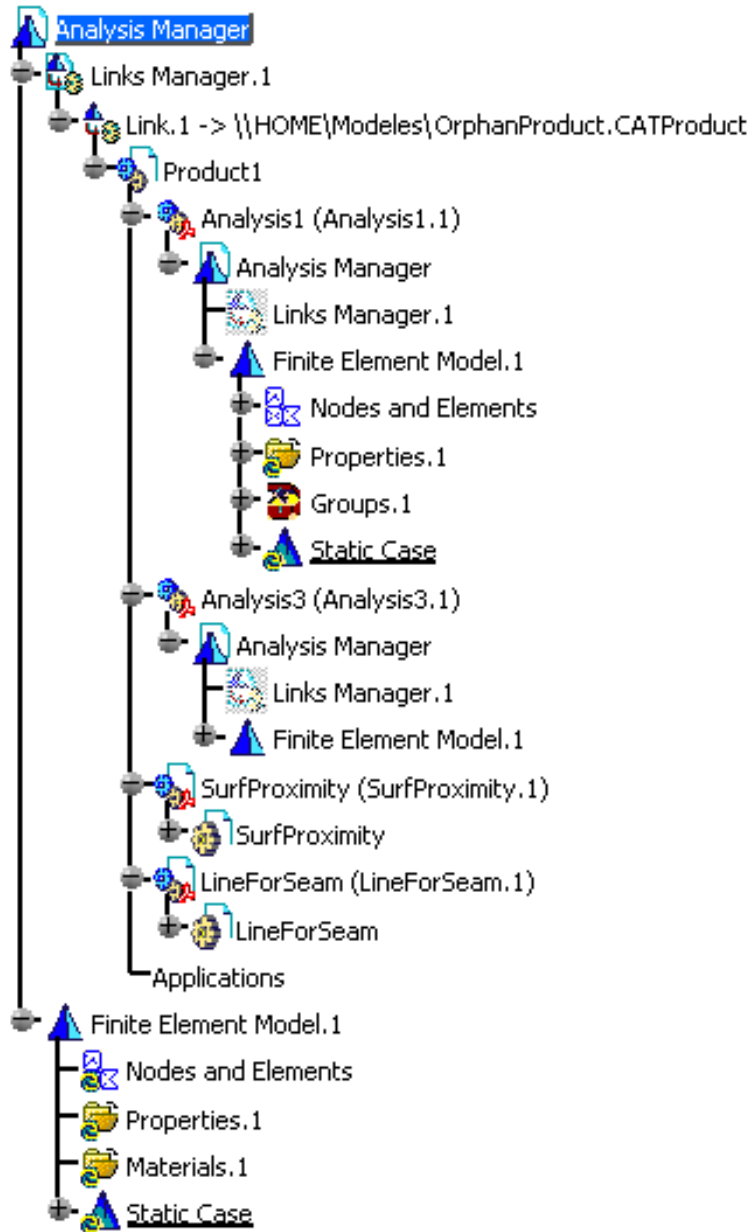

Note that: **Analysis1 (Analysis1.1)** and **Analysis1 (Analysis1.1)** are not pointing any geometry

You can find here the graph of an assembly of orphan analysis:

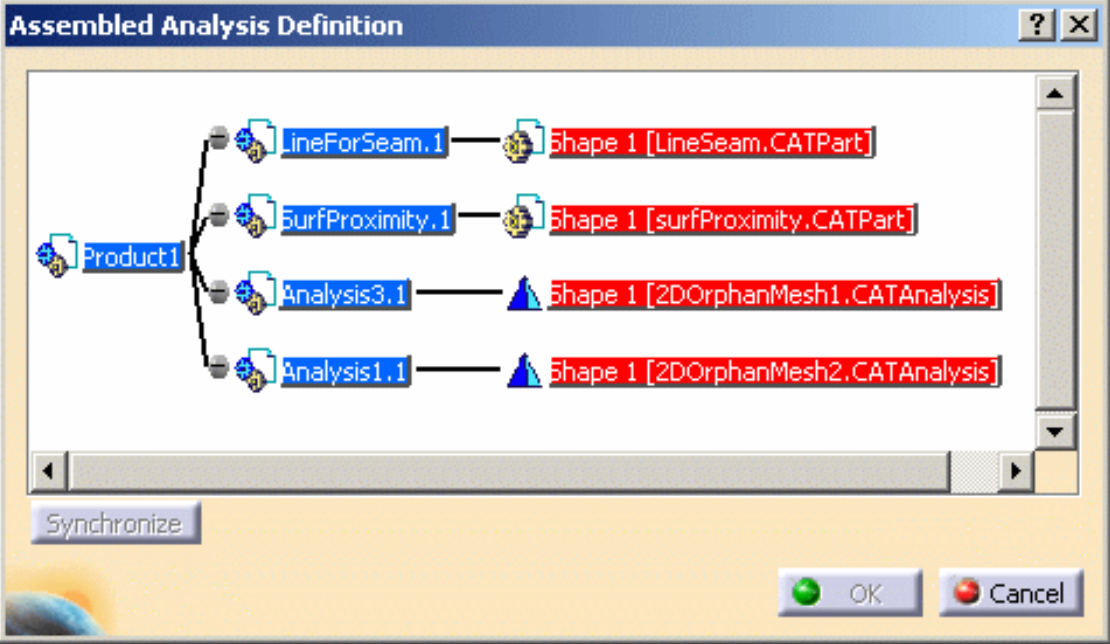

# Virtual Parts



*Virtual Parts* are structures created without a geometric support. They represent bodies for which no geometry model is available, but which play a role in the structural analysis of single part or assembly systems.

Virtual Parts are used to transmit action at a distance. Therefore they can be thought of as rigid bodies, except for the case where a lumped flexibility is explicitly introduced by the means of a spring element.



Do not use Virtual Parts to simulate connections.

To simulate connections, please use [Analysis Connections](#) of the Generative Structural Analysis (GAS) product.



## Create Rigid Virtual Parts

Generate a stiff transmission rigid virtual part.



## Create Smooth Virtual Parts

Generate a soft transmission rigid virtual part.



## Create Contact Virtual Parts

Generate a contact transmission rigid virtual part.



## Create Rigid Spring Virtual Parts

Generate a stiff transmission elastic spring virtual part.



## Create Smooth Spring Virtual Parts

Generate a soft transmission elastic spring virtual part.



## Create Periodicity Conditions

Simulate periodicity conditions by linking together the degrees of freedom of two faces that undergo transformation.

# Creating Rigid Virtual Parts



This task shows how to create a Rigid Virtual Part between a point and a geometry support.



A Rigid Virtual Part is a rigid body connecting a specified point to specified part geometries, behaving as a mass-less rigid object which will stiffly transmit actions (masses, restraints and loads) applied at the handle point, while locally stiffening the deformable body or bodies to which it is attached.

The Rigid Virtual Part does not take into account the elastic deformability of the parts to which it is attached.

The program proceeds as follows:

- a node is created in coincidence with the specified handle point.
- each node of the specified geometry supports meshes is connected by a kinematical rig-beam element to the handle node.
- a set of rig-beam relations is generated between the handle node degree of freedom and the connected nodes degree of freedom.

Thus, the Rigid Virtual Part generates as many rig-beam kinematical elements as there are nodes on specified support meshes.

The Rigid Virtual Part is built with a Rigid Spider element.

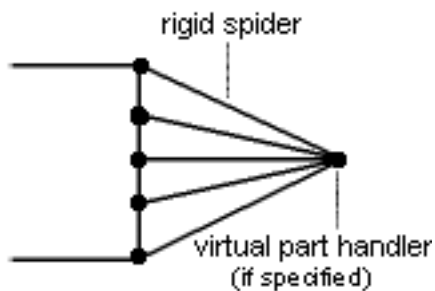

To know more about this element, see [Rigid Spider](#) in the *Finite Element Reference Guide*.



Rigid Virtual Parts can be applied to the following types of Supports:

Mechanical Feature	Geometrical Feature					Analysis Feature	Mesh Part
	Point or Vertex	Curve or Edge	Surface or Face	Volume or Part	Group		



You can use the [sample28.CATAnalysis](#) document from the samples directory for this task: [Finite Element Model](#) containing a Static Analysis Case and computed corresponding [Static Solution](#). A **Part Design** point was created on the associated CATPart document.

#### Before You Begin:

Go to **View -> Render Style -> Customize View** and make sure the **Shading**, **Outlines** and **Materials** options are active in the Custom View Modes dialog box.



1. Click the **Rigid Virtual Part** icon .

The Rigid Virtual Part dialog box appears.



2. Select a face or an edge of the part as a geometry support. In this particular case, select a face.

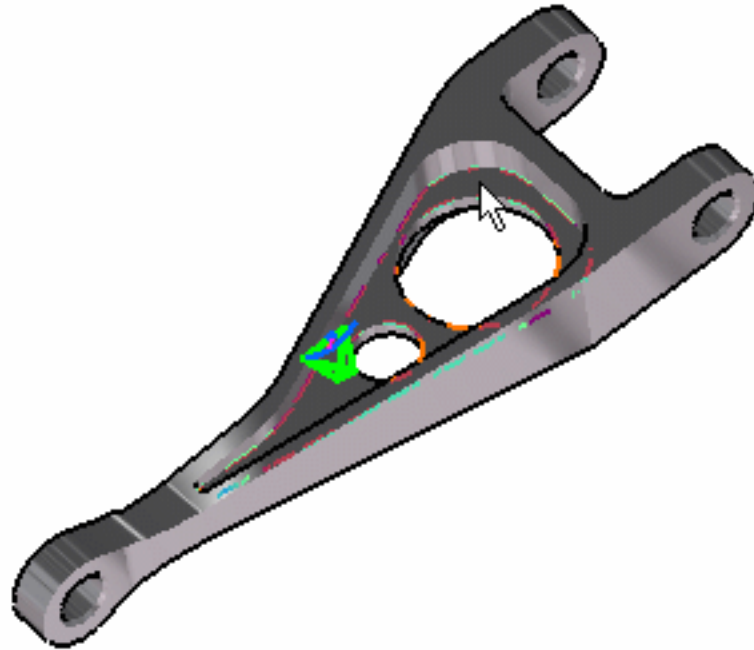

3. Click the **Select Mesh Parts** button in the Rigid Virtual Parts dialog box.
4. Position the cursor on the **Handler** field in the Rigid Virtual Part dialog box and select a vertex or a point as handler point (the handler point symbol appears as your cursor passes over it). In this case, select a point.

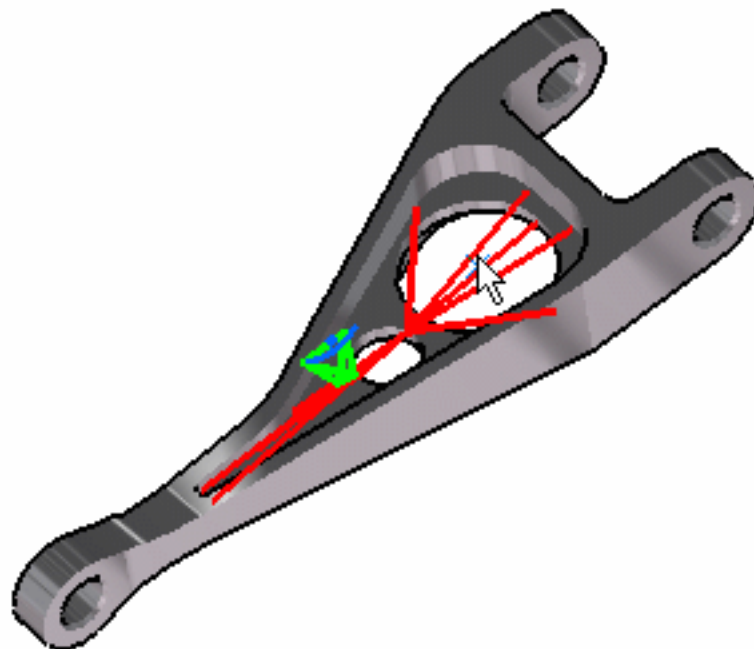

- ⚠ This point selected as handler must be a Part Design point.
- If you do not specifically select a point, the centroid (the point at which the lines meet) will be used as the handler point.
- When several virtual parts share a same handler point, only one finite element node is generated.

The Rigid Virtual Part dialog box is updated.



5. Click **OK** to create the Rigid Virtual Part.

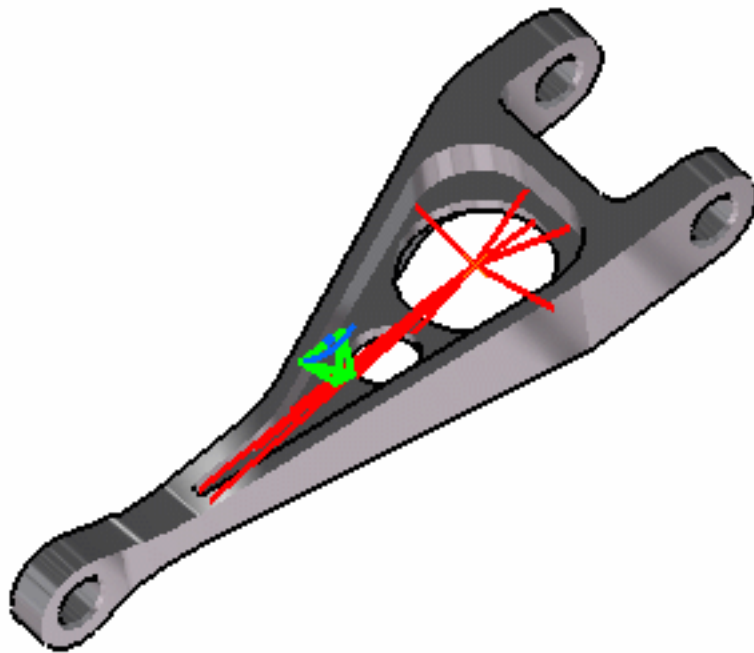

A Rigid Virtual Part object appears in the specification tree under the active **Nodes and Elements** objects set.

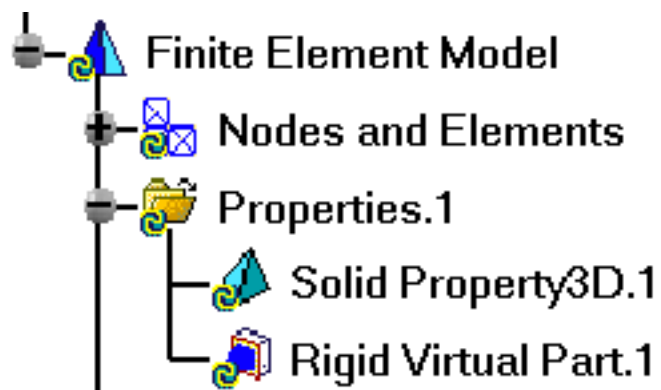





When a 1D mesh part is created by selecting two virtual parts handler, the nodes are not condensed. The beam mesh part must be created first.

Do not use virtual parts to simulate connections. You should use the Analysis Connection.



- You can select several geometry supports.
- The Rigid Virtual Part will connect all supports to the handle point and stiffly transmit all actions as a rigid body.



# Creating Smooth Virtual Parts



This task shows how to create a Smooth Virtual Part between a point and a geometry support.



A Smooth Virtual Part is a rigid body connecting a specified point to specified part geometries, behaving as a mass-less rigid object which will softly transmit actions (masses, restraints and loads) applied at the handle point, without stiffening the deformable body or bodies to which it is attached.

The Smooth Virtual Part does approximately take into account the elastic deformability of the parts to which it is attached.

The program proceeds as follows:

- a node is created in coincidence with the specified handle point.
- all nodes of the specified geometry supports meshes are connected by a kinematical spider element to the handle node.
- a set of mean (constr-n) relations is generated between the handle node degree of freedom and the connected nodes degree of freedom.

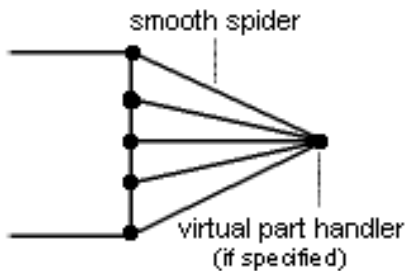

The Smooth Virtual Part is built with a Smooth Spider element.



To know more about this element, see [Smooth Spider](#) in the *Finite Element Reference Guide*.



Smooth Virtual Parts can be applied to the following types of Supports:

Mechanical Feature	Geometrical Feature				Analysis Feature
	Point or Vertex	Curve or Edge	Surface or Face	Volume or Part	
					



You can use the [sample28.CATAnalysis](#) document from the samples directory for this task: [Finite Element Model](#) containing a Static Analysis Case and computed corresponding [Static Solution](#). A **Part Design** point was created on the associated CATPart document.

**Before You Begin:**

Go to **View -> Render Style -> Customize View** and make sure the **Shading, Outlines** and **Materials** options are active in the Custom View Modes dialog box.



1. Click the **Smooth Virtual Part** icon .

The Smooth Virtual Part dialog box appears.



2. Select an edge or a face of the part as geometry support. In this case, select a face.

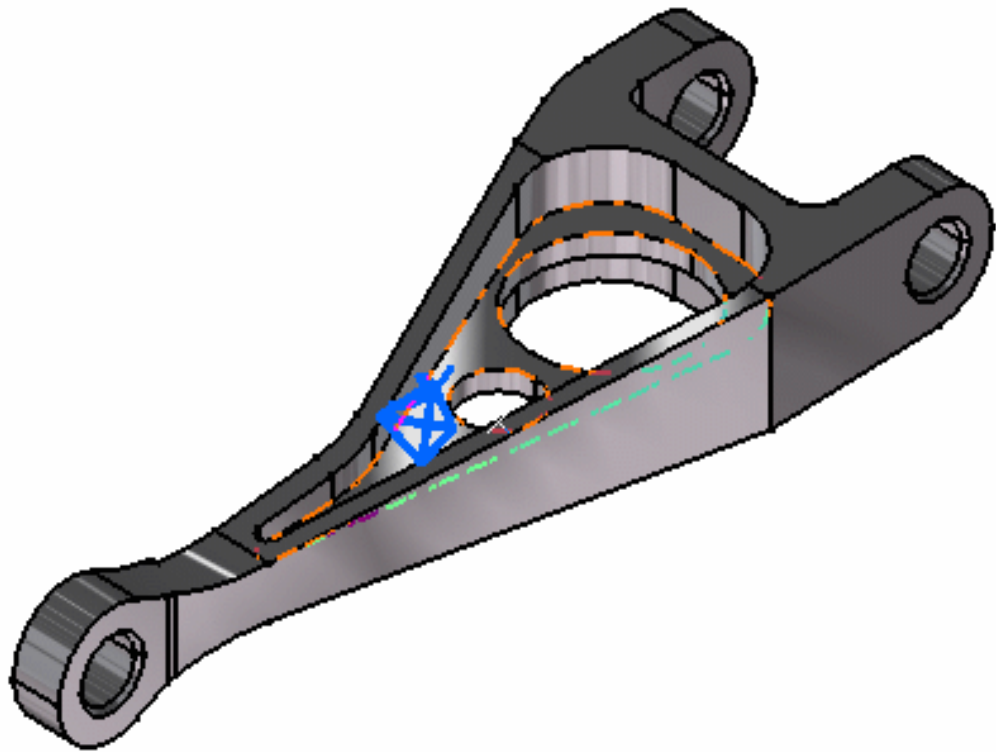

3. Position the cursor on the **Handler** field in the Smooth Virtual Part dialog box and select a point or a vertex as the handler point (the handler point symbol appears as your cursor passes over it). In this case, select a point.

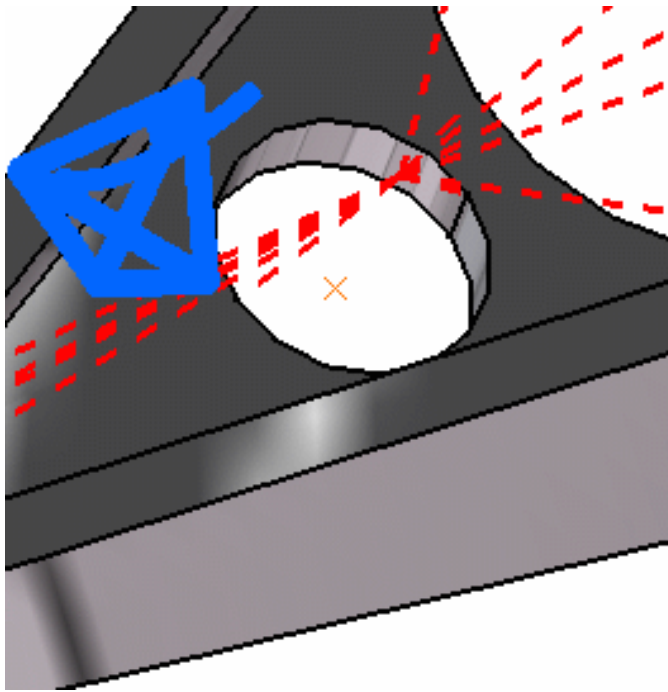

The Rigid Virtual Part dialog box is updated.



If you do not specifically select a point, the centroid (the point at which the lines meet) will be used as the handler point.

4. Click **OK** to create the Smooth Virtual Part.

When several virtual parts share a same handler point, only one finite element node is generated.

The symbol appearing at the handler point represents the Smooth Virtual Part.

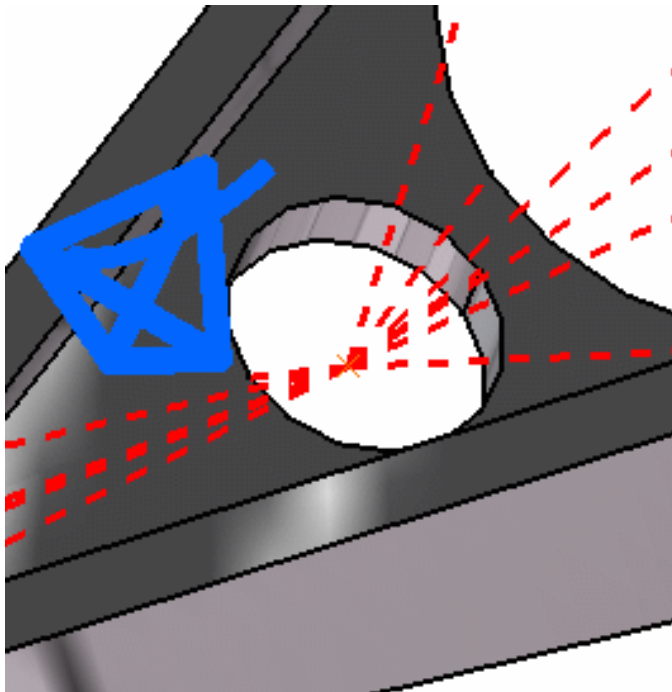

A Smooth Virtual Part object appears in the specification tree under the active **Nodes and Elements** objects set.

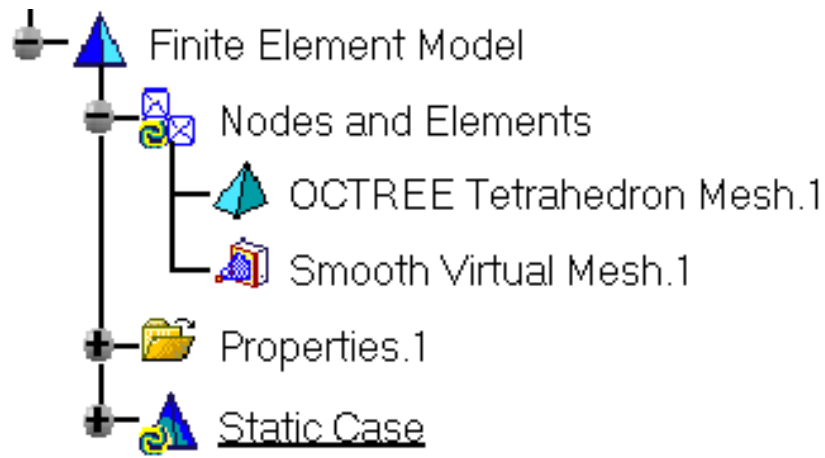

- You can select several geometry supports.
- The Smooth Virtual Part will connect all supports to the handle point and softly transmit all actions as a rigid body.



# Creating Contact Virtual Parts



This task shows how to create a Contact Virtual Part between a point and a geometry support.



A Contact Virtual Part is a rigid body connecting a specified point to specified part geometries, behaving as a mass-less rigid object which will transmit actions (masses, restraints and loads) applied at the handle point, while preventing from body interpenetration and thus without stiffening the deformable body or bodies to which it is attached.

The Contact Virtual Part does take into account the elastic deformability of the parts to which it is attached.

The program proceeds as follows:

- a node is created in coincidence with the specified handle point.
- each node of the specified geometry supports meshes is offset in the local normal direction by a small amount and a contact element is generated between each pair of offset nodes, generating a set of contact relations with a right-hand side equal to the user-defined clearance.
- each offset node is connected by a kinematical rig-beam element to the handle node.
- a set of rig-beam relations is generated between the handle node degree of freedom and the connected offset nodes degree of freedom.

Thus, the Contact Virtual Part generates as many rig-beam kinematical elements and as many contact elements as there are nodes on specified support meshes.

The Contact Virtual Part is built with Rigid Spider and Contact Rod elements.

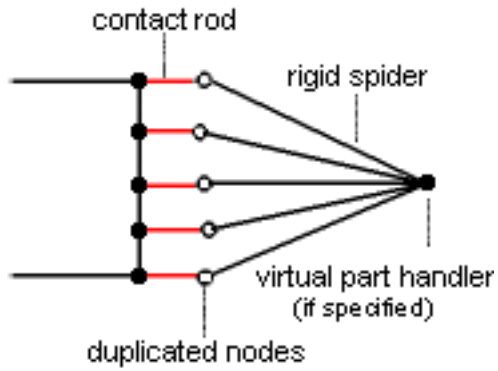

To know more about those elements, see [Rigid Spider](#) and [Contact Rod](#) in the *Finite Element Reference Guide*.



Contact Virtual Parts can be applied to the following types of Supports:

Mechanical Feature	Geometrical Feature				Analysis Feature
	Point or Vertex	Curve or Edge	Surface or Face	Volume or Part	
		▲	▲		



Open the [sample28.CATAnalysis](#) document from the samples directory for this task: [Finite Element Model](#) containing a Static Analysis Case and computed corresponding [Static Solution](#). A **Part Design** point was created on the associated CATPart document.

**Before You Begin:**

Go to **View -> Render Style -> Customize View** and make sure the **Shading**, **Outlines** and **Materials** options are active in the Custom View Modes dialog box.





1. Click the **Contact Virtual Part** icon .

The Contact Virtual Part dialog box appears.

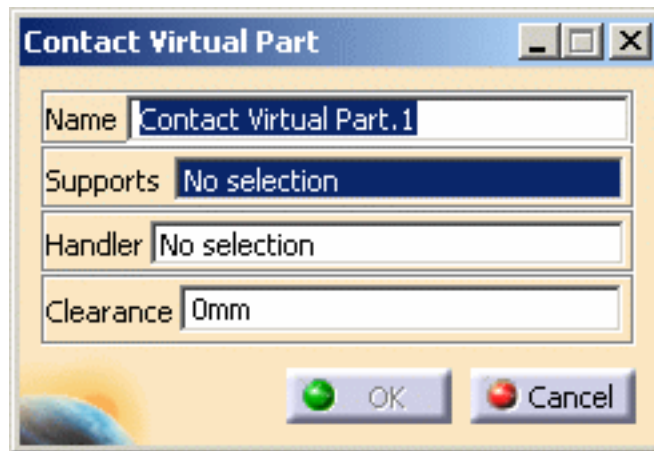

2. Select a face of the part as a geometry support.

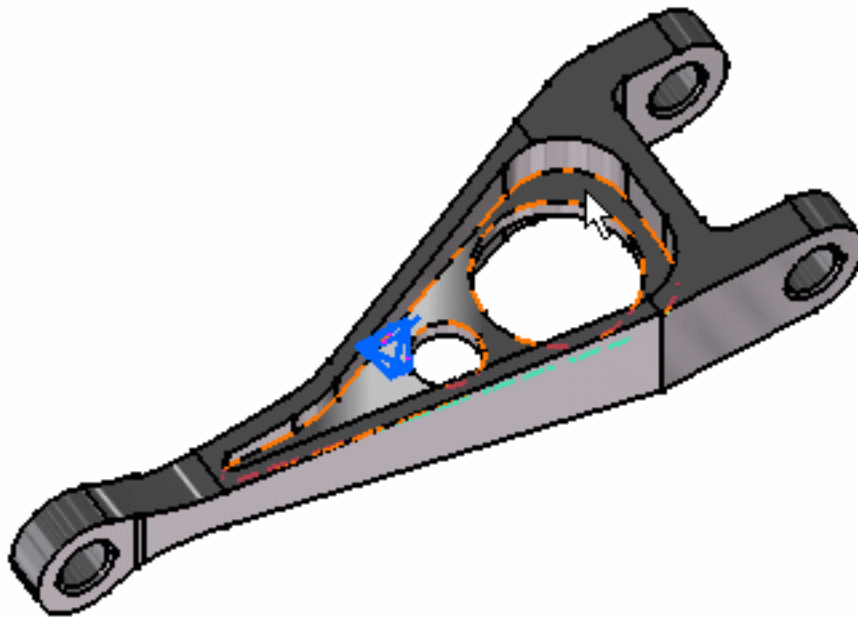

3. Position the cursor on the **Handler** field in the Contact Virtual Part dialog box and select a point for the handler point (the handler point symbol appears as your cursor passes over it).

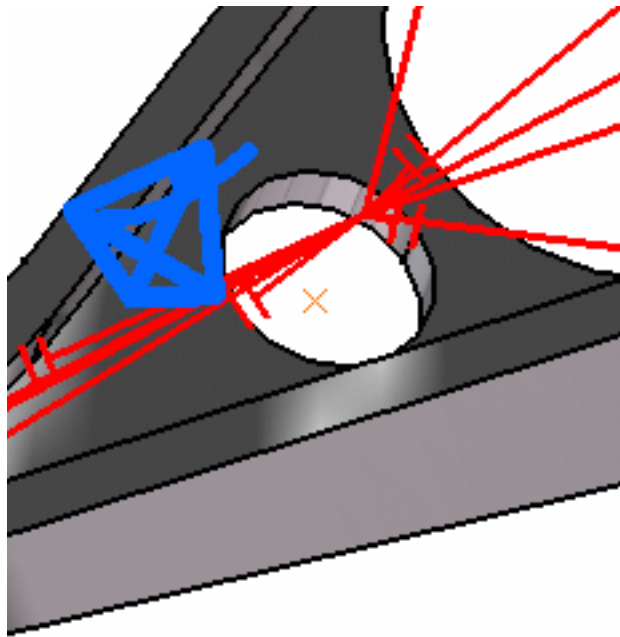

If you do not specifically select a point, the centroid (the point at which the lines meet) will be used as the handler point.

Optionally enter a clearance value in the **Clearance** field.

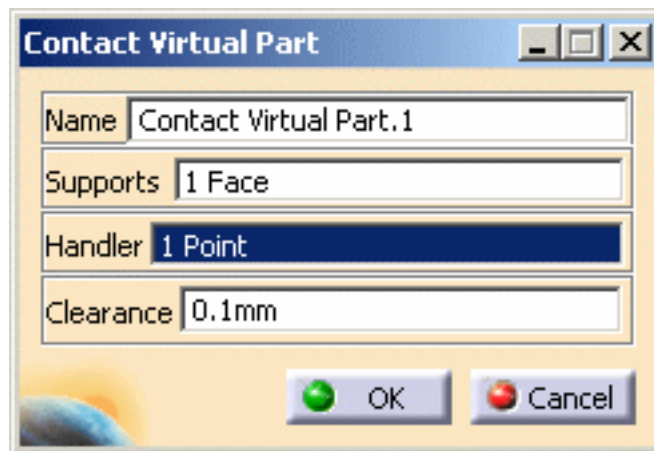

4. Click **OK** to create the Contact Virtual Part.

When several virtual parts share a same handler point, only one finite element node is generated.

The symbol appearing at the handler point represents the Contact Virtual Part.

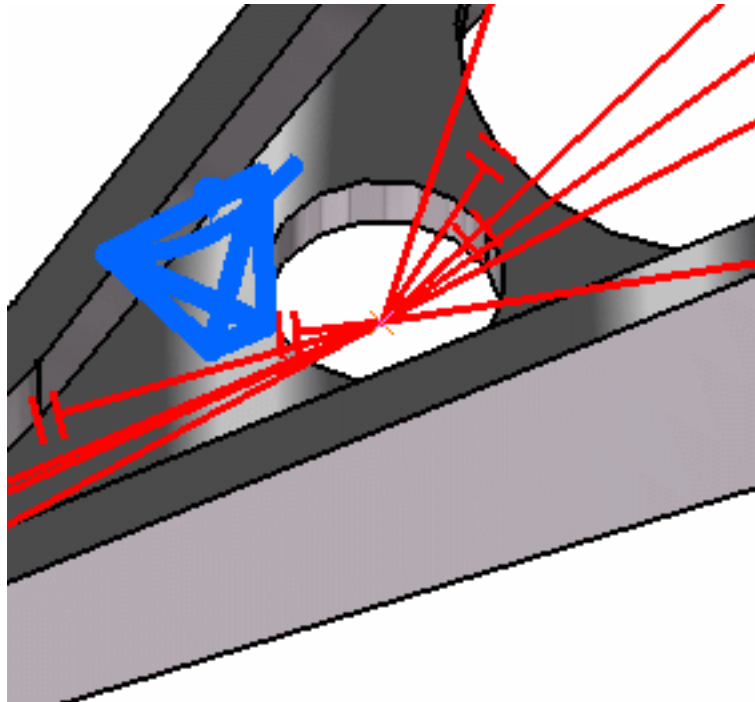

A Contact Virtual Mesh object appears in the specification tree under the active Nodes and Elements objects set.

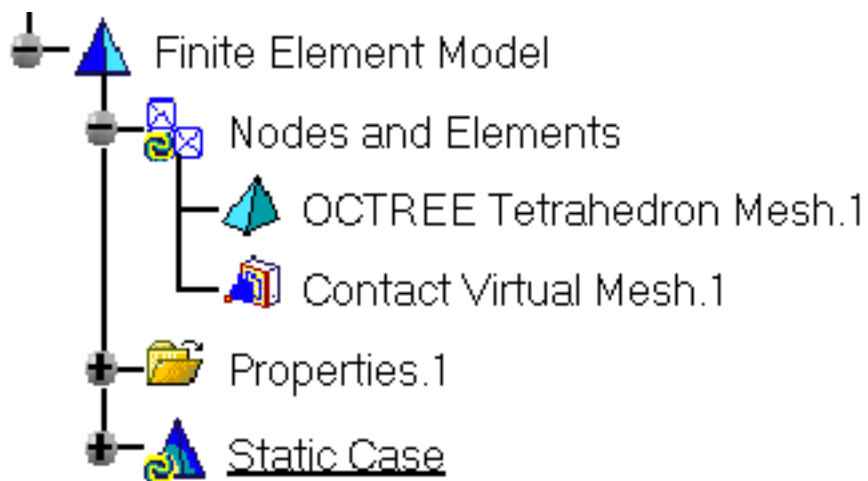

- You can select several geometry supports.
- The Contact Virtual Part will connect all support offset nodes to the handle point into a rigid body and transmit all actions via contact conditions between offset nodes and supports.



# Creating Rigid Spring Virtual Parts



This task shows how to create a Rigid Spring Virtual Part between a point and a geometry support.



A *Rigid Spring Virtual Part* is an elastic body connecting a specified point to a specified geometry, behaving as a six degree of freedom spring in series with a mass-less rigid body which will stiffly transmit actions (masses, restraints and loads) applied at the handle point, while stiffening the deformable body or bodies to which it is attached.

The Rigid Spring Virtual Part does not take into account the elastic deformability of the parts to which it is attached.

The program proceeds as follows:

- a node is created in coincidence with the specified handle point.
- a second node, offset from the first node, is created in a user-specified direction.
- the offset node is connected by a user-specified spring element to the handle node.
- all nodes of the specified geometry supports meshes are connected by rig-beam kinematical elements to the offset node.
- a set of rig-beam relations is generated between the offset node degree of freedom and the connected nodes degree of freedom.

The Rigid Virtual Part is built with Rigid Spider and Spring elements.

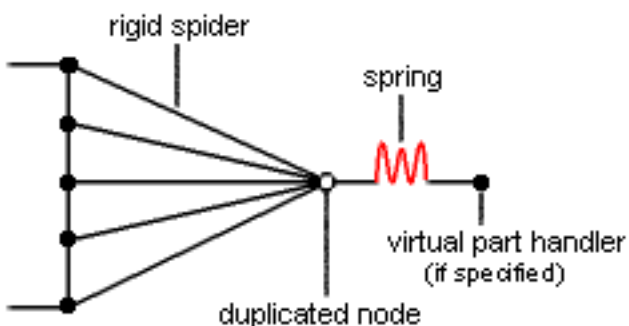

To know more about those elements, see [Rigid Spider](#) and [Spring](#) in the *Finite Element*

Reference Guide.



Rigid Spring Virtual Parts can be applied to the following types of Supports:

Mechanical Feature	Geometrical Feature				Analysis Feature
	Point or Vertex	Curve or Edge	Surface or Face	Volume or Part	



You can use the [sample28.CATAnalysis](#) document from the samples directory for this task: [Finite Element Model](#) containing a Static Analysis Case and computed corresponding [Static Solution](#). A **Part Design** point was created on the associated CATPart document.

**Before You Begin:**

Go to **View -> Render Style -> Customize View** and make sure the **Shading, Outlines** and **Materials** options are active in the Custom View Modes dialog box.



1. Click the **Rigid Spring Virtual Part** icon

The Rigid Spring Virtual Part dialog box appears.

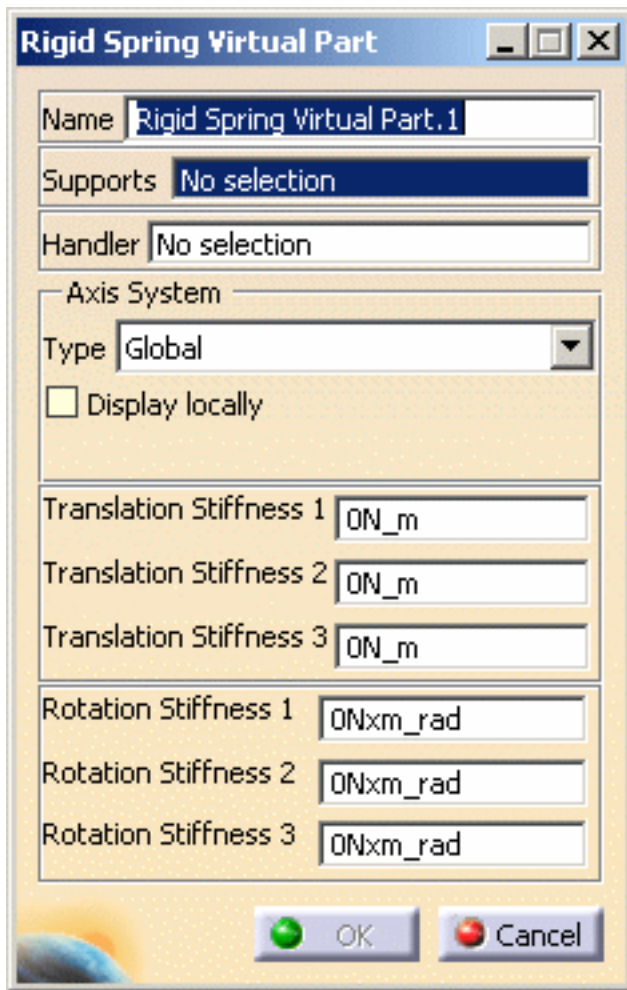

2. Select the cylindrical face of the hole as a geometry support.

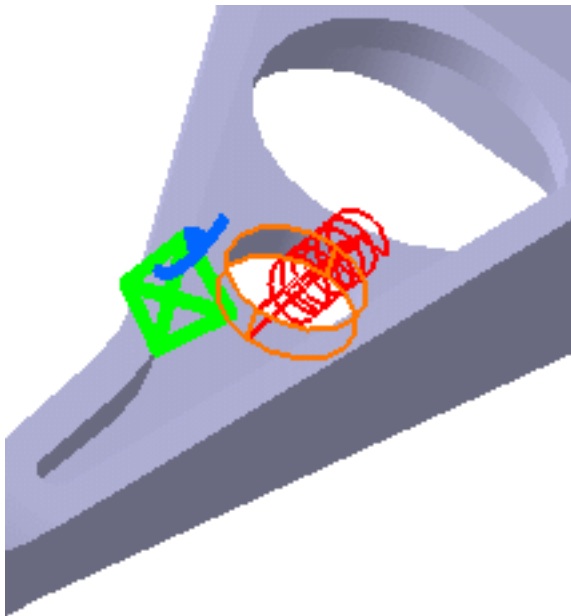

3. Position the cursor on the **Handler** field in the Rigid Spring Virtual Part dialog box and select a point for the handler point (the handler point symbol appears as your cursor

passes over it).

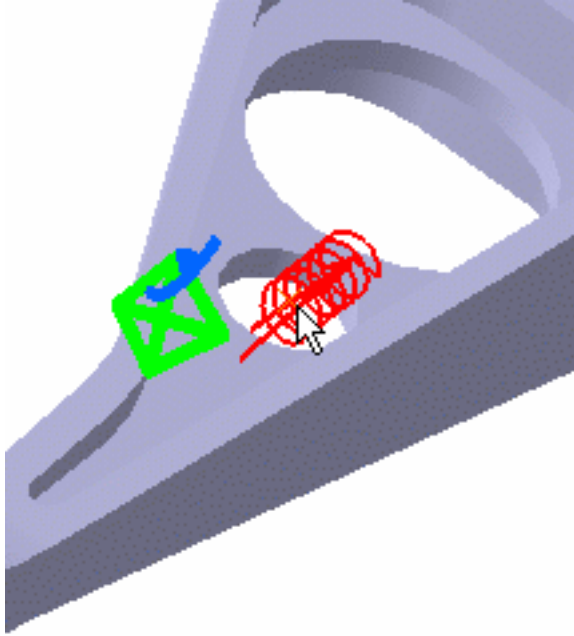

- If you do not specifically select a point, the centroid will be used as the handler point
- When several virtual parts share a same handler point, only one finite element node is generated.

The **Axis System Type** combo box allows you to choose between **Global** and **User-defined** Axis systems, for entering components of the resultant moment vector.

- **Global:** if you select the Global Axis system, the components of the resultant moment vector will be interpreted as relative to the fixed global rectangular coordinate system.
- **User-defined:** if you select a User-defined Axis system, the components of the resultant moment vector will be interpreted as relative to the specified rectangular coordinate system.

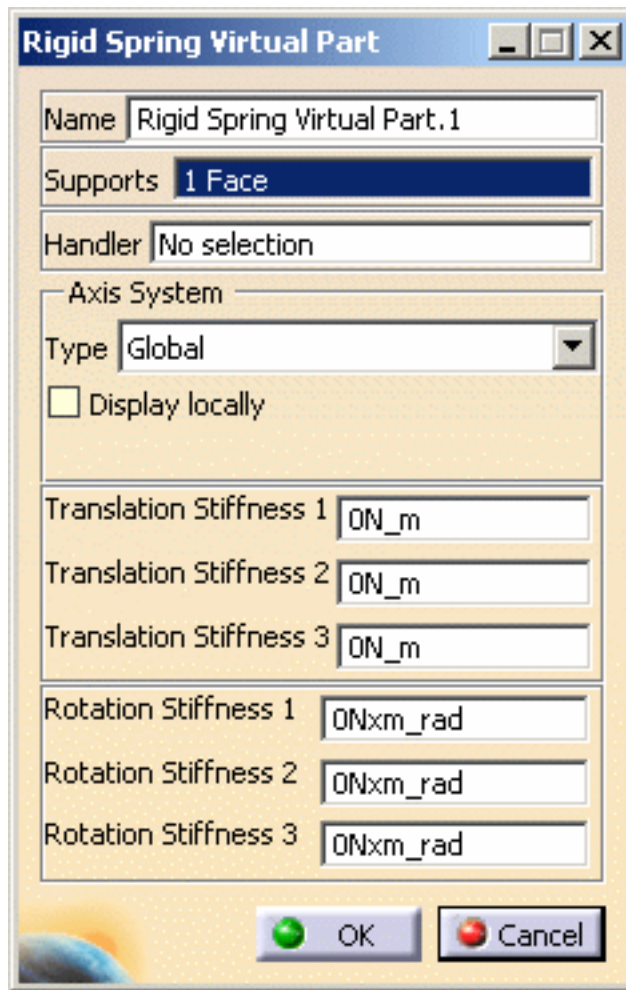

To select a User-defined Axis system, you must activate an existing Axis by clicking it in the specification tree. Its name will then be automatically displayed in the **Current Axis** field.

4. Set the Axis system.
5. Enter values for the six degree of freedom spring constants.
6. Click **OK** to create the Spring Rigid Virtual Part.



The symbol appearing at the handler point represents the Rigid Spring Virtual Part.

A **Rigid Spring Virtual Part Mesh.1** object appears in the specification tree under the active Nodes and Elements objects set.

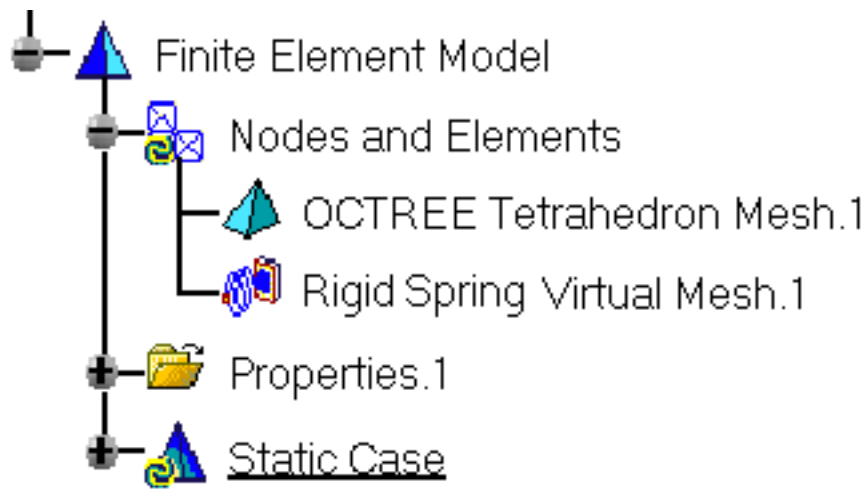

 You can select several geometry supports.

The Spring Rigid Virtual Part will connect all supports to the handler point and stiffly transmit all actions as a spring in series with a rigid body.



# Creating Smooth Spring Virtual Parts



This task shows how to create a Spring Smooth Virtual Part between a point and a geometry support.



A *Spring Smooth Virtual Part* is an elastic body connecting a specified point to a specified geometry, behaving as a 6-degree of freedom spring in series with a mass-less rigid body which will softly transmit actions (masses, restraints and loads) applied at the handle point, without stiffening the deformable body or bodies to which it is attached.

The Spring Smooth Virtual Part does approximately take into account the elastic deformability of the parts to which it is attached.

The program proceeds as follows:

- a node is created in coincidence with the specified handle point.
- a second node, offset from the first node, is created in a user-specified direction.
- the offset node is connected by a user-specified spring element to the handle node.
- all nodes of the specified geometry supports meshes are connected by a kinematical spider element to the offset node.
- a set of mean (**constr-n**) relations is generated between the offset node degree of freedom and the connected nodes degree of freedom.

The Spring Smooth Virtual Part is built with Smooth Spider and Spring elements.

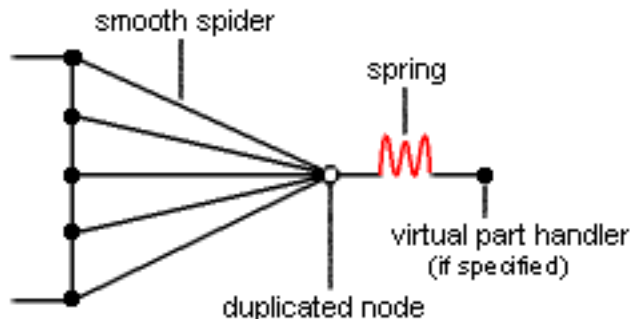

To know more about those elements, see [Smooth Spider](#) and [Spring](#) in the *Finite Element Reference Guide*.



Spring Smooth Virtual Parts can be applied to the following types of Supports:

Mechanical Feature	Geometrical Feature				Analysis Feature
	Point or Vertex	Curve or Edge	Surface or Face	Volume or Part	



You can use the [sample28.CATAnalysis](#) document from the samples directory for this task: [Finite Element Model](#) containing a Static Analysis Case and computed corresponding [Static Solution](#). A **Part Design** point was created on the associated CATPart document.

**Before You Begin:**

Go to **View -> Render Style -> Customize View** and make sure the **Shading**, **Outlines** and **Materials** options are active in the Custom View Modes dialog box.



1. Click the **Smooth Spring Virtual Part** icon .

The Smooth Spring Virtual Part dialog box appears.

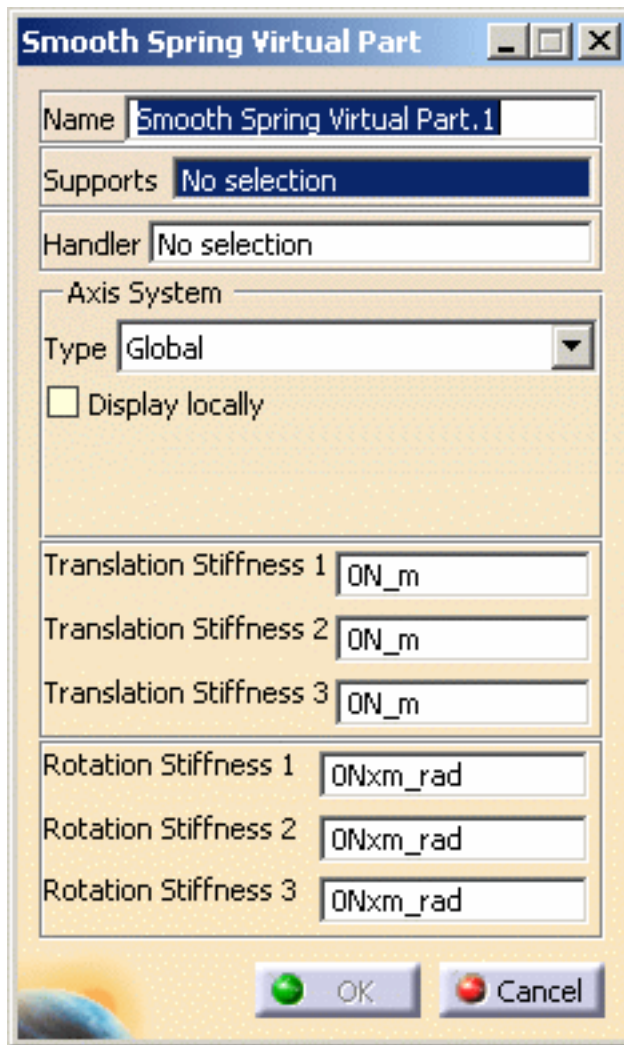

2. Select the cylindrical face of the hole as a geometry support.

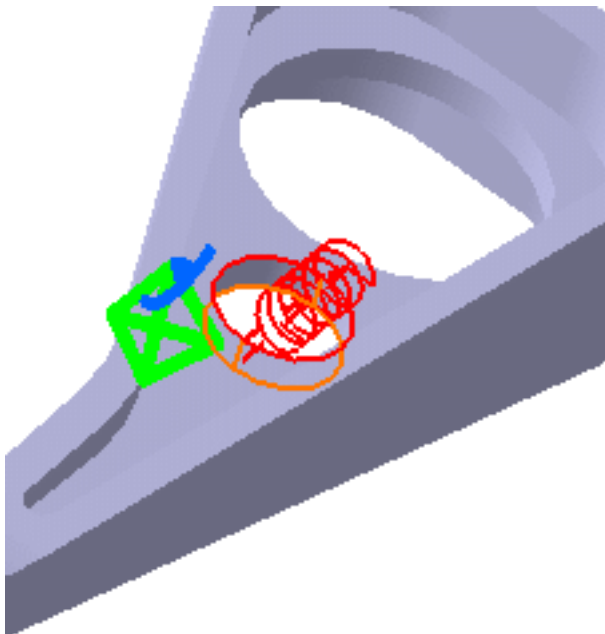

3. Position the cursor on the **Handler** field in the Smooth Spring Virtual Part dialog

box and select a point for the handler point (the handler point symbol appears as your cursor passes over it).

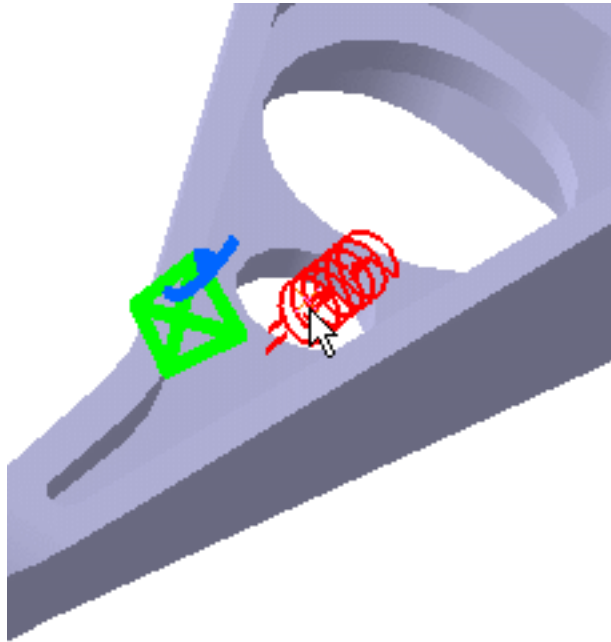

- If you do not specifically select a point, the centroid will be used as the handler point
- When several virtual parts share a same handler point, only one finite element node is generated.

The **Axis System Type** combo box allows you to choose between **Global** and **User-defined** Axis systems, for entering components of the resultant moment vector.

- **Global:** if you select the Global Axis system, the components of the resultant moment vector will be interpreted as relative to the fixed global rectangular coordinate system.
- **User-defined:** if you select a User-defined Axis system, the components of the resultant moment vector will be interpreted as relative to the specified rectangular coordinate system.

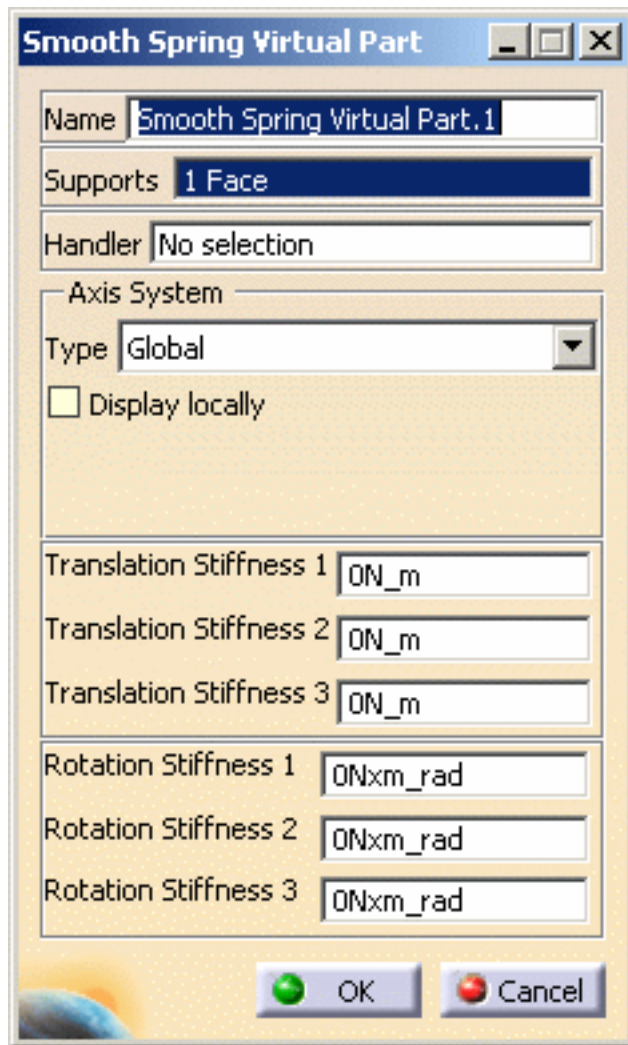

To select a User Axis system, you must activate an existing Axis by clicking it in the features tree. Its name will then be automatically displayed in the **Current Axis** field.

4. Set the Axis system.
5. Enter values for the 6-degree of freedom spring constants.
6. Click **OK** to create the Smooth Spring Virtual Part.

The symbol appearing at the handler point represents the Smooth Spring Virtual Part.

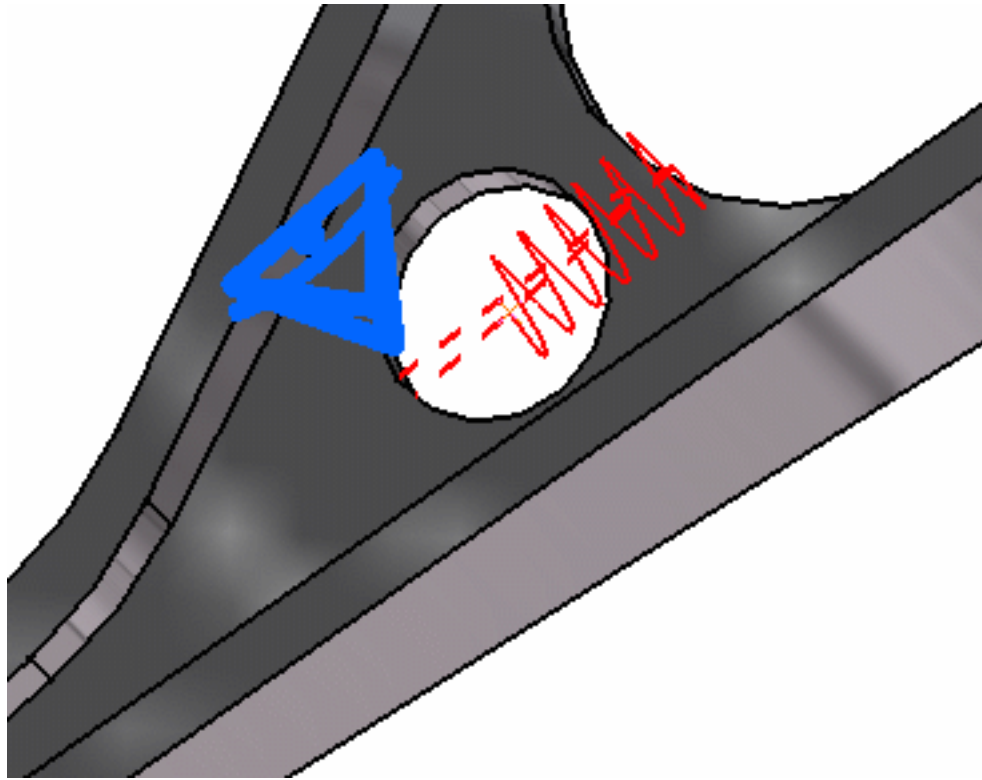

A Smooth Spring Virtual Mesh object appears in the specification tree under the active **Nodes and Elements** objects set.

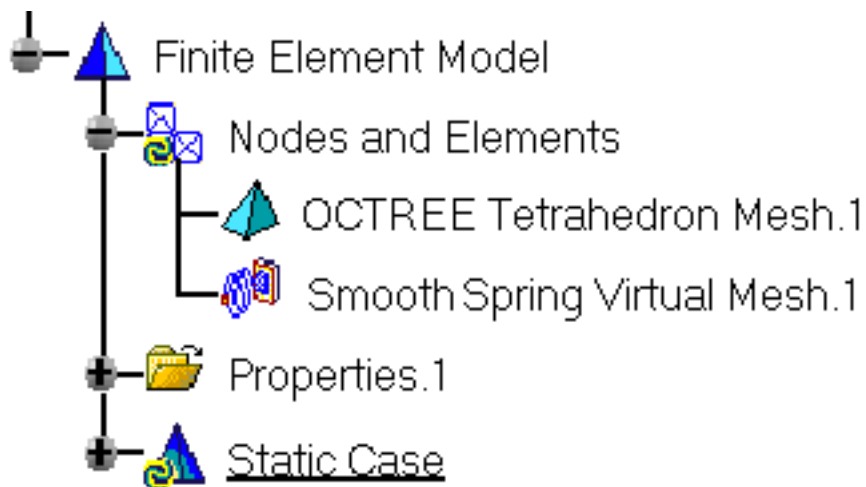

- You can select several geometry supports.
- The Smooth Spring Virtual Part will connect all supports to the handler point and softly transmit all actions as a spring in series with a rigid body.



# Creating Periodicity Conditions



This task shows you how to simulate periodicity conditions by linking together the degrees of freedom of two faces that undergo transformation. You will apply cyclic symmetry.



This functionality is only available if you installed the ELFINI Structural Analysis product.



*Periodicity conditions* enable you to perform an analysis on the solid section of a periodic part. This solid section should represent a cyclic period of the entire part as shown in two examples below.

Applying periodicity conditions is cost saving: you compute only a section of the part and get a result that is representative of the whole part.

Two types of periodicity conditions can be applied:

1. **Cyclic symmetry** of the geometry as well as both restraints and loads.  
The actual part results from  $n$  rotations applied to the modelled solid section where  $n = 2 \pi / \theta$  :  $\theta$  should be an integer.



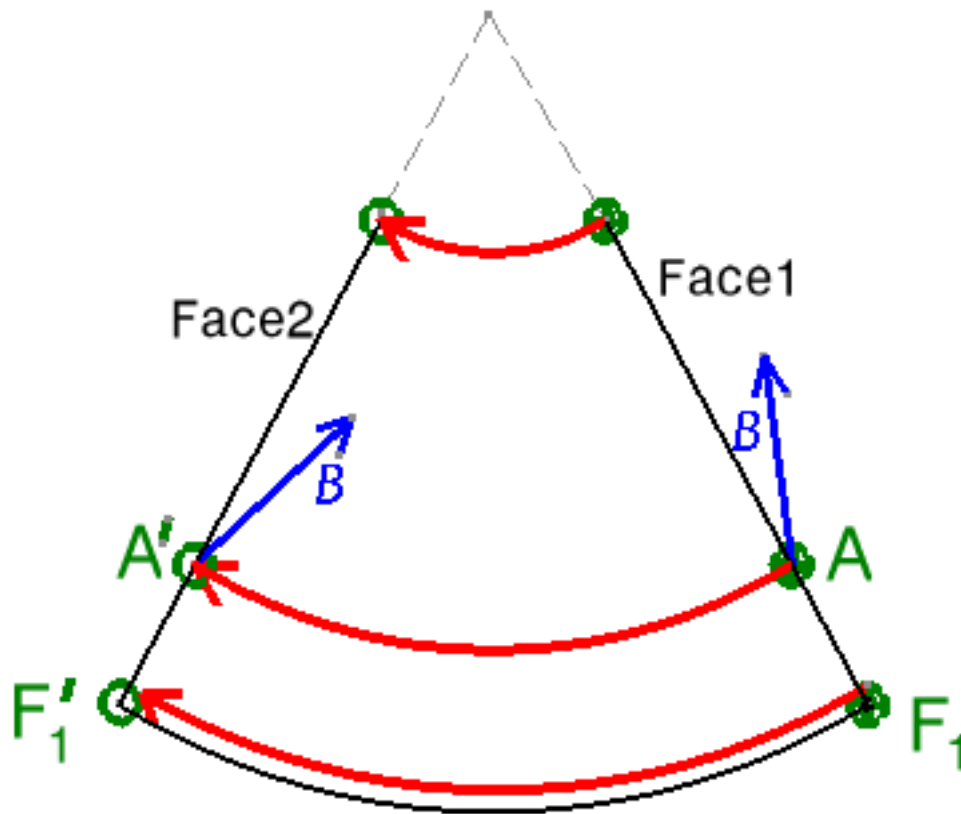

2. **Regular symmetry** of the sectioned geometry as well as both restraints and loads:

The section is geometrically regular, there is no discontinuity. The entire actual part results from an infinite number of translations (right and left) of the modeled section.

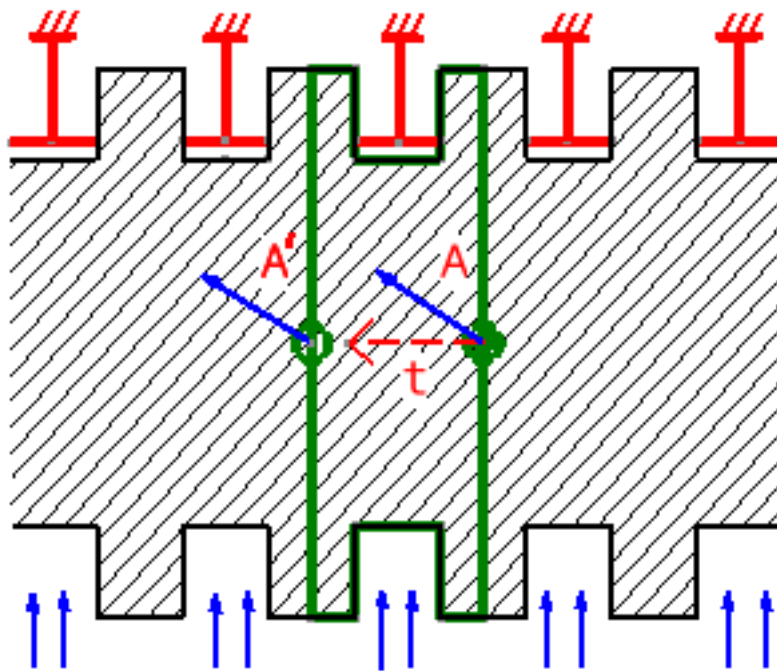

To know more about this element, see [Periodic Condition](#) and [Join Fasten](#) in the *Finite Element Reference Guide*.



To use periodicity conditions, you need to make sure the geometry as well as the created restraints and loads are periodic. The geometry also needs to be regular at the place the section is cut: discontinuity is not allowed.



Open the [sample44.CATAnalysis](#) document from the samples directory for this task.

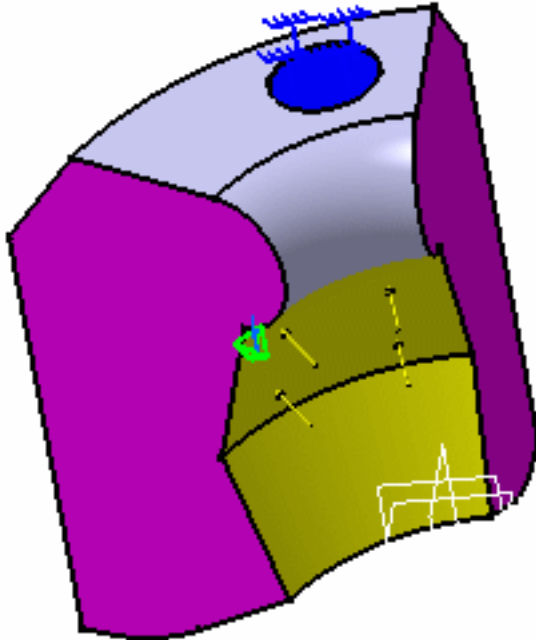

1. Click the **Periodicity Conditions** icon .

The Periodicity Conditions dialog box appears.

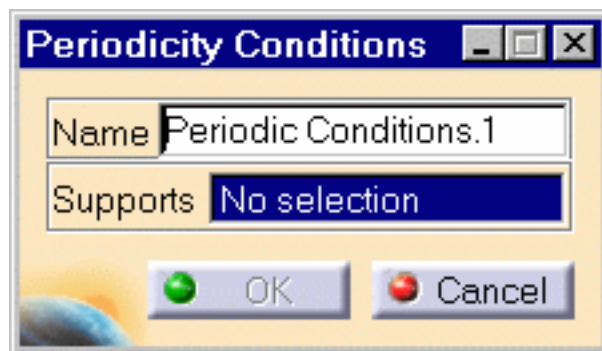

2. Select on the model both planes to be used for generating periodicity of the part section. In this particular case, select both pink faces.

The selected planes are high-lighted.

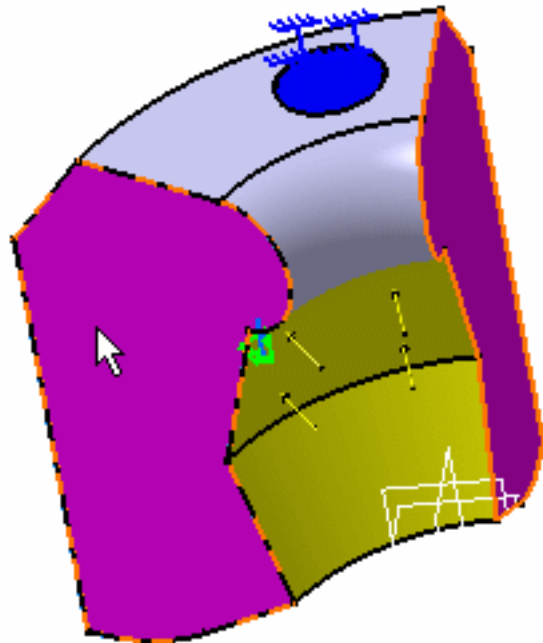

The Periodicity Conditions dialog box is updated.

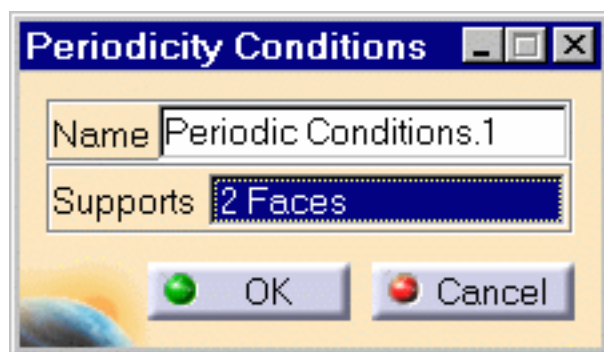

3. Click **OK** in the Periodicity Conditions dialog box.

The periodicity conditions are now created.

The specification tree is updated.

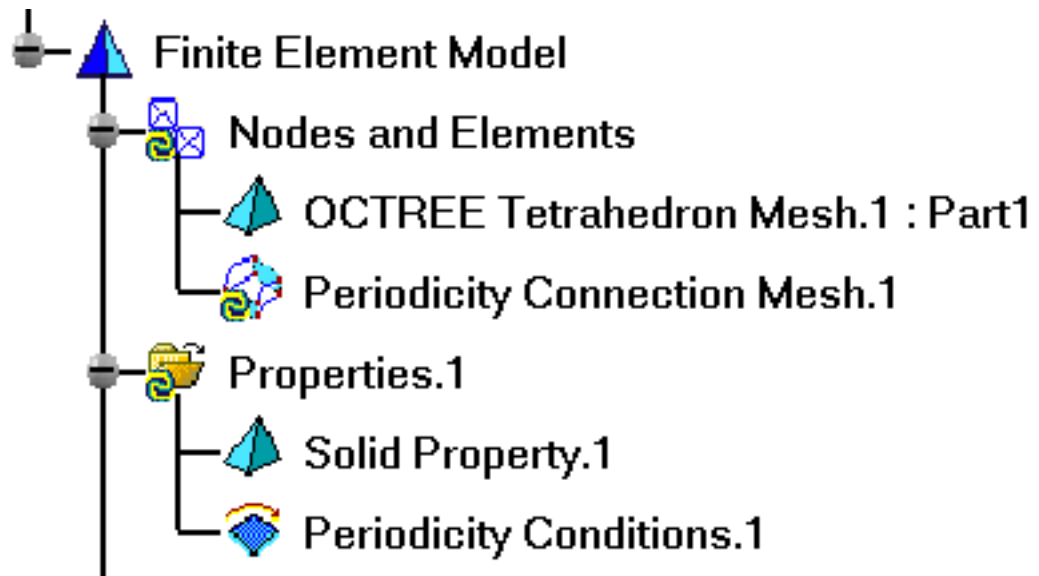

If you want to apply Periodicity Conditions via regular symmetry, open the [sample43.CATAnalysis](#) document from the samples directory.

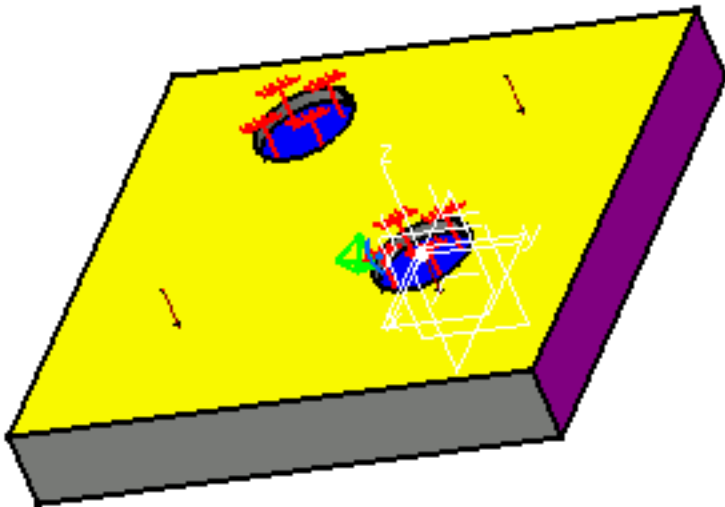

# Mass Equipment



## Create Distributed Mass Equipment

Generate a non-structural lumped mass distribution equivalent to a total mass concentrated at a given point.

**Create Mass Densities:** Generates non-structural mass densities of given intensity.



## Create Line Mass Densities

Generate a scalar line mass field of given uniform intensity on a curve geometry.



## Create Surface Mass Densities

Generate a scalar surface mass field of given uniform intensity on a surface geometry.



## Inertia on Virtual Part

Define inertia on virtual parts.



# Creating Distributed Masses



This task shows you how to create a Distributed Mass applied to a virtual part or to a geometry selection.



Distributed Masses are used to model purely inertial (non-structural) system characteristics such as additional equipment. They represent scalar point mass fields equivalent to a total mass concentrated at a given point, distributed on a virtual part or on a geometric selection.

The user specifies the total mass. This quantity remains constant independently of the geometry selection. The point where the total mass is concentrated is automatically defined as follows:

- For extended geometries, this point is the centroid of the geometry.
- For virtual parts, this point is the handler of the virtual part.

The given concentrated-mass system is processed by the program as follows:

- In the case of extended geometries, it is transformed into an equivalent lumped masses system distributed over the selected support.
- In the case of virtual parts connected to deformable bodies, it is transmitted as a lumped masses system collectively to the entire connected geometry.

Units are mass units (typically kg in SI).

Mass sets can be included in static cases: in this case, they are used for loadings based inertia effects.



Distributed Mass can be applied to the following types of Supports:

Geometrical Feature	Mechanical Feature	Analysis Feature			
		Free Groups	Geometrical Groups	Proximity Groups	Others
Point/Vertex Edge Face Homogeneous selection	▲	▲	▲	▲	Virtual Part



Open the [sample16.CATAnalysis](#) document from the samples directory.

## Before You Begin:

Go to **View -> Render Style -> Customize View** and make sure the **Shading, Outlines and Materials** options are active in the Custom View Modes dialog box.



1. Click the **Distributed Mass** icon .

The Distributed Mass dialog box is displayed.

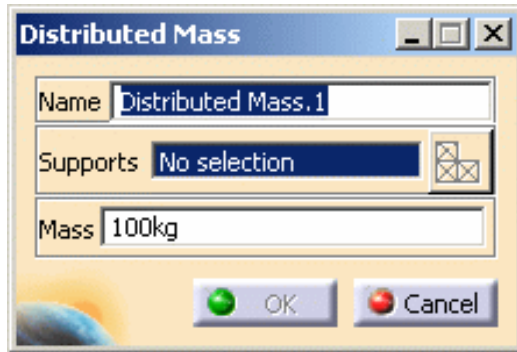

2. You can change the identifier of the Distributed Mass by editing the **Name** field.
3. Enter the value of the total **Mass** to define the mass magnitude.
4. Select the support (a vertex, an edge, a face or a virtual part) on which the concentrated mass is applied at the pre-defined point. Any selectable geometry is highlighted when you pass the cursor over it.

You can select several supports in sequence, to apply the Distributed Mass to all supports simultaneously.

Symbols representing the total mass equivalent to the Distributed Mass are displayed at the application point of the support to visualize the input lumped mass system.

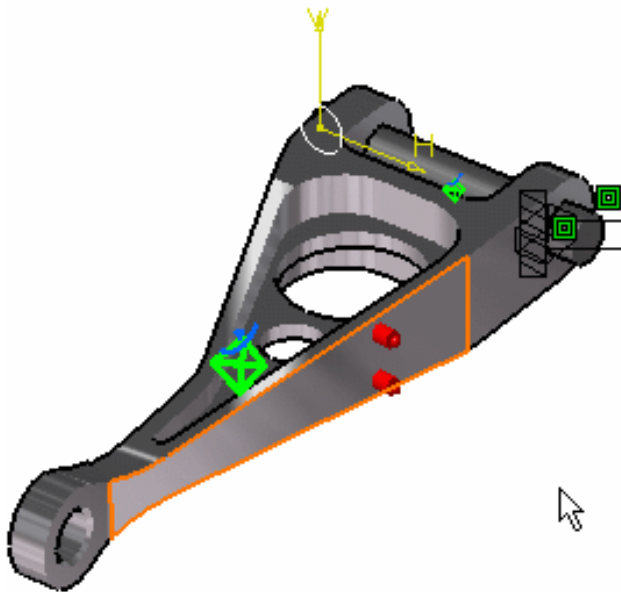

5. Click **OK** to create the Distributed Mass.

A **Distributed Mass.1** object appears in the features tree under the active Masses objects set.

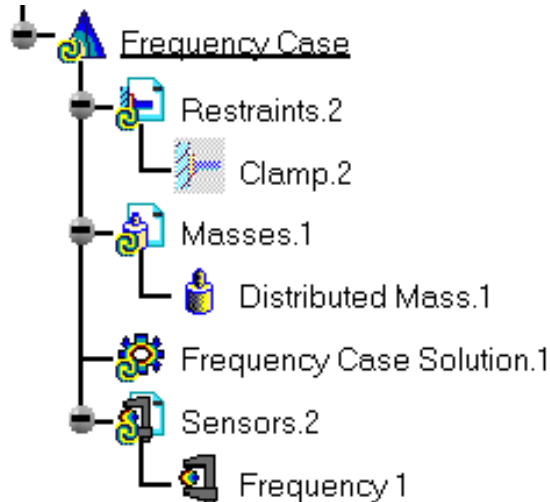



- You can either select the support and then set the Distributed Mass specifications, or set the Distributed Mass specifications and then select the support.
- If you select several geometric supports, you can create as many Distributed Masses as desired with the same dialog box. A series of Distributed Masses can therefore be created quickly. The point where the total mass is initially concentrated is automatically assumed to be the centroid of the system of individual supports centroids.
- Non-Structural Masses are not required for either Stress Analysis or Modal computations.
- If several Analysis Cases have been defined in the Finite Element Model, you must activate a Masses objects set in the features tree before creating a Distributed Mass object (only available if you have ELFINI Structural Analysis product installed).
- Distributed Mass objects can be edited by a double click on the corresponding object or icon in the features tree.



Make sure the computation is finished before starting any of the following operations.



#### Products Available in Analysis Workbench

-  The ELFINI Structural Analysis product offers the following additional features with a right mouse click (key 3) on a Distributed Mass object:
  - **Distributed mass visualization on mesh:** the translation of your Distributed Mass object specifications into solver specifications can be visualized symbolically at the impacted mesh entities, provided the mesh has been previously generated via a Compute action.
-  The ELFINI Structural Analysis product offers the following additional features with a right mouse click (key 3) on a Masses objects set:
  - **Generate Image:**  
Generates an image of the Local Update action (which translates all user-defined Masses specs into explicit solver commands on mesh entities), by generating symbols for the elementary masses imposed by the Masses objects set. The image can be edited to include part or all of the options available.  
Right-click (key 3) on a Masses objects set and select the **Generate Image** option. The Image Choice dialog box is displayed. You can select images by clicking them in the list.



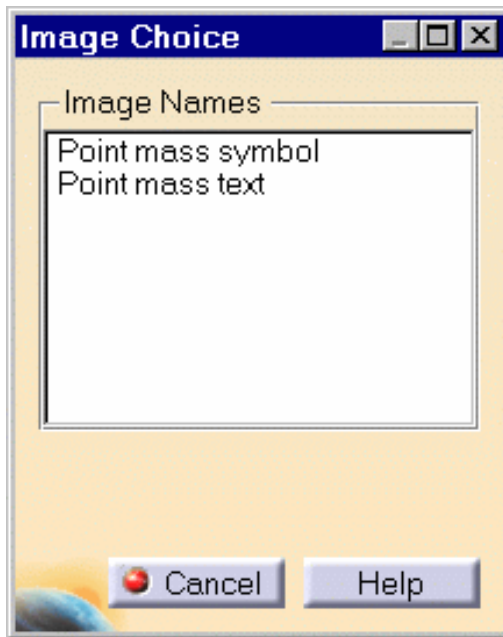



The resulting images sequence is obtained by superposition.

o **Report:**

The partial status and results of intermediate pre-processor computations are reported in HTML format. It represents a subset of the global Report capability and generates a partial report of the Masses objects set Computation.

Click the Basic Analysis Report icon  (on the condition you previously computed a solution using the Compute icon ).

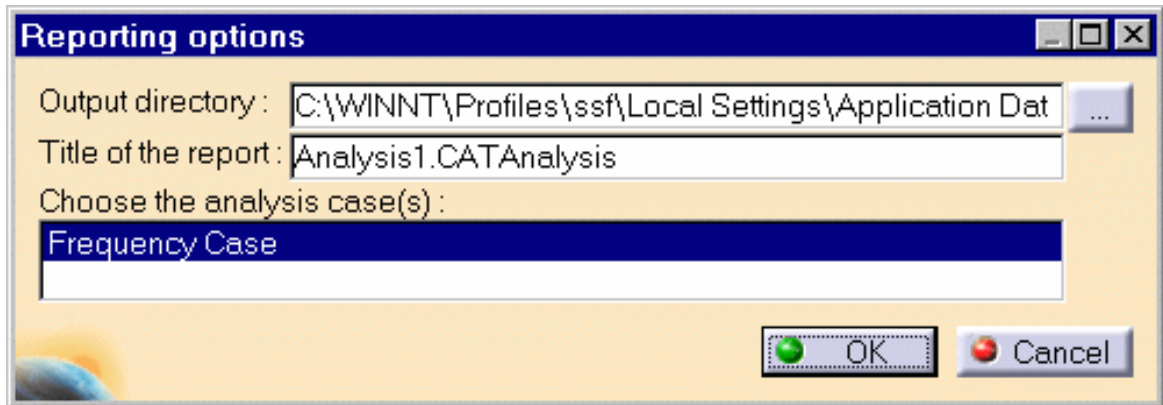

Click **OK** in the Reporting Options dialog box that appears (if you have more than one analysis case, ensure that the relevant analysis case is highlighted in the dialog box).

The .html partial report file is displayed.

# Masses.1

Name: MassSet.1

Structural: yes

Number of lines : 1275  
Number of coefficients : 1275  
Number of blocks : 1  
Maximum number of coefficients per bloc : 1275  
Total matrix size : 0.02 Mb

Additional mass : 1.000e+001 kg

Inertia center coordinates

Xg : 4.872e+001 mm  
Yg : 2.239e+001 mm  
Zg : -1.825e-001 mm

Inertia tensor at origine: gmm2

5.73944e+006	-9.09013e+006	182036.
-9.09013e+006	3.65027e+007	27104.
182036.	27104.	4.13234e+007



# Creating Line Mass Densities



This task shows you how to create a Line Mass Density applied to a virtual part or to a geometry selection.







*Line Mass Densities* used to model purely inertial (non-structural) system characteristics such as additional equipment. They represent scalar line mass density fields of given intensity, applied to curve geometries.

The user specifies the line mass density. This quantity remains constant independently of the geometry selection. Units are line mass density units (typically kg/m in SI).

Mass sets can be included in static cases: in this case, they are used for loadings based inertia effects.



Line Mass Density can be applied to the following support types:

Geometrical Feature	Mechanical Feature	Analysis Feature			
		Free Groups	Geometrical Groups	Proximity Groups	Others
Edge					



Open the [sample16.CATAnalysis](#) document from the samples directory.

## Before You Begin:

Go to **View -> Render Style -> Customize View** and make sure the **Shading, Outlines** and **Materials** options are active in the Custom View Modes dialog box.



1. Click the **Line Mass Density** icon .

The Line Mass Density dialog box is displayed.

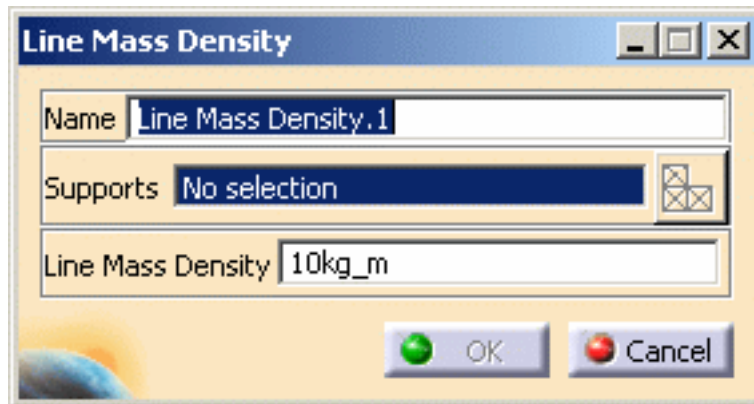

2. You can change the identifier of the Line Mass Density by editing the **Name** field.
3. Select the support (an edge, curve or line geometry) on which the line mass density is applied. Any selectable geometry is highlighted when you pass the cursor over it.

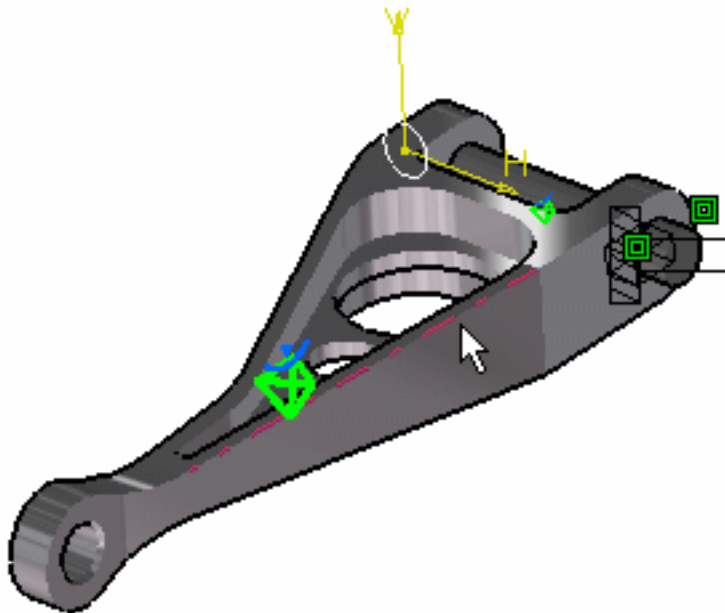

You can select several supports in sequence, to apply the Line Mass Density to all supports simultaneously.

4. Enter the desired **Mass Density** value to modify the mass density magnitude.

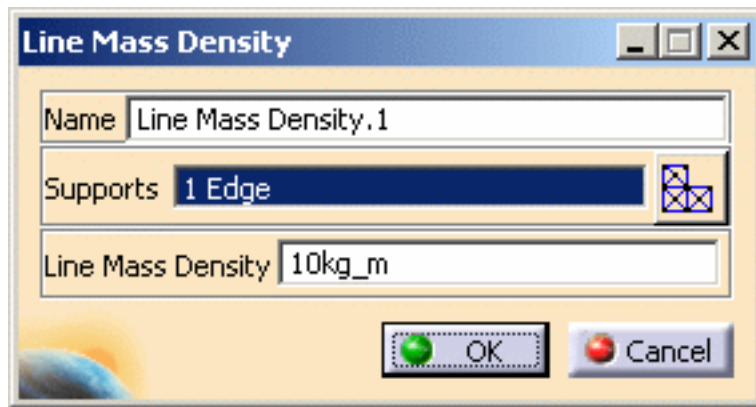

5. Click **OK** in the Line Mass Density dialog box.

A **Line Mass Density** object appears in the specification tree under the active **Masses** objects set.

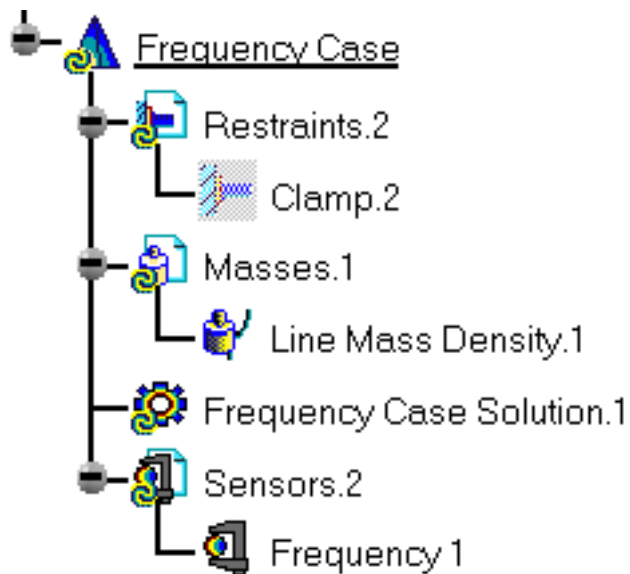

Symbols representing the Line Mass Density are displayed on the support geometry.

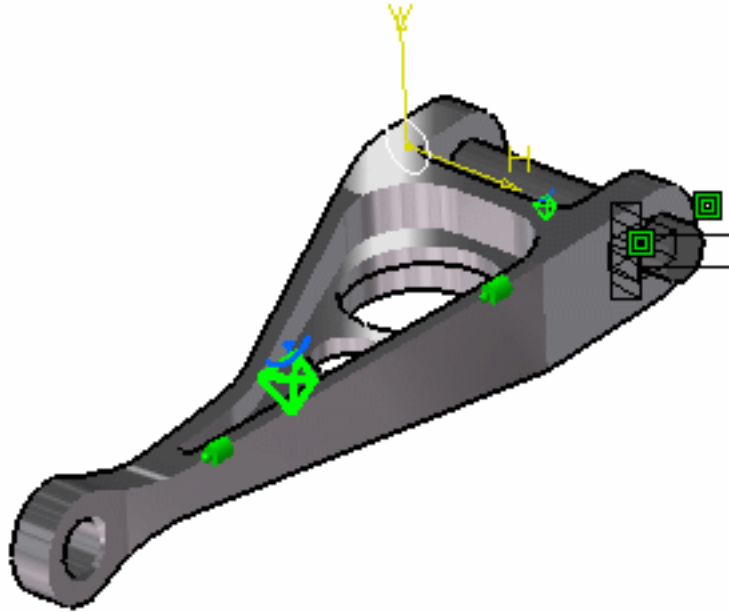

- You can either select the support and then set the Line Mass Density specifications, or set the Line Mass Density specifications and then select the support.
- If you select other supports, you can create as many Line Mass Densities as desired with the same dialog box. A series of Line Mass Densities can therefore be created quickly.
- Non-Structural Masses are not required for either Stress Analysis or Modal computations.
- If several Analysis Cases have been defined in the Finite Element Model, you must activate a Masses objects set in the features tree before creating a Line Mass Density object (only available if you have ELFINI Structural Analysis product installed).
- Line Mass Density objects can be edited by a double click on the corresponding object or icon in the specification tree.





Make sure the computation is finished before starting any of the following operations.



#### Products Available in Analysis Workbench

The ELFINI Structural Analysis product offers the following additional features with a right mouse click (key 3) on:

-  a Line Mass Density object:
  - **Line Mass Density Visualization on Mesh:** the translation of your Line Mass Density object specifications into solver specifications can be visualized symbolically at the impacted mesh entities, provided the mesh has been previously generated via a Compute action.
-  a Mass objects set:

- **Generate Image:** generates an image of the Local Update action (which translates all user-defined Masses specs into explicit solver commands on mesh entities), by generating symbols for the elementary masses imposed by the Masses objects set. The image can be edited to include part or all of the options available.
- **Report:** the partial status and results of intermediate pre-processor computations are reported in HTML format. It represents a subset of the global Report capability and generates a partial report of the Masses objects set Computation. For more details, please refer to [Creating Distributed Masses](#).



# Creating Surface Mass Densities



This task shows you how to create a Surface Mass Density applied to a virtual part or to a geometry selection.



*Surface Mass Densities* are used to model purely inertial (non-structural) system characteristics such as additional equipment. They represent scalar surface mass density fields of given intensity, applied to surface geometries.

The user specifies the surface mass density. This quantity remains constant independently of the geometry selection.

Units are surface mass density units (typically kg/m<sup>2</sup> in SI).

Mass sets can be included in static cases: in this case, they are used for loadings based inertia effects.



Surface Mass Density can be applied to the following types of Supports:

Geometrical Feature	Mechanical Feature	Analysis Feature			
		Free Groups	Geometrical Groups	Proximity Groups	Others
Face					



Open the [sample16.CATAnalysis](#) document from the samples directory.

## Before You Begin:

Go to **View -> Render Style -> Customize View** and make sure the **Shading**, **Outlines** and **Materials** options are active in the Custom View Modes dialog box.





1. Click the **Surface Mass Density** icon .

The Surface Mass Density dialog box is displayed.

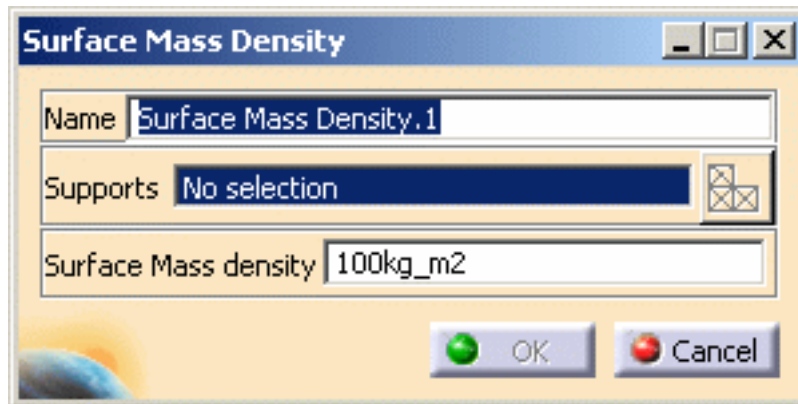

2. You can change the identifier of the Surface Mass Density by editing the **Name** field.
3. Enter the value of the surface mass density.
4. Select the support (a surface or face geometry) on which the surface mass density is applied. Any selectable geometry is highlighted when you pass the cursor over it.

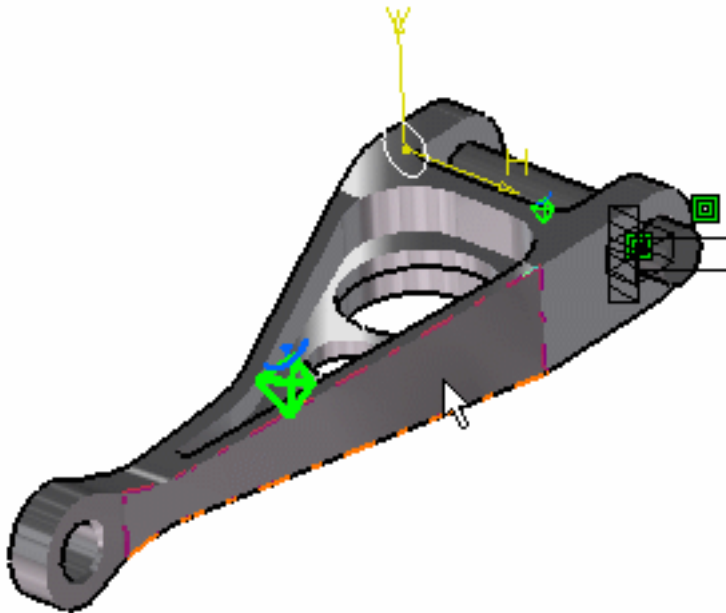

You can select several supports in sequence, to apply the Surface Mass Density to all supports simultaneously.

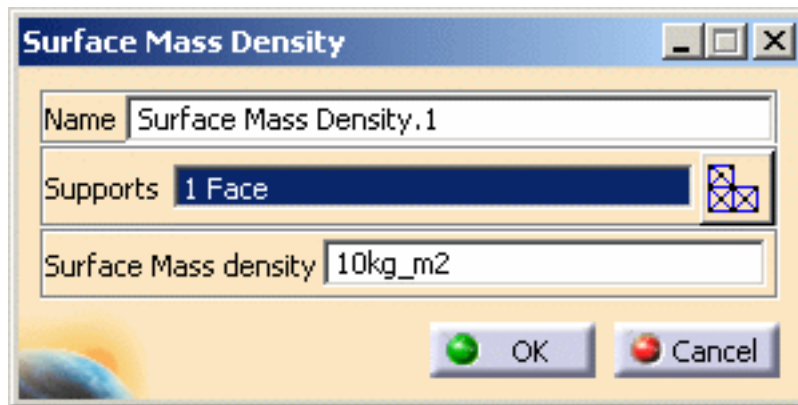

5. Click **OK** in the Surface Mass Density dialog box to create the Surface Mass Density.

A **Surface Mass Density** object appears in the specification tree under the active **Masses** objects set.

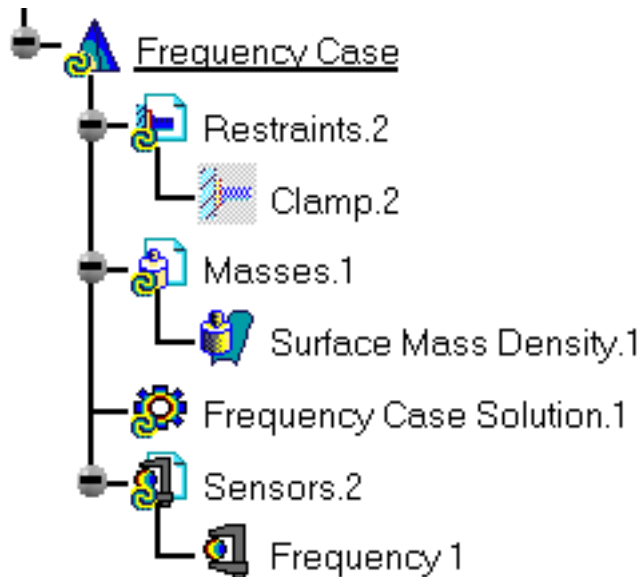

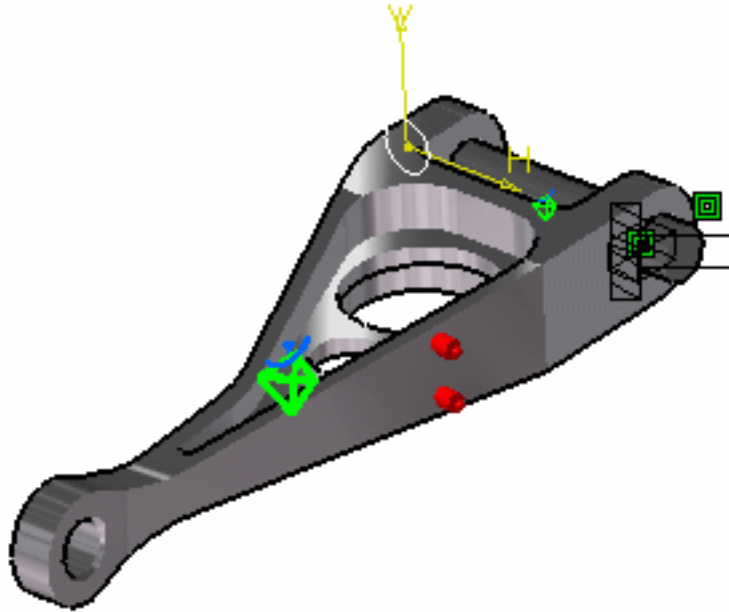

- You can either select the support and then set the Surface Mass Density specifications, or set the Surface Mass Density specifications and then select the support.
- If you select other supports, you can create as many Surface Mass Densities as desired with the same dialog box. A series of Surface Mass Densities can therefore be created quickly.
- Non-Structural Masses are not required for either Stress Analysis or Modal computations.
- If several Analysis Cases have been defined in the Finite Element Model, you must activate a Masses objects set in the features tree before creating a Surface Mass Density object (only available if you have ELFINI Structural Analysis product installed).
- Surface Mass Density objects can be edited by a double click on the corresponding object or icon in the features tree.





Make sure the computation is finished before starting any of the following operations.



### Products Available in Analysis Workbench

The ELFINI Structural Analysis product offers the following additional features with a right mouse click (key 3) on:

-  a Line Mass Density object:
  - **Surface Mass Density Visualization on Mesh:** the translation of your Surface Mass Density object specifications into solver specifications can be visualized symbolically at the impacted mesh entities, provided the mesh has been previously generated via a Compute action.
-  a Masses objects set:
  - **Generate Image:** generates an image of the Local Update action (which translates

all user-defined Masses specs into explicit solver commands on mesh entities), by generating symbols for the elementary masses imposed by the Masses objects set. The image can be edited to include part or all of the options available.

- **Report:** the partial status and results of intermediate pre-processor computations are reported in HTML format. It represents a subset of the global Report capability and generates a partial report of the Masses objects set Computation.

For more details, please refer to [Creating Distributed Masses](#).



# Inertia on Virtual Part



This task shows you how to define inertias on virtual part.

Inertia on Virtual Part lets you take into account a spatial distribution of mass on a virtual part.



Only available with the **ELFINI Structural Analysis (EST)** product.



Inertia can be applied to the following types of supports:

Geometrical Feature	Mechanical Feature	Analysis Feature			
		Free Groups	Geometrical Groups	Proximity Groups	Others
					Virtual Part



Open the [sample28\\_1.CATAnalysis](#) document from the samples directory.



1. Click the **Inertia on Virtual Part** icon .

The Inertia on Virtual Part dialog box is displayed.

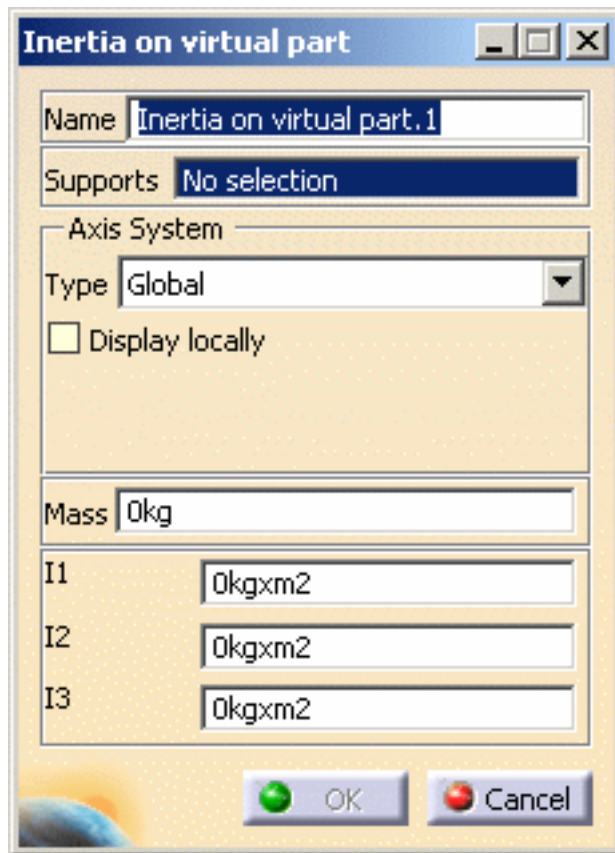

- **Name:** lets you change the name of the inertia.
- **Supports:** lets you select a support.
  - The only authorized support is the virtual part.
  - Multi-selection is not available.
- **Axis System Type:**
  - **Global:** if you select the Global Axis system, the directions will be interpreted as relative to the fixed global rectangular coordinate system of CATIA.
  - **User:** if you select a User Axis system, the directions will be relative to the specified **Current axis** system. Their interpretation will further depend on your Axis System Type choice.  
To select a User-defined Axis system, you must activate an existing Axis by clicking an axis created in the Part document. Its name will then be automatically displayed in the **Current axis** field.

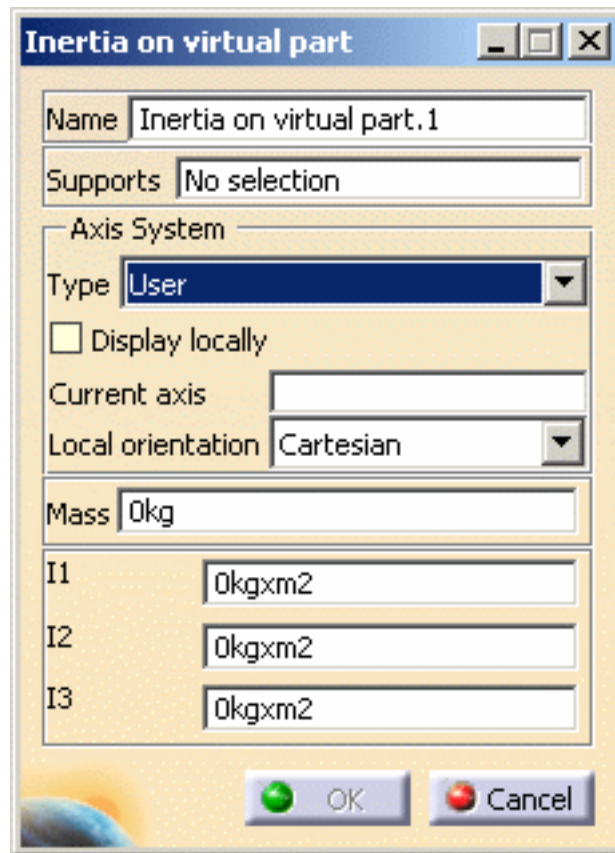

- **Current axis:** lets you select the desired axis system
- **Local orientation: (Cartesian)** the components are interpreted as relative to a fixed rectangular coordinate system aligned with the Cartesian coordinate directions of the User-defined Axis.
- **Display locally:** lets you display the axis system locally on the geometry.
- **Mass:** lets you specify a mass magnitude value (in **kg**).
- **I1:** lets you specify the mass inertia value in the X-direction.
- **I2:** lets you specify the mass inertia value in the Y-direction.
- **I3:** lets you specify the mass inertia value in the Z-direction.

**2.** Select a virtual part as Support.

In this particular case, select the **Rigid Virtual Part.1** either from the specification tree or directly on the geometry as shown bellow:

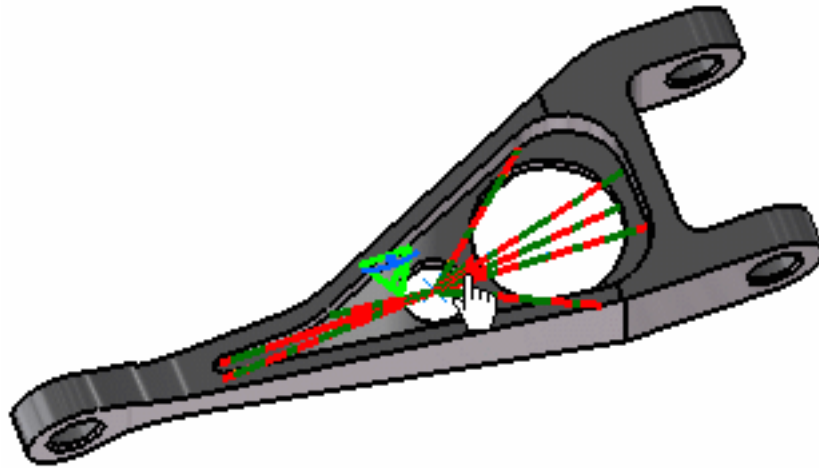

The Inertia on Virtual Part dialog box is updated.

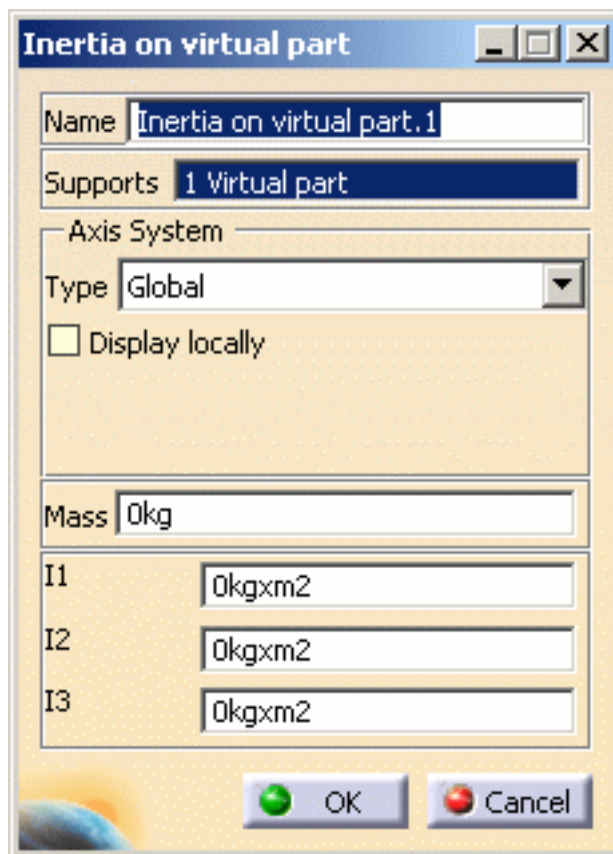

3. Enter a **Mass** value to define the mass magnitude.

In this particular example, enter 5kg as **Mass** value.



4. Modify the mass inertia components.
5. Click **OK** in the Inertia on Virtual Part dialog box.

An **Inertia on Virtual Part.1** object appears in the specification tree under the **Masses.1** set.

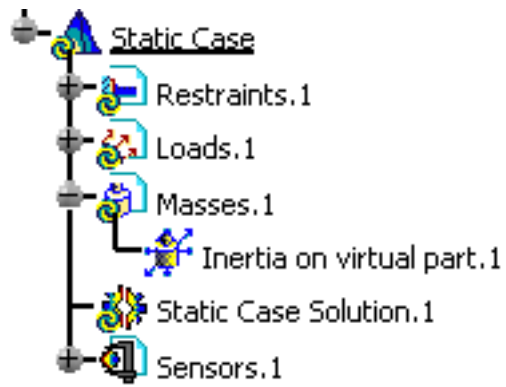

# Restraints



## Create Clamps

Fix all degrees of freedom on a geometry selection

## Technological Restraints



## Create Surface Sliders

Generate surface constraint joins, which allow points of a surface to slide along a coinciding rigid surface (fixes the translation degree of freedom for a surface in the direction of the local normal)



## Create Ball Joints

Generate spherical joints (balls), which allow a rigid body to rotate about a given point (fixes all translation degrees of freedom of a point)



## Create Sliders

Generate prismatic joints (sliders), which allow a rigid body to translate along a given axis (fixes all degrees of freedom of a point, except for one translation)



## Create Pivots

Generate conical joints (hinges), which allow a rigid body to rotate around a given axis (fixes all degrees of freedom of a point, except for one rotation)



## Create Sliding Pivots

Generate cylindrical joints (actuators) which allow a rigid body to translate about and rotate around a given axis (fixes all degrees of freedom of a point, except for one translation and one rotation)

## Generic Restraints



## Create Advanced Restraints

Fix any combination of degrees of freedom on a geometry selection



## Create Iso-static Restraints

Generate statically determinate supports on a part

# Creating Clamps



This task shows how to create a Clamp on a geometry.



*Clamps* are restraints applied to surface or curve geometries, for which all points are to be blocked in the subsequent analysis.

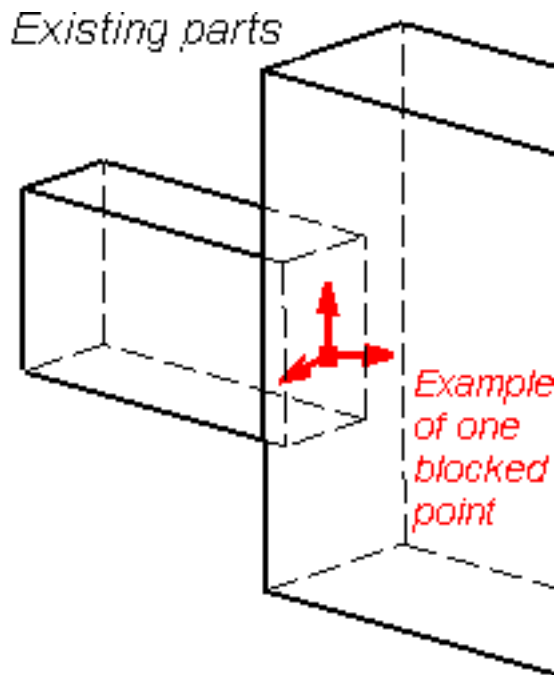

**→** means that there is no translation degree of freedom left in that direction.

Clamp objects belong to Restraint objects sets.

Make sure you fixed all the global degrees of freedom of your assembly, otherwise a global singularity will be detected at the time of the Static Computation (such a model is unsolvable). To allow you to easily correct the model (Static Analysis Cases only), the singular displacement of the assembly will be simulated and visualized after computation.



Clamps can be applied to the following types of supports:

Geometrical Feature	Mechanical Feature	Analysis Feature			
		Free Groups	Geometrical Groups	Proximity Groups	Others
Point/Vertex Edge Face					Virtual Part



Open the [sample02.CATAnalysis](#) document from the samples directory for this task: a [Finite Element Model](#) containing a Static or Frequency Analysis Case.

### Before You Begin:

Go to **View -> Render Style -> Customize View** and make sure the **Shading**, **Outlines** and **Materials** options are active in the Custom View Modes dialog box.



1. Click the **Clamp** icon .

The Clamp dialog box appears.

2. You can change the identifier of the Clamp by editing the **Name** field.

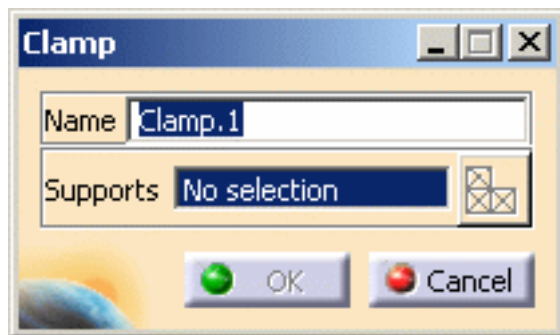

3. Select the geometry support (a surface, an edge or a virtual part). Any selectable geometry is highlighted when you pass the cursor over it.



You can select several supports in sequence, to apply the Clamp to all supports simultaneously.

Symbols representing a fixed translation in all directions of the selected geometry are visualized.

4. Click **OK** in the Clamp dialog box to create the Clamp.

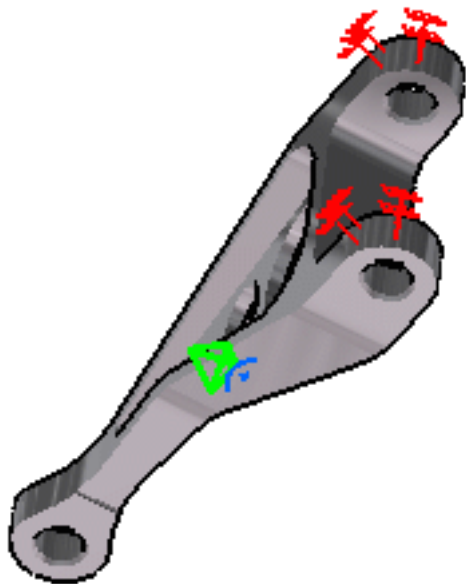

A **Clamp** object appears in the features tree under the active **Restraints** objects

set.

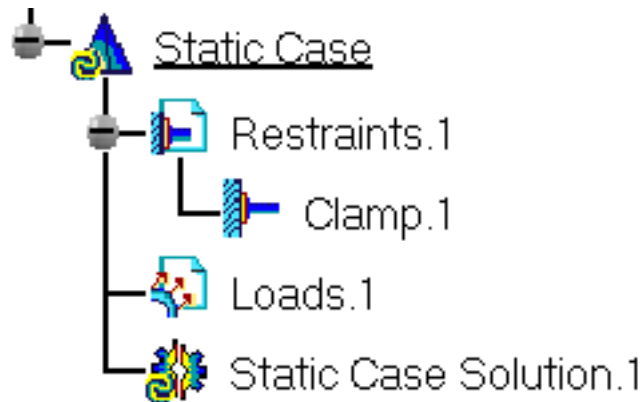

- You can either select the support and then set the Clamp specifications, or set the Clamp specifications and then select the support.
- If several Analysis Cases have been defined in the Finite Element Model, you must activate a Restraints objects set in the features tree before creating a Clamp object.
- Restraints are required for Stress Analysis computations. They are optional for Modal Analysis computations (if not created, the program will compute vibration modes for the free, unrestrained part).
- Clamp objects can be edited by a double click on the corresponding object or icon in the specification tree.



Make sure the computation is finished before starting any operation.



### Products Available in Analysis Workbench

The **ELFINI Structural Analysis** product offers the following additional features with a right mouse click (key 3) on a **Clamp** object:

- **Restraint visualization on mesh:** the translation of your Clamp object specifications into solver specifications can be visualized symbolically at the impacted mesh nodes, provided the mesh has been previously generated via a Compute action.

Right-click your clamp object and select the **Restraint visualization on mesh** option.

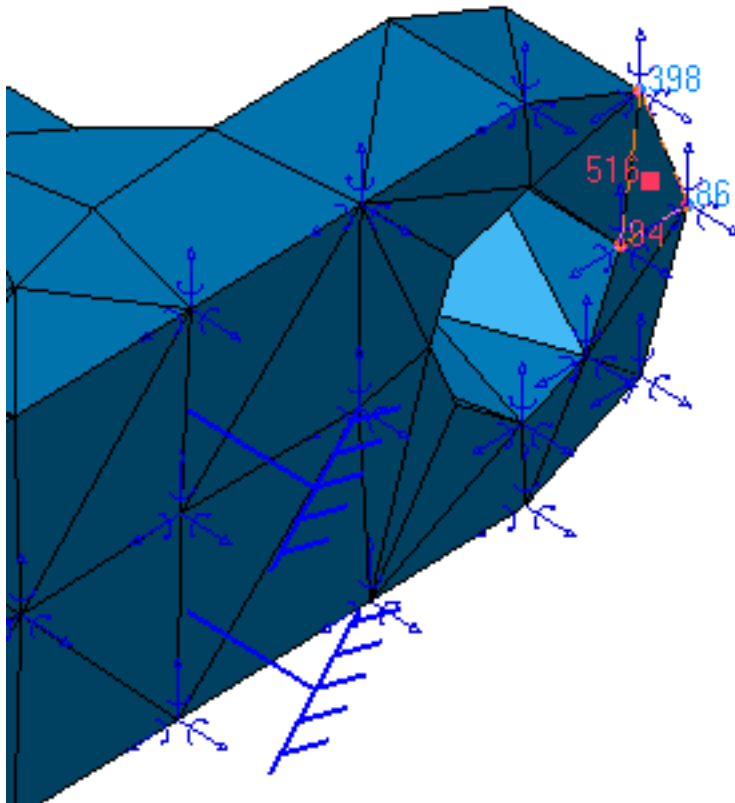

- **Generate Image:** generates an image of the computed Restraint objects (along with translating all user-defined Restraints specifications into explicit solver commands on mesh entities), by generating symbols for the nodal restraints imposed by the Restraints objects set. The image can be edited to include part or all of the options available.

Right-click on a Restraints objects set and select the Generate image option. The Image Choice dialog box is displayed. You can select images by clicking them in the list.

The resulting images sequence is obtained by superposition.

- **Report:** the partial status and results of intermediate pre-processor computations are reported in HTML format. It represents a subset of the global Report capability and generates a partial report of the Restraints objects set Computation.

Click the Basic Analysis Report icon  on the bottom toolbar.

The .html partial report file is displayed.



# Creating Surface Sliders



This task shows how to create a Surface Slider on a surface.



*Surface Sliders* are surface constraint joins, which allow points of a surface to slide along a coinciding rigid surface.

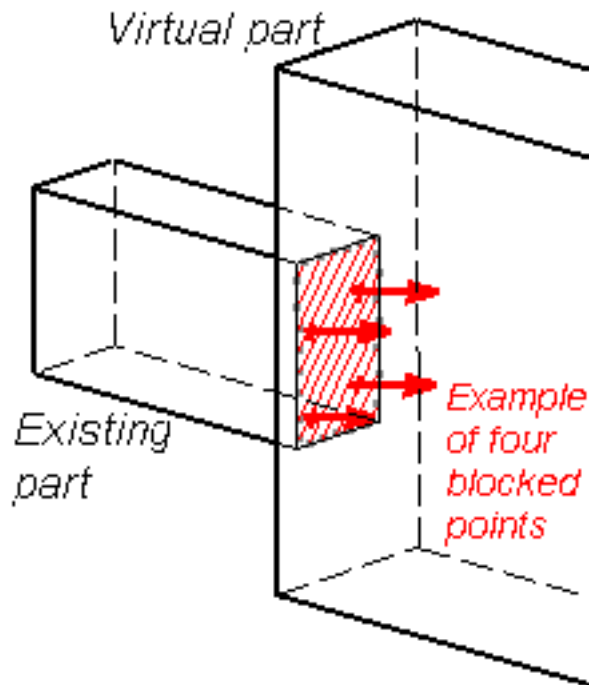

**→ means that there is no translation degree of freedom left in that direction.**

Surface Sliders are applied to surface geometries. Surface Slider objects belong to Restraint objects sets.

Make sure you fixed all the global degrees of freedom of your assembly, otherwise a global singularity will be detected at the time of the Static Computation (such a model is unsolvable). To allow you to easily correct the model (Static Analysis Cases only), the singular displacement of the assembly will be simulated and visualized after computation.

At each point of the deformable surface, the program automatically generates a constraint which fixes the translation degree of freedom in the direction normal to the surface at that point.





Surface Slider can be applied to the following types of supports:

Geometrical Feature	Mechanical Feature	Analysis Feature			
		Free Groups	Geometrical Groups	Proximity Groups	Others
Face					



Open the [sample15.CATAnalysis](#) document from the samples directory for this task: a [Finite Element Model](#) containing a Static or Frequency Analysis Case and computed corresponding [Solution](#).

**Before You Begin:**

Go to **View -> Render Style -> Customize View** and make sure the **Shading**, **Outlines** and **Materials** options are active in the Custom View Modes dialog box.



1. Click the **Surface Slider** icon .

The Surface Slider dialog box appears.



2. You can change the identifier of the Surface Slider by editing the **Name** field, if needed.
3. Select a geometry support (a face).

You can select several supports in sequence, to apply the Surface Slider simultaneously to all. Symbols representing the Surface Slider are displayed on the support.

4. Click **OK** in the Surface Slider dialog box to create the Surface Slider.

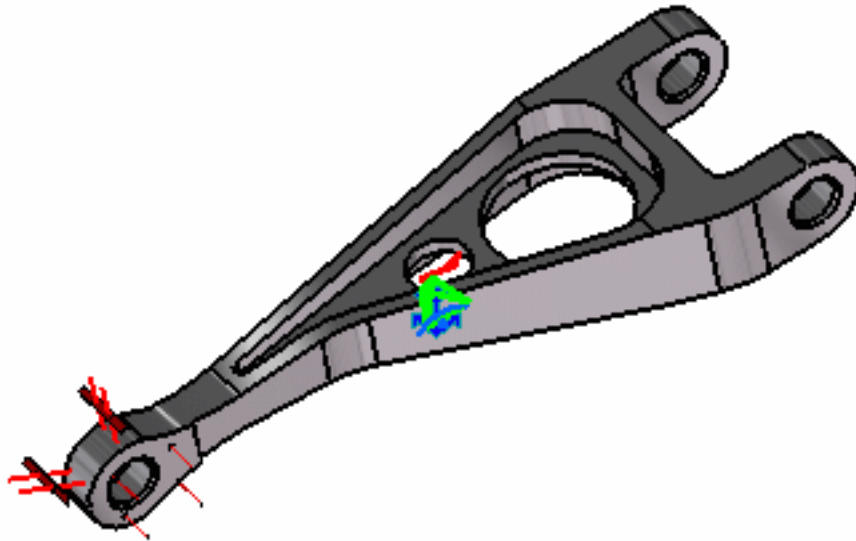

A **Surface Slider** object appears in the specification tree under the active **Restraints** objects set.

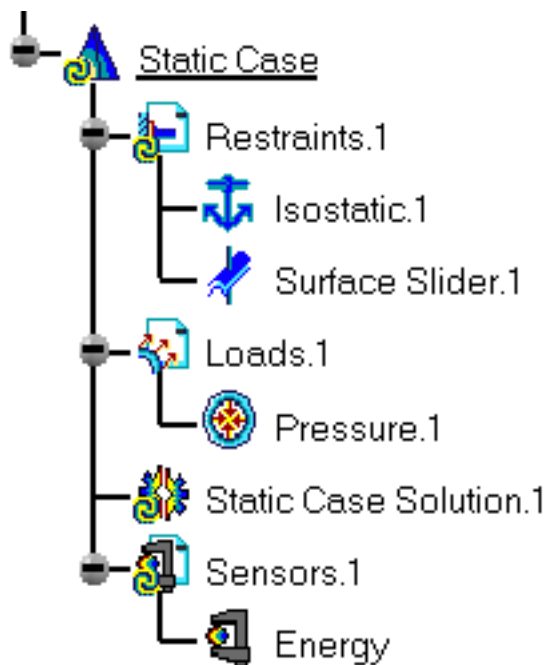



- You can either select the geometry support and then set the Surface Slider specifications, or set the Surface Slider specifications and then select the geometry support.
- If several Analysis Cases have been defined in the Finite Element Model, you must activate a Restraints objects set by clicking it in the features tree before creating a Surface Slider object.
- Restraints are required for Stress Analysis computations. They are optional for Modal Analysis computations (if not created, the program will compute vibration modes for the free, unrestrained part).
- Surface Slider objects can be edited by a double click on the corresponding object or icon in the features tree.





Make sure the computation is finished before starting any of the following operations.



### Products Available in Analysis Workbench

The **ELFINI Structural Analysis** product offers the following additional features with a right mouse click (key 3):

-  on a **Surface Slider** object:
  - **Restraint visualization on mesh:** the translation of your Surface Slider object specifications into solver specifications can be visualized symbolically at the impacted mesh nodes, provided the mesh has been previously generated via a Compute action.
-  on a **Restraints objects** set:
  - **Generate Image:** generates an image of the computed Restraint objects (along with translating all user-defined Restraints specs into explicit solver commands on mesh entities), by generating symbols for the nodal restraints imposed by the Restraints objects set. The image can be edited to include part or all of the options available.
  - **Report:** the partial status and results of intermediate pre-processor computations are reported in HTML format. It represents a subset of the global Report capability and generates a partial report of the Restraints objects set Computation.

For more details, please refer to [Creating Clamps](#).



# Creating Ball Joins



This task shows how to create a Ball Join on a virtual part.



*Ball Joins* are **spherical joint** restraints applied to handle points of virtual parts, which result in constraining the point to rotate around a coinciding fixed point. They can be viewed as particular cases of general spherical joints, which allow a relative rotation between two points (in the Ball Join case, one of the two points is fixed).

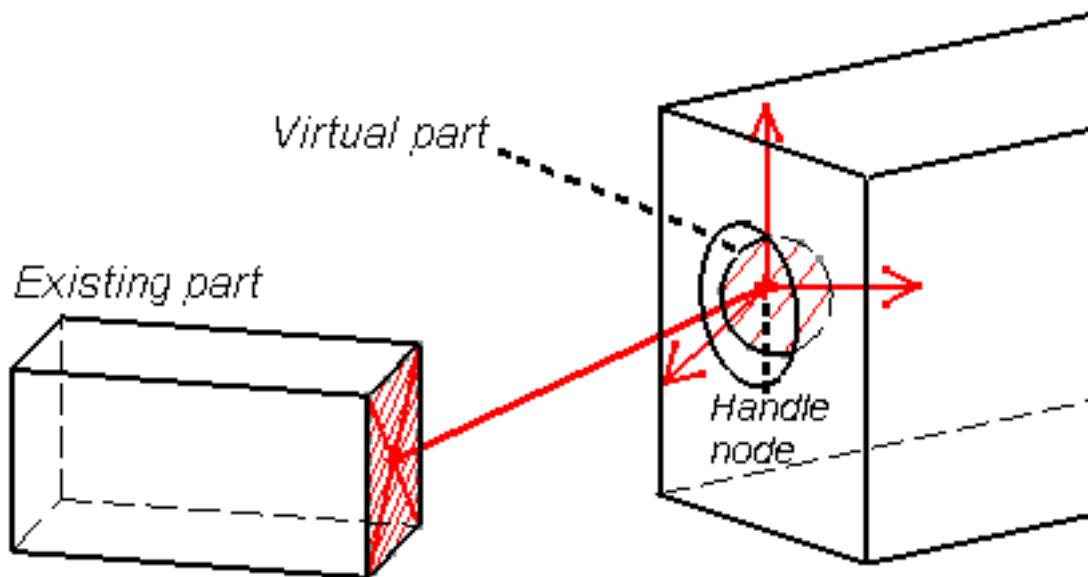

**→ means that there is no translation degree of freedom left in that direction.**

Ball Join objects belong to Restraints objects sets.

For the fixed point, the program automatically picks the handle of the virtual part. The virtual part as a whole is then allowed to rotate around this point.

Make sure you fixed all the global degrees of freedom of your assembly, otherwise a global singularity will be detected at the time of the Static Computation (such a model is unsolvable). To allow you to easily correct the model (Static Analysis Cases only), the singular displacement of the assembly will be simulated and visualized after computation.

When connected to deformable bodies, the virtual part will transmit the effect of the Ball

Join restraint collectively to the entire connected geometry.



Ball Joins can be applied to the following types of supports:

Geometrical Feature	Mechanical Feature	Analysis Feature			
		Free Groups	Geometrical Groups	Proximity Groups	Others
Point/Vertex					Virtual Part



Open the [sample15.CATAnalysis](#) document from the samples directory for this task: a [Finite Element Model](#) containing a Static or Frequency Analysis Case and created a [Virtual part](#).

### Before You Begin:

Go to **View -> Render Style -> Customize View** and make sure the **Shading, Outlines** and **Materials** options are active in the Custom View Modes dialog box.



1. Click the **Ball Join** icon .

The Ball Join dialog box appears.



2. You can change the identifier of the Ball Join by editing the **Name** field, if needed.
3. Select the virtual part.

The Ball Joint dialog box is updated.

A symbol representing the Ball Joint is displayed on the virtual part.

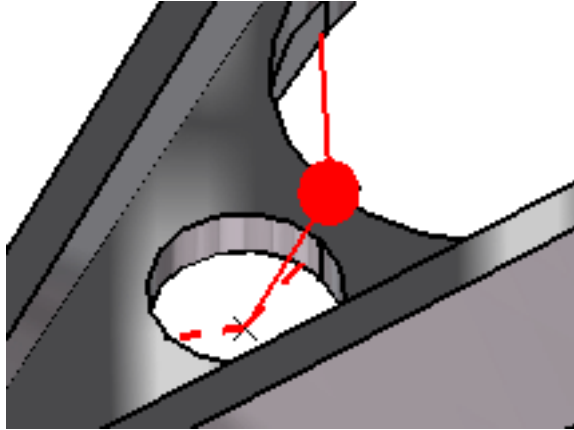

4. Click **OK** in the Ball Joint dialog box to create the Ball Joint.

A **Ball Joint** object appears in the specification tree under the active **Restraints** objects set.

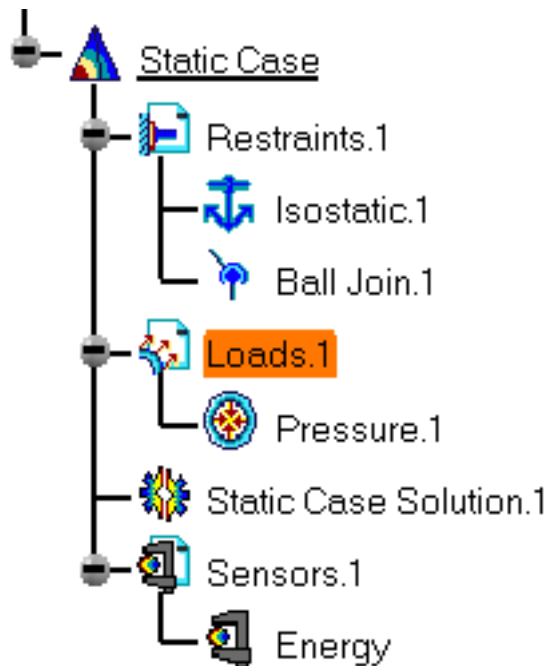



You can either select the virtual part support and then set the Ball Join specifications, or set the Ball Join specifications and then select the virtual part support.

If several Analysis Cases have been defined in the Finite Element Model, you must activate a Restraints objects set by clicking it in the features tree before creating a Ball Join object.

Restraints are required for Stress Analysis computations. They are optional for Modal Analysis computations (if not created, the program will compute vibration modes for the free, unrestrained part).

Ball Join objects can be edited by a double click on the corresponding object or icon in the features tree.





Make sure the computation is finished before starting any of the following operations.



### Products Available in Analysis Workbench

The **ELFINI Structural Analysis** product offers the following additional features with a right mouse click (key 3):

-  on a **Ball Join** object:
  - **Restraint visualization on mesh:** the translation of your Ball Join object specifications into solver specifications can be visualized symbolically at the impacted mesh nodes, provided the mesh has been previously generated via a Compute action.
  
-  on a **Restraints objects** set:
  - **Generate Image:** generates an image of the computed Restraint objects (along with translating all user-defined Restraints specs into explicit solver commands on mesh entities), by generating symbols for the nodal restraints imposed by the Restraints objects set. The image can be edited to include part or all of the options available.
  - **Report:** the partial status and results of intermediate pre-processor computations are reported in HTML format. It represents a subset of the global Report capability and generates a partial report of the Restraints objects set Computation.

For more details, please refer to [Creating Clamps](#).



# Creating Sliders



This task shows how to create a Slider on a virtual part.



*Sliders* are **prismatic joint** restraints applied to handle points of virtual parts, which result in constraining the point to slide along a given axis. They can be viewed as particular cases of general prismatic joints, which allow a relative translation between two points (in the Slider case, one of the two points is fixed, along with the sliding axis).

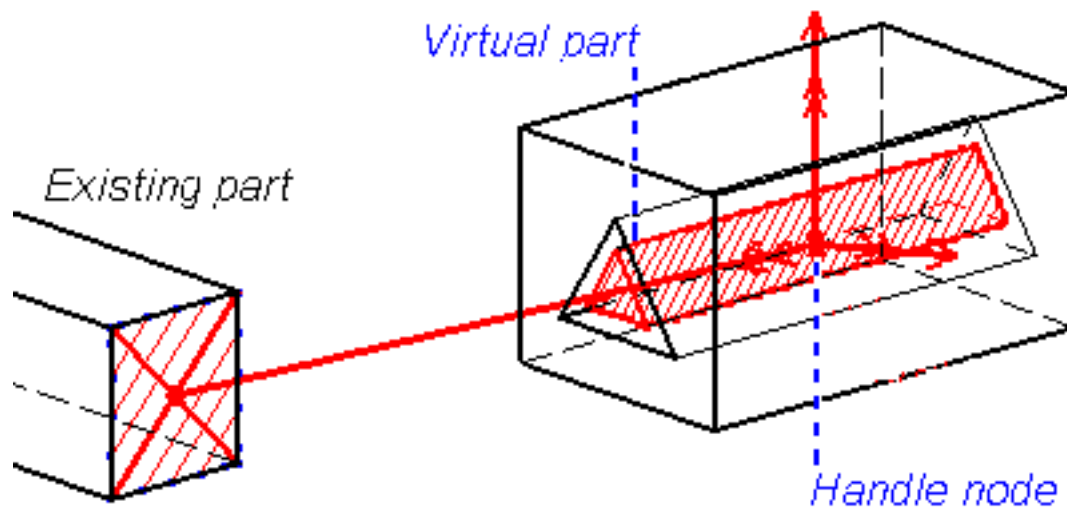

 means that there is no translation degree of freedom left in that direction.

 means that there is no rotation degree of freedom left in the direction.

Slider objects belong to Restraint objects sets.

For the fixed point, the program automatically picks the handle of the virtual part. The user defines the sliding direction, and as a result the virtual part as a whole is allowed to slide along an axis parallel to the sliding direction and passing through the fixed point.

Make sure you fixed all the global degrees of freedom of your assembly, otherwise a global singularity will be detected at the time of the Static Computation (such a model is unsolvable). To allow you to easily correct the model (Static Analysis Cases only), the singular displacement of the assembly will be simulated and visualized after computation.

When connected to deformable bodies, the virtual part will transmit the effect of the Slider



restraint collectively to the entire connected geometry.



Sliders can be applied to the following types of supports:

Geometrical Feature	Mechanical Feature	Analysis Feature			
		Free Groups	Geometrical Groups	Proximity Groups	Others
					Virtual Part



Open the [sample15.CATAnalysis](#) document from the samples directory for this task.

**Before You Begin:**

Go to **View -> Render Style -> Customize View** and make sure the **Shading, Outlines** and **Materials** options are active in the Custom View Modes dialog box.



1. Click the **Slider** icon .

The Slider dialog box appears.

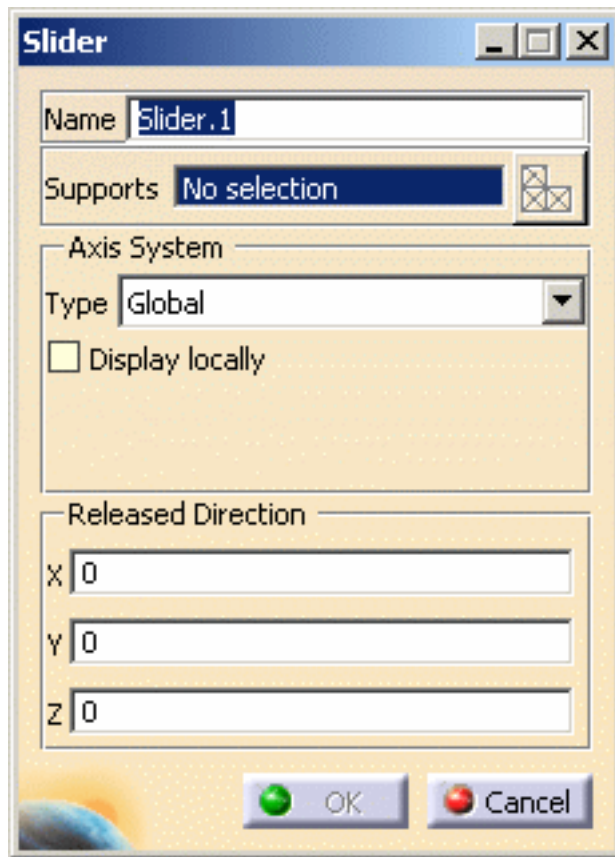

2. You can change the identifier of the Slider by editing the **Name** field, if needed.

The Axis Type combo box allows you to choose between **Global** and **User-defined** Axis systems for entering components of the sliding axis.

- **Global:** if you select the Global Axis system, the components of the sliding direction will be interpreted as relative to the fixed global rectangular coordinate system.
- **User-defined:** if you select a User-defined Axis system, the components of the sliding direction will be interpreted as relative to the specified rectangular coordinate system.  
To select a User-defined Axis system, you must activate an existing Axis by clicking it in the features tree. Its name will then be automatically displayed in the **Current Axis** field.

3. Set the Axis system.
4. In the **X**, **Y**, **Z** fields, enter the values corresponding to the components of the sliding direction relative to the selected Axis System.

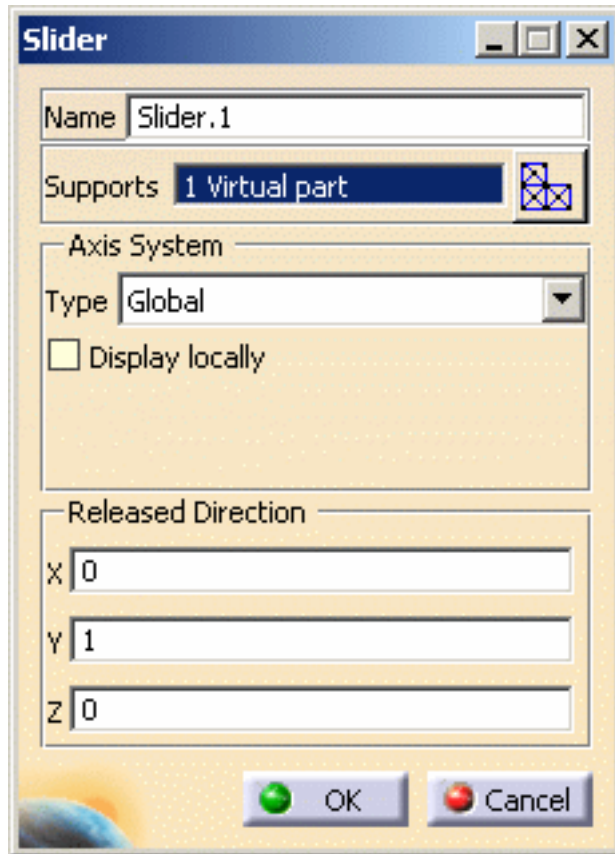

- You can define the sliding direction by using the compass. The values in the **X**, **Y**, **Z** fields correspond to the direction components of the compass principal axis.
- You can modify the compass orientation either with the mouse or by editing the compass.
- By applying the compass to any part geometry, you can align the compass directions with the implicit axis directions of that geometry: drag the compass by handling the red square and drop it on the appropriate surface. The normal direction to this surface defines the new direction. Then, click on the Compass Direction button to take this new direction into account. You can now invert the direction if desired, by editing the values of the three components.

**5.** Select the virtual part.

A symbol representing the sliding direction is displayed on the virtual part.

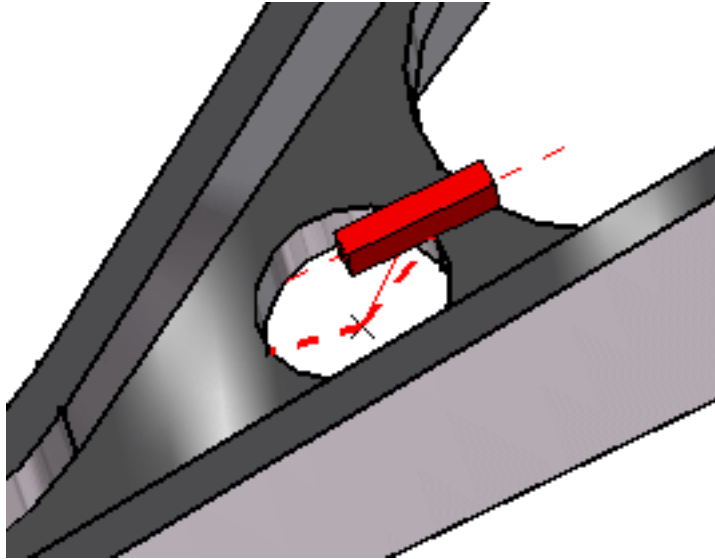

6. Modify the sliding direction orientation.

The visualized Slider symbol orientation is automatically updated to reflect the modifications of the compass principal direction.

7. Click **OK** in the Slider dialog box.

A **Slider** object appears in the specification tree under the active **Restrains** objects set.

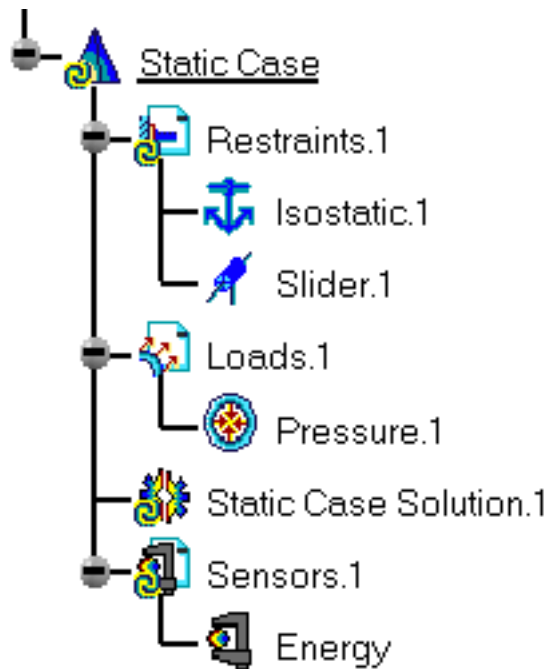

You can either select the virtual part support and then set the Slider specifications, or set the Slider specifications and then select the virtual part support.

If several Analysis Cases have been defined in the Finite Element Model, you must activate a Restraints objects set by clicking it in the features tree before creating a Slider object (only available if you have **ELFINI Structural Analysis** product installed).

Restraints are required for Stress Analysis computations. They are optional for Modal Analysis computations (if not created, the program will compute vibration modes for the free, unrestrained part).

Slider objects can be edited by a double click on the corresponding object or icon in the features tree.





Make sure the computation is finished before starting any of the following operations.



## Products Available in Analysis Workbench

The **ELFINI Structural Analysis** product offers the following additional features with a right mouse click (key 3):

-  on a **Slider** object:
  - **Restraint visualization on mesh:** the translation of your Slider object specifications into solver specifications can be visualized symbolically at the impacted mesh nodes, provided the mesh has been previously generated via a Compute action.
  
-  on a **Restraints objects** set:
  - **Generate Image:** generates an image of the computed Restraint objects (along with translating all user-defined Restraints specs into explicit solver commands on mesh entities), by generating symbols for the nodal restraints imposed by the Restraints objects set. The image can be edited to include part or all of the options available.
  - **Report:** the partial status and results of intermediate pre-processor computations are reported in HTML format. It represents a subset of the global Report capability and generates a partial report of the Restraints objects set Computation.

For more details, please refer to [Creating Clamps](#).



# Creating Pivots



This task shows how to create a Pivot on a virtual part.



*Pivots* are **hinge (conical joint)** restraints applied to handle points of virtual parts, which result in constraining the point to rotate around a given axis. They can be viewed as particular cases of general hinge joints, which allow a relative rotation between two points (in the Pivot case, one of the two points is fixed, along with the pivot axis).

Pivot objects belong to Restraint objects sets.

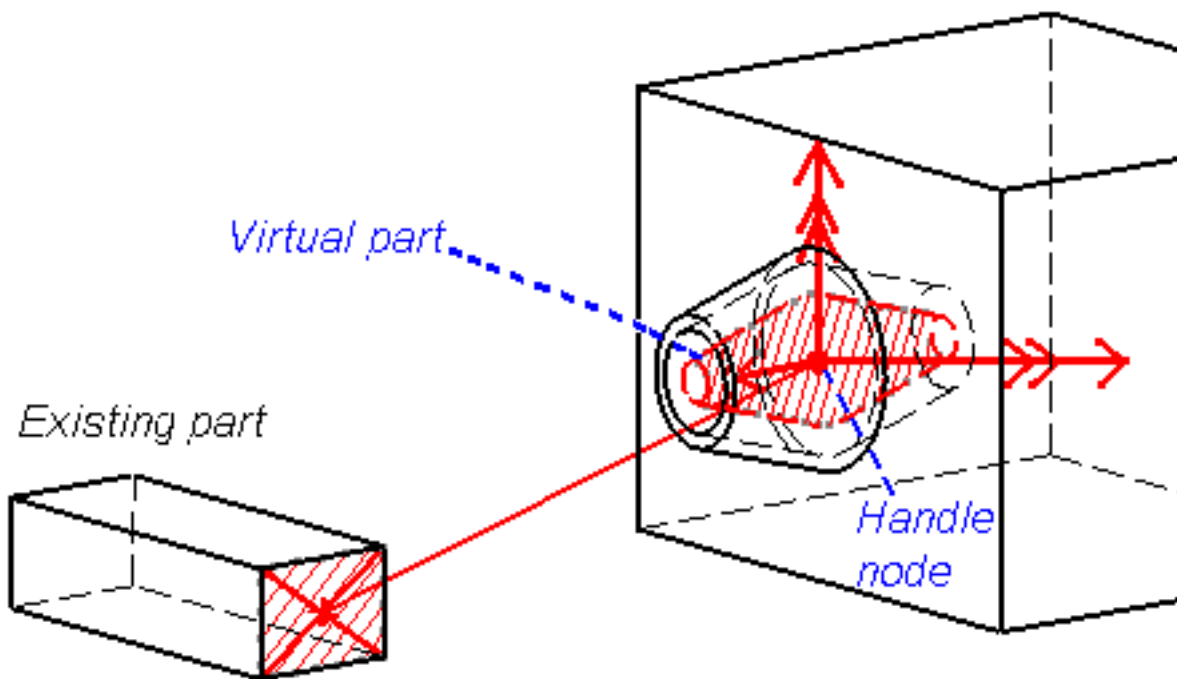

 means that there is no translation degree of freedom left in that direction.

 means that there is no rotation degree of freedom left in the direction.

For the fixed point, the program automatically picks the handle of the virtual part. The user defines the pivot direction, and as a result the virtual part as a whole is allowed to rotate around an axis parallel to the pivot direction and passing through the fixed point.

Make sure you fixed all the global degrees of freedom of your assembly, otherwise a global singularity will be detected at the time of the Static Computation (such a model is unsolvable). To allow you to easily correct the model (Static Analysis Cases only), the

singular displacement of the assembly will be simulated and visualized after computation.

When connected to deformable bodies, the virtual part will transmit the effect of the Pivot restraint collectively to the entire connected geometry.



Pivots can be applied to the following types of supports:

Geometrical Feature	Mechanical Feature	Analysis Feature			
		Free Groups	Geometrical Groups	Proximity Groups	Others
					Virtual Part



Open the [sample15.CATAnalysis](#) document from the samples directory for this task: a [Finite Element Model](#) containing a Static or Frequency Analysis Case and created a [Virtual part](#).

### Before You Begin:

Go to **View -> Render Style -> Customize View** and make sure the **Shading, Outlines** and **Materials** options are active in the Custom View Modes dialog box.



1. Click the **Pivot** icon .

The Pivot dialog box appears.



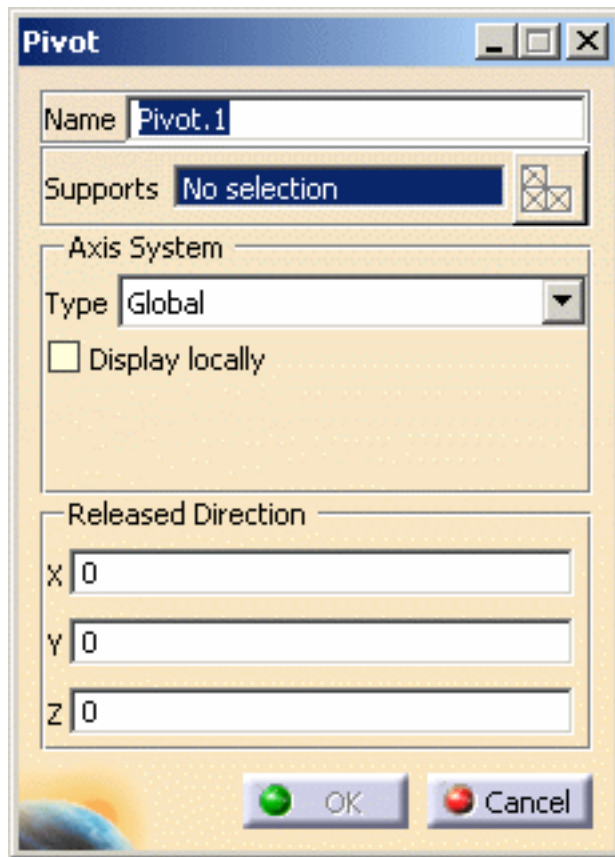

2. You can change the identifier of the Pivot by editing the **Name** field, if needed.

The **Axis System Type** combo box allows you to choose between **Global** and **User-defined** Axis systems for entering components of the pivot axis.

- **Global:** if you select the Global Axis system, the components of the pivot direction will be interpreted as relative to the fixed global rectangular coordinate system.
- **User-defined:** if you select a User-defined Axis system, the components of the pivot direction will be interpreted as relative to the specified rectangular coordinate system.  
To select a User-defined Axis system, you must activate an existing Axis by clicking it in the features tree. Its name will then be automatically displayed in the **Current Axis** field.

3. Set the Axis system.
4. In the **X**, **Y**, **Z** fields, enter the values corresponding to the components of the pivot direction relative to the selected Axis system.



- You can define the pivot direction by using the compass. The values in the **X**, **Y**, **Z** fields correspond to the direction components of the compass principal axis.
- You can modify the compass orientation either with the mouse or by editing the compass.
- By applying the compass to any part geometry, you can align the compass directions with the implicit axis directions of that geometry: drag the compass by handling the red square and drop it on the appropriate surface. The normal direction to this surface defines the new direction. Then, click on the Compass Direction button to take this new direction into account. You can now invert the direction if desired, by editing the values of the three components.

**5.** Select a virtual part.

A symbol representing the pivot direction is displayed on the virtual part.

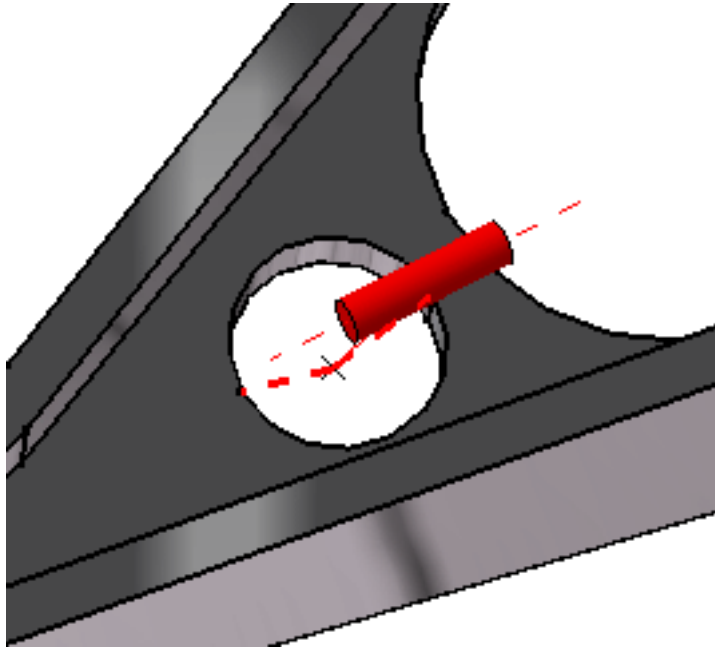

**6.** Modify the pivot direction orientation.

The visualized Pivot symbol orientation is automatically updated to reflect the modifications of the compass principal direction.

**7.** Click **OK** in the Pivot dialog box.

A **Pivot** object appears in the features tree under the active **Restraints** objects set.

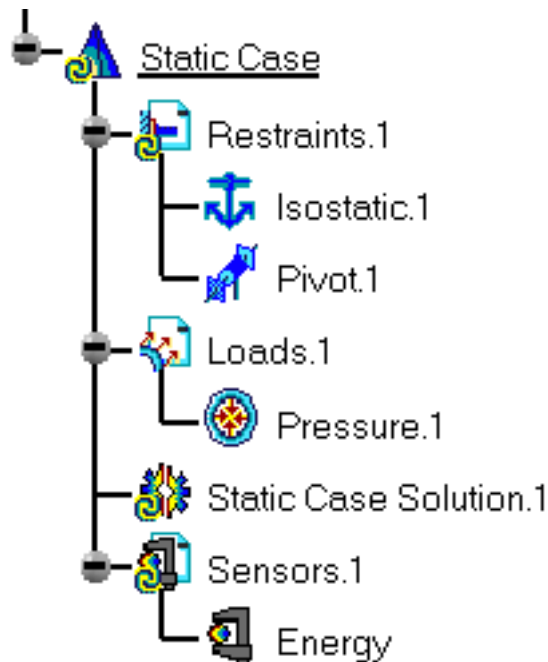

- You can either select the virtual part support and then set the Pivot specifications, or set the Pivot specifications and then select the virtual part support.
- If several Analysis Cases have been defined in the Finite Element Model, you must activate a Restraints objects set by clicking it in the specification tree before creating a Pivot object.
- Restraints are required for Stress Analysis computations. They are optional for Modal Analysis computations (if not created, the program will compute vibration modes for the free, unrestrained part).
- Pivot objects can be edited by a double click on the corresponding object or icon in the features tree.





Make sure the computation is finished before starting any of the following operations.



## Products Available in Analysis Workbench

The **ELFINI Structural Analysis** product offers the following additional features with a right mouse click (key 3):

-  on a **Pivot** object:
  - **Restraint visualization on mesh:** the translation of your Pivot object specifications into solver specifications can be visualized symbolically at the impacted mesh nodes, provided the mesh has been previously generated via a Compute action.
  
-  on a **Restraints objects** set:
  - **Generate Image:** generates an image of the computed Restraint objects (along with translating all user-defined Restraints specs into explicit solver commands on mesh entities), by generating symbols for the nodal restraints imposed by the Restraints objects set. The image can be edited to include part or all of the options available.
  - **Report:** the partial status and results of intermediate pre-processor computations are reported in HTML format. It represents a subset of the global Report capability and generates a partial report of the Restraints objects set Computation. For more details, please refer to [Creating Clamps](#).



# Creating Sliding Pivots



This task shows how to create a Sliding Pivot on a virtual part.



*Sliding Pivots* are **cylindrical join** restraints applied to handle points of virtual parts, which result in constraining the point to simultaneously translate along and rotate around a given axis. They can be viewed as particular cases of general cylindrical joints, which allow a relative combined translation and rotation between two points (in the Sliding Pivot case, one of the two points is fixed, along with the sliding pivot axis).

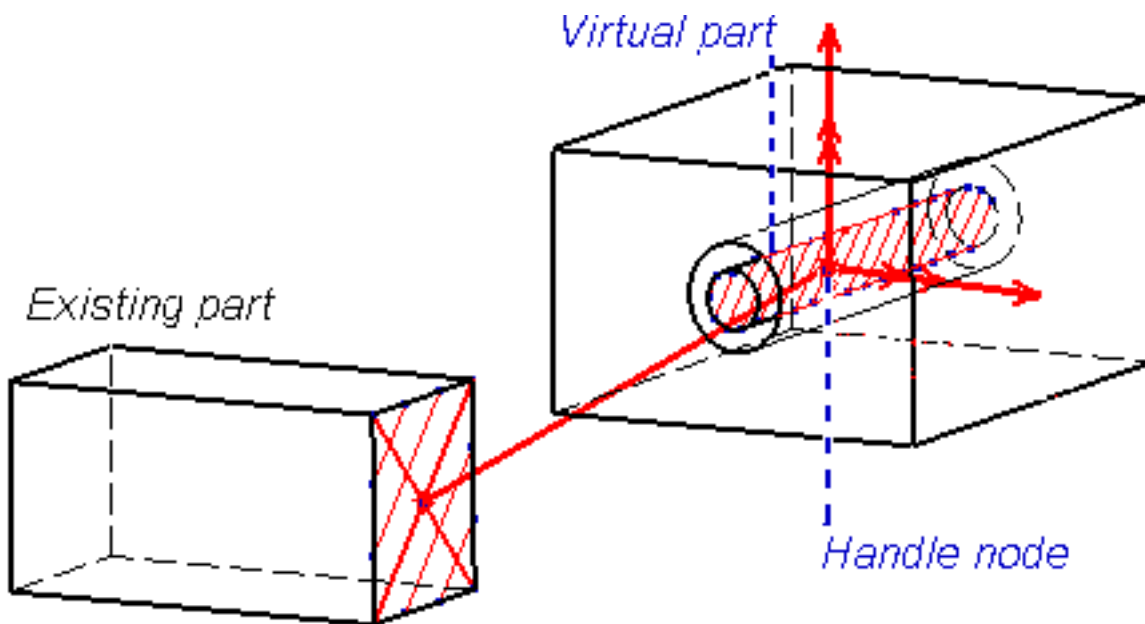

 means that there is no translation degree of freedom left in that direction.

 means that there is no rotation degree of freedom left in the direction.

Sliding Pivot objects belong to Restraint objects sets.

For the fixed point, the program automatically picks the handle of the virtual part. The user defines the sliding pivot direction, and as a result the virtual part as a whole is allowed to translate along and to rotate around an axis parallel to the sliding pivot direction and passing through the fixed point.

Make sure you fixed all the global degrees of freedom of your assembly, otherwise a global singularity will be detected at the time of the Static Computation (such a model is

unsolvable). To allow you to easily correct the model (Static Analysis Cases only), the singular displacement of the assembly will be simulated and visualized after computation.

When connected to deformable bodies, the virtual part will transmit the effect of the Sliding Pivot restraint collectively to the entire connected geometry.



Sliding Pivots can be applied to the following types of supports:

Geometrical Feature	Mechanical Feature	Analysis Feature			
		Free Groups	Geometrical Groups	Proximity Groups	Others
					Virtual Part



Open the [sample15.CATAnalysis](#) document from the samples directory for this task: a [Finite Element Model](#) containing a Static or Frequency Analysis Case and created a [Virtual part](#).

### Before You Begin:

Go to **View -> Render Style -> Customize View** and make sure the **Shading, Outlines** and **Materials** options are active in the Custom View Modes dialog box.



1. Click the **Sliding Pivot** icon .

The Sliding Pivot dialog box appears.

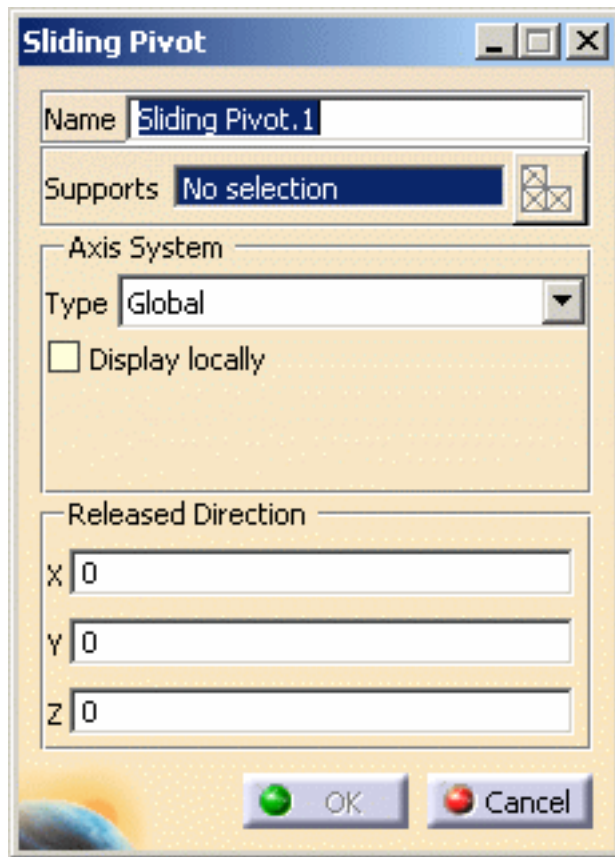

2. You can change the identifier of the Sliding Pivot by editing the **Name** field, if needed.

The **Axis System Type** combo box allows you to choose between **Global** and **User-defined** Axis systems for entering components of the pivot axis.

- **Global:** if you select the Global Axis system, the components of the sliding pivot direction will be interpreted as relative to the fixed global rectangular coordinate system.
- **User-defined:** if you select a User-defined Axis system, the components of the sliding pivot direction will be interpreted as relative to the specified rectangular coordinate system.  
To select a User-defined Axis system, you must activate an existing Axis by clicking it in the features tree. Its name will then be automatically displayed in the **Current Axis** field.

3. Set the Axis system.

4. Select a virtual part.

A symbol representing the sliding pivot direction is displayed on the virtual part.

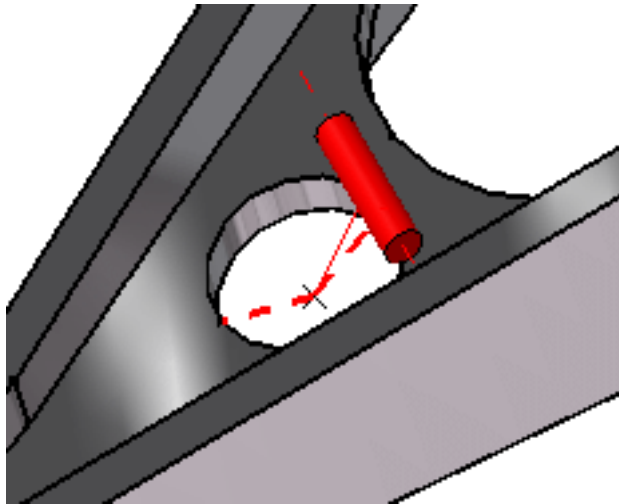

5. In the **X**, **Y**, **Z** fields, enter the values corresponding to the components of the sliding pivot direction relative to the selected **Axis System**.

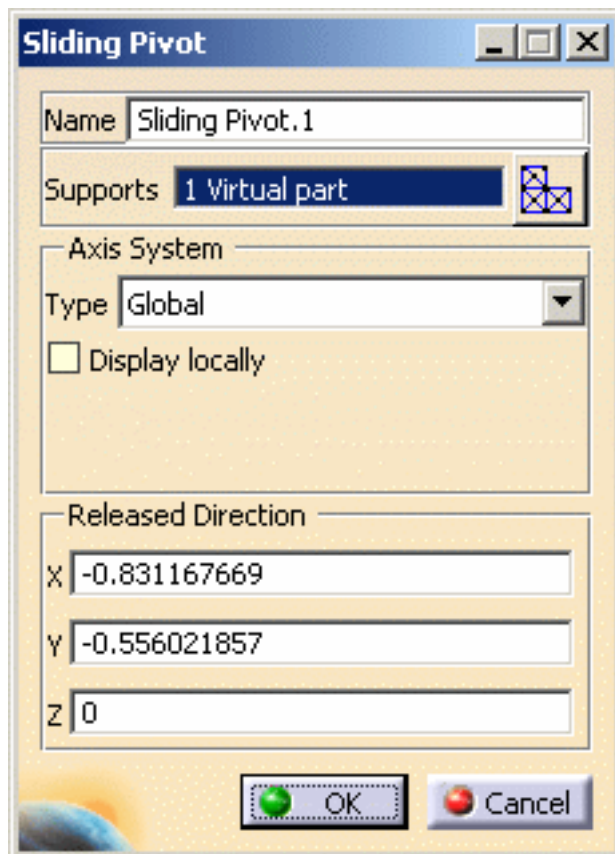





- You can define the sliding pivot direction by using the compass. The values in the **X**, **Y**, **Z** fields correspond to the direction components of the compass principal axis.
- You can modify the compass orientation either with the mouse or by editing the compass.
- By applying the compass to any part geometry, you can align the compass directions with the implicit axis directions of that geometry: drag the compass by handling the red square and drop it on the appropriate surface. The normal direction to this surface defines the new direction. Then, click on the Compass Direction button to take this new direction into account. You can now invert the direction if desired, by editing the values of the three components.

**6.** Modify the sliding pivot direction orientation.

The visualized Sliding Pivot symbol orientation is automatically updated to reflect the modifications of the compass principal direction.

**7.** Click **OK** in the Sliding Pivot dialog box.

A Sliding Pivot object appears in the specification tree under the active **Restraints** objects set.

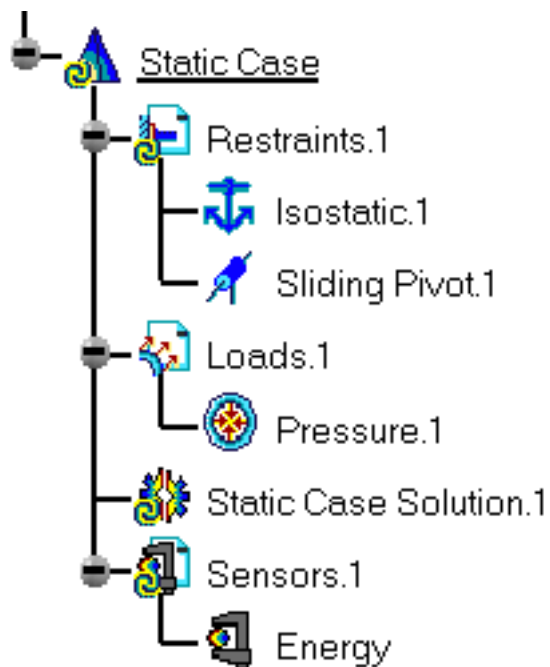



- You can either select the virtual part support and then set the Sliding Pivot specifications, or set the Sliding Pivot specifications and then select the virtual part support.
- If several Analysis Cases have been defined in the Finite Element Model, you must activate a Restraints objects set by clicking it in the specification tree before creating a Sliding Pivot object (only available if you have **ELFINI Structural Analysis** product installed).
- Restraints are required for Stress Analysis computations. They are optional for Modal Analysis computations (if not created, the program will compute vibration modes for the free, unrestrained part).
- Sliding Pivot objects can be edited by a double click on the corresponding object or icon in the features tree.





Make sure the computation is finished before starting any of the following operations.



### Products Available in Analysis Workbench

The **ELFINI Structural Analysis** product offers the following additional features with a right mouse click (key 3):

-  on a **Sliding Pivot** object:
  - **Restraint visualization on mesh:** the translation of your Sliding Pivot object specifications into solver specifications can be visualized symbolically at the impacted mesh nodes, provided the mesh has been previously generated via a Compute action.
-  on a **Restraints objects** set:
  - **Generate Image:** generates an image of the computed Restraint objects (along with translating all user-defined Restraints specs into explicit solver commands on mesh entities), by generating symbols for the nodal restraints imposed by the Restraints objects set. The image can be edited to include part or all of the options available.
  - **Report:** the partial status and results of intermediate pre-processor computations are reported in HTML format. It represents a subset of the global Report capability and generates a partial report of the Restraints objects set Computation.

For more details, please refer to [Creating Clamps](#).



# Creating Advanced Restraints



This task shows how to create an Advanced Restraint on a geometry.



*Advanced Restraints* are generic restraints allowing you to **fix any combination of available nodal degrees of freedom** on arbitrary geometries. There are three translation degrees of freedom per node for continuum element meshes, and three translation and three rotation degrees of freedom per node for structural element meshes.

*(this is an example)*

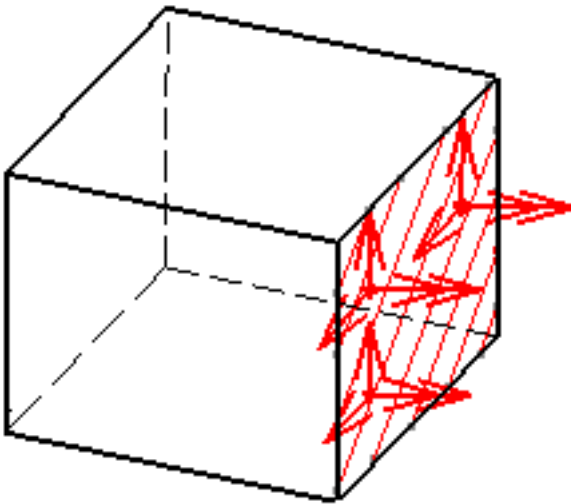

 means that there is no translation degree of freedom left in that direction.

 means that there is no rotation degree of freedom left in the direction.

Make sure you fixed all the global degrees of freedom of your assembly, otherwise a global singularity will be detected at the time of the Static Computation (such a model is unsolvable). To allow you to easily correct the model (Static Analysis Cases only), the singular displacement of the assembly will be simulated and visualized after computation.

Advanced Restraint objects belong to Restraint objects sets.



Advanced Restraints can be applied to the following types of supports:

Geometrical Feature	Mechanical Feature	Analysis Feature			
		Free Groups	Geometrical Groups	Proximity Groups	Others
Point/Vertex Edge Face					Virtual Part



Open the [sample20.CATAnalysis](#) document from the samples directory for this task: a [Finite Element Model](#) containing a Static or Frequency Analysis Case.

**Before You Begin:**

Go to **View -> Render Style -> Customize View** and make sure the **Shading, Outlines** and **Materials** options are active in the Custom View Modes dialog box.



1. Click the **Advanced Restraint** icon .

The Advanced Restraint dialog box appears.

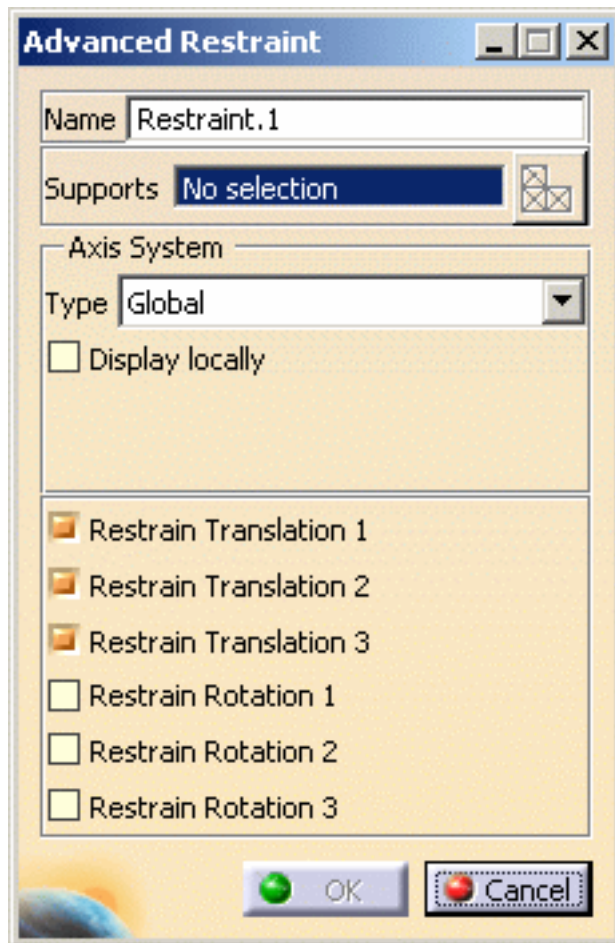

2. You can change the identifier of the Advanced Restraint by editing the **Name** field, if needed.
3. Set the Axis System Type.

The **Axis System Type** combo list allows you to choose between **Global**, **Implicit** and **User-defined** Axis systems for defining the degrees of freedom directions:

- **Global:** if you select the Global Axis system, the degree of freedom directions will be interpreted as relative to the fixed global rectangular coordinate system.
- **Implicit:** if you select the Implicit Axis system, the degree of freedom directions will be interpreted as relative to a local variable coordinate system whose type depends on the support geometry.
- **User:** if you select a User Axis system, the degree of freedom directions will be relative to the specified Axis system. Their interpretation will further depend on your Axis Type choice.  
To select a User-defined Axis system, you must activate an existing Axis by clicking it in the features tree. Its name will then be automatically displayed in the **Current Axis** field.  
If you select the User-defined Axis system, the Local orientation combo box further allows you to choose between **Cartesian**, **Cylindrical** and **Spherical** Local Axis Orientations.

- **Cartesian:** the degrees of freedom directions are relative to a fixed rectangular coordinate system aligned with the cartesian coordinate directions of the User-defined Axis.
- **Cylindrical:** the degrees of freedom directions are relative to a local variable rectangular coordinate system aligned with the cylindrical coordinate directions of each point relative to the User-defined Axis.
- **Spherical:** the degrees of freedom directions are relative to a local variable rectangular coordinate system aligned with the spherical coordinate directions of each point relative to the User-defined Axis.

4. Select the geometry support (a surface or an edge). Any selectable geometry is highlighted when you pass the cursor over it.

You can select several supports in sequence, to apply the Advanced Restraint to all supports simultaneously.

Symbols representing fixed degrees of freedom in all restrained directions for the selected geometry are visualized.

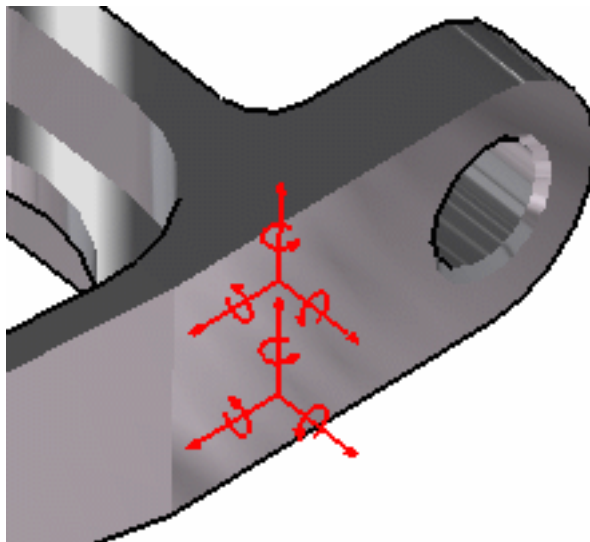

5. Activate the degrees of freedom which are to be fixed in the subsequent analysis.

You can fix up to six degrees of freedom per node:

1. **Translation 1** = Translation in **x**
2. **Translation 2** = Translation in **y**
3. **Translation 3** = Translation in **z**
4. **Rotation 1** = Rotation in **x**
5. **Rotation 2** = Rotation in **y**
6. **Rotation 3** = Rotation in **z**



If you activate the **Restrain Rotation** options, make sure the selected elements can actually be restrained at given rotations.

6. Click **OK** to create the Advanced Restraint.

A **Restraint** object appears in the specification tree under the active **Restraints** objects set.

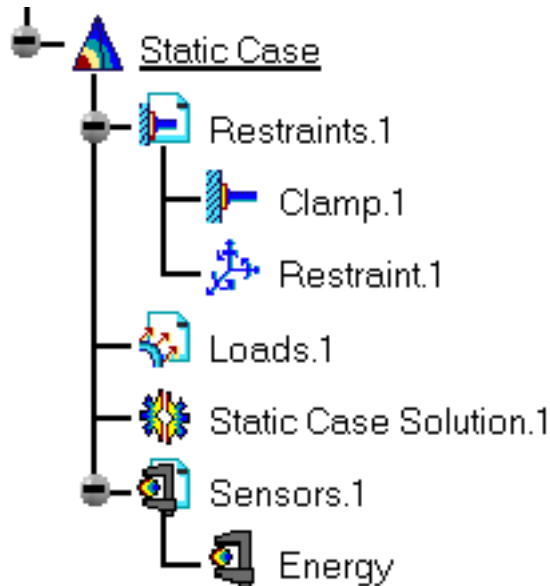

- You can either select the support and then set the Advanced Restraint specifications, or set the Advanced Restraint specifications and then select the support.
- If several Analysis Cases have been defined in the Finite Element Model, you must activate a Restraints objects set by clicking it in the features tree before creating an Advanced Restraint object.
- Restraints are required for Stress Analysis computations. They are optional for Modal Analysis computations (if not created, the program will compute vibration modes for the free, unrestrained part).
- Advanced Restraint objects can be edited by a double click on the corresponding object or icon in the features tree.





Make sure the computation is finished before starting any of the following operations.



## Products Available in Analysis Workbench

The **ELFINI Structural Analysis** product offers the following additional features with a right mouse click (key 3):

-  on an **Advanced Restraint** object:
  - **Restraint visualization on mesh:** the translation of your Advanced Restraint object specifications into solver specifications can be visualized symbolically at the impacted mesh nodes, provided the mesh has been previously generated via a Compute action.
  
-  on a **Restraints objects** set:
  - **Generate Image:** generates an image of the computed Restraint objects (along with translating all user-defined Restraints specs into explicit solver commands on mesh entities), by generating symbols for the nodal restraints imposed by the Restraints objects set. The image can be edited to include part or all of the options available.
  - **Report:** the partial status and results of intermediate pre-processor computations are reported in HTML format. It represents a subset of the global Report capability and generates a partial report of the Restraints objects set Computation.

For more details, please refer to [Creating Clamps](#).





# Creating Iso-static Restraints



This task shows how to create an Iso-Static Restraint on a body.



*Iso-static Restraints* are statically definite restraints allowing you to simply support a body.

*(this is an example of a part iso-statically restrained)*

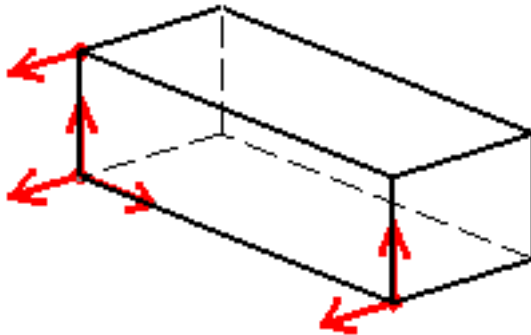

**→ means that there is no translation degree of freedom left in that direction.**

Iso-static Restraint objects belong to Restraint objects sets.

The program automatically chooses three points and restrains some of their degrees of freedom according to the 3-2-1 rule. The resulting boundary condition prevents the body from rigid-body translations and rotations, without over-constraining it.

Make sure you fixed all the global degrees of freedom of your assembly, otherwise a global singularity will be detected at the time of the Static Computation (such a model is unsolvable). To allow you to easily correct the model (Static Analysis Cases only), the singular displacement of the assembly will be simulated and visualized after computation.



Open the [sample00.CATAnalysis](#) document from the samples directory for this task: a [Finite Element Model](#) containing a Static or Frequency Analysis Case.

## **Before You Begin:**

Go to **View -> Render Style -> Customize View** and make sure the **Shading**, **Outlines** and **Materials** options are active in the Custom View Modes dialog box.



1. Click the **Isostatic Restraint** icon .

The Isostatic Restraint dialog box appears.



2. You can change the identifier of the Iso-static Restraint by editing the **Name** field.
3. Click **OK** in the Iso-static Restraint dialog box.

An **Isostatic.1** object appears in the specification tree under the active **Restraints** objects set.

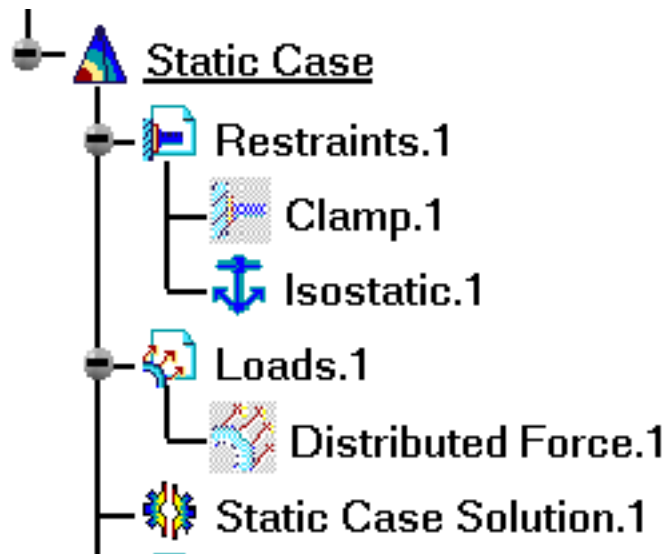

An Iso-static symbol appears on the geometry.

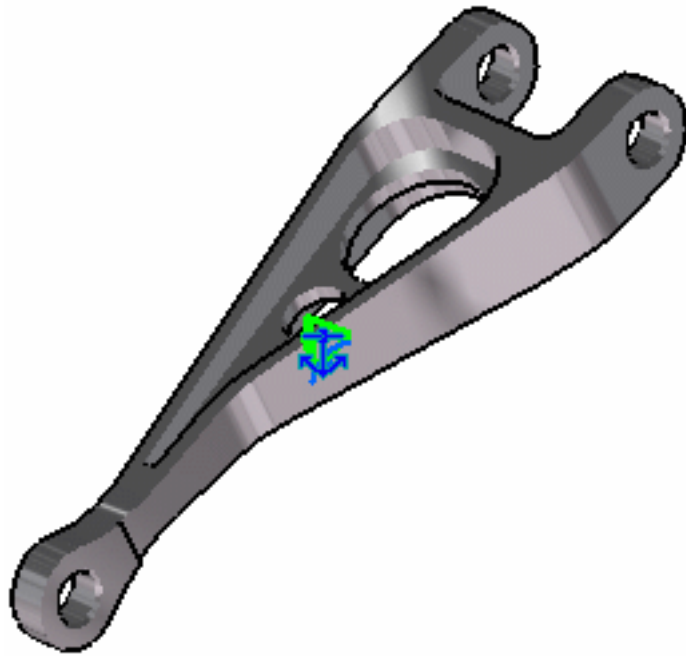

You can double-click the Iso-static symbol on the geometry or the **Isostatic.1** object in the specification tree, to display the Iso-static Restraint dialog box and modify the **Name**, if needed.



- You can either select the support and then set the Iso-static Restraint specifications, or set the Iso-static Restraint specifications and then select the support.
- If several Analysis Cases have been defined in the Finite Element Model, you must activate a Restraints objects set by clicking it in the features tree before creating an Iso-static Restraint object.
- Restraints are required for Stress Analysis computations. They are optional for Modal Analysis computations (if not created, the program will compute vibration modes for the free, unrestrained part).
- Iso-static Restraint objects can be edited by a double click on the corresponding object or icon in the features tree.





Make sure the computation is finished before starting any of the following operations.



## Products Available in Analysis Workbench

The **ELFINI Structural Analysis** product offers the following additional features with a right mouse click (key 3):

-  on an **Iso-Static Restraint** object:
  - **Iso-static Restraint Visualization on Mesh:** the translation of your Iso-static Restraint object specifications into solver specifications can be visualized symbolically at the impacted mesh nodes, provided the mesh has been previously generated via a Compute action.
  
-  on a **Restraints** objects set:
  - **Generate Image:** generates an image of the computed Restraint objects (along with translating all user-defined Restraints specs into explicit solver commands on mesh entities), by generating symbols for the nodal restraints imposed by the Restraints objects set. The image can be edited to include part or all of the options available.
  - **Report:** the partial status and results of intermediate pre-processor computations are reported in HTML format. It represents a subset of the global Report capability and generates a partial report of the Restraints objects set Computation.

For more details, please refer to [Creating Clamps](#).



# Loads



## Create Pressures

Generate pressure loads over a surface.

## Distributed Force Systems



## Create a Distributed Force

Generate a distributed force system equivalent to a pure force at a point (given force resultant and zero moment resultant).



## Create a Distributed Moment

Generate a distributed force system equivalent to a pure couple (given moment resultant and zero force resultant).



## Create a Bearing Load

Simulate contact loads applied to cylindrical parts.



## Import Forces

Import forces from a text file or an excel file, either on a surface or on a virtual part.



## Import Moments

Import moments from a text or an excel file, on a surface.



## Force Densities



## Create a Line Force Density

Generate a line force field of given uniform intensity on a part edge.



## Create a Surface Force Density

Generate a surface traction field of given uniform intensity on a part face.



## Create a Body Force

Generate a volume body force field of given uniform intensity on a part.



### Create a Force Density

Generate the equivalent of the existing line and surface force densities and body force by giving as input only a force in Newton (N).



## Mass Body Forces



### Create an Acceleration

Generate a uniform acceleration field over a part.



### Create Rotations

Generate a linearly varying acceleration field over a part.



### Create Enforced Displacements

Assign non-zero displacement values to restrained geometric selections.

## Temperature



### Create Temperature Field

Load a body with a given temperature.



### Import Temperature Field from Thermal Solution

Load a body with temperature imported from an existing thermal solution.



# Creating Pressures



This task shows how to create a Pressure applied to surface geometry.



*Pressures* are intensive loads representing uniform scalar pressure fields applied to surface geometries, and characterized by the fact that the force direction is everywhere normal to the surface.

**Pressure** objects belong to **Loads** sets.

Units are pressure units (typically  $\text{N}/\text{m}^2$  in SI).



Pressures can be applied to the following types of supports:

Geometrical Feature	Mechanical Feature	Analysis Feature			
		Free Groups	Geometrical Groups	Proximity Groups	Others
Face					



Open the [sample00.CATAnalysis](#) document from the samples directory for this task: [Finite Element Model](#) containing a Static Analysis Case and computed corresponding [Static Solution](#).

## Before You Begin:

Go to **View** -> **Render Style** -> **Customize View** and make sure the **Shading**, **Outlines** and **Materials** options are active in the Custom View Modes dialog box.



1. Click the **Pressure** icon .

The Pressure dialog box appears.

2. You can change the identifier of the Pressure by editing the **Name** field.
3. Set the value of the scalar pressure. A positive value describes a pressure whose resultant is directed towards the material side of the selected surface.
4. Activate the **Data Mapping** option.



The data mapping functionality is only available with the **ELFINI Structural Analysis (EST)** product.

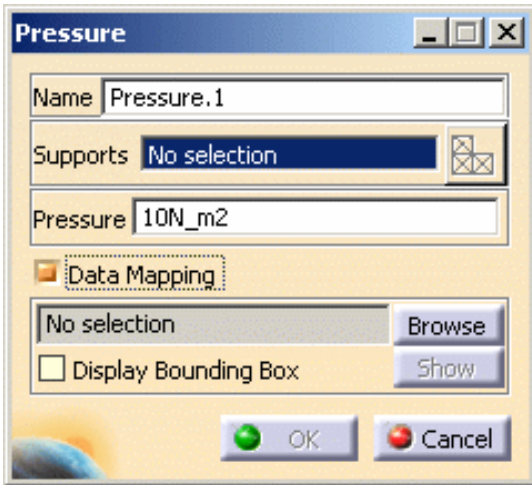

For more details about **Data Mapping** functionality and data mapping files, please refer to [Data Mapping](#) of the Frequently Asked Questions section.

5. Click the **Browse** button in the Pressure dialog box and load the desired external file. Make sure the file type is actually **\*.txt**.

The File Browser dialog box lets you select the desired file.

In this particular example, select the **MappingFileExample.txt** file in the samples directory.

When you click **Open**, the Pressure dialog box is updated.

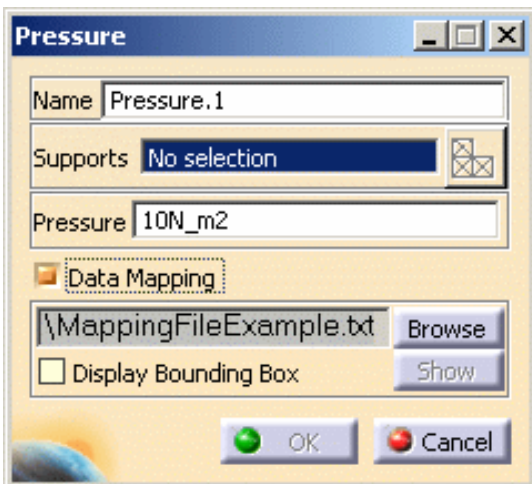

The **Show** button now lets you visualize the imported file inside the session. If you then modify the pointed file, the values are synchronized and the load feature invalidated.



X(mm)	Y(mm)	Z(m)	Coef()
-20	0	0.02	50
-21	14	0.03	50
-22	-16	0	50
0	0	0	100
0	16	-0.02	100
0	-14	0	100
20	0	0	150
21	15	-0.01	150
22	-15	0.01	150

- Select the geometry support (a face) on which you want to apply the Pressure. Any selectable geometry is highlighted when you pass the cursor over it.

You can select several supports in sequence, to apply the Pressure to all supports simultaneously. Several arrows symbolizing the pressure are visualized.

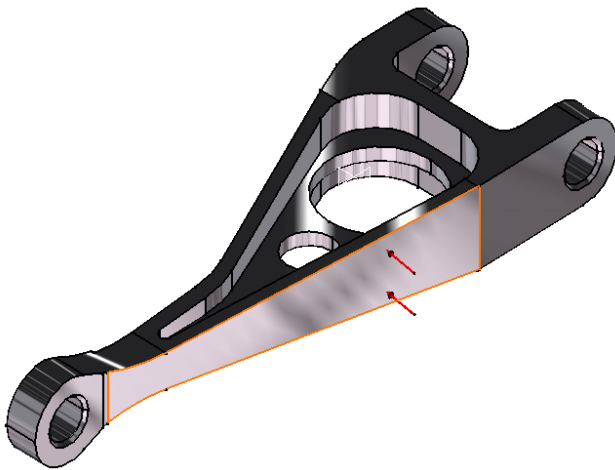

- Click **OK** in the Pressure dialog box.

A **Pressure** object appears in the specification tree under the active **Loads** objects set.

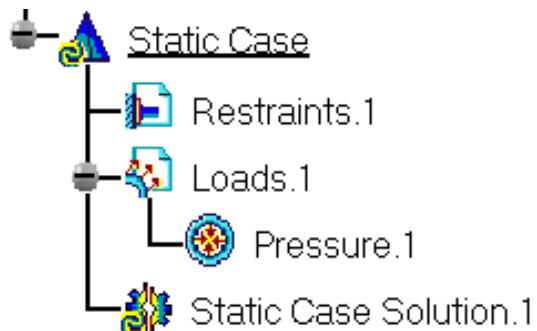



- You can either select the surface and then set the pressure value, or set the pressure value and then select the surface.
- If you select other surfaces, you can create as many Pressure Loads as desired with the same dialog box. A series of Pressures can therefore be created quickly.
- Loads are required for Stress Analysis computations.
- If several Analysis Cases have been defined in the Finite Element Model, you must activate a Loads objects set in the features tree before creating a Pressure object (only available if you have **ELFINI Structural Analysis (EST)** product installed).
- Pressure objects can be edited by a double-click on the corresponding object in the specification tree.



Make sure the computation is finished before starting any of the following operations.





### Products Available in Analysis Workbench

The **ELFINI Structural Analysis (EST)** product offers the following additional feature with a right-click (key 3):

-  on a **Pressure** object:
  - **Pressure visualization on mesh:** the translation of your Pressure object specifications into solver specifications can be visualized symbolically at the impacted mesh elements, provided the mesh has been previously generated via a Compute action.

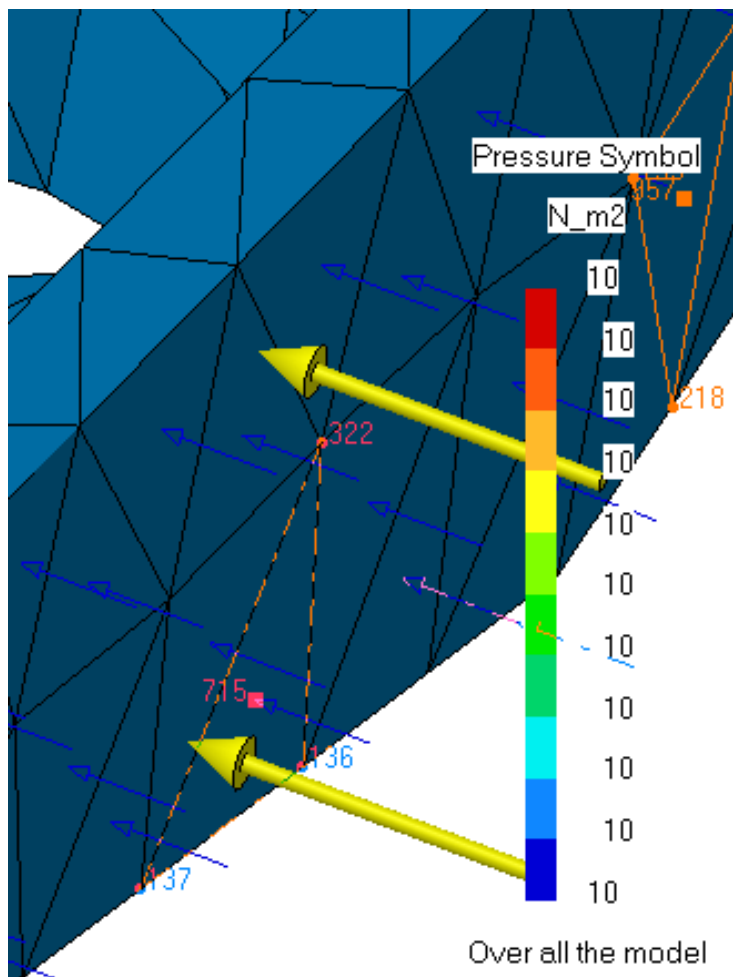
Right-click on a Pressure object and select the Pressure visualization on mesh option.



-  on a **Loads** set:
  - **Generate Image**: generates an image of the computed Load objects (along with translating all user-defined Loads specs into explicit solver commands on mesh entities), by generating symbols for the elementary loads imposed by the Loads objects set. The image can be edited to include part or all of the options available.

Right-click on a **Loads** set in the specification tree and select the **Generate Image** contextual menu. The Image Generation dialog box appears. You can select images by selecting them in the list.

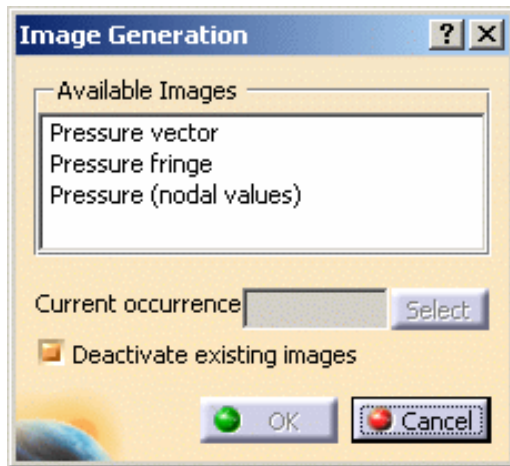

The resulting images sequence is obtained by superposition.

- **Report**: the partial status and results of intermediate pre-processor computations are reported in HTML format. It represents a subset of the global report capability and generates a partial report of the **Loads** set Computation.

Right-click the **Loads** set in the specification tree and select the **Report** contextual menu.

The **.html** partial report file appears.

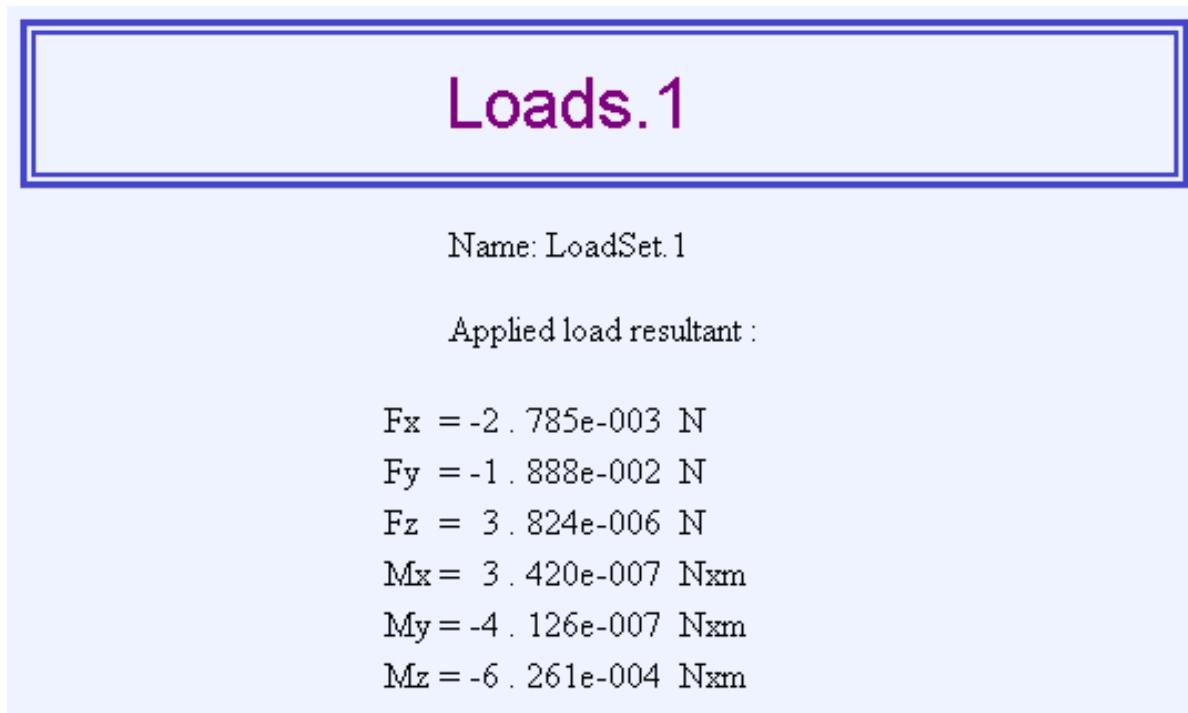

- **Self balancing on Loads set**: already named **Inertia Relief**.

Double-click the **Loads** set. The Loads dialog box appears:

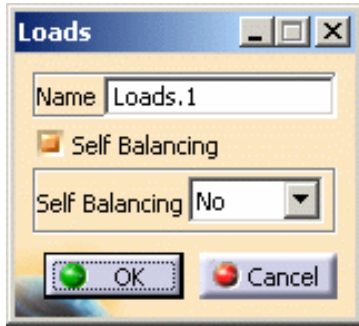

The Loads dialog box lets you choose whether you wish to apply self-balancing to the load. If activated, this option automatically adds inertia forces in order to counter balance external loads. Thus the global loading equals null.

This kind of loading is used when modeling free bodies submitted to constant external forces (for example: a rocket during lift-off).

This option is usually combined with iso-static restraint. In this case, reaction forces are null, which simulates a free body.



# Creating Distributed Forces



This task shows you how to create a Distributed Force applied to a virtual part or to a geometry selection.



*Distributed Forces* are force systems **statically equivalent to a given pure force resultant at a given point**, distributed on a virtual part or on a geometric selection.

Distributed Force objects belong to Loads objects sets.

The user specifies three components for the direction of the resultant force, along with a magnitude information. Upon modification of any of these four values, the resultant force vector components and magnitude are updated based on the last data entry. The resultant force vector remains constant independently of the geometry selection.

The point of application of the force resultant is automatically defined as follows:

- For extended geometries, this point is the centroid of the geometry.
- For virtual parts, this point is the handler of the virtual part.





The given single-force system is processed by the program as follows:

- In the case of extended geometries, it is transformed into an equivalent force system distributed over the selected support.
- In the case of virtual parts connected to deformable bodies, it is transmitted as a force system collectively to the entire connected geometry.

Units are force units (typically **N** in SI).



Distributed Forces can be applied to the following types of supports:

Geometrical Feature	Mechanical Feature	Analysis Feature			
		Free Groups	Geometrical Groups	Proximity Groups	Others
Point/Vertex Edge Face (homogeneous selection)					Virtual Part



Open the [sample00.CATAnalysis](#) document from the samples directory for this task: [Finite Element Model](#) containing a Static Analysis Case and computed corresponding [Static Solution](#).

**Before You Begin:**

Go to **View -> Render Style -> Customize View** and make sure the **Shading, Outlines** and **Materials** options are active in the Custom View Modes dialog box.



1. Click the **Distributed Force** icon .

The Distributed Force dialog box appears.

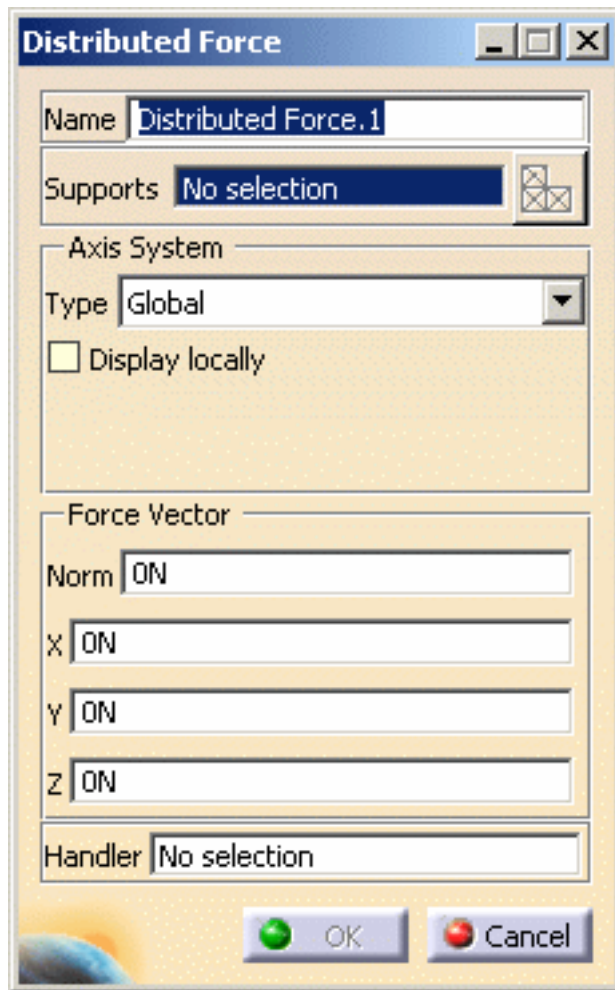

2. If needed, change the identifier of the Distributed Force by editing the **Name** field.
3. Set the **Axis System Type**.

The **Axis System Type** combo box allows you to choose between **Global** and **User** Axis systems, for entering components of the resultant force vector.

- **Global:** if you select the **Global** Axis system, the components of the resultant force vector will be interpreted as relative to the fixed global rectangular coordinate system.
- **User:** if you select a **User** Axis system, the components of the resultant force vector will be interpreted as relative to the specified rectangular coordinate system.  
To select a **User** Axis system, you must activate an existing Axis by clicking it in the specification tree. Its name will then be automatically displayed in the **Current Axis** field.



- You can define the resultant force vector direction by using the compass.
- You can modify the compass orientation either with the mouse or by editing the compass.
- By applying the compass to any part geometry, you can align the compass directions with the implicit axis directions of that geometry: drag the compass by handling the red square and drop it on the appropriate surface. The normal direction to this surface defines the new direction. Then, click on the Compass Direction button to take this new direction into account. You can now invert the direction if desired, editing the values of the three components.

**4.** Enter values for the **X**, **Y**, **Z** components of the resultant force vector.

For example, enter **-50N** as **Z** value.

The remaining three fields are automatically computed and displayed.

The visualized symbols orientation will also reflect the modification, once the support will be selected.

**5.** Select the support (a virtual part or a geometry) on which the resultant force vector is applied at the pre-defined point.

Any selectable geometry is highlighted when you pass the cursor over it.

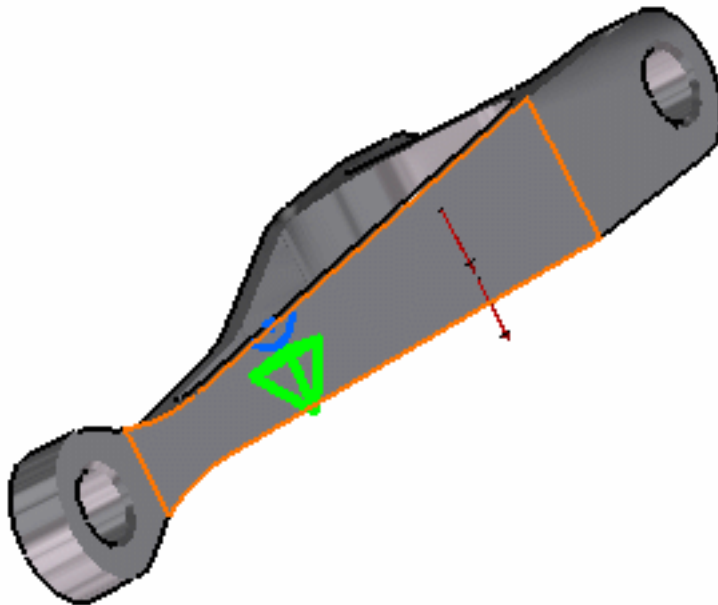

You can select several supports in sequence, to apply the Distributed Force to all supports simultaneously.



A symbol representing the resultant force equivalent to the Distributed Force is displayed at the application point of the support to visualize the input force system.

The Distributed Force dialog box now appears as shown here:

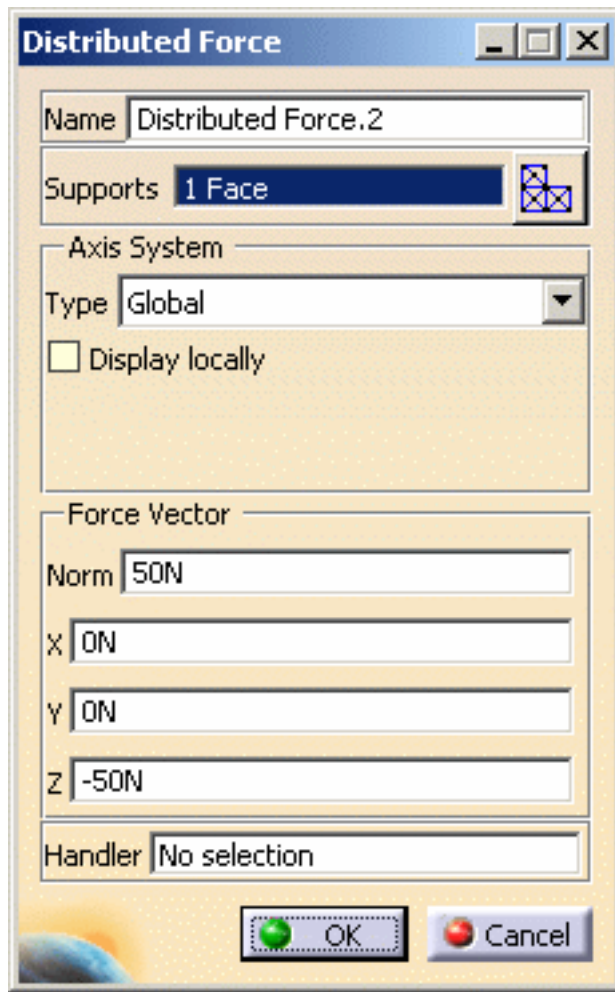

6. Optionally, select a point as **Handler**.
7. Click **OK** in the Distributed Force dialog box.

A **Distributed Force** object appears in the specification tree under the active **Loads** objects set.

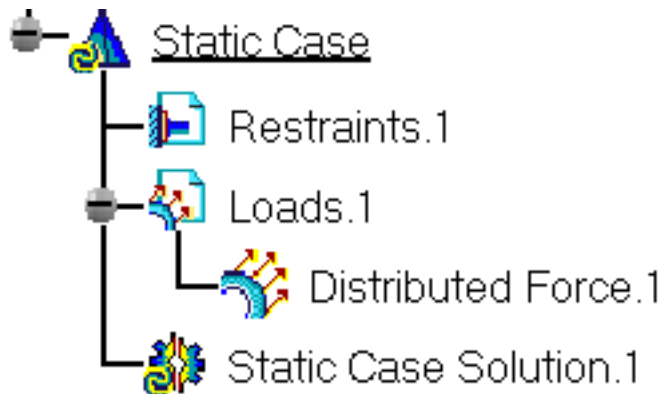

- Make sure the computation is finished before starting any of the following operations.
- Be aware that the Distributed Force, as the Distributed Moment, applies directly to the nodes of the selected entity, whereas a Surface Density Force, or a Pressure, applies to the element faces of the selected entity. The latter type of forces is far more accurate and should be used whenever equivalent to the Distributed Force.

As an example, consider a coarsely meshed cylinder whose top surface has been submitted to a Distributed Force and whose bottom surface is clamped. As the nodes on the edges have less neighbors than inner nodes, they are pulled a lot further than the inner nodes, thus leading to an erroneous result near the edges. Mesh refinement is needed to get proper results. On the contrary, the Surface Density Force leads to a smoother and more accurate displacement.



Open [DistribForce.CATAnalysis](#) in this particular case.

[Applying a Distributed Force results as shown here:](#)

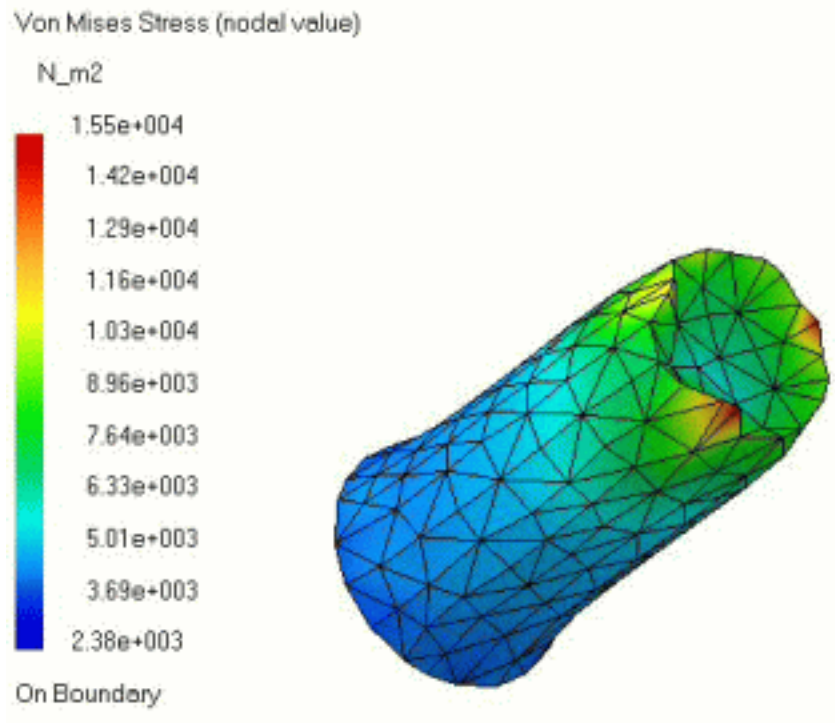

Applying a Surface Density Force results as shown here:

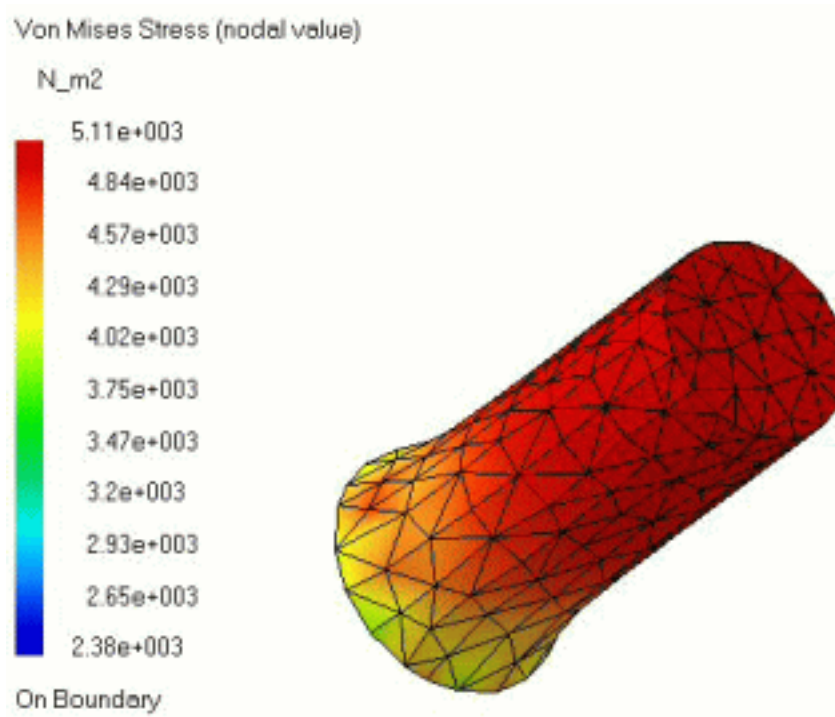





- You can either select the support and then set the Distributed Force specifications, or set the Distributed Force specifications and then select the support.
- If you select several geometric supports, you can create as many Distributed Forces as desired with the same dialog box. A series of Distributed Forces can therefore be created quickly. The point of application is automatically assumed to be the centroid of the system of individual supports centroids.
- Loads are required for Stress Analysis computations.
- If several Analysis Cases have been defined in the Finite Element Model, you must activate a Loads objects set in the features tree before creating a Distributed Force object.
- Distributed Force objects can be edited by a double click on the corresponding object or icon in the features tree.



### Products Available in Analysis Workbench

The **ELFINI Structural Analysis** product offers the following additional features with a right mouse click (key 3):

-  on a **Body Force** object:
  - **Distributed Force Visualization on Mesh:** the translation of your Distributed Force object specifications into solver specifications can be visualized symbolically at the impacted mesh nodes, provided the mesh has been previously generated via a Compute action.
-  on a **Loads objects** set:
  - **Generate Image:** generates an image of the computed Load objects (along with translating all user-defined Loads specs into explicit solver commands on mesh entities), by generating symbols for the elementary loads imposed by the Loads objects set. The image can be edited to include part or all of the options available.
  - **Report:** the partial status and results of intermediate pre-processor computations are reported in HTML format. It represents a subset of the global Report capability and generates a partial report of the Loads objects set Computation. See [Creating Pressures](#) for more details.
  - **Double-clicking** on the Loads set, you will display the Loads dialog box that lets you choose whether you wish to apply self-balancing to the load. Example of use: if this option is used with iso-static specifications, it will allow you to simulate free-body loading. If you make the option active, the center of inertia results null.



# Creating Moments



This task shows you how to create a Moment applied to a virtual part or to a geometry selection.



*Moments* are force systems statically equivalent to a given pure couple (single moment resultant), distributed on a virtual part or on a geometric selection.

Moment objects belong to Loads objects sets.

The user specifies three components for the direction of the resultant moment, along with a magnitude information. Upon modification of any of these four values, the resultant moment vector components and magnitude are updated based on the last data entry. The resultant moment vector remains constant independently of the geometry selection.

The given pure couple system is processed by the program as follows:

- In the case of extended geometries, it is transformed into an equivalent force system distributed over the selected support.
- In the case of virtual parts connected to deformable bodies, it is transmitted as a force system collectively to the entire connected geometry.

The point of application of the couple is arbitrary.

Units are moment units (typically **Nm** in SI).



Moments can be applied to the following types of supports:

Geometrical Feature	Mechanical Feature	Analysis Feature			
		Free Groups	Geometrical Groups	Proximity Groups	Others

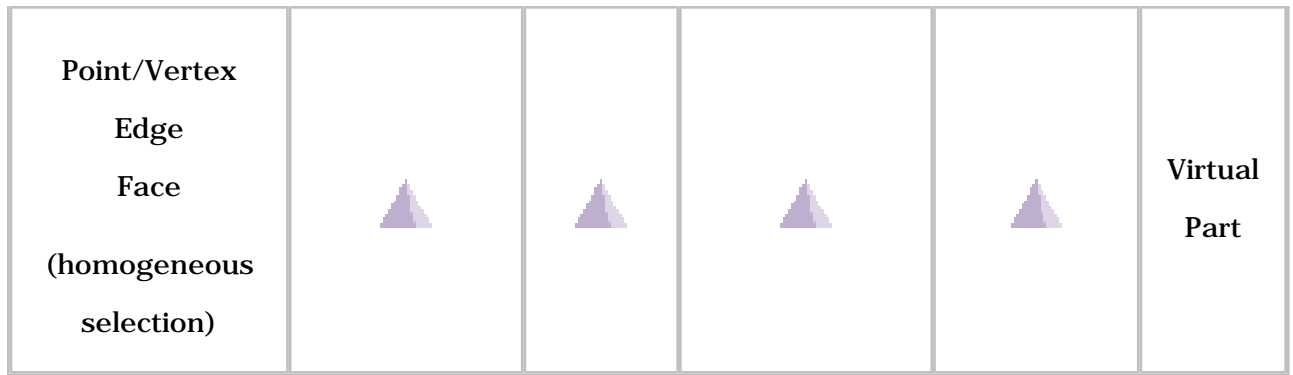

Open the [sample00.CATAnalysis](#) document from the samples directory for this task: [Finite Element Model](#) containing a Static Analysis Case and computed corresponding [Static Solution](#).

**Before You Begin:**

Go to **View -> Render Style -> Customize View** and make sure the **Shading**, **Outlines** and **Materials** options are active in the Custom View Modes dialog box.



1. Click the **Moment** icon .

The Moment dialog box appears.

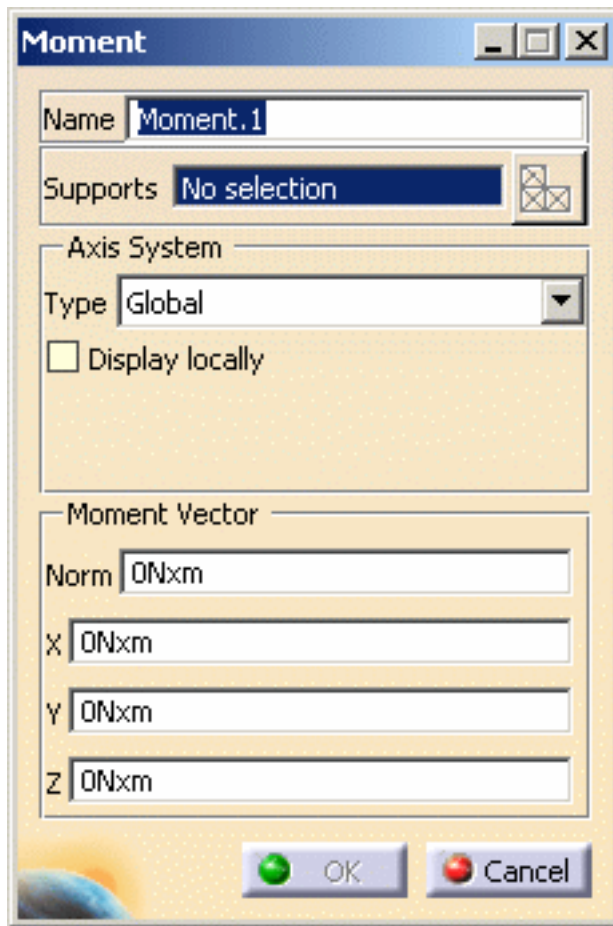

2. You can change the identifier of the Moment by editing the **Name** field.
3. Set the Axis system.

The **Axis System Type** combo box allows you to choose between **Global** and **User** Axis systems, for entering components of the resultant moment vector.

- **Global**: if you select the Global Axis system, the components of the resultant moment vector will be interpreted as relative to the fixed global rectangular coordinate system.
- **User**: if you select a User-defined Axis system, the components of the resultant moment vector will be interpreted as relative to the specified rectangular coordinate system.

To select a **User Axis System**, you must activate an existing Axis by clicking it in the specification tree. Its name will then be automatically displayed in the **Current Axis** field.



- You can define the resultant moment vector direction by using the compass.
- You can modify the compass orientation either with the mouse or by editing the compass.
- By applying the compass to any part geometry, you can align the compass directions with the implicit axis directions of that geometry: drag the compass by handling the red square and drop it on the appropriate surface. The normal direction to this surface defines the new direction. Then, click on the Compass Direction button to take this new direction into account. You can now invert the direction if desired, editing the values of the three components.

4. Select the support (a virtual part or a geometry) on which the resultant moment vector is applied.

Any selectable geometry is highlighted when you pass the cursor over it.

You can select several supports in sequence, to apply the Moment to all supports simultaneously.

A symbol representing the resultant moment equivalent to the Moment is displayed at the application point of the support to visualize the input force system.

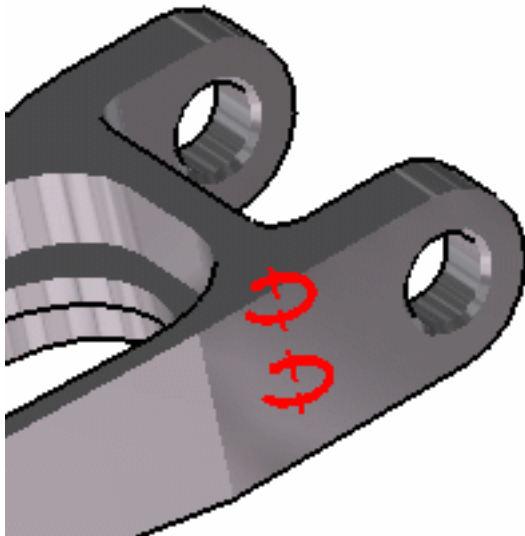

5. Enter values for the **X**, **Y**, **Z** components of the resultant moment vector: the corresponding **Norm** value is automatically computed and displayed.

The visualized symbols orientation is also updated to reflect the modification.



6. Click **OK** in the Moment dialog box.

A **Moment** object appears in the specification tree under the active **Loads** objects set.

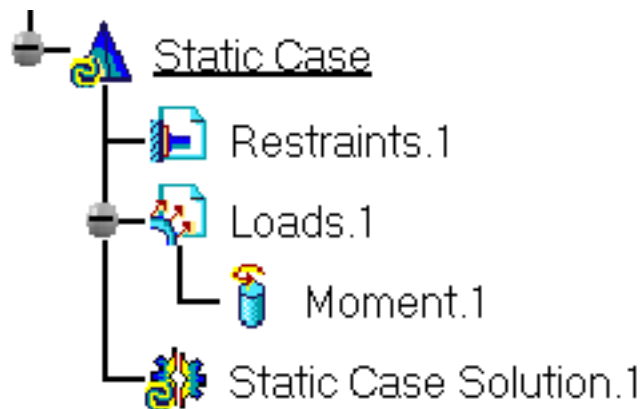

- You can either select the support and then set the Moment specifications, or set the Moment specifications and then select the support.
- If you select several geometric supports, you can create as many Moment loads as desired with the same dialog box. A series of Moments can therefore be created quickly.
- Loads are required for Stress Analysis computations.
- If several Analysis Cases have been defined in the Finite Element Model, you must activate a Loads objects set in the specification tree before creating a Moment object (only available if you have **ELFINI Structural Analysis** product installed).
- Moment objects can be edited by a double click on the corresponding object or icon in the specification tree.





Make sure the computation is finished before starting any of the following operations.



### Products Available in Analysis Workbench

The **ELFINI Structural Analysis** product offers the following additional features with a right mouse click (key 3):

-  on a **Moment** object:
  - **Moment Visualization on Mesh:** the translation of your Moment object specifications into solver specifications can be visualized symbolically at the impacted mesh nodes, provided the mesh has been previously generated via a Compute action.

-  on a **Loads objects** set:
  - **Generate Image:** generates an image of the computed Load objects (along with translating all user-defined Loads specs into explicit solver commands on mesh entities), by generating symbols for the elementary loads imposed by the Loads objects set. The image can be edited to include part or all of the options available.
  - **Report:** the partial status and results of intermediate pre-processor computations are reported in HTML format. It represents a subset of the global Report capability and generates a partial report of the Loads objects set Computation. See [Creating Pressures](#) for more details.
  - **Double-clicking** on the Loads set, you will display the Loads dialog box that lets you choose whether you wish to apply self-balancing to the load. Example of use: if this option is used with iso-static specifications, it will allow you to simulate free-body loading. If you make the option active, the center of inertia results null.



# Creating a Bearing Load



This task shows you how to create a Bearing Load applied to a selected geometry.



Only available with the **ELFINI Structural Analysis (EST)** product.



*Bearing Loads* are simulated contact loads applied to cylindrical parts.

Creating Bearing Loads is done in only one step and is much quicker than creating first a virtual part and then a load. Computation is also much less time-consuming, because Bearing Loads do not generate either costly contact beam elements or virtual mesh parts.

The user selects a cylindrical boundary of the part. Any type of revolution surface can be selected. In the Bearing Load definition panel, you have to specify the resulting contact force (direction and norm). The components of the force can be given either in the global or in a user axis system (similar to the Distributed Force).

Bearing Loads are flexible: You can vary the angle sector on which the force is applied as well as the type of the profile distribution.

***Display of the applied sinusoidal traction:***

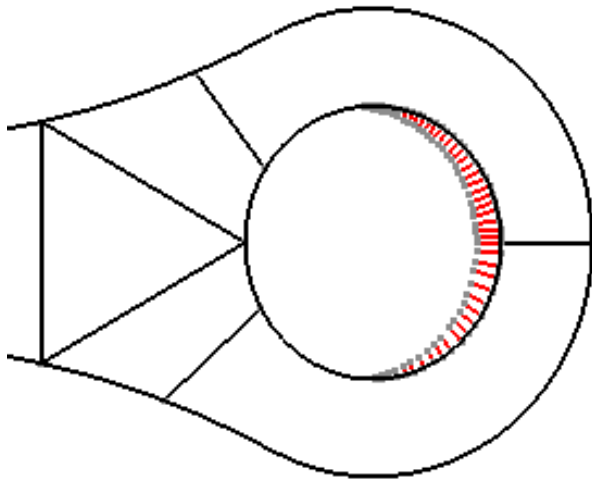

Bearing Loads objects belong to Loads objects sets.



Bearing Loads can be applied to the following types of supports:

Geometrical Feature	Mechanical Feature	Analysis Feature			
		Free Groups	Geometrical Groups	Proximity Groups	Others
Cylindrical Surface					
Cone					
Revolution Surface					



Open the [sample02.CATAnalysis](#) document from the samples directory for this task.

**Before You Begin:**

Go to **View -> Render Style -> Customize View** and make sure the **Shading, Outlines** and **Materials** options are active in the Custom View Modes dialog box.



1. Click the **Bearing Load** icon .

The Bearing Load dialog box appears.

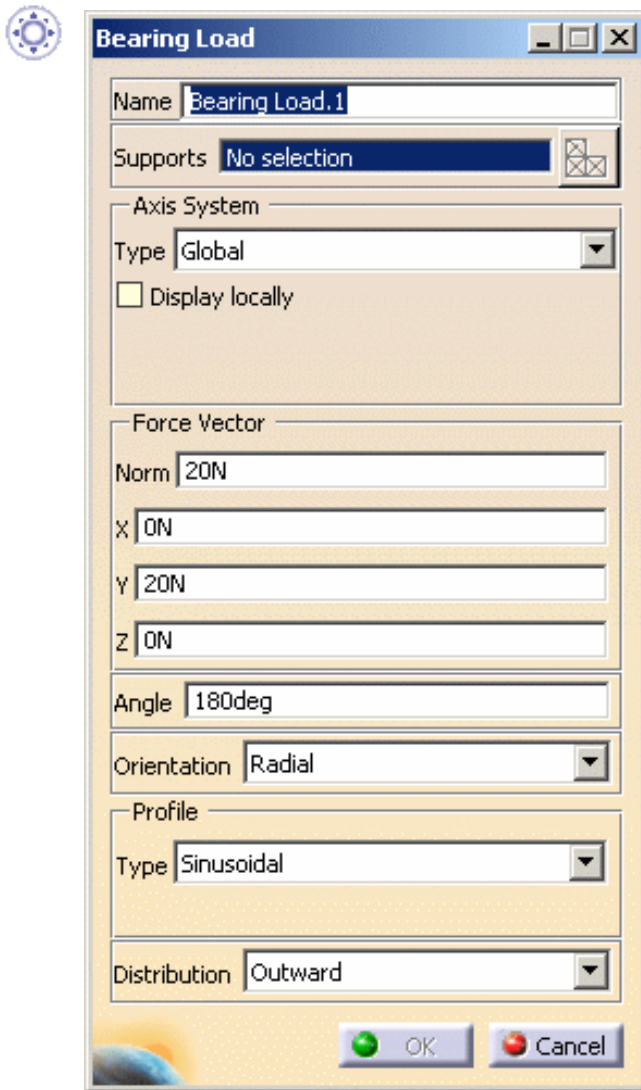

- o **Name:** lets you modify the name of the load.
- o **Supports:** lets you select cylindrical surfaces on which you want to apply a bearing load. Multi-selection is available.



Multi-selection must be used on different cylindrical surfaces and not on different elements belonging to a same cylindrical surface.

Indeed, if you apply a **10N** norm force vector on a multi-selection of three surfaces belonging to the same geometry, the norm of the global resultant force will be equal to **30N** (and not **10N**).

To apply a **10N** norm force vector on three different cylindrical surfaces, the following methods are equivalent:

- create three bearing loads (select one cylindrical surface for each bearing load) with a **10N** norm force vector
  - create one bearing load (multi-select three cylindrical surfaces) with a **10N** norm force vector
- **Axis System Type:** allows you to choose between **Global** and **User** Axis systems, for entering components of the resultant force vector.
- **Global:** if you select the **Global** Axis system, the components of the resultant force vector will be interpreted as relative to the fixed global rectangular coordinate system.
  - **User:** if you select a **User** Axis system, the components of the resultant force vector will be interpreted as relative to the specified rectangular coordinate system.  
To select a **User** Axis system, you must activate an existing Axis by clicking it in the specification tree. Its name will then be automatically displayed in the **Current Axis** field.  
Only the Force vector component which is perpendicular to the revolution axis is taken into account because this component is a contact component.
- **Angle:** corresponds to the angle over which the forces can be distributed. When entering an angle value, a highly precise preview automatically appears on the model. **180** is the default value, **< 180** is useful to take into account some positive clearance, **> 180** is useful to take into account some negative clearance.
- **Orientation:** provides you with two ways for distributing forces:
- **Radial:** all the force vectors at the mesh nodes are normal to the surface in all points. This is generally used for force contact.
  - **Parallel:** all the force vectors at the mesh nodes are parallel to the resulting force vectors. This can be useful in the case of specific loads.

Radial:

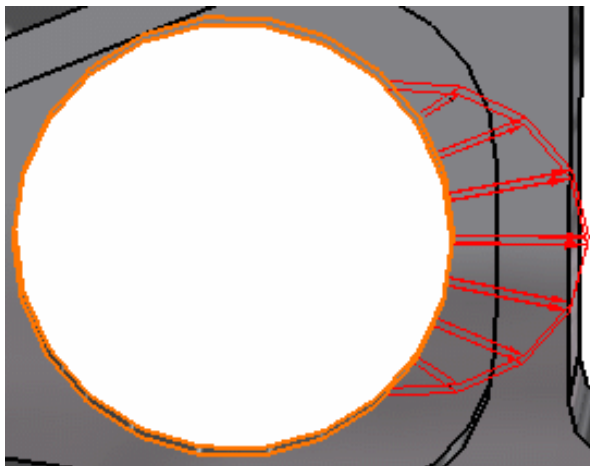

Parallel:

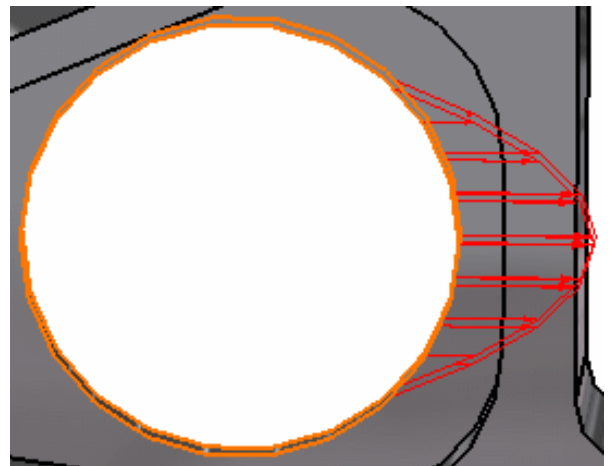

- **Profile:** can be **Sinusoidal**, **Parabolic** or **Law** type, defining how you will vary the Force intensity according to the angle: **Sinusoidal**, **Parabolic** or **Law**.
  - **Law:** or  $F=f(\theta)$  requires that a formal law (Formal parameters) was defined in Knowledge Advisor (Fog). On the condition you previously activated the **Relations** option in **Tools -> Options -> Part Design (Display tab)** command, you can see the Law feature in the specification tree. No sooner do you select this feature in the specification tree, that this formal parameter appears in the Law field (Bearing Load dialog box).



- **Distribution:** lets you specify the force distribution.

- **Outward:**

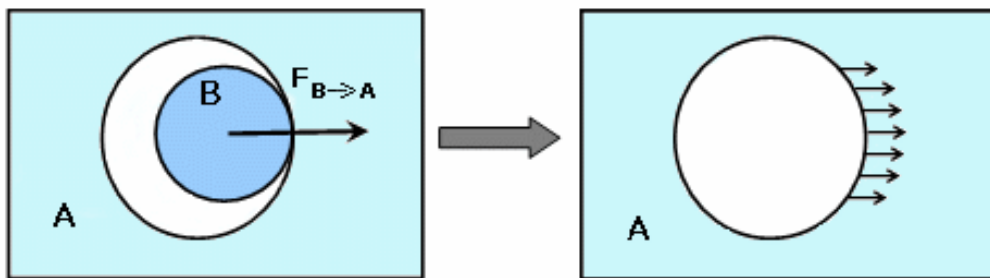

B pushes on A

In this particular example, the result is the following:

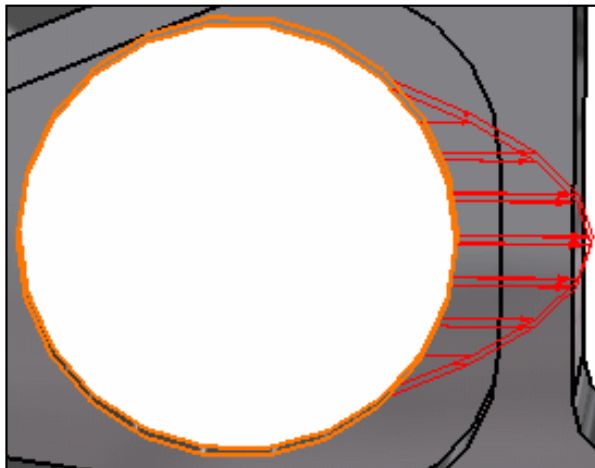

- **Inward:**

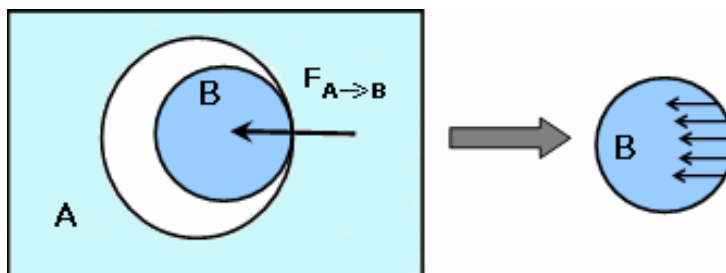

A pushes on B

In this particular example, the result is the following:

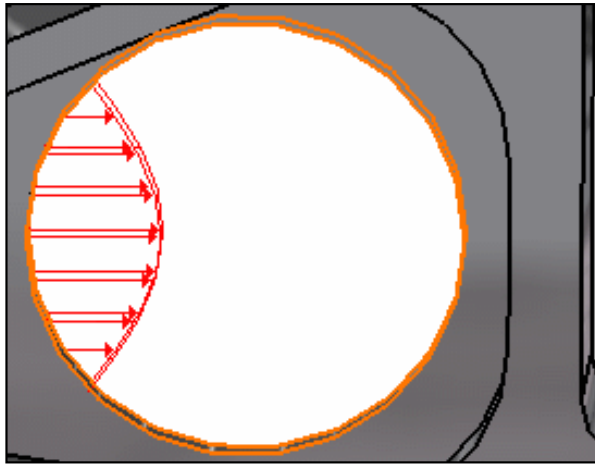

2. You can change the identifier of the Bearing Load by editing the **Name** field.
3. Select **Global** as **Axis System Type**.
4. Enter values for the **X**, **Y**, **Z** components of the resultant force vector.  
For example, enter **-500N** as **X** value.

The corresponding **Norm** value is automatically computed and displayed.



- o You can define the resultant force vector direction by using the compass.
- o By applying the compass to any part geometry, you can align the compass directions with the implicit axis directions of that geometry: drag the compass by handling the red square and drop it on the appropriate surface. The normal direction to this surface defines the new direction. Then, click on the Compass Direction button to take this new direction into account. You can now invert the direction if desired, editing the values of the three components.

5. Enter a value for the **Angle** parameter. For example, enter **90deg** as **Angle** value.
6. Select the support (a geometry) on which the resultant Bearing Load vectors are applied.

Any selectable geometry is highlighted when you pass the cursor over it.

Selected support:

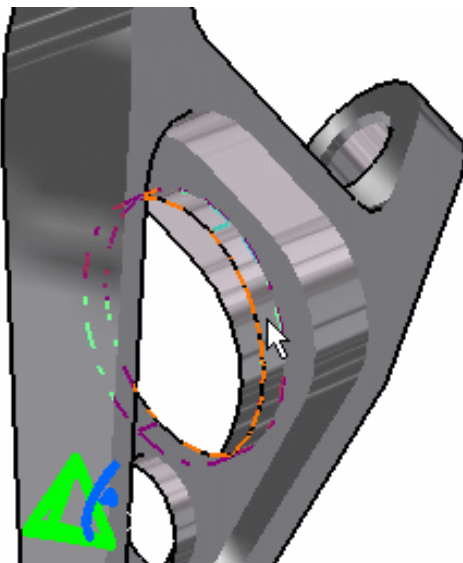

Resultant load:

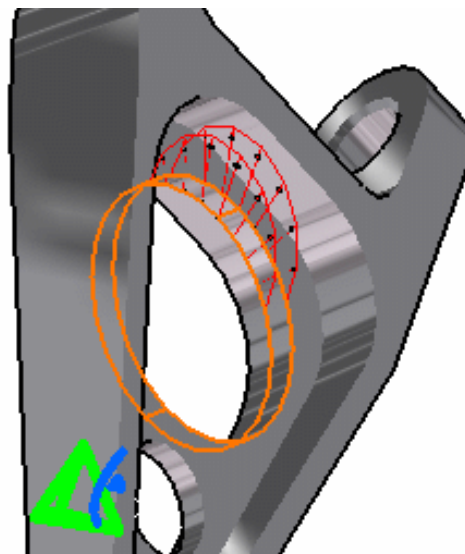

7. Select the following options:
  - o **Radial** as **Orientation** option,
  - o **Parabolic** as **Profile Type** option,
  - o **Outward** as **Distribution** option.
8. Click **OK** in the Bearing Load dialog box.

A **Bearing Load** object appears in the specification tree under the active **Loads** objects set.

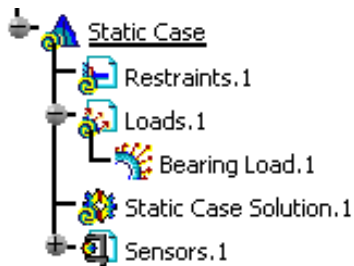

- You can either select the support and then set the Bearing Load specifications, or set the Bearing Load specifications and then select the support.
- Loads are required for Stress Analysis computations.
- If several Analysis Cases have been defined in the Finite Element Model, you must activate a Loads objects set in the specification tree before creating a Bearing Load object.
- Bearing Load objects can be edited by a double click on the corresponding object or icon in the specification tree.

Make sure the computation is finished before starting any of the following operations.

### Products Available in Analysis Workbench

The **ELFINI Structural Analysis** product offers the following additional features with a right mouse click (key 3):

- **iEST** on a **Bearing Load** object:
  - o **Bearing Load Visualization on Mesh:** the translation of the Bearing Load specifications into solver specifications can be visualized symbolically at the impacted mesh nodes, provided the mesh has been previously generated via a Compute action.
- **iEST** on a **Loads objects** set:
  - o **Generate Image:** generates an image of the computed Load objects (along with translating all user-defined Loads specs into explicit solver commands on mesh entities), by generating symbols for the elementary loads imposed by the Loads objects set. The image can be edited to include part or all of the options available.
  - o **Report:** the partial status and results of intermediate pre-processor computations are reported in HTML format. It represents a subset of the global Report capability and generates a partial report of the Loads objects set Computation. See [Creating Pressures](#) for more details.
  - o **Self-balancing:** you can double-click the **Loads** set to automatically add inertia forces in order to counter balance external loads. For details, please click [here](#).





# Importing Forces



This task shows you how to import forces from a .xls file:

- on a surface
- on a virtual part

*Importing forces from a text file* means importing and mapping force data from a text or excel file. This force data can be either force extrapolated on the nodes of the closest element or force directly applied on the associated node. This allows transferring light data.



Only available with the **ELFINI Structural Analysis (EST)** product.



Imported forces can be applied to the following types of supports:

Geometrical Feature	Mechanical Feature	Analysis Feature			
		Free Groups	Geometrical Groups	Proximity Groups	Others
Point/Vertex Face		▲	▲	▲	

## On a Surface



In this particular case, open the [sample53.CATAnalysis](#) document from the samples directory.

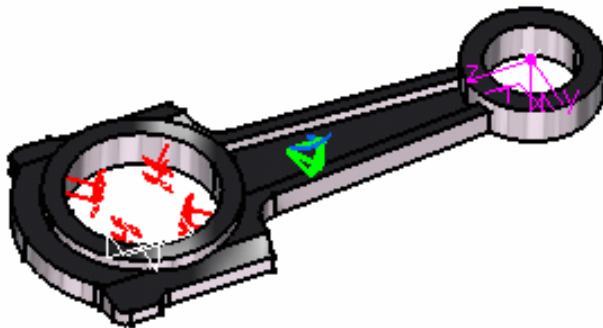

### Before You Begin:

Go to **View -> Render Style -> Customize View** and make sure the **Shading, Outlines** and **Materials** options are active in the Custom View Modes dialog box.



1. Click the **Imported Force** icon .

The Imported Forces dialog box appears.

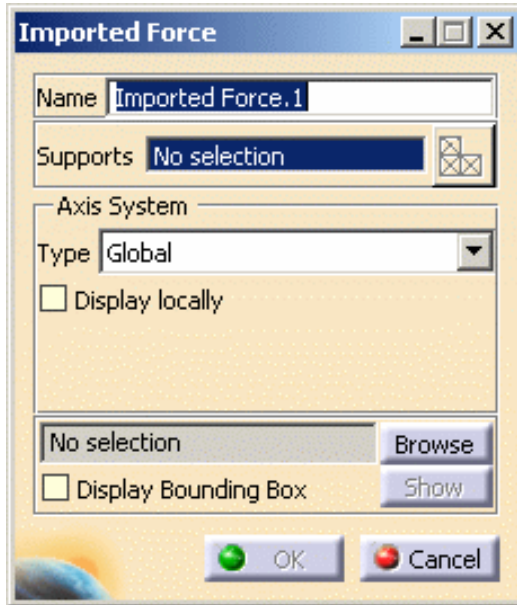

- o **Name**
- o **Supports**
- o **Axis System:** The **Axis System Type** combo box allows you to choose between **Global** and **User** Axis systems, for entering components of the resultant force vector.
  - **Global:** if you select the **Global** Axis system, the components of the force vector (in a file) will be interpreted as relative to the fixed global rectangular coordinate system.
  - **User:** if you select a **User** Axis system, the components of the force vector (in a file) will be interpreted as relative to the specified rectangular coordinate system. To select a **User** Axis system, you must activate an existing Axis by clicking it in the specification tree. Its name will then be automatically displayed in the **Current Axis** field. If you select the User Type, the following options are available:

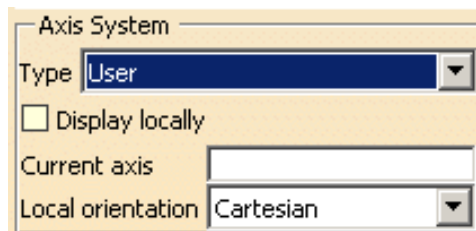

- o **File Selection:** use the **Browse** button.
- o **Display Bounding Box,** if needed, on the model.

2. Select the surface as the **Support** on which you want to import the Force.

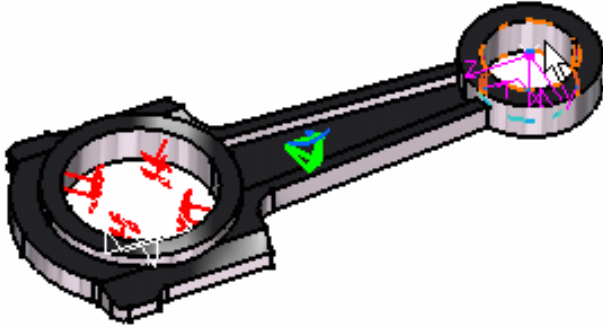

3. Click the **Browse** button in the Imported Forces dialog box to select the file to be imported.

The File Selection dialog box appears to let you choose the file to be imported. In this particular case, select **Data.xls** file.

4. Once the File name has been selected, click **Open** in the File Selection dialog box.

The Imported Forces dialog box is updated.

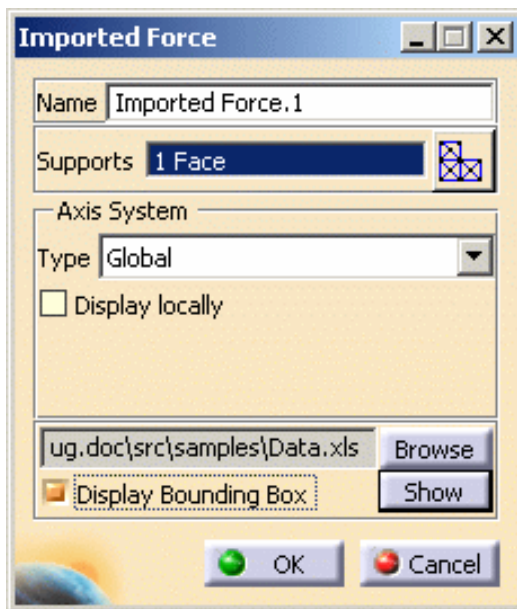

5. If needed, click the **Show** button to display the Imported Table dialog box corresponding to the selected file data.

In this particular case, the imported table appears as shown here:

X(mm)	Y(mm)	Z(mm)	Fx(N)	Fy(N)	Fz(N)
-167	0.0000000000175078	15	0.0423091	1.60566	0.113629
-167	0.0000000000175078	6.97443E-15	-0.0768273	1.58255	-0.100305
-133	0.0000000000175078	15	8.56993	-36.1512	25.6339
-133	0.0000000000175078	6.97443E-15	42.0573	180.965	-4.77655
-175	0.0000000000175078	0.0000000000000194...	0	0	0
-128.057	11.9793	0.000000000000015456	0	0	0
-175	0.0000000000175078	15	0	0	0
-125	0.0000000000175078	15	0	0	0
-125	0.0000000000175078	5	0	0	0
-126.029	7.09701	5	0	0	0
-126.029	7.09701	10	0	0	0
-128.057	11.9793	10	0	0	0

- Click **Close** in the Imported Table box.
- In this particular case, we also decided to activate the **Display bounding box** (as shown in the dialog box above).

The model appears as shown here:

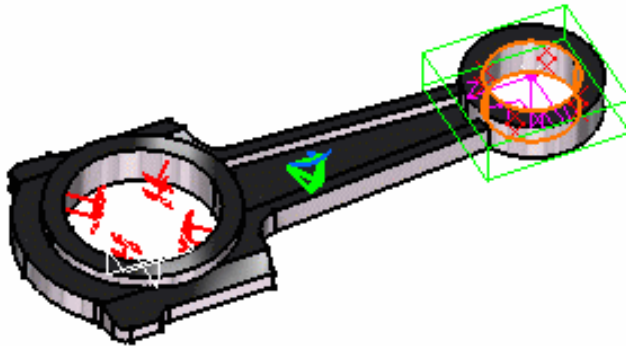

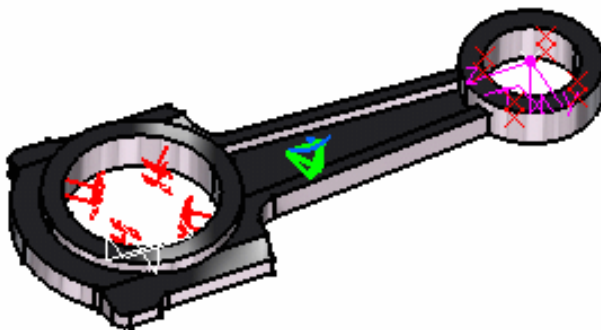

- Click **OK** in the Imported Forces dialog box.

The resulting model appears as shown here:

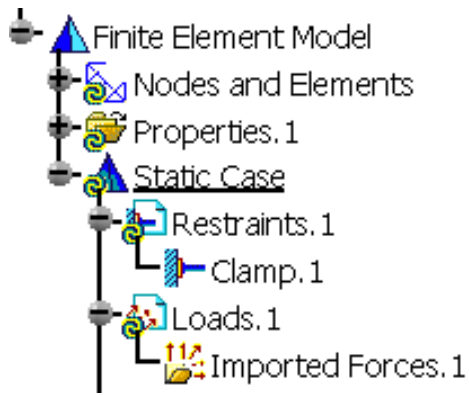

The **Imported Forces.1** feature is displayed in the specification tree.



 For each point in the data file, the corresponding force is distributed on the three closest nodes of the selected support.

If the point coordinates correspond to a node, the force is directly applied on it.

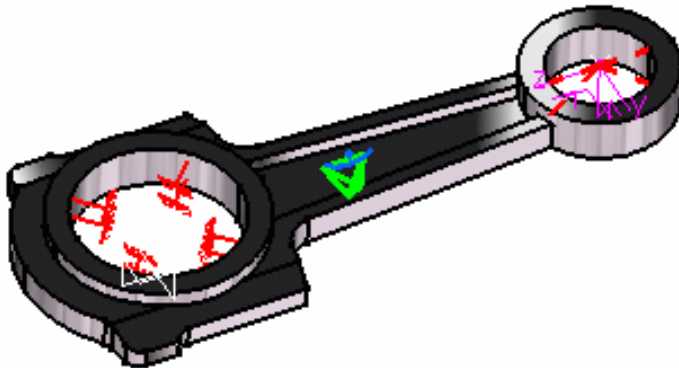

## On a Virtual Part

 In this particular case, open the [sample54.CATAnalysis](#) document from the samples directory.



### Before You Begin:

Go to **View -> Render Style -> Customize View** and make sure the **Shading, Outlines** and **Materials** options are active in the Custom View Modes dialog box.

- 
1. Click the **Imported Force** icon .
  2. Select a vertex as **Support**.

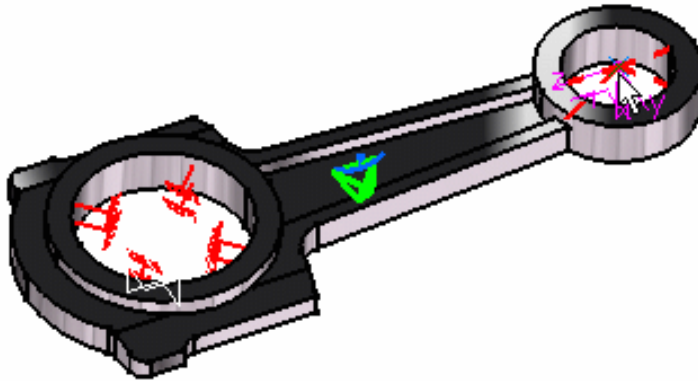

The Imported Forces dialog box now appears as shown here:

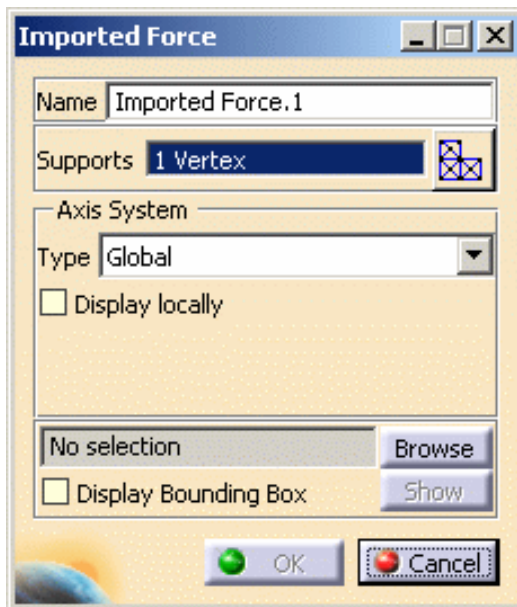

3. Click the Browse button to select the file to be imported.

The File Selection dialog box appears to let you choose the file to be imported. In this particular case, select **Data.xls** file.

4. Once the File name has been selected, click **Open** in the File Selection dialog box.

The Imported dialog box is updated.

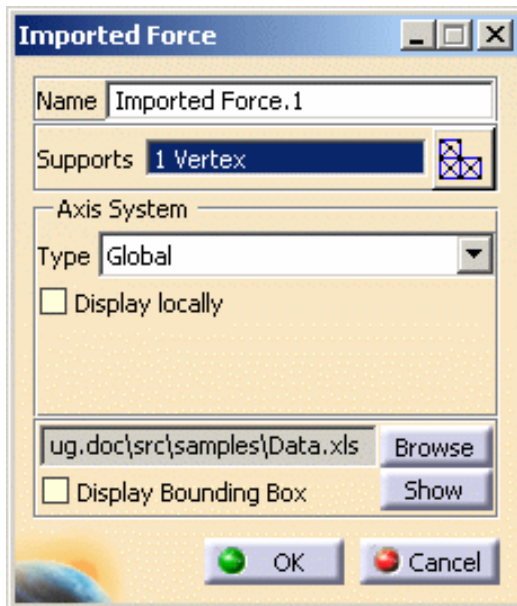

5. If needed, click the **Show** button to display the Imported Table box corresponding to the selected file data.

In this particular case, the imported table appears as shown here:

X(mm)	Y(mm)	Z(mm)	Fx(N)	Fy(N)	Fz(N)
-167	0.0000000000175078	15	0.0423091	1.60566	0.113629
-167	0.0000000000175078	6.97443E-15	-0.0768273	1.58255	-0.100305
-133	0.0000000000175078	15	8.56993	-36.1512	25.6339
-133	0.0000000000175078	6.97443E-15	42.0573	180.965	-4.77655
-175	0.0000000000175078	0.0000000000000194...	0	0	0
-128.057	11.9793	0.000000000000015456	0	0	0
-175	0.0000000000175078	15	0	0	0
-125	0.0000000000175078	15	0	0	0
-125	0.0000000000175078	5	0	0	0
-126.029	7.09701	5	0	0	0
-126.029	7.09701	10	0	0	0
-128.057	11.9793	10	0	0	0

6. Click **Close** in the Imported Table box.
7. Click **OK** in the Imported Forces dialog box.

The model appears as shown here:

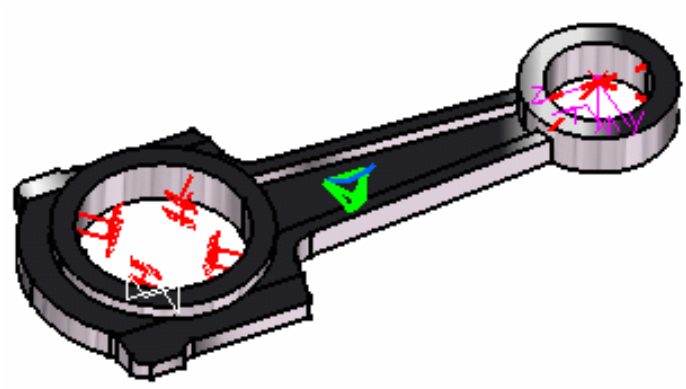

 Note that for each point in the data file, the corresponding force is directly applied on the closest point handler of a virtual part.





# Importing Moments



This task shows you how to import moments from a text file on a surface.

*Importing moment from a text file* means importing and mapping moment data from a text or excel file. Moments can be imported on surfaces, exclusively.



Only available with the **ELFINI Structural Analysis (EST)** product.



Imported moments can be applied to the following types of supports:

Geometrical Feature	Mechanical Feature	Analysis Feature			
		Free Groups	Geometrical Groups	Proximity Groups	Others
Point/Vertex Face					



Open the [sample55.CATAnalysis](#) document from the samples directory for this task.

## Before You Begin:

Go to **View -> Render Style -> Customize View** and make sure the **Shading** and **Outlines** options are active in the Custom View Modes dialog box.



1. Click the **Imported Moment** icon .

The Imported Moments dialog box appears.

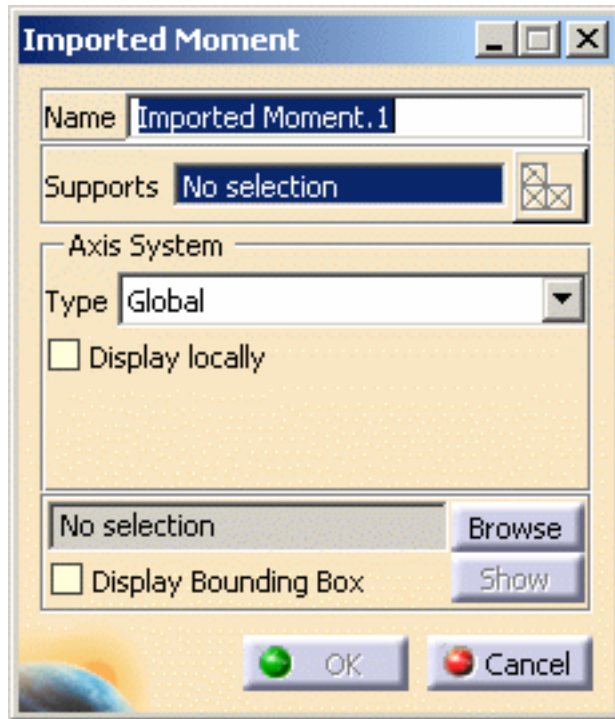

- **Name**
- **Supports**
- **Axis System:** The **Axis System Type** combo box allows you to choose between **Global** and **User** Axis systems, for entering components of the resultant moment vector.
  - **Global:** if you select the **Global** Axis system, the components of the moment vector (in a file) will be interpreted as relative to the fixed global rectangular coordinate system.
  - **User:** if you select a **User** Axis system, the components of the moment vector (in a file) will be interpreted as relative to the specified rectangular coordinate system.  
To select a **User** Axis system, you must activate an existing Axis by clicking it in the specification tree. Its name will then be automatically displayed in the **Current Axis** field.



If you select the User Type, the following options are available:

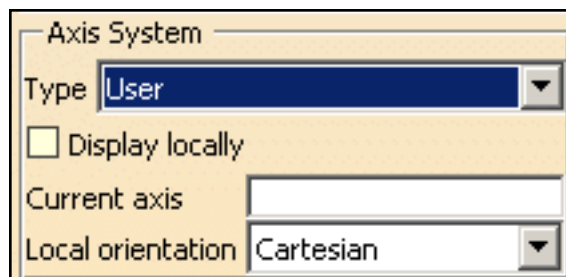

- File Selection: use the **Browse** button.
- **Display Bounding Box**, if needed, on the model.

**2.** Select a surface as **Support**.

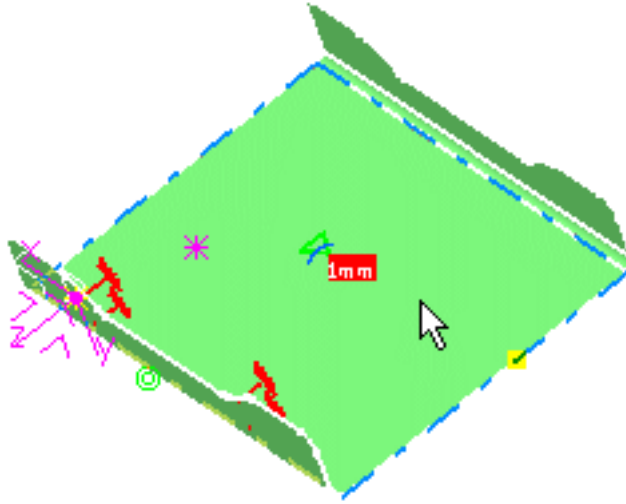

**3.** Click the **Browse** button in the Imported Moment dialog box to select the file to be imported.

The File Selection dialog box appears to let you choose the file to be imported. In this particular case, select **DataFile.xls** file from the samples directory.

**4.** Once the File name has been selected, click **Open** in the File Selection dialog box.

The Imported Moments dialog box is updated.

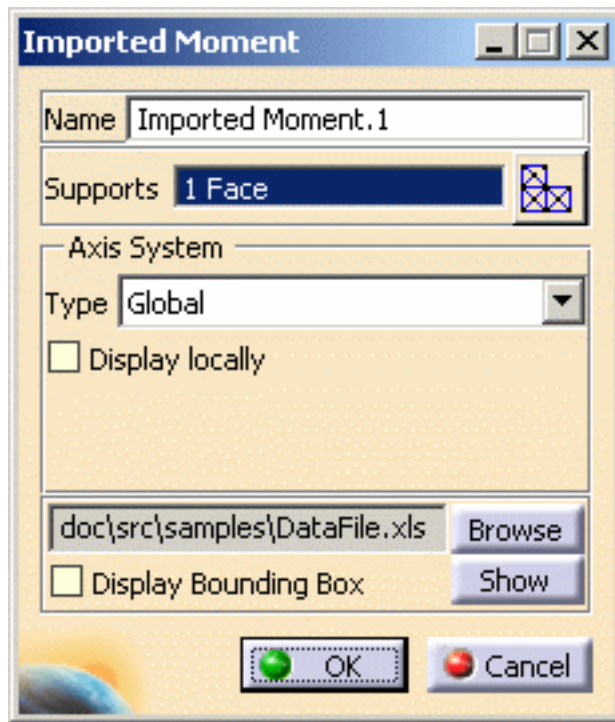

5. If needed, click the **Show** button to display the Imported Table box corresponding to the selected file data.

In this particular case, the imported table appears as shown here:

X(mm)	Y(mm)	Z(mm)	Mx(Nxm)	My(Nxm)	Mz(Nxm)
3950.41	-2.83764	-2352.19	0	0	0
4024.5	4879.44	-2352.19	0	0	0
3849.53	-59.8922	-1511.06	0	0	0
3925.4	4939.53	-1511.06	0	0	0
4025.39	4938.01	-1611.06	0.540433	-2.76279	-0.582291
3949.52	-61.4095	-1611.06	0.703057	2.27023	-0.668529
4025.39	4938.01	-2210.77	0	0	0
4022.35	4738.04	-2410.77	0	0	0
4011.06	3993.51	-2410.77	0	0	0
4009.5	3890.64	-2382.28	0	0	0
4001.79	3383.17	-2111.06	0	0	0

6. Click **Close** in the Imported Table box.
7. In this particular case, we also decided to activate the **Display bounding box** (as

shown in the dialog box above).

The model appears as shown here: the face to be used as support for the imported moment is bounded.

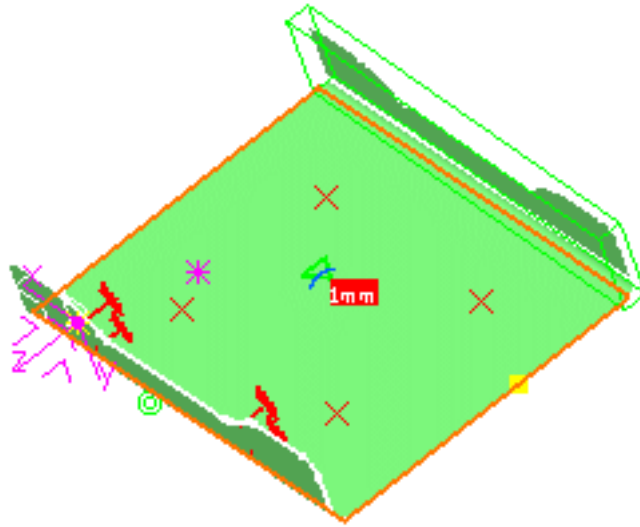

8. Click **OK** in the Imported Moments dialog box.

The resulting model appears as shown here:

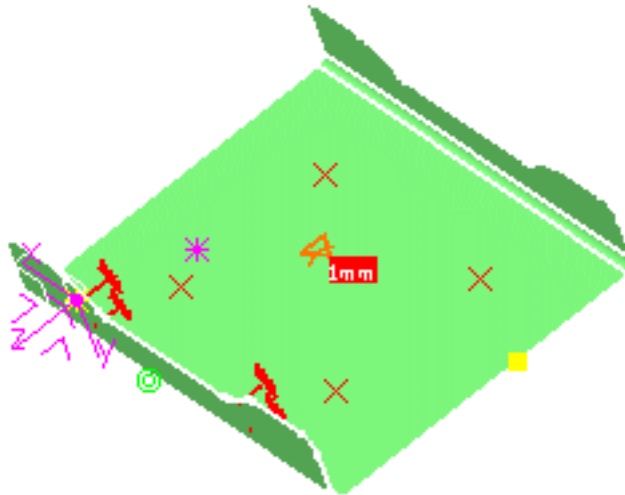

The **Imported Moments.1** feature is displayed in the specification tree.

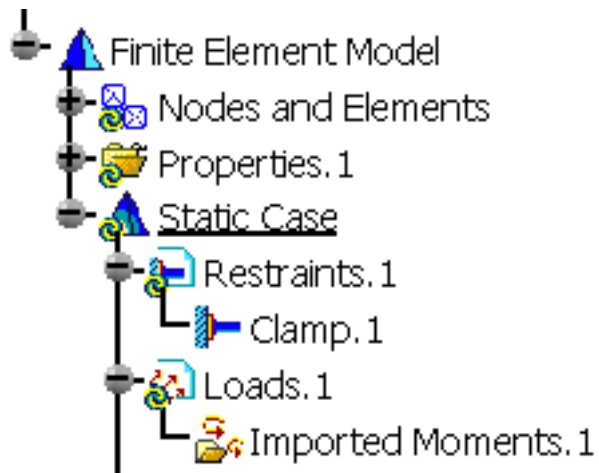

For each point in the data file, the corresponding moment is distributed on the three closest nodes of the selected support. If the point coordinates correspond to a node, the moment is directly applied on it.

The moments are converted into equivalent forces.

Imported moments works differently depending of the kind of support selected :

- If selected supports are surfaces: imported moments works the same way imported moments do, except that moments are converted to equivalent moments distributed on the three closest nodes. Be aware that if the data file point coordinates corresponds to a node, the moment won't be applied on the node but converted to moments on the closest nodes.
- If selected supports are points or vertices: moments will be directly applied on the closest node.



# Creating Line Force Densities



This task shows you how to create a Line Force Density applied to a surface geometry.



*Line Force Densities* are intensive loads representing line traction fields of uniform magnitude applied to curve geometries.





Line Force Density objects belong to Loads objects sets.

The user specifies three components for the direction of the field, along with a magnitude information. Upon modification of any of these four values, the line traction vector components and magnitude are updated based on the last data entry. The line traction vector remains constant independently of the geometry selection.

Units are line traction units (typically N/m in SI).



Line Force Density can be applied to the following types of supports:

Geometrical Feature	Mechanical Feature	Analysis Feature			
		Free Groups	Geometrical Groups	Proximity Groups	Others
Edge					



Open the [sample00.CATAnalysis](#) document from the samples directory for this task: [Finite Element Model](#) containing a Static Analysis Case and computed corresponding [Static Solution](#).

## Before You Begin:

Go to **View -> Render Style -> Customize View** and make sure the **Shading, Outlines** and **Materials** options are active in the Custom View Modes dialog box.



1. Click the **Line Force Density** icon .

The Line Force Density dialog box appears.

2. You can change the identifier of the Line Force Density by editing the **Name** field.
3. Set the Axis System.

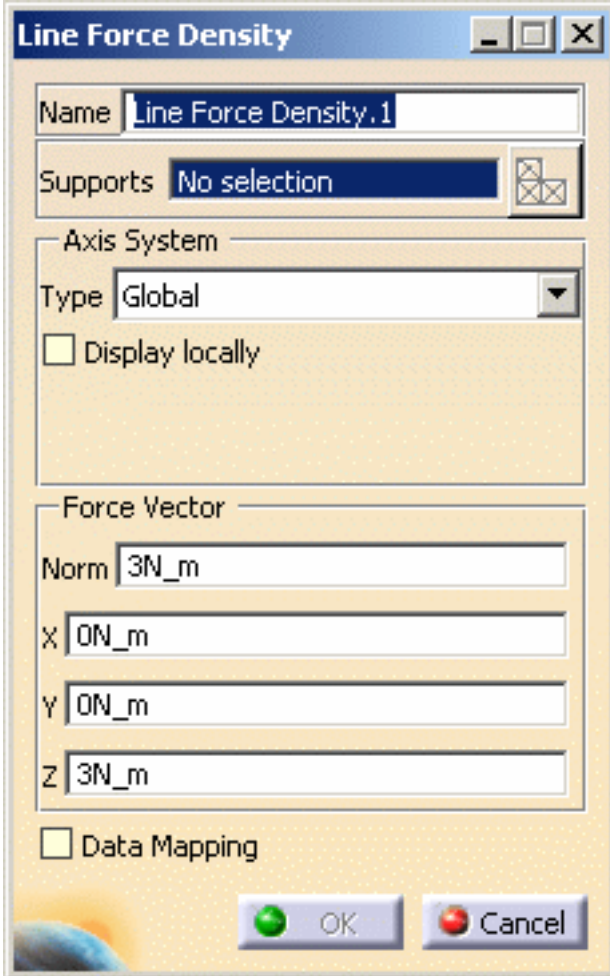

The **Axis System Type** combo box allows you to choose between **Global**, **Implicit** and **User** Axis systems for entering components of the line traction field vector:

- **Global:** if you select the **Global** Axis system, the components of the surface traction field will be interpreted as relative to the fixed global coordinate system.
- **Implicit:** if you select the **Implicit** Axis system, the components of the line traction field will be interpreted as relative to a local variable coordinate system whose type depends on the support geometry.
- **User:** if you select a **User** Axis system, the components of the line traction field will be relative to the specified Axis system. Their interpretation will further



depend on your Axis Type choice.

To select a **User** Axis system, you must activate an existing Axis by clicking it in the specification tree. Its name will then be automatically displayed in the **Current Axis** field.

If you choose the **User** axis system, the **Local orientation** combo box further allows you to choose between **Cartesian**, **Cylindrical** and **Spherical** local axis orientations.

- **Cartesian**: the components of the surface traction field are interpreted as relative to a fixed rectangular coordinate system aligned with the cartesian coordinate directions of the User-defined Axis.
- **Cylindrical**: the components of the surface traction field are interpreted as relative to a local variable rectangular coordinate system aligned with the cylindrical coordinate directions of each point relative to the User-defined Axis.
- **Spherical**: the components of the surface traction field are interpreted as relative to a local variable rectangular coordinate system aligned with the spherical coordinate directions of each point relative to the User-defined Axis.



- You can define the line traction field direction by using the compass.
- You can modify the compass orientation either with the mouse or by editing the compass.
- By applying the compass to any part geometry, you can align the compass directions with the implicit axis directions of that geometry: drag the compass by handling the red square and drop it on the appropriate surface. The normal direction to this surface defines the new direction. Then, click on the Compass Direction button to take this new direction into account. You can now invert the direction if desired, editing the values of the three components.
- Even if a **User** axis system has been referenced, the coordinates of the data mapping stay in the **Global** axis system. Only the **User** axis system directions are taken into account with data mapping.

4. Select the geometry support (an edge) on which the line traction is to be applied.

Any selectable geometry is highlighted when you pass the cursor over it.

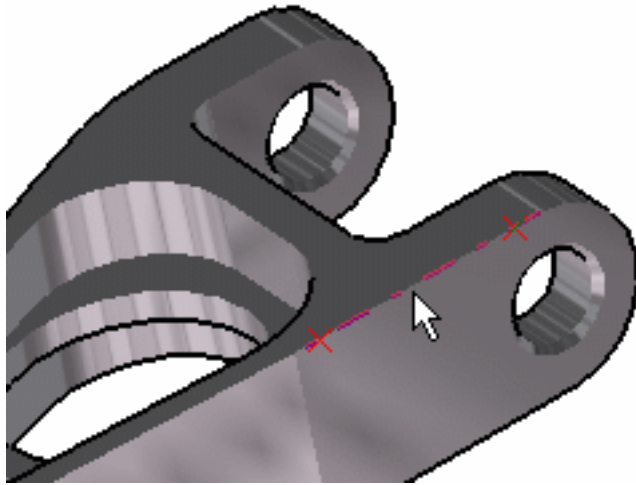

You can select several supports in sequence, to apply the Line Force Density to all supports simultaneously.

Symbols representing the Line Force Density are displayed on the support geometry to visualize the traction field.

5. If needed, enter a new value for any one of the four fields: **Norm**, **X**, **Y** and **Z** in the Line Force Density dialog box.

For example, enter below values for the **X**, **Y**, **Z** components of the line traction field.

The corresponding **Norm** value is automatically computed and displayed.

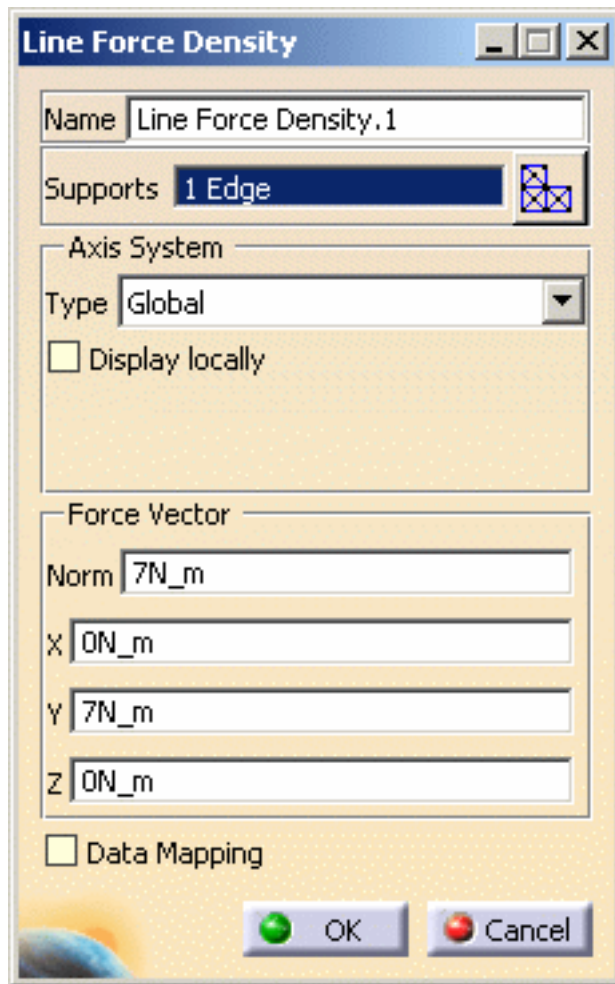

- The remaining three fields are automatically computed and displayed.
- The visualized symbols orientation is also updated to reflect the modification.



You can re-use data (**Data Mapping**) that are external from this version (experimental data or data coming from in-house codes or procedures). For more details, please refer to [Data Mapping](#) (only available if you installed the **ELFINI Structural Analysis** product).

**6.** Click **OK** in the Line Force Density dialog box.

A **Line Force Density** object appears in the features tree under the active **Loads** objects set.

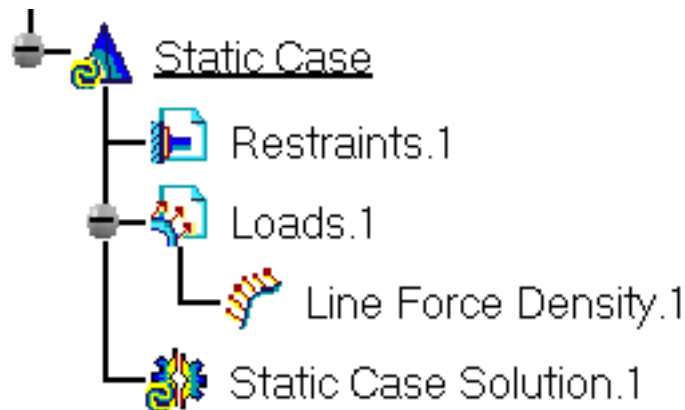

- You can either select the edge and then set the Line Force Density specifications, or set the Line Force Density specifications and then select the edge.
- If you select other surfaces, you can create as many Line Force Density loads as desired with the same dialog box. A series of Line Force Densities can therefore be created quickly.
- Loads are required for Stress Analysis computations.
- If several Analysis Cases have been defined in the Finite Element Model, you must activate a Loads objects set in the specification tree before creating a Line Force Density object (only available if you installed the **ELFINI Structural Analysis** product).
- Line Force Density objects can be edited by a double click on the corresponding object or icon in the specification tree.





Make sure the computation is finished before starting any of the below operations.



### Products Available in Analysis Workbench

The **ELFINI Structural Analysis** product offers the following additional features with a right mouse click (key 3):

-  on a **Line Force Density** object:
  - **Line load visualization on mesh:** the translation of your Line Force Density object specifications into solver specifications can be visualized symbolically at the impacted mesh elements, provided the mesh has been previously generated via a Compute action.
-  on a **Loads objects** set:
  - **Generate Image:** generates an image of the computed Load objects (along with

translating all user-defined Loads specs into explicit solver commands on mesh entities), by generating symbols for the elementary loads imposed by the Loads objects set. The image can be edited to include part or all of the options available.

- **Report:** the partial status and results of intermediate pre-processor computations are reported in HTML format. It represents a subset of the global Report capability and generates a partial report of the Loads objects set Computation. See [Creating Pressures](#) for more details.
- **Double-clicking** on the Loads set, you will display the Loads dialog box that lets you choose whether you wish to apply self-balancing to the load. Example of use: if this option is used with iso-static specifications, it will allow you to simulate free-body loading. If you make the option active, the center of inertia results null.



# Creating Surface Force Densities



This task shows you how to create a Surface Force Density applied to a surface geometry.



*Surface Force Densities* are intensive loads representing surface traction fields of uniform magnitude applied to surface geometries.

Surface Force Density objects belong to Loads objects sets.

The user specifies three components for the direction of the field, along with a magnitude information. Upon modification of any of these four values, the surface traction vector components and magnitude are updated based on the last data entry. The surface traction vector remains constant independently of the geometry selection.

Units are surface traction units (typically  $\text{N}/\text{m}^2$  in SI).



Surface Force Density can be applied to the following types of supports:

Geometrical Feature	Mechanical Feature	Analysis Feature			
		Free Groups	Geometrical Groups	Proximity Groups	Others
Face					



Open the [sample00.CATAnalysis](#) document from the samples directory for this task: [Finite Element Model](#) containing a Static Analysis Case and computed corresponding [Static Solution](#).

## Before You Begin:

Go to **View -> Render Style -> Customize View** and make sure the **Shading, Outlines** and **Materials** options are active in the Custom View Modes dialog box.



1. Click the **Surface Force Density** icon .

The Surface Force Density dialog box appears.

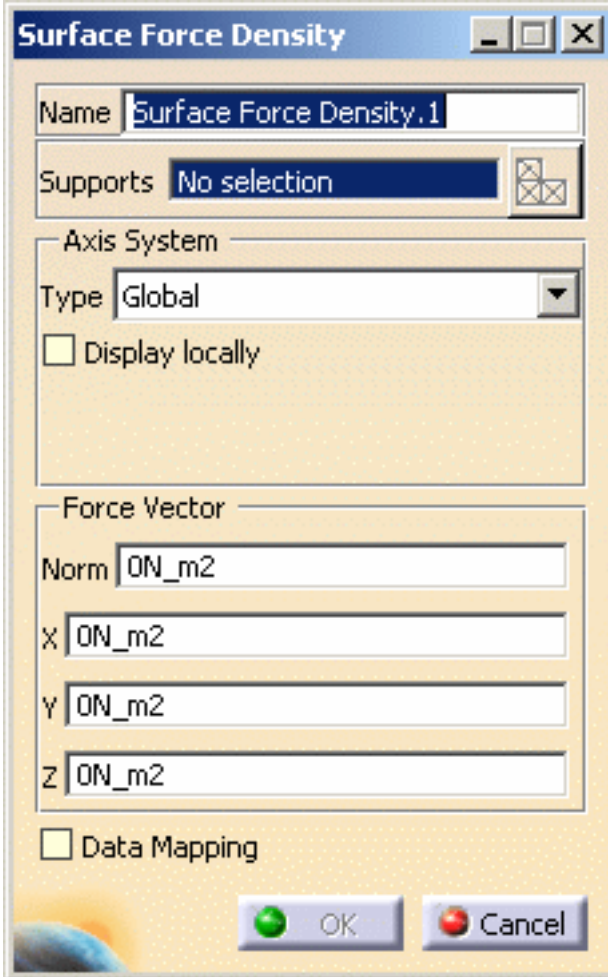

**Surface Force Density**

Name

Supports

Axis System

Type

Display locally

Force Vector

Norm

X

Y

Z

Data Mapping

2. You can change the identifier of the Surface Force Density by editing the **Name** field.
3. Set the Axis system.

The **Axis System Type** combo box allows you to choose between **Global**, **Implicit** and **User** Axis systems for entering components of the traction field vector:

- **Global**: if you select the **Global** Axis system, the components of the surface traction field will be interpreted as relative to the fixed global coordinate system.
- **Implicit**: if you select the **Implicit** Axis system, the components of the surface traction field will be interpreted as relative to a local variable coordinate system whose type depends on the support geometry.
- **User**: if you select a **User** Axis system, the components of the surface traction field will be relative to the specified Axis system. Their interpretation will further depend on your Axis Type choice.

To select a **User** Axis system, you must activate an existing Axis by clicking it in the specification tree. Its name will then be automatically displayed in the **Current Axis** field.

If you choose the **User** axis system, the **Local orientation** combo box further allows you to choose between **Cartesian**, **Cylindrical** and **Spherical** local axis orientations.

- **Cartesian**: the components of the surface traction field are interpreted as relative to a fixed rectangular coordinate system aligned with the cartesian coordinate directions of the User-defined Axis.
- **Cylindrical**: the components of the surface traction field are interpreted as relative to a local variable rectangular coordinate system aligned with the cylindrical coordinate directions of each point relative to the User-defined Axis.
- **Spherical**: the components of the surface traction field are interpreted as relative to a local variable rectangular coordinate system aligned with the spherical coordinate directions of each point relative to the User-defined Axis.





- You can define the surface traction direction by using the compass.
- You can modify the compass orientation either with the mouse or by editing the compass.
- By applying the compass to any part geometry, you can align the compass directions with the implicit axis directions of that geometry: drag the compass by handling the red square and drop it on the appropriate surface. The normal direction to this surface defines the new direction. Then, click on the Compass Direction button to take this new direction into account. You can now invert the direction if desired, editing the values of the three components.
- Even if a **User** axis system has been referenced, the coordinates of the data mapping stay in the **Global** axis system. Only the **User** axis system directions are taken into account with data mapping.

**4.** Select the geometry support (a face) on which the surface traction is to be applied.

Any selectable geometry is highlighted when you pass the cursor over it.

You can select several supports in sequence, to apply the Surface Force Density to all supports simultaneously.

Symbols representing the Surface Force Density are displayed on the support geometry to visualize the traction field.

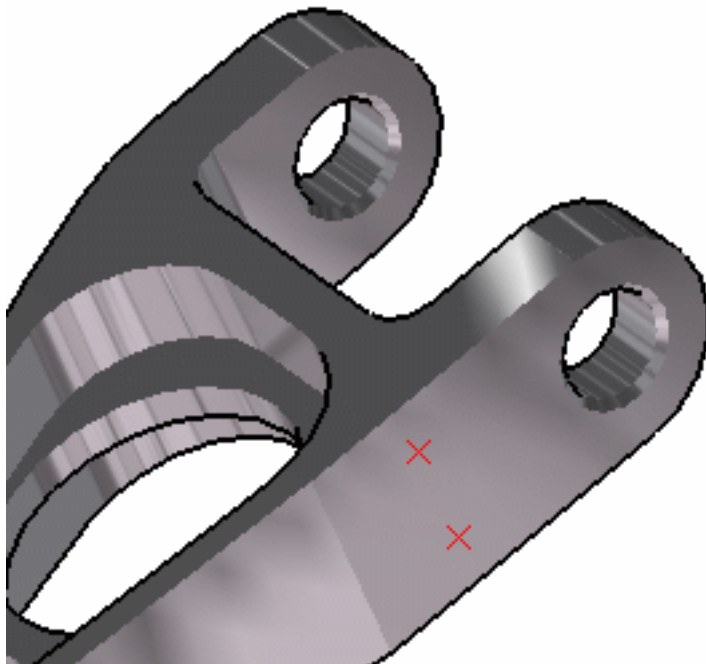

**5.** Enter a new value for any one of the four fields.

For example, enter values for the **X**, **Y**, **Z** components of the surface traction field as shown below

- The corresponding **Norm** value is automatically computed and displayed.
- The remaining three fields are automatically computed and displayed.
- The visualized symbols orientation is also updated to reflect the modification.

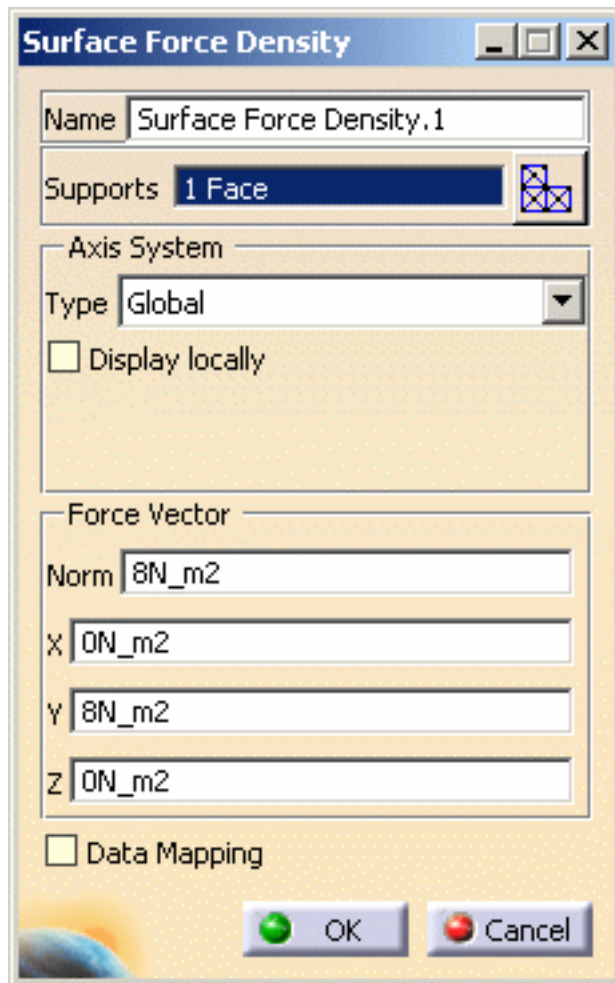

You can re-use data (**Data Mapping**) that are external from this version (experimental data or data coming from in-house codes or procedures). For more details, please refer to [Data Mapping](#) (only available if you installed the **ELFINI Structural Analysis** product).

6. Click **OK** in the Surface Force Density dialog box.

A **Surface Force Density** object appears in the features tree under the active **Loads** objects set.

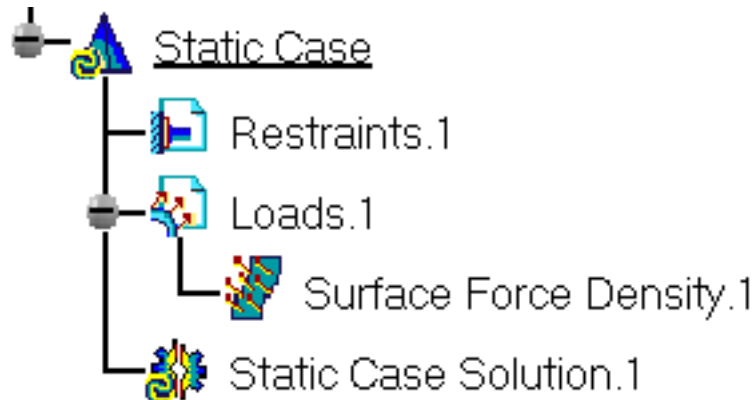

- You can either select the surface and then set the Surface Force Density specifications, or set the Surface Force Density specifications and then select the surface.
- If you select other surfaces, you can create as many Surface Force Density loads as desired with the same dialog box. A series of Surface Force Densities can therefore be created quickly.
- Loads are required for Stress Analysis computations.
- If several Analysis Cases have been defined in the Finite Element Model, you must activate a Loads objects set in the features tree before creating a Surface Force Density object (only available if you installed the **ELFINI Structural Analysis** product).
- Surface Force Density objects can be edited by a double click on the corresponding object or icon in the specification tree.





Make sure the computation is finished before starting any of the below operations.



### Products Available in Analysis Workbench

The **ELFINI Structural Analysis** product offers the following additional features with a right mouse click (key 3):

-  on a **Surface Force Density** object:
  - **Surface load visualization on mesh:** the translation of your Surface Force Density object specifications into solver specifications can be visualized symbolically at the impacted mesh elements, provided the mesh has been previously generated via a Compute action.
-  on a **Loads objects** set:
  - **Generate Image:** generates an image of the computed Load objects (along with

translating all user-defined Loads specs into explicit solver commands on mesh entities), by generating symbols for the elementary loads imposed by the Loads objects set. The image can be edited to include part or all of the options available.

- **Report:** the partial status and results of intermediate pre-processor computations are reported in HTML format. It represents a subset of the global Report capability and generates a partial report of the Loads objects set Computation. See [Creating Pressures](#) for more details.
- **Self-balancing:** xxx.



# Creating Volume Force Densities



This task shows you how to create a volume force density (named Body Force) applied to a part.



*Body Forces* are intensive loads representing volume body force fields of uniform magnitude applied to parts.

Body Force objects belong to the Loads objects set.

You need to specify three components for the direction of the field, along with a magnitude information. Upon modification of any of these four values, the volume body force vector components and magnitude are updated based on the last data entry. The volume body force vector remains constant independently of the geometry selection.

Units are volume body force units (typically  $\text{N}/\text{m}^3$  in SI).



Body Forces can be applied to the following types of supports:

Geometrical Feature	Mechanical Feature	Analysis Feature			
		Free Groups	Geometrical Groups	Proximity Groups	Others
Body 3D					Mesh Part



Open the [sample00.CATAnalysis](#) document from the samples directory for this task: [Finite Element Model](#) containing a Static Analysis Case and computed corresponding [Static Solution](#).

## Before You Begin:

Go to **View -> Render Style -> Customize View** and make sure the **Shading, Outlines** and **Materials** options are active in the Custom View Modes dialog box.



1. Click the **Body Force** icon .

The Body Force dialog box appears.

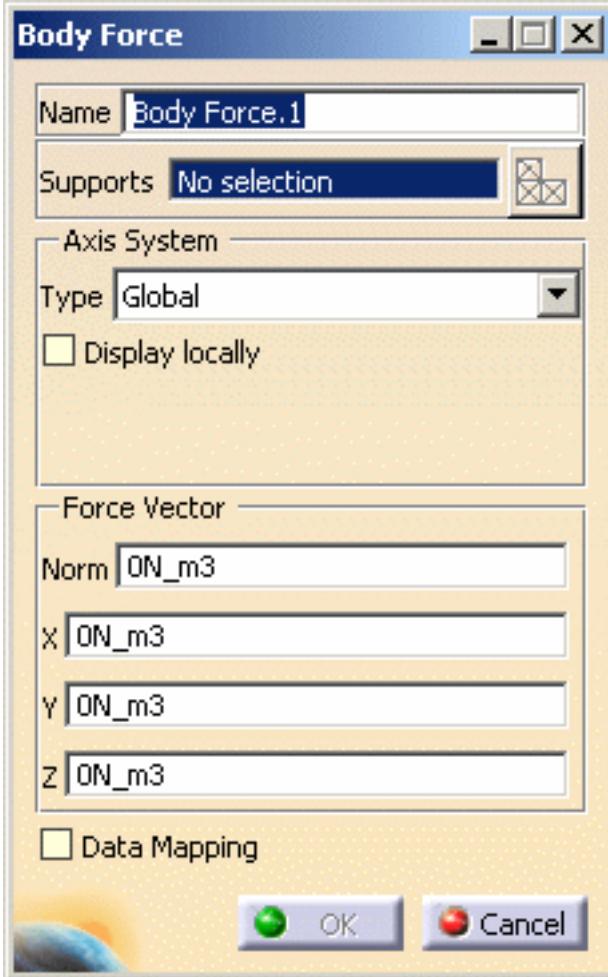

**Body Force**

Name

Supports  

Axis System

Type  

Display locally

Force Vector

Norm

X

Y

Z

Data Mapping

2. You can change the identifier of the Body Force by editing the **Name** field.
3. Set the **Axis System**. In this example, select **Global**.

The **Axis System Type** combo box allows you to choose between **Global** and **User** Axis systems for entering components of the volume body force field.

- **Global:** if you select the Global Axis system, the components of the volume body force field will be interpreted as relative to the fixed global rectangular coordinate system.
- **User:** if you select a User-defined Axis system, the components of the volume body force field will be interpreted as relative to the specified rectangular coordinate system.

To select a User-defined Axis system, you must activate an existing Axis by clicking it in the specification tree. Its name will then be automatically displayed in the **Current Axis** field.

If you choose the **User** axis system, the **Local orientation** combo box further allows you to choose between **Cartesian**, **Cylindrical** and **Spherical** local axis orientations.

- **Cartesian:** the components of the surface traction field are interpreted as relative to a fixed rectangular coordinate system aligned with the Cartesian coordinate directions of the User-defined Axis.
- **Cylindrical:** the components of the surface traction field are interpreted as relative to a local variable rectangular coordinate system aligned with the cylindrical coordinate directions of each point relative to the User-defined Axis.
- **Spherical:** the components of the surface traction field are interpreted as relative to a local variable rectangular coordinate system aligned with the spherical coordinate directions of each point relative to the User-defined Axis.



- You can define the volume body force direction by using the compass.
- You can modify the compass orientation either with the mouse or by editing the compass.
- By applying the compass to any part geometry, you can align the compass directions with the implicit axis directions of that geometry: drag the compass by handling the red square and drop it on the appropriate surface. The normal direction to this surface defines the new direction. Then, click on the Compass Direction button to take this new direction into account. You can now invert the direction if desired, editing the values of the three components.
- Even if a **User** axis system has been referenced, the coordinates of the data mapping stay in the **Global** axis system. Only the **User** axis system directions are taken into account with data mapping.

4. Select the geometry support (a part) on which the volume body force is to be

applied.

Any selectable geometry is highlighted when you pass the cursor over it.

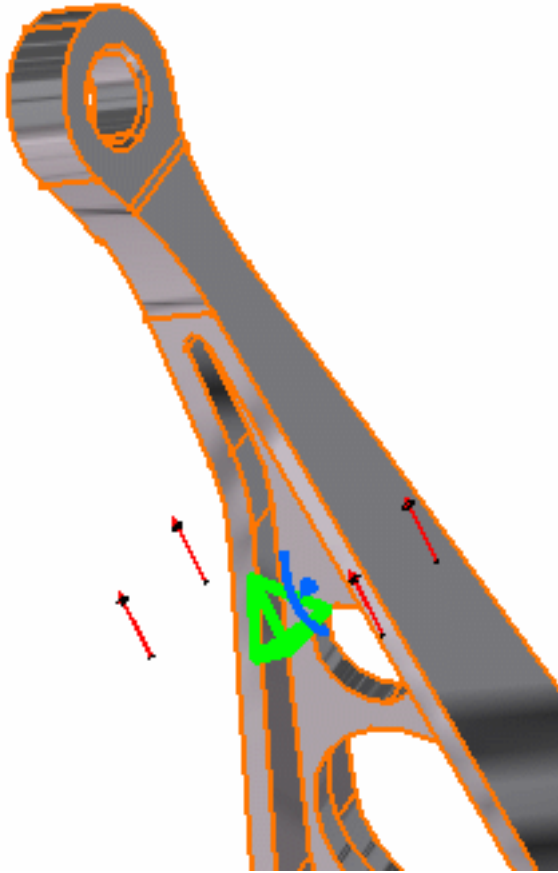

You can select several supports in sequence, to apply the Body Force to all supports simultaneously. Symbols representing the Body Force are displayed on the support geometry to visualize the volume body force field.

5. If needed, enter a new value for any one of the four fields.

For example, enter values for the **X**, **Y**, **Z** components of the volume body force field as shown below

- The corresponding **Norm** value is automatically computed and displayed.
- The remaining three fields are automatically computed and displayed.
- The visualized symbols orientation is also updated to reflect the modification.



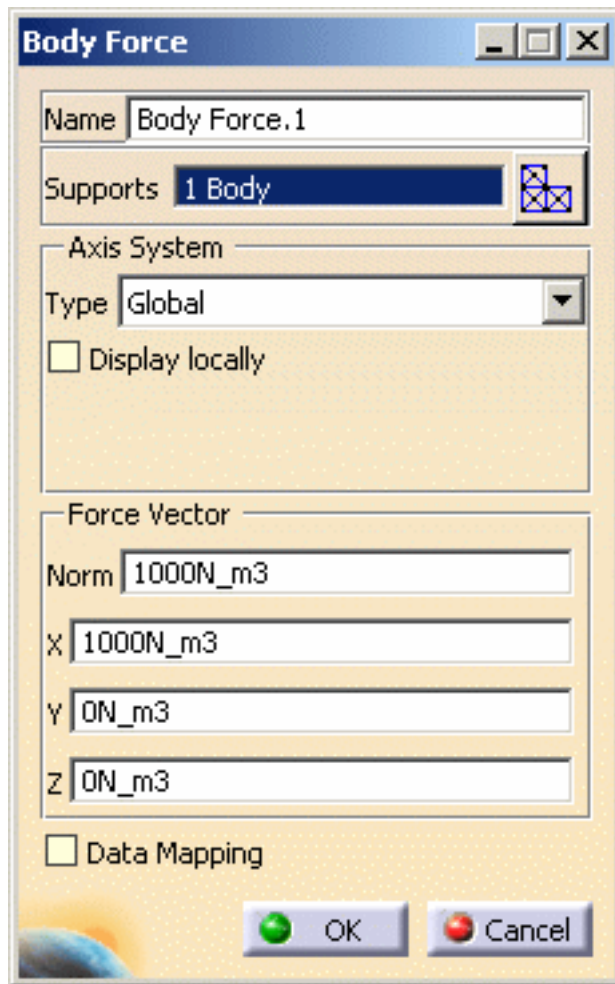



You can re-use data (**Data Mapping**) that are external from this version (experimental data or data coming from in-house codes or procedures). For more details, please refer to [Data Mapping](#) (only available if you installed the **ELFINI Structural Analysis** product).

6. Click **OK** in the Body Force dialog box.

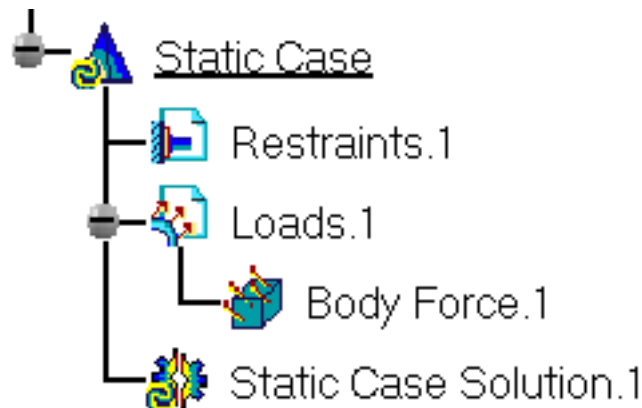
A **Body Force** object appears in the specification tree under the active **Loads** objects set.



- You can either select the part and then set the Body Force specifications, or set the Body Force specifications and then select the part.
- If you select other parts, you can create as many Body Force loads as desired with the same dialog box. A series of Body Force objects can therefore be created quickly.
- Loads are required for Stress Analysis computations.
-  If several Analysis Cases have been defined in the Finite Element Model, you must activate a Loads objects set in the features tree before creating a Body Force object (only available if you installed the **ELFINI Structural Analysis** product).
- Body Force objects can be edited by a double click on the corresponding object or icon in the specification tree.





Make sure the computation is finished before starting any of the below operations.



### Products Available in Analysis Workbench

The **ELFINI Structural Analysis** product offers the following additional features with a right mouse click (key 3):

-  on a **Body Force** object:
  - **Volume load visualization on mesh:** the translation of your Body Force object specifications into solver specifications can be visualized symbolically at the impacted mesh elements, provided the mesh has been previously generated via a Compute action.
-  on a **Loads objects** set:
  - **Generate Image:** generates an image of the computed Load objects (along with

translating all user-defined Loads specs into explicit solver commands on mesh entities), by generating symbols for the elementary loads imposed by the Loads objects set. The image can be edited to include part or all of the options available.

- **Report:** the partial status and results of intermediate pre-processor computations are reported in HTML format. It represents a subset of the global Report capability and generates a partial report of the Loads objects set Computation. See [Creating Pressures](#) for more details.
- **Self-balancing:** xxx.



# Creating Force Density



This task shows you how to create the equivalent of the existing line force density, surface force density and body force by giving only as input a force in Newton (N in SI) and not a force density ( $\text{N/m}$  in SI for a line force density,  $\text{N/m}^2$  in SI for a surface force density and  $\text{N/m}^3$  for body force).



Only available with the **ELFINI Structural Analysis (EST)** product.



Force Densities can be applied to the following types of supports:

Geometrical Feature	Mechanical Feature	Analysis Feature			
		Free Groups	Geometrical Groups	Proximity Groups	Others
Point/Vertex Face Body (homogeneous selection)		▲			



Open the [sample00.CATAnalysis](#) document from the samples directory for this task: [Finite Element Model](#) containing a Static Analysis Case and computed corresponding [Static Solution](#).

## Before You Begin:

Go to **View -> Render Style -> Customize View** and make sure the **Shading, Outlines** and **Materials** options are active in the Custom View Modes dialog box.



1. Click the **Force Density** icon .

The Force Density Defined by Force Vector dialog box appears.

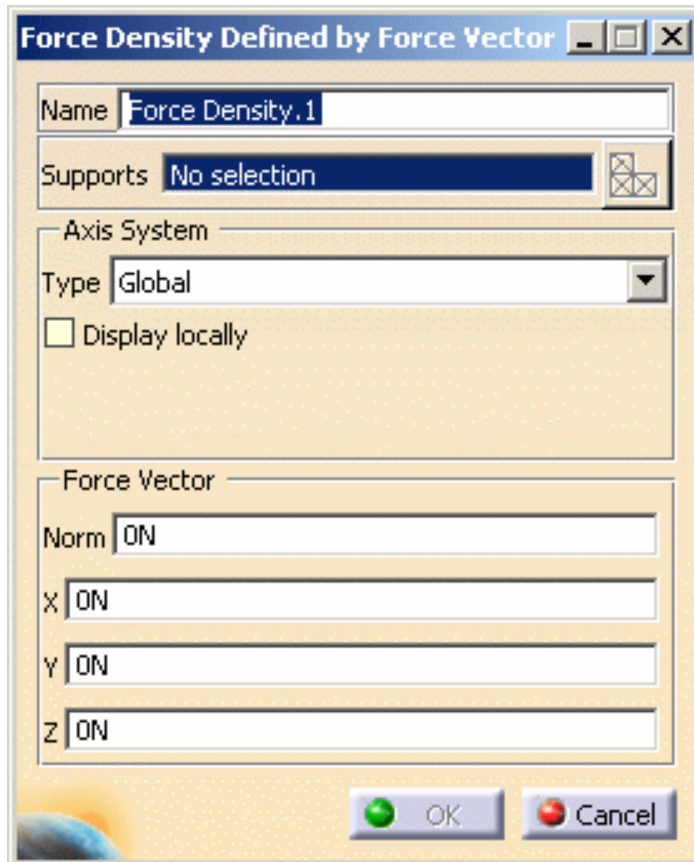

- **Name:** gives you the name of the force. If needed, you can change it.
- **Support:** lets you select the support.
  - ⚠ Multi-selection is available and must be homogeneous.
  - You can select edge, surface or bodies (2D or 3D).
- **Axis System:**
  - **Type:**
    - **Global:** if you select the Global Axis system, the components of the force density field will be interpreted as relative to the fixed global rectangular coordinate system.
    - **User:** if you select a User-defined Axis system, the components of the force density field will be interpreted as relative to the specified rectangular coordinate system.

To select a User-defined Axis system, you must activate an existing Axis by clicking it in the specification tree.

Its name will then be automatically displayed in the **Current Axis** field.

The **Local orientation** is **Cartesian**: the components of the surface traction field are interpreted as relative to a fixed rectangular coordinate system aligned with the Cartesian coordinate directions of the User-defined Axis.



- You can define the force density direction by using the compass.
  - You can modify the compass orientation either with the mouse or by editing the compass.
  - By applying the compass to any part geometry, you can align the compass directions with the implicit axis directions of that geometry: drag the compass by handling the red square and drop it on the appropriate surface. The normal direction to this surface defines the new direction. Then, click on the Compass Direction button to take this new direction into account. You can now invert the direction if desired, editing the values of the three components.
- **Display locally**: lets you display the selected axis system.
  - **Force Vector**: lets specify the value of the force vector component.

**2. Specify the Axis System.**

In this particular example, select **Global** as axis system **Type**.

**3. Select the desired geometry support.**

In this particular example, select the two following surfaces.

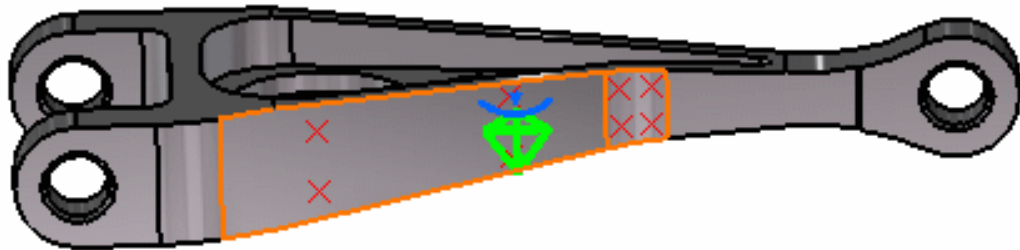

Symbols representing the force are displayed on the selected support to visualize the force density field.

**4. Specify the desired Force Vector value.**

In this particular example, enter **3N** as **X** value and **10N** as **Z** value.

Note that:

- The corresponding **Norm** value is automatically computed and displayed.

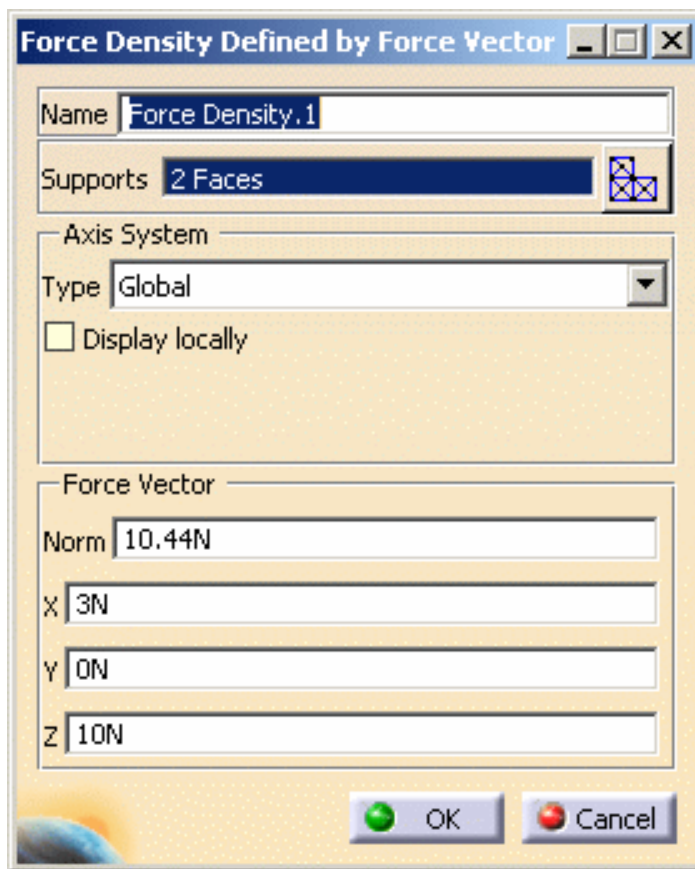

- The visualized symbols orientation is also updated to reflect the modification.

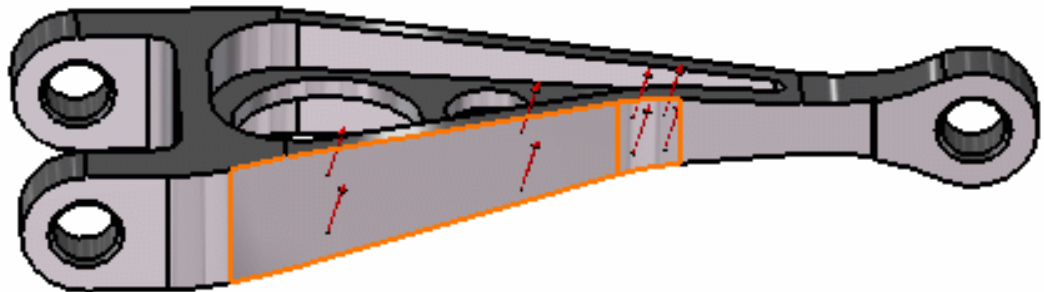

5. Click **OK** in the Force Density Defined by Force Vector dialog box.

A **Force Density** object is displayed in the specification tree under the **Loads.1** set.

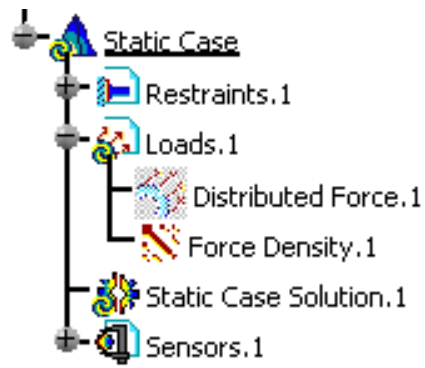



# Creating Accelerations



This task shows you how to create an Acceleration applied to a part.



*Accelerations* are intensive loads representing mass body force (acceleration) fields of uniform magnitude applied to parts.

Acceleration objects belong to Loads objects sets.

You need to specify three components for the direction of the field, along with a magnitude information. Upon modification of any of these four values, the mass body force vector components and magnitude are updated based on the last data entry.

Units are mass body force (or acceleration) units (typically **N/kg**, or **m/s<sup>2</sup>** in SI).



Accelerations can be applied to the following types of supports:

Geometrical Feature	Mechanical Feature	Analysis Feature			
		Free Groups	Geometrical Groups	Proximity Groups	Others
Body 1D Body 2D Body 3D		▲	▲	▲	Mesh Part Virtual Part



Open the [sample00.CATAnalysis](#) document from the samples directory for this task: [Finite Element Model](#) containing a Static Analysis Case and computed corresponding [Static Solution](#).

## Before You Begin:

Go to **View -> Render Style -> Customize View** and make sure the **Shading, Outlines** and **Materials** options are active in the Custom View Modes dialog box.



1. Click the **Acceleration** icon .

The Acceleration dialog box appears.

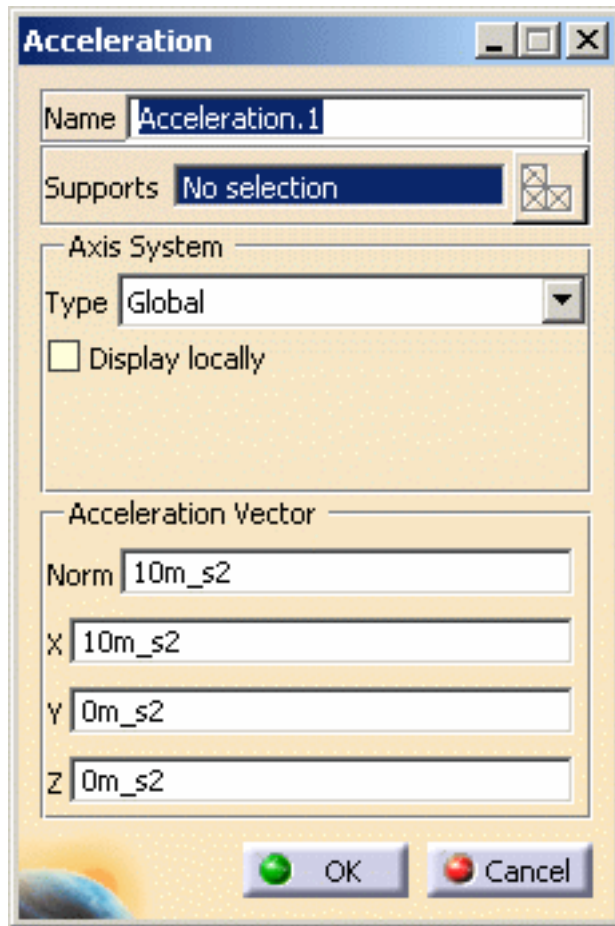

2. You can change the identifier of the Acceleration by editing the **Name** field.
3. Set the **Axis System**.

The **Axis System Type** combo box allows you to choose between **Global** and **User** Axis systems for entering components of the acceleration field.

- **Global:** if you select the **Global** Axis system, the components of the acceleration field will be interpreted as relative to the fixed global rectangular coordinate system.
- **User:** if you select a **User** Axis system, the components of the acceleration field will be interpreted as relative to the specified rectangular coordinate system.  
To select a User Axis system, you must activate an existing Axis by clicking it in the specification tree. Its name will then be automatically displayed in the **Current Axis** field.



- You can define the mass body force direction by using the compass.
- You can modify the compass orientation either with the mouse or by editing the compass.
- By applying the compass to any part geometry, you can align the compass directions with the implicit axis directions of that geometry: drag the compass by handling the red square and drop it on the appropriate surface. The normal direction to this surface defines the new direction. Then, click on the Compass Direction button to take this new direction into account. You can now invert the direction if desired, editing the values of the three components.

4. Enter values for the **X**, **Y**, **Z** components of the mass body force field: the corresponding **Norm** value is automatically computed and displayed.

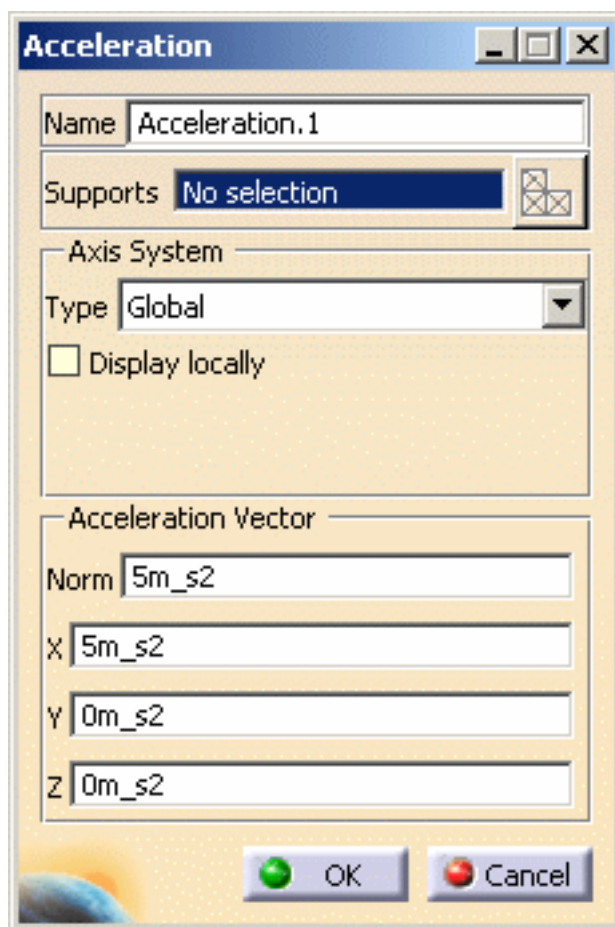

5. Select the geometry support (a part) on which the mass body force is to be applied.

Any selectable geometry is highlighted when you pass the cursor over it.

You can select several supports in sequence, to apply the Acceleration to all supports simultaneously.

Symbols representing the Acceleration are displayed on the support geometry to visualize the volume body force field.

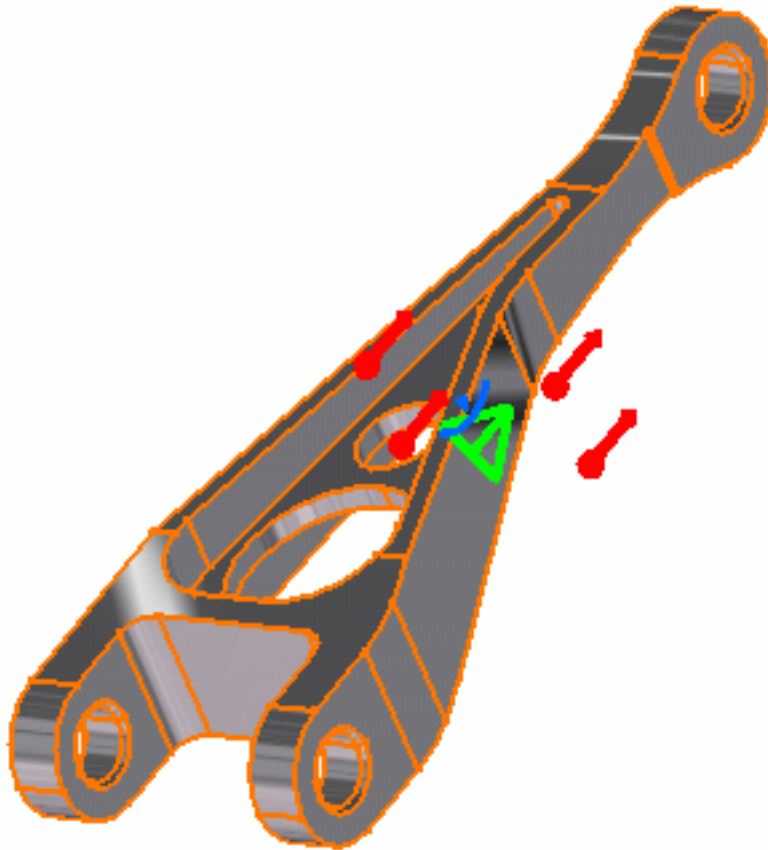

The remaining three fields are automatically computed and displayed.

The visualized symbols orientation is also updated to reflect the modification.

6. Click **OK** in the Acceleration dialog box.

An **Acceleration** object appears in the specification tree under the active **Loads** objects set.

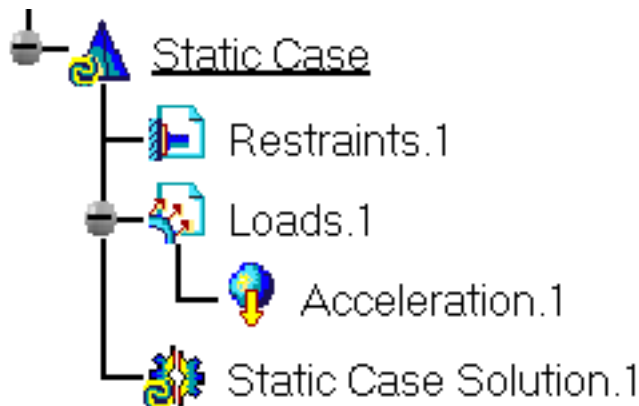

- You can either select the part and then set the Acceleration specifications, or set the Acceleration specifications and then select the part.
- If you select other parts, you can create as many Acceleration loads as desired with the same dialog box. A series of Accelerations can therefore be created quickly.
- Loads are required for Stress Analysis computations.
- If several Analysis Cases have been defined in the Finite Element Model, you must activate a Loads objects set in the specification tree before creating an Acceleration object (only available if you installed the **ELFINI Structural Analysis** product).
- Acceleration objects can be edited by a double click on the corresponding object or icon in the specification tree.





Make sure the computation is finished before starting any of the below operations.



### Products Available in Analysis Workbench

The **ELFINI Structural Analysis** product offers the following additional features with a right mouse click (key 3):

-  on an **Acceleration** object:
  - **Translational acceleration visualization on mesh:** the translation of your Acceleration object specifications into solver specifications can be visualized symbolically at the impacted mesh elements, provided the mesh has been previously generated via a Compute action.
-  on a **Loads objects** set:
  - **Generate Image:** generates an image of the computed Load objects (along with translating all user-defined Loads specs into explicit solver commands on mesh

entities), by generating symbols for the elementary loads imposed by the Loads objects set. The image can be edited to include part or all of the options available.

- **Report:** the partial status and results of intermediate pre-processor computations are reported in HTML format. It represents a subset of the global Report capability and generates a partial report of the Loads objects set Computation. See [Creating Pressures](#) for more details.
- **Self-balancing:** xxx.



# Creating Rotation Forces



This task shows you how to create a Rotation Force applied to a part.



*Rotation Forces* are intensive loads representing mass body force (acceleration) fields induced by rotational motion applied to parts. Rotation Force objects belong to Loads objects sets.

The user specifies a rotation axis and values for the angular velocity and angular acceleration magnitudes, and the program automatically evaluates the linearly varying acceleration field distribution.

Units are angular velocity and angular acceleration units (typically **rad/s** and **rad/s<sup>2</sup>** in SI).



Rotation Forces can be applied to the following types of supports:

Geometrical Feature	Mechanical Feature	Analysis Feature			
		Free Groups	Geometrical Groups	Proximity Groups	Others
Body 1D Body 2D Body 3D		▲	▲	▲	Mesh Part Virtual Part



Open the [sample00.CATAnalysis](#) document from the samples directory for this task: [Finite Element Model](#) containing a Static Analysis Case and computed corresponding [Static Solution](#).

## Before You Begin:

Go to **View -> Render Style -> Customize View** and make sure the **Shading, Outlines** and **Materials** options are active in the Custom View Modes dialog box.



1. Click the **Rotation** icon .

The Rotation Force dialog box appears.

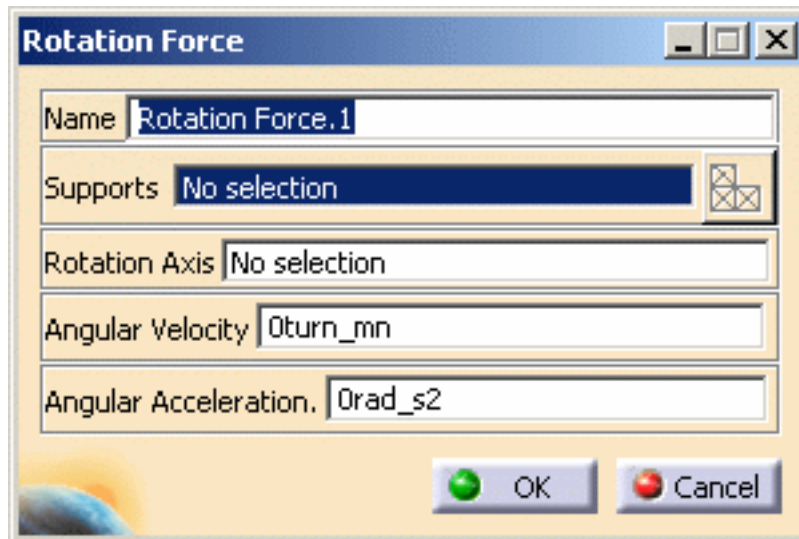

2. You can change the identifier of the Rotation Force by editing the **Name** field.
3. Select the geometry support (**Supports** field): the part on which the variable acceleration field is to be applied.

Any selectable geometry is highlighted when you pass the cursor over it.

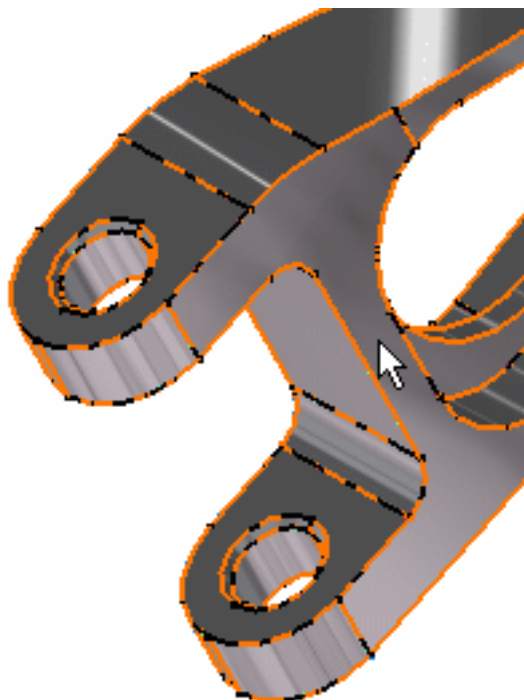



You can select several supports in sequence, to apply the Rotation Force to all supports simultaneously.

4. Select an existing line or a construction axis to specify the **Rotation Axis**.

Any selectable geometry is highlighted when you pass the cursor over it.

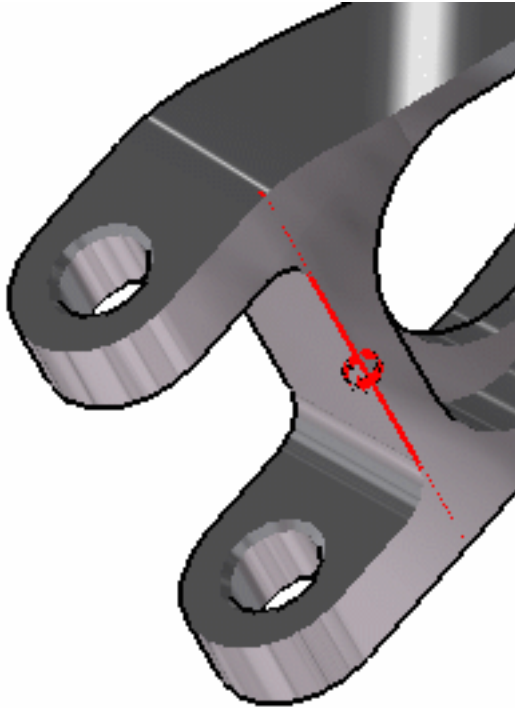

To select a User-defined Axis system, you must activate an existing Axis by clicking it in the features tree. Its name will then be automatically displayed in the Axis Name field.

Symbols representing the Rotation Force are displayed on the support geometry to visualize the acceleration field.

5. Enter a value for the magnitude of the **Angular Velocity** about the rotation axis. For example, **8turn\_mn**.
6. Enter a value for the magnitude of the **Angular Acceleration** about the rotation axis. For example, **70rad\_s2**.

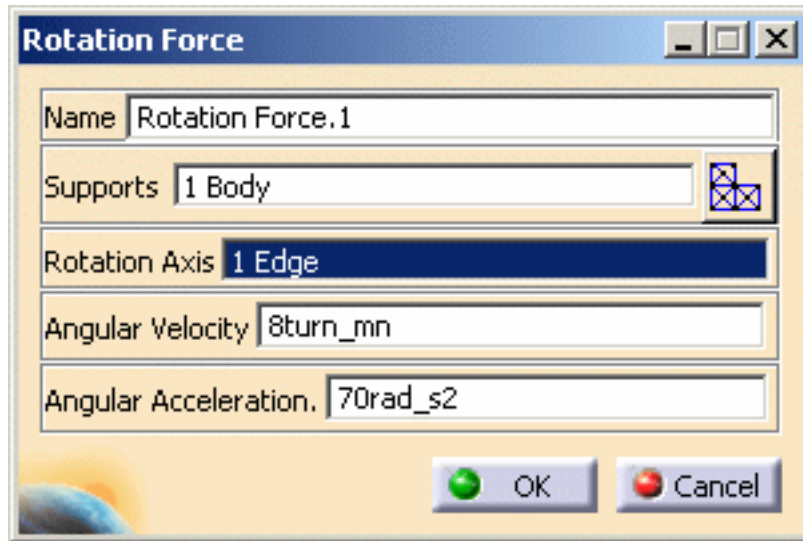

7. Click **OK** in the Rotation Force dialog box.

A **Rotation Force** object appears in the specification tree under the active **Loads** objects set.

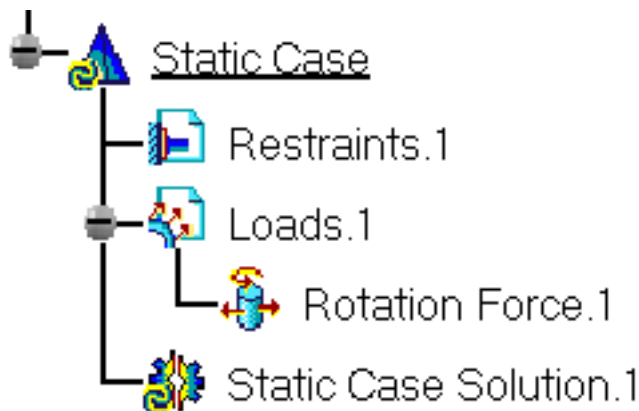

- You can either select the part and then set the Rotation Force specifications, or set the Rotation Force specifications and then select the part.
- If you select other parts, you can create as many Rotation Force loads as desired with the same dialog box. A series of Rotation Forces can therefore be created quickly.
- Loads are required for Stress Analysis computations.
- If several Analysis Cases have been defined in the Finite Element Model, you must activate a Loads objects set in the specification tree before creating a Rotation Force object (only available if you installed the **ELFINI Structural Analysis** product).
- Rotation Force objects can be edited by a double click on the corresponding object or icon in the specification tree.





Make sure the computation is finished before starting any of the below operations.



### Products Available in Analysis Workbench

The **ELFINI Structural Analysis** product offers the following additional features with a right mouse click (key 3):

-  on a **Rotation Force** object:
  - **Rotation Force Visualization on Mesh:** the translation of your Rotation Force object specifications into solver specifications can be visualized symbolically at the impacted mesh elements, provided the mesh has been previously generated via a Compute action.
  
-  on a **Loads objects** set:
  - **Generate Image:** generates an image of the computed Load objects (along with translating all user-defined Loads specs into explicit solver commands on mesh entities), by generating symbols for the elementary loads imposed by the Loads objects set. The image can be edited to include part or all of the options available.
  - **Report:** the partial status and results of intermediate pre-processor computations are reported in HTML format. It represents a subset of the global Report capability and generates a partial report of the Loads objects set Computation. See [Creating Pressures](#) for more details.
  - **Self-balancing:** xxx.



# Creating Enforced Displacements



This task shows how to create an Enforced Displacement on a restrained geometry.



*Enforced Displacements* are loads applied to support geometries, resulting for the subsequent analysis in assigning non-zero values to displacements in previously restrained directions.

Enforced Displacement objects belong to Loads objects sets. An Enforced Displacement object is by definition associated to a Restraint object.

Make sure you entered non-zero values only for those degrees of freedom which have been fixed by the associated Restraint object. Non-zero values for any other degree of freedom will be ignored by the program.



Enforced Displacements can be applied to the following types of Supports:

Geometrical Feature	Mechanical Feature	Analysis Feature			
		Free Groups	Geometrical Groups	Proximity Groups	Others
					Restraint specifications



Open the [sample20.CATAnalysis](#) document from the samples directory for this task: a [Finite Element Model](#) containing a Static Analysis Case and a [Restraint](#) object.

## Before You Begin:

Go to **View -> Render Style -> Customize View** and make sure the **Shading**, **Outlines** and **Materials** options are active in the Custom View Modes dialog box.



1. Click the **Enforced Displacement** icon .

The Enforced Displacement dialog box appears.



**Enforced displacement**

Name: Enforced Displacement.1

restraint: [dropdown menu]

Translation 1: 100mm

Translation 2: 0mm

Translation 3: 0mm

Rotation 1: 0deg

Rotation 2: 0deg

Rotation 3: 0deg

OK Cancel

2. You can change the identifier of the Enforced Displacement by editing the **Name** field.
3. Activate the appropriate Restraint object by clicking, for example, **Clamp.1** in the specification tree (**Restraints.1** object set).
4. Enter values for the imposed displacement values corresponding to the restrained degree of freedom of the selected Restraint.

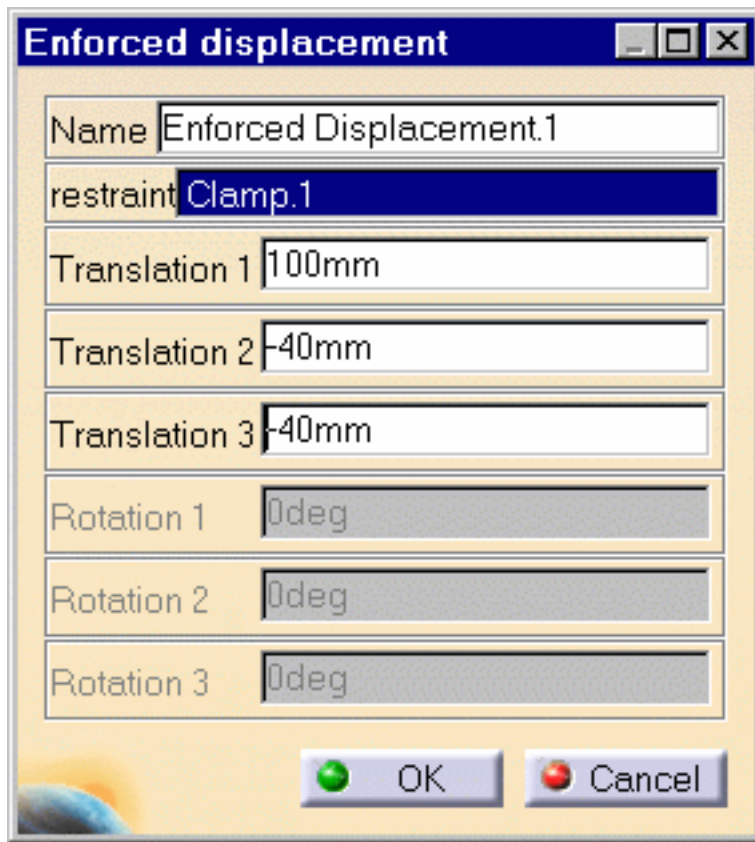

The values of the imposed displacements are displayed on the corresponding Restraint symbol.

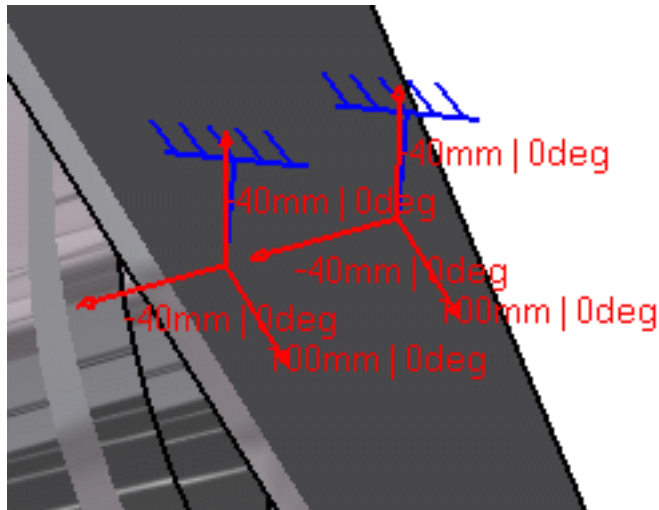

5. Click **OK** in the Enforced Displacement dialog box.

An **Enforced Displacement** object appears in the specification tree under the active **Loads.1** objects set.

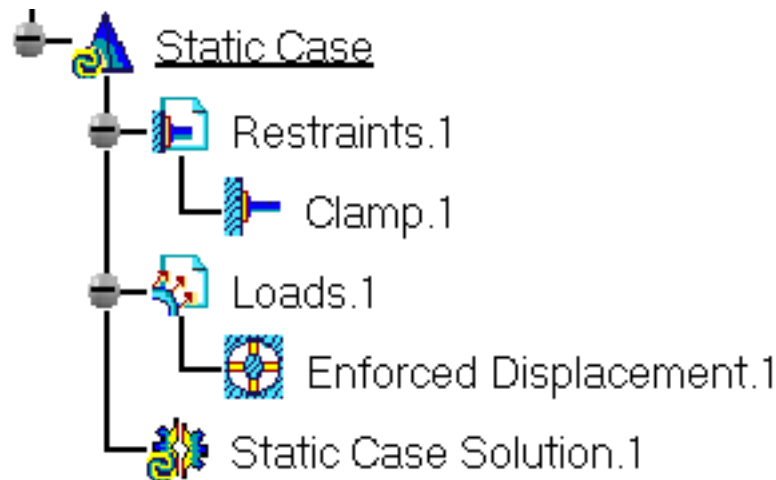

- If several Analysis Cases have been defined in the Finite Element Model, you must activate a Loads objects set in the specification tree before creating an Enforced Displacements object (only available if you installed the **ELFINI Structural Analysis** product).
- Restraints are required for Stress Analysis computations. They are optional for Modal Analysis computations (if not created, the program will compute vibration modes for the free, unrestrained part).
- Enforced Displacement objects can be edited by a double click on the corresponding object or icon in the specification tree.





Make sure the computation is finished before starting any of the below operations.



### Products Available in Analysis Workbench

The **Elfini Structural Analysis** product offers the following additional features with a right mouse click (key 3):

-  on an **Enforced Displacement** object:
  - **Enforced Displacement Visualization on Mesh:** the translation of your Enforced Displacement object specifications into solver specifications can be visualized symbolically at the impacted mesh nodes, provided the mesh has been previously generated via a Compute action.
-  on a **Loads objects** set:
  - **Generate Image:** generates an image of the computed Load objects (along with

translating all user-defined Loads specs into explicit solver commands on mesh entities), by generating symbols for the elementary loads imposed by the Loads objects set. The image can be edited to include part or all of the options available.

- **Report:** the partial status and results of intermediate pre-processor computations are reported in HTML format. It represents a subset of the global Report capability and generates a partial report of the Loads objects set Computation. See [Creating Pressures](#) for more details.





# Creating Temperature Field



This task shows you how to load a body with a given temperature.

Creating Temperature Field means applying a temperature constant or not (data mapping) to a part.



Only available with the **ELFINI Structural Analysis (EST)** product.



Temperature Field can be applied to the following types of supports:

Geometrical Feature	Mechanical Feature	Analysis Feature			
		Free Groups	Geometrical Groups	Proximity Groups	Others
Face Body					Mesh Part



Open the [sample34.CATAnalysis](#) document from the samples directory.



1. Select the **Temperature Field** icon .

The Temperature Field dialog box appears which lets you define the **Name**, **Support** and reference **Temperature** you wish to define.

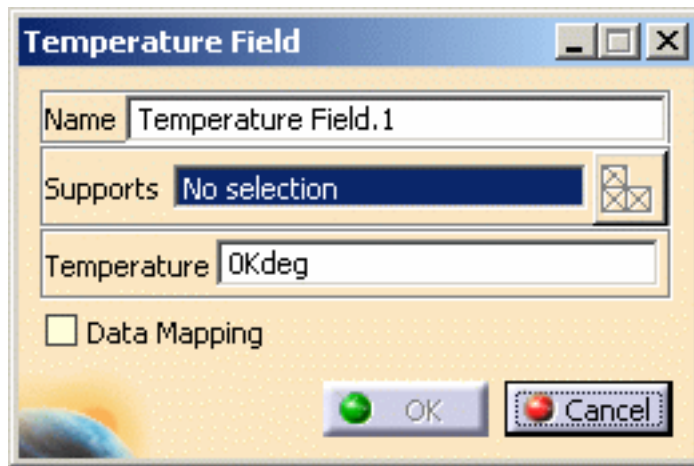

You can re-use data (**Data Mapping**) that are external from this version (experimental data or data coming from in-house codes or procedures). For more details, please refer to [Data Mapping](#).

2. Select the part or surface (body) you wish to be applied a temperature.

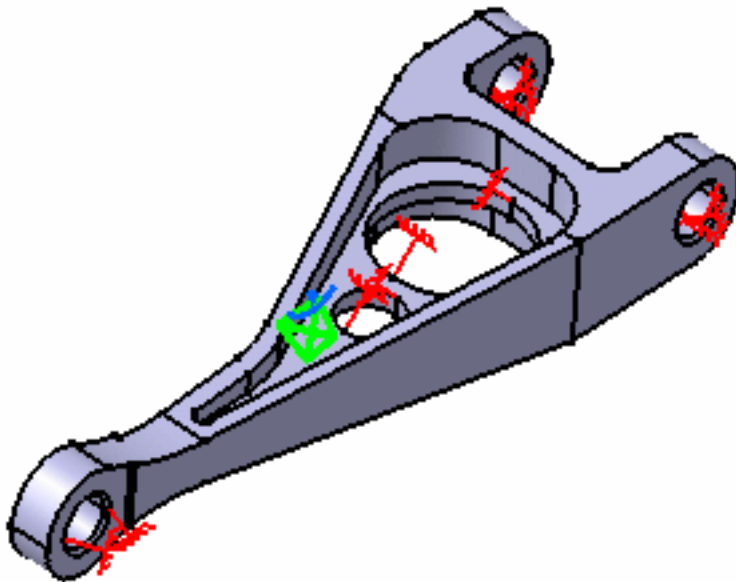

The Temperature Field dialog box is updated.

A **T** symbol now appears on the selected part or surface.

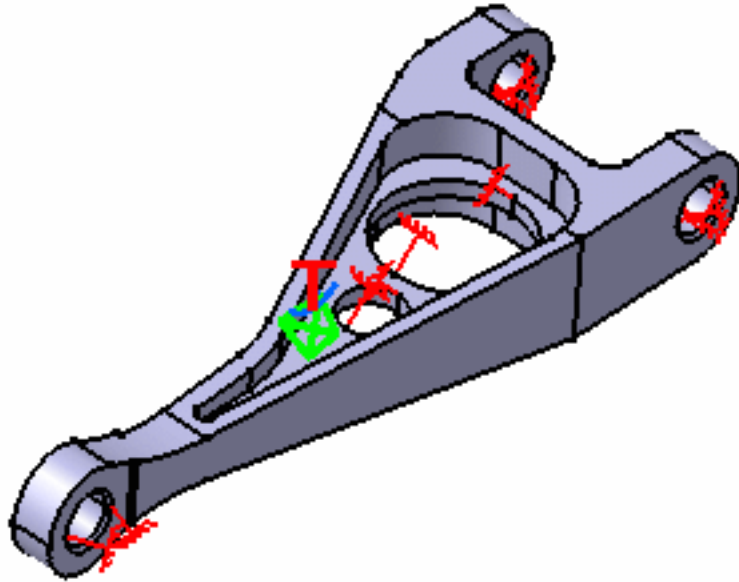

You can activate the **Data mapping** option and use the results coming from a thermal solver.

3. Click **OK** in the Temperature Field dialog box.

The Specification tree is also updated: both the **Environment.1** and the **Temperature Field.1** features appear:

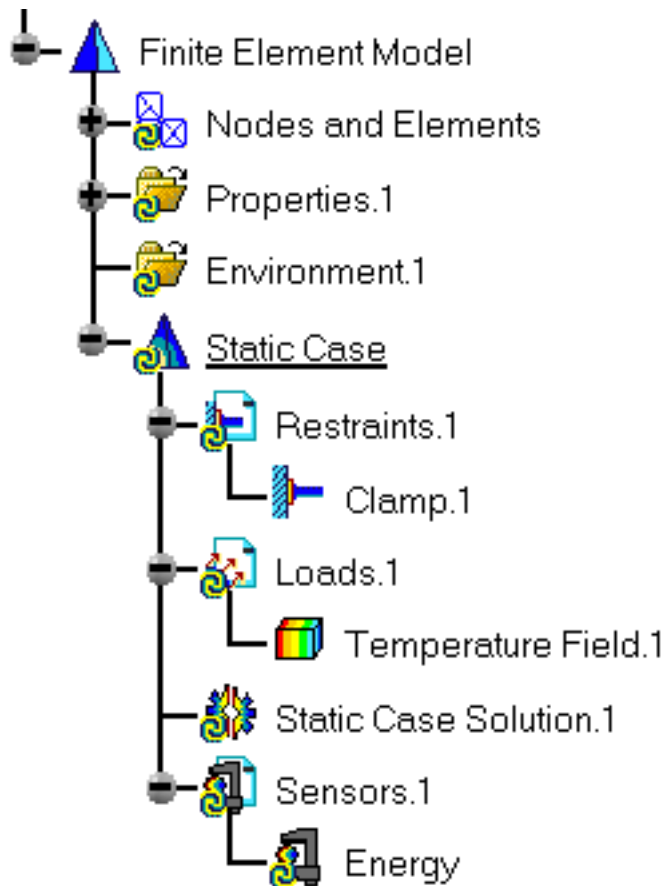

At any time you can double-click the Environment feature and define an **Initial temperature**.

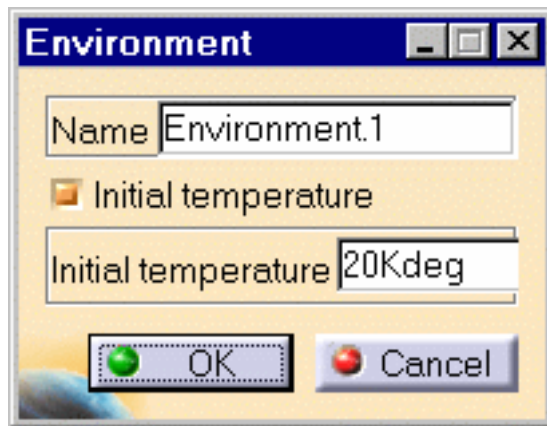

**Double-clicking** on the Loads set, you will display the Loads dialog box that lets you choose whether you wish to apply self-balancing to the load. Example of use: if this option is used with iso-static specifications, it will allow you to simulate free-body loading. If you make the option active, the center of inertia results null.





# Importing Temperature Field from Thermal Solution



This task shows you how to load a body with a given temperature.

Importing Temperature Field from an existing thermal solution means applying a temperature constant or not to a part using an existing thermal solution.

Contrary to the [temperature field](#), you will directly import the temperature field from a thermal solution and so, you do not need to use the data mapping functionality.



Only available with the **ELFINI Structural Analysis (EST)** product.



Temperature Field can be applied to the following types of supports:

Geometrical Feature	Mechanical Feature	Analysis Feature			
		Free Groups	Geometrical Groups	Proximity Groups	Others
Face Body		▲			Mesh Part



1. Select the **Temperature Field from Thermal Solution** icon .

The Temperature Field from Thermal Solution dialog box appears.

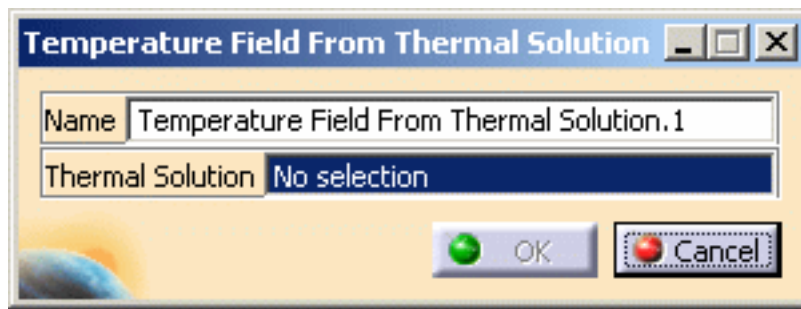

- **Name:** lets you modify the name of the temperature field.
- **Thermal Solution:** lets you select an existing thermal solution.

2. Select the desired thermal solution.
3. Click **OK** in the Temperature Field from Thermal Solution dialog box.

The specification tree is updated: the **Temperature Field from Thermal Solution.1** features appears:

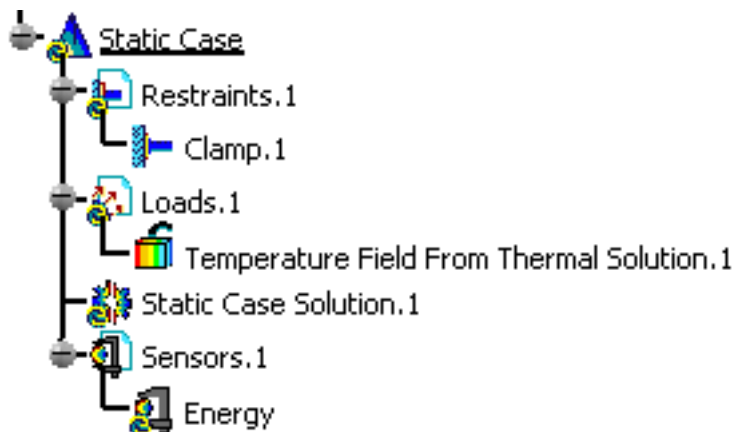

**Double-clicking** on the Loads set, you will display the Loads dialog box that lets you choose whether you wish to apply self-balancing to the load. Example of use: if this option is used with iso-static specifications, it will allow you to simulate free-body loading. If you make the option active, the center of inertia results null.



# Sensors



A sensor is a physical output of a computation, optionally limited to a local area, on which you can apply a post-treatment.

You can get a synthesis of analysis results by creating sensors.

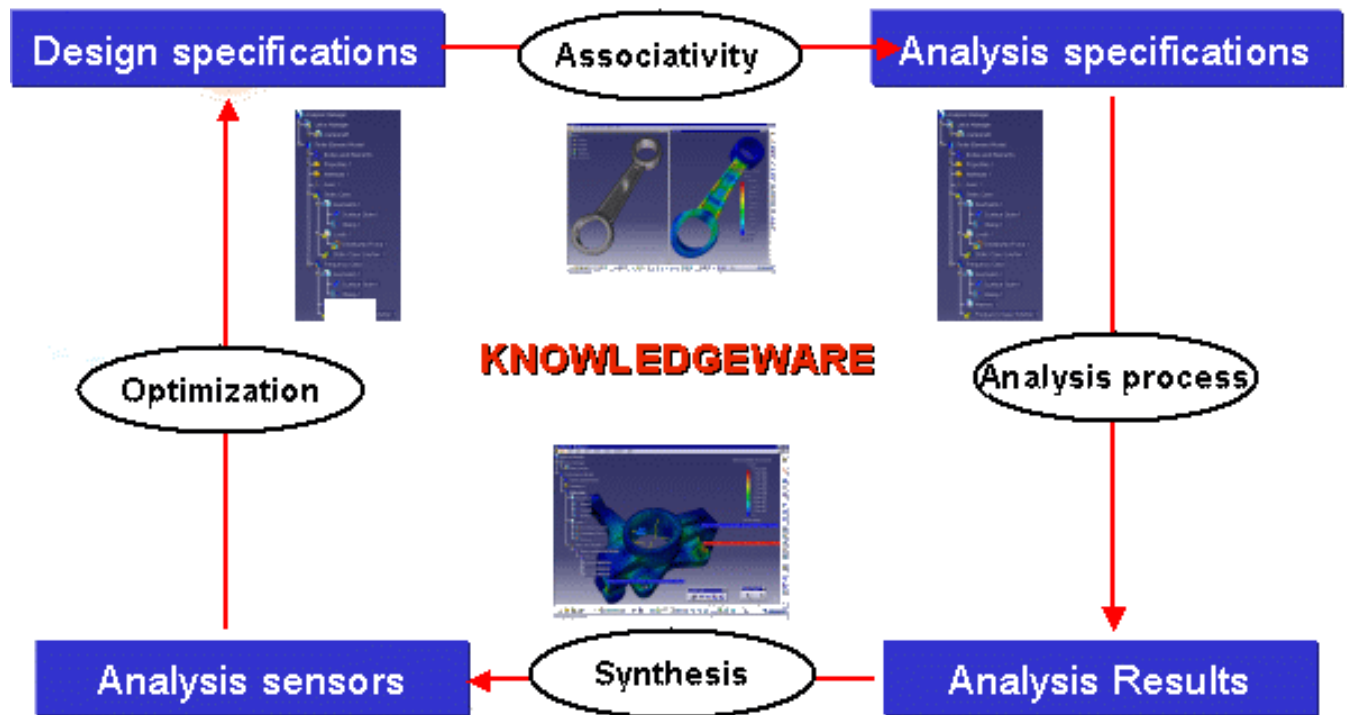

A sensor can produce two kinds of results, depending on the sensor definition and on the analysis case:

- knowledge parameters (single value or list of values): the sensor set provides parameters that can be re-used in Knowledgeware in order to set rules, checks, formulas and Product Engineering Optimizer workbench.
- 2D Display (only in multi-occurrence case): allows you to display the variation of an output for different occurrences.

## Create Global Sensors

Create a sensor on entire model.

## Create Local Sensors

Create a sensor on local area.

## Create Reaction Sensors

Create a reaction sensor.

## Display Values of Sensors

Display values of sensors in the specification tree under a sensor set.

## Integration with Product Engineering Optimizer

Give information about the analysis data authorized in the Product Engineering Optimizer (PEO) product.

# Creating Global Sensors



This task will show you how to create global sensors, available for the entire model.



The global sensors can be used either in a mono-occurrence solution (static solution, combined solution) or multi-occurrence solution (frequency solution, buckling solution).

Analysis Case	Static Case	Frequency Case	Buckling Case	Combined Case
<b>Available global sensor</b>	<b>Energy</b> <b>Error in Energy</b> <b>Global Error Rate (%)</b> <b>Maximum Displacement</b> <b>Maximum Von Mises</b> <b>Mass</b>	<b>Frequency</b> <b>Mass</b>	<b>Buckling</b> <b>Factors</b>	<b>Energy</b> <b>Error in Energy</b> <b>Global Error Rate (%)</b> <b>Maximum Displacement</b> <b>Maximum Von Mises</b> <b>Mass</b>



The 2D Display result is not available for the global sensors.



- Open the [Sample08.CATAnalysis](#) document from the samples directory for this task.
- Compute all the solutions.  
For this, click the **Compute** icon and select the **All** option.

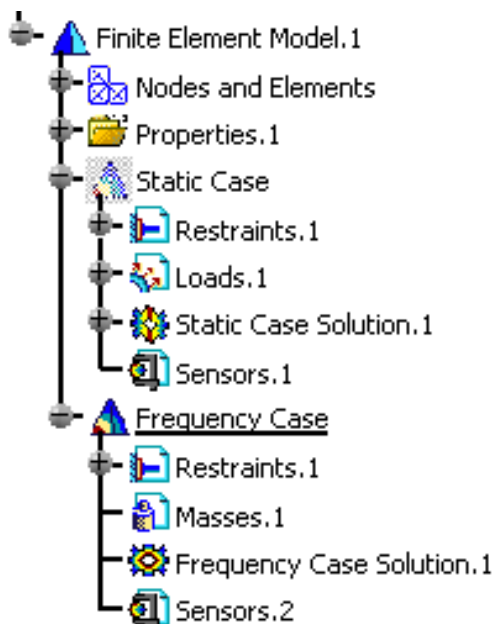





1. Right-click the **Sensors.1** feature in the specification tree and select the **Create Global Sensor** contextual menu.

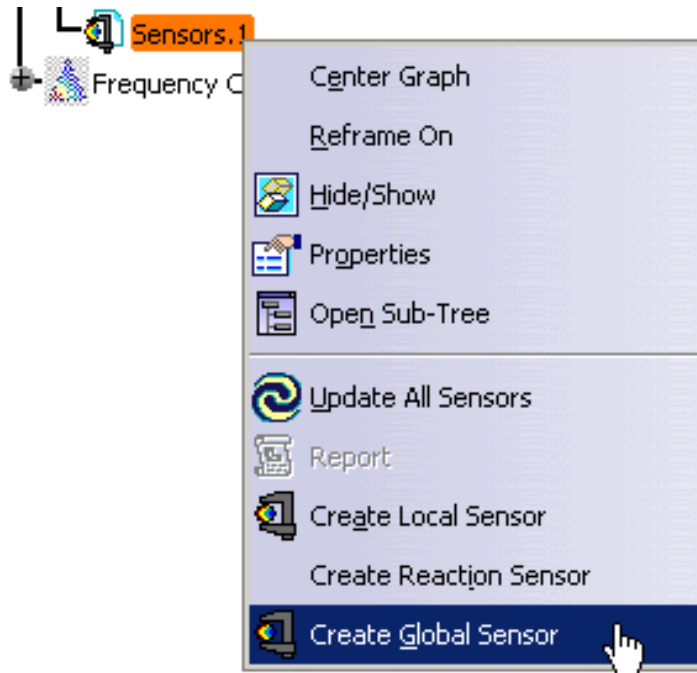

The Create Sensors dialog box appears.

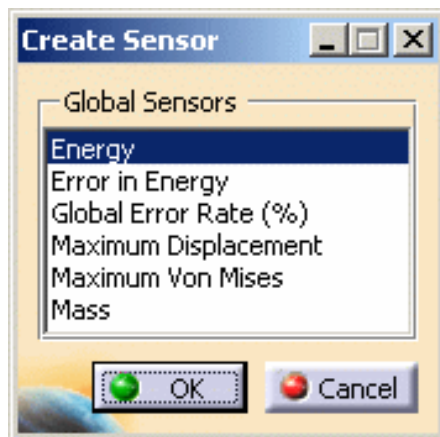

2. Select the desired global sensor in the Create Sensor dialog box.

In this particular case, select the **Energy** global sensor.

3. Click **OK** in the Create Sensor dialog box.

An **Energy** object appears in the specification tree.



You can edit a parameter to change the name or to visualize the associated value.

For this, double-click the knowledge parameter in the specification tree.

The Edit Parameter dialog box appears.

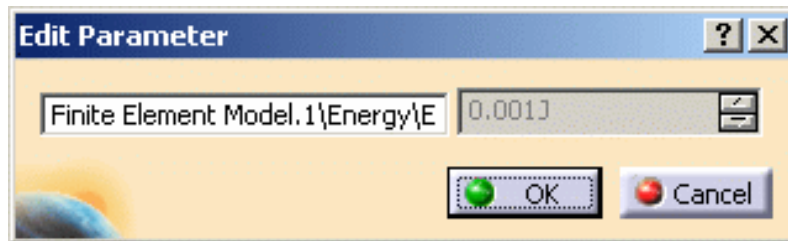

4. Right-click the **Sensors.2** feature in the specification tree and select the **Create Global Sensor** contextual menu.

The Create Sensor dialog box appears.

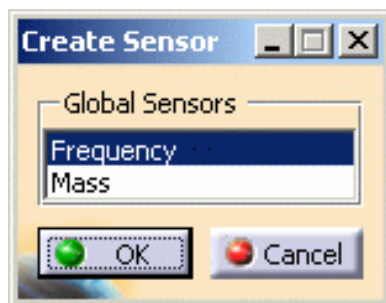

5. Select the **Frequency** option and click **OK** in the Create Sensor dialog box.

A **Frequency** object appears in the specification tree under the **Sensor.2** object.

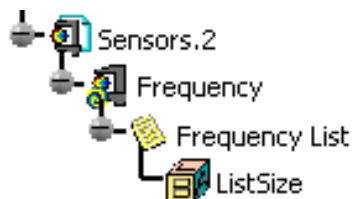



You can see that a **Frequency List** has also appeared. This object lists the parameters under only one specification tree node.

6. Edit the frequency global sensor. For this, double-click the **Frequency** object in the specification tree.

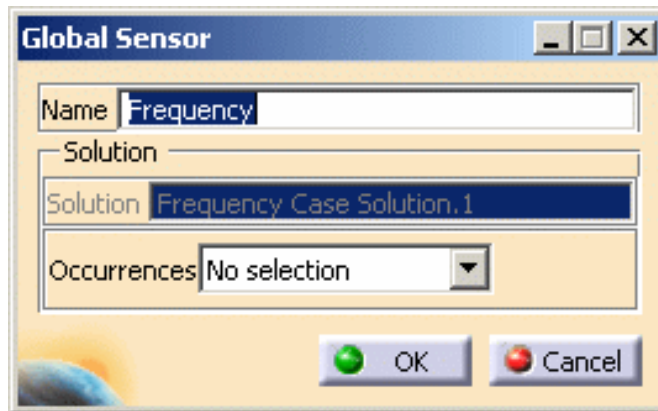
The Global Sensor dialog box appears.



- o Name: lets you change the name of the sensor
- o **Occurrences**: lets you preserve the selected occurrences
  - **No Selection**: no occurrence will be preserved
  - **Value to Approach**: lets you preserve the occurrences that approach a selected value
  - **Intervals**: lets you preserve the occurrences include in a selected interval
  - **Occurrence Numbers Selection**: lets you preserve the occurrences of which the numbers have been selected
  - **Occurrence Values Selection**: lets you select the occurrences of which the values have been selected
  - **All**: lets you preserve all the occurrences
  - **Component Edition** : this button lets you select the desired occurrences
    -  This button is only available if you selected one of the following options: **Value to Approach**, **Intervals**, **Occurrence Numbers Selection** or **Occurrence Values Selection**.
  - **Edit Filtered Occurrences** : this button lets you visualize the selected occurrences



This button is only available if you selected one of the following options:  
**Value to Approach, Intervals, Occurrence Numbers Selection, Occurrence Values Selection or All.**

For example, if you select the **Intervals** options:

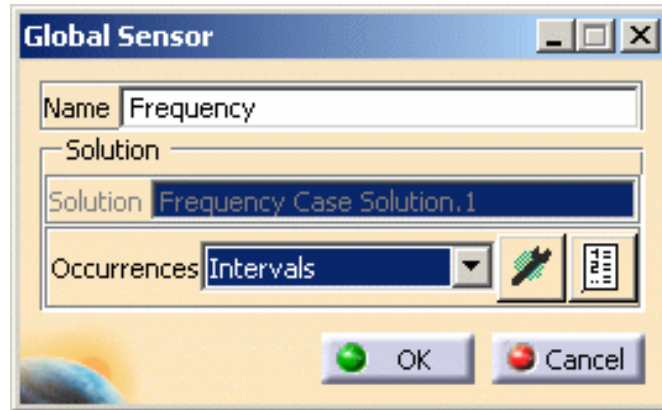

7. Select the **All as Occurrences** option in the Global Sensor dialog box.

The Global Sensor dialog box appears as shown bellow:

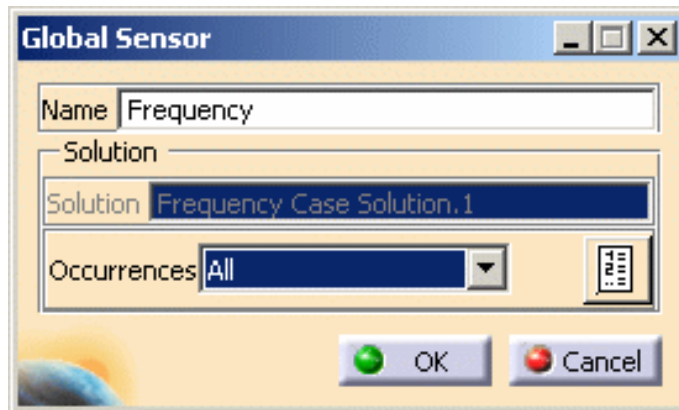

You can visualize the occurrences you have chosen.

For this, click the **Edit Filtered Occurrences** button  in the Global Sensor dialog box. The Solution dialog box appears.

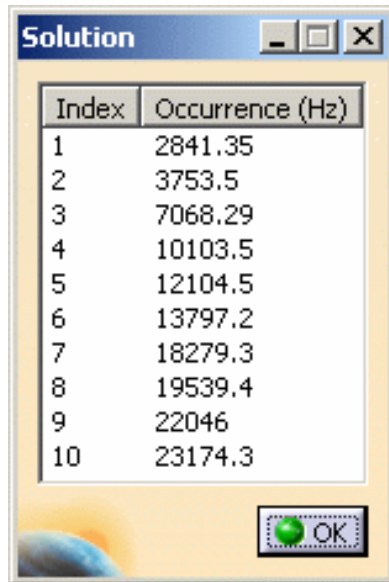

8. Click **OK** in the Solution dialog box and then in the Global Sensor dialog box.
9. Update the **Frequency** global sensor. For this, please refer the [Update a sensor](#) paragraph.
10. Double-click the **Frequency List** object in the specification tree.

The List Edition dialog box appears.

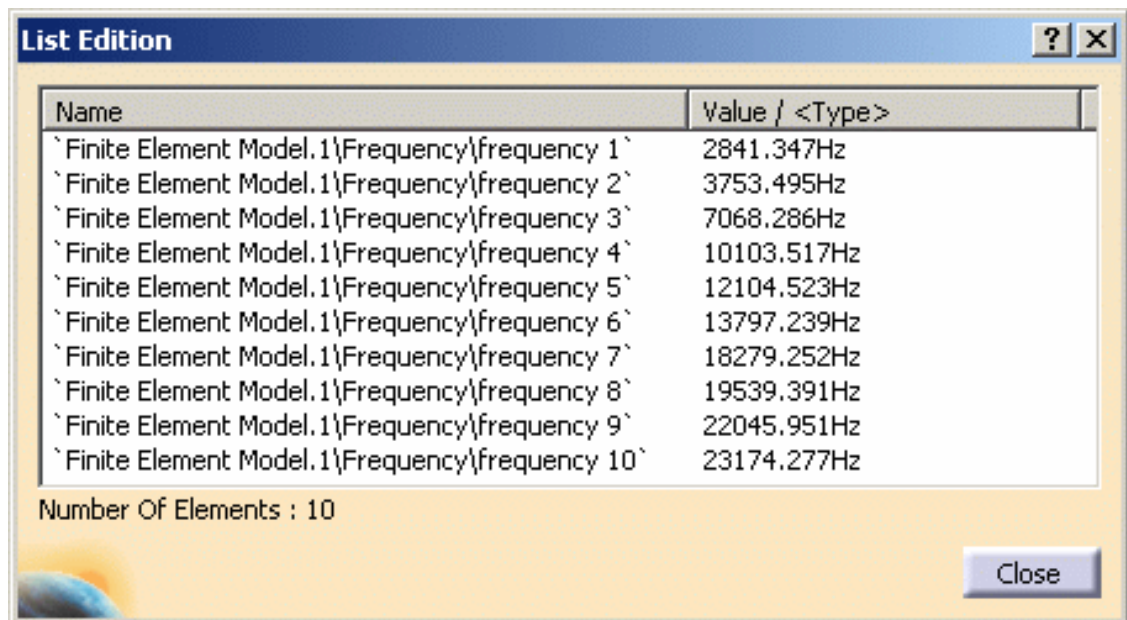

11. Click **OK** in the List Edition dialog box.



You can display the value of knowledge parameters in the specification tree.

For more details, please refer to [Displaying Values of Sensors](#).



You can update the sensor you just have created or modified. You can also update all the sensors which are under a sensor set.

- **Update a sensor:**

For this, right-click the sensor you want to be updated and select the Update Sensor contextual menu.

- **Update all sensors under a sensor set:**

For this, right-click the sensor set you want to be updated and select the Update All Sensors contextual menu.



# Creating Local Sensors



This task will show you how to create and edit local sensors.









































A local sensor is a physical output (stress, strain, force, ...) of the computation limited to a local area (body, edge, face, vertex, mechanical feature), on which a post-treatment has been optionally applied (Max, Min, Average, ...).



The local sensors can be used either in a mono-occurrence computed solution (static solution) or multi-occurrence computed solution (frequency, buckling or dynamic solution).

- mono-occurrence solution
- multi-occurrence solution

Local Sensor	Static Case	Frequency Case	Dynamic Case (Harmonic or Transient)	Buckling Case	Combined Case	Static Constrained
Displacement Magnitude						
Displacement Vector						
Relative Displacement			 (restraint excitation)			
Rotation Vector						
Force	*				*	*
Moment	*				*	*

Von Mises Stress						
Stress Tensor						
Principal Shearing						
Principal Stress Tensor						
Principal Strain Tensor						
Strain Tensor						
Elastic Energy						
Error						
Acceleration vector						
Relative Acceleration vector			 (restraint excitation)			
Velocity vector						



Relative Velocity vector			 (restraint excitation)			
* only available with the <b>ELFINI Structural Analysis (EST)</b> product						



### **Mono-occurrence:**

The creation of knowledge parameters is restricted to:

- the case of a single point support
- the case of other support type only if the post-treatment is different of none

### **Multi-occurrence:**

The creation of knowledge parameters and the generation of a 2D Display are restricted to the cases of:

- the case of a single point support
- the case of other support type only if the post-treatment is different of none

For more details about the 2D Display generation, please refer to [Generating 2D Display for Sensors](#).



Open the [sample08.CATAnalysis](#) document from the samples directory for this task.

### **Before You Begin:**

Compute all the solutions. For this, click the **Compute** icon and select the **All** option.

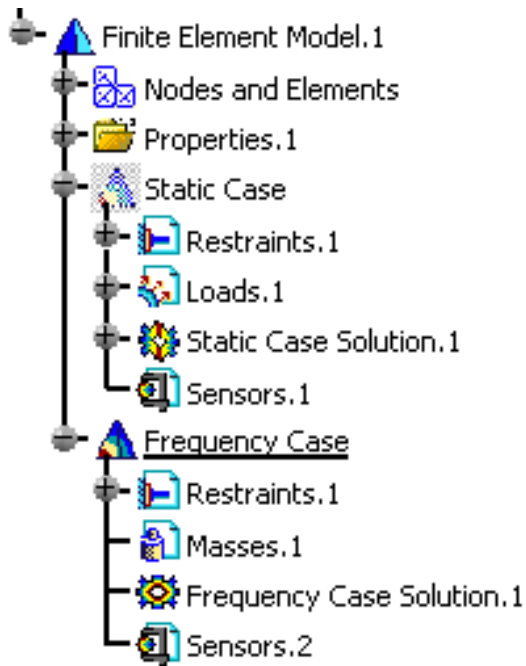

You will now see two examples of local sensor creation in case of [mono-occurrence solution](#) and in case of [multi-occurrence solution](#).

## Mono-occurrence solution



1. Activate a static case, if needed.

For this, right-click the Static Case set in the specification tree and select the **Set As Current Case** contextual menu.

2. Right-click on the **Sensors.1** feature in the specification tree and select the **Create Local Sensor** contextual menu.

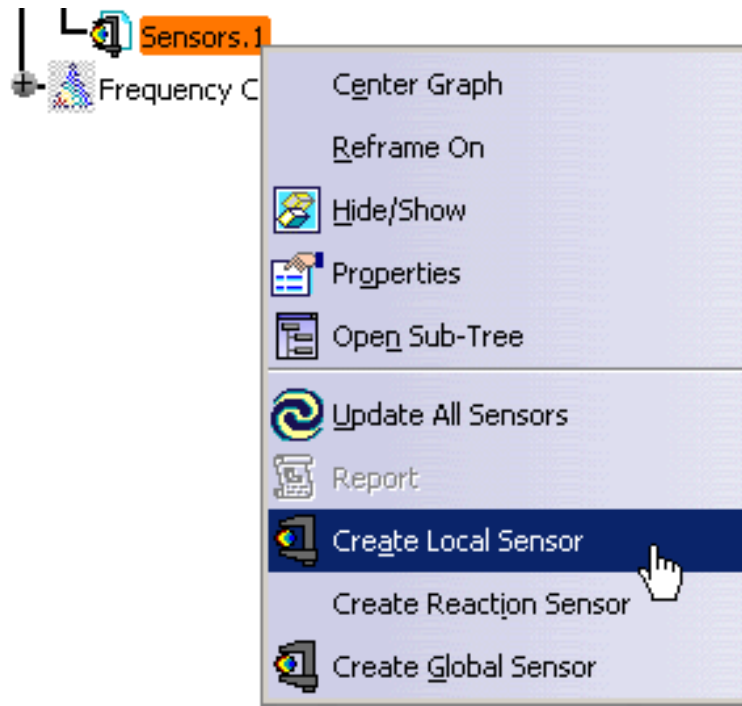

The Create Sensors dialog box appears.

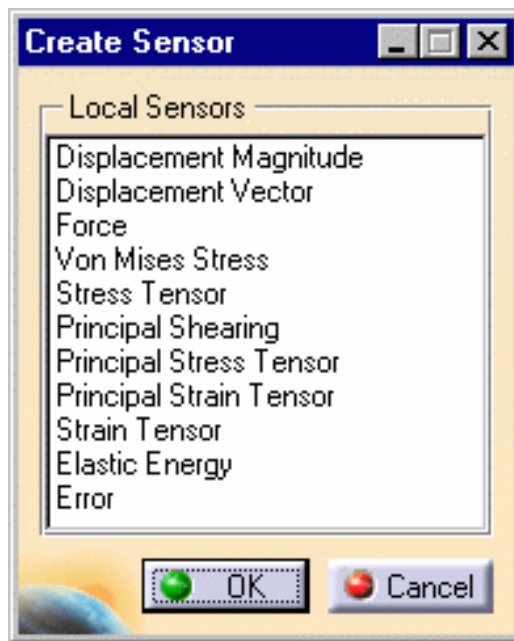

3. Select the desired local sensor and click **OK** in the Create Sensor dialog box.

In this example, select the **Displacement Vector** local sensor.

The **Displacement Vector** object appears in the specification tree.

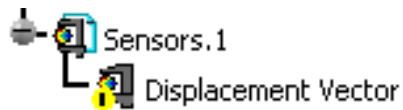

The **Displacement Vector** is not yet valid. To make it valid, you have to edit it.

4. Double-click the **Displacement Vector** object in the specification tree.

The Local Sensor dialog box appears.

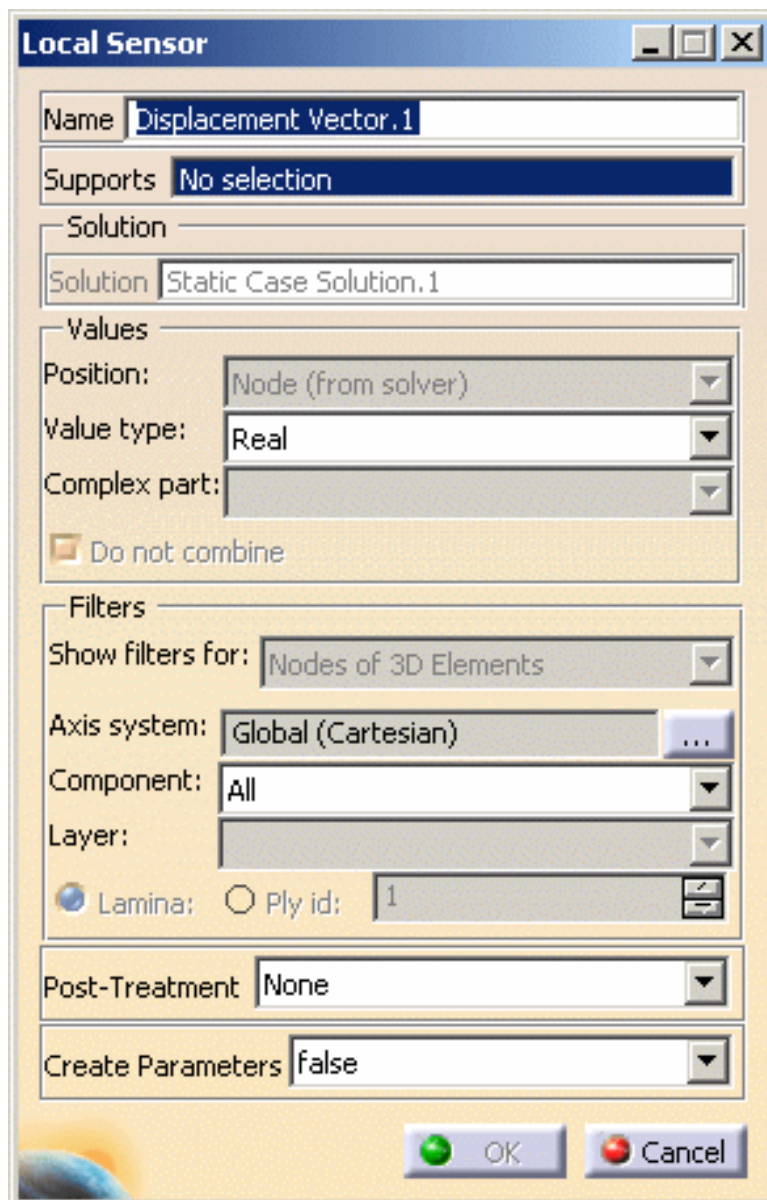

- o **Name:** gives you the name of the sensor.
- o **Supports:** gives you the support definition (vertex, edge, face, body, group,

feature).

- **Solution:** gives you the name of the solution on which you are working.
- **Values:** for more details, please click [here](#).
- **Filters:** for more details, please click [here](#).
- **Post-Treatment:** lets you take the minimum, maximum or average value of the results.
- **Create Parameters:** lets you generate, when it is possible, knowledge parameters.

**5.** Select the desired parameters in the Local Sensor dialog box.

In this particular example, select:

- a face as **Support**
- **Real** as **Value type**
- **All** as **Components**
- **Maximum** as **Post-Treatment**
- **True** as **Create Parameters**

**6.** Click **OK** in the Local Sensor dialog box.



The **OK** button is read only in the Local Sensor dialog box as long as the sensor is not valid.

**7.** Update the **Displacement Vector** local sensor. For this, please refer to the [Update a sensor](#) paragraph.

A knowledge parameter appears in the specification tree without associated value.



**8.** Double-click the **Displacement Vector** sensor in the specification tree.

**9.** Select **C1** as **Components** option and click **OK** in the Local Sensor dialog box.

**10.** Update the **Displacement Vector** local sensor. For this, please refer to the [Update a sensor](#) paragraph.

A label containing the maximum value appears on the geometry.

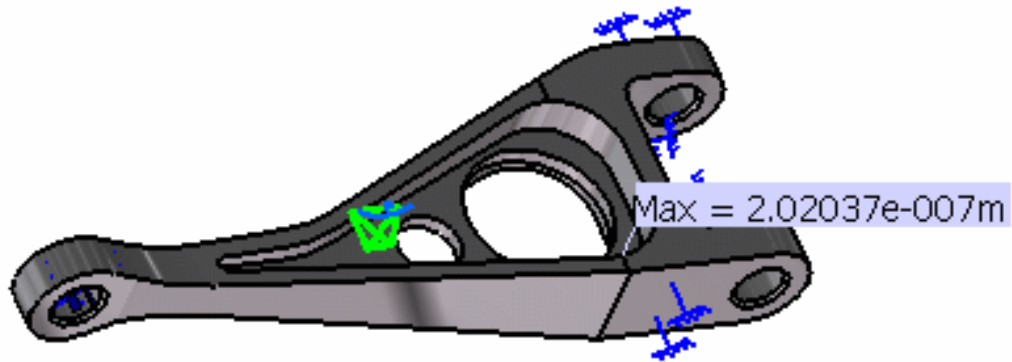

This visualization type is only available if the local sensor:

- a. is created in case of mono-occurrence solution
- b. is defined with any of the **Components** options except the **All** option.
- c. is defined with a **Minimum** or **Maximum Post-Treatment** value
- d. is updated



- You can display the value of knowledge parameters in the specification tree. For more details, please refer to [Displaying Values of Sensors](#).
- You can also export data associated to a local sensor (only available if you installed the **ELFINI Structural Analysis (EST)** product).



The **Export Data** contextual menu is only available on mono-occurrence local sensor without post-treatment.

To export data on local sensor, right-click a local sensor in the specification tree and

then select the **Export Data** contextual menu  **Export Data**.



## Multi-occurrence solution



1. Right-click on the **Sensors.2** feature in the specification tree and select the **Create Local Sensor** contextual menu.

The Create Sensors dialog box appears.

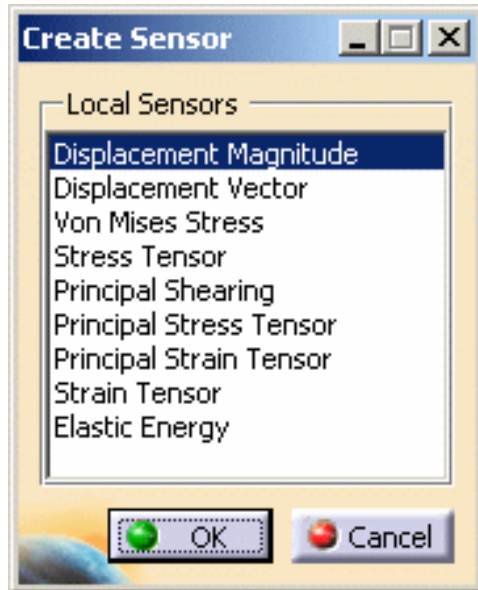

2. Select the desired local sensor in the Local Sensor dialog box.

In this example, select **Von Mises Stress** and click **OK** in the Create Sensor dialog box.

The **Von Mises Stress** object appears in the specification tree.



The **Von Mises Stress** is not yet valid. To make it valid, you have to edit it.

3. Double-click the **Von Mises Stress** object in the specification tree.

The Local Sensor dialog box appears.

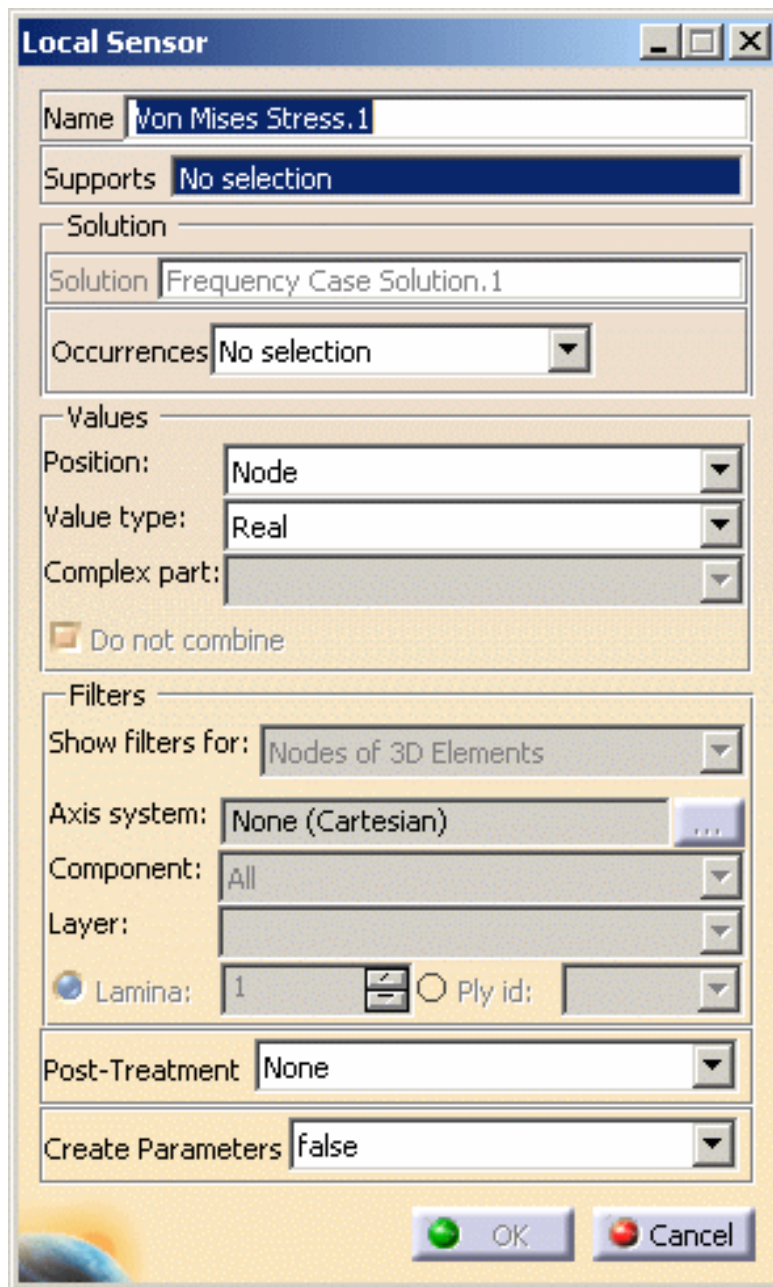

- **Name:** gives you the name of the sensor.
- **Supports:** gives you the support definition (vertex, edge, face, body, group, feature).
- **Solution:** gives you the name of the solution on which you are working.
- **Occurrences:** lets you preserve the selected occurrences.
  - **No Selection:** no occurrence will be preserved.
  - **Value to Approach:** lets you preserve the occurrences that approach a selected value.
  - **Intervals:** lets you preserve the occurrences include in multi-selected intervals.



- **Occurrence Numbers Selection:** lets you preserve the occurrences of which the numbers have been selected.
- **Occurrence Values Selection:** lets you select the occurrences of which the values have been selected.
- **All:** lets you preserve all the occurrences.

- **Component Edition** : this button lets you select the desired occurrences.



This button is only available if you selected one of the following options: **Value to Approach, Intervals, Occurrence Numbers Selection or Occurrence Values Selection.**

- **Edit Filtered Occurrences** : this button lets you visualize the selected occurrences.



This button is only available if you selected one of the following options: **Value to Approach, Intervals, Occurrence Numbers Selection, Occurrence Values Selection or All.**

For example, if you select the **Intervals** options:

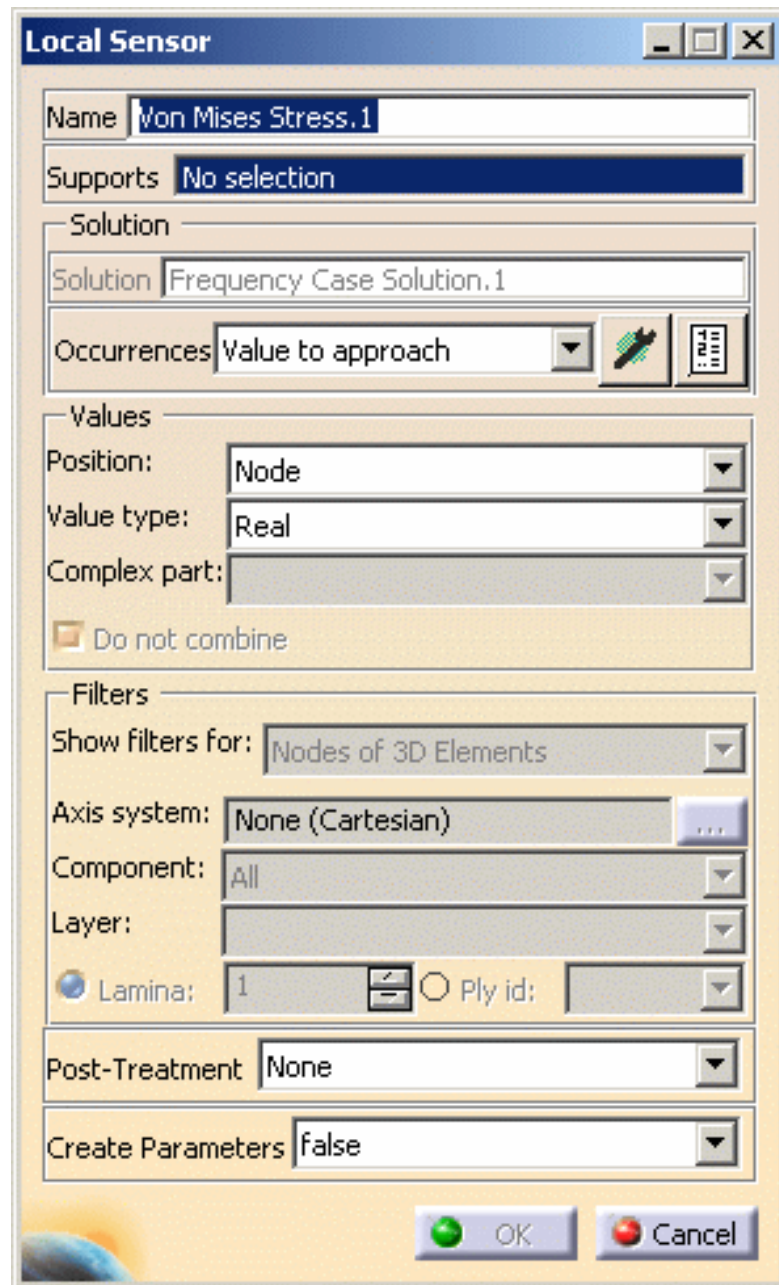

- **Values:** for more details, please click [here](#).
- **Filters:** for more details, please click [here](#).
- **Post-Treatment:** lets you take the minimum, maximum or average value of the results.
- **Create Parameters:** lets you generate, when it is possible, knowledge parameters.

4. Select the desired parameters in the Local Sensor dialog box.

In this particular example, select:

- a vertex as **Support**
- **All** as **Occurrences**
- **Node** as **Position**
- **Real** as **Value type**
- **Maximum** as **Post-Treatment**
- **True** as **Create Parameters**

5. Click **OK** in the Local Sensor dialog box.

6. Update the **Von Mises Stress** local sensor. For this, please refer to the [Update a sensor](#) paragraph.

The knowledge parameters appear in the specification tree without the values.

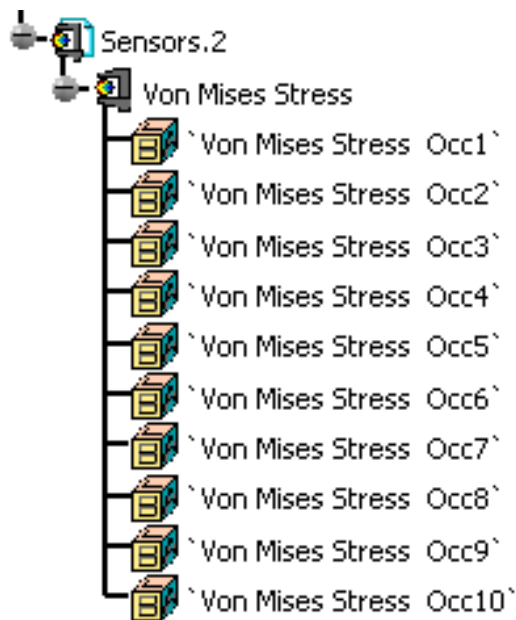

You can display the value of knowledge parameters in the specification tree.

For more details, please refer to [Displaying Values of Sensors](#).





You can update the sensor you just have created or modified. You can also update all the sensors which are under a sensor set.

- **Update a sensor:**

For this, right-click the sensor you want to be updated and select the **Update Sensor** contextual menu .

- **Update all sensors under a sensor set:**

For this, right-click the sensor set you want to be updated and select the **Update All Sensors** contextual menu.

# Creating Reaction Sensors



This task will show you how to create and edit reaction sensors.

A reaction represents the resulting force and moment at restraint and connection specifications.



Reaction sensors are only available in a Static Analysis Case.



Open the [Sample08.CATAnalysis](#) document from the samples directory for this task.

## Before You Begin:

Compute all the solutions. For this, click the **Compute** icon and select the **All** option.

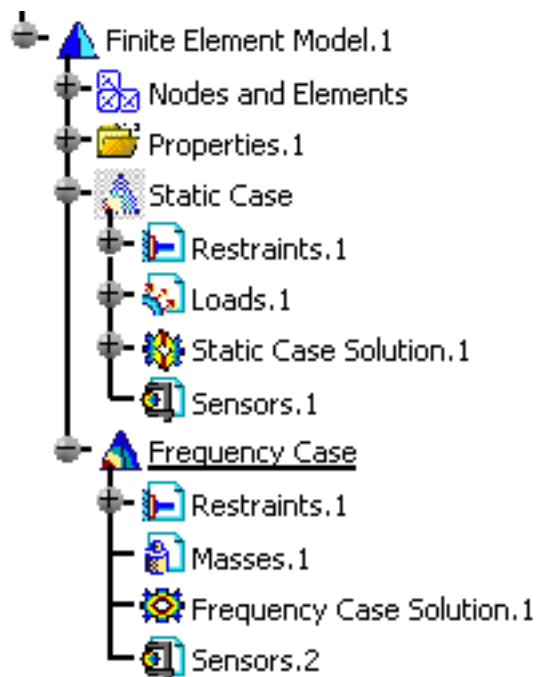



1. Right-click the **Sensors.1** object in the specification tree and select the **Create Reaction Sensor** contextual menu.

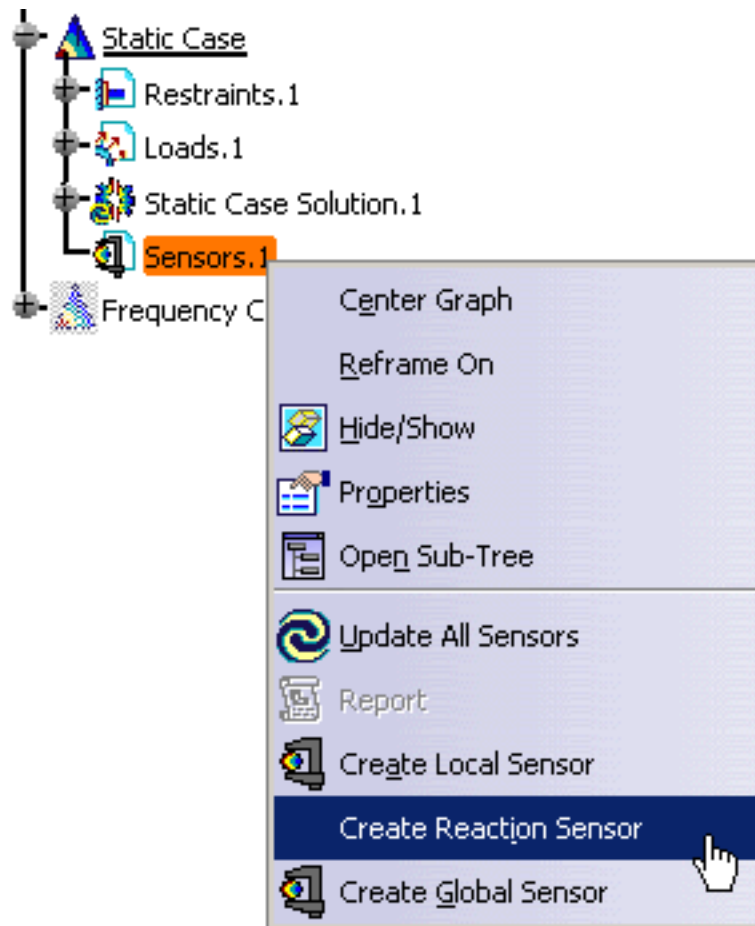

The Reaction Sensors dialog box appears.

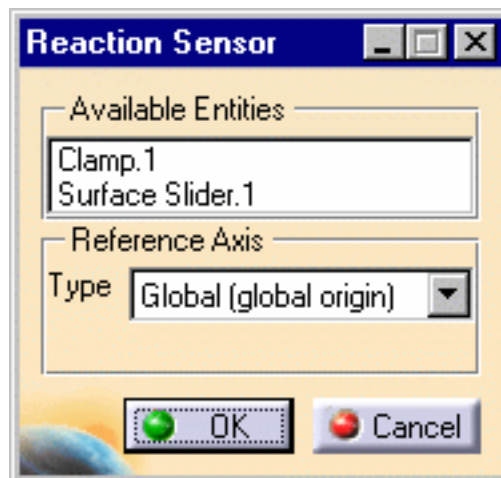

- o **Available Entities:** lets you choose the restraint and connection properties (except for Spot Weld and Seam Weld Connections)



You can access the values of the reactions inside any connection using the image edition.

For this:

**a.** Right-click the **Properties** set in the specification tree.

**b.** Select the **Generate Image** contextual menu.

The Image Generation dialog box appears.

**c.** Select the **Point Force Vector** image or the **Point Moment Vector** image and click **OK** in the Image Generation dialog box.



The **Point Force Vector** and the **Point Moment Vector** images are only available if you installed the ELFINI Structural Analysis product.

**d.** Double-click the image you just have generated in the specification tree.

The Image Edition dialog box appears.

**e.** Select:

- **Text** type in the **Visu** tab
- **Node of element** as **Position Value Control** in the **Filters** tab
- **Connection Mesh** object in the **Selections** tab

**f.** Click **OK** in the Image Edition dialog box.

For more details about image generation and image edition, please refer to [Generating Images](#) and [Editing Images](#) in this guide.

- **Reference Axis Type:** lets you choose the type of axis in which the reaction sensor will be computed and displayed in the 3D view
  - **Global (global origin):** corresponds to the absolute origin
  - **Global (local origin):** corresponds to the handling point for a virtual point entity or a geometric center for other entities
  - **User:** lets you select an existing reference axis system either in the specification tree or directly in the 3D view.

**2.** Select the desired **Available Entities** (previously created on the CATAnalysis document) in the Reaction Sensor dialog box.



Note that: multi-selection is available (for example, you can select several restraints).

In this particular case, select the **Clamp.1** in the Reaction Sensor dialog box.

3. Select the desired **Reference Axis Type** in the Reaction Sensor dialog box.

In this particular case, select the **Global (global origin)** option.

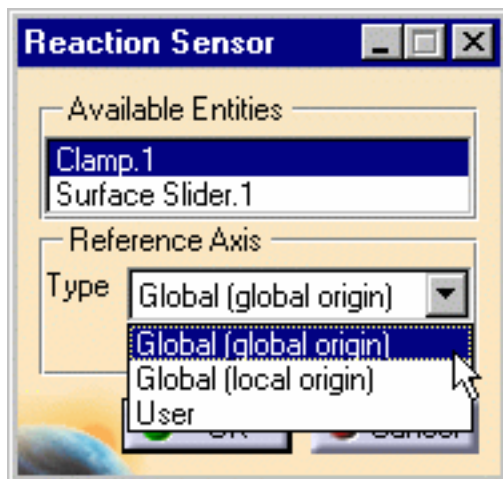

4. Click **OK** in the Reaction Sensor dialog box.

The **Reaction -> Clamp.1** object appears in the specification tree.

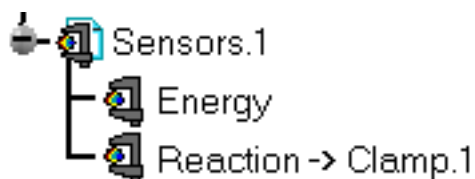

You can edit the reaction sensor name you just have created and visualize the different parameters you just have defined.

For this, double-click the **Reaction -> Clamp.1** object in the specification tree.

The Reaction Tensor dialog box appears.



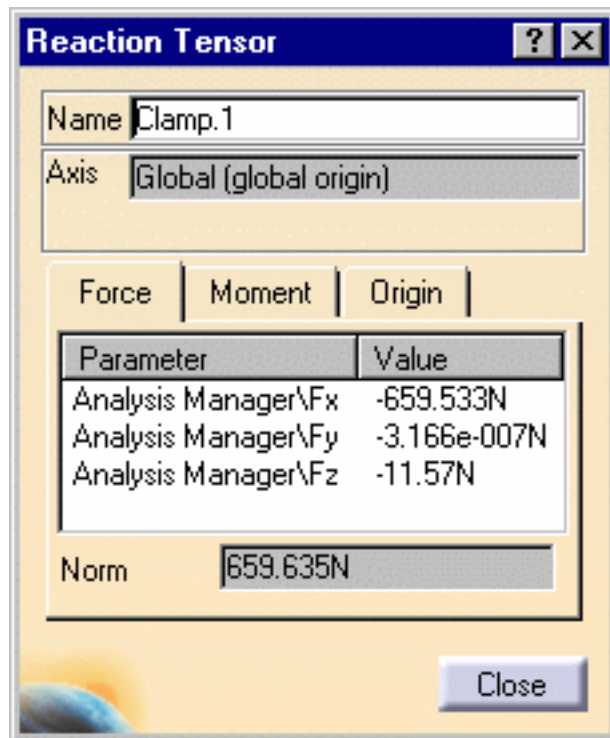

- **Name:** gives you the name of the selected entity
- **Axis:** reminds you the reference axis type you have previously selected
- **Force** tab: gives the force values of the parameters
- **Moment** tab: gives the moment values of the parameters
- **Origin** tab: gives the coordinates of the center point of the axis (relative to the global axis)



You can update the sensor you just have created or modified. You can also update all the sensors which are under a sensor set.

- **Update a sensor:**  
For this, right-click the sensor you want to be updated and select the Update Sensor contextual menu.
- **Update all sensors under a sensor set:**  
For this, right-click the sensor set you want to be updated and select the Update All Sensors contextual menu.



# Displaying Values of Sensors



This task will show you how to display the values of the knowledge parameters in the case of global and local sensors.



1. Select the **Tools -> Options...** command to open the Options dialog box.
2. Click the **Knowledge** tab in the **General -> Parameters and Measures** category.
3. Select the **With value** option in the **Knowledge** tab.

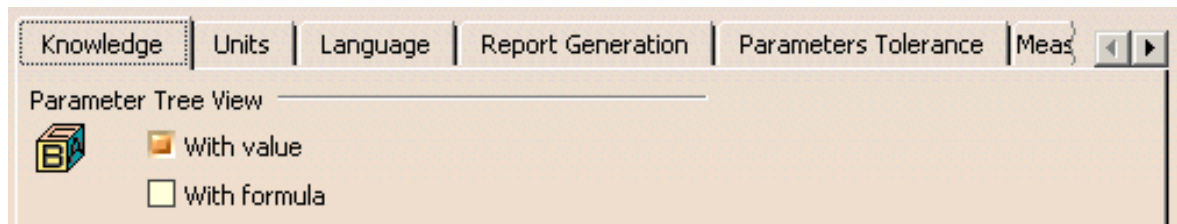

4. Click **OK** in the Options dialog box.

The specification tree is automatically updated and you can visualize the sensor value.

You can retrieve hereunder the result of the knowledge parameters display for the examples of the [Creating Global Sensors](#) and [Creating Local Sensors](#) tasks:

- o Energy global sensor



- o Displacement Vector local sensor (mono-occurrence solution)

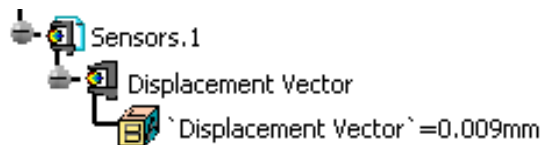

- o Von Mises Stress local sensor (multi-occurrence solution)

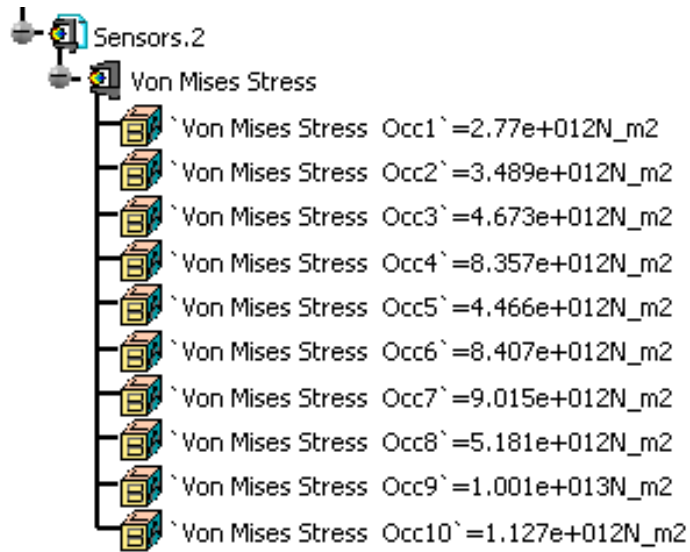

### Customizing the decimal number

You can also change the decimal number in the **Units** tab of the Options dialog box.



# Results Computation

## External Storage



### Specify External Storage

Specify the path of an external storage file directory (computation and result data).



### Clear Data

Clear Elfini Storage in order to save space on your disk (either computation data exclusively or both result and computation data).



### Specify Temporary Data Directory

Specify a temporary data directory for the CATElfini stored data and computation results.

## Computation



### Compute Objects

Perform finite element computations on one or several objects.

### Compute a Static Solution

Perform a static computation on one or several Static Analysis Cases.

### Compute a Static Constrained Solution

Perform a static constrained computation on one or several Static Constrained Modes.

### Compute a Frequency Solution

Perform a normal vibration modes computation on one or several Frequency Analysis Cases.

### Compute a Buckling Solution

Perform a normal buckling modes computation on one or several Buckling Analysis Cases.

### Compute a Harmonic Dynamic Case

Perform a normal dynamic modes computation on one or several Harmonic Dynamic response Cases.

### Compute a Transient Dynamic Case

Perform a normal dynamic modes computation on one or several Transient Dynamic response Cases.

### Compute Using a Batch

Update and compute a CATAnalysis document using a batch.

## Computing with Adaptivity



### Compute with Adaptivity

Computing adaptive solutions.

# Specifying External Storage



This task shows how to specify External Storage in a particular case.



All ELFINI Solver computations (matrices, operators, displacements, intermediate entities and so forth) are systematically stored in a structured way out of core memory, on an external file.

*External Storage* is the file of the directory where this structured computed data is stored.

The link between the .CATAnalysis document and the External Storage is maintained after the end of a session, in a way similar to the link between a .CATPart document and the associated .CATAnalysis document.

Stored data resulting from analysis are stored in two files, one for results and one for computations. After the opening of a new analysis document, the default directories in which they are stored are the last directories chosen by the user.

*Result data* is data necessary for generating images: displacements, loads, restraints, singularities, strain energy and so forth. This data is self sufficient if only results are to be saved and no more computations should be performed from them. Result data takes small disk space, any newly performed computation starts from the beginning and therefore may take time.

*Computation data* corresponds to matrices such as stiffness. This data is needed to perform new computations from the loaded data which will benefit from it. It is time saving, but as a counterpart needs much disk space storage.

Computation data can be removed by activating the "Clear storage" command before saving the analysis document.



The default storage location of computation files can be previously set.

For more details, please refer to [External Storage](#) in the Customizing section.



Open the [sample01.CATAnalysis](#) document from the samples directory.



1. Click the **External Storage** icon .

The External Storage dialog box appears.

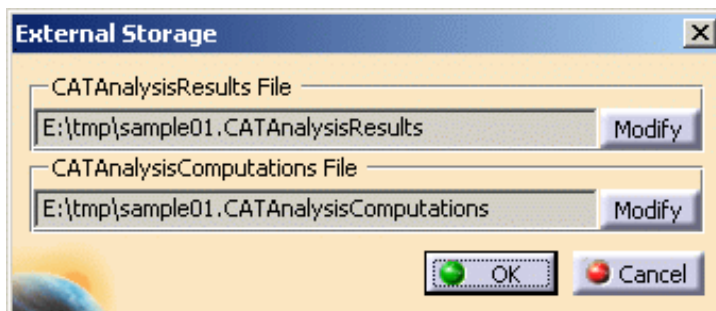

The results and computation data are stored in one single file with given extensions:

- o **xxx.CATAnalysisResults**
- o **xxx.CATAnalysisComputations**

2. If needed, click the **Modify** button.

The Selection dialog box appears.

3. Select the desired external storage directory and then click **Save** in the Selection dialog box.

The selected path name is visualized in the External Storage dialog box.

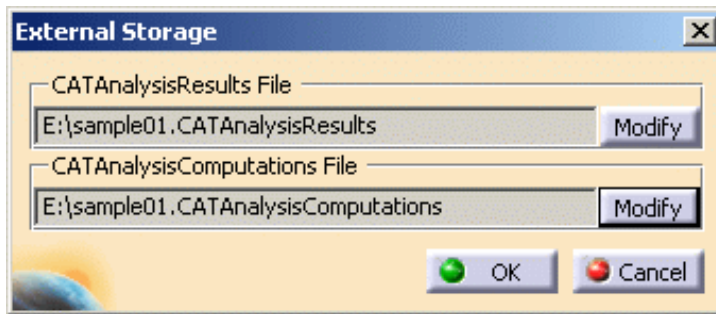

You can still modify or cancel your file selection by clicking the **Modify** or **Cancel** buttons.

4. Click **OK** in the External Storage dialog box.

Your External Storage file has been stored and the extensions are kept.

The file locations objects (**CATAnalysisResults** and **CATAnalysisComputations**) appear in the specification tree, under **Links Manager**.

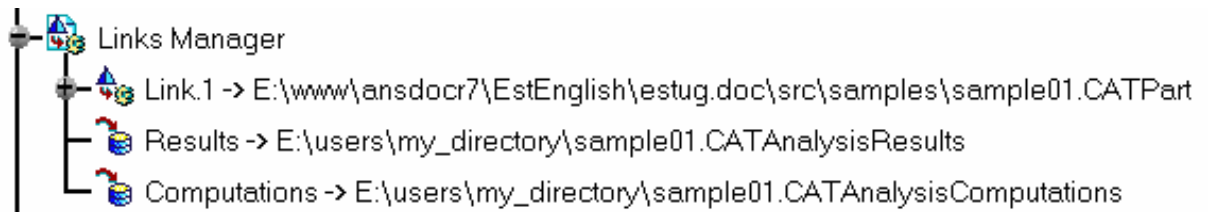

- You can modify the location using the specification tree. Double-click either the **CATAnalysis Results** and **CATAnalysis Computations** in the specification tree: the External Storage dialog box appears with the selected link only. You can now modify the path of the file again.

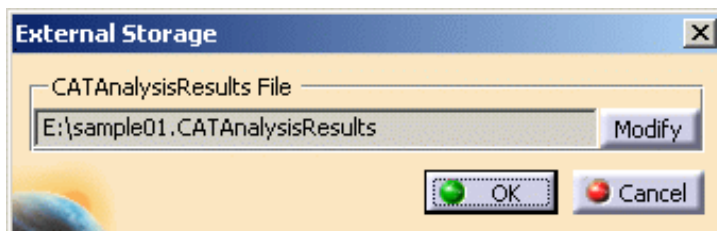

- When External Storage files are created, the default file names are based on the current analysis document file name.

Both files (CATAnalysisResults and CATAnalysisComputations) are created when:

- a computation is launched,
- one of the external storage commands is launched.

Note that storage names only change if you request it, except for the above mentioned cases.

Attention should be ported on the **Save As** operation : changing the CATAnalysis path without changing those of the external storage files will not be allowed (unless you activate the **Automatic Renaming** option). An error message will be displayed.

- If computations file size exceeds two Gb, additional CATAnalysisComputations files are created and the corresponding links appear in the **Links Manager** feature (specification tree).



# Clearing External Storage



This task shows how to clear external storage in order to save space on your disk.



Open the [sample18.CATAnalysis](#) document from the samples directory.



1. Click the **External Storage Clean-up** icon .

The External Storage Clean-up dialog box appears

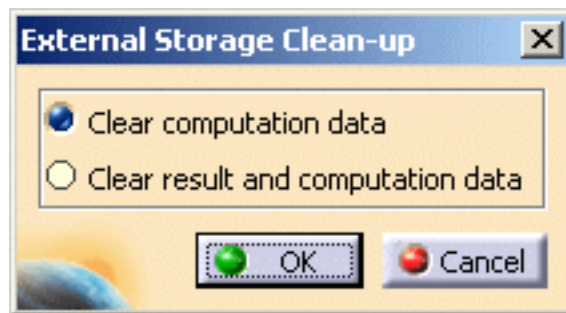

- **Clear computation data:** lets you clear only computation data
  - **Clear result and computation data:** lets you clear both result and computation data
2. Select the desired option.

In this particular case, select the **Clear computation data** option.

3. Click **OK** in the External Storage Clean-up dialog box.

As mentioned in the confirmation dialog box that appears, you should know that this command will remove some data from all the solutions and that it may take time to rebuild them.





# Specifying Temporary External Storage



This task shows how to specify a temporary data directory for the CATAnalysis stored data and computation results.



During an analysis session, current data is stored in a *temporary directory*.

The Save operation makes current data become persistent by saving it from the temporary data directory into two result computation storage files. As a result, current changes do not alter previously loaded results and computations data unless you perform a Save operation.

The temporary data directory is cleared each time the related analysis session is closed.

The default settings for the temporary data directory is the temporary directory of your computer. Due to the important disk space generally required for analysis computations, it is highly recommended that you change default settings by specifying a new temporary directory.



Open the [sample01.CATAnalysis](#) document from the samples directory.



1. Click the **Temporary External Storage** icon .

The Temporary External Storage dialog box appears.



2. If needed, click the **Modify** button.

The Selection dialog box appears.

3. Select the desired temporary external storage directory and then click **OK** in the

Selection dialog box.

The selected path name is visualized in the Temporary External Storage dialog box.

4. Click **OK** in the Temporary External Storage dialog box.

Both CATAnalysis stored data and computation results files can now be accessed from the directory you previously defined.



# Computing Objects Sets



This task will show you how to compute objects sets.

In this particular example, you will see how to compute a Mesh.

Computing a mesh will enable the analysis of any object of Restraints, Loads and Masses type, without requiring the computation of a Solution.



A finite element computation is a succession of data manipulation processes in which input data resulting from a previous process (or directly input by the user) is converted into output data ready to be used by a subsequent process. Such ready-to-use data is stored in program objects sets such as those appearing in the analysis features tree under Analysis Cases (Restraints, Loads, Masses, Solutions) objects sets.

When data contained in such an objects set is ready for use in the subsequent finite element computation process, the object has been computed and can be analyzed. Thus, computing an objects set consists in generating finite elements results for all objects and objects sets necessary to analyze the specified objects set.

The computation of an objects set requires two distinct actions:

- First, the user-defined specifications attached to each object belonging to the objects set in the specification tree must be translated by the pre-processor into solver-interpretable commands.

Since solvers can only interpret data applied on mesh entities (nodes and elements), this first translation step requires the existence of a mesh support for converting user input specifications on the geometry into explicit solver commands on nodes and elements.

- Next, the solver translates the solver commands into data ready for algorithmic treatment as required by the numeric procedure invoked.

Since algorithms deal only with operators dimensioned by the problem size (number of degrees of freedom (degree of freedom)), this second translation step requires the exact knowledge of the behavioral hypotheses of the finite elements (properties), which contain the required degree of freedom information.

As a result of such action, the program translates the user-defined specifications into solver-interpretable commands applied on mesh entities, and you can visualize on the mesh the result of this translation. This analysis capability, used especially for displaying program feedback on applied Restraints, Loads or Masses objects in the case of large size models (when you do not wish the entire computation to be performed), is available with a right (key 3) click on:

- Restraint, Load and Mass type objects, in the form of the object Visualization on Mesh action
- Restraints, Loads, Masses and Solutions objects sets, in the form of the following objects set actions:
  - objects set Image Generation
  - objects set Reporting

A prerequisite to these actions is the existence of a Mesh.



Avoid having CATAnalysis documents automatically saved. For this, go to **Tools->Options->General** (menu bar) and de-activate the **Automatic save every xx minutes** option. Otherwise, on some models, each computation will be followed by a Save, thus making temporary data become persistent data.



You can use the [sample00.CATAnalysis](#) document from the samples directory for this task: [Finite Element Model](#) containing a Static Analysis Case and computed corresponding [Static Solution](#).



1. Click the **Compute** icon .

The Compute dialog box appears.

- o The list allows you to choose between several options for the set of objects to update:

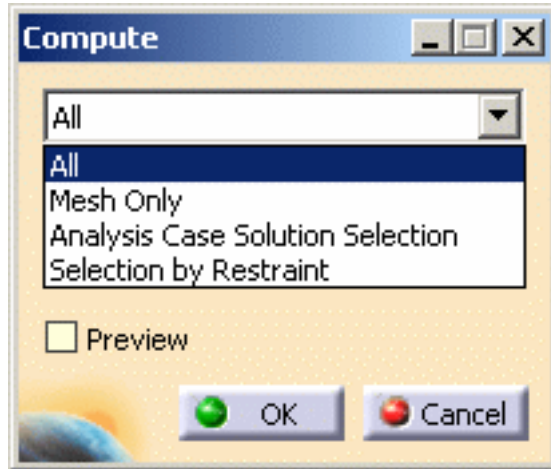

- **All**: all objects defined in the analysis features tree will be computed.
- **Mesh Only**: only the mesh will be computed.
- **Analysis Case Solution Selection**: only a selection of user-specified Analysis Case Solutions will be computed, with an optimal parallel computation strategy.
- **Selection by Restraint**: only the selected characteristics will be computed (Properties, Loads, Masses).



This option is only available with the **ELFINI Structural Analysis (EST)** product

- o The **Preview** option allows you to obtain an estimate of the time and memory required to perform the computation.

2. Select the **Mesh Only** option.



3. Click **OK** in the Compute dialog box.

The Mesh is computed and can be visualized.

The status of the Nodes and Elements objects set is changed to valid in the analysis features tree.

A valid **Mesh** object also appears under the **Nodes and Elements** objects set.

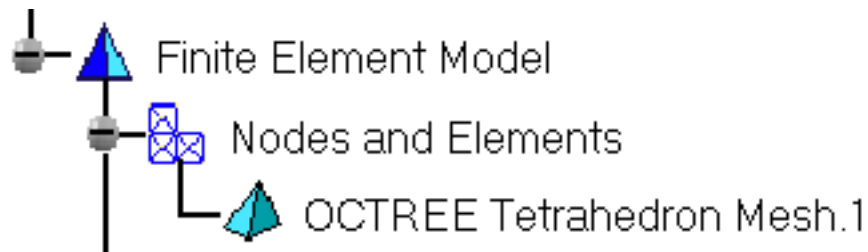

Any object in the Finite Element Model can now be analyzed (visualized on the Mesh).

By extension, all objects belonging to any objects set in the Finite Element Model can also be analyzed (visualized in various Generated Images or analyzed in a Report).

For more details on object **Visualization on Mesh** and on objects set **Report** and **Image Generation**, see the creation of objects of **Restraints**, **Loads** and **Masses** types.

You can change the definition parameters of an object either by replacing it by a new one (delete followed by create) or by modifying it (edit the definition parameters).

To edit the definition parameters of an object, activate it in the analysis features tree and double-click the object (or right-click, then click **.Object -> Definition**) to re-display the object definition dialog box.



# Computing Static Solutions



This task shows how to compute a Static Case Solution.



The Compute command is most often applied to Analysis Case Solutions (which are particular types of objects sets). In this case, it generates the analysis case solution, along with partial results for all objects involved in the definition of the Analysis Case.

The primary Static Solution Computation result consists of a displacement vector whose components represent the values of the system degree of freedom. This result can be further processed to produce other results such as stresses, reaction forces and so forth.

The program can compute simultaneously several Solution objects sets, with optimal parallel computation whenever applicable.



Avoid having CATAnalysis documents automatically saved. For this, go to **Tools->Options->General** (menu bar) and de-activate the **Automatic save every xx minutes** option. Otherwise, on some models, each computation will be followed by a Save, thus making temporary data become persistent data.



You can use the [Sample08.CATAnalysis](#) document from the samples directory for this task.





1. Click the **Compute** icon .

The Compute dialog box appears.

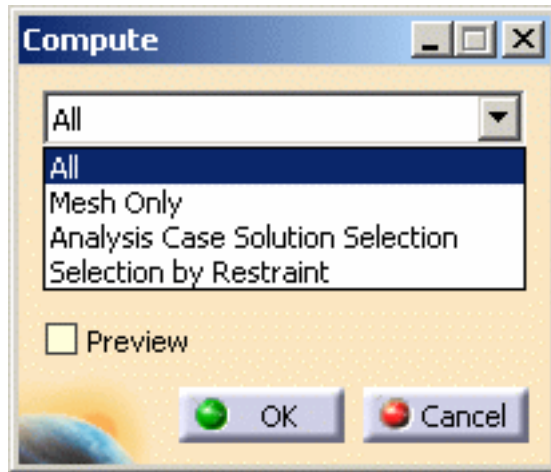
- o The list allows you to choose between several options for the set of objects to update:



- **All:** all the objects defined in the analysis features tree will be computed.
- **Mesh Only:** the preprocessing parts and connections will be meshed. The preprocessing data (loads, restraints and so forth) will be applied onto the mesh.  
Capability is only available with the **ELFINI Structural Analysis** product: for your information, in case the Mesh only option was previously activated, you will then be able to visualize the applied data on the mesh by using the **Visualization on Mesh** option (contextual menu) 
- **Analysis Case Solution Selection:** only a selection of user-specified Analysis Case Solutions will be computed, with an optimal parallel computation strategy. This capability is only available with the **ELFINI Structural Analysis** product .
- **Selection by Restraint:** only the selected characteristics will be computed (Properties, Restraints, Loads, Masses).
- The **Preview** option allows you to obtain an estimate of the Time and Memory required to perform the computation, prior to triggering the actual computation.

**2.** Select the **All** (or **Analysis Case Solution Selection**) option.



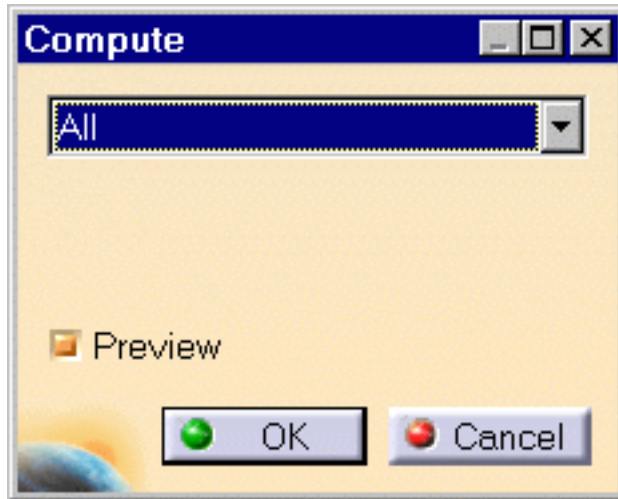

In this case, the program will compute by default all objects up to (and including) the Static Case Solution in the analysis features tree.

3. Select the **Preview** option and click **OK** in the Compute dialog box.

The estimates are displayed in the Preview dialog box. You can proceed with the computation or choose to postpone it.

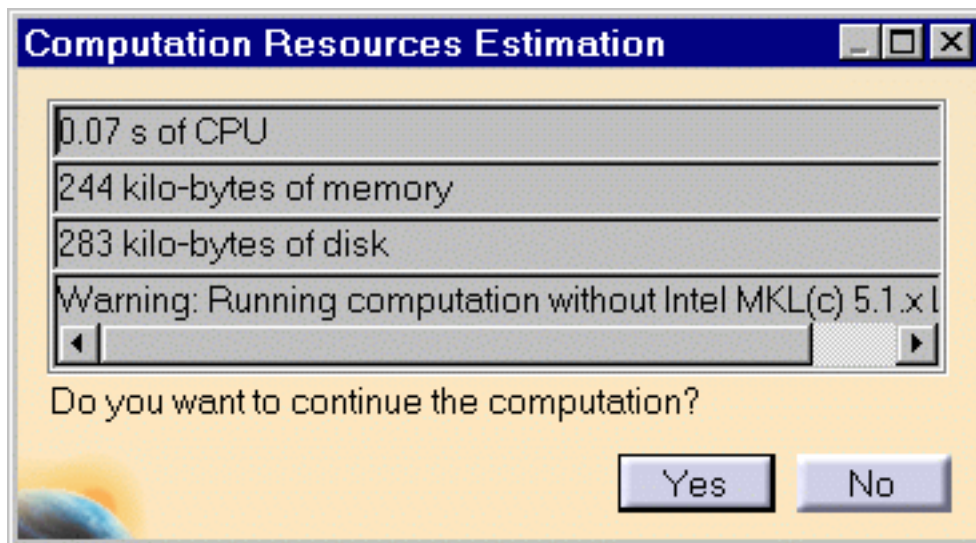

4. Click **Yes** to launch the computation.

The Progress Bar dialog box provides a series of status messages (**Meshing**, **Factorization**, **Solution**) that inform you of the degree of advancement of the computation process.

The Static Analysis Solution is computed and can be visualized.

Upon successful completion of the computation, the FEM mesh is visualized on your part, and the status of all objects in the analysis specification tree up to the Static Case Solution objects set is changed to valid. You can now:

- analyze the report of the computation
- visualize images for various results

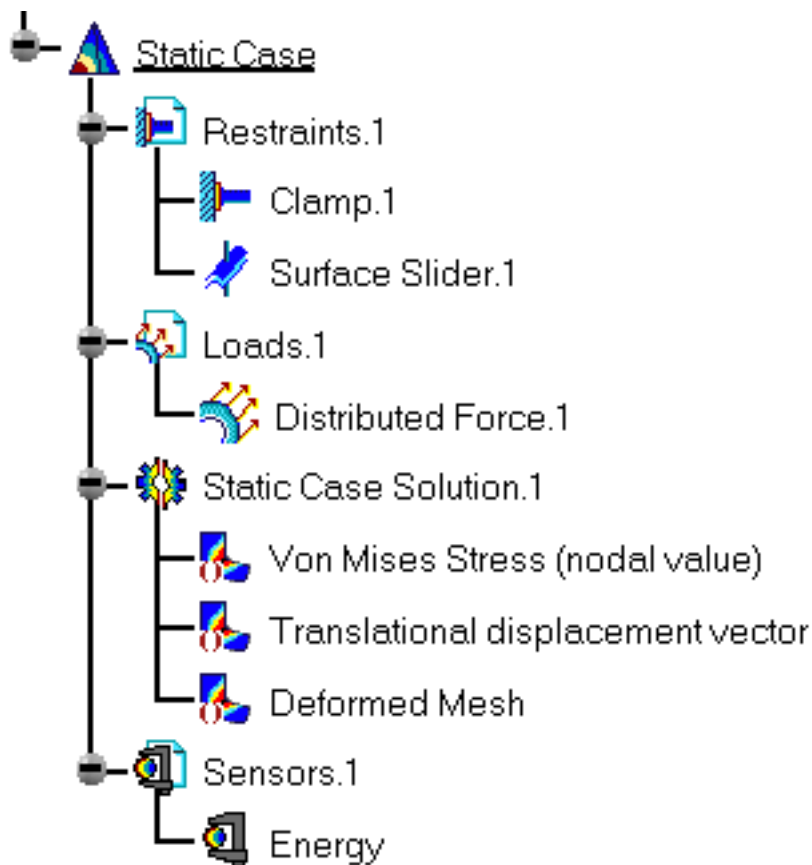

- The status and results of all intermediate computations necessary to compute the solution are reported in HTML format. For more detail see the basic global Report capability .
- To display CPU time and memory requirement estimates prior to launching any computations, activate the Estimates switch in the Update dialog box.



## Products in Analysis Workbench

- The **ELFINI Structural Analysis** product offers the following additional feature:

If several Static Analysis Cases have been defined, you can compute them simultaneously by following the same procedure. You can also compute only a selection of cases by selecting Analysis Cases Solution Selection. You can then specify the cases in the Compute dialog box.

The Definition parameters of an Analysis Case, (available, in the **ELFINI Structural Analysis** product, in the New Case dialog box at the time of a Case Insertion) cannot be modified once the Case has been created. These must not be confused with the Computation parameters of a Case Solution, which are proposed by default at creation, and are editable afterwards.

To edit the default values of the Computation parameters of a Case Solution, double-click the Solution objects set in the analysis features tree (or right-click, then click **.Object -> Definition** ) to display the Definition Parameters dialog box.

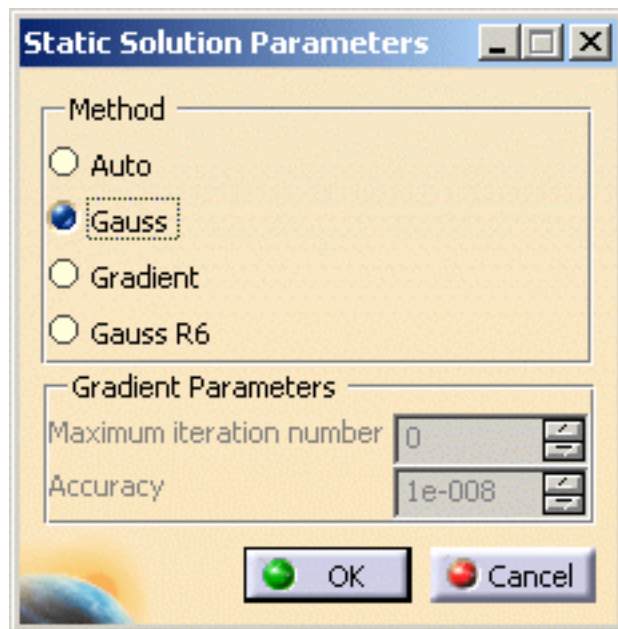

The Static Solution Parameters dialog box contains the following parameters which can all be modified in the dialog box:

- **Auto**
- **Gauss**
- **Gradient Parameters**
  - **Maximum iterations number**

- **Accuracy**
  - **Gauss R6**
- The **ELFINI Structural Analysis** product offers the following additional features with a right-click (key 3) on a **Static Case Solution objects** set:
  - **Generate Image**: proposes to generate the various images available along with the Static Solution objects set. The image can be edited to include part or all of the options available.

Right-click the **Load** object in the specification tree and click the **Generate Image** contextual menu (on the condition you previously computed a solution using the **Compute** icon ).



The Image Generation dialog box appears. You can select images by clicking them in the list.

The resulting images sequence is obtained by superposition.

- **Report**: the global status and results of all computations are reported in HTML format.

Click the **Basic Analysis Report** icon  (on the condition you previously computed a solution using the **Compute** icon ).

The .html partial report file is displayed. It contains a summary of the modal computation results, including the values of the rigid body modal participation factors for the computed modes.



# Computing Static Constrained Solutions



This task shows how to compute a Static Case Constrained Solution.



The Compute command is most often applied to Analysis Case Solutions (which are particular types of objects sets). In this case, it generates the analysis case solution, along with partial results for all objects involved in the definition of the Analysis Case.



Avoid having CATAnalysis documents automatically saved. For this, go to **Tools->Options->General** (menu bar) and de-activate the **Automatic save every xx minutes** option. Otherwise, on some models, each computation will be followed by a Save, thus making temporary data become persistent data.



Open the [Sample05.CATAnalysis](#) document from the samples directory for this task.



1. Select the **Static Constrained Modes.1** in the specification tree.

2. Click the **Compute** icon .

The Compute dialog box appears.

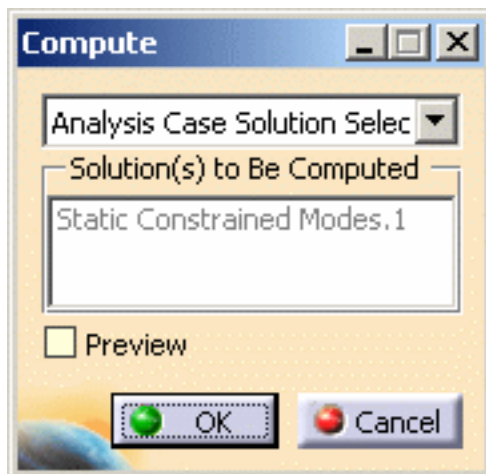

3. Click **OK** in the Compute dialog box.

The Static Constrained Mode is computed and can be visualized.

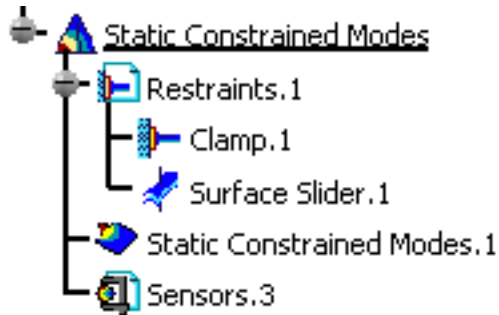

You can now:

- Visualize images for various results. For this, you can use the **Generate Image** contextual menu.  
For more details, please refer to [Generating Images](#).
- Analyze the report of the computation. For this, select the **Report** contextual menu.  
For more details, please refer to [Reporting](#).



# Computing Frequency Solutions



This task shows how to compute a Frequency Case Solution.



The Compute command is most often applied to Analysis Case Solutions (which are particular types of objects sets). In this case, it generates the analysis case solution, along with partial results for all objects involved in the definition of the Analysis Case.

The primary Frequency Solution Computation result consists of a set of frequencies and associated modal vibration shape vectors whose components represent the values of the system dof for various vibration modes.

The program can compute simultaneously several Solution objects sets, with optimal parallel computation whenever applicable.



Avoid having CATAnalysis documents automatically saved. For this, go to **Tools->Options->General** (menu bar) and de-activate the **Automatic save every xx minutes** option. Otherwise, on some models, each computation will be followed by a Save, thus making temporary data become persistent data.



You can use the [sample16.CATAnalysis](#) document from the samples directory for this task.





1. Click the **Compute** icon .

The Compute dialog box appears.

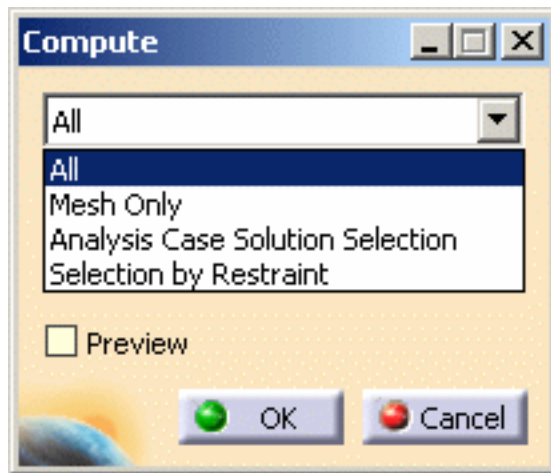
- o The list allows you to choose between several options for the set of objects to be updated:



- **All**: all objects defined in the analysis features tree will be computed.
- **Mesh Only**: the preprocessing parts and connections will be meshed. The preprocessing data (loads, restraints and so forth) will be applied onto the mesh.  
Capability is only available with the **ELFINI Structural Analysis** product: for your information, in case the Mesh only option was previously activated, you will then be able to visualize the applied data on the mesh by using the **Visualization on Mesh** option (contextual menu) .
- **Analysis Case Solution Selection**: only a selection of user-specified Analysis Case Solutions will be computed, with an optimal parallel computation strategy. This capability is only available with the **ELFINI Structural Analysis** product .
- **Selection by Restraint**: only the selected characteristics will be computed (Properties, restraints, Loads, Masses).
- The **Preview** option allows you to obtain an estimate of the Time and Memory required to perform the computation, prior to triggering the actual computation.

**2.** Select the **All** (or **Analysis Case Solution Selection**) option.



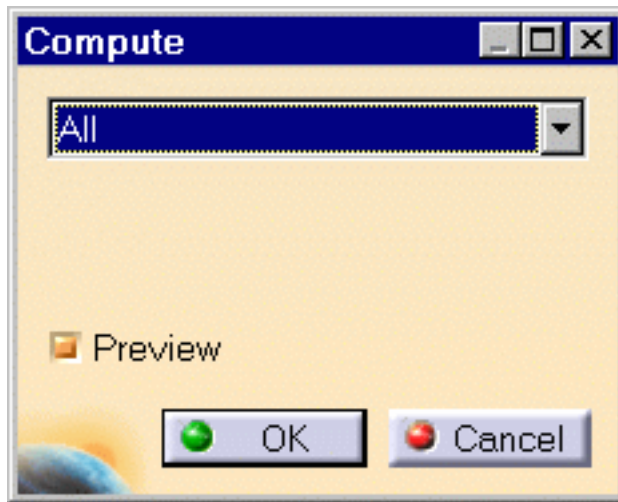

In this case, the program will compute by default all objects up to (and including) the Frequency Case Solution in the analysis features tree.

3. Activate the **Preview** option from the Compute dialog box.
4. Click **OK** in the Compute dialog box.

The estimations are displayed in the Computation Resources Estimation dialog box. You can proceed with the computation or choose to postpone it.

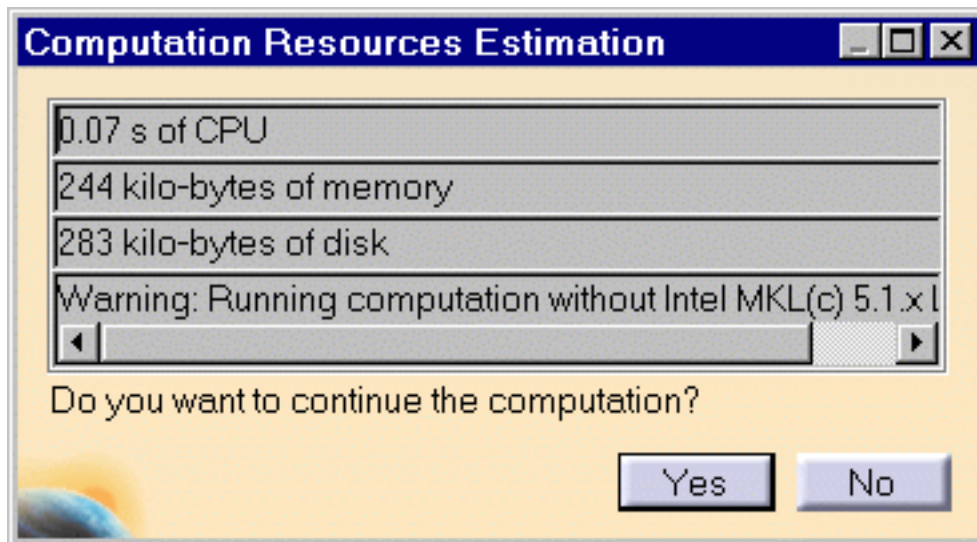

5. Click **Yes** to launch the computation.

The Computation Status dialog box provides a series of status messages (**Meshing, Factorization, Solution**) that inform you of the degree of advancement of the computation process.

The Frequency Analysis Solution is computed and can be visualized.

Upon successful completion of the computation, the FE mesh is visualized on your part, and the status of all objects in the analysis features tree up to the Frequency Case Solution objects set is changed to valid. You can now:

- analyze the report of the computation
- visualize images for various results

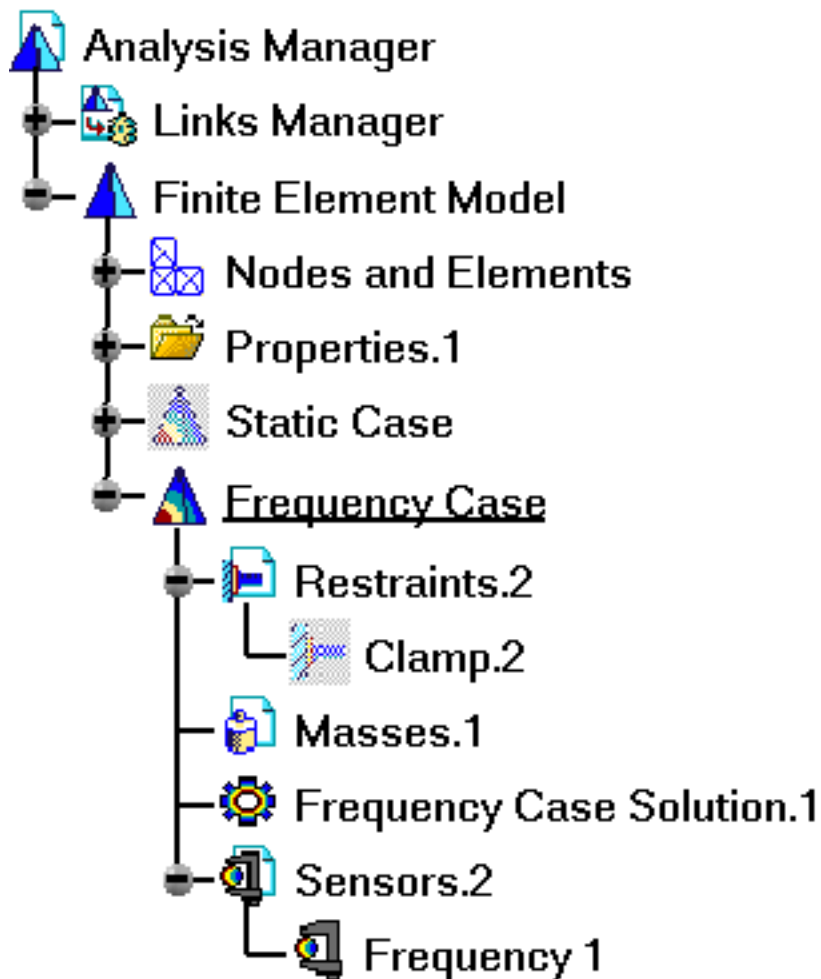



## Products Available in Analysis Workbench



The **ELFINI Structural Analysis** product offers the following additional feature:

- If several Frequency Analysis Cases have been defined, you can compute them simultaneously by following the same procedure. You can also compute only a selection of cases by selecting Analysis Cases Solution Selection. You can then specify the cases in the Compute dialog box.
- You can compute vibration modes either for the free system or for the system subjected to supports. In the first case there are no restraints so your Analysis Case must contain no Restraints objects set.
- To display CPU time and memory requirement estimates prior to launching any computations, activate the Estimates switch in the Update dialog box.
- The status and results of intermediate pre-processor computations necessary to perform this translation are reported in HTML format. For more detail see the basic global Report capability .
- The Definition parameters of an Analysis Case, (available, in the ELFINI Structural Analysis product, in the New Case dialog box at the time of a Case Insertion) cannot be modified once the Case has been created. These must not be confused with the Computation parameters of a Case Solution, which are proposed by default at creation, and are editable afterwards.
- To edit the default values of the Computation parameters of a Case Solution, double-click the Solution objects set in the analysis specification tree (or right-click, then click **.Object -> Definition** ) to display the Frequency Solution Parameters dialog box.

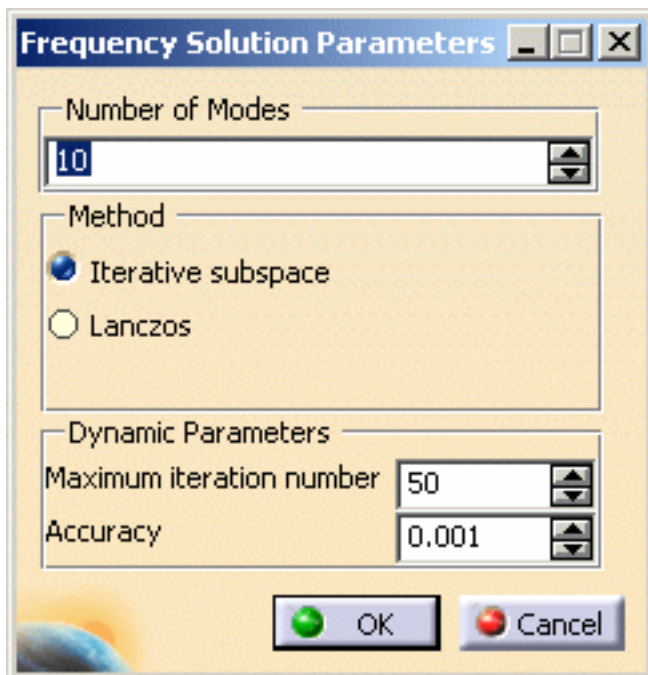

The Frequency Solution Parameters dialog box contains the following parameters which can all be modified in the dialog box:

- **Number of Modes**

- **Method**
  - **Iterative subspace**
  - **Lanczos**
- **Dynamic parameters**
  - **Maximum iteration number**
  - **Accuracy**



The **ELFINI** product offers the following additional features on a **Frequency Case Solution objects** set:



- **Generate Image:** proposes to generate the various images available along with the Static Solution objects set. The image can be edited to include part or all of the options available.

Right-click the Mass object and then click the **Generate Image** contextual menu (on the condition you previously computed a solution using the **Compute** icon ).



The Image Generation dialog box appears. You can select images by clicking them in the list.

- **Report:** the global status and results of all computations are reported in HTML format.

Click the **Basic Analysis Report** icon  on the bottom toolbar (on the condition you previously computed a solution using the **Compute** icon ).

The .html partial report file is displayed. It contains a summary of the modal computation results, including the values of the rigid body modal participation factors for the computed modes.



# Computing Buckling Solutions



This task shows how to compute a Buckling Case Solution.



Only available with the **ELFINI Structural Analysis (EST)** product.



The Compute command is most often applied to Analysis Case Solutions (which are particular types of objects sets). In this case, it generates the analysis case solution, along with partial results for all objects involved in the definition of the Analysis Case.

The primary Buckling Solution Computation result consists of a set of critical load factors and associated buckling shape vectors, whose components represent the values of the system degree of freedom for various buckling modes associated with a given Static Case.

The program can compute simultaneously several Solution objects sets, with optimal parallel computation whenever applicable.



Avoid having CATAnalysis documents automatically saved. For this, go to **Tools->Options->General** (menu bar) and de-activate the **Automatic save every xx minutes** option. Otherwise, on some models, each computation will be followed by a Save, thus making temporary data become persistent data.



You can use the [sample29.CATAnalysis](#) document from the samples directory: you created a **Finite Element Model** containing a Buckling Analysis Case.



1. Select the **Buckling Case Solution** feature from the specification tree.

2. Click the **Compute** icon .

The Compute dialog box appears.

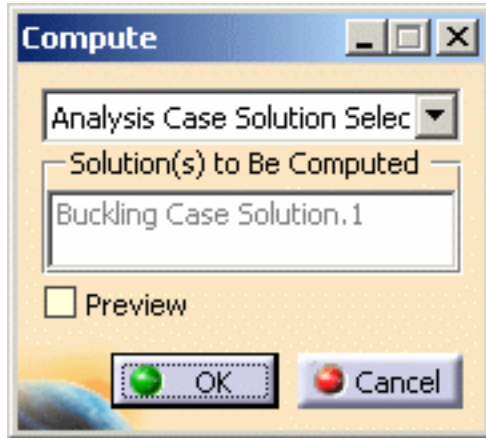

In this case, the program will compute the Buckling Case Solution in the analysis specification tree.

3. Click **OK** in the Compute dialog box.

The Buckling Analysis Solution is computed and can be visualized.

Upon successful completion of the computation, the FE mesh is visualized on your part, and the status of all objects in the analysis features tree up to the Buckling Case Solution objects set is changed to valid. You can now:

- analyze the report of the computation
- visualize images for various results

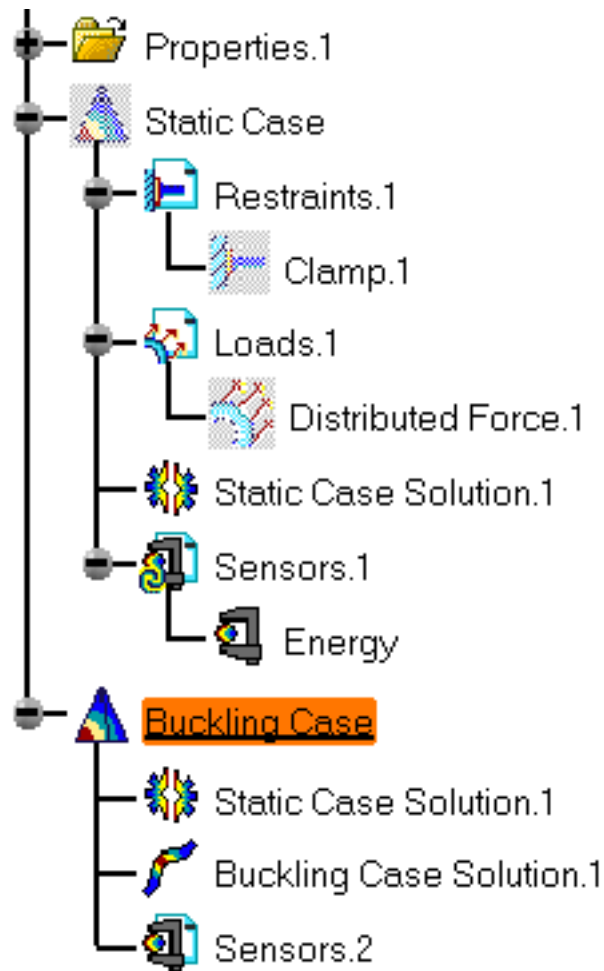

### Products Available in Analysis Workbench



The **ELFINI Structural Analysis** product offers the following additional feature:

- If several Buckling Analysis Cases have been defined, you can compute them simultaneously by following the same procedure.
- To display CPU time and memory requirement estimates prior to launching any computations, activate the Estimates switch in the Update dialog box.
- The status and results of intermediate pre-processor computations necessary to perform this translation are reported in HTML format. For more detail see the basic global Report capability.
- The Definition parameters of an Analysis Case, (available, in the **ELFINI Structural Analysis** product, in the New Case dialog box at the time of a Case Insertion) cannot be modified once the Case has been created. These parameters must not be confused with the Computation parameters of a Case Solution, which are proposed by default at creation, and are editable afterwards.

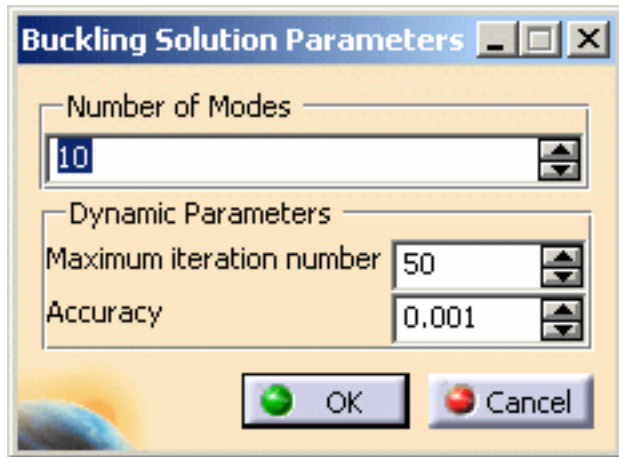

To edit the default values of the Computation parameters of a Case Solution, double-click the Solution objects set in the analysis features tree (or right-click, then click **.Object -> Definition** ) to display the Definition par... dialog box.

The Buckling Solution Parameters dialog box contains the following parameters which can all be modified in the dialog box:

1. **Number of modes**
2. **Method (Iterative subspace or lanczos)**
3. **Dynamic parameters (Maximum iteration number and Accuracy)**



The **ELFINI Structural Analysis (EST)** product offers the following additional features on a Buckling Case Solution:

- **Generate Image:** allows to generate the various images available along with the Static Solution objects set. The image can be edited to include part or all of the options available.

Right-click the Buckling Case object and then click the **Generate Image** contextual menu (on the condition you previously computed a solution using the **Compute** icon



The Image Generation dialog box appears. You can select images by clicking them in the list.



Since a Buckling solution is a multi-occurrence solution, you can select the buckling mode that will be displayed by clicking the **Select** button in the Image Generation dialog box.



Number of modes	Buckling factor
1	53676.3
2	-55425.9
3	58049.5
4	-59005.5
5	62405.1
6	-65392.1
7	69104
8	-72963.8
9	75854.5
10	-77762.9

The resulting images sequence is obtained by superposition.

- **Report:** the global status and results of all computations are reported in HTML format.

Click the **Basic Analysis Report**  icon (on the condition you previously computed a solution using the **Compute** icon ).

The .html partial report file is displayed. It contains a summary of the buckling computation results.



# Computing Harmonic Dynamic Response Solutions



This task shows how to compute a Harmonic Dynamic Response Case Solution.



Only available with the **Generative Dynamic Analysis (GDY)** product.



The Compute command is most often applied to Analysis Case Solutions (which are particular types of objects sets). In this case, it generates the analysis case solution, along with partial results for all objects involved in the definition of the Analysis Case.

The primary Dynamic Solution Computation result consists of a set of critical load excitation set factors and associated damping.

The program can compute simultaneously several Solution objects sets, with optimal parallel computation whenever applicable.



Avoid having CATAnalysis documents automatically saved.

For this, go to **Tools->Options->General** (menu bar) and de-activate the **Automatic save every xx minutes** option. Otherwise, on some models, each computation will be followed by a Save, thus making temporary data become persistent data.



You can use the [sample58.CATAnalysis](#) document from the samples directory: you created a **Finite Element Model** containing a Dynamic Response Case.

In this example, the Load Excitation set and the Damping set have been previously defined.



1. Double-click on the **Harmonic Dynamic Response Case Solution.1** in the specification tree to edit it.

The Harmonic Dynamic Response Set dialog box appears to let you define the computation parameters.

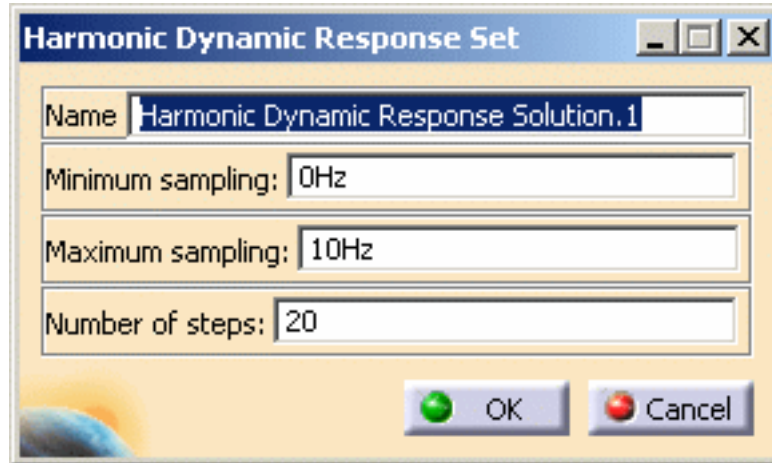

- o **Name:** allows you to modify the name of the set.
  - o **Minimum sampling:** allows you to define the minimum sampling parameters (in Hz).
  - o **Maximum sampling:** allows you to define the maximum sampling parameters (in Hz).
  - o **Number of steps:** allows you to define the number of steps between the minimum and maximum sampling.
2. Modify the desired parameters.  
In this particular example, enter:
    - o **0Hz** as **Minimum sampling** value
    - o **100Hz** as **Maximum sampling** value
    - o **2000** as **Number of steps** value
  3. Click **OK** in the Harmonic Dynamic Response Set dialog box.
  4. Select the **Harmonic Dynamic Response Solution** object in the specification tree.
  5. Click the **Compute** icon .

The Compute dialog box appears as shown here:

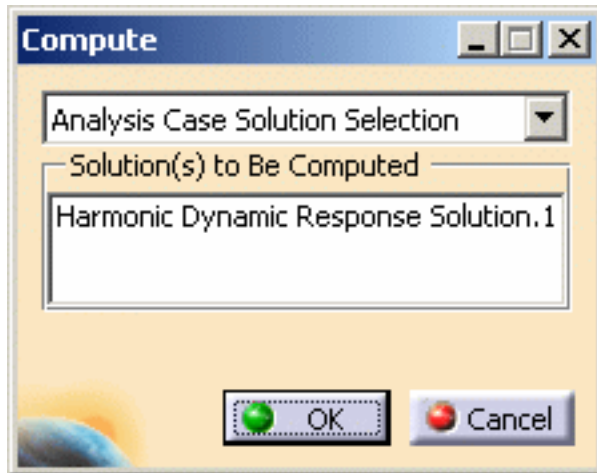

6. Click **OK** in the Compute dialog box.

The Dynamic Response Solution is computed.

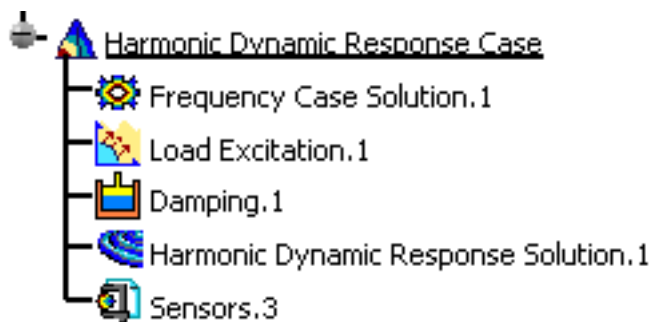

Upon successful completion of the computation, the FE mesh is visualized on your part, and the status of all objects in the analysis features tree up to the Dynamic Response Solution objects set is changed to valid. You can now:

- analyze the report of the computation
- visualize images for various results
- visualize the 2D Display result



## Products Available in Analysis Workbench



The **ELFINI Structural Analysis** product offers the following additional feature:

- If several Harmonic Dynamic Response Cases have been defined, you can compute them simultaneously by following the same procedure.
- To display CPU time and memory requirement estimates prior to launching any computations, activate the Estimates switch in the Update dialog box.
- The status and results of intermediate pre-processor computations necessary to perform this translation are reported in HTML format. For more detail see the basic global Report capability.
- The Definition parameters of an Analysis Case (available, in the **ELFINI Structural Analysis** product, in the New Case dialog box at the time of a Case Insertion) cannot be modified once the Case has been created. These parameters must not be confused with the Computation parameters of a Case Solution, which are proposed by default at creation, and are editable afterwards.
- To edit the default values of the Computation parameters of a Case Solution, double-click the Solution objects set in the analysis features tree (or right-click, then click **.Object -> Definition...** ) to display the Dynamic Response Set dialog box.



The **ELFINI Structural Analysis** product offers the following additional features on a **Dynamic Response Solution objects** set:

- **Generate Image:** allows to generate the various images available along with the Dynamic Response Solution objects set. The image can be edited to include part or all of the options available.

Right-click the **Dynamic Response Case** object and then click the **Generate Image** contextual menu (on the condition you previously computed a solution using the

**Compute** icon ).



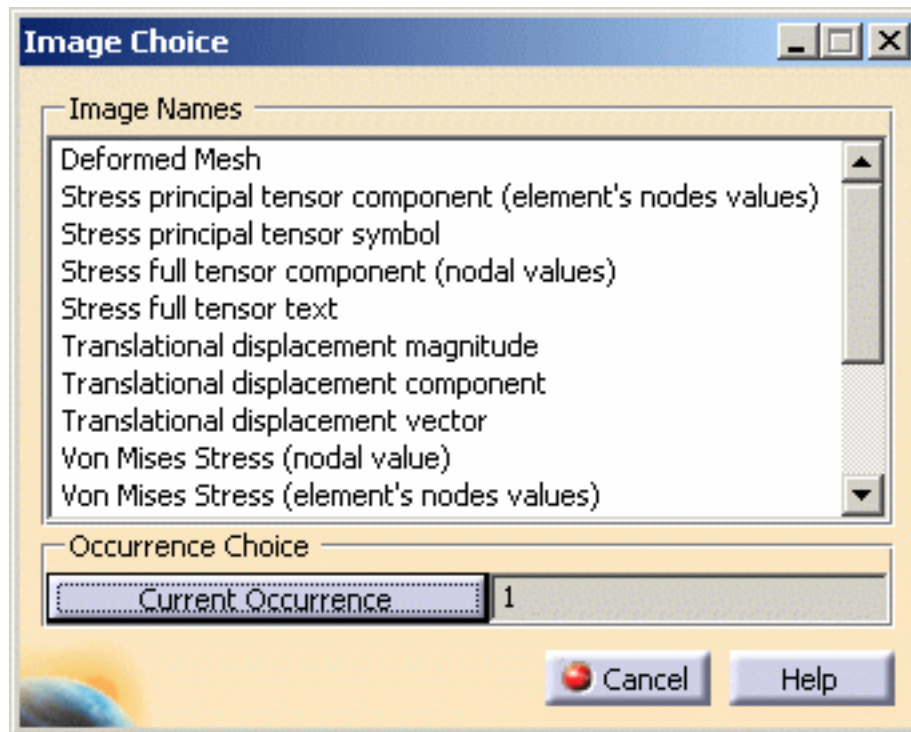

The Image Choice dialog box is displayed. You can select images by clicking them in the list.

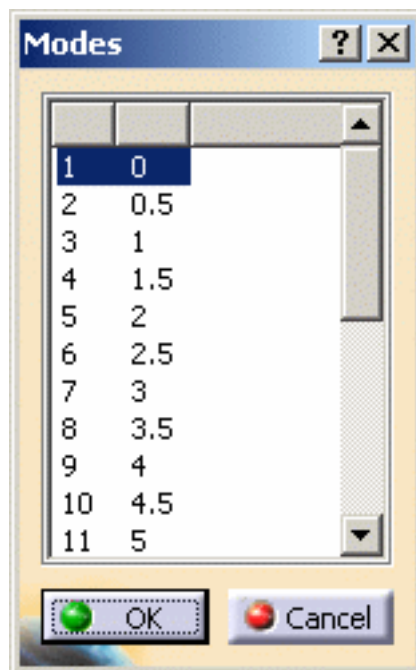

If you select the **Current Occurrence** button, the table below lets you choose the desired **Mode**.



- **Report:** the global status and results of all computations are reported in HTML format.

Click the **Basic Analysis Report**  icon (on the condition you previously computed a solution using the **Compute** icon  ).

The .html partial report file is displayed. It contains a summary of the harmonic dynamic response computation results.

# Dynamic Response Case

## Boundary Conditions



# Computing Transient Dynamic Response Solutions



This task shows how to compute a Transient Dynamic Response Case Solution.



The Compute command is most often applied to Analysis Case Solutions (which are particular types of objects sets). In this case, it generates the analysis case solution, along with partial results for all objects involved in the definition of the Analysis Case.

The primary Dynamic Solution Computation result consists of a set of critical load excitation set factors and associated damping.

The program can compute simultaneously several Solution objects sets, with optimal parallel computation whenever applicable.

This capability is only available with the ELFINI Structural Analysis product .



Avoid having CATAnalysis documents automatically saved.

For this, go to **Tools->Options->General** (menu bar) and de-activate the **Automatic save every xx minutes** option. Otherwise, on some models, each computation will be followed by a Save, thus making temporary data become persistent data.



You can use the [sample58\\_1.CATAnalysis](#) document from the samples directory: you created a **Finite Element Model** containing a Dynamic Response Case.

In this example, the Load Excitation set and the Damping set have been previously defined.





1. Double-click on the **Transient Dynamic Response Case Solution.1** in the specification tree to edit it.

The Transient Dynamic Response Set dialog box appears to let you define the computation parameters.

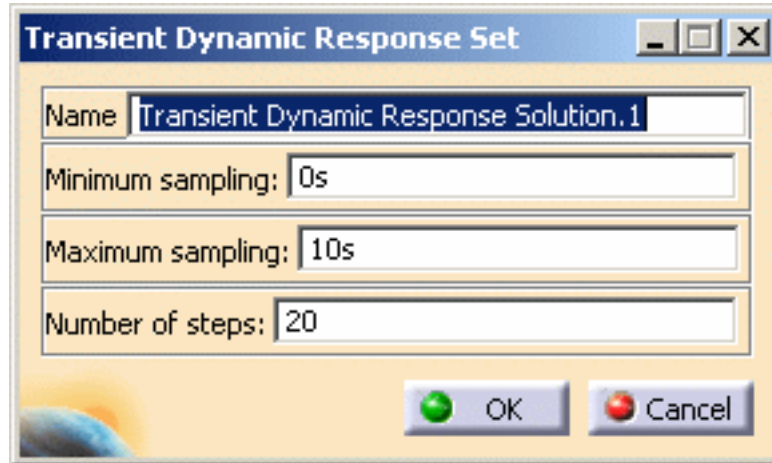

- o **Name:** allows you to modify the name of the set.
  - o **Minimum sampling:** allows you to define the minimum sampling parameters (in s).
  - o **Maximum sampling:** allows you to define the maximum sampling parameters (in s).
  - o **Number of steps:** allows you to define the number of steps between the minimum and maximum sampling.
2. Modify the desired parameters.  
In this particular example, enter:
    - o **0s** as **Minimum sampling** value
    - o **20s** as **Maximum sampling** value
    - o **2000** as **Number of steps** value
  3. Click **OK** in the Transient Dynamic Response Set dialog box.
  4. Select the **Transient Dynamic Response Solution** object in the specification tree.
  5. Click the **Compute** icon .

The Compute dialog box appears as shown here:

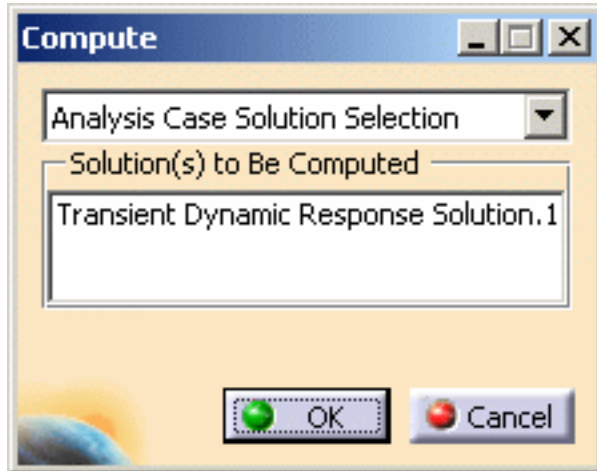

6. Click **OK** in the Compute dialog box.

The Transient Dynamic Response Solution is computed.

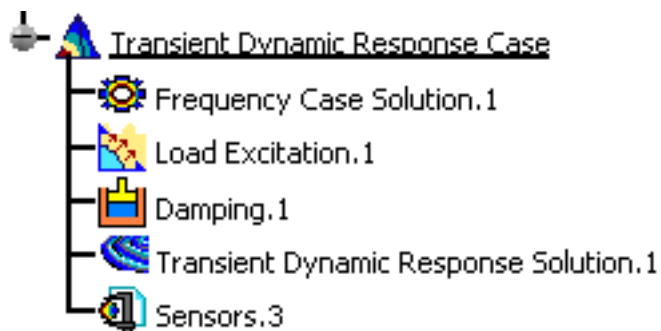

Upon successful completion of the computation, the FE mesh is visualized on your part, and the status of all objects in the analysis features tree up to the Dynamic Response Solution objects set is changed to valid. You can now:

- analyze the report of the computation
- visualize images for various results
- visualize the 2D Display result



## Products Available in Analysis Workbench



The **ELFINI Structural Analysis** product offers the following additional feature:

- If several Transient Dynamic Response Cases have been defined, you can compute them simultaneously by following the same procedure.
- To display CPU time and memory requirement estimates prior to launching any computations, activate the Estimates switch in the Update dialog box.
- The status and results of intermediate pre-processor computations necessary to perform this translation are reported in HTML format. For more detail see the basic global Report capability.
- The Definition parameters of an Analysis Case (available, in the **ELFINI Structural Analysis** product, in the New Case dialog box at the time of a Case Insertion) cannot be modified once the Case has been created. These parameters must not be confused with the Computation parameters of a Case Solution, which are proposed by default at creation, and are editable afterwards.
- To edit the default values of the Computation parameters of a Case Solution, double-click the Solution objects set in the analysis features tree (or right-click, then click **.Object -> Definition...** ) to display the Dynamic Response Set dialog box.



The **ELFINI Structural Analysis** product offers the following additional features on a **Dynamic Response Solution objects** set:

- **Generate Image:** allows to generate the various images available along with the Dynamic Response Solution objects set. The image can be edited to include part or all of the options available.

Right-click the **Dynamic Response Case** object and then click the **Generate Image** contextual menu (on the condition you previously computed a solution using the

**Compute** icon ).



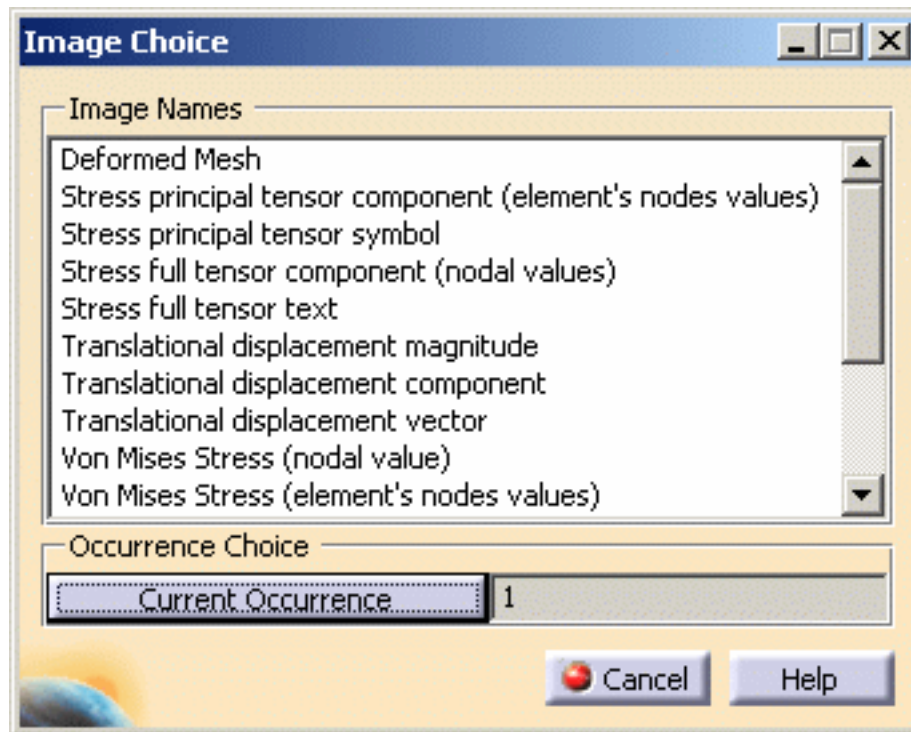

The Image Choice dialog box is displayed. You can select images by clicking them in the list.

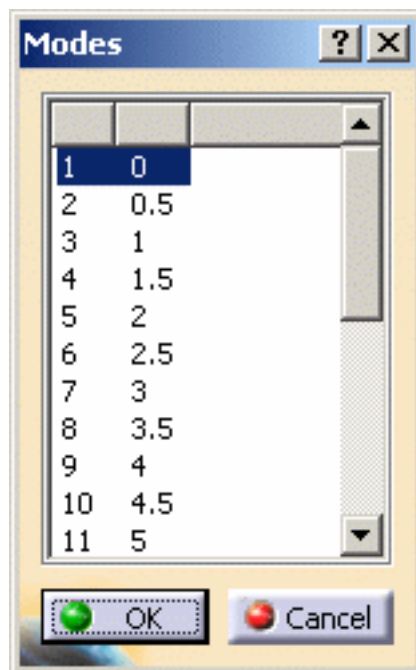

If you select the **Current Occurrence** button, the table below lets you choose the desired **Mode**.



- **Report:** the global status and results of all computations are reported in HTML format.

Click the **Basic Analysis Report**  icon (on the condition you previously computed a solution using the **Compute** icon  ).

The .html partial report file is displayed. It contains a summary of the dynamic response computation results.

# Dynamic Response Case

## Boundary Conditions



# Computing Using a Batch



This task shows how to update and compute a .CATAnalysis document using a batch:

- [in local mode](#)
- [in remote mode](#)

Computing a document will enable the analysis of any object of Restraints, Loads and Masses type, without requiring the computation of a Solution.

For more details about computation, please refer to [Computing Object Sets](#).



To know how to use the batch monitor, please refer to [Running Batches using the Batch Monitor](#) in the *Infrastructure User's Guide*.

## Local Mode



1. Open the Batch Monitor.

For more details about the use of the Batch Monitor, please refer to [Running Batches using the Batch Monitor](#) in the *Infrastructure User's Guide*.

2. Double-click **AnalysisUpdateBatch** in the Batch Monitor.

The AnalysisUpdateBatch dialog box appears.

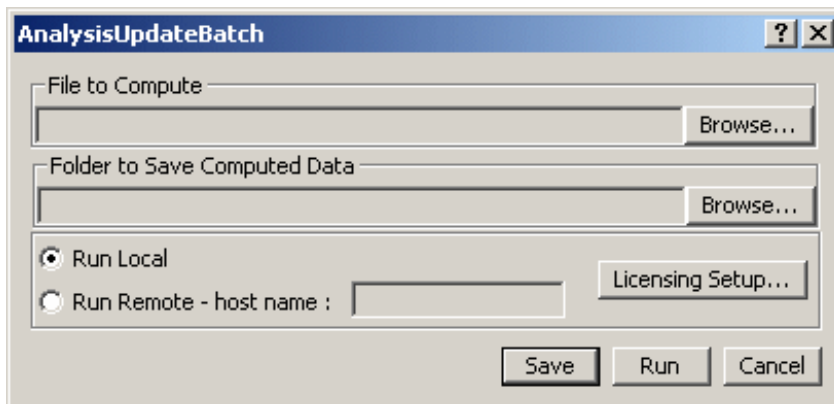

- **File to Compute:** lets you select the .CATAnalysis file you want to update and compute (using the **Browse...** button).
- **Folder to Save Computed Data:** lets you select the folder in which you will save the .CATAnalysis document and the associated .CATAnalysisResults and .CATAnalysisComputations files (using the **Browse...** button).
- **Run Local:** lets you run the batch on your local machine.
- **Run Remote - host name:** lets you indicate the name of the remote machine on which the batch will be run.
- **Licensing Setup...:** lets you select a license authorizing the use of the batch you want to run.
- **Save:** lets you save the xml file in the desired location.
- **Run:** lets you run the batch.
- **Cancel:** lets you return to the batch monitor without launching the analysis batch.

3. Click the **Browse...** button to choose the file to compute.

The File Selection dialog box appears to let you select the .CATAnalysis document you want to compute.

In this particular example, you can select the **sample00.CATAnalysis** from the samples directory and click **OK** in the File Selection dialog box.

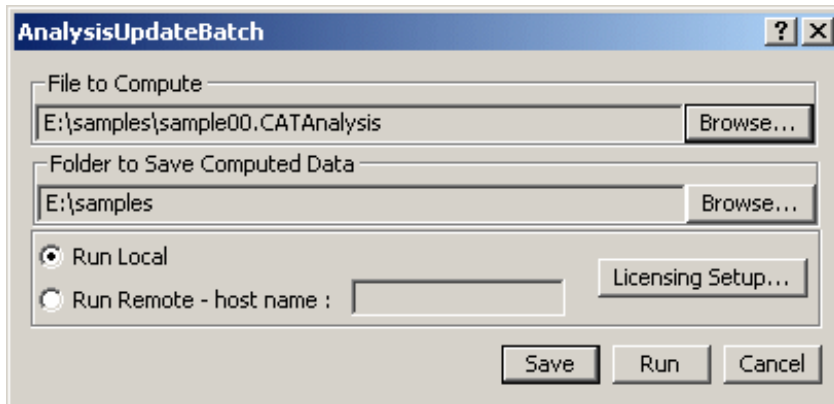

Note that the **Folder to Save Computed Data** field is automatically updated.

By default, this folder is the same as the .CATAnalysis document.

You can change the default folder.

4. Click the **Browse...** button if you want to change the folder in which the computed .CATAnalysis document (and the associated .CATAnalysisResults and .CATAnalysisComputations files) will be saved.

The Folder Selection dialog box appears.

You can change the folder or create a new one.

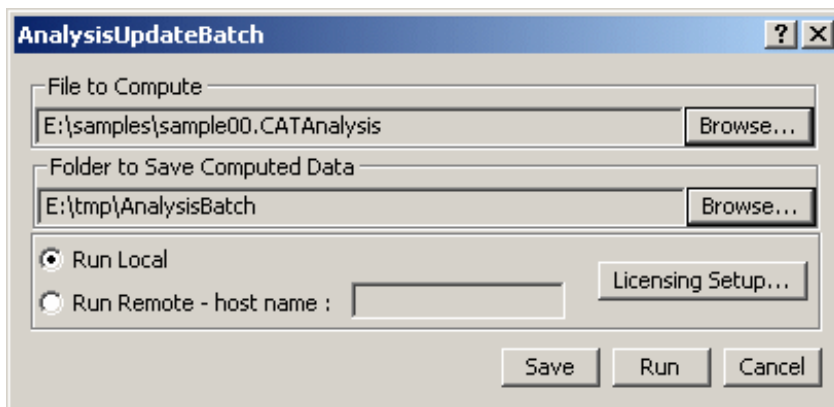

5. Click **Run** in the AnalysisUpdateBatch dialog box.
6. Select the **Processes** tab of the Batch Monitor.

The batch computation has been successfully done if you get **0** as **Return Code**.

7. Right-click the **AnalysisUpdateBatch** line and select the **Results** contextual menu.

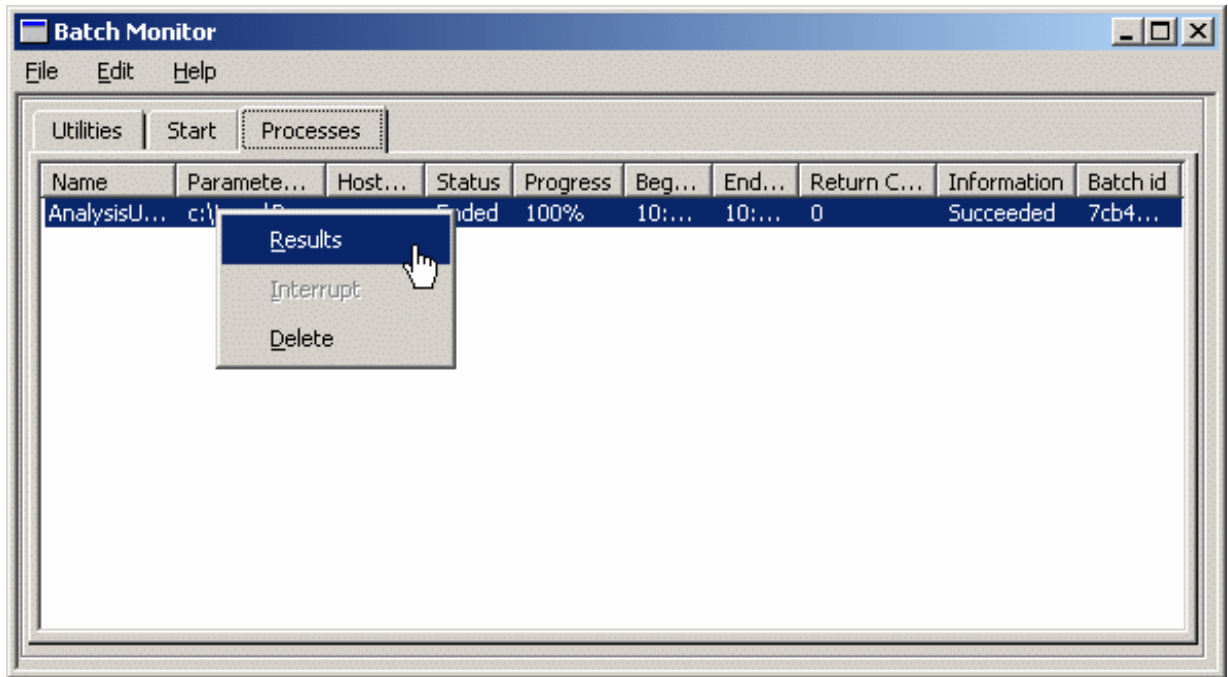

The Results dialog box appears.

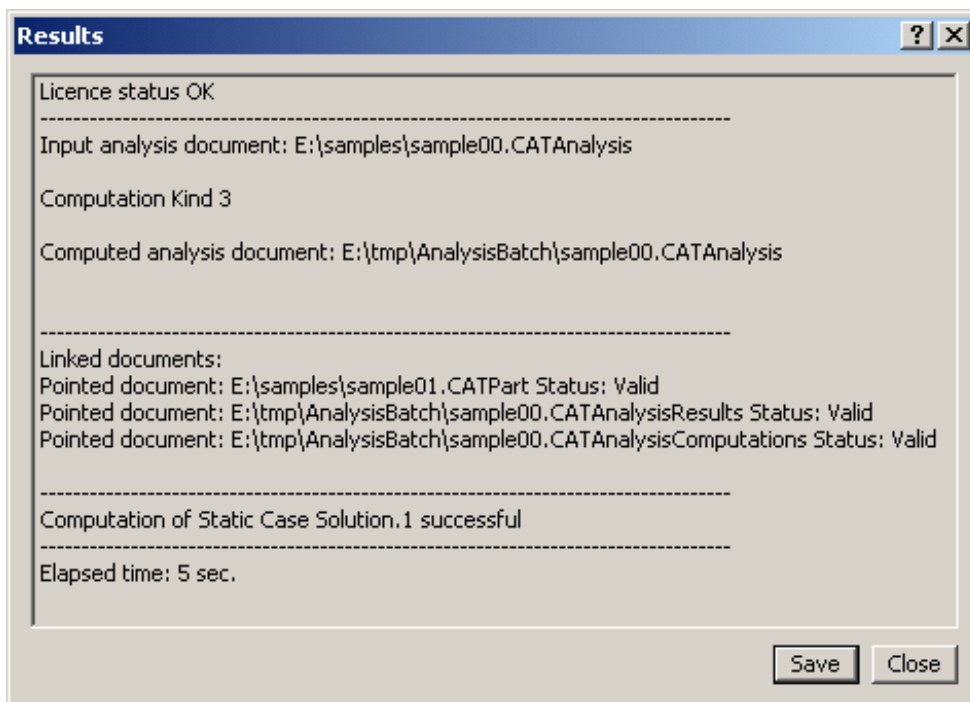

You can retrieve the computed **.CATAnalysis** file and also the associated **.CATAnalysisResults** and **CATAnalysisComputations** files in the same folder.

## Remote Mode







The recommended methodology to work in remote mode with the **AnalysisUpdateBatch** batch is:

- a. Send the **.CATAnalysis** file and the pointed documents from the client to the server using the **Send To** menu.
- b. Run the **AnalysisUpdateBatch** batch on the server.
- c. Send the **.CATAnalysis** file and the pointed documents (including the computed documents) from the server to the client using the **Send To** menu.

You can find here the supported configurations (client and server machines must be in Network File System visible):

Supported configurations		Server	
		Windows	Unix
Client	Windows	▲	▲ *
	Unix		▲

\* : for this configuration, a manual edition of the **.xml** batch parameter file is required:

- a. Save the **.xml** parameter file as **MyBatch.xml**.
- b. Edit the file and enter the path for the input **.CATAnalysis** file:  
u/samples/MyAnalysis.CATAnalysis
- c. Associate the modified **.xml** parameter file to the **AnalysisUpdateBatch** batch using the **Associate a parameters file** contextual menu.
- d. Edit the properties to specify the remote machine using the **Properties** contextual menu.
- e. Run the batch using the **Run** contextual menu.

For more details about the edition of the **.xml** batch parameter file, please refer to [Running Batches using the Batch Monitor](#) in the *Infrastructure User's Guide*.



1. Open the Batch Monitor.
2. Double-click **AnalysisUpdateBatch** in the Batch Monitor.

The AnalysisUpdateBatch dialog box appears.

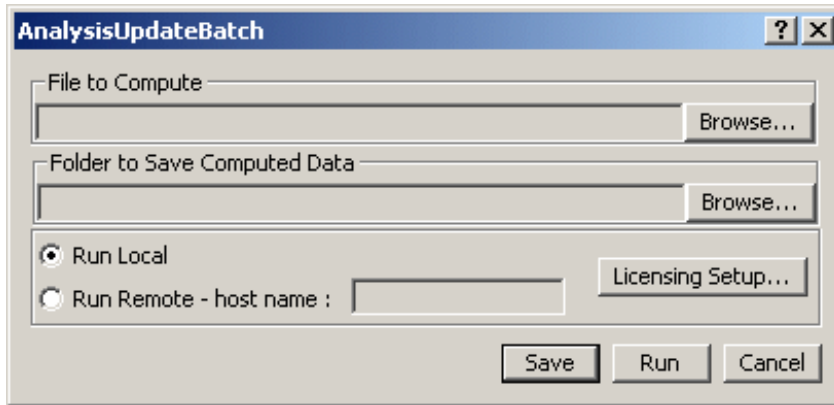

For more details about this dialog box, please click [here](#).

3. Click the **Browse...** button to choose the file to compute.

The File Selection dialog box appears to let you select the .CATAnalysis document you want to compute.

In this particular example, you can select the **sample00.CATAnalysis** from the samples directory and click **OK** in the File Selection dialog box.

Note that the **Folder to Save Computed Data** field is automatically updated.

By default, this folder is the same as the .CATAnalysis document.

You can change the default folder.



In remote mode, the folder you indicate in the **Folder to Save Computed Data** field will not be taken into account.

4. Select the **Run Remote** option.

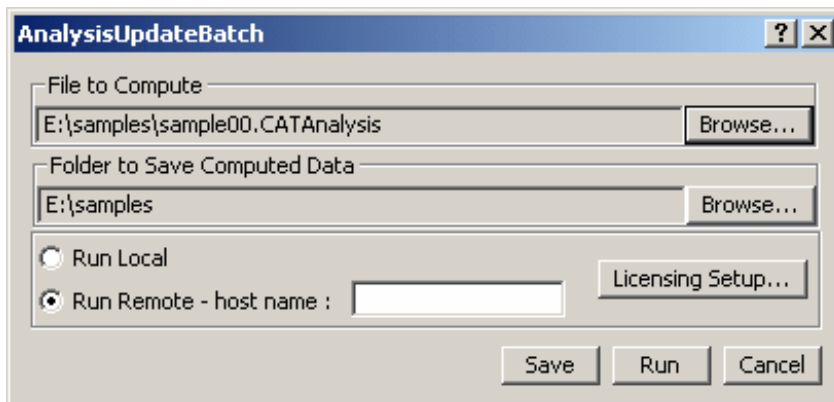

5. Enter the name of the remote machine in the **host name** field.

6. Click **Run** in the AnalysisUpdateBatch dialog box.

7. Select the **Processes** tab of the Batch Monitor.

The batch computation has been successfully done if you get **0** as **Return Code**.

**8.** Right-click the **AnalysisUpdateBatch** line and select the **Results** contextual menu.

The Results dialog box appears.

The **Updated file** field gives you the directory (on the remote machine) of the computed file.



# Results Visualization

**Image Creation: Generate images corresponding to analysis results**



**Visualize Deformations**

Create a deformed mesh image.



**Visualize Von Mises Stresses**

Create a von Mises stress field image.



**Visualize Displacements**

Create a displacement field image.



**Visualize Principal Stresses**

Create a principal stresses image.



**Visualize Precisions**

Create an error map image.

## Analysis Results



**Report**

Create an analysis report.



**Advanced Reporting**

Extract existing information for creating an analysis report.



**Historic of Computation**

Read and if needed modify the graphical properties.



### Elfini Listing

Give ELFINI solver listing.

## Results Management: Post-processes results and images



### Animate Images

Animate an image.



### Cut Plane Analysis

Examine results in a plane cut.



### Amplification Magnitude

Scale the deformed mesh amplitude.



### Extrema Detection

Search for global or local extrema of the analyzed field.

### Edit the Color Palette

Edit the Palette on Von Mises display.



### Information

Return information on generated images.



### Images Layout

Tile layout images



### Simplify Representation

Display a simplified representation while moving an image.



## Generate Images

Generate images that are not those included in the Image toolbar.



## Edit Images

Select the required options so that you may get the desired image.

## Save As New Template

Save an image as template.



## Generate 2D Display Visualization

Generate a 2D visualization for modulations, sensors and dynamic solutions.

## Export Data

Transfer data in a .txt or .xls file.



For every image type, you can [edit the Color Palette](#).

# Visualizing Deformations



This task shows how to generate Deformed Mesh images on parts.



*Deformed Mesh* images are used to visualize the finite element mesh in the deformed configuration of the system, as a result of environmental action (loading). Deformed Mesh Image objects can belong to Static Case Solution objects sets or to Frequency Case Solution objects sets.



Open the [sample23.CATAnalysis](#) document from the samples directory for this task.

## Before You Begin:

- Go to **View -> Render Style -> Customize View** and make sure the **Edges points, Shading** and **Materials** option are active in the Custom View Modes dialog box.
- Compute the solution.

For this, click the **Compute** icon



1. Click the **Deformation** icon



The **Deformed Mesh** object appears in the specification tree under the active Static Case Solution objects set.

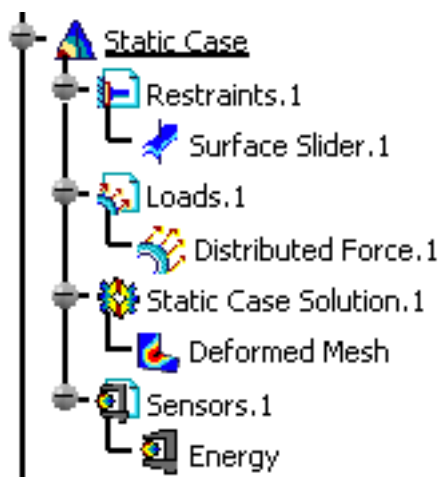

The Deformed Mesh on the part is visualized.

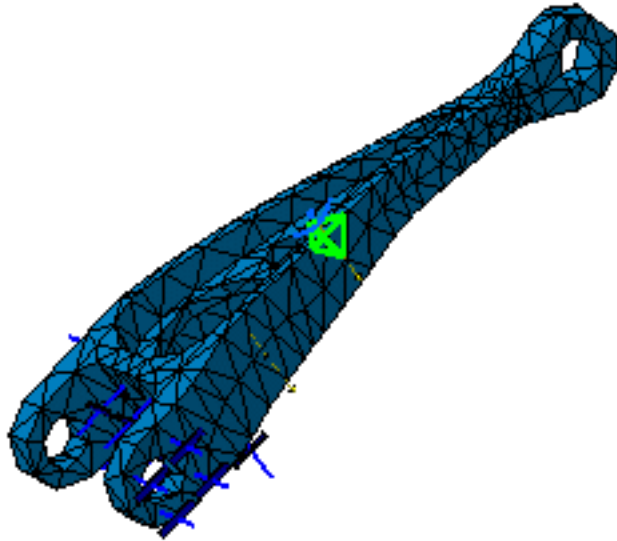

2. Double-click the **Deformed Mesh** object in the specification tree to edit the image.

The Image Edition dialog box appears.

For more details about the Image Edition dialog box, please click [here](#).

3. Click **OK** in the Image Edition dialog box.

The image corresponding to the settings you defined is now visualized.



### Products Available in Analysis Workbench



The **ELFINI Structural Analysis** product offers the following additional feature:

Right-click the **Deformed Mesh** object and select the **Report** contextual menu.

This option generates a report in .html and .txt formats.





# Visualizing Von Mises Stresses



This task shows how to generate von Mises images on part geometries.



*Von Mises Stress* images are used to visualize Von Mises Stress field patterns, which represent a scalar field quantity obtained from the volume distortion energy density and used to measure the state of stress.

Von Mises Stress Image objects belong to Static Case Solution objects sets.

The volume distortion energy density is often used in conjunction with the material yield stress value to check part structural integrity according to the Von Mises criterion. For a sound structural design, the maximum value of the Von Mises stress should be less than this yield value.



Open the [sample22.CATAnalysis](#) document from the samples directory.

## Before You Begin:

- Go to **View -> Render Style -> Customize View** and make sure the **Materials** option is active in the Custom View Modes dialog box.
- Compute the solution.

For this, click the **Compute** icon  .



1. Click the **Von Mises Stress** icon  .

The Von Mises Stress image is displayed, and a **Von Mises Stress (nodal value)** Image object appears in the specification tree under the active Static Case Solution objects set.

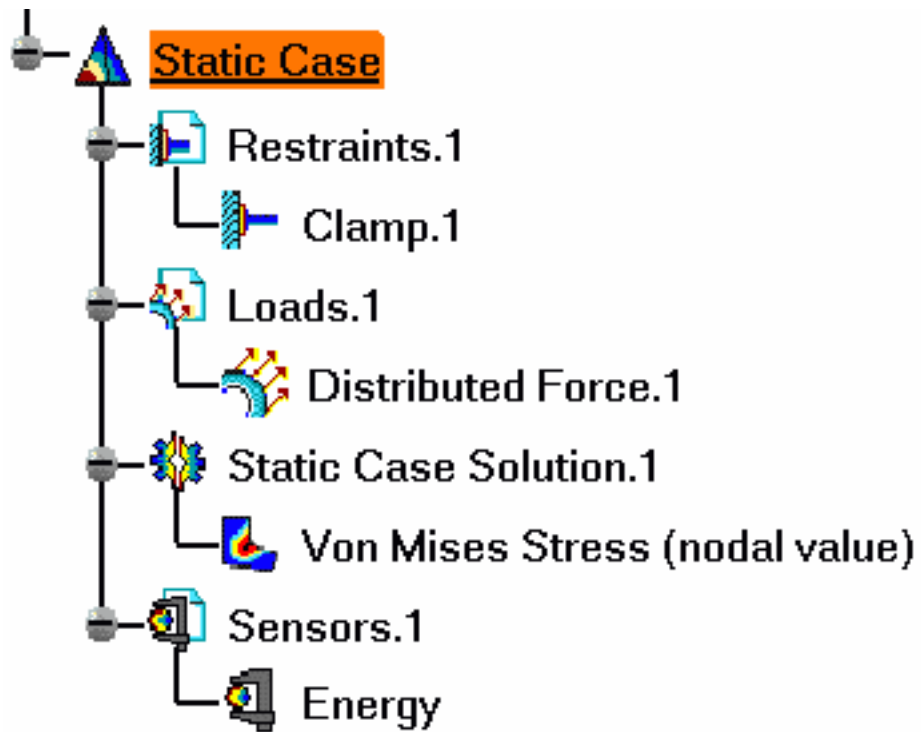

The Von Mises Stress distribution on the part is visualized in Iso-value mode, along with a color palette.

You can visualize the Von Mises Stress image in different ways by modifying the Custom view modes. To do this, you open the **View** menu and select **Render Style - > Customize View** option.

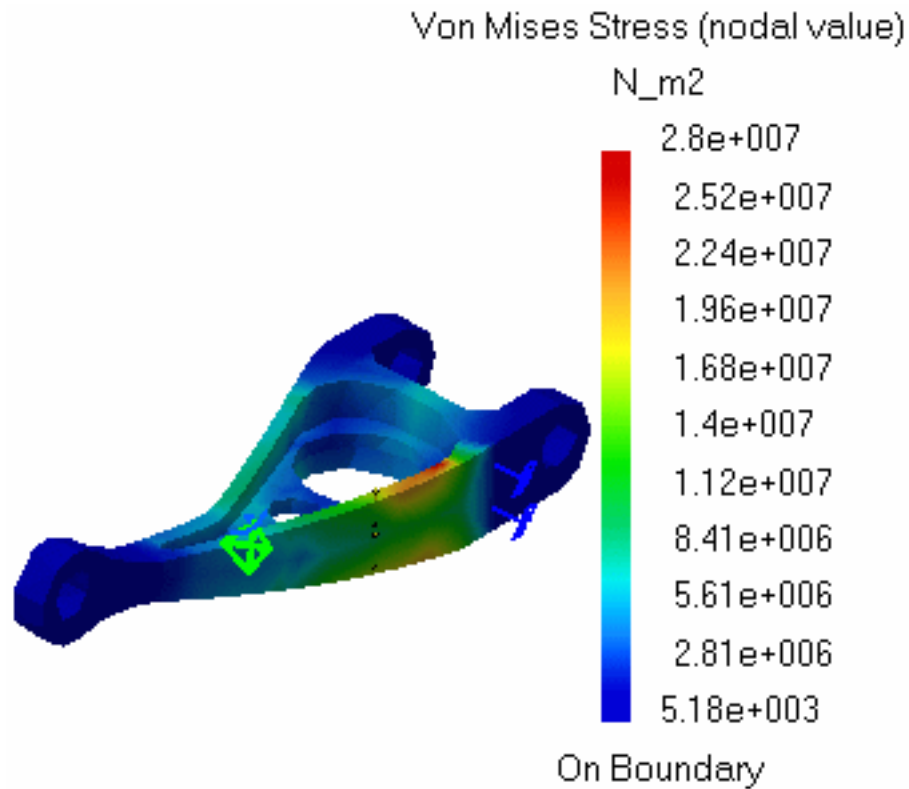

2. When the mouse cursor is passing over finite elements of the mesh, the values of the Von Mises Stress are visualized at each of their nodes.

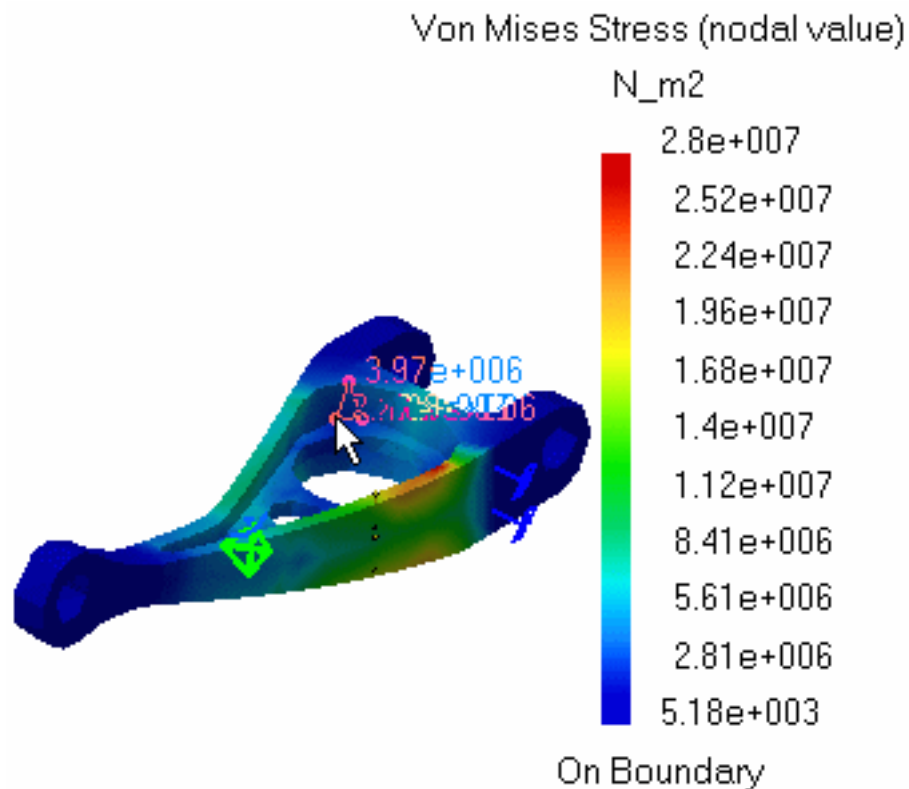

3. Select a finite element to obtain a steady display.

4. Double-click the **Von Mises Stress** Image object in the specification tree to edit the image.

The Image Edition dialog box appears.

For more details about the Image Edition dialog box, please click [here](#).

5. Click **OK** in the Image Edition dialog box.

An image corresponding to your settings is visualized.



#### Products Available in Analysis Workbench



The **ELFINI Structural Analysis** product offers the following additional feature:

Right-click the **Stress Von Mises** feature in the specification tree and select the **Report** contextual menu.

This option generates a report in .html and .txt formats.



# Visualizing Displacements



This task shows how to generate Displacement images on parts.



*Translational Displacement vector* images are used to visualize **displacement field patterns**, which represent a vector field quantity equal to the variation of position vectors of material particles of the system as a result of environmental action (loading). Translational Displacement vector Image objects can belong to Static Case Solution objects sets or to Frequency Case Solution objects sets.

The displacement resulting from part loading is important for a correct understanding of the way in which the part behaves.



Open the [sample23.CATAnalysis](#) document from the samples directory.

## **Before You Begin:**

Compute the solution.



For this, click the **Compute** icon .



1. Click the **Displacement** icon  .

The Translational Displacement vector image is displayed and a **Translational displacement vector** Image object appears in the specification tree under the active Static Case Solution objects set.

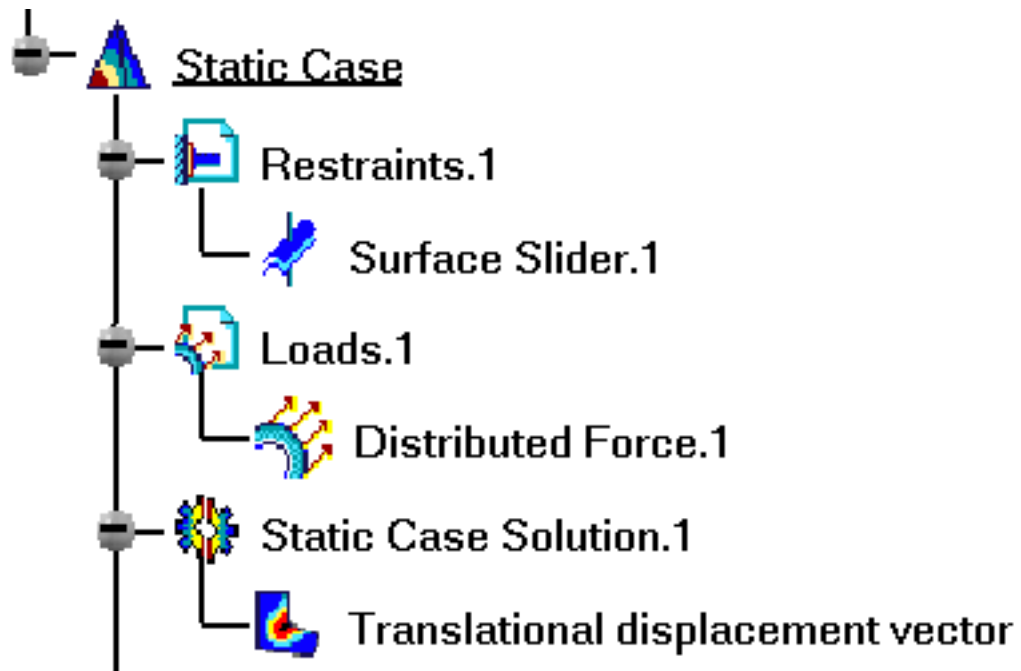

The Translational displacement vector distribution on the part is visualized in arrow symbol mode, along with a color palette.

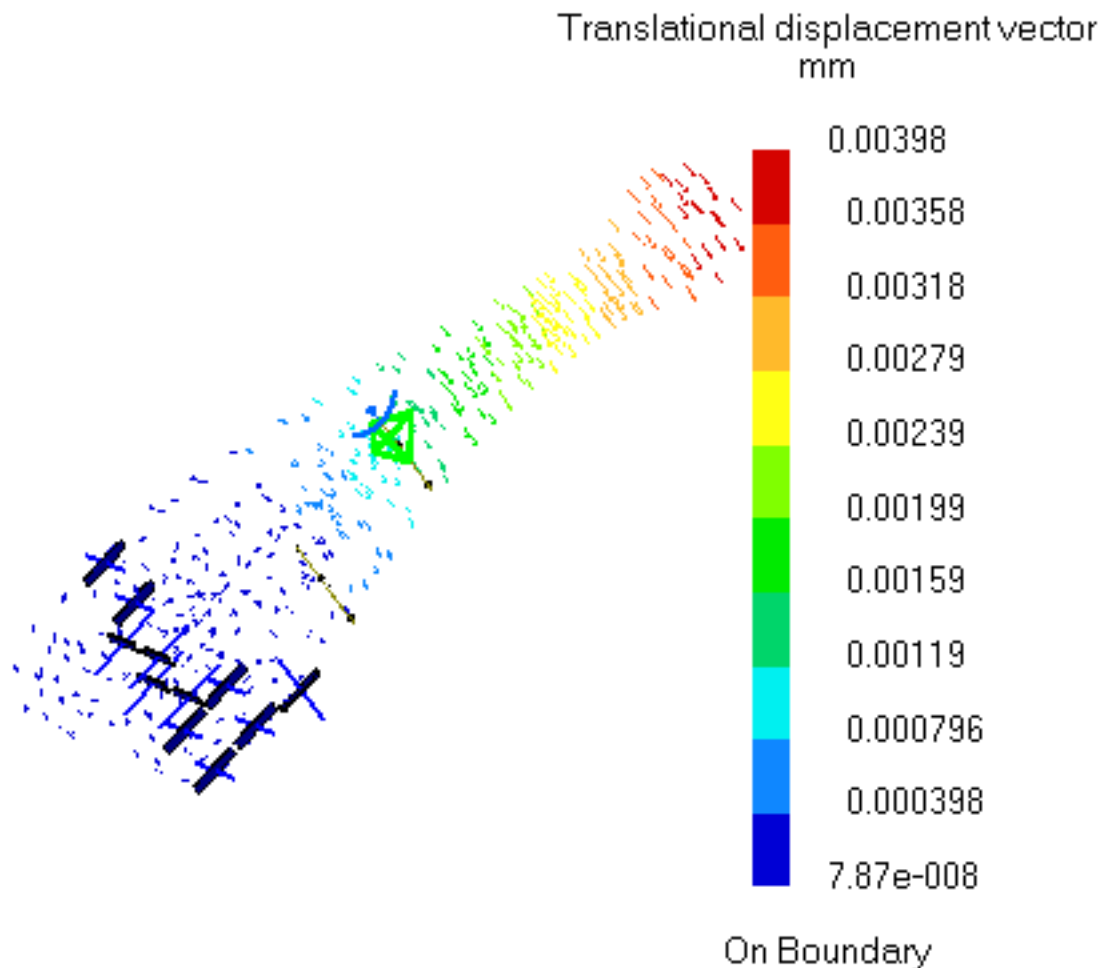

2. When the mouse cursor is passing over vector arrow symbols, their components

with respect to the global reference frame are visualized.

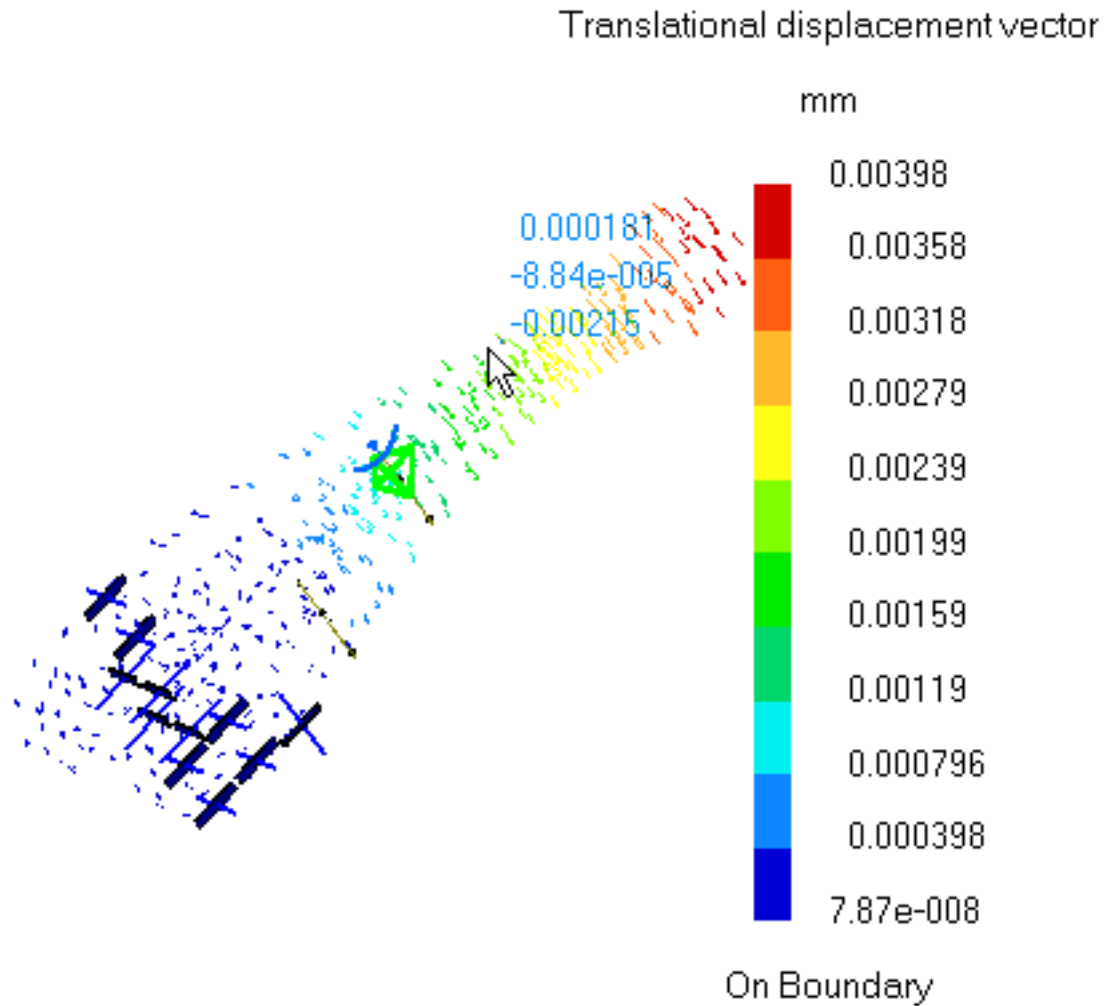

3. Select an arrow to obtain a steady display.
4. Double-click the **Translational displacement vector** Image object in the specification tree to edit the image.

The Image Edition dialog box appears.

For more details about the Image Edition dialog box, please click [here](#).

5. Click **OK** in the Image Edition dialog box.



## Products Available in Analysis Workbench



The **ELFINI Structural Analysis** product offers the following additional feature:

Right-click the **Translational displacement vector** feature in the specification tree and select the **Report** contextual menu.

This option generates a report in .html and .txt formats.





# Visualizing Principal Stresses



This task shows how to generate Stress principal tensor symbol images on part geometries.



*Stress principal tensor symbol* images are used to visualize **principal stress field patterns**, which represent a tensor field quantity used to measure the state of stress and to determine the load path on a loaded part.

Stress principal tensor symbol Image objects belong to Static Case Solution objects sets.

At each point, the principal stress tensor gives the directions relative to which the part is in a state of pure tension/compression (zero shear stress components on the corresponding planes) and the values of the corresponding tensile/compressive stresses.



Open the [sample24.CATAnalysis](#) document from the samples directory.

## **Before You Begin:**

Compute the solution.



For this, click the **Compute** icon .



1. Click the **Principal Stress** icon  .

The Stress principal tensor symbol image is displayed, and a **Stress principal tensor symbol** Image object appears in the specification tree under the active Static Case Solution objects set.

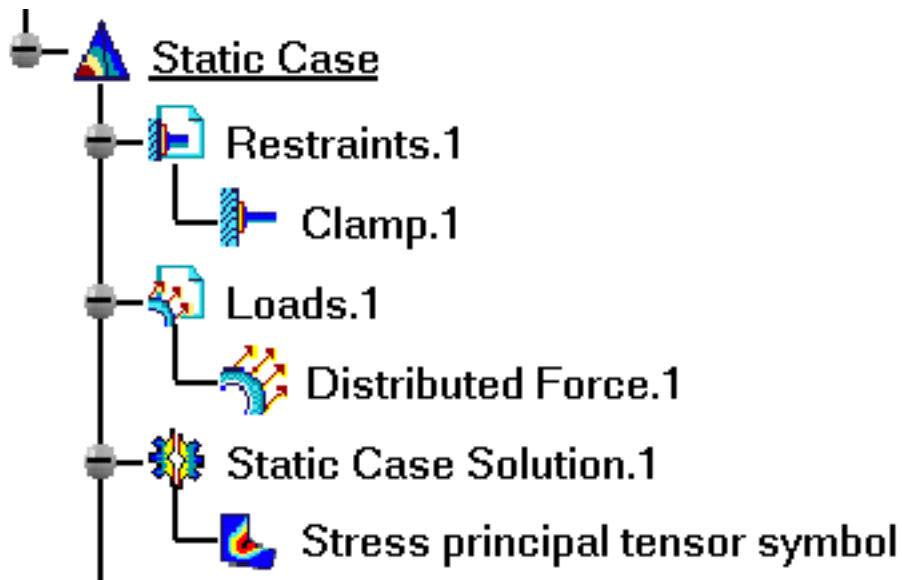

You can visualize the Stress principal tensor symbol image in different ways by modifying the Custom view modes. To do this, you open the **View** menu and select **Render Style -> Customize View** option.

The principal values stress tensor distribution on the part is visualized in symbol mode, along with a color palette:

- At each point, a set of three directions is represented by line symbols (principal directions of stress).
- Arrow directions (inwards / outwards) indicate the sign of the principal stress. The color code provides quantitative information.

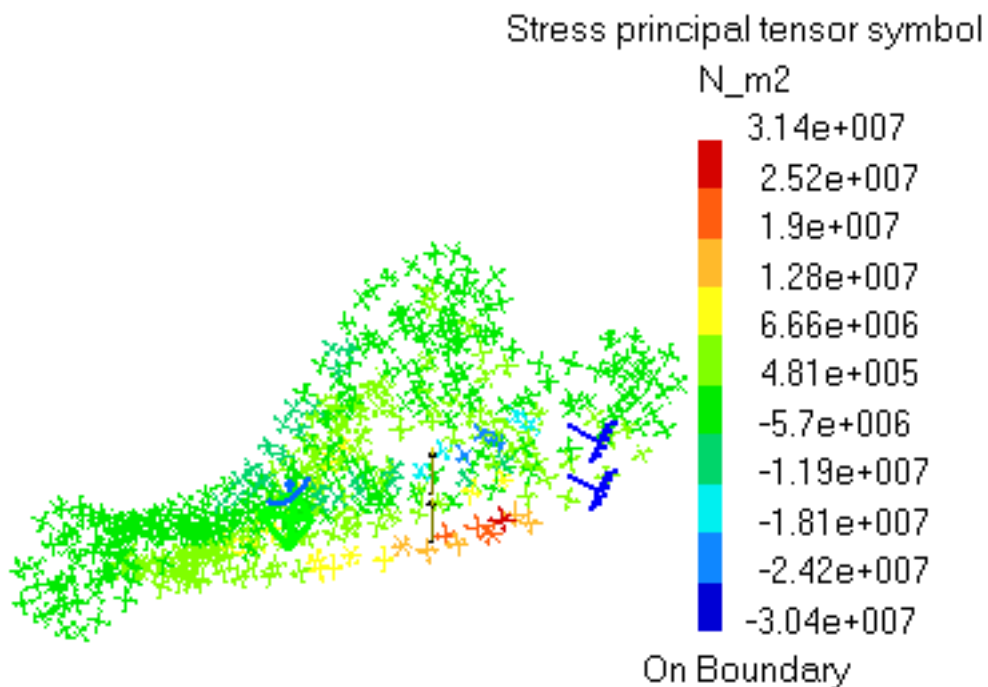

2. When the mouse cursor is passing over tensor symbol representations, their principal values are displayed.

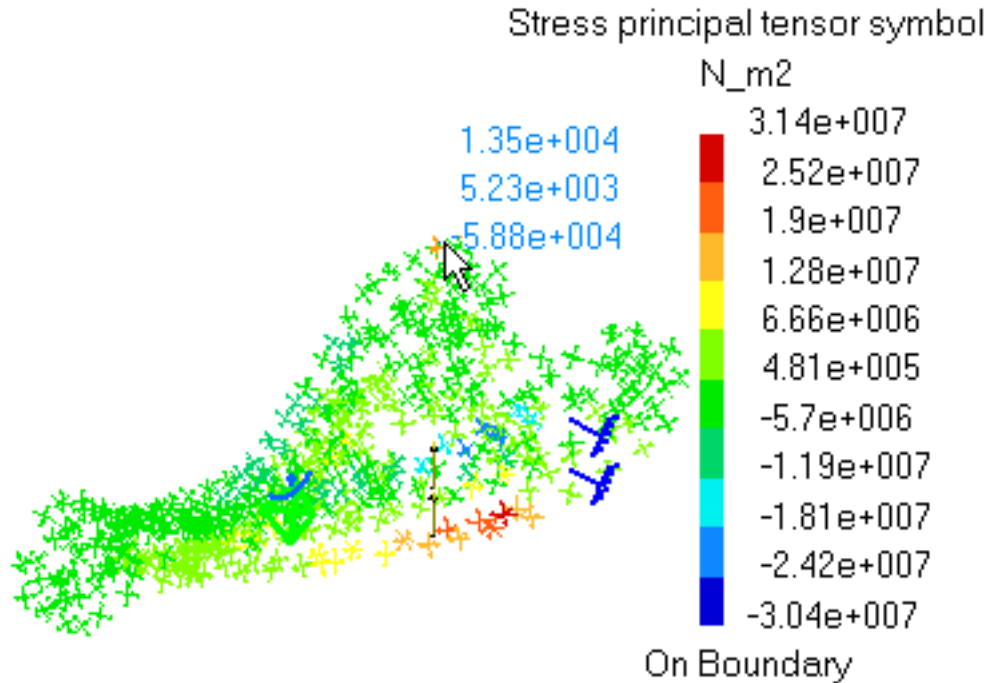

3. Select a tensor symbol to obtain a steady display.
4. Double-click the **Stress principal tensor symbol** object in the specification tree to edit the image.

The Image Edition dialog box appears.

For more details about the Image Edition dialog box, please click [here](#).

5. Click **OK** in the Image Edition dialog box.



### Products Available in Analysis Workbench



The **ELFINI Structural Analysis** product offers the following additional feature:

Right-click the **Stresses Principal tensor** object in the specification tree and select the **Report** contextual menu.

This option generates a report in .html and .txt formats.



# Visualizing Precisions



This task shows how to generate Estimated local error images on parts.



*Estimated local error* images are used to visualize **computation error maps**, which represent scalar field quantities defined as the distribution of energy error norm estimates for a given computation.

Estimated local error Image objects belong to Static Case Solution objects sets.

The program evaluates the validity of the computation and provides a global statement about this validity. It also displays a predicted energy error norm map which gives qualitative insight about the error distribution on the part.



Open the [sample25.CATAnalysis](#) document from the samples directory.

## **Before You Begin:**

- Go to **View -> Render Style -> Customize View** and make sure the **Edges, Shading, Outline and Materials** options are active in the Custom View Modes dialog box.
- Compute the solution.

For this, click the **Compute** icon  .



1. Click the **Precision** icon  .

The Estimated local error image is displayed and an **Estimated local error** Image object appears in the specification tree under the active Static Case Solution objects set.

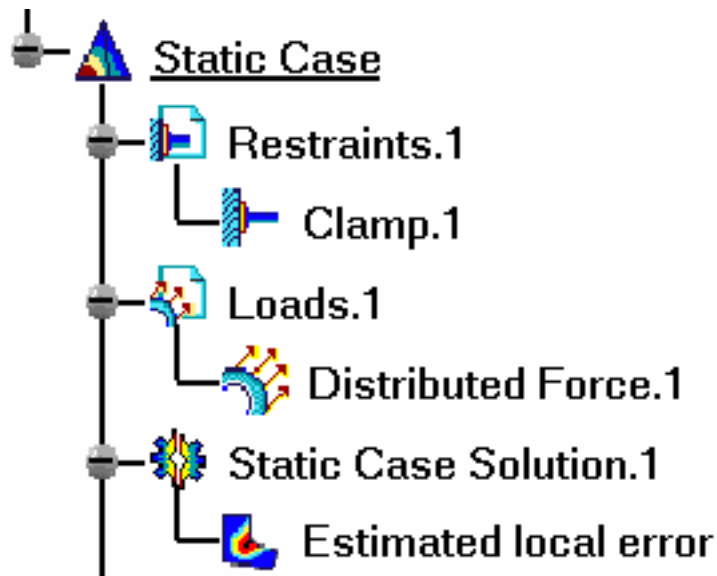

You can visualize the Estimated Error image in different ways by modifying the Custom view modes. To do this, you open the **View** menu and select **Render Style - > Customize View** option.

The Estimated local error distribution on the part is visualized in fringe pattern mode, along with a color palette.

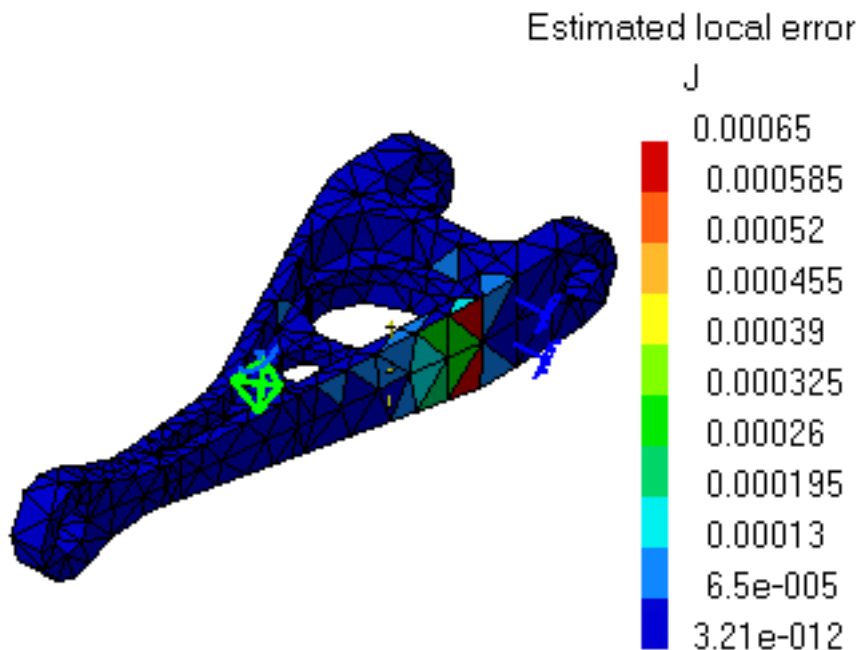

This map provides qualitative information about the way in which estimated computation errors are relatively distributed on the part.

- If the error is relatively large in a particular region of interest, the computation results in that region may not be reliable. A new computation can be performed to obtain better precision.

- To obtain a refined mesh in a region of interest, use smaller Local Size and Sag values in the mesh definition step.
2. When the mouse cursor is passing over a finite element, its Error Estimate (relative strain energy variation) is displayed.

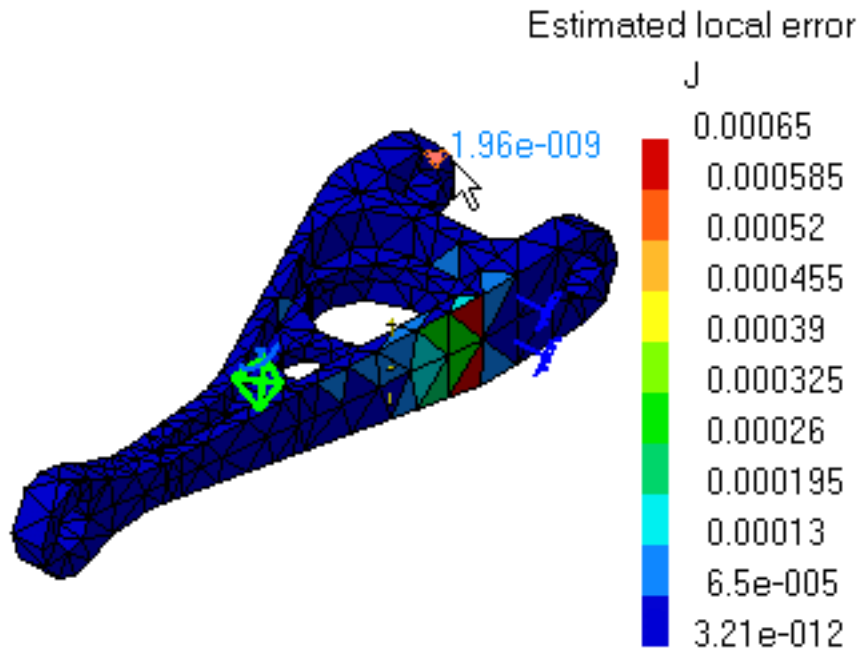

3. Select a finite element to obtain a steady display.
4. Double-click the **Estimated local error** object in the specification tree to edit the image.

The Image Edition dialog box appears.

For more details about the Image Edition dialog box, please click [here](#).

5. Click **OK** in the Image Edition dialog box.



### Products Available in Analysis Workbench



The **ELFINI Structural Analysis** product offers the following additional feature:

Right-click the **Estimated local error** feature in the specification tree and select the **Report** contextual menu.

This option generates a report in .html and .txt formats.



# Reporting



This task shows how to generate a report for computed solutions.

You can generate a report:

- using the [Basic Analysis Report icon](#)
- using the [Report contextual menu](#) (only available in the **ELFINI Structural Analysis** product)



A report is a summary of an objects set computation results and status messages, captured in an editable file.

Once an objects set has been computed (meaning that the user-defined specifications have been converted into solver commands, which in turn have been transformed into degree of freedom data and processed), all data contained in the object is ready for use in the subsequent finite element computation process and the object can be analyzed.



- Open the [sample56.CATAnalysis](#) document from the samples directory.
- Compute the solution. For this, click the **Compute** icon .

## Using the Basic Analysis Report Command



1. Click the **Basic Analysis Report** icon .

The Reporting options dialog box appears.

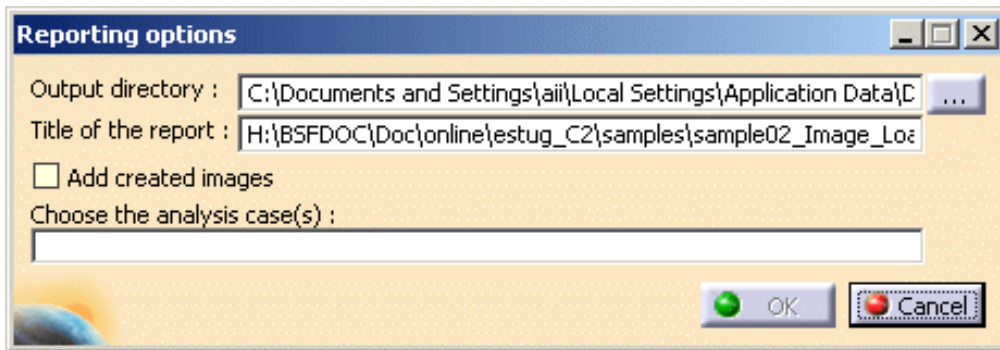

- **Output directory:**  
Pressing the button on the right gives you access to your file system for defining a path for the output Report file. You can edit the title of the report.
- **Title of the report:**  
Modify the title, if desired.
- **Add created images:**  
Add automatically in the basic report the images created in the selected case.
- **Choose the analysis case(s)**

2. Set the path and click **OK** to close the dialog box.

A HTML file containing the Report of the Static Case Solution objects set computation is displayed. It contains information relative to the static computation procedure:

## sample02\_Image\_Loads.CATAnalysis

### MESH:

Entity	Size
Nodes	424
Elements	1003

### ELEMENT TYPE:

Connectivity	Statistics
TE4	1003 ( 100.00% )

- restraints translation
- loads translation
- numbering
- SPC singularity auto-fixing
- constraints factorization
- stiffness computation
- constrained stiffness and loads computation
- stiffness factorization
- displacement computation
- reactions computation
- equilibrium checking

For example, you will find the image of the Von Mises Stress (nodal value) you previously generated.



## Von Mises Stress (nodal value)

Von Mises Stress (nodal value)

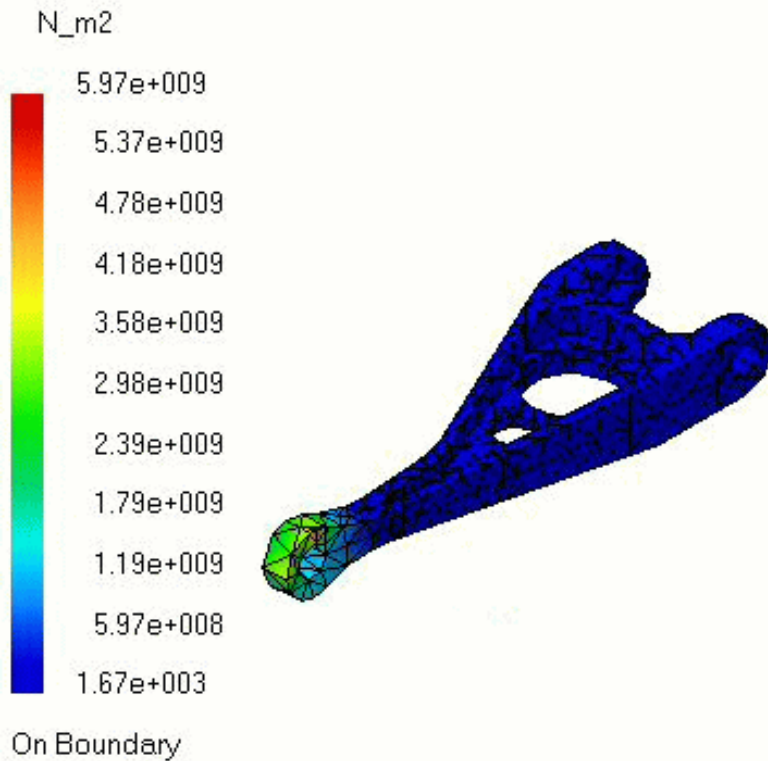

3. If needed, you can perform the same operation with the Frequency Case.

A HTML file containing the Report of the Frequency Case Solution objects set computation is displayed. It contains information relative to the frequency computation procedure. In complement to the Static Case Report, one finds items such as:

- o a list of vibration frequencies
- o a list modal participation factors

4. Click **OK** in the Reporting options dialog box.



In addition to the HTML Report file, the program also generates a Text file ready for user editing.

Click here to open the .txt file: [sample02\\_Image\\_Loads.txt](#).



## Using the Report contextual menu



Only available with the **ELFINI Structural Analysis (EST)** product.



You can access the **Report** contextual menu on images and on several pre-processor sets as Loads, Restraints, Mass, Properties.



1. Generate an image.



For more details, please refer to [Generating Images](#).

2. Right-click on the image feature in the specification tree and select the **Report** contextual menu.

The Report automatically appears and can now be saved, if needed in the directory you wish using **File -> Save as...** command.



# Advanced Reporting



This task shows how to extract the desired data and generate a report for computed solutions.

An advanced report is an extract summary of an objects set computation results and status messages, captured in a .html file.



Only available with the **ELFINI Structural Analysis (EST)** product.



- Open the [sample56.CATAnalysis](#) document from the samples directory.



- Compute the solution: for this, click the **Compute** icon.



1. Create an image. In this particular example, click the **Deformation** icon .



2. Click the **Advanced Reporting** icon.

The Reporting Options dialog box appears.

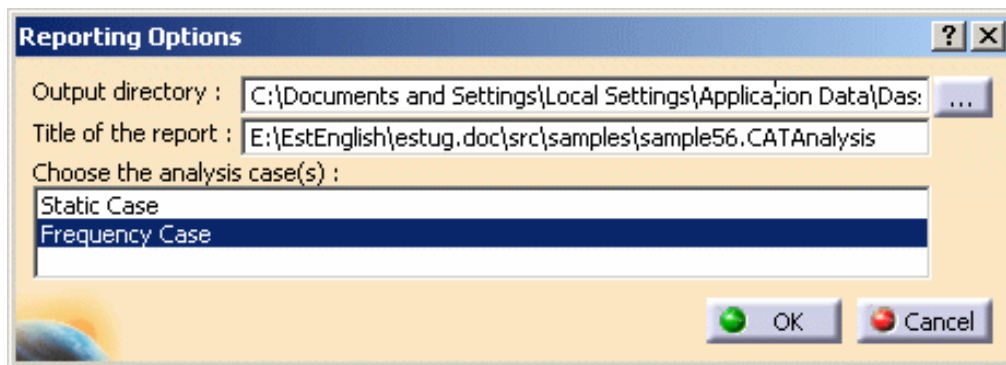

- **Output directory:** lets you change the directory in which you will store the .html advanced report.



The last selected path is automatically proposed.

- **Title of the report:** lets you modify the title of the .html advanced report.
- **Choose the analysis case(s):** lets you choose the analysis case for which you want to work.



Multi-selection of analysis cases is available.

3. Modify the **Output directory** by clicking the ... button and choose the desired path.
4. Modify the name of the report if needed.

In this particular example, enter **Analysis Report (56)** as **Title of the report** option.

5. Choose the desired analysis case(s).

In this particular example, select **Frequency Case**.

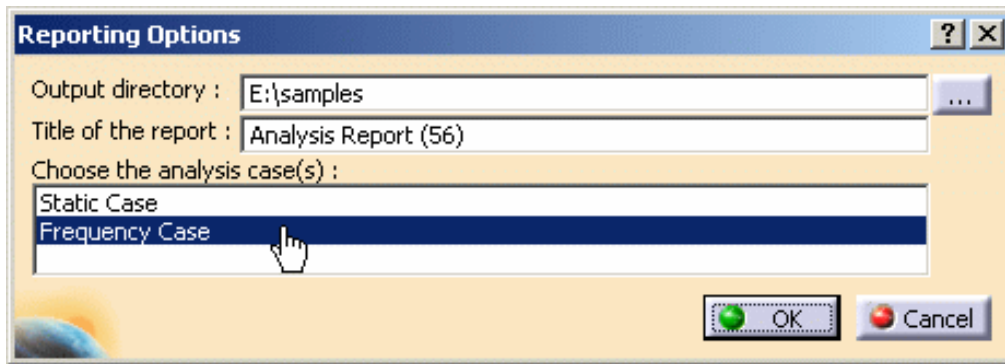

6. Click **OK** in the Reporting Options dialog box.

The Advanced reporting options dialog box appears and lets you define which information you wish to extract from all the specifications before launching the browser, creating and if needed updating the output Report file.

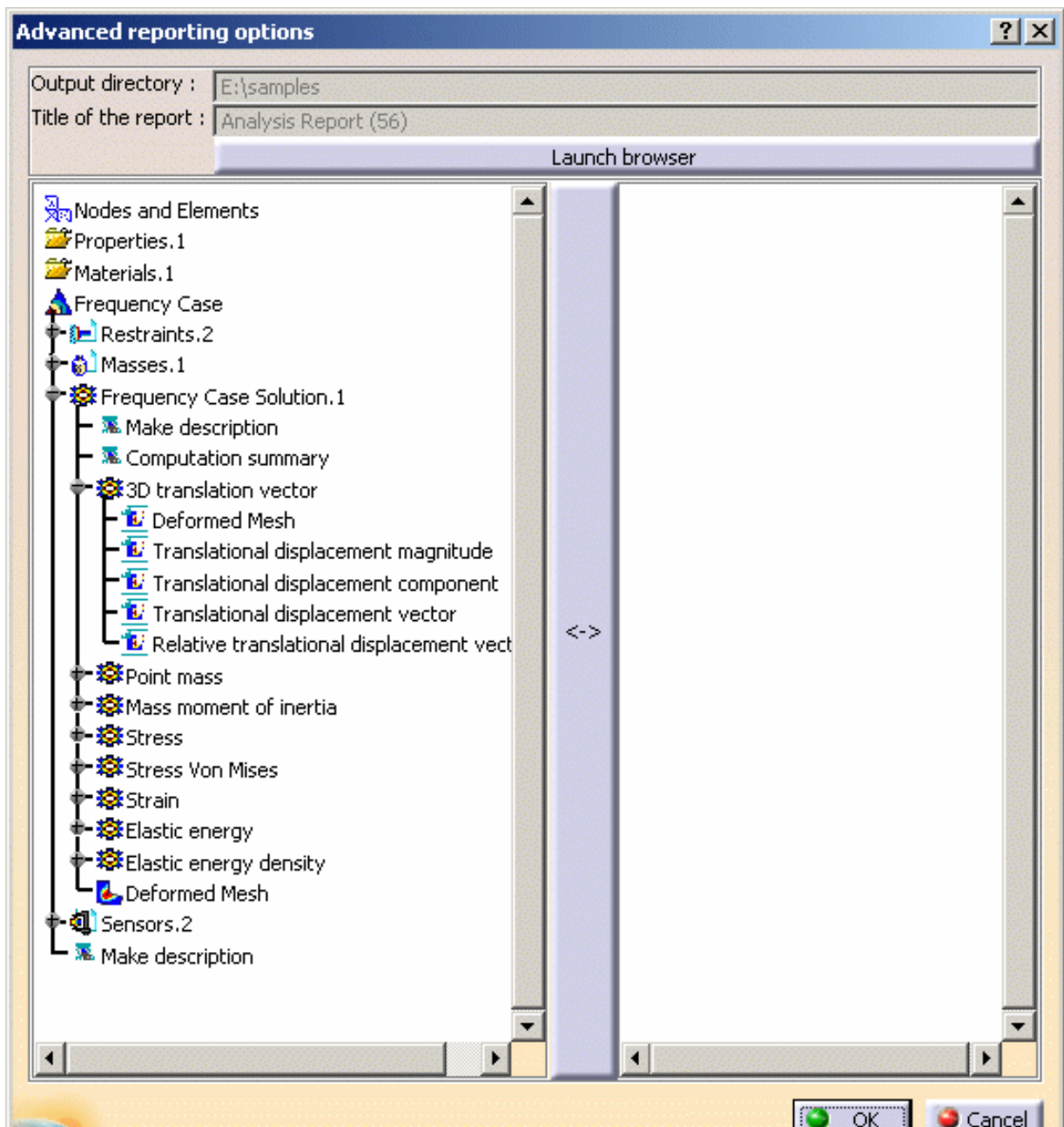



There are two windows in the Advanced reporting options dialog box. The left window displays the data corresponding to the specification tree. The right window displays the data which you want to appear in the advanced report:

- Left window: contains all the entities you can export in the report. You can select a node to expand it (you can also double-click the entity associated to this node). The entity types are:
  - Text:
    - **Make description**
    - **Computation summary**
  - Images: grouped according to the physical types. Each time you add an image in the report, the representation is performed using the current viewpoint.
    - pre-defined images
    - user images
- Right window: contains all the entities which will be contained in the report.
- **Launch browser**: this button lets you launch the .html navigator.

**7.** Select all the desired entities.

In this particular example, double-click:

- **Make description** (under **Frequency Case Solution.1**),
- **Translational displacement magnitude** (under **3D translational vector**) as pre-defined image,
- **Deformed Mesh** (under **Frequency Case Solution.1**) as user image.

**8.** Click **OK** in the Advanced Reporting Options dialog box.



In addition to the HTML report file, the program also generates a text (.txt) file in the same output directory.



# Reading a Historic of Computation



This task shows how to read and if needed modify the graphical properties of a Historic of Computation.



A *Historic of computation* allows comparing new values possibly assigned to a CATAnalysis. For this you need to perform at least two computation operations.





You can use the [sample30.CATAnalysis](#) document from the samples directory for this task.

## Before You Begin:

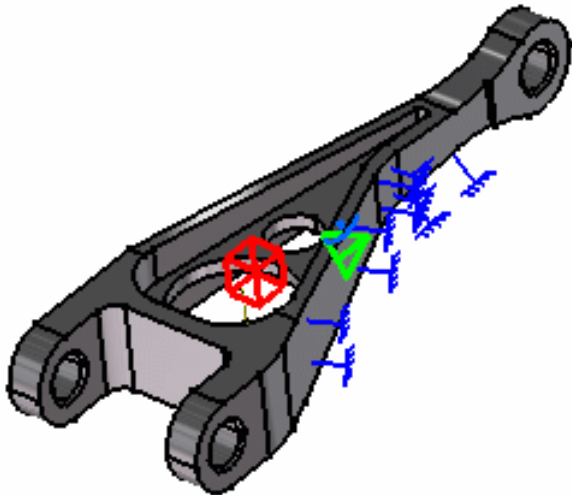
- Go to **View -> Render Style -> Customize View** and make sure the **Materials** option are active in the Custom View Modes dialog box.
- Compute the solution. For this, click the Compute icon .



1. Assign Global Error and Von Mises sensors. For this, right-click on **Sensors** in the specification tree and select the **Create Sensor** contextual menu. Select **misesmax** option from the Sensor Creation dialog box and then click **OK**. Repeat the same operation for creating the **globalerror** sensor.
2. Click the **Compute** icon  (**All** option).
3. Modify the Global Mesh Size. For this, double-click in the specification tree on the **OCTREE Tetrahedron Mesh.1** object and modify the size value to **10 mm**.
4. Click the **Compute** icon  (**All** option).
5. Select the **Local Mesh Size** icon , the desired support (for example, a face) and modify the global size value to **5 mm**.

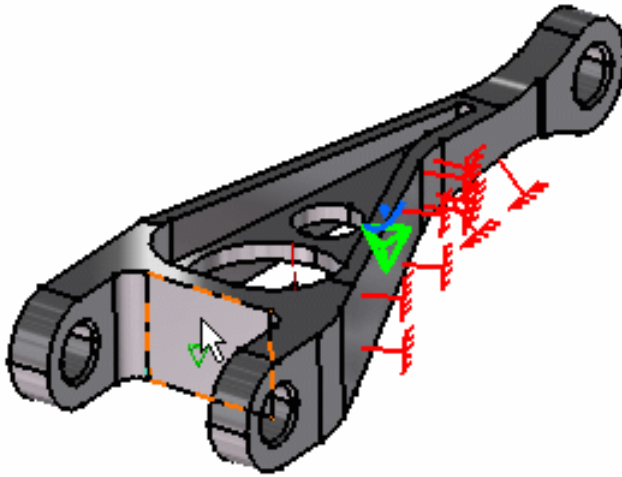

6. Click the **Compute** icon  (All option).

7. Click the **Historic of Computations** icon .

The Convergence of computation visualization dialog box is displayed with the Historic of Computation for the current case. You can select the different options at the right of the dialog box and thus display the convergence information as desired:

- **By default:** Number of Elements, Number of Nodes.
- **Static Case:** energy, mises max, disp max, global error (results based on created sensors). If Adaptivity boxes were previously created, one local error per box appears on the graph.
- **Frequency Case:** frequency for each mode requested in the computation operation (results based on created sensors).

## Global Precision

Note that if you position the cursor on the graph, the corresponding coordinates automatically appear at the bottom of the Convergence of computation visualization dialog box.

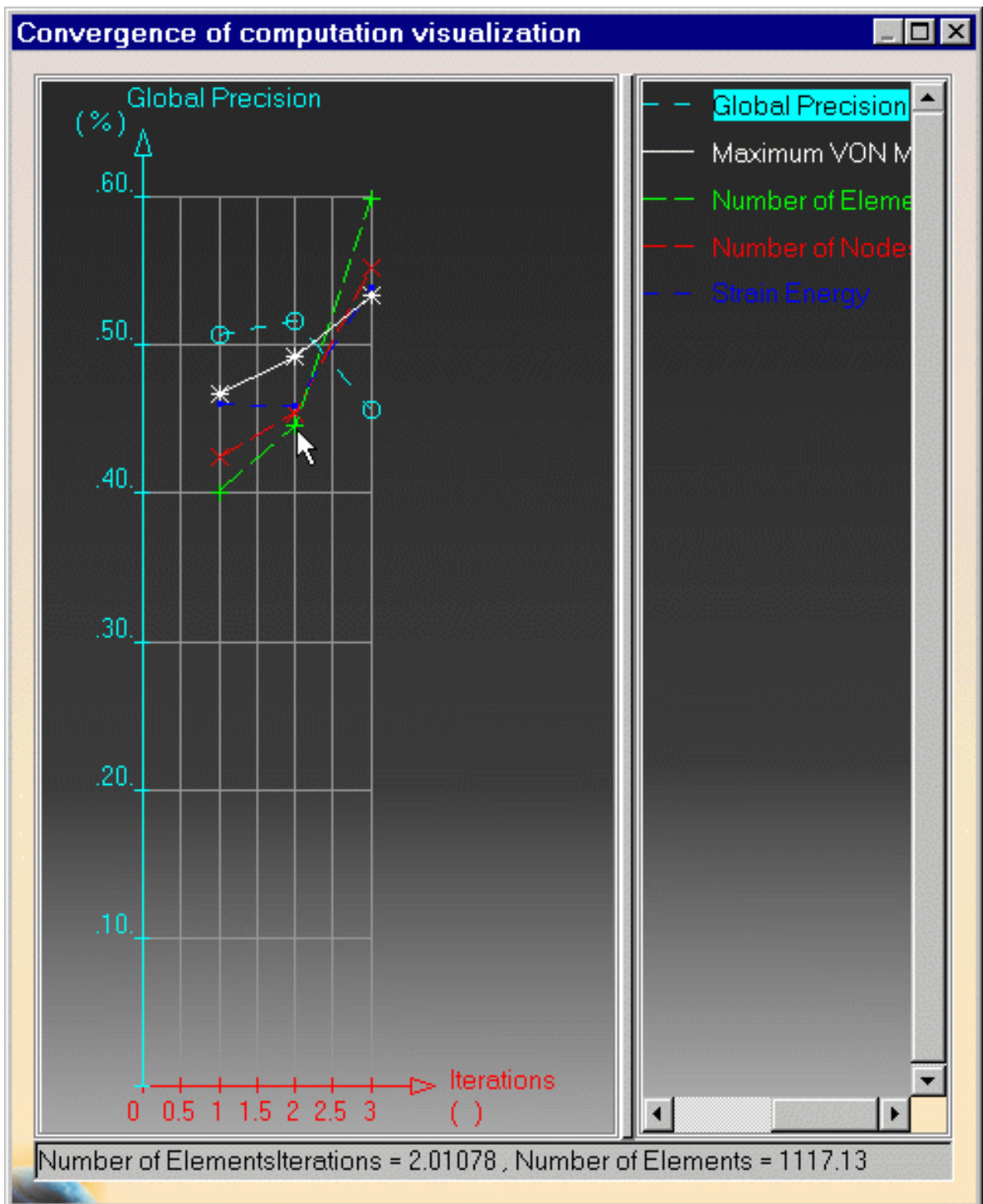

Von Mises (Sensors)



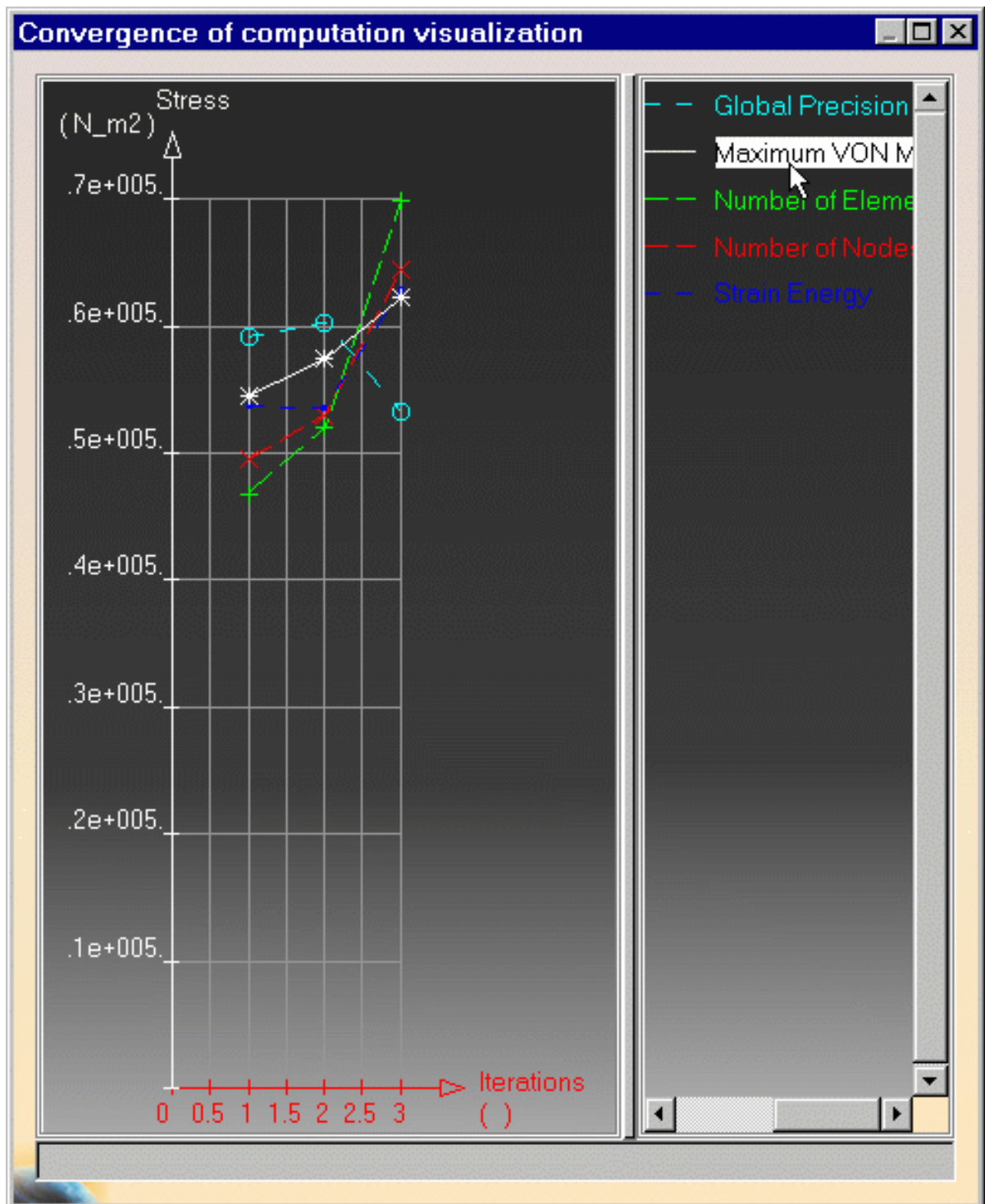

You can edit the graph. For this:

8. Double-click on the line you want to edit. In this example, the Global Precision line.

The EditPopup dialog box appears:

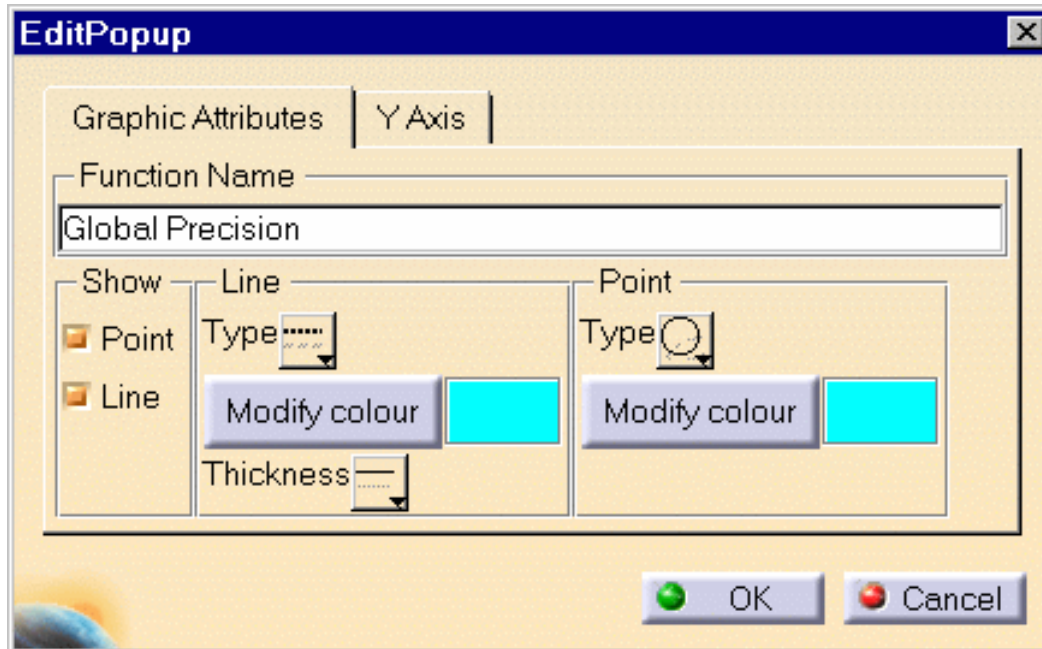

You can modify the following Graphic Attributes and then click **OK**:

- **Function Name**: enter the desired new name.
- **Show**: you can show or not points and lines.
- **Line**: you can modify the line type, color and thickness.
- **Point**: you can modify the type and color of the points.

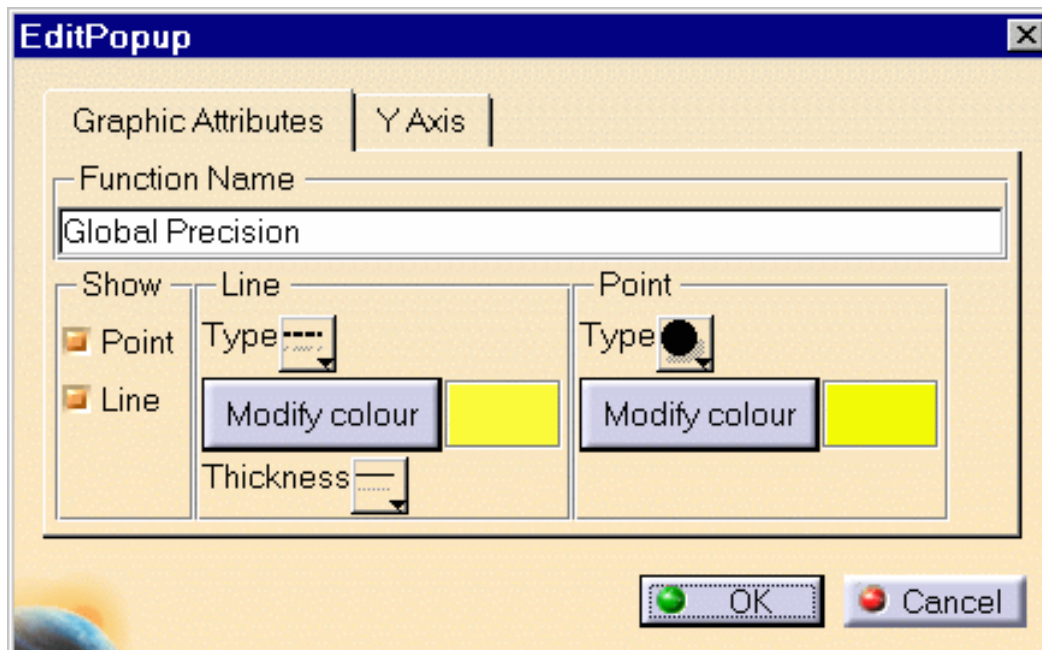

You will get this in the Convergence of computation visualization dialog box:

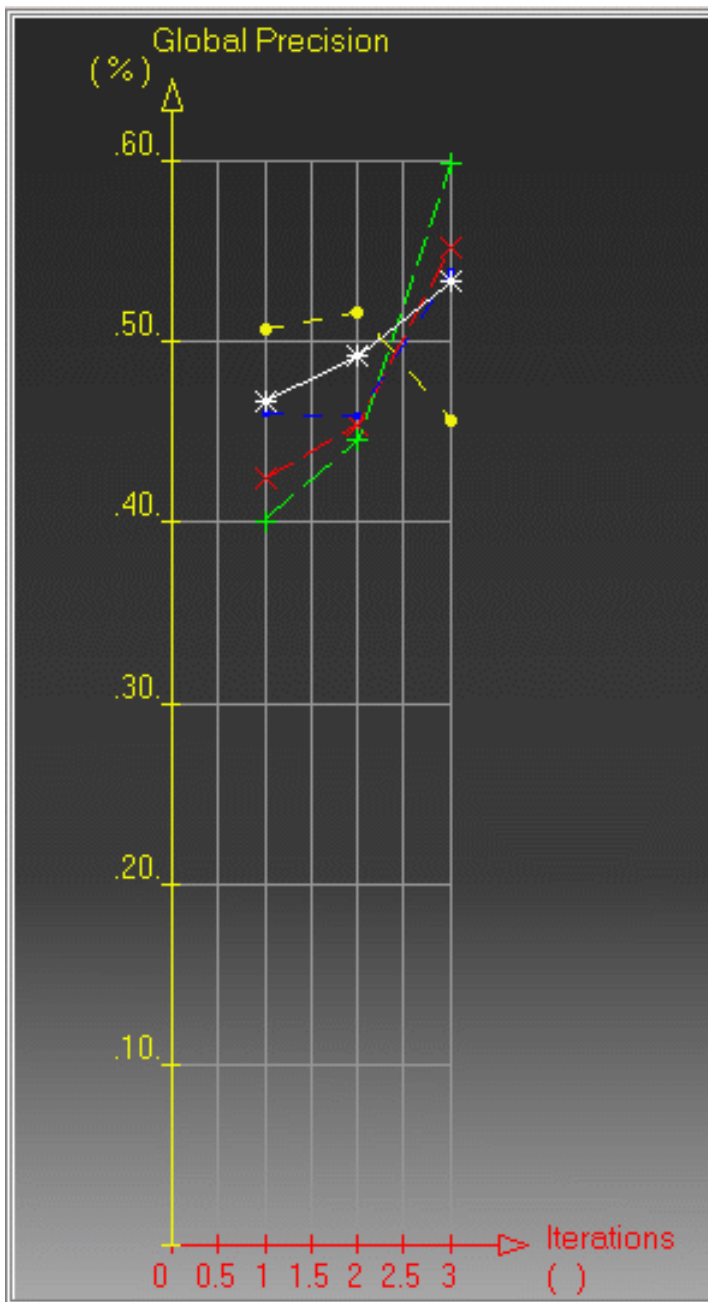

# Elfini Listing



This task shows how to extract the desired data and generate a Report for Computed Solutions. The generated file is called **FICELF**.

The Elfini Listing file contains all the computation data of all the documents you computed in a CATIA session.



When restarting a CATIA session, a new FICELF file is generated.

If you want to store the particular CATIA session FICELF, you have to copy it after closing the CATIA session.



Open the [sample02\\_Image\\_Loads.CATAnalysis](#) document from the samples directory.



1. Click the **Elfini Listing** icon .

The Elfini Listing dialog box appears.

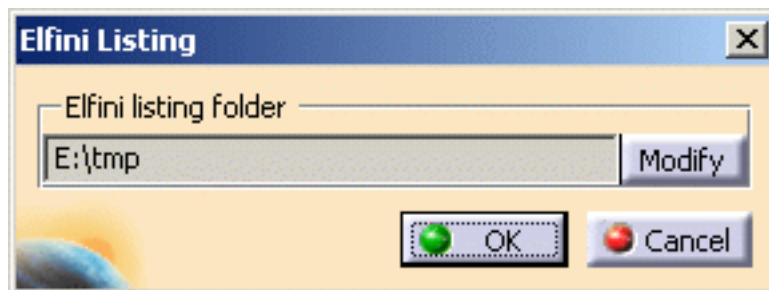

The **Modify** button lets you change the Elfini Listing Folder location.

2. Click the **Modify** button.

The Selection dialog box appears.

3. Select the desired path in the Selection dialog box and click **OK**.
4. Click **OK** in the Elfini Listing dialog box.



# Animating Images



This task shows how to animate one image or a multi-selection of images.

Image Animation is a continuous display of a sequence of frames obtained from a given image. Each frame represents the result displayed with a different amplitude. The frames follow each other rapidly giving the feeling of motion.

By animating a deformed geometry or a normal vibration mode, you can get a better insight of the behavior of the system. Sometimes, you gain a more thorough understanding of the system behavior.



Open the [sample26.CATAnalysis](#) document from the samples directory.

## Before You Begin:

- Go to **View -> Render Style -> Customize View** and make sure the **Edges and points** option is not active and the **Materials** option is active in the Custom View Modes dialog box.
- Compute the solution.

For this, click the **Compute** icon .

- Activate the **Stress Von Mises** image.  
For this, right click the **Von Mises Stress (nodal value)** feature from the specification tree and select the **Activate/Deactivate** option from the displayed contextual menu.



1. Click the **Animate** icon .



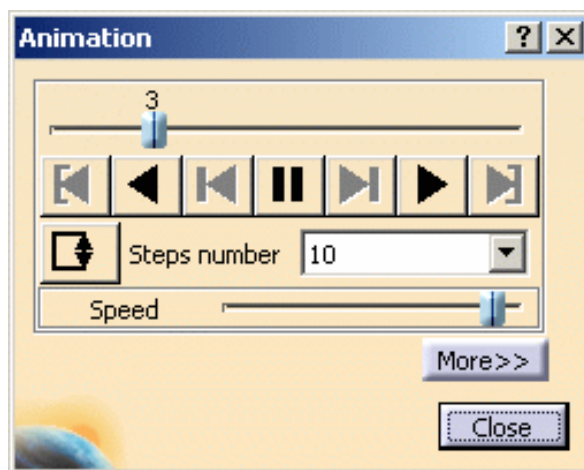



The Animation dialog box appears and the image is animated with default animation parameters.



- Slider: lets you manually select the desired step.

- **Play:**

- : **Jump to Start**
- : **Play Backward**
- : **Steps Backward**

- : **Pause**
- : **Steps Forward**
- : **Play Forward**
- : **Jump to End**
- **Change loop mode:**
  - : plays once in one shot
  - : repeats play non stop
  - : repeats play and reverse non stop

For a smooth animation enter the maximum value (**20**) as **Steps number** option and activate the **Repeat play and reverse non stop** button.

- **Steps number:** makes the animation more or less fluent.
- **Speed:** lets you manually define the desired speed.
- **More:** this button expands the Animation dialog box.

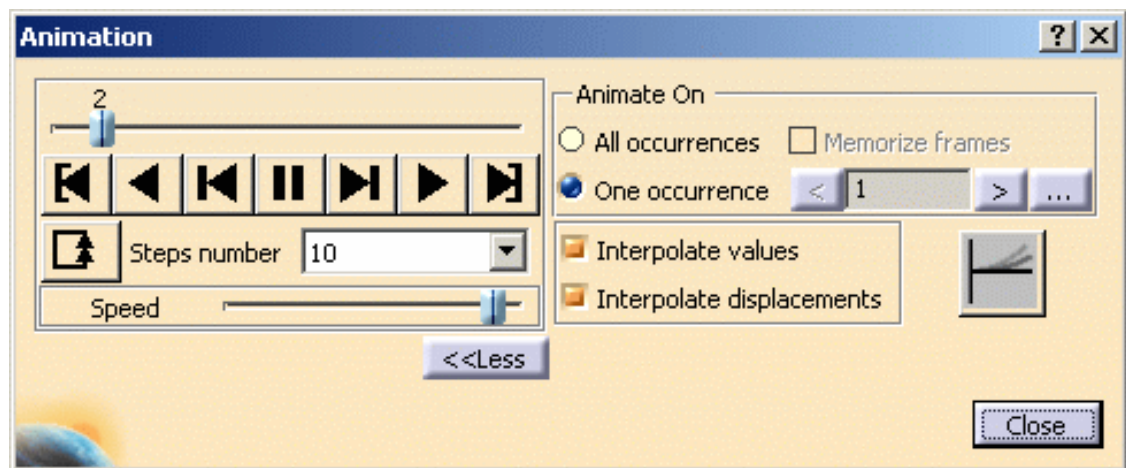

The options available in this part of the dialog box depend on the solution type (mono-occurrence or multi-occurrence).

**Mono-occurrence solutions:**

By default, you can access the following options:



- : use non symmetrical animation (default value).
  - **Interpolate values:** animate the interpolated values of the activated image.
  - **Interpolate displacements:** animate the interpolated displacements of the activated

image.



- : use symmetrical animation.

#### Multi-occurrence solutions:

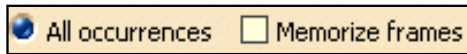

- **All occurrences:** animate all the occurrences of the solution.
  - When activated, this option allows you to choose whether you want to memorize frames:



The frame animation will be speed driven but memory consuming. If you do not activate the **Memorize frames** option, the frame animation will need less memory but will be slower.

- **One occurrence:** animate the selected occurrences of the solution.



- : this button lets you select the previous occurrence.
- : this button lets you select the next occurrence.
- : this button lets you select the desired occurrence using the Frequencies dialog box. When clicking this button, the Frequencies dialog box appears. Multi-selection is not available in the Frequencies dialog box.



- : use non symmetrical animation (default value).
  - **Interpolate values:** animate the interpolated values of the activated image.
  - **Interpolate displacements:** animate the interpolated displacements of the activated image.



- : use symmetrical animation.

2. Click the **Pause** button .



The animation is interrupted.

You access any point of the simulation at random using the slider.

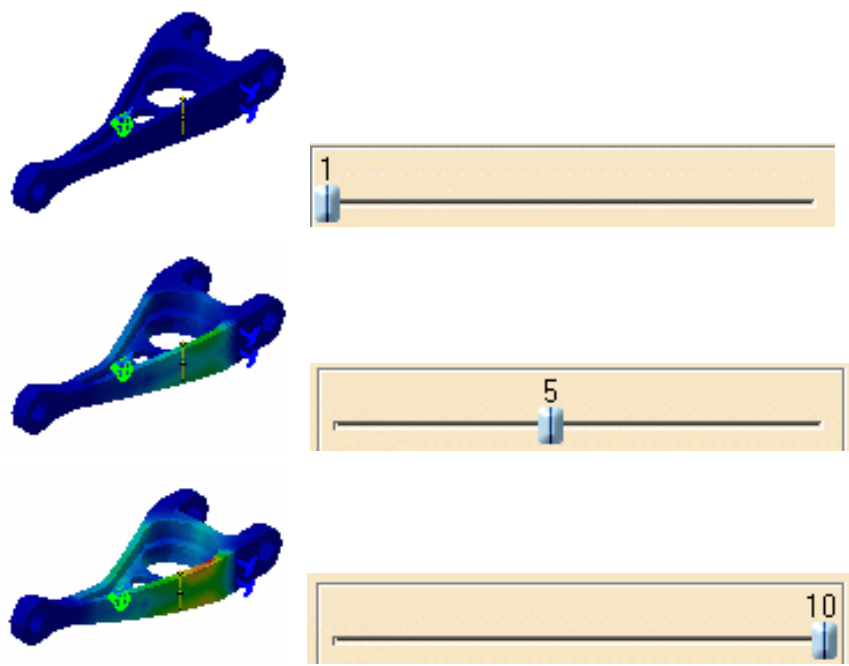

- 3. If needed, modify the **Steps Number** and click the **More** button.

Both the the dialog box and the model appear as shown here:

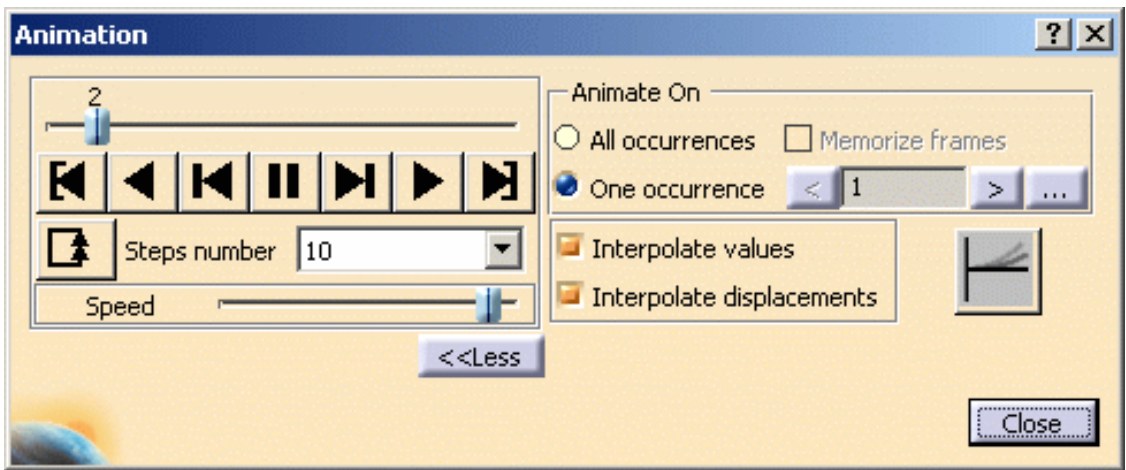

- 4. Click the non symmetrical animation button





Both the dialog box and the model appear as shown here:

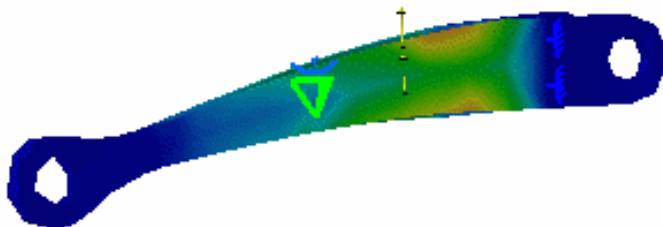
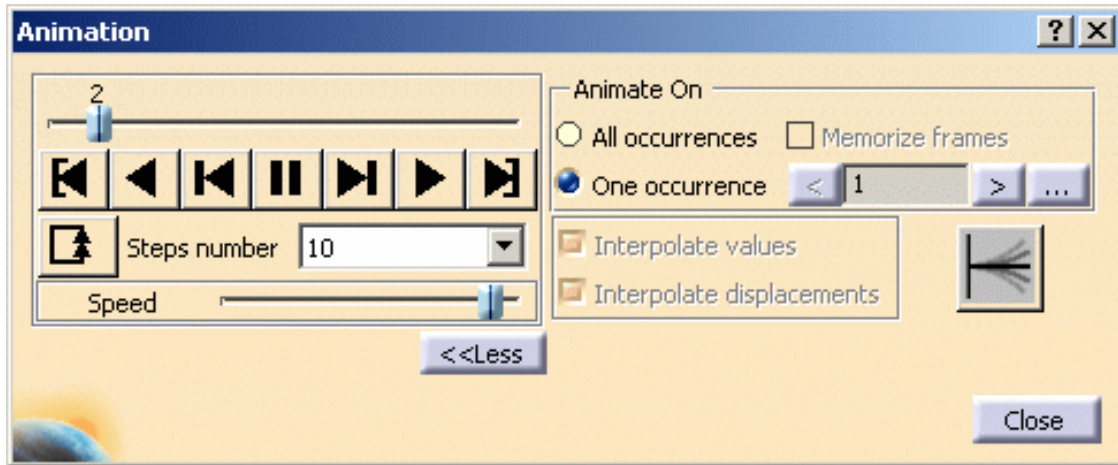

5. Click the **Play Forward** button .

Animation is resumed, with the new settings taken into account.

6. Click **Close** in the Animation dialog box.



- The animation capability is also available for Frequency Solutions.
- You can use the image animation with tiled images using the [Images Layout](#) functionality.



# Cut Plane Analysis



This task shows how to use the Cut Plane Analysis capability.



*Cut Plane Analysis* consists in visualizing results in a plane section through the structure.

By dynamically changing the position and orientation of the cutting plane, you can rapidly analyze the results inside the system.



Open the [sample26.CATAnalysis](#) document from the samples directory.

## Before You Begin:

- Go to **View -> Render Style -> Customize View** and make sure the **Materials** option is active in the Custom View Modes dialog box.
- Compute the solution. For this, click the **Compute** icon .
- Activate the Stress Von Mises image. For this, right click the **Von Mises Stress (nodal value)** feature from the specification tree and select the **Activate/Deactivate** option from the displayed contextual menu.

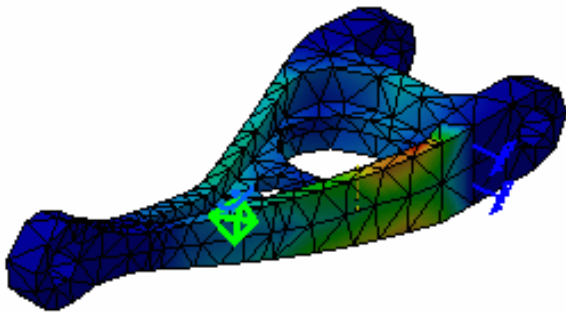

1. Position the compass on the face that will be considered as the reference section.

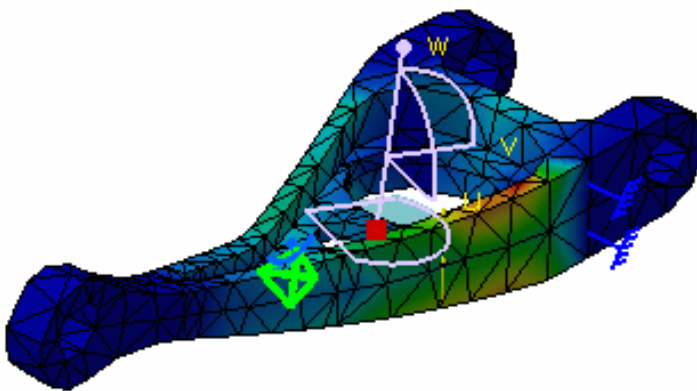

Note that: if you do not position the compass, the compass will be automatically positioned on the part, with a Cutting Plane normal to its privileged direction.

2. Click the **Cut Plane Analysis** icon .

The Cutting Plane appears.

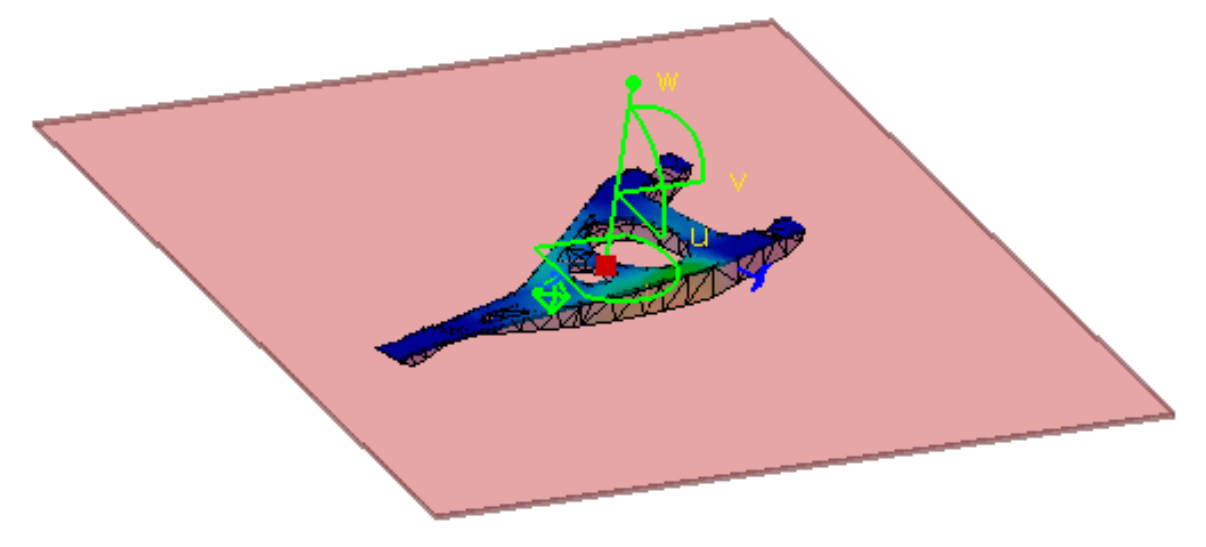

The Cut Plane Analysis dialog box is displayed.

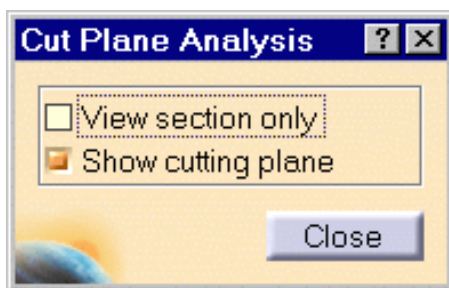

3. Handle the compass using the cursor and rotate or translate the Cutting Plane.
4. Activate the **View section Only** option in the Cut Plane Analysis dialog box to see the section relatively to the position of the cutting plane.

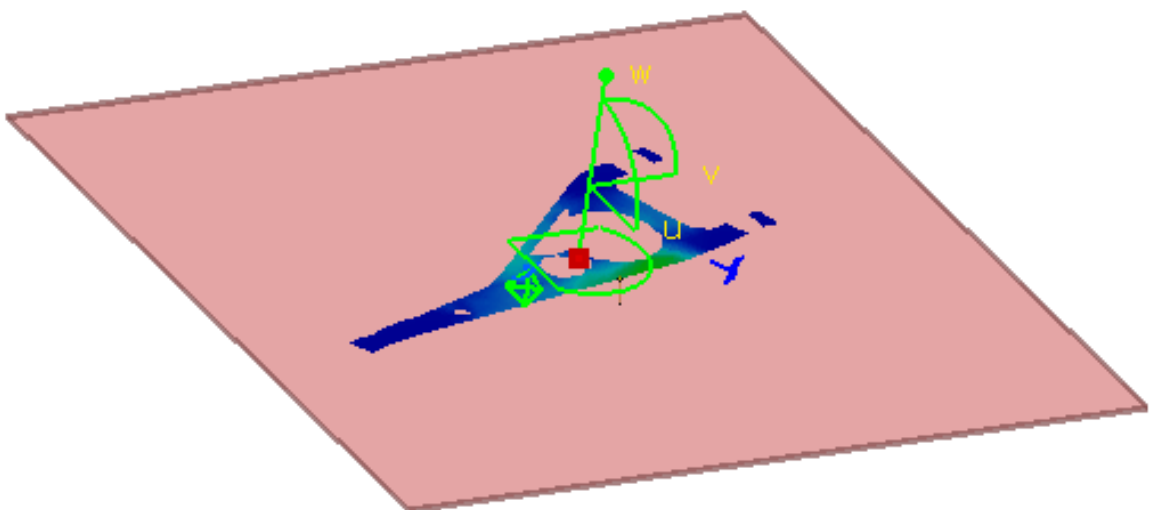

5. De-activate the **Show cutting plane** option in the Cut Plane Analysis dialog box to see only the boundary of this cutting plane.

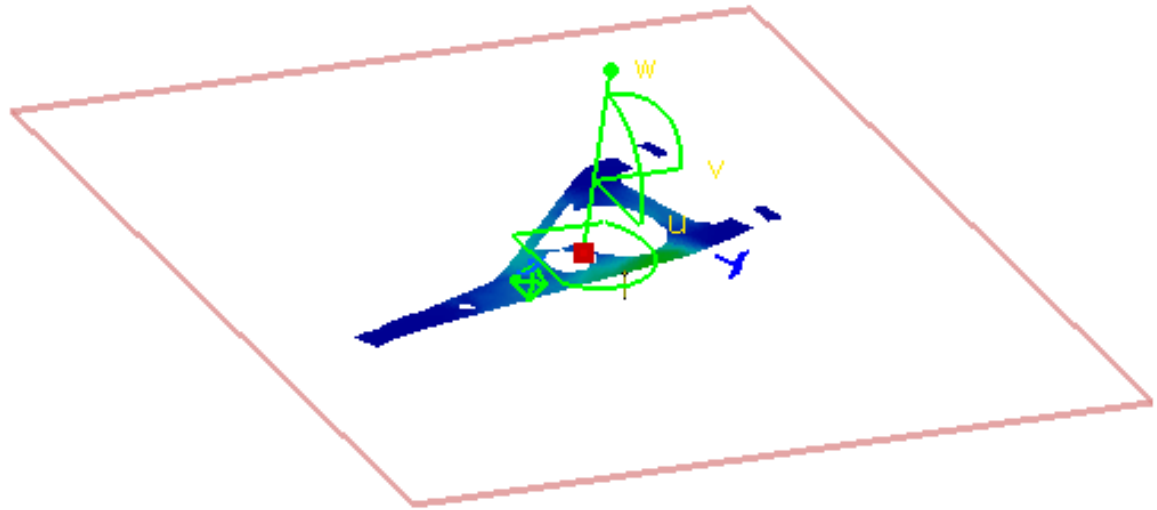

6. Click **Close** in the Cut Plane Analysis dialog box.



- The cut plane capability is also available for Frequency Solutions.
- All the existing images will be cut, if needed.
- You can use the Cut Plane Analysis with tiled images using the [Images Layout](#) functionality.



# Amplification Magnitude



This task shows how to use the Amplification Magnitude functionality.

Amplification Magnitude consists in scaling the maximum displacement amplitude for visualizing a deformed image.



Open the [sample26.CATAnalysis](#) document from the samples directory.

## Before You Begin:

- Go to **View -> Render Style -> Customize View** and make sure the **Materials** option is active in the Custom View Modes dialog box.
- Compute the solution. For this, click the **Compute** icon .
- Activate the Stress Von Mises image.  
For this, right click the **Von Mises Stress (nodal value)** feature from the specification tree and select the **Activate/Deactivate** option from the displayed contextual menu.

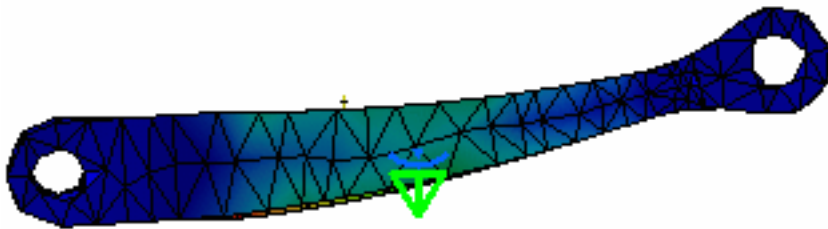

1. Click the **Amplification Magnitude** icon .

The Amplification Magnitude dialog box appears.

- **Scaling factor:** lets you modify the amplification magnitude for deformation visualization using a constant scale factor

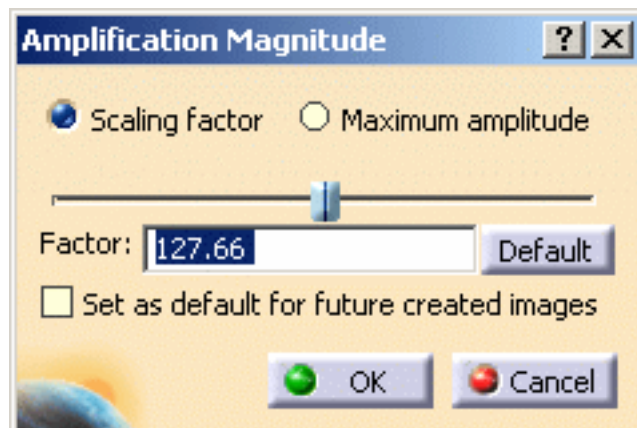

- **Cursor:** lets you dynamically modify the scale factor from **0** to a maximal

value

- **Factor:** lets you specify the scaling factor
- **Default:** lets you return to the default scaling factor
- **Maximum amplitude:** lets you modify the amplification magnitude for deformation visualization using a constant maximum amplitude (artificial)

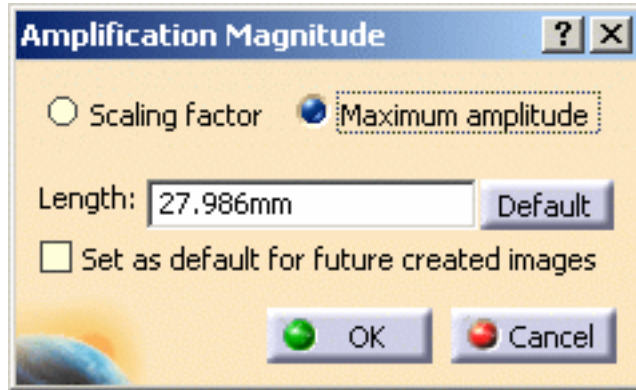

- **Length:** lets you specify the value of the maximum allowed deformation on the image (in **mm**)



The default unit for the **Length** option is fixed in the Options dialog box (**General** -> **Parameters and Measure** -> **Units** tab).

For more details, please refer to the *Infrastructure User's Guide*.

- **Default:** lets you return to the default amplification magnitude
- **Set as default for future created images:** lets you apply the modified amplification magnitude parameter (factor or length) to the future created images

To summarize:

$$\text{maximum amplitude} = \text{real deformation} * \text{scaling factor}$$

To visualize the real deformation, the scaling factor must be equal to **1**.

- 2.** Select the **Scaling factor** option in the Amplification Magnitude dialog box.
- 3.** Enter **300** as **Factor** value and press **Enter**.

As a result, the deformation is increased.

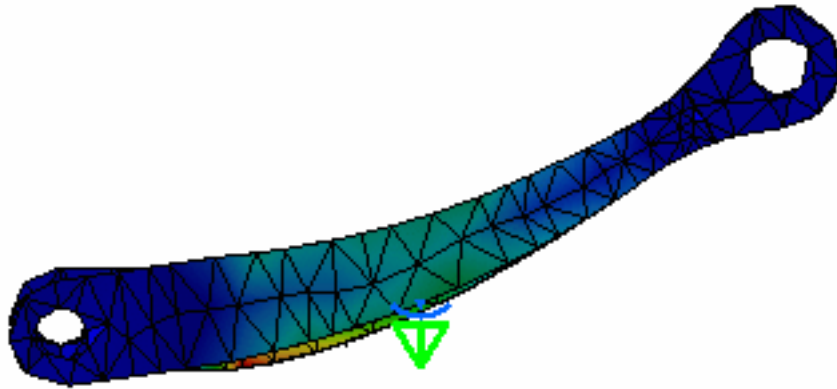

4. Click the **Default** button and then click **OK** in the Amplification Magnitude dialog box.

The image retrieves the default deformation.

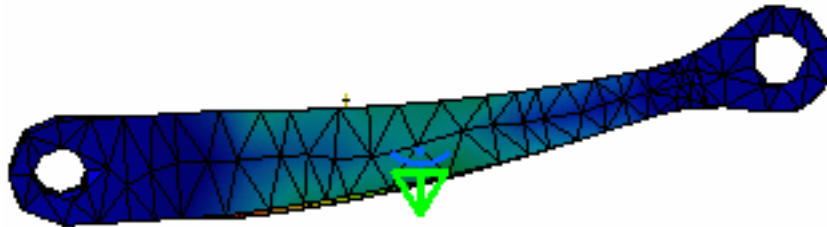

5. Modify the value of the load.

In this particular example:

- double-click the **Distributed Force.1** load in the specification tree
- enter **1000N** as **Z** value
- click **OK** in the Distributed Force dialog box

6. Activate the Von Mises Stress image.

A message informs you that the solution must be updated.

Click **OK** to update the solution.

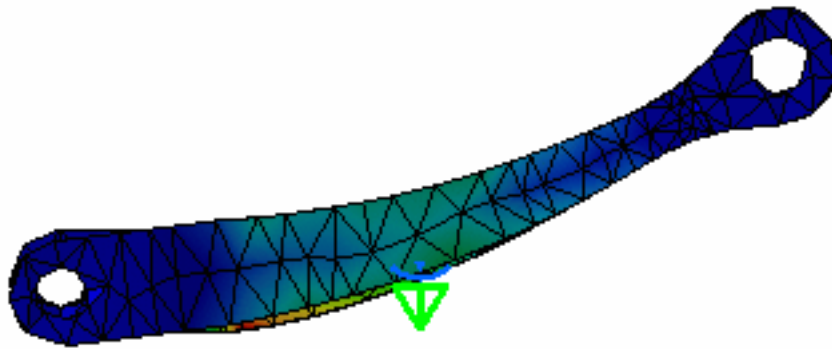

In this case, the real deformation is more important.

So the deformation visualization is more important with a constant scaling factor.

**7.** Click the **Amplification Magnitude** icon.

The Amplification Magnitude dialog box appears.

**8.** Select the **Maximum amplitude** option in the Amplification Magnitude dialog box.

The **Length** value is different:

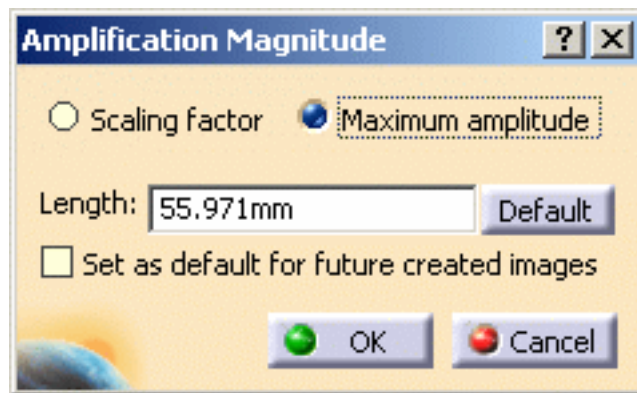

**9.** Click the **Default** button and click **OK** in the Amplification Magnitude dialog box.

The **Length** value is equal to **27.985mm**.

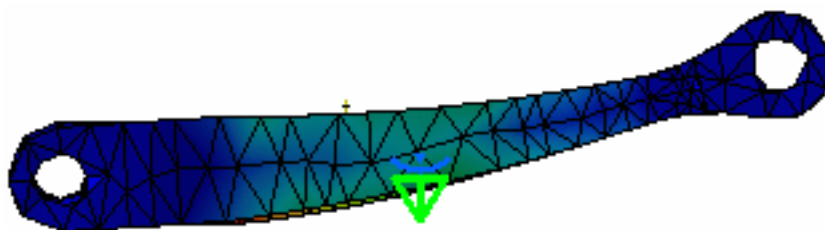



**10.** Modify the load value.

In this particular example:

- double-click the **Distributed Force.1** load in the specification tree
- enter **500N** as **Z** value
- click **OK** in the Distributed Force dialog box

**11.** Activate the Von Mises Stress image.

A message informs you that the solution must be updated.

Click **OK** to update the solution.

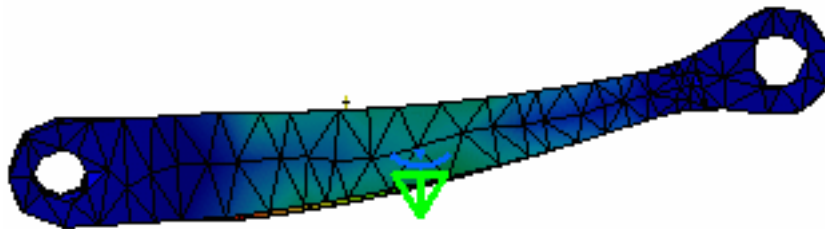

In this case, the real deformation is less important, but the deformation visualization is the same with a constant maximum amplitude.



# Extrema Creation



This task shows how to use the Extrema Creation capability.



*Extrema Creation* consists in localizing points where a results field is maximum or minimum. You can ask the program to detect either one or both global extrema and an arbitrary number of local extrema for your field.



Open the [sample26.CATAnalysis](#) document from the samples directory.

## Before You Begin:

- Go to **View -> Render Style -> Customize View** and make sure the **Materials** option is active in the Custom View Modes dialog box.
- Compute the solution. For this, click the **Compute** icon .
- Activate the Stress Von Mises image. For this, right click the **Von Mises Stress (nodal value)** feature from the specification tree and select the **Activate/Deactivate** option from the displayed contextual menu.

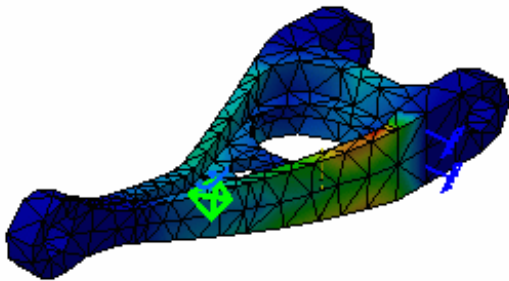

1. Click the **Image Extrema** icon .

The Extrema Creation dialog box appears.

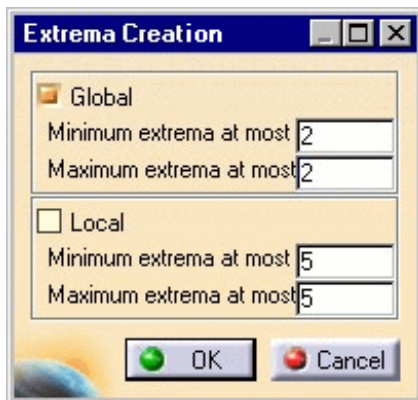

You can ask the program to detect given numbers of global (on the whole part) and/or local (relatively to neighbor mesh elements) extrema at most, by setting the **Global** and **Local** switches.

- If you activate the **Global** option, you will launch the detection of the minimum and maximum global extrema. Global means that the system will detect all the entities which have a value equal to the Minimum or Maximum value.
- If you activate the **Local** option, you will launch the detection of the minimum and maximum local extrema. Local means that the system will search all the entities which are related to the Minimum or Maximum value compared to the two-leveled neighboring entities.

For more details about local extrema computation, please refer to [Post-Processing and Visualization](#) in the Frequently

Asked Questions section.

2. Enter the desired parameters in the Extrema Creation dialog box.
3. Click **OK** in the Extrema Creation dialog box.

A new image corresponding to the default settings is displayed, with two arrow boxes locating the points of absolute extremum for the current field and containing information about the detected value.



The **Extrema** object set containing the two Global Extrema appears under the current Image object in the specification tree.

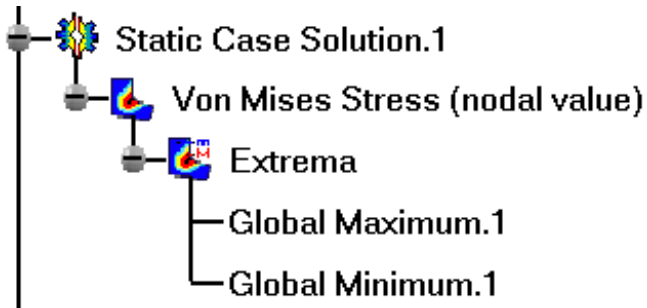

4. Double click the **Extrema** object set in the specification tree.

The Extrema Edition dialog box appears.

You can modify the objects set by setting the **Global** and **Local** switches.

5. Deactivate the **Global** option and activate the **Local** option.

The boxes locating the global extrema disappear, and symbols locating the local extrema are visualized.

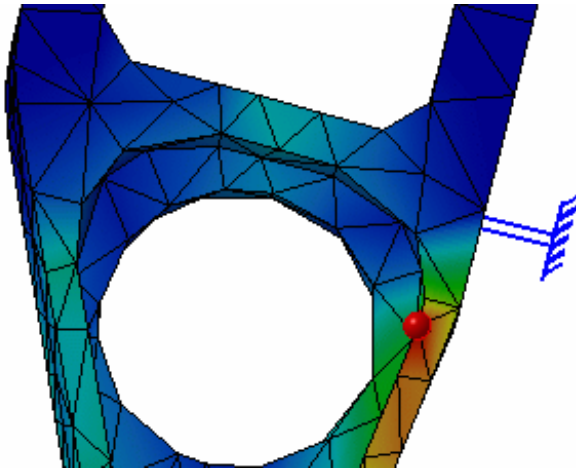

The **Extrema** objects set in the specification tree now contains, in addition to the two **Global Extrema** objects, as many **Local Extremum** (Maximum or Minimum) objects as you have required.

6. Double-click one of the **Local Extremum** objects in the specification tree.

The Extremum Edition dialog box appears.

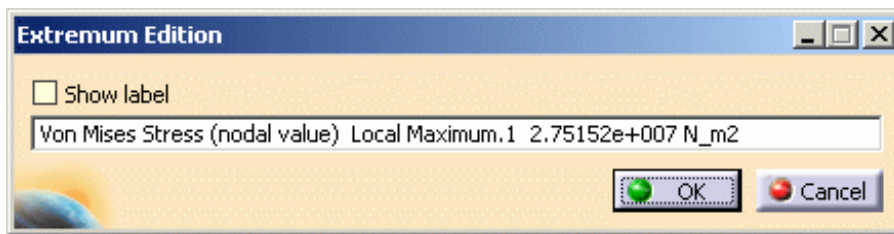

7. Select the **Show Label** option and click **OK** in the Extremum Edition dialog box.

A new arrow box is visualized, locating the position of the corresponding point and containing information about the detected value.

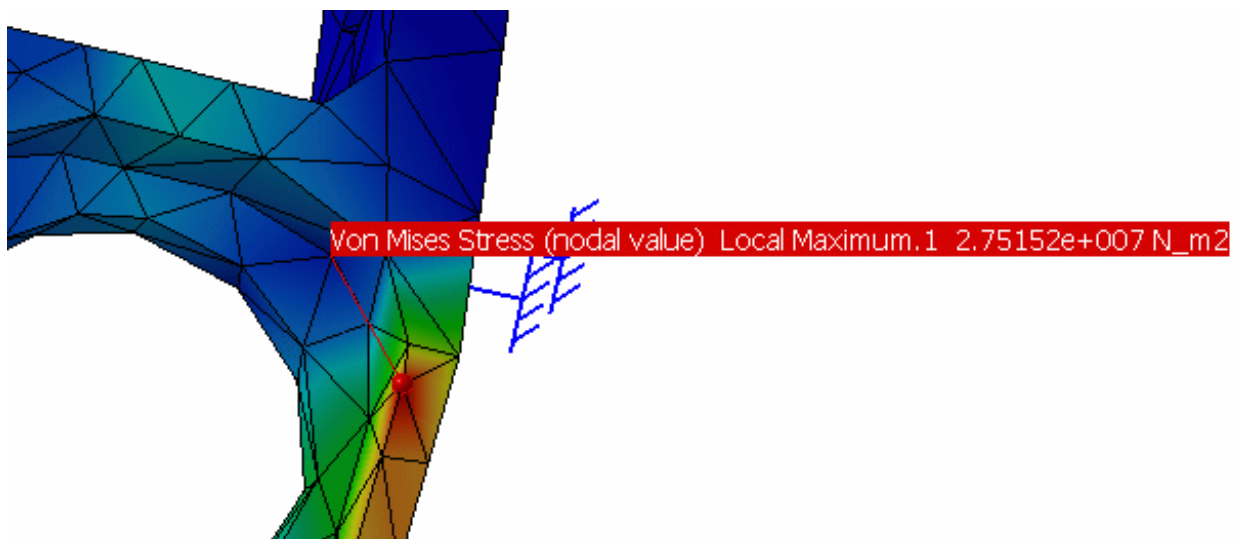

The extrema detection capability is also available for images obtained under Frequency and Buckling Solutions.



# Editing the Color Palette



This task shows how to **edit** and **lock** the Color Palette on a Von Mises Stress display.



The Von Mises Stresses, the Displacements, the Precision, the Principal Stress distributions are employed along with a Color Palette. Editing the palette enables you to emphasize on particular values spread on the parts.



Open the [sample26.CATAnalysis](#) document from the samples directory.

## Before You Begin:

- Go to **View -> Render Style -> Customize View** and make sure the **Edges points** option is not active and the **Materials** option is active in the Custom View Modes dialog box.
- Compute the solution. For this, click the **Compute** icon .
- Activate the Stress Von Mises image. For this, right click the **Von Mises Stress (nodal value)** feature from the specification tree and select the **Activate/Deactivate** option from the displayed contextual menu.

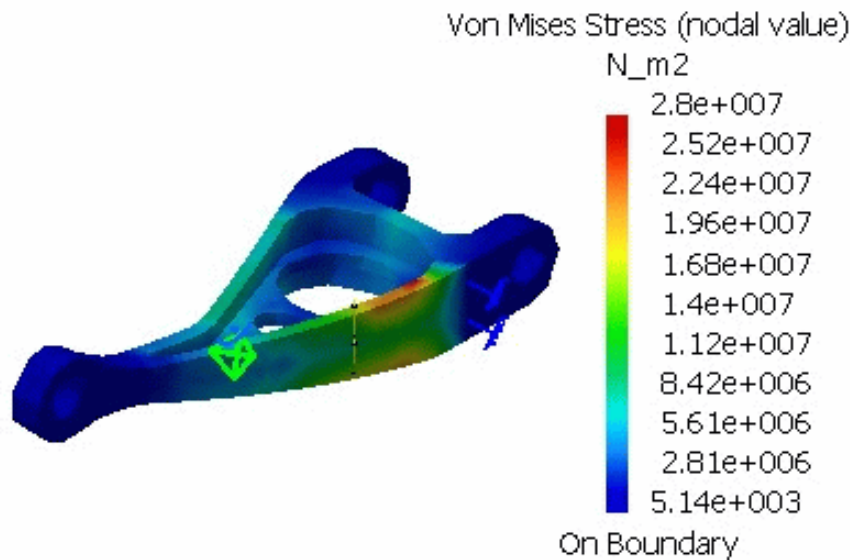

1. Double click on the color palette to edit it.  
The Color Map Edition dialog box appears.

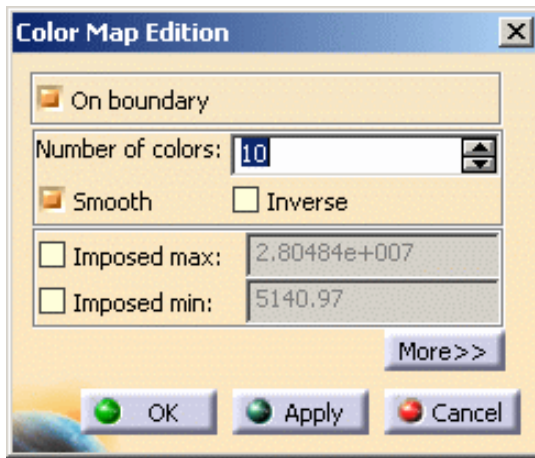

- **On boundary:** lets you choose to compute the colors according to the boundary or the overall model.
- **Number of colors:** lets you modify the number of colors.
- **Smooth:** lets you smooth the colors.
- **Inverse:** lets you inverse the colors order.
- **Imposed max:** lets you impose a maximal value.
- **Imposed min:** lets you impose a minimal value.
- **More/Less buttons:** lets you enlarge/reduce the Color Map Edition dialog box.



The **More/Less** buttons are only available if you installed the **ELFINI Structural Analysis** product.

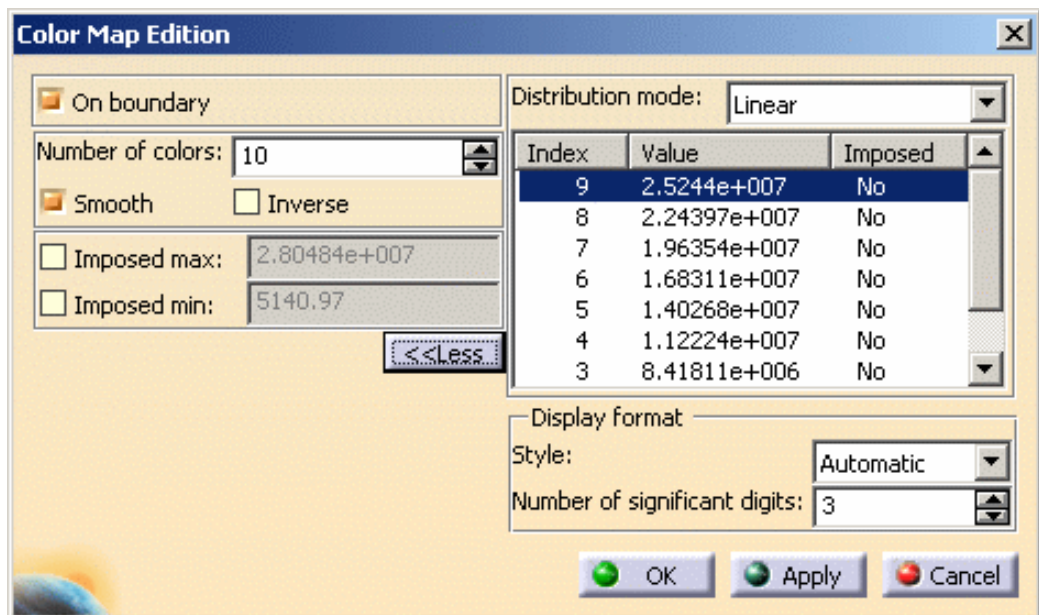

- **Distribution mode:**
  - **Linear:** regular values distribution between the minimum value (computed or imposed) and the maximum value (computed or imposed).
  - **Histogram:** values distribution so that each interval contains the same number of entities.
    - ⚠ Only available if the **Imposed max** and **Imposed min** options are deactivated.
  - **Logarithmic:** logarithmic values distribution between the minimum value (computed or imposed) and the maximum value (computed or imposed).
    - ⚠ Only available if the minimum value (computed or imposed) is strictly positive.
- **Distribution edition:** it is possible to edit the distribution using contextual menus.

You can as well impose a particular value for a threshold in order not to modify it when setting other values. (impose)

After each new value entered for a threshold, the list is computed to take into account the potential interactions between this threshold and the two other thresholds which flank it. If an interaction is detected, the former values are distributed taking into account if possible the imposed values. (edit)

- **Display Format:**
  - **Style: Scientific, Decimal and Automatic**
  - **Number of significant digits**

2. Modify the desired parameters.
3. Right-click the first value of the distribution.

Index	Value	Imposed
9	2.5244e+007	No
8	2.24397e+007	No
7	1.96354e+007	No
6	1.68311e+007	No
5	1.40268e+007	No
4	1.12224e+007	No
3	8.41811e+006	No

4. Select the **Impose** contextual menu.

As a result, the **Imposed** value is **Yes** as shown bellow:

Index	Value	Imposed
9	2.5244e+007	Yes
8	2.24397e+007	No
7	1.96354e+007	No
6	1.68311e+007	No
5	1.40268e+007	No
4	1.12224e+007	No
3	8.41811e+006	No

5. Right-click the first value of the distribution.

Index	Value	Imposed
9	2.5244e+007	Yes
8	2.24397e+007	No
7	1.96354e+007	No
6	1.68311e+007	No
5	1.40268e+007	No
4	1.12224e+007	No
3	8.41811e+006	No

6. Select the **Release** contextual menu.

As a result, the **Imposed** value is **No** as shown below:

Index	Value	Imposed
9	2.5244e+007	No
8	2.24397e+007	No
7	1.96354e+007	No
6	1.68311e+007	No
5	1.40268e+007	No
4	1.12224e+007	No
3	8.41811e+006	No

7. Right-click the first value of the distribution.
8. Select the **Edit...** contextual menu.

The Edit Value dialog box appears.

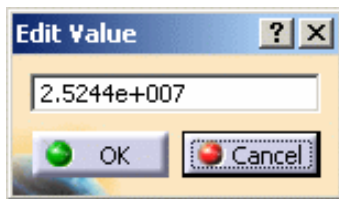

In this particular example, enter **2.6e+007** and click **OK** in the Edit Value dialog box. As a result, the value you have just edited is automatically imposed as shown below:

Index	Value	Imposed
9	2.6e+007	Yes
8	2.24397e+007	No
7	1.96354e+007	No
6	1.68311e+007	No
5	1.40268e+007	No
4	1.12224e+007	No
3	8.41811e+006	No

9. Click on **Apply** to check if the palette fits. If yes, click on **OK**.

The palette dialog box disappears and the modifications will be valid only for this display.

Von Mises Stress (nodal value)

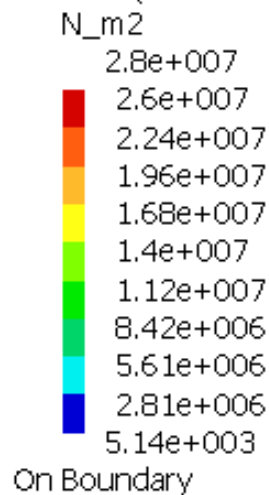



You can move the Palette in the viewer.

10. Select the Palette and move it with the middle mouse button to the desired place.

When the Palette is selected, the part viewer is deactivated and the part is shaded.

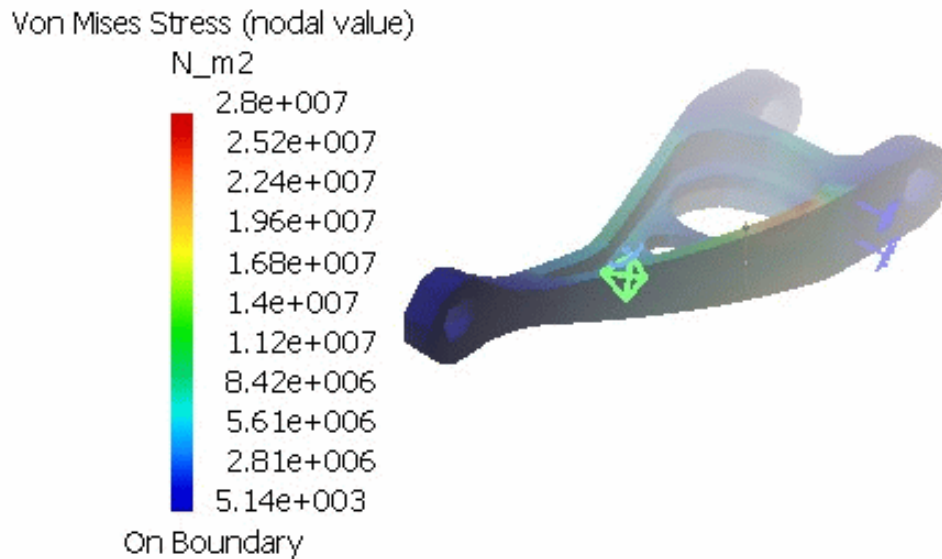

11. Click again on the Palette to fix it there.



You can lock the palette (global maxima and minima).

This functionality is only available if you installed the **ELFINI Structural Analysis** product.

At any time, you can lock / unlock the Color Palette.

When a palette is locked, the color values are not updated anymore whatever the modifications you perform on the image (using the **Selections** tab of the Image Edition dialog box).

It is an alternative to the **Imposed min** and **Imposed max** options and an easy way to set the palette scale being independent of what is visualized.

For example, when dealing with an assembly, and if you select one part in the assembly, the palette is automatically updated and all the colors are now defined in accordance with the selected color.



You can use the [Analysis2\\_Lock01.CATAnalysis](#) document from the samples directory.



1. Select the part of which you want to lock the color, right-click the color palette and select the **Lock** contextual menu.
2. Double-click an image of one part in the assembly.

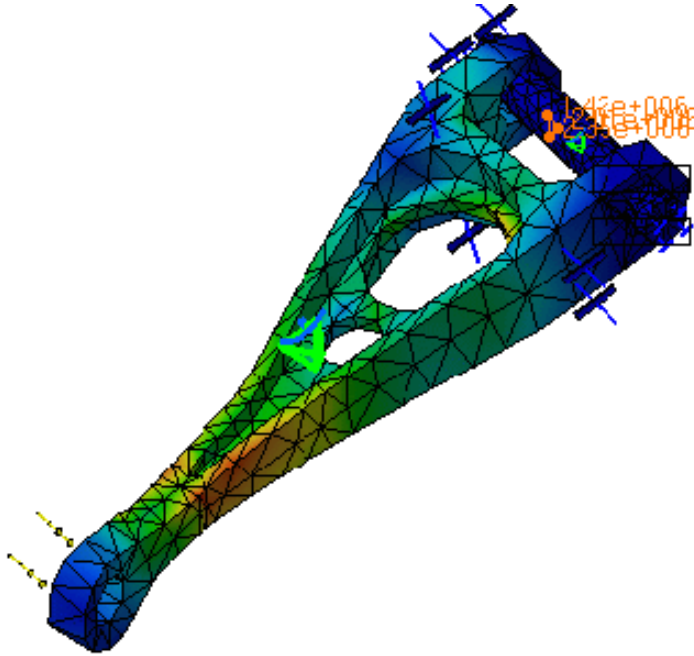

The Palette is as follows:

Von Mises Stress (nodal value)

N\_m2

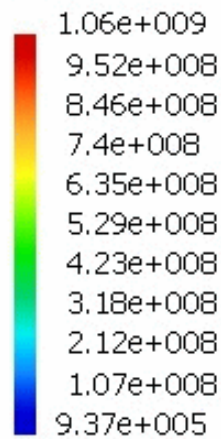

On Boundary

3. Select the desired part (in the Image Edition dialog box (Selections tab), right-click the color palette and select the **Lock** Option from the contextual menu.

The selected color in the selected part now becomes some kind of a reference color.

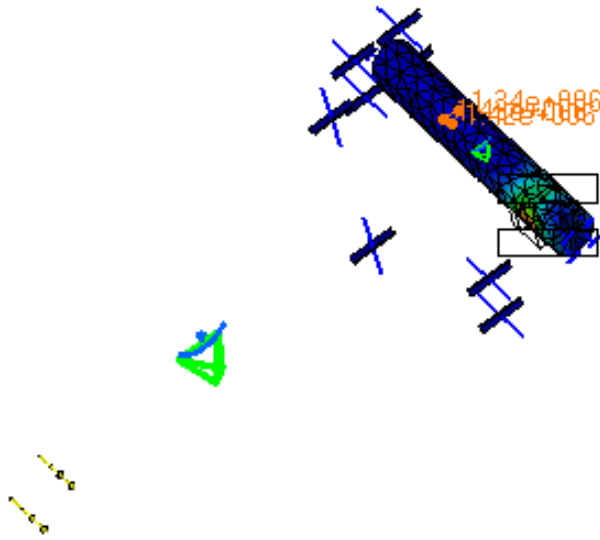

The Palette is as follows (local maxima and minima now appear):

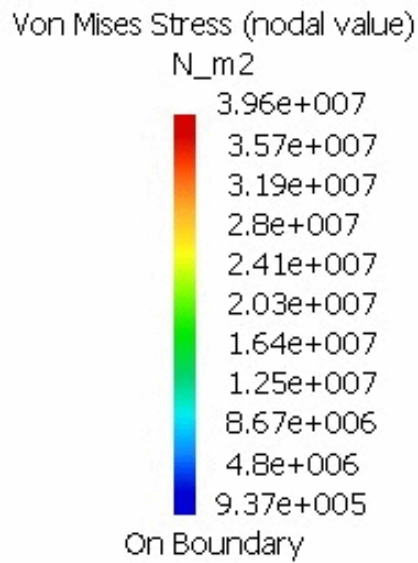

4. Select the **All** product in the Image Edition dialog box (Selections tab).

The colors of the whole product are modified according to the reference color. This color becomes the reference color for the whole product. As a result all the other colors are set accordingly.

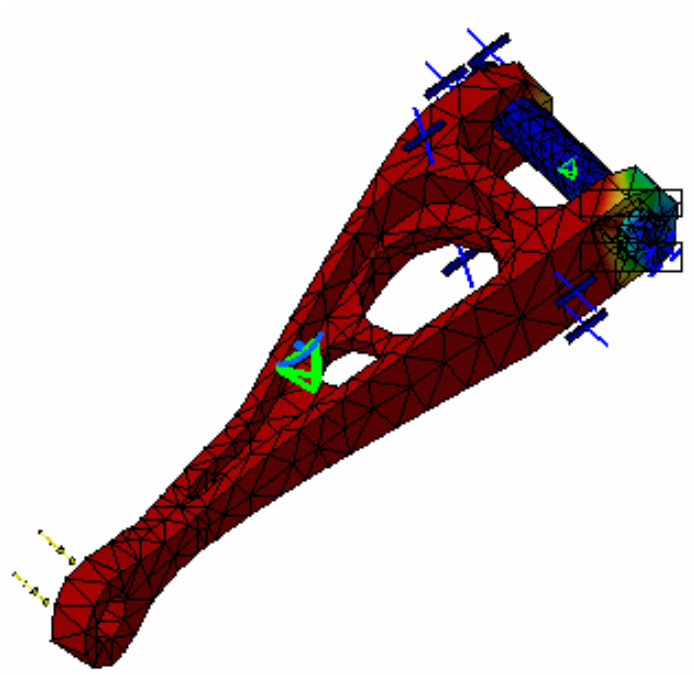

The Palette is as follows (local maxima and minima are kept even though you are now using global maxima and minima):

Von Mises Stress (nodal value)

Locked

N\_m2

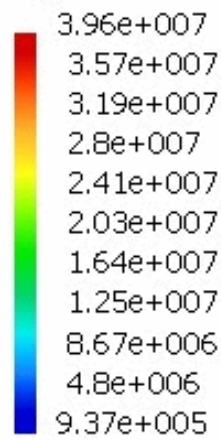

On Boundary



# Information



This task shows how to get information on one or more images and extrema you generated.



Open the [sample15.CATAnalysis](#) document from the samples directory for this task.

## Before You Begin:

- Compute the solution. For this, click the **Compute** icon .
- Right-click on the **Static case solution** feature in the specification tree and select the **Generate image** option from the displayed contextual menu. Then select the **Stress full tensor component (nodal values)** image from the Image choice dialog box.

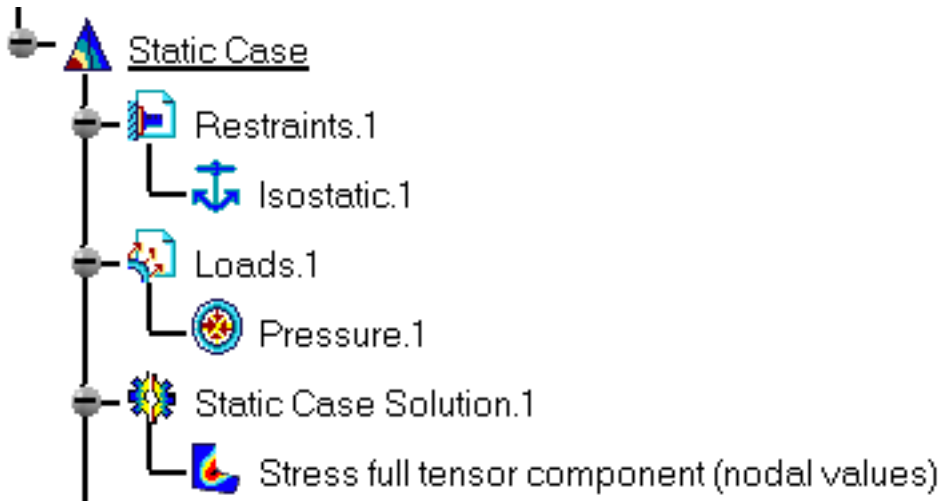

1. Click the **Information** icon .
2. Select the **Stress full tensor component (nodal values)** image from the specification tree.



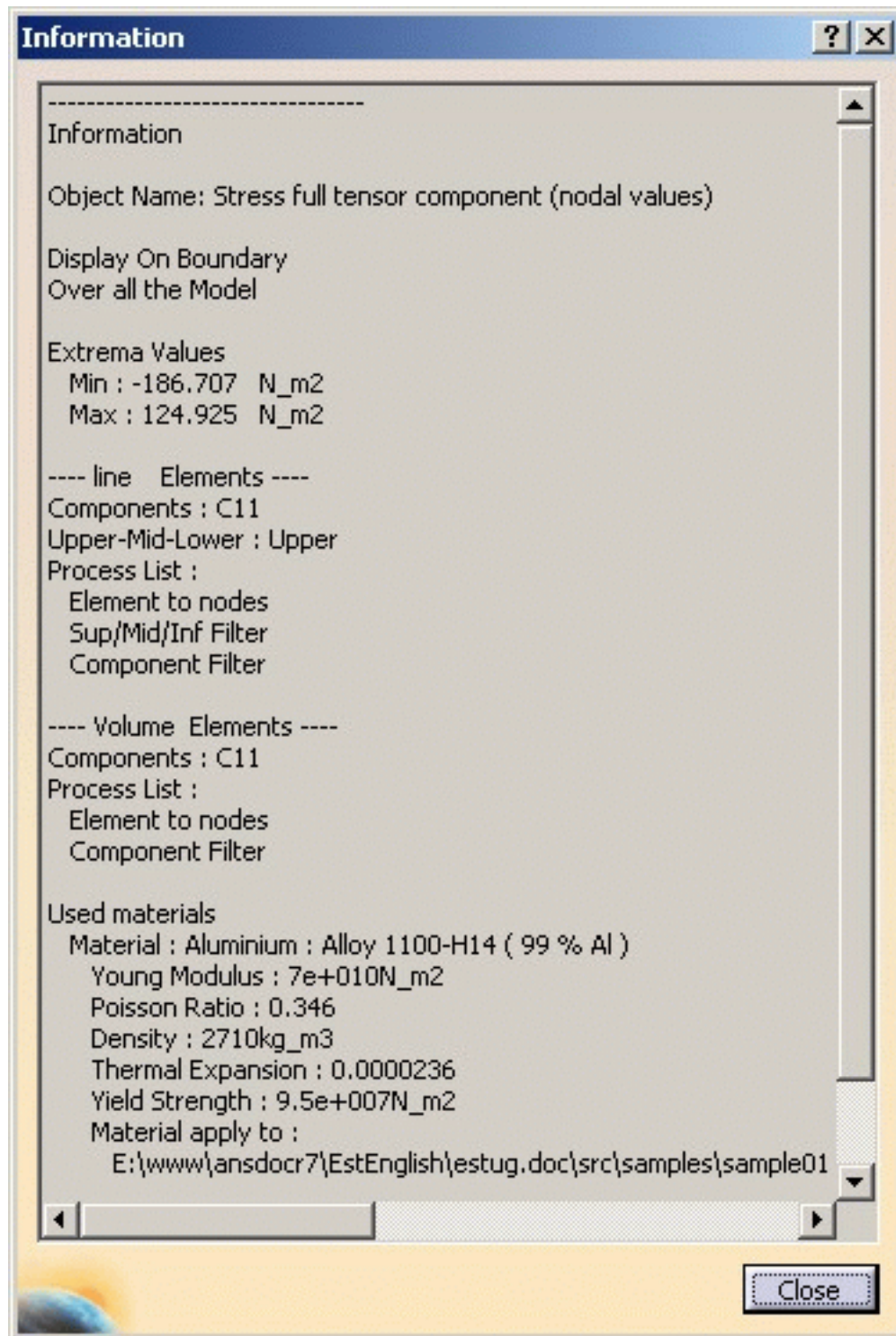









The Information dialog box now appears with information on the selected image.









Note that you can add more information on another generated image by selecting this image from the specification tree. The information on this secondly selected image will appear in the box following the information on the image first selected.



The information displayed in the Information dialog box depends on the type of the image selected:

Type of Information	Type of Image		
	Deformed Mesh	Estimated Local Error	Any Other Type of Image
<b>Object Name</b>			
<b>Display</b> (On Boundary or all elements ; Over Local Selections or all the Model)			
<b>Mesh Statistics</b> (nodes and elements)			
<b>Extrema Values</b> (Min and Max)			
<b>Surface elements vs Volume elements</b>			
<b>Process List</b> (component, name, position)			

<b>Used Materials (and Yield Strength)</b>			
<b>Precision Location</b>			
<b>Estimated Precision</b>			
<b>Strain Energy</b>			
<b>Global Estimated Error Rate</b>			



For Frequency cases or Buckling cases, in addition, you are informed on the Mode Number and Mode Value.

3. You can also get information on an extremum (global or local).

For this, select an extremum in the specification tree and click the **Information** icon



The Information dialog box appears and gives you information on the selected extremum.

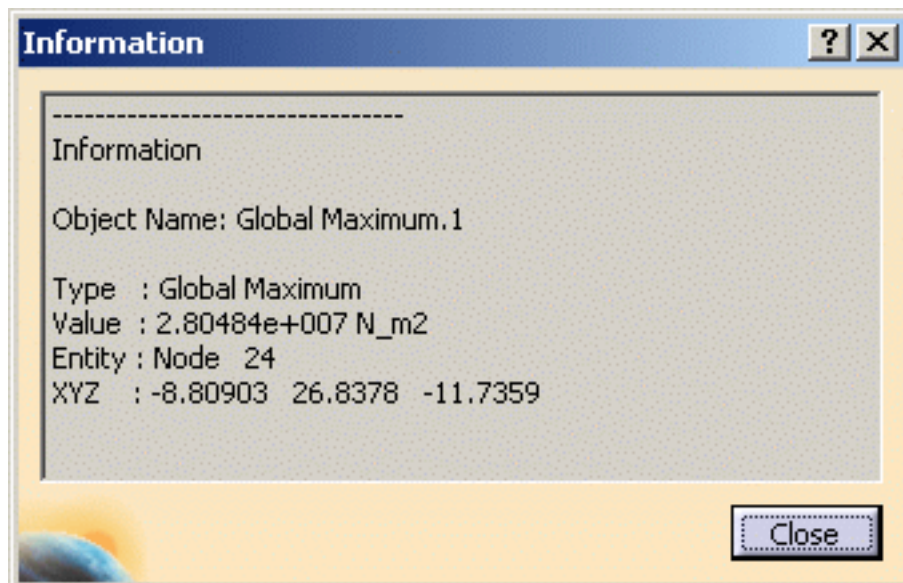

To know more about extrema, please refer to [Extrema Creation](#) in this guide.



# Images Layout



This task shows how to tile layout images.

Generated images corresponding to analysis results are superimposed into one image that cannot be properly visualized. You can tile these superimposed images into as many layout images on the 3D view.



Only available with the **ELFINI Structural Analysis (EST)** product.



Open the [sample13.CATAnalysis](#) document from the samples directory for this task.

## Before You Begin:

- Go to **View -> Render Style -> Customize View** and make sure the **Shading, Outline** and **Materials** options are active in the Custom View Modes dialog box.
- Compute the static solution.
- Activate at least two images.

For this, right-click, one after the other, the **Von Mises Stress** and then the **Deformed Mesh** images in the specification tree and select the **Activate/Deactivate** contextual menu.



1. Click the **Images Layout** icon .



The Images Layout dialog box appears.

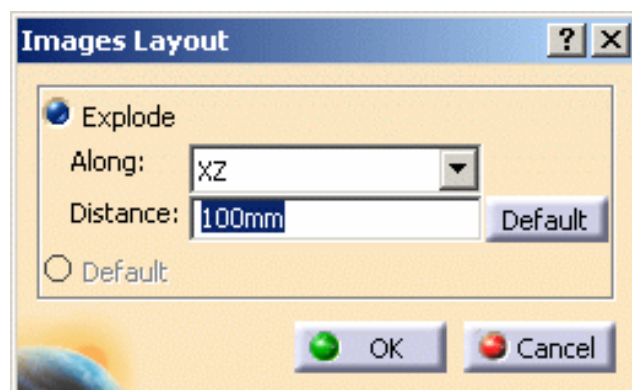

- **Explode:**

- **Along:** lets you specify the axis (**X**, **Y** or **Z** axis) or the plane (**XY**, **XZ** or **YZ** plane) along which you want to explode the image visualizations.
- **Distance:** lets you specify the distance between two images. The **Default** button lets you retrieve an optimum **Distance** value.
- **Default:** lets you retrieve the default superimposed visualization.



The **Default** option is only available if you have already exploded the image visualization.

2. Select the **X** axis option and enter **200mm** as **Distance** value.
3. Click **OK** in the Images Layout dialog box.

The image visualization are tiled along the **X** axis.



4. Click the **Images Layout** icon and select the **Default** option in the dialog box as shown below:

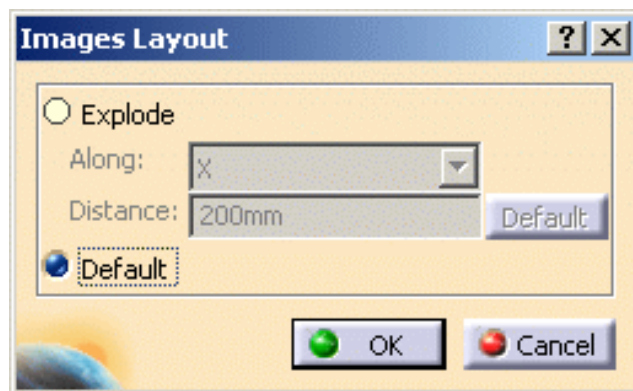

5. Click **OK** in the Images Layout dialog box.
6. Activate the **Translational displacement vector** image.
7. Click the **Images Layout** icon  and select the **Explode** option.
8. Select **XZ** as **Along** option, enter **100mm** as **Distance** value and click **OK** in the Images Layout dialog box.

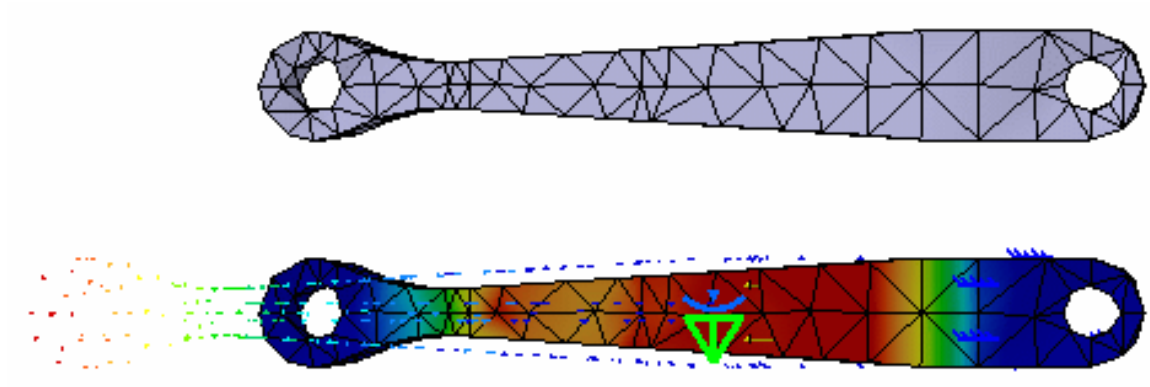

- You can [animate](#) one or more of these images, if desired.
- Be careful: the [cutting plane](#) will cut all the images.



# Simplifying Representation



This task shows how to display a simplified representation while moving an image.



Only available with the **ELFINI Structural Analysis (EST)** product.



- An image must have been created.
- The image must be activated.



Open the [sample26.CATAnalysis](#) document from the samples directory.

## Before You Begin:

- Go to **View -> Render Style -> Customize View** and make sure the **Edges, Shading, Outline and Materials** options are active in the Custom View Modes dialog box.
- Compute the solution.



For this, click the **Compute** icon.

- Activate an image.  
In this particular example, right-click the **Von Mises Stress (nodal value)** image in the specification tree and select the **Activate/Deactivate** contextual menu.



1. Click the **Simplified Representation** icon .

2. Select an image in the specification tree.

In this particular example, select the **Von Mises Stress (nodal value)** image in the specification tree.

The Simplified Representation dialog box appears.

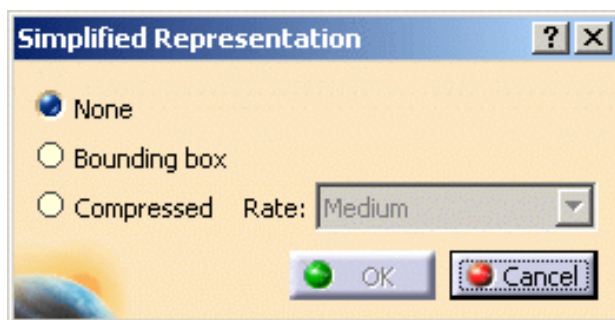

- **None**: no simplified representation
- **Bounding box**: displays the image bounding box while moving
- **Compressed**: reduces the number of graphical entities of the representation. The Rate list lets you choose the desired degree of reduction (**Low, Medium, High**).



- The **Compressed** option is not available in the following cases:
  - **Text** image type
  - **Symbol** image type
  - the **Shrink** coefficient is not equal to **1.00** (for more details, please refer to the **Visualization Options** dialog box)
  - the **Display element without value** is activated (for more details, please refer to the **Visualization Options** dialog box)
- This option could require significant computation time, so the Compressed Representation status bar appears to inform you about the progress of compression:

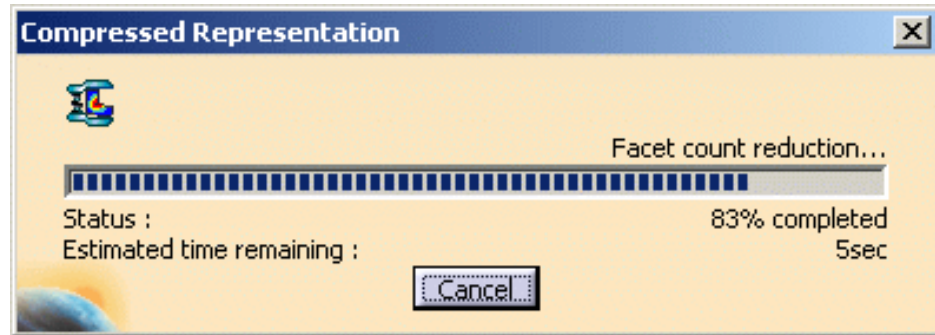

At any time, you can click the **Cancel** button to stop the compression process.

3. Select the **Bounding Box** option.
4. Click **OK** in the Simplified Representation dialog box.
5. Zoom, pan or rotate the image.

The bounding box representation appears as shown bellow:

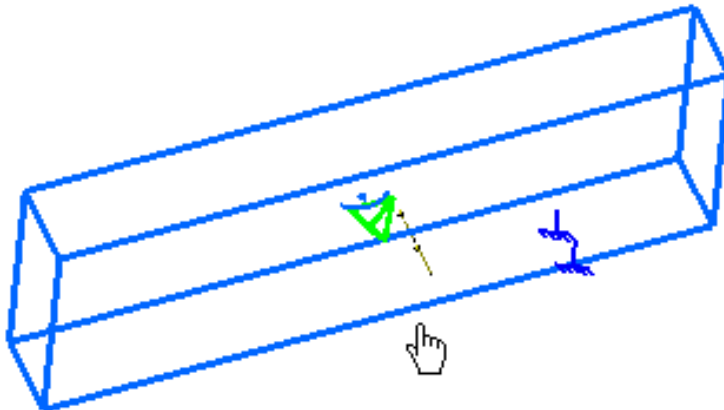

As soon as you release the mouse buttons, the bounding box representation is hidden.

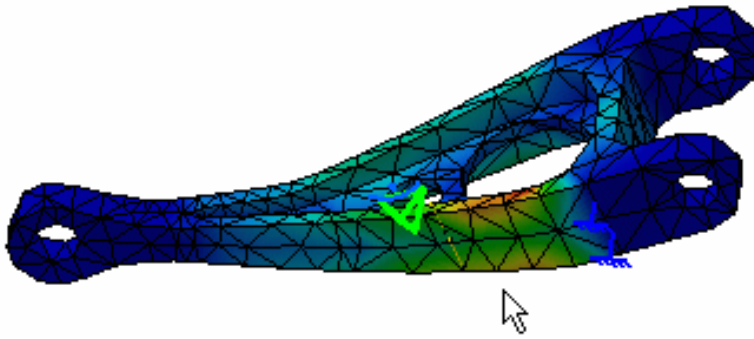

The current simplified representation is lost if you:

- edit the image,
- activate/deactivate the image,
- close the CATAnalysis file even if you saved it.



## Restrictions

- a. Some visualization elements are not taken into account by the **Compressed** representation mode
  - nodes (visualized using the **Display nodes** option)
  - small elements (visualized using the **Display small elements** option)
- b. Images with isolines:

Here you can find an example of isolines:

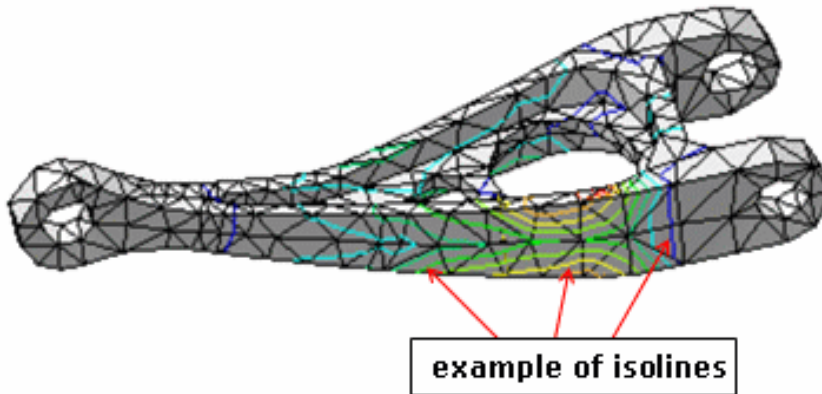

The isolines are visible if you deactivate the **Material** option in the Custom View Modes dialog box (**View -> Render Style -> Customize View** menu).

In this case, the isolines are not taken into account by the **Compressed** representation mode.

- c. The **Compressed** representation is not displayed while moving in the following cases:
  - the **Triangles** option is activated in the Custom View Modes dialog box (**View -> Render Style -> Customize View** menu).
  - the **Shading** option is deactivated in the Custom View Modes dialog box (**View -> Render Style -> Customize View** menu) when visualizing a **fringe** image type.



# Generating Images



This task shows how to generate images in addition to those of the **Image** toolbar using a contextual menu from the following sets:

- Analysis Case Solution
- Nodes and Elements
- Loads
- Masses
- Restraints
- Properties



Only available with the **ELFINI Structural Analysis (EST)** product.



Open the [sample00.CATAnalysis](#) document from the samples directory for this task.

## Before You Begin:

Compute the solution. For this, click the **Compute** icon .



1. Right-click the desired set in the specification tree and select the **Generate Image** contextual menu .

In this particular example, select the **Static Case Solution.1** set in the specification tree.

The Image Generation dialog box appears.

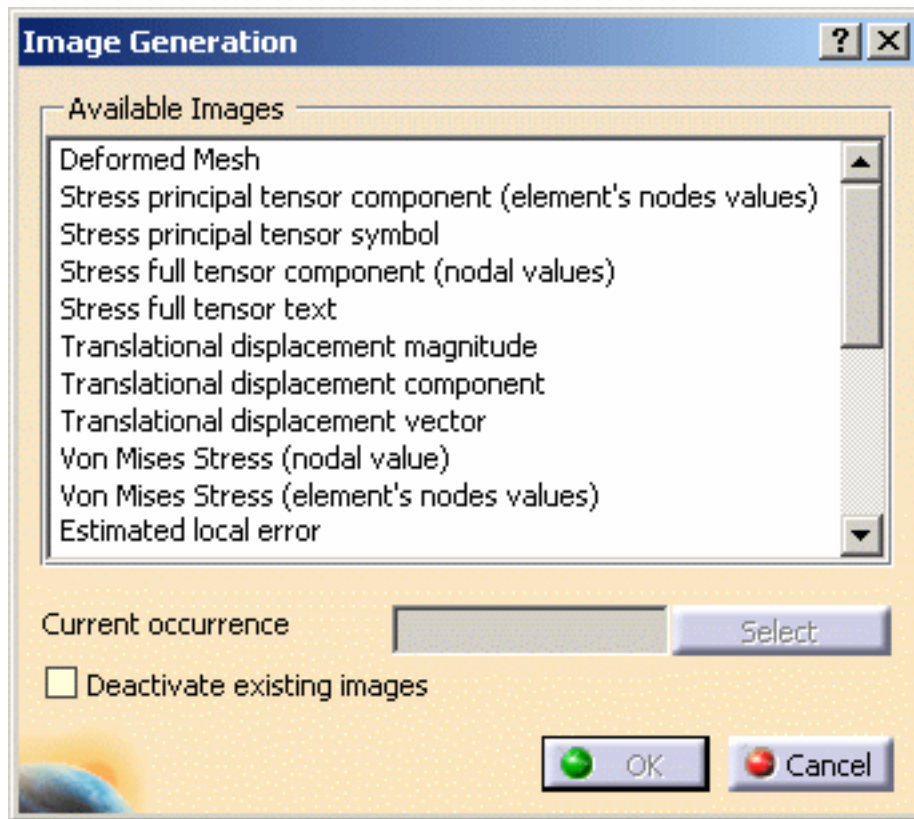

- **Available Images:** lists all the available images you can generate.



You will find below the list of the available images according to the set from which they have been generated:

- [Analysis Solution](#)
- [Nodes and Elements](#)
- [Loads](#)
- [Masses](#)
- [Restraints](#)
- [Properties](#)

- **Current occurrence:** lets you select the current occurrence you want to visualize.



This option is only available for the multi-occurrence analysis solutions.

- **Deactivate existing images:** lets you deactivate the display of all the images you have previously generated.

**2.** Select the type of the image you want to generate in the **Available Images** list.

**3.** Select the desired **Current occurrence**.





This option is only available for the multi-occurrence analysis solutions.

For this, click the **Select** button.

The Frequencies dialog box appears.

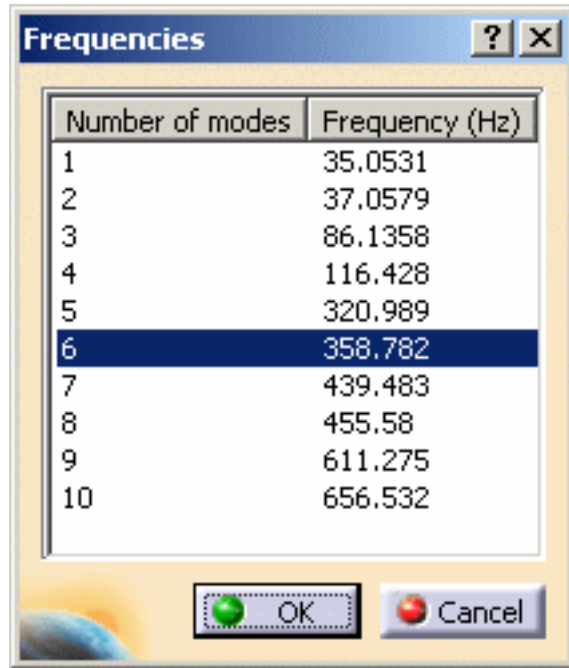

4. If desired, select the **Deactivate existing images** option.

5. Click **OK** in the Image Generation dialog box.

The image is automatically generated. The feature of the newly generated image appears in the specification tree under the selected set.



For the Frequency Case, the mode shapes are arbitrarily normalized displacements. In this case, the images of stress and energy results give only tendencies related to these mode shapes.

## Analysis Solutions

Image Names	Meaning	Case Solution Type
<b>Deformed Mesh</b>	Deformed mesh	Static Case Frequency Case Free Frequency Case Buckling Case Combined Case Static Constrained Mode Harmonic Dynamic Response Case Transient Dynamic Response Case
<b>Stress principal tensor component (element's nodes values)</b>	Stress principal tensor. Discontinuous iso-value image of one algebraic component. The first component is displayed by default. This component can be changed through the <b>Filter</b> option (Image Editor dialog box).	Static Case Frequency Case Free Frequency Case Combined Case Static Constrained Mode Harmonic Dynamic Response Case Transient Dynamic Response Case
<b>Stress principal tensor symbol</b>	Stress principal tensor. Symbols of tensor algebraic values.	Static Case Frequency Case Free Frequency Case Combined Case Static Constrained Mode Harmonic Dynamic Response Case Transient Dynamic Response Case
<b>Stress full tensor component (element's nodes values)</b>	Iso-value image of one component of the Stress Tensor. The first component is displayed by default. This component can be changed through the <b>Filter</b> option (Image Editor dialog box).	Static Case Frequency Case Free Frequency Case Combined Case Static Constrained Mode Harmonic Dynamic Response Case Transient Dynamic Response Case
<b>Stress full tensor component (nodal values)</b>	Iso-value image of one component of the Stress Tensor. The first component is displayed by default. This component can be changed through the <b>Filter</b> option (Image Editor dialog box).	Static Case Frequency Case Free Frequency Case Combined Case Static Constrained Mode Harmonic Dynamic Response Case Transient Dynamic Response Case

<p><b>Stress full tensor text</b></p>	<p>Stress full tensor values at nodes. By default, the six components are displayed. A given component can be displayed through the <b>Filter</b> option (Image Editor dialog box).</p>	<p>Static Case  Frequency Case  Free Frequency Case  Combined Case  Static Constrained Mode  Harmonic Dynamic Response Case  Transient Dynamic Response Case</p>
<p><b>Translational displacement magnitude</b></p>	<p>Iso-value image of the nodal translation displacements magnitude.</p>	<p>Static Case  Frequency Case  Free Frequency Case  Buckling Case  Combined Case  Static Constrained Mode  Harmonic Dynamic Response Case  Transient Dynamic Response Case</p>
<p><b>Translational displacement component</b></p>	<p>Iso-value image of one component of the nodal translation displacements. This component can be changed through the <b>Filter</b> option (Image Editor dialog box).</p>	<p>Static Case  Frequency Case  Free Frequency Case  Buckling Case  Combined Case  Static Constrained Mode  Harmonic Dynamic Response Case  Transient Dynamic Response Case</p>
<p><b>Translational displacement vector</b></p>	<p>Symbols of the translation displacements vector.</p>	<p>Static Case  Frequency Case  Free Frequency Case  Buckling Case  Combined Case  Static Constrained Mode  Harmonic Dynamic Response Case  Transient Dynamic Response Case</p>
<p><b>Von Mises Stress (nodal values)</b></p>	<p>Iso-value image of nodal VonMises stress.</p>	<p>Static Case  Frequency Case  Free Frequency Case  Combined Case  Static Constrained Mode  Harmonic Dynamic Response Case  Transient Dynamic Response Case</p>

<p><b>Von Mises Stress (element node values)</b></p>	<p>Discontinuous iso-value image of element's nodal VonMises stress.</p>	<p>Static Case  Frequency Case  Free Frequency Case  Combined Case  Static Constrained Mode  Harmonic Dynamic Response Case  Transient Dynamic Response Case</p>
<p><b>Estimated local error</b></p>	<p>Fringe image of element's energy error estimation.</p>	<p>Static Case  Combined Case</p>
<p><b>Strain principal tensor component (nodal values)</b></p>	<p>Iso-value image of one component of the nodal rotational displacements. This component can be changed through the <b>Filter</b> option (Image Editor dialog box).</p>	<p>Static Case  Frequency Case  Free Frequency Case  Combined Case  Static Constrained Mode  Harmonic Dynamic Response Case  Transient Dynamic Response Case</p>
<p><b>Strain full tensor component (nodal values)</b></p>	<p>Iso-value image of one component of the Strain Tensor. The first component is displayed by default. This component can be changed through the <b>Filter</b> option (Image Editor dialog box).</p>	<p>Static Case  Frequency Case  Free Frequency Case  Combined Case  Static Constrained Mode  Harmonic Dynamic Response Case  Transient Dynamic Response Case</p>
<p><b>Strain principal tensor symbol</b></p>	<p>Strain principal tensor. Symbols of tensor algebraic values.</p>	<p>Static Case  Frequency Case  Free Frequency Case  Combined Case  Static Constrained Mode  Harmonic Dynamic Response Case  Transient Dynamic Response Case</p>
<p><b>Rotational displacement magnitude</b></p>	<p>Iso-value image of the nodal translation displacements magnitude.</p>	<p>Static Case  Frequency Case  Free Frequency Case  Buckling Case  Combined Case  Static Constrained Mode  Harmonic Dynamic Response Case  Transient Dynamic Response Case</p>

<b>Rotational displacement vector</b>	Symbols of the rotational displacements vector.	Static Case Frequency Case Free Frequency Case Buckling Case Combined Case Static Constrained Mode Harmonic Dynamic Response Case Transient Dynamic Response Case
<b>Friction force ratio iso</b>	iso value image of the friction force ratio.	Static Case
<b>Point force vector</b>	Symbols of the nodal force reactions.	Static Case Static Constrained Mode
<b>Point moment vector</b>	Symbols of the nodal moment reactions.	Static Case Static Constrained Mode
<b>Local strain energy</b>	Fringe image of element strain energy	Static Case Frequency Case Free Frequency Case Combined Case Static Constrained Mode
<b>Local strain energy density</b>	Fringe image of element strain energy density	Static Case Frequency Case Free Frequency Case Combined Case Static Constrained Mode
<b>Local strain energy symbol</b>	Symbol of strain energy	Static Case Frequency Case Free Frequency Case Combined Case Static Constrained Mode
<b>Force Flow text</b>	Text of force flow	Static Case Harmonic Dynamic Response Case Transient Dynamic Response Case
<b>Moment flow text</b>	Text of moment flow	Static Case Harmonic Dynamic Response Case Transient Dynamic Response Case
<b>Transverse shear strain text</b>	Text of transverse shear strain	Static Case Frequency Case Free Frequency Case Combined Case Static Constrained Mode Harmonic Dynamic Response Case Transient Dynamic Response Case

<b>Transverse shear stress text</b>	Text of transverse shear stress	Static Case Frequency Case Free Frequency Case Combined Case Static Constrained Mode Harmonic Dynamic Response Case Transient Dynamic Response Case
<b>Translational velocity vector</b>	Symbol of translational velocity	Harmonic Dynamic Response Case Transient Dynamic Response Case
<b>Translational acceleration vector</b>	Symbol of translational acceleration	Harmonic Dynamic Response Case
<b>Rotational velocity vector</b>	Symbol of rotational velocity	Harmonic Dynamic Response Case Transient Dynamic Response Case
<b>Rotational acceleration vector</b>	Symbol of rotational acceleration	Harmonic Dynamic Response Case Transient Dynamic Response Case
<b>Curvature text</b>	Text of curvature	Static Case Frequency Case Free Frequency Case Combined Case Static Constrained Mode Harmonic Dynamic Response Case Transient Dynamic Response Case
<b>Pressure fringe</b>	Fringe image of pressure	Static Case
<b>Pressure vector</b>	Symbol of pressure	Static Case
<b>Pressure (nodal value)</b>	Iso-value image of pressure	Static Case
<b>Clearance iso</b>	Iso value image of final clearance	Static Case
<b>Mass moment of inertia (text)</b>	Text of mass moment of inertia (spring element)	Static Case Frequency Case Static Constrained Mode
<b>Point Mass</b>	Symbol of nodal mass	Static Case Frequency Case Static Constrained Mode

<b>Surface stress principal tensor symbol</b>	Symbol of surface stress principal tensor	Static Case Frequency Case Free Frequency Case Combined Case Static Constrained Mode Harmonic Dynamic Response Case Transient Dynamic Response Case
<b>Relative acceleration vector</b>	Symbol of nodal mass	Harmonic Dynamic Response Case (restraint excitation) Transient Dynamic Response Case (restraint excitation)
<b>Relative translational displacement vector</b>	Symbol of nodal mass	Harmonic Dynamic Response Case (restraint excitation) Transient Dynamic Response Case (restraint excitation)
<b>Relative velocity vector</b>	Symbol of nodal mass	Harmonic Dynamic Response Case (restraint excitation) Transient Dynamic Response Case (restraint excitation)

## Nodes and Elements

Image Names	Meaning
<b>Mesh</b>	Mesh
<b>Elements text</b>	Elements numbers
<b>Nodes text</b>	Nodes numbers
<b>Degrees of freedom</b>	Nodal symbol of fixed degrees of freedom
<b>Local axis</b>	Symbol of local axis

<b>Physical type fringe</b>	Fringe image of the element physical type
<b>Coordinate symbol node</b>	Nodal coordinate symbol

## Loads

Image Names	Meaning	Load type
<b>Translational displacement magnitude</b>	Iso-value image of the nodal translation displacements magnitude.	Enforced Displacement
<b>Translational displacement component</b>	Iso-value image of one component of the nodal translation displacements. This component can be changed through the <b>Filter</b> option (Image Editor dialog box).	Enforced Displacement
<b>Translational displacement vector</b>	Symbols of the translation displacements vector.	Enforced Displacement
<b>Rotational displacement magnitude</b>	Iso-value image of the nodal translation displacements magnitude.	Enforced Displacement
<b>Rotational displacement vector</b>	Symbols of the rotational displacements vector.	Enforced Displacement
<b>Point moment vector</b>	Symbols of the nodal moment reaction	Distributed force Moment Bearing load
<b>Point force vector</b>	Symbols of the nodal force reactions.	Distributed Force Moment Bearing Load
<b>Angular acceleration vector</b>	Symbol of the modal angular acceleration.	Rotation Force



<b>Angular velocity vector</b>	Symbol of the modal angular velocity.	Rotation Force
<b>Acceleration vector</b>	Symbol of the modal angular nodal acceleration.	Acceleration
<b>Line force vector</b>	Symbols of the nodal force reactions.	Line Force Density
<b>Surface force vector</b>	Symbols of the nodal force reactions.	Surface Force Density
<b>Volume force vector</b>	Symbols of the nodal force reactions.	Body Force
<b>Pressure vector</b>	Symbols of vector pressure on face of elements.	Pressure
<b>Pressure Fringe</b>	Fringe image of contact pressure on face of elements.	Pressure
<b>Pressure (nodal values)</b>	Iso value image of average modal pressure.	Pressure
<b>Temperature field symbol</b>	Symbols of temperature field	Load
<b>Local axis symbol</b>	Symbol of local axis	Load

## Masses

Image Names	Meaning	Mass type
<b>Point mass symbol</b>	Symbols of nodal mass	Mass
<b>Point mass text</b>	Text of nodal mass	Mass
<b>Line mass symbol</b>	Symbols of line mass	Mass
<b>Line mass text</b>	Texts of line mass	Mass
<b>Surface mass symbol</b>	Symbols of surface mass	Mass
<b>Surface mass text</b>	Texts of surface mass	Mass
<b>Volume mass symbol</b>	Symbols of volume mass	Mass
<b>Volume mass text</b>	Texts of volume mass	Mass

## Restraints

Image Names	Meaning	Restraint type
<b>Degrees of freedom symbol</b>	Nodal symbol of the fixed degrees of freedom.	Clamp Surface slider Restraint Iso-Static Restraint
<b>Local axis symbol</b>	Symbol of local axis	

## Properties

Image Names	Meaning	Geometry Type
<b>Area moment of inertia</b>	Text of area moment of inertia	1D
<b>Area shear ratio in XY plane (text)</b>	Cross sectional area above shear area in XY plane	1D
<b>Area shear ratio in XZ plane (text)</b>	Cross sectional area above shear area in XZ plane	1D
<b>Clearance iso</b>	Iso-value image of initial clearance	
<b>Composite angle symbol</b>	Symbol of angle	2D composite
<b>Cross sectional area fringe</b>	Fringe image of beam element cross sectional area	1D
<b>Laminate number fringe</b>	Number of laminate in fringe visualization	2D composite

<b>Laminate number text</b>	Number of laminate in text visualization	2D composite
<b>Local axis symbol</b>	Symbol of local axis	3D 2D 1D
<b>Material fringe</b>	Fringe image of element material	3D 2D 1D
<b>Material text</b>	Text image of element material	3D 2D 1D
<b>Orientation vector (symbol)</b>	Symbol of orientation of beam connection	1D
<b>Physical type fringe</b>	Fringe image of the element physical type	3D 2D 1D
<b>Physical type text</b>	Text image of the element physical type	3D 2D 1D
<b>Ply id fringe</b>	Fringe image of the element physical type	2D composite
<b>Ply id text</b>	Text image of the element physical type	2D composite
<b>Rotational stiffness (symbol)</b>	Symbol of rotational stiffness	spring element
<b>Shear center (text)</b>	Shear center. Two coordinates in the plane of the beam section	1D
<b>Thickness fringe</b>	Fringe image of surface element thickness	2D 1D
<b>Translational stiffness (symbol)</b>	Symbol of translational stiffness	spring element

<b>Thickness text</b>	Text image of surface element thickness	2D 1D
-----------------------	---	----------

## Additional Images





You can edit the generated images.

For this, double-click the generated image.

For more details please refer to [Editing Images](#).









You will find here the list of the images available by editing the images that by default appear in the Image Generation dialog box.





















Images Available Using GPS Product		
Physical Type	Image Names	Generated (via icons) or edited ?*
<b>Error</b>	Estimated local error	
<b>Mesh</b>	Deformed Mesh	
<b>Stress</b>	Stress principal tensor symbol	
	Stress principal shearing (element's nodes values)	
	Stress principal tensor component (element value)	
<b>Temperature</b>	Temperature field fringe	
	Temperature field iso	
	Temperature field text	
<b>Von Mises</b>	Von Mises Stress (nodal value)	
	Translational displacement vector	





















<b>3D Nodal Displacement</b>	Translational displacement component	
	Translational displacement magnitude	
*  images edited using double-click		























The **ELFINI Structural Analysis** product offers additional images.



















Additional Images Available Using EST Product		
Physical Type	Image Names	Generated (via contextual menu) or Edited ?*
<b>Angle</b>	Angle text	
<b>Angular acceleration</b>	Angular acceleration vector	
	Angular acceleration fringe	
	Angular acceleration text	
<b>Angular velocity</b>	Angular velocity vector	
	Angular velocity fringe	
	Angular velocity text	
<b>Area moment of inertia</b>	Area moment of inertia (text)	





















<b>Clearance</b>	Clearance iso	
	Clearance symbol	
	Clearance text	
<b>Cross sectional area</b>	Cross sectional area fringe	
	Cross sectional area text	
<b>Curvature</b>	Curvature text	
<b>Effective shear ratio in XY plane</b>	Area shear ratio in XY plane (text)	
<b>Effective shear ratio in XZ plane</b>	Area shear ratio in XZ plane (text)	
<b>Elastic energy</b>	Local strain energy	
	Local strain energy symbol	
	Local strain energy text	
<b>Elastic energy density</b>	Local strain energy density	
	Local strain energy density symbol	
	Local strain energy density text	
<b>Elements material</b>	Material fringe	
	Material text	
<b>Elements set</b>	Elements text	
<b>Estimated error</b>	Estimated local error symbol	
	Estimated local error text	
<b>Force Flow</b>	Force flow text	
<b>Laminate number</b>	Laminate number text	





















	Laminate number fringe	
<b>Lineic force vector</b>	Line force vector	
	Line force text	
<b>Lineic mass</b>	Line mass symbol	
	Line mass text	
<b>Local axis</b>	Local axis symbol	
<b>Mass inertia</b>	Mass inertia (text)	
<b>Mass moment of inertia</b>	Mass moment of inertia (text)	
<b>Material angle</b>	Material angle text	
<b>Moment Flow</b>	Moment flow text	
<b>Nodes</b>	Nodes text	
<b>Normal to tangential force ratio</b>	Friction force ratio iso	
	Friction force ratio symbol	
	Friction force ratio text	
<b>Physical type</b>	Physical Type fringe	
	Physical Type text	
<b>Ply id</b>	Ply id text	
	Ply id fringe	
<b>Point force vector</b>	Point force vector	
	Point force component	
	Point force magnitude	









	Point force text	
<b>Point mass</b>	Point mass	
	Point mass symbol	
	Point mass text	
<b>Point moment vector</b>	Point moment vector	
	Point moment component	
	Point moment magnitude	
	Point moment text	
<b>Pressure</b>	Pressure fringe	
	Pressure text	
	Pressure vector	
	Pressure (nodal values)	
<b>Rotational acceleration</b>	Rotational acceleration vector	
	Rotational acceleration iso	
	Rotational acceleration text	
<b>Rotational stiffness</b>	Rotational stiffness (text)	
	Rotational stiffness (symbol)	
<b>Rotational velocity</b>	Rotational velocity	
	Rotational velocity iso	
	Rotational velocity text	
<b>Shear center</b>	Shear center (text)	

<b>Strain</b>	Strain principal tensor component (nodal values)	
	Strain principal tensor symbol	
	Strain principal tensor text	
	Strain full tensor component (nodal values)	
	Strain full tensor text	
<b>Stress</b>	Stress full tensor component (element's nodes values)	
	Stress full tensor component (nodal values)	
	Stress full tensor text	
	Stress principal tensor component (element's nodes absolute values)	
	Stress principal tensor component (nodal absolute values)	
	Stress principal tensor component (nodal values)	
	Stress principal tensor text	
	Stress principal tensor text (absolute)	
	Tensor for maximum shearing (nodal values)	
	Tensor for maximum shearing text	
	Von Mises Stress (center of element's values)	
	Von Mises Stress (element's nodes values)	
	Von Mises Stress (nodal values)	
	Von Mises Stress text	
	<b>Stress Von Mises</b>	Von Mises Stress (element's nodes values)

	Von Mises Stress (symbol)	
	Von Mises Stress text	
<b>Surface force vector</b>	Surface force vector	
	Surface force fringe	
	Surface force text	
<b>Surface mass</b>	Surface mass fringe	
	Surface mass symbol	
	Surface mass text	
<b>Surface stress</b>	Surface stress principal tensor symbol	
<b>Relative Translation</b>	Relative translational displacement vector	
<b>Relative translational acceleration</b>	Relative acceleration vector	
<b>Relative translational velocity</b>	Relative velocity vector	
<b>Temperature</b>	Temperature field symbol	
<b>Translational acceleration vector</b>	Acceleration vector	
	Acceleration	
	Acceleration fringe	
	Acceleration text	
<b>Translational Stiffness</b>	Translational stiffness (symbol)	
	Translational stiffness (text)	
<b>Translational Velocity Vector</b>	Velocity vector	

	Velocity	
	Velocity text	
<b>Transverse shear strain</b>	Transverse shear strain text	
	Transverse shear strain iso	
<b>Transverse shear stress</b>	Transverse shear stress text	
	Transverse shear stress iso	
<b>Volumic force vector</b>	Volume force vector	
	Volume force	
	Volume force fringe	
	Volume force text	
<b>Volumic mass</b>	Volume mass	
	Volume mass fringe	
	Volume mass symbol	
	Volume mass text	
<b>3D coordinates</b>	Nodal coordinates symbol	
	Nodal coordinates text	
<b>3D mechanical degrees of freedom</b>	Degrees of freedom symbol	
<b>3D orientation vector</b>	Orientation vector (symbol)	
	Orientation vector (text)	
<b>3D rotational vector</b>	Rotational displacement component	
	Rotational displacement magnitude	

	Rotational displacement text	
	Rotational displacement vector	
<b>3D shell thickness</b>	Thickness fringe	
	Thickness text	
<b>3D translational vector</b>	Translational displacement text	
<p>*</p> <p> images generated using the <b>Generate Image</b> contextual menu</p> <p> images edited using double-click</p>		



You can also generate images that you have previously saved.

For more details, please refer to [Saving an Image as New Template](#) in this guide.



# Editing Images



This task will show you how to edit images.

You can generate an image in addition to those of the **Image** toolbar (using the **Image Generation** dialog box). The list of these images will depend on the Case type. You will then be able to edit **different types of images** that by default appear in the Image Generation dialog box.

In other words, the names of the images depend on:

1. physical type (for example: **Displacement**)
2. visualization type (for example: **Symbol** or **Text**)
3. criterion (for example: **Vector** or **Principal value**)



Open the [sample00.CATAnalysis](#) document from the samples directory.

In this particular example, you have to generate images using the **Generate Image contextual menu** or using the **Images toolbar**.



You have to activate the image before editing it.

For this, right-click the image you want to activate and select the **Activate/Deactivate** contextual menu.



1. Double-click an activated image in the specification tree.



The Image Edition dialog box appears.

For more details about the Image Edition dialog box, please click [here](#).

2. Set the desired parameters in the Image Edition dialog box.
3. Click **OK** in the Image Edition dialog box.



In case of pre-processing specifications, the type of entities contained in a selection may be different from a specification to another.

For example:

- a **Clamp** symbolizes a list of nodes
- a **Lineic Force** symbolizes a list of edges
- a **Pressure** symbolizes a list of faces

You can find an example:



1. Open the [sample49\\_2.CATAnalysis](#) from the samples directory.
2. Double-click the **Clamp.1** object in the specification tree.

You can see that the support of the clamp is one face.

You can close the Clamp dialog box.

3. Right-click the **Von Mises Stress (nodal values)** image in the specification tree and select the Activate/Deactivate contextual menu.
4. Double-click the **Von Mises Stress (nodal values)** image in the specification tree to edit it.
5. Select the **Selections** tab in the Image Edition dialog box.
6. Select **Clamp.1** in the Image Edition dialog box.

You can visualize nodes:

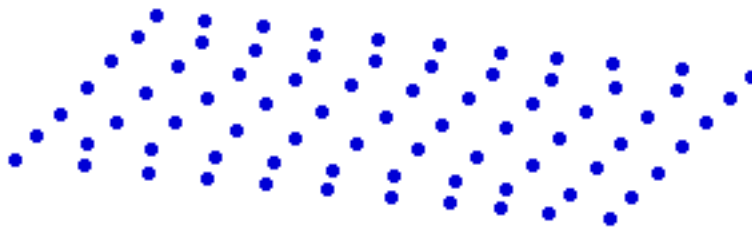

7. Select **Surface Group.1** in the Image Edition dialog box.

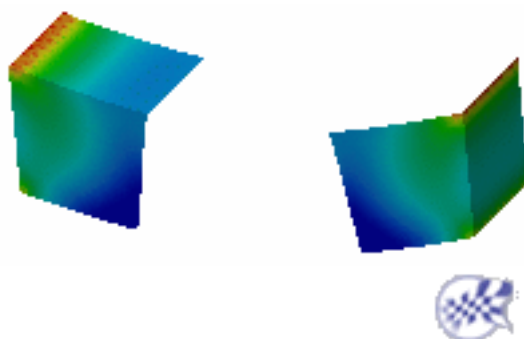

# Saving an Image As New Template



This task shows you how to save a generated image as template in a xml file which contains all the images you have generated.

Visu type mesh images cannot be saved as template.



Only available with the **ELFINI Structural Analysis (EST)** product.



Open [sample35.CATAnalysis](#) document from the samples directory for this task.

## Before You Begin:

- Compute the solution.  
For this click the **Compute** icon.
- Generate an image.  
For more details, please refer to [Generating Images](#).



1. Right-click an image feature in the specification tree.

2. Select the **Save As New Template** contextual menu



The Save as new template dialog box appears.

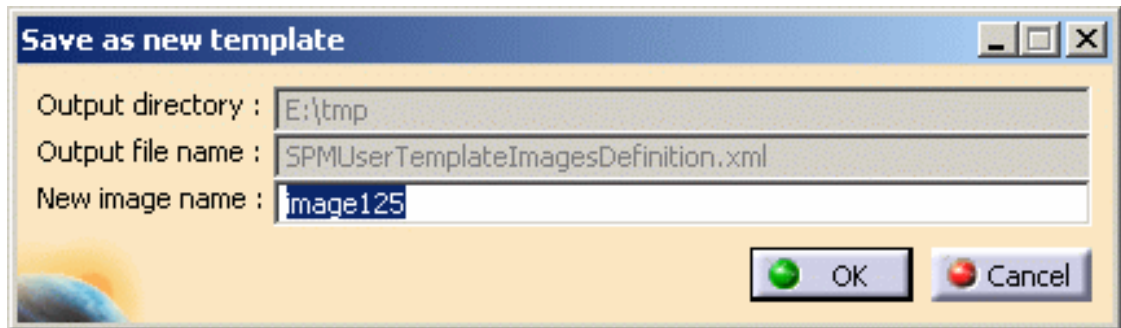

- **Output directory:** lets you see the name of the directory in which the image will be saved.
- **Output file name:** lets you see the name of the file in which the image will be saved.
- **New image name:** lets you give a name to the image you want to save as template.



To know more about the management of the xml file, please refer to the Post Processing task in the Customizing section of this user's guide.

3. Modify the name of the image you want to save as template in the Save as new



template dialog box, if needed.

4. Click **OK** in the Save as new template dialog box.

The saved image is now available in the Image Generation dialog box.



You can retrieve the template image you just have saved.

For this, right-click the **Static Case Solution.1** object in the specification tree and select the **Generate Image** contextual menu.

The Image Generation dialog box appears and you can create an image from the template image you just have saved you have saved.



# Generating 2D Display Visualization



Only available with the **Generative Dynamic Response Analysis (GDY)** product.

The 2D Display functionality allows you to visualize in two dimensions a modulation, the results of a dynamic response computation or sensors (in certain conditions).

You can modify the parameters associated to the plot, axis, legend or background.

You can also resize the plot.

## Generating 2D Display for Modulation

Generate a 2D Display visualization of a modulation.

## Generating 2D Display for Dynamic Response

Generate a 2D Display result after a dynamic response computation.

## 2D Display for Local Sensor

Generate a 2D Display visualization of a sensor.

## Editing the 2D Display Parameters

Edit the 2D Display parameters (axis, display, legend, plot, ...).

# Generating a 2D Display for Modulation



This task shows you how to generate a 2D Display visualization for a modulation (frequency modulation or time modulation).



Open the [sample59.CATAnalysis](#) document from the samples directory for this task.

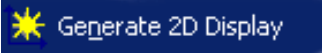

1. Right-click the **Frequency Modulation.1** object in the specification tree and select the **Generate 2D Display** contextual menu .

The corresponding view appears in a 2D Display document.

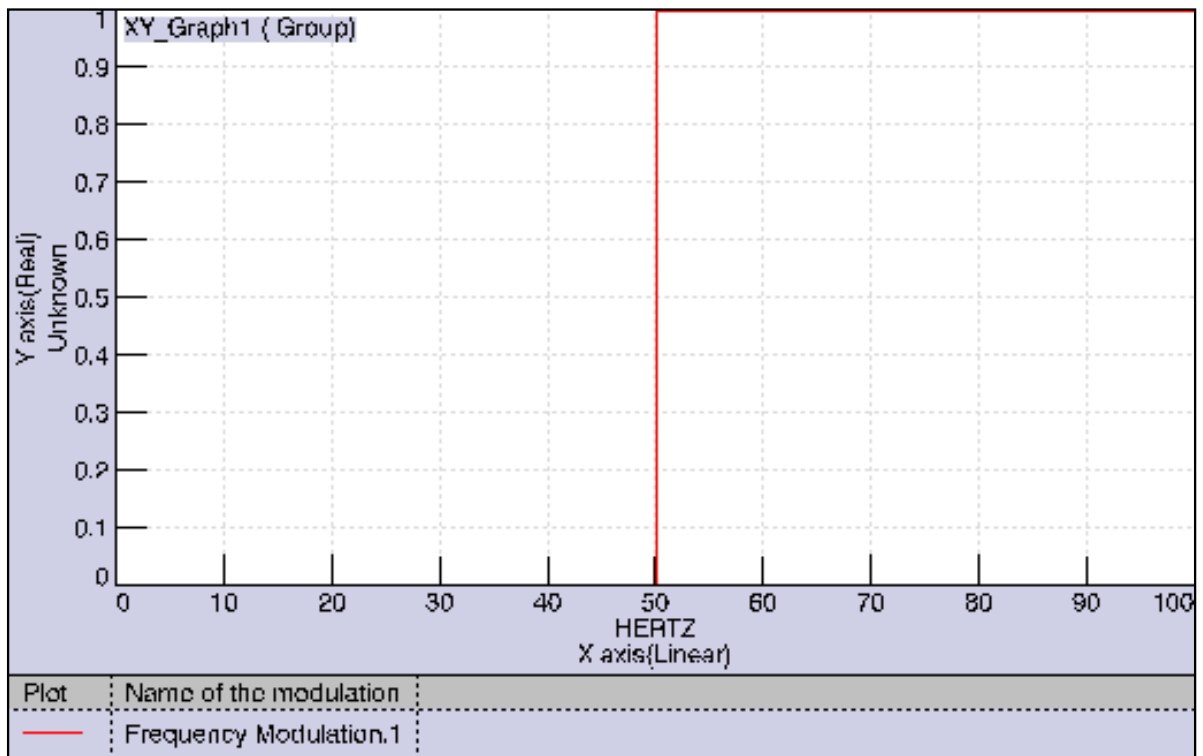

You can change the units and the format of the axis to have a better visualization.

For this, please refer to [Editing the 2D Display Parameters](#):

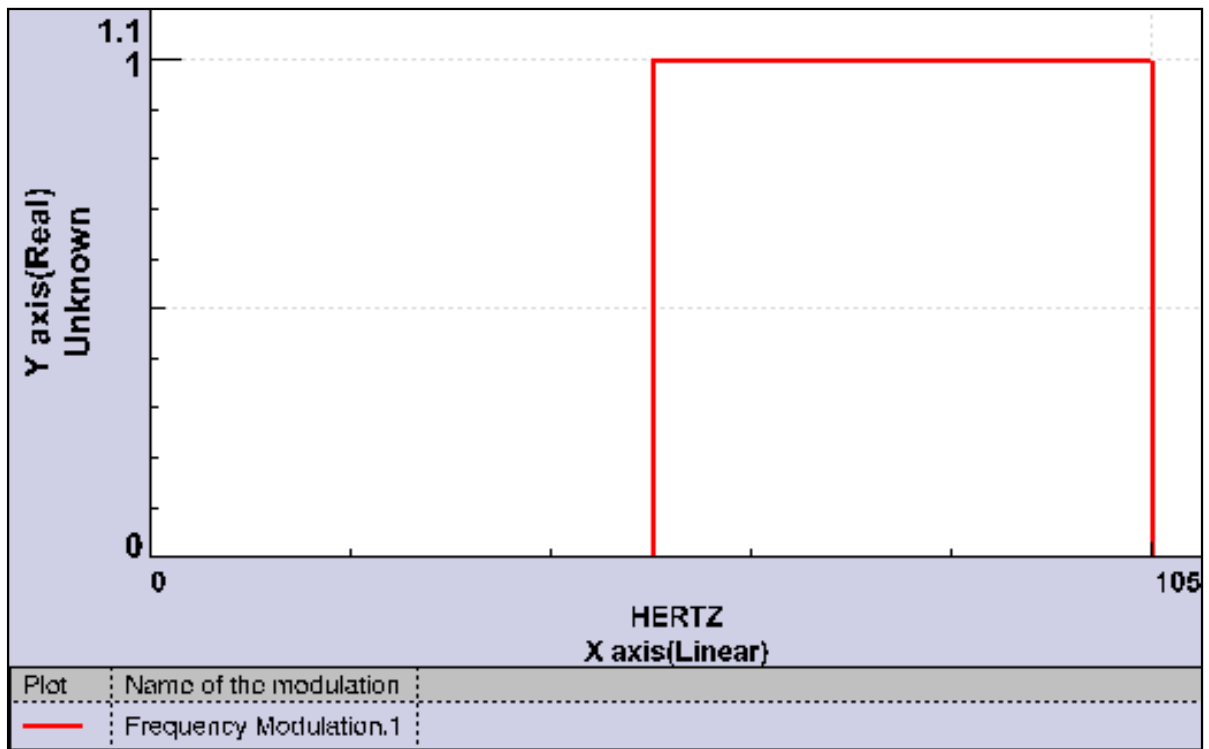

2. Close the window to retrieve the CATAnalysis document.

A **2D Display - Frequency Modulation.1** object appears in the specification tree.

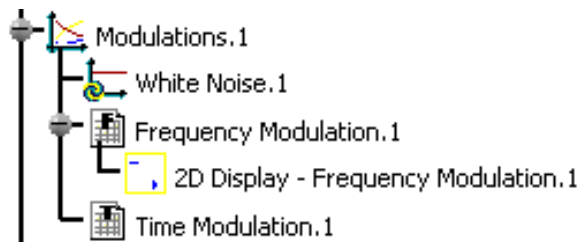

You can retrieve the 2D view and edit it.

For this, double-click the **2D Display - Frequency Modulation.1** object in the specification tree.

3. Right-click the **Time Modulation.1** object in the specification tree and select the **Generate 2D Display** contextual menu.

The corresponding view appears in a 2D Display document.

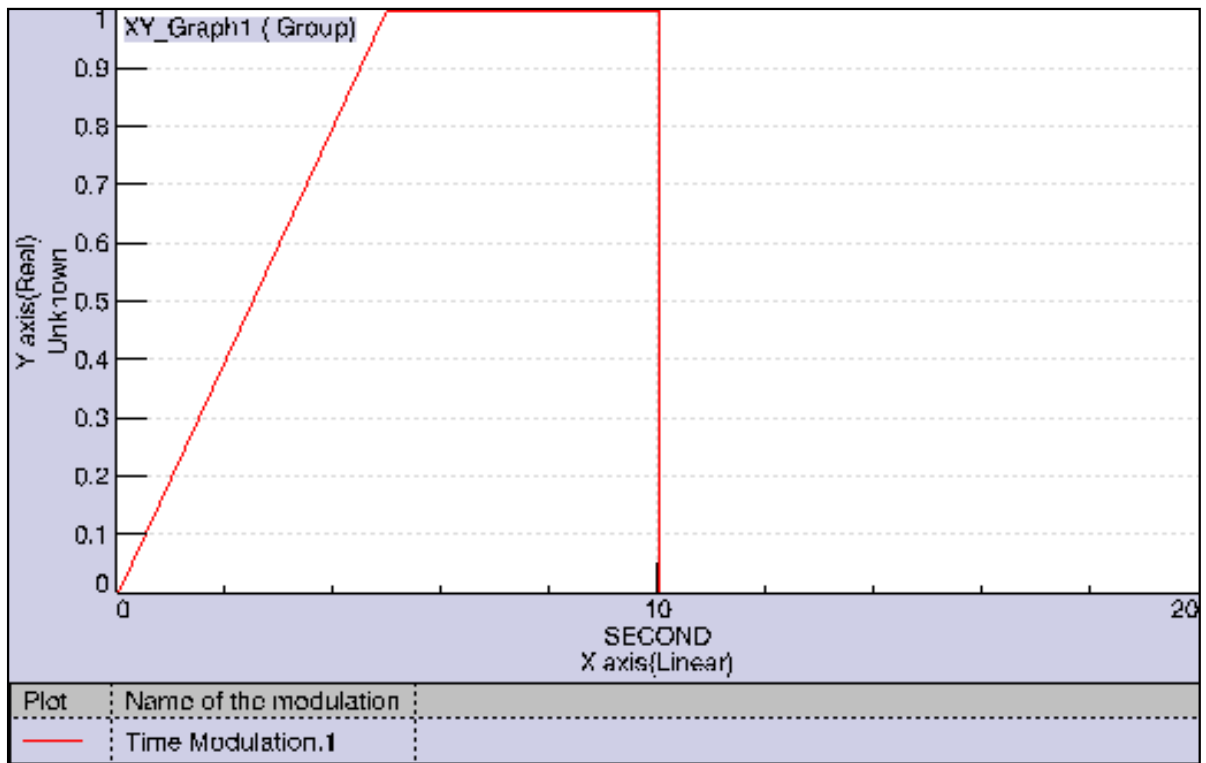

4. Close the 2D Display window.

A **2D Display - Time Modulation.1** object appears in the specification tree.

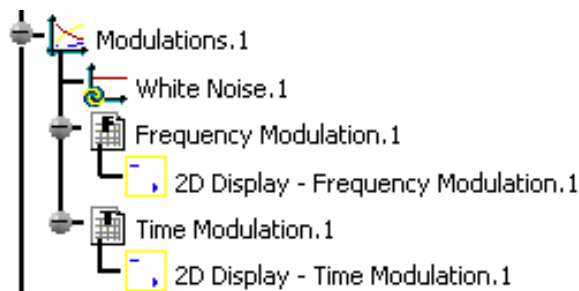

- For an easier navigation between the two documents, select the **Tile Horizontally** or **Tile Vertically** submenu of the **Window** menu.
- You can delete a 2D display.  
For this, right-click the 2D Display you want to delete in the specification tree and select the **Delete** contextual menu.





You can edit several graphic parameters.

For more details, please refer to [Editing 2D Display Parameters](#).



# Generating 2D Display for Dynamic Response Solution

 This task shows you how to generate a 2D Display result after a dynamic response computation (harmonic or transient).

 Open the [sample59.CATAnalysis](#) document from the samples directory for this task.

-  The computation of the solution is automatically launched when you use this functionality.  
The computation process may be long.
- Results generated from a dynamic response solution with restraint excitation (using the **Generate 2D Display** contextual menu) are displayed in a relative axis system. That means that observed displacements correspond to displacements resulting from the elastic strain.

On the contrary, images generated from a dynamic response solution with restraint excitation (using the **Generate Image** contextual menu) are displayed in the absolute axis system. That means that observed displacements are the sum of rigid body displacements resulting from the excitation and displacements resulting from the elastic strain.

 1. Right-click the **Harmonic Dynamic Response Solution.1** object and select the **Generate 2D Display** contextual menu



 The New Function Display dialog box appears.

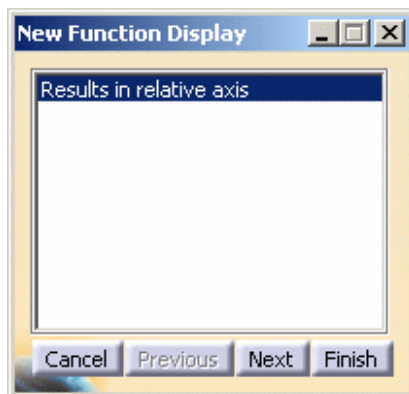

 The content of this dialog box depends on the excitation set you defined.

If you work on a dynamic response case (harmonic or transient) defined with a **Restraint Excitation** set, the New Function Display dialog box appears as shown below:

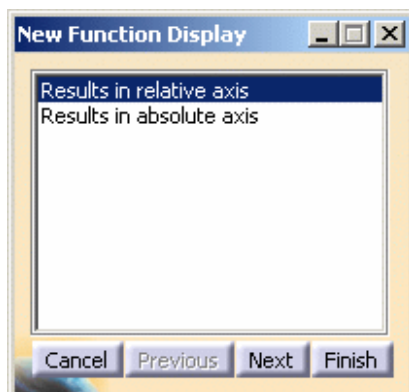

- Results in relative axis:** lets you visualize results in a relative axis system.
- Results in absolute axis:** lets you visualize results in an absolute axis system.
- Cancel:** lets you cancel the 2D Display generation.

- **Previous:** this button is not available at this step.
- **Next:** lets you access the next step of the 2D Display generation.
- **Finish:** lets you finish the 2D Display generation.  
If you click this button at this step, you will create only one graph.

2. Click **Next** in the New Function display dialog box.

The dialog box appears as shown bellow:

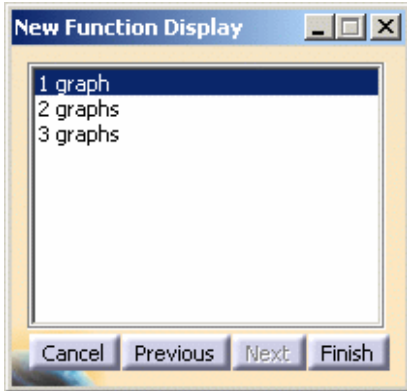

- **1 graph:** lets you generate a 2D Display document containing only one graph.
- **2 graphs:** lets you generate a 2D Display document containing two graphs.
- **3 graphs:** lets you generate a 2D Display document containing only three graphs.
- **Cancel:** lets you cancel the 2D Display generation.
- **Previous:** lets you access the previous step.
- **Next:** this button is not available at this step.
- **Finish:** lets you finish the 2D Display generation.

3. Select **3 graphs** and click **Finish** in the New Function Display dialog box.

A 2D Display document and the Select Data dialog box appear simultaneously.

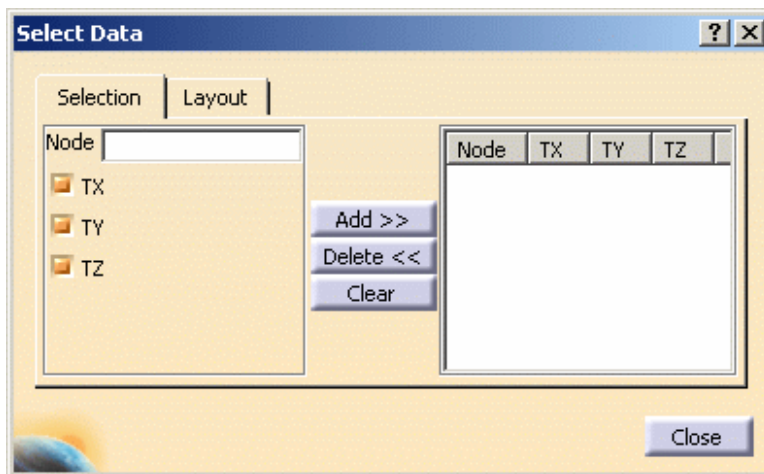

- **Selection tab:**
  - **Node:** gives you the number of the selected node.
  - **Degrees of freedom:** lets you choose the degrees of freedom you want.
- **Layout tab:**

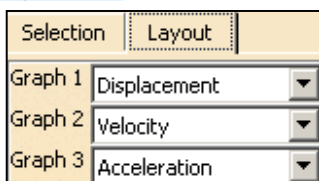

- **Graph 1:** lets you choose which type of results (**Displacement, Velocity or Acceleration**) you want to display in the first graph.
  - **Graph 2:** lets you choose which type of results (**Displacement, Velocity or Acceleration**) you want to display in the second graph.
  - **Graph 3:** lets you choose which type of results (**Displacement, Velocity or Acceleration**) you want to display in the third graph.
- It is possible to select the same result type for two or three graphs. This will be useful to visualize the

- **Add>>:** this button lets you add parameters of a selected node.
- **Delete<<:** this button lets you remove parameters of a selected node.
- **Clear:** this button lets you clear the contain of the **Selected curves** field.
- **Close:** this button lets you close the Select Data dialog box.

A **Results in relative axis - 3 graphs** object appears in the specification tree in the CATAnalysis document:

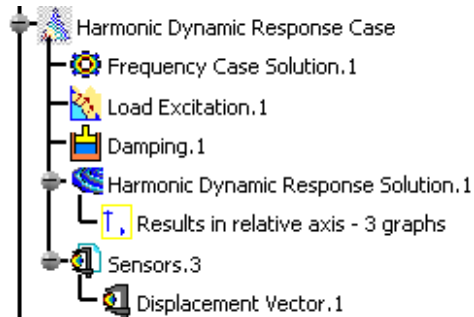

For an easier navigation between the two documents, select the **Tile Horizontally** or **Tile Vertically** submenu of the **Window** menu.

4. Select a node on the mesh visualization in the **.CATAnalysis** document.

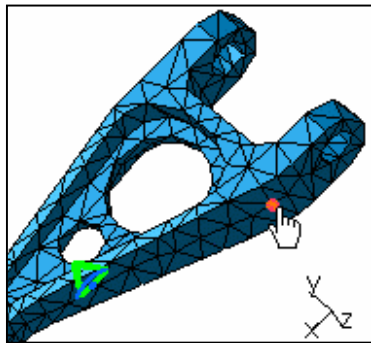

5. Select the degree of freedom (**TX** and/or **TY** and/or **TZ**).

In this particular example, deactivate the **TY** and **TZ** options.

6. Click the **Add>>** button.

The Select Data dialog box is automatically updated.



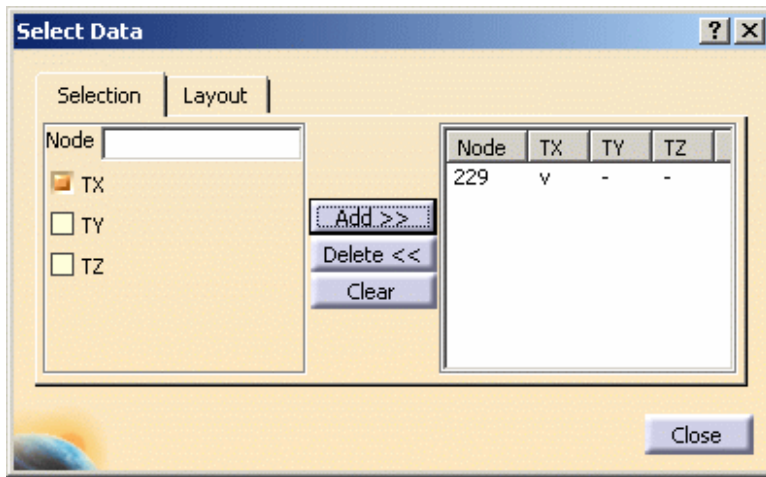

The three curves are automatically displayed in the 2D Display document.

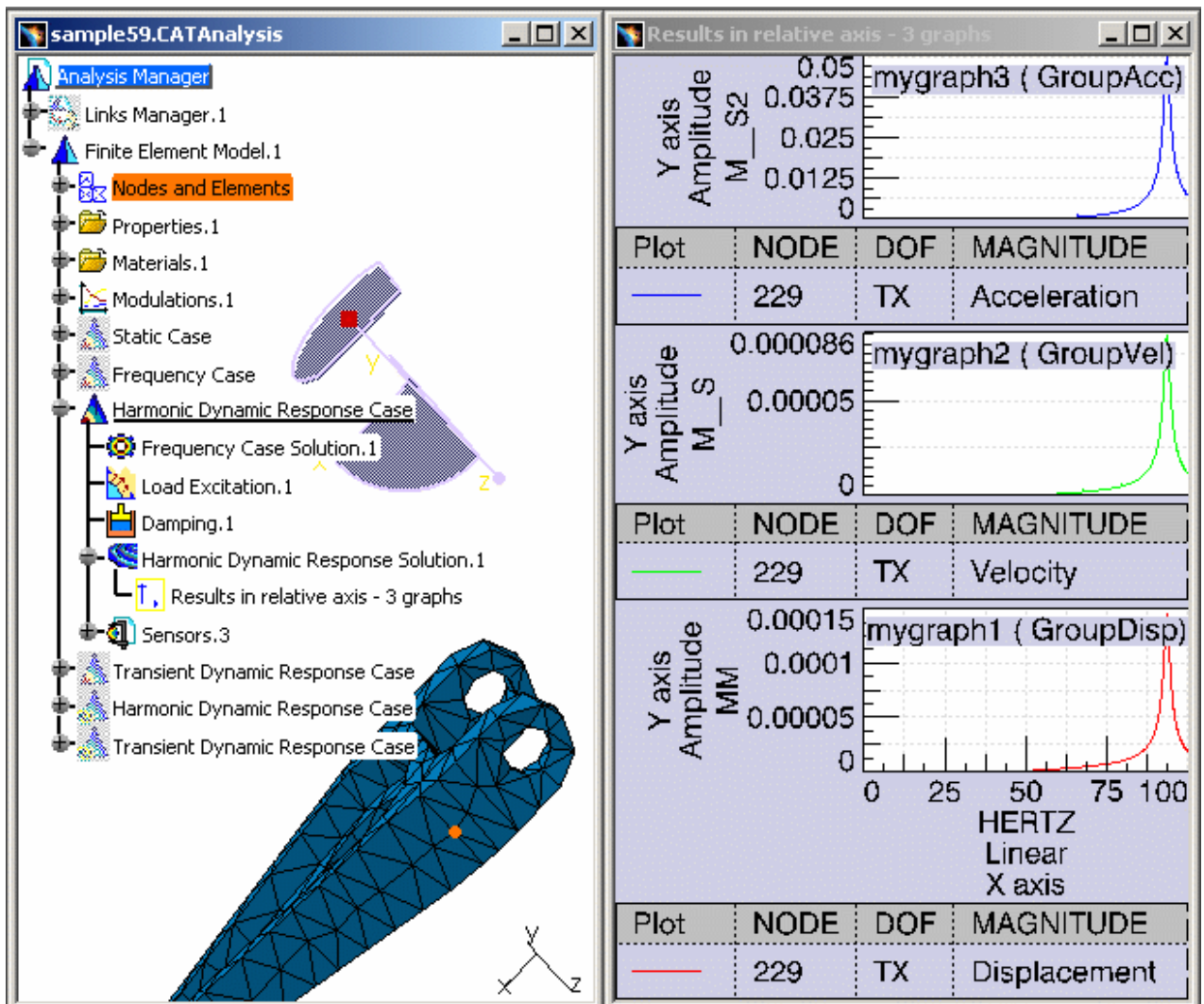

In this particular example, the first graph gives you the displacement results, the second one gives you the velocity results and the third one gives you the acceleration results.

7. Select the **Layout** tab in the Select Data dialog box and select **Displacement** as output type for **Graph 2**.

The legend of the second graph is updated.

8. Click **Close** in the Select Data dialog box.

9. Change the format of the Y axis in the first graph and second graph.

For this:

- a. Double-click the Y axis of the first graph to edit it.
- b. Select **Real** in the **Format** tab of the Y Axis dialog box.
- c. Click **OK**.
- d. Double-click the Y axis of the second graph to edit it.
- e. Select **Real** in the **Format** tab of the Y Axis dialog box.
- f. Click **OK**.

The 2D Display document is updated:

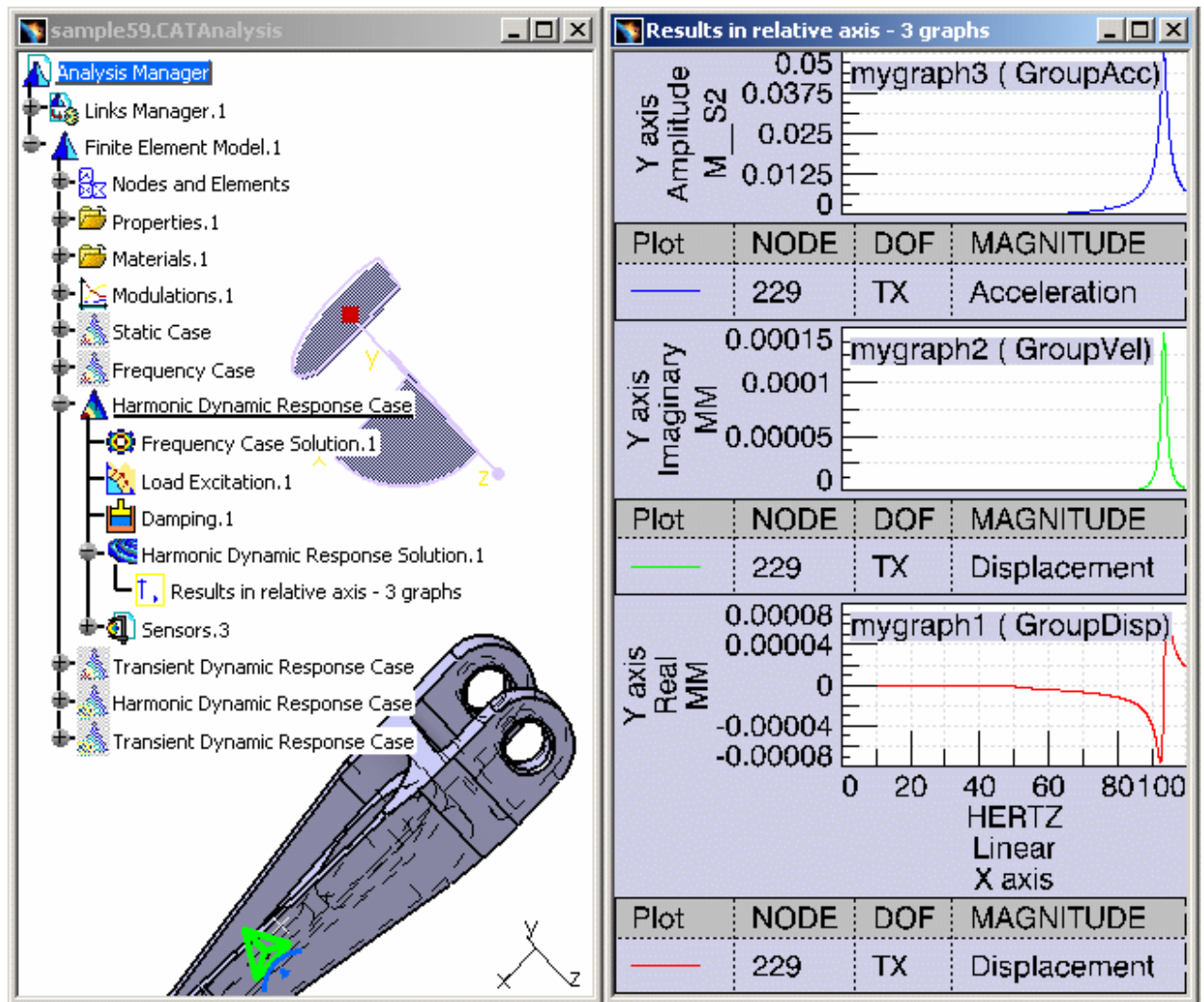

10. You can close the 2D Display window.



You can edit several graphic parameters.

For more details, please refer to [Editing 2D Display Parameters](#).



# Generating a 2D Display for Sensor



This task shows you how to generate a 2D Display visualization of a sensor.



- You can generate a 2D Display visualization only in case of multi-occurrence solutions (frequency, dynamic response, ...).
- The computation of the solution containing the sensor is automatically launched when you use this functionality. The computation process may be long.



Open the [sample59.CATAnalysis](#) document from the samples directory for this task.

## Before You Begin:

Compute all the solution. For this, click the **Compute** icon.



1. Right-click the **Displacement Vector** sensor under the **Sensor.3** object in the specification tree and select

the **Generate 2D Display** contextual menu 

The corresponding view appears in a 2D Display document.

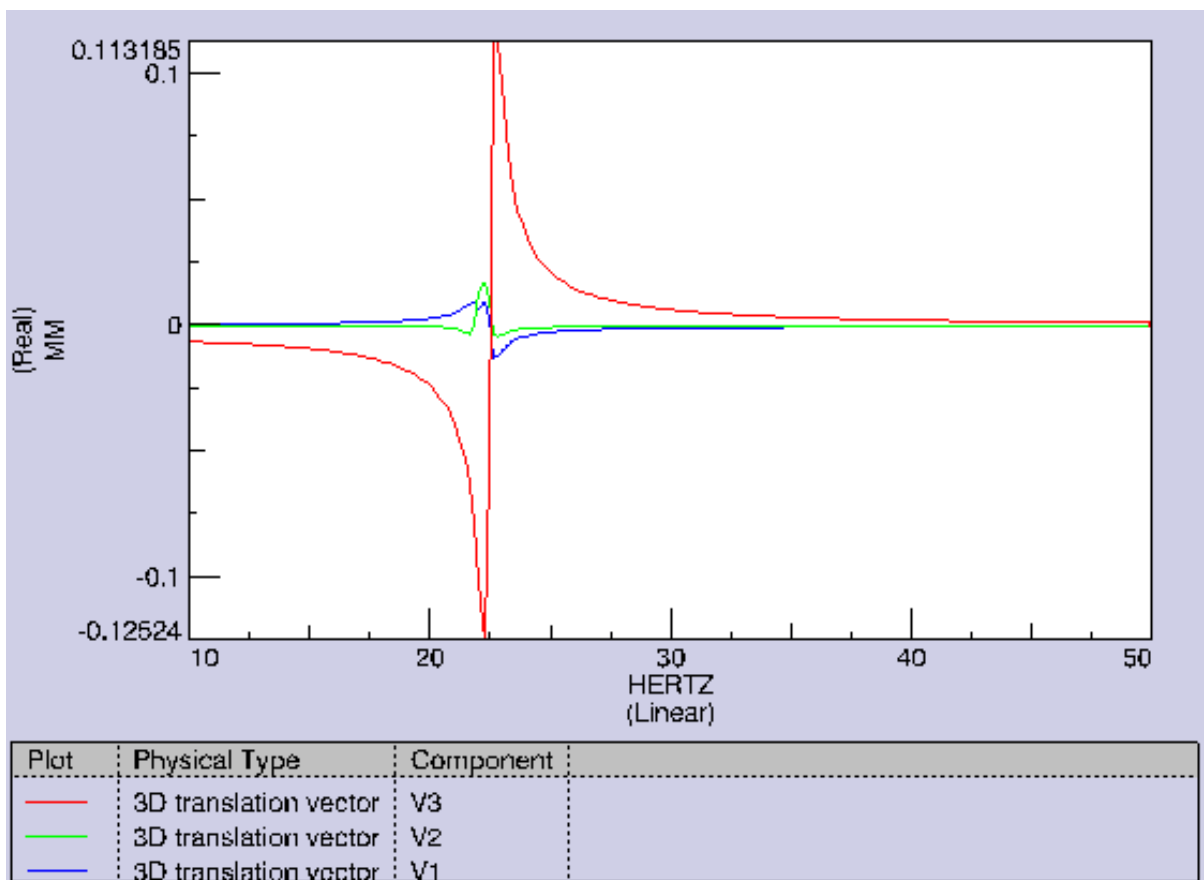

2. Close the window to retrieve the CATAnalysis document.

A 2D Display object appears in the specification tree.



You can retrieve the 2D view and edit it.

For this, double-click the 2D Display object in the specification tree.



For an easier navigation between the two documents, select the **Tile Horizontally** or **Tile Vertically** submenu of the **Window** menu.



You can edit several graphic parameters.

For more details, please refer to [Editing 2D Display Parameters](#).



# Editing 2D Display Parameters



This task shows you how to edit the 2D Display parameters.

You can edit:

- [x axis parameters](#) (limits, scale, ...)
- [y axis parameters](#) (limits, scale, ...)
- [plot parameters](#) (color, thickness of the line, ...)
- [legend parameters](#) (position, text style, ...)
- [display parameters](#) (background color, units, ...)

The following diagram gives you the main parts of a 2D Display document.

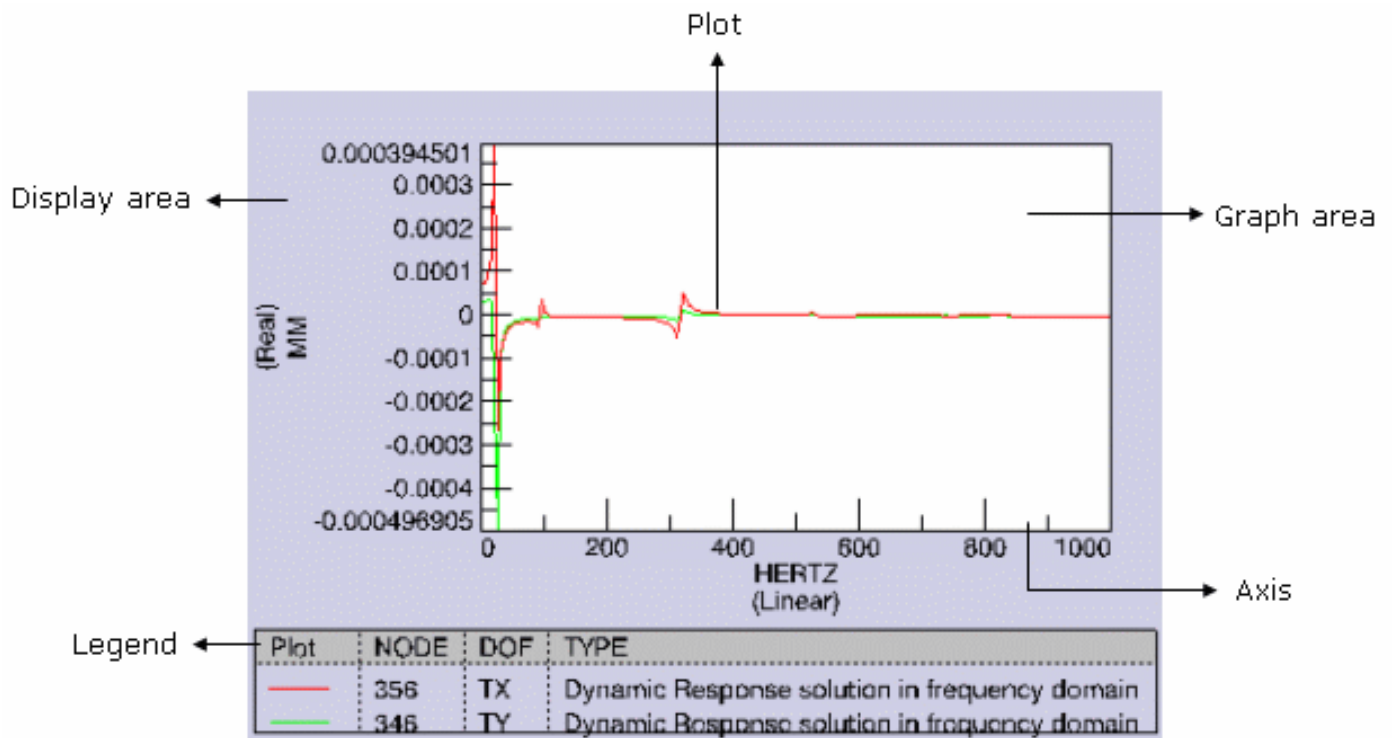

To perform this task, you have to:

- open the [sample58.CATAnalysis](#) document from the samples directory.
- generate a 2D display result with only one graph for a dynamic response computation. For more details, please refer to [Generating 2D Display for Dynamic Response](#).

In this task, you will work with the following graph:

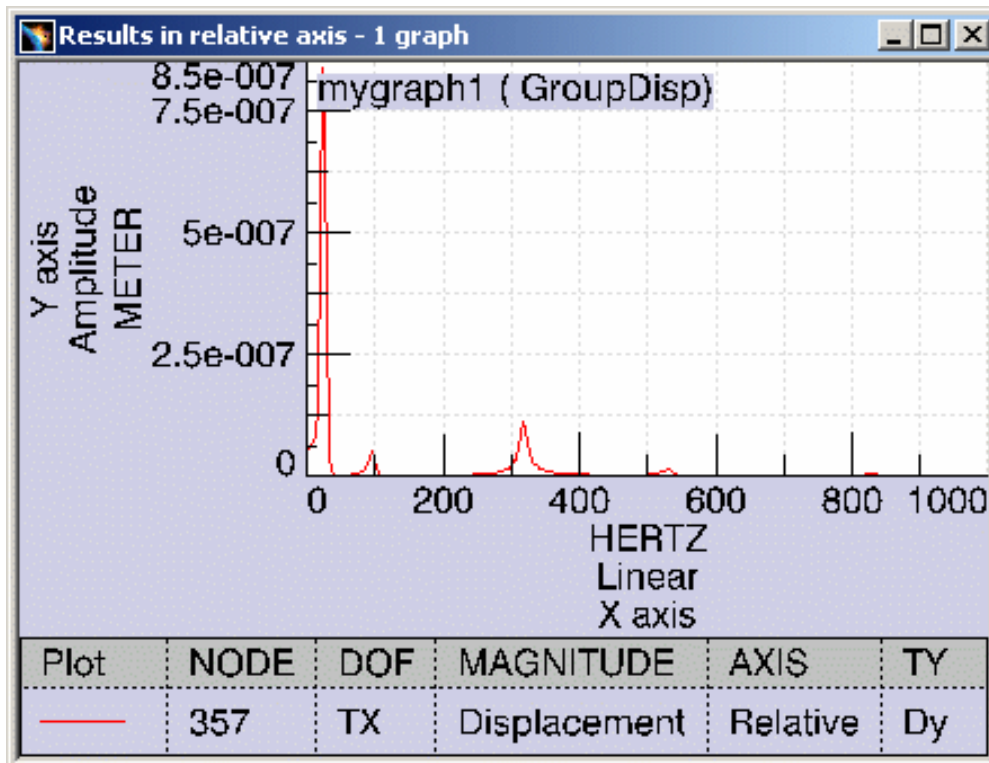

## Editing X Axis Parameters

You will see here how to edit the x axis system parameters.



1. Right-click the **X** axis system.

The following contextual menus are available:

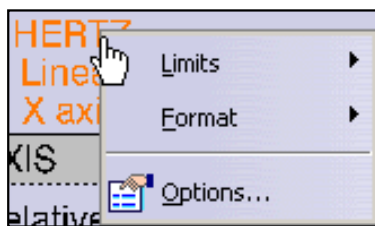

- **Limits:** lets you choose between the following options:
  - **Free**
  - **Optimized**
  - **Fixed...:** lets you fix the limit of the X axis by entering **Lower** and **Upper** values.
  - **Application Defined**
- **Format:**
  - **Linear:** lets you select a linear scale
  - **Octaves:** lets you choose a scale with logarithm in base 2
  - **Decades:** lets you choose a scale with logarithm in base 10
  - **Power2:** lets you choose a scale with logarithm in base 2 and the annotation in real powers of 2
- **Options...:** lets you access the X Axis dialog box.  
You can also double-click the **X Axis** to access the X Axis dialog box.

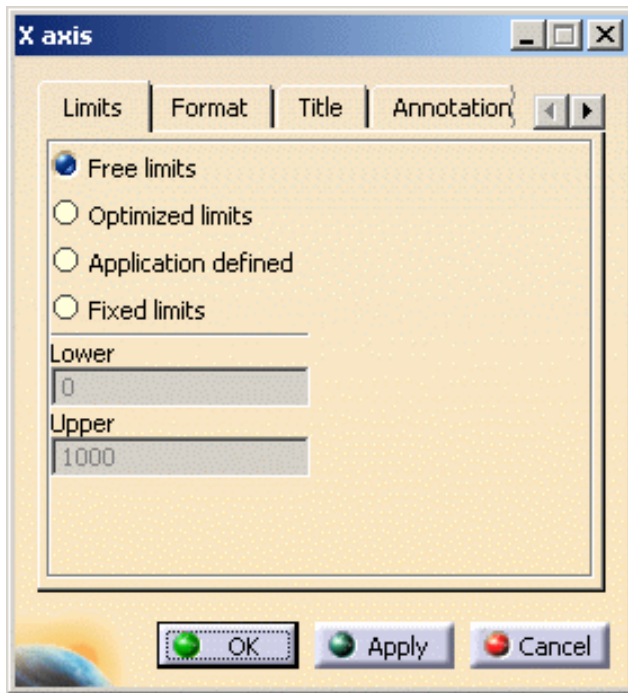

- **Limits:** for more details, please click [here](#).
  - **Format:** for more details, please click [here](#).
  - **Title:** lets you modify the name of the axis.
    - **Default:** lets you preserve the default axis name (**X axis**).
    - **Custom:** lets you enter a new axis name. This will modify the name of the dialog box.
  - **Annotation:**
    - **Include limit annotation:** lets you hide or show the limit values of the axis.
    - **Include tick annotation:** lets you hide or show the tick values.
    - **Include labels:** lets you hide or show information about the axis.
    - **Setting for Linear Formats**
      - **Number of divisions:** Automatic, One, Two, Four, Five, Ten
      - **Resolution:** Automatic, One, Two, Four, Five, Ten
  - **Grid:** lets you modify the **Color**, the **Dash Style** and the **Weight** of the grid.
    - **Show on major ticks**
    - **Show on minor ticks**
  - **Text Style:** lets you change the style of the x axis text.
    - **Inherit**
    - **Customized:** lets you customize the text style of the X axis. You can choose the **Size** and the **Font** of the X axis text.
    - **Make children inherit**
2. Select the **Options...** contextual menu.
  3. Select the desired parameters in the X Axis dialog box.



In this particular example,

- o select **Fixed limits** in the **Limits** tab,
- o enter **600** as **Upper** value,
- o select the **Customized** option in the **Text Style** tab,
- o enter **2.00** as **Size** value.

4. Click **OK** in the X Axis dialog box.

The x axis appears as shown here:

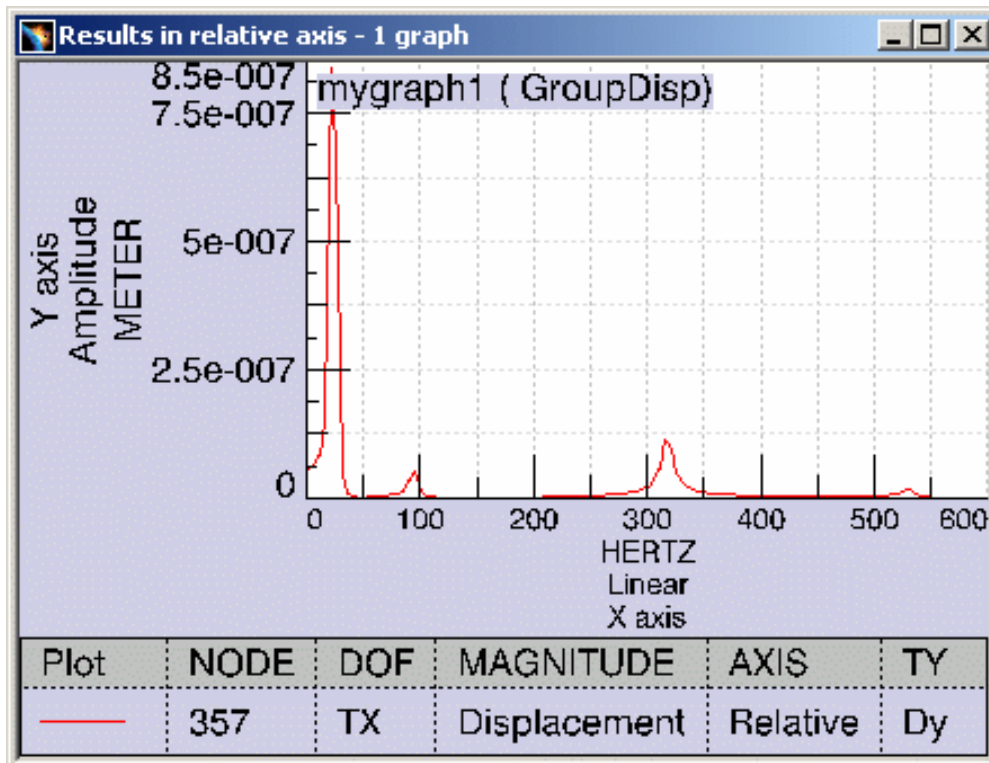

## Editing Y Axis Parameters

You will see here how to edit the y axis system.





## 1. Right-click the y axis.

The following contextual menus are available.

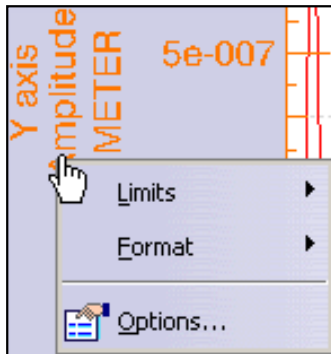

- **Limits:** for more details, please click [here](#).
- **Format:**
  - **Real**
  - **Imaginary**
  - **Phase degrees**
  - **Phase radians**
  - **Amplitude**
  - **Logarithmic**
  - **dB(RMS)**
  - **dB(Peak)**
- **Options...:** lets you access the Y Axis dialog box.  
You can also double-click the **Y Axis** to access the Y Axis dialog box.

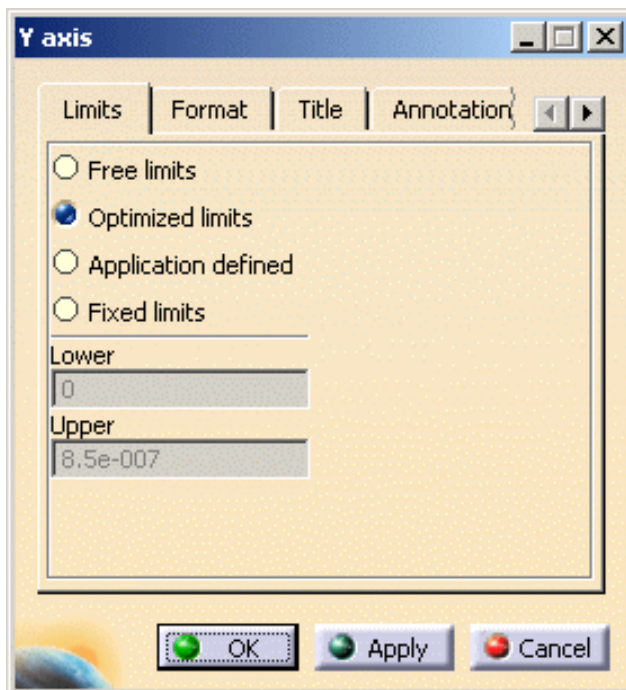

- **Limits:** for more details, please click [here](#).
- **Format:** for more details, please click [here](#).

- **Title:** for more details, please click [here](#).
  - **Annotation:** for more details, please click [here](#).
  - **Grid:** for more details, please click [here](#).
  - **Text Style:** for more details, please click [here](#).
2. Select the **Options...** contextual menu.
  3. Select the desired parameters.
  4. Click **OK** in the Y Axis dialog box.



## Editing Plot Parameters

You will see here how to edit the plot.



1. Right-click the plot.

The following contextual menus are available.

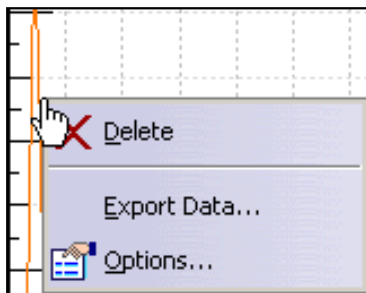

- **Delete:** lets you delete the plot.
- **Export Data...:** lets you export the 2D Display results in a Text (.txt) file or in a Exel (.xls) file. If you select this contextual menu, the Export Data dialog box appears to let you:
  - select the directory in which you will export the 2D Display data,
  - name the file containing the 2D Display data,
  - choose between the .txt or .xls file type.
- **Options...:** lets you access the Edit Plot dialog box. You can also double-click the plot to access the Edit Plot dialog box.

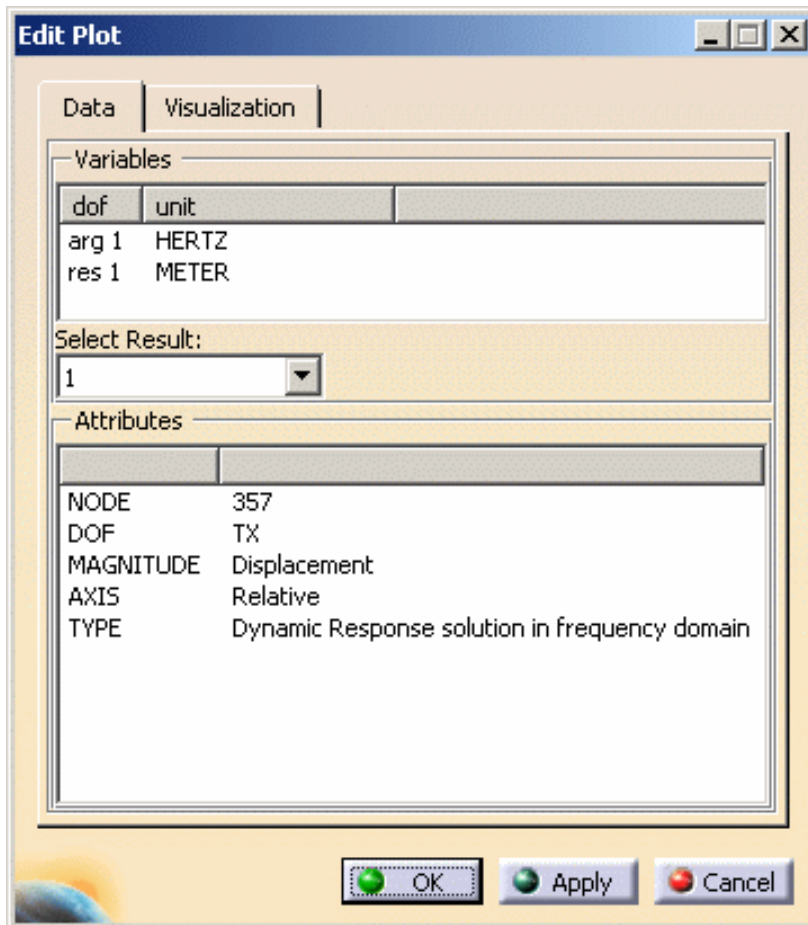

- **Data tab:**
    - **Variables**
      - **Select Result**
    - **Attributes**
  - **Visualization tab:** lets you define the **Line Style**
    - **Line color:** lets you choose the color of the plot
    - **Use line:** lets you draw the plot with a line. You can define the **Dash** and the **Weight** of the line.
    - **Use symbol:** lets you draw the plot with symbols.
- 2.** Select the **Export Data...** contextual menu.
  - 3.** Select the desired directory and enter a name in the Export Data dialog box.
  - 4.** Select **Exel** as **Save as type** option in the Export Data dialog box.
  - 5.** Click **OK** in the Export Data dialog box.

To visualize an example of Exel export data file, please click [here](#).

To visualize an example of Text export data file, please click [here](#).



## Editing Legend Parameters

You will see here how to edit the legend.



1. Double-click the graph legend.

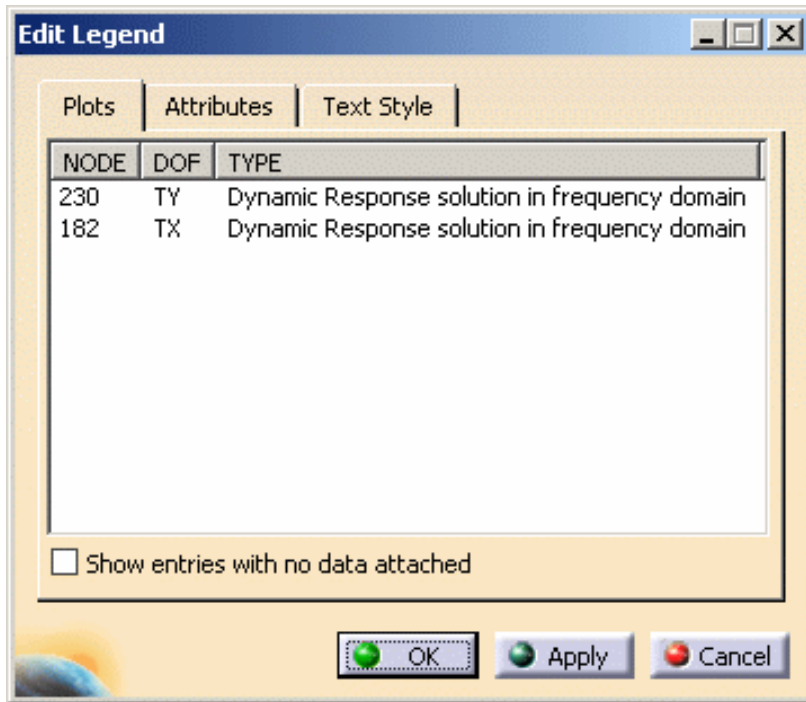

- o **Plots** tab: lets you visualize details of attributes
    - **Show entries with no data attached**
  - o **Attributes** tab:
    - **Hide Attributes**: lets you hide an attribute in the legend
    - **Show Attributes**: lets you show an attribute in the legend
    - **Up** and **Down**: let you change the position of attributes in the legend
  - o **Text Style** tab: for more details, please click [here](#).
2. Select the desired parameters.
  3. Click **OK** in the Edit Legend dialog box.
  4. Right-click the graphic legend.

The **Show Legend** contextual menu is available.



This contextual menu lets you hide the legend.

To show again the legend, use the **Legend** contextual menu.

For more details about the **Legend** contextual menu, please click [here](#).



# Editing Display Parameters

You will see here how to edit the background.



1. Right-click the display area.

The following contextual menus are available.

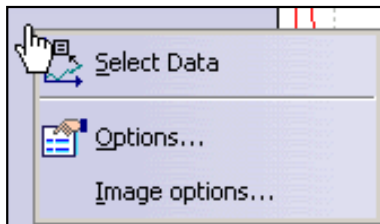

- **Select Data:** lets you access to the Select Data dialog box.  
For more details, please refer to [Generating a 2D Display for Dynamic Response Solution](#).
- **Options...:** lets you access the Edit Display dialog box.  
You can also double-click the plot to access the Edit Display dialog box.
- **Image options...:** lets you access the Edit Image dialog box.

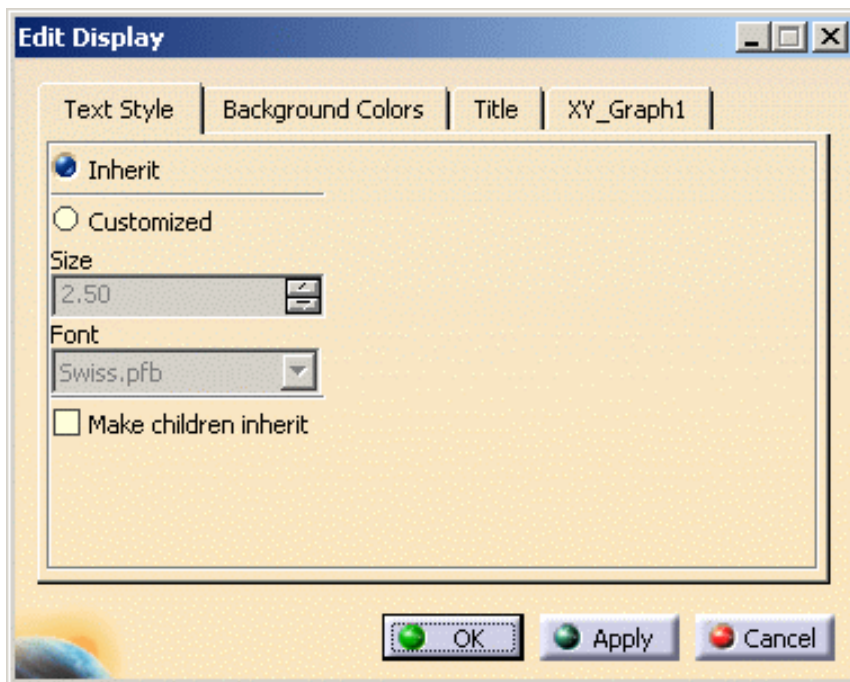

- **Text Style tab:**
  - **Inherit**
  - **Customized:** lets you customize the style of the all the text elements of the 2D Display document. You can change the **Size** and the **Font** of all these elements.
  - **Make children inherit**
- **Background Colors tab:**
  - **Display Area:** lets you choose the display area color. You can choose to have no background color (**No background**) or have a background color (**Include background** and **Choose color**).
  - **Graph Area:** lets you choose the graph area color. You can choose to have no background color

(**No background**) or have a background color (**Include background and Choose color**).

- **Restore Defaults:** lets you restore the default parameters.
  - **Title:** for more details, please click [here](#).
  - **XY\_Graph1 tab:**
    - **Units: MKS, Data Defined, Options Defined**
    - **Interpretation: Default**
    - **OrientationLabel: Default (XY), YX**
- 2.** Select the desired parameters.
- 3.** Click **OK** in the Edit Display dialog box.



## Editing Graph Parameters

You will see here how to edit the graph.



- 1.** Right-click the graph area.

The following contextual menus are available.

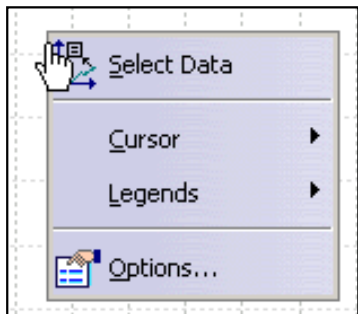

- **Select Data:** lets you access to the Select Data dialog box.  
For more details, please refer to [Generating a 2D Display for Dynamic Response Solution](#).
- **Cursor:** lets you visualize a value corresponding to a particular abscissa or a particular ordinate.
  - **Single X:**

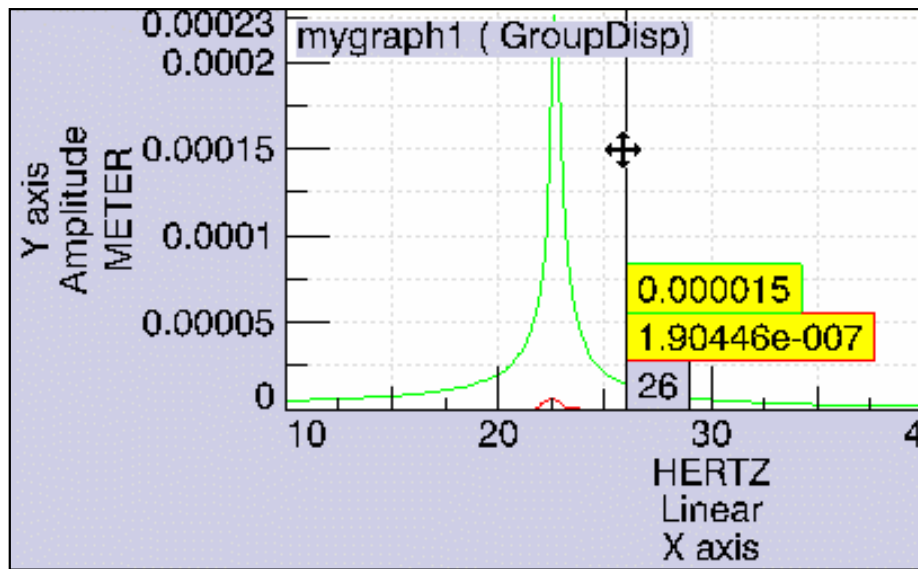

■ **Double X:**

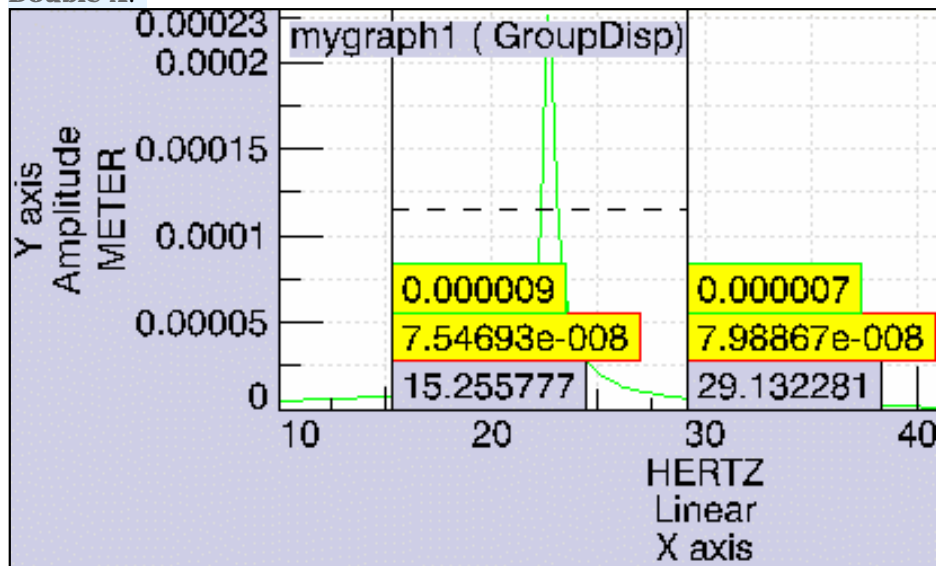

■ **Single Y:**

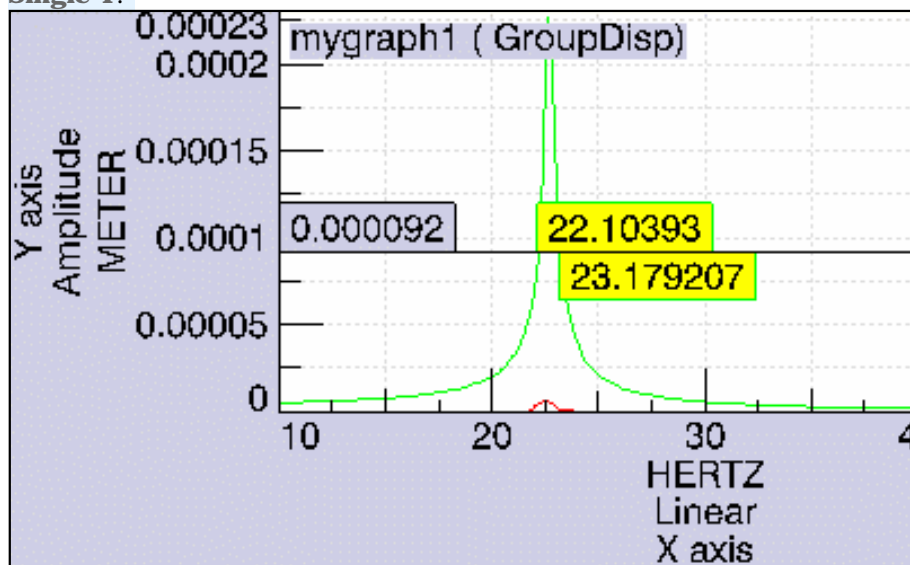

- **Legends:** lets you hide or show the graph legend.
- **Options...:** lets you access the Edit Graph dialog box.  
You can also double-click the plot to access the Edit Graph dialog box.

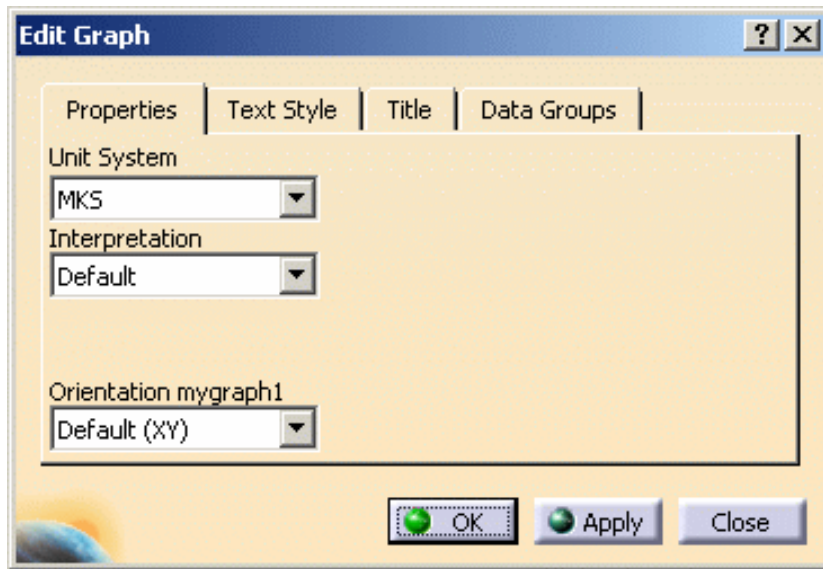

2. Select the desired parameters.
3. Click **OK** in the Edit Display dialog box.





# Export Data



This task shows you how to transfer image content (coordinates, values, axis system if needed) into a .txt or .xls file. This can be performed in the case of hybrid or non-hybrid models.



Only available with the **ELFINI Structural Analysis (EST)** product.



The Export Data contextual menu is not available for the **Mesh** and **Deformed Mesh** images.

This contextual menu is valid only for images with the following positions:

- node
- element
- center of element
- node of element



Open [sample35.CATAnalysis](#) document from the samples directory for this task.



**1.** Right-click the image feature in the specification tree.

**2.** Select the **Export Data** contextual menu



The Export Data dialog box appears, which lets you define the desired directory, name and type of the file to be generated.

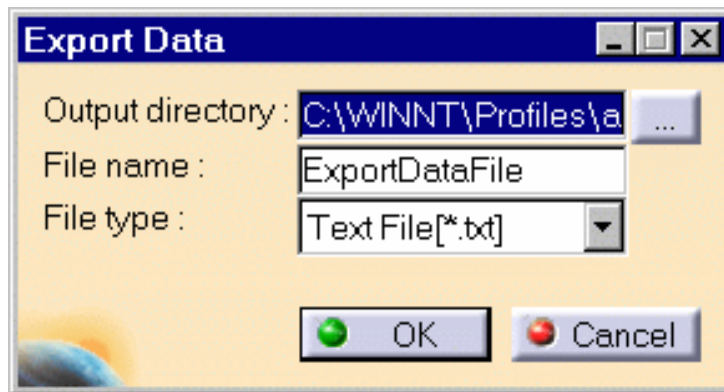

- **Output directory:** you can select the directory in which the data will be exported.

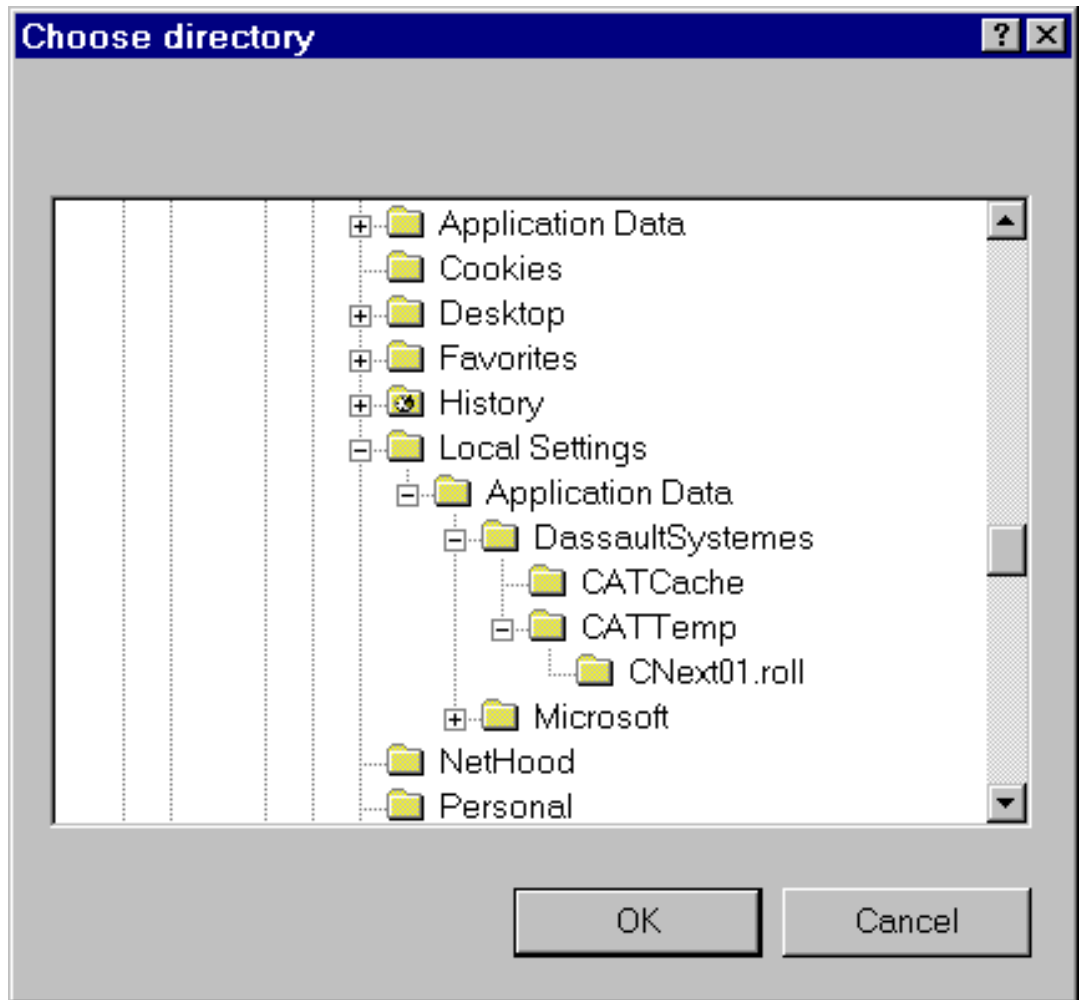

- **File name:** You can choose the desired file name.
- **File type:** The file type can be either .txt or .xls.



3. Click **OK** in the Export Data dialog box.

The file appears as shown here:

- x, y and z values
- values previously assigned to the image via the Filter operation.

x(mm)	y(mm)	z(mm)	ALL(N_m2)
110.504	4.3728	-10.6676	10
128	4.3728	-0.000735787	10
97.8754	4.3728	-6.18202	10
97.8754	4.3728	6.18202	10
110.504	4.3728	10.6676	10
123	4.3728	-0.000735787	10
110	5.3728	-0.000735787	10
117.903	4.3728	-11.8481	10
101.423	4.3728	-7.06308	10
97.8754	4.3728	-1.53657	10
97.8754	4.3728	2.04118	10
103.878	4.3728	7.83804	10
117.903	4.3728	11.8481	10
116.213	5.3728	5.99624	10
114.886	5.3728	-5.8957	10
103.086	4.3728	-0.408872	10
125.133	4.3728	-7.78372	10



The exported data (for example, the number of the nodes) depends on

- the Selection elements that you chose to visualize on a generated image
- whether you activated or not the **on boundary** option from the Color Map Editor dialog box (displayed when double clicking on the color palette).



# Analysis Application Interoperability

This section will show you how to work with analysis data stored in ENOVIA.

[VPM Navigator Interoperability](#)

[ENOVIAVPM / CATIA V5 Analysis Integration](#)

# VPM Navigator Interoperability



This section deals with the interoperability between the analysis data and the VPM Navigator product.

## Retrieving Pointed Documents of an Analysis File





### Data-Mapping

### Analysis Impact Graph

## Synchronizing Documents with Versioned Parts or Products

You can find in the following table the VPM Navigator functionalities supported in an analysis context (depending on the analysis pointed document):

Pointed Documents of Analysis File	VPM Navigator functionalities					
	Document Storage	Document Renaming	Document Reading	Update Status	Impact Graph	Synchronization on version
CATPart						
CATProduct (Work Package)						
CATProduct (Explode)						- *
External Storage						-

Data Mapping					-	
Analysis Assembly	-	-	-	-	-	-

\* a product saved in Explode mode cannot be versioned, but the parts that are pointed by the product can be versioned.

For more details, please refer to [Synchronizing Documents with Versioned Parts and Products](#).



For more details about the VPM Navigator product, please refer to the *VPM Navigator User's Guide*.

# Retrieving Pointed Documents of an Analysis File



This task will show you how to work with analysis data stored in ENOVIA, using VPM Navigator.

You will see how to retrieve pointed document of a CATAnalysis file.

You will create an analysis from a product saved in ENOVIA either in Work Package mode or in Explode mode.



For more details about the VPM Navigator product, please refer to the *VPM Navigator User's Guide*.



1. Connect your session to ENOVIA.
2. Load a product stored in ENOVIA.

In this example, choose a product that has been saved in ENOVIA in Work Package mode.

3. Enter the Generative Structural Analysis workbench.

For this, select the **Start -> Analysis & Simulation -> Generative Structural Analysis** menu.

4. Click **OK** in the New Analysis Case dialog box.
5. Define the analysis specifications.

For example, define the restraint set and the load set, apply a analysis connection property to an assembly constraint, and finally perform a compute execution.

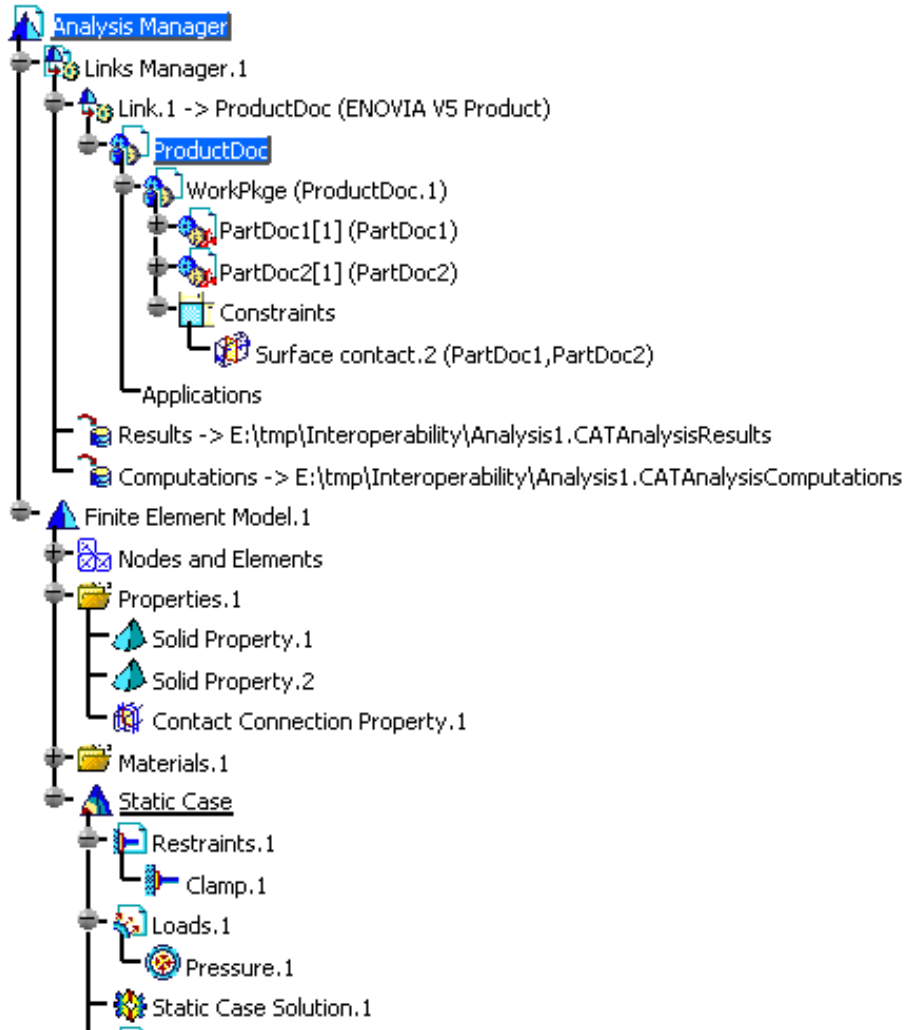

6. Save the analysis document in ENOVIA.



An analysis document can only be saved in Work Package mode.

For this, click the **Save data in Enovia V5** icon.

The following dialog box appears:

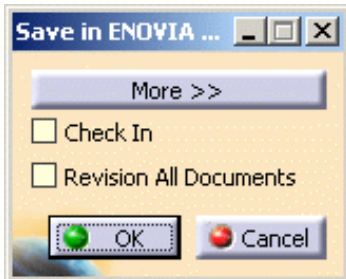

Select the **More >>** button.

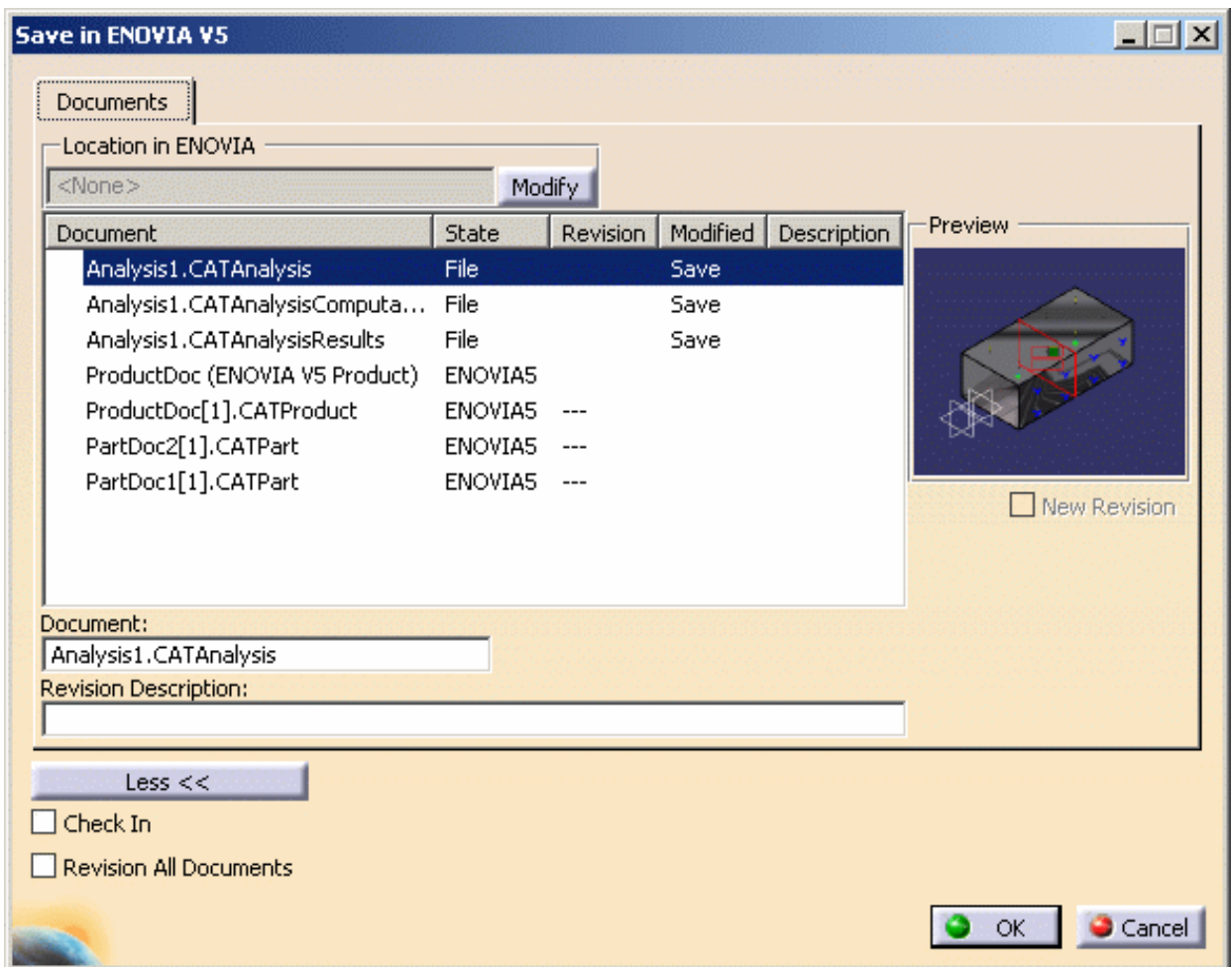

7. Click **OK** in the Save in ENOVIA V5 dialog box.

8. Close the analysis document.

9. Load your analysis data stored in ENOVIA.



Click the **Search ENOVIA data** icon and launch the search.

10. Right-click the analysis you want to load in the Search Result dialog box and select the **Open** contextual menu.

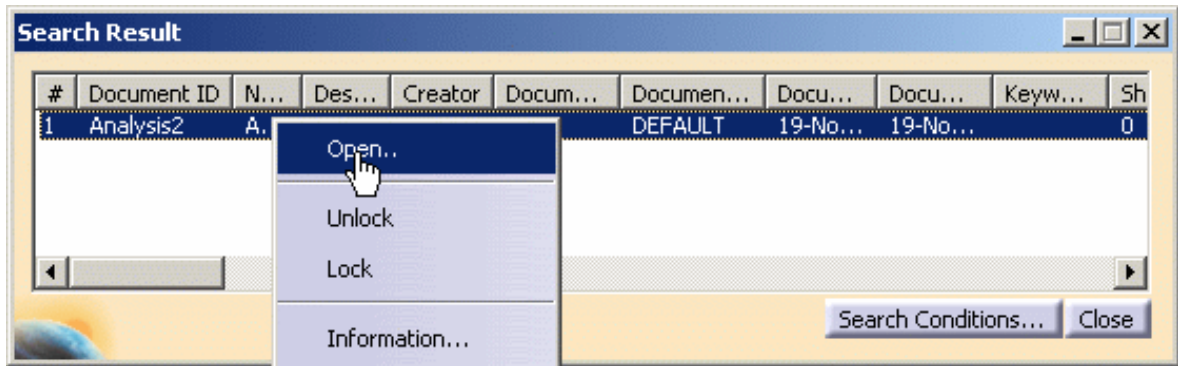

The Open Modes dialog box appears.

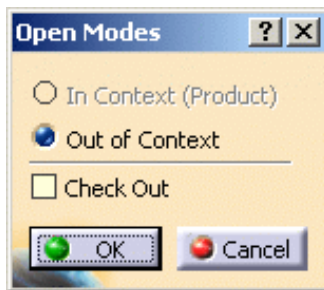

11. Select the **Out of context** option and click **OK** in the Open Modes dialog box.

Note that you retrieve all the analysis specifications and the updated status you saved in the analysis document. Moreover, the referenced CATProduct, CATAnalysisResults and CATAnalysisComputations files become ENOVIA V5 documents.

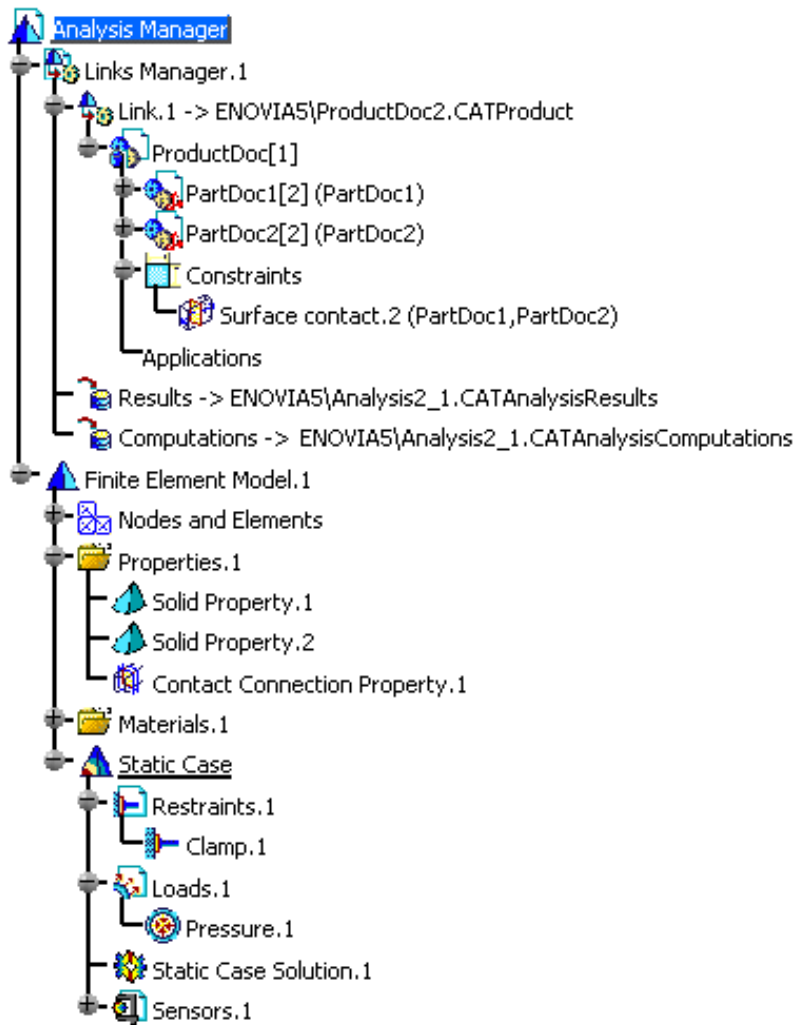

# Data-Mapping

You will see here how to work with analysis data-mapping files stored in ENOVIA.

To modify a data-mapping file (.xls) stored in ENOVIA, you have to work with ENOVIA LCA:

- search the data-mapping file (.xls file)
- check-out the data-mapping file
- modify the data-mapping file
- check-in the data-mapping file



To know more, please refer to the *ENOVIA / CATIA Interoperability User's Guide - Checking-in an ENOVIA LCA Document*.



# Analysis Impact Graph



This task will show you how to use the analysis impact graph. The analysis impact graph allows you to visualize the exposure of dependency links in ENOVIA V5.



The analysis graph depends on the save mode of the pointed product (Work Package mode or explode mode).

You will see here how to use the **Impacted by** and **Impacts on** functionalities in an analysis document pointing:

- a CATPart file
- a CATProduct file saved in Work Package mode
- a CATProduct file saved in Explode mode



For more details about the Impact Graph, please refer to the *VPM Navigator User's Guide*.

## Analysis Document Pointing a .CATPart File

In the specification tree, you will find a CATAnalysis links to a CATPart document, a CATAnalysisResults file and a CATAnalysisComputations file:

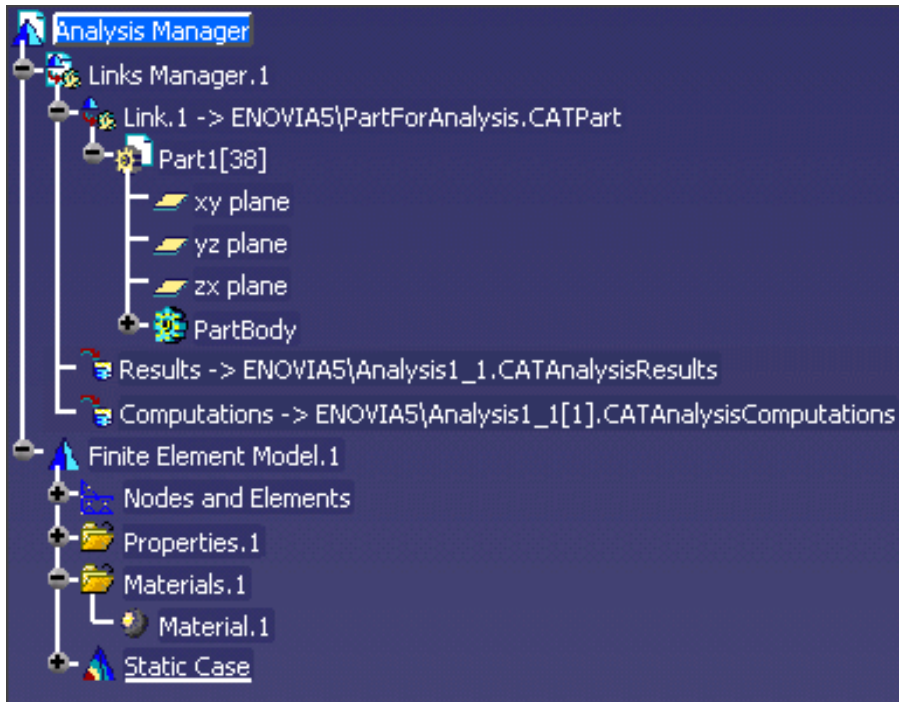

The analysis impact graphs looks like:

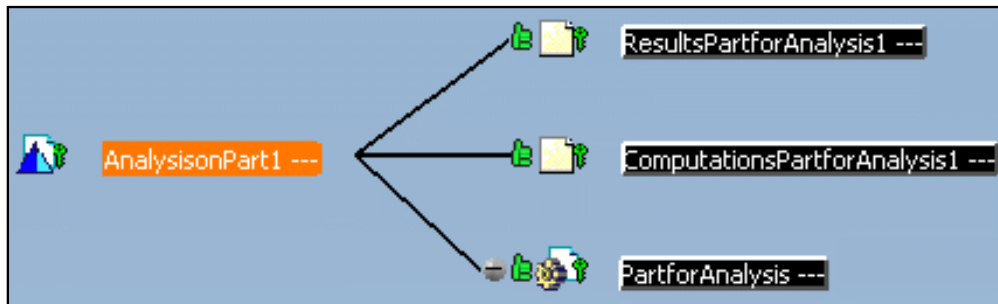

All the dependency links between analysis document and part, results and computations documents are valid.

The type of these links are document/document.



## Analysis Document Pointing a .CATProduct File Saved in Work Package Mode

In this case, the analysis document points at a product saved in Work Package mode. This product points at two parts.

The analysis impact graph looks like:

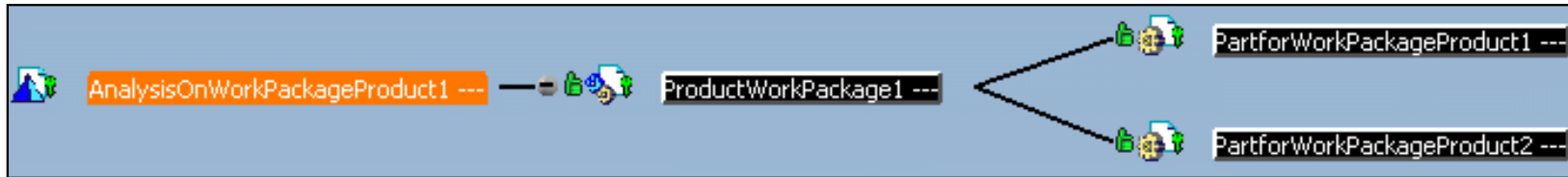

The type of these links are document/document.



## Analysis Document Pointing a .CATProduct File Saved in Explode Mode

In this case, the analysis document points at a product saved in Explode mode. This product points at two parts.

The analysis impact graph looks like:

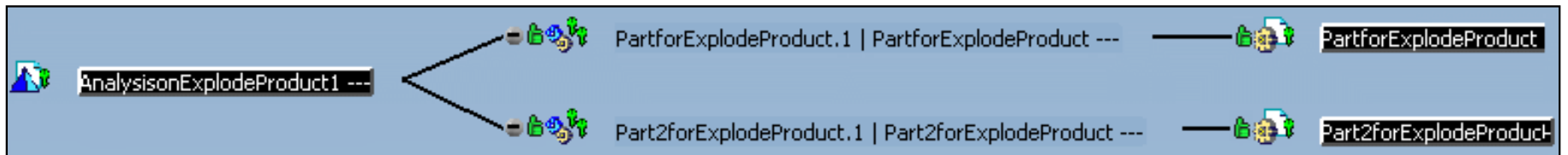

Note that you can visualize the part instance. The type of these links are document/instance.





# Synchronizing Documents with Versioned Parts or Products



This task will show you how to manually synchronize an analysis document with versioned parts and products.



For more details about the *VPM Navigator* product, please refer to the *VPM Navigator User's Guide*.



1. Save in ENOVIA V5 an analysis document pointing at parts and products.
2. Modify a pointed document (part or product) and create a new version of this document using the **Save in ENOVIA V5** functionality.



- You can create new versions of parts and products saved in Work Package mode.
  - If you create a new version of a part belonging to product saved in Explode mode, the product will be automatically synchronize with this last version and so, the analysis document will be automatically synchronize.
3. Open the analysis document from the *VPM Navigator* product.
  4. Select the **Edit -> Links** menu.
  5. Select the **Pointed Documents** tab.
  6. Click the **Synchronize to last version** button.

The analysis document is synchronized with the last existing version.





# ENOVIAVPM / CATIA V5 Analysis Integration

 This task will show you how to work (modify, save and manage) with a **.CATAnalysis** document in ENOVIAVPM context.

Usually, to save a document in ENOVIAVPM, you have to use the **Set PDM Properties** functionality, except with **.CATAnalysis** documents.

 For more details about ENOVIAVPM, please refer to the *VPM User's Guide*.

 You have to launch an ENOVIAVPM session, and if needed, connect your CATIA session to ENOVIAVPM.

-  **1.** Send to CATIA V5 a **.CATPart** or a **.CATProduct** document from the Virtual Product Model Access dialog box.
- 2.** Enter the Generative Structural Analysis workbench.

For this, select the **Start -> Analysis & Simulation -> Generative Structural Analysis** menu.

- 3.** Click **OK** in the New Analysis Case dialog box.
- 4.** Apply the desired specifications (restraints and loads).
- 5.** Save the analysis document in ENOVIAVPM.

For this, click the **Create and Save** icon in the Virtual Product Model Access dialog box.

A new VPM Part with the provided part number is created.

 Do not use the **Set PDM Properties** functionality to save the **.CATAnalysis** document in ENOVIAVPM.  
Always use the **Create and Save** functionality.

- 6.** Compute the document.
- 7.** If needed, clear computation data.
- 8.** Rename the **.CATAnalysisResults** (and **.CATAnalysisComputations**) file(s).

For this, click the **Storage Location** icon  from the **Solver Tools** toolbar (or double-click them in the specification tree).

 Do not use the **Set PDM Properties** functionality to rename the **.CATAnalysisResults** (and **.CATAnalysisComputations**) document(s) in ENOVIAVPM.  
Always use the **Storage Location** functionality to rename these files.

- 9.** Click the **Set PDM Properties** icon  from the **ENOVIAVPM** toolbar



Each pointed document appears in the dialog box.

- 10.** Select the pointed documents you want to save in ENOVIAVPM.



For each pointed document, select the appropriate VPM database environment in **Doc Env** (please refer to your VPM administrator).

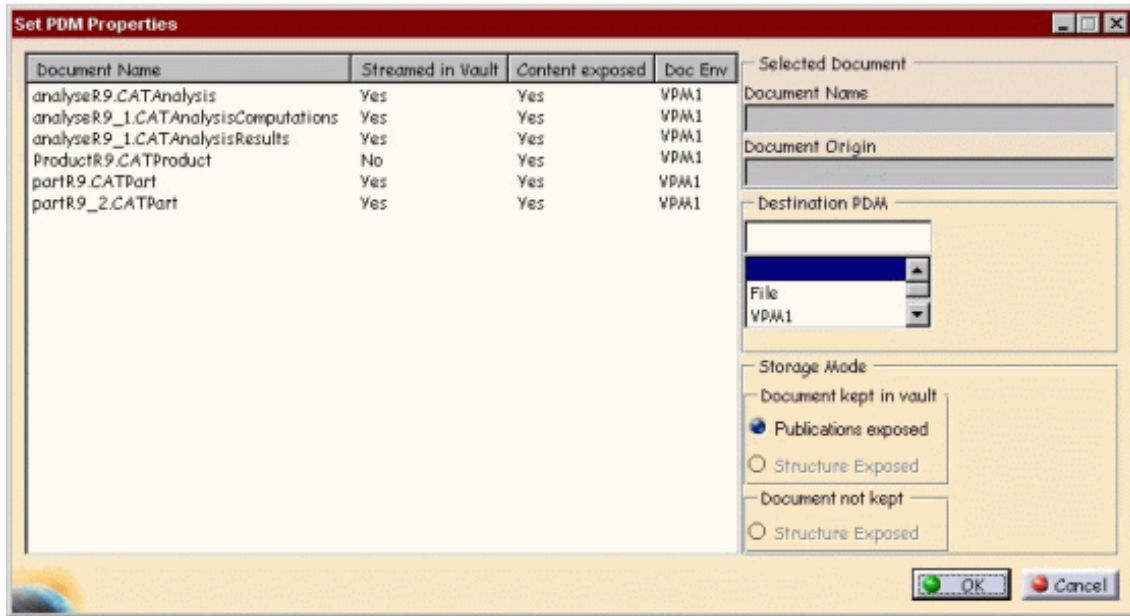

When saving assemblies containing applicative data (such as Analysis Connection), make sure the **Publication exposed** option is selected.

11. Select the **File -> Save All** menu to store all modified or created data in ENOVIAVPM.
12. Refresh the view in ENOVIAVPM.

Newly created VPM parts and documents now appear.

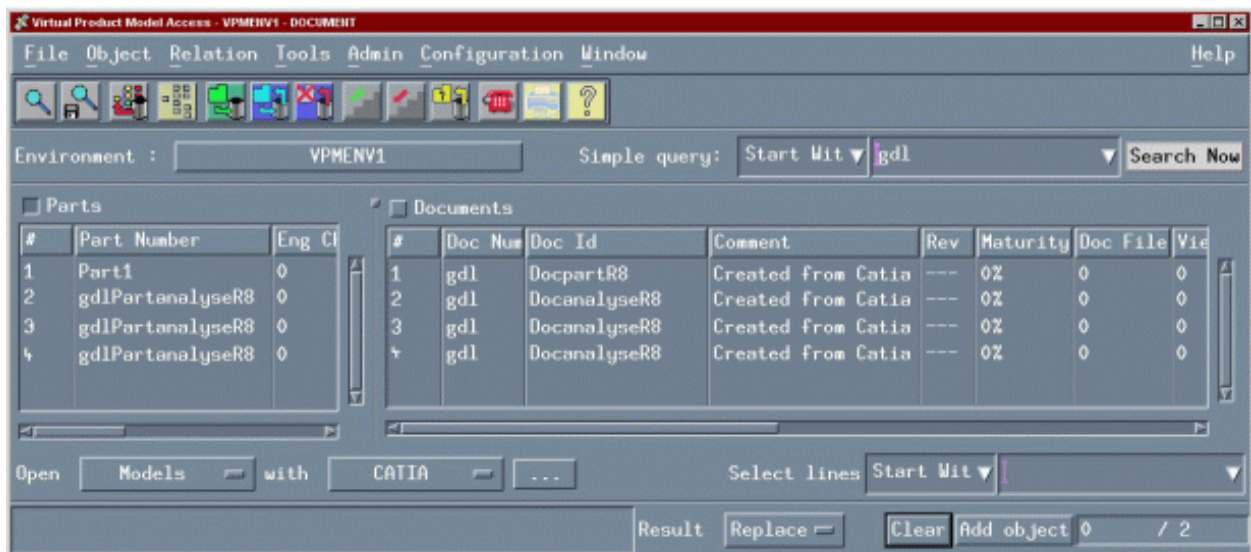

13. Close the current analysis document in CATIA.
14. Open the CATAnalysis document you saved from ENOVIAVPM.

The previously saved CATAnalysis document is loaded in CATIA, updated and appears with the corresponding results if any.

# Workbench Description

This section contains the description of the icons and menus which are specific to this workbench.

You can click the sensitive areas on this image to see related documentation.

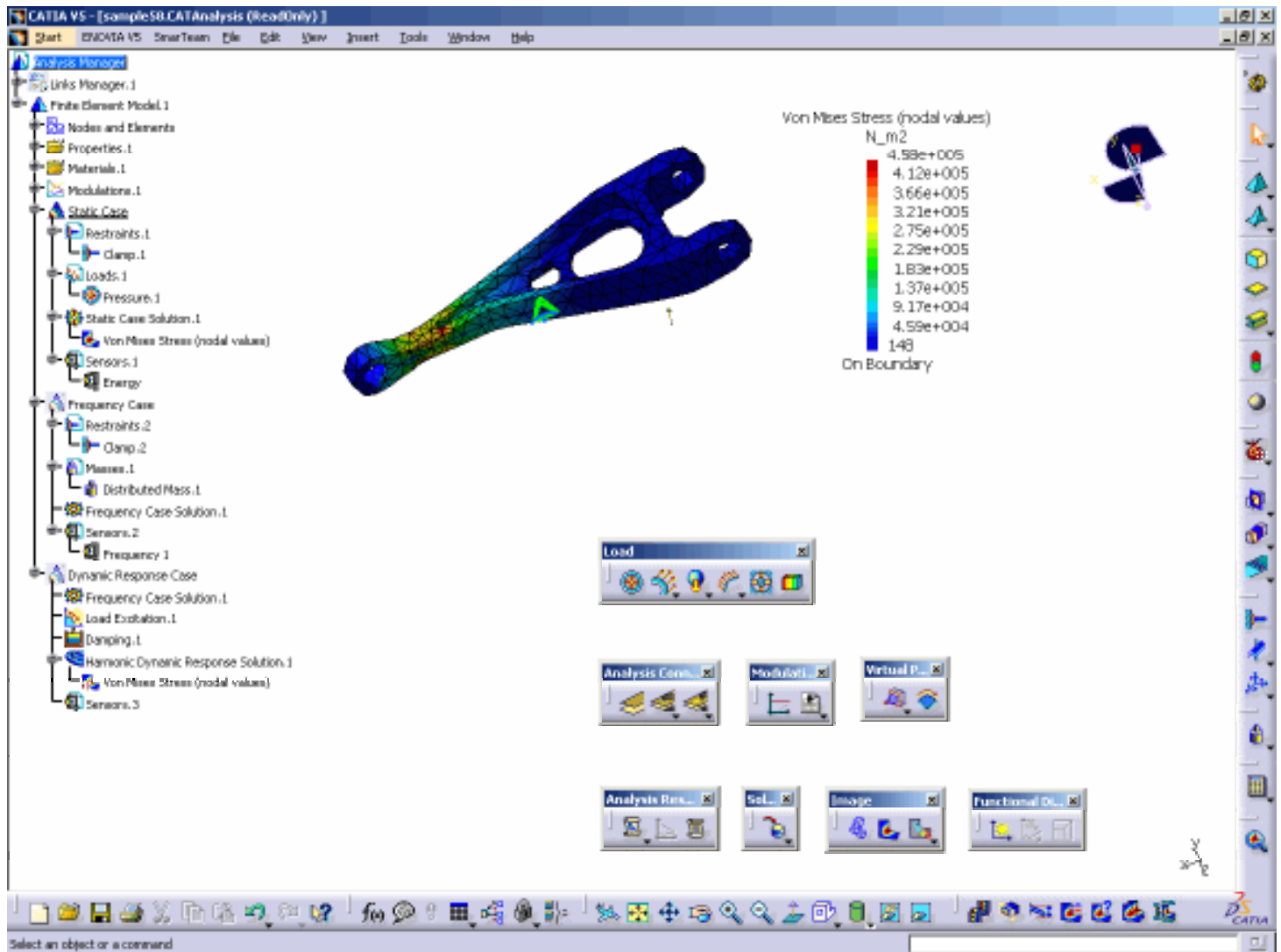

Generative Structural Analysis Menu Bar

Model Manager Toolbar

Adaptivity Toolbar

Modulation Toolbar

Groups Toolbar

Analysis Connections Toolbar

Connection Toolbar

Analysis Assembly Toolbar

Virtual Part Toolbar

Mass Toolbar

Restraint Toolbar

Load Toolbar

Compute Toolbar

Solver Tools Toolbar

Image Toolbar  
Analysis Tools Toolbar  
Analysis Results Toolbar  
Analysis Symbol

# Generative Structural Analysis Menu Bar

The Menu Bar and most of the items available in Generative Structural Analysis workbench are the standard ones. The different commands and tools are described in the *Infrastructure Version 5 User's Guide*.

For more information, please refer to the standard Menu Bar section.

However, the **Insert** menu is specific to the Generative Structural Analysis workbench.

# Model Manager Toolbar

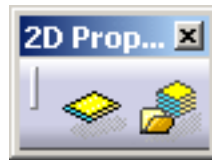
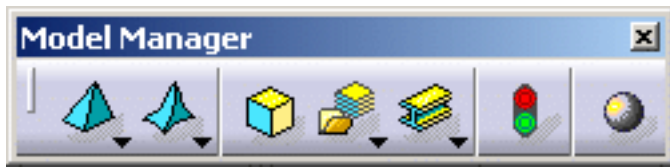

## Mesh Creation



See [Creating 3D Mesh Parts](#)



See [Creating 2D Mesh Parts](#)



See [Creating 1D Mesh Parts](#)

## Mesh Specification



See [Creating Local Mesh Sizes \(Element Type\)](#)



See [Creating Local Mesh Sizes](#)



See [Creating Local Mesh Sags](#)

## Mesh Property



See [Creating 3D Properties](#)



See [Creating 2D Properties](#)



See [Importing Composite Properties](#)



See [Creating 1D Properties](#)



See [Creating Imported Beam Properties](#)

### **Check**



See [Checking the Model](#)

### **Isotropic Material**



See [Creating User Materials](#)

# Adaptivity Toolbar



See [Creating Global Adaptivity Specifications](#)

# Modulation Toolbar



See [Creating White Noise Modulation](#)

## **Import Modulation**



See [Importing Frequency Modulation](#)



See [Importing Time Modulation](#)



# Groups Toolbar



## Geometry Groups



See [Grouping Points](#)



See [Grouping Lines](#)



See [Grouping Surfaces](#)



See [Grouping Bodies](#)

## Free Groups



See [Box Group](#)



See [Sphere Group](#)

## Proximity Groups



See [Grouping Point by Neighborhood](#)



See [Grouping Line by Neighborhood](#)



See [Grouping Surface by Neighborhood](#)

# Analysis Connections Toolbar



See [General Analysis Connection](#)



See [Point Analysis Connection](#)



See [Point Analysis Connection Within One Part](#)



See [Line Analysis Connection](#)



See [Line Analysis Connection Within One Part](#)



See [Surface Analysis Connection](#)



See [Surface Analysis Connection Within One Part](#)

# Connection Toolbar



## Face Face Connections



See [Slider Connection Properties](#)



See [Contact Connection Properties](#)



See [Fastened Connection Properties](#)



See [Fastened Spring Connection Properties](#)



See [Pressure Fitting Connection Properties](#)



See [Bolt Tightening Connection Properties](#)

## Distant Connections



See [Rigid Connection Properties](#)



See [Smooth Connection Properties](#)



See [Virtual Rigid Bolt Tightening Connection Properties](#)



See [Virtual Spring Bolt Tightening Connection Properties](#)



See [Customized Distant Connection](#)

## **Welding Connections**



See [Spot Welding Connection Properties](#)



See [Seam Weld Connection Properties](#)



See [Surface Weld Connection Properties](#)



# Analysis Assembly Toolbar



See [Analysis Assembly 2D Viewer](#)

# Virtual Part Toolbar



See [Creating Rigid Virtual Parts](#)



See [Creating Smooth Virtual Parts](#)



See [Creating Contact Virtual Parts](#)



See [Creating Spring Virtual Parts](#)



See [Creating Smooth Spring Virtual Parts](#)



See [Periodicity Conditions](#)



# Mass Toolbar



See [Creating Distributed Masses](#)



See [Creating Line Mass Densities](#)



See [Creating Surface Mass Densities](#)



See [Inertia on Virtual Part](#)



# Restraint Toolbar

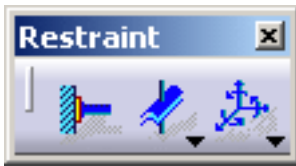

See [Creating Clamps](#)

## **Mechanical Restraint**



See [Creating Surface Sliders](#)



See [Creating Ball Joints](#)



See [Creating Sliders](#)



See [Creating Pivots](#)



See [Creating Sliding Pivots](#)

## **Advanced Restraint**



See [Creating Advanced Restraints](#)



See [Creating Iso-Static Restraints](#)



# Load Toolbar



See [Creating Pressures](#)



See [Creating Enforced Displacements](#)

## Force



See [Creating Distributed Forces](#)



See [Creating Distributed Moments](#)



See [Creating Distributed Bearing Loads](#)



See [Importing Forces](#)



See [Importing Moments](#)



## Acceleration



See [Creating Accelerations](#)



See [Creating Rotation Forces](#)

## Force Density



See [Creating Line Force Densities](#)



See [Creating Surface Force Densities](#)



See [Creating Volume Force Densities](#)

## **Temperature**



See [Creating Temperature Field](#)



See [Importing Temperature Field from Thermal Solution](#)

# Compute Toolbar



See [Computing Objects Sets](#)

See also [Computing Static Solutions](#)

[Computing Static Constrained Solutions](#)

[Computing Frequency Solutions](#)

[Computing Buckling Solutions](#)

[Computing Dynamic Response Solutions](#)



See [Computing with Adaptativity](#)

# Solver Tools Toolbar

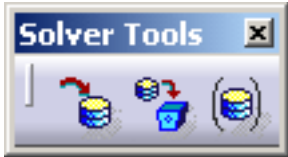

See [Specifying External Storage](#)



See [Clearing External Storage](#)



See [Specifying Temporary Data Directory](#)

# Image Toolbar



See [Visualizing Deformations](#)



See [Visualizing Von Mises Stresses](#)

## **Other Images**



See [Visualizing Displacements](#)



See [Visualizing Principal Stresses](#)



See [Visualizing Precisions](#)

# Analysis Tools Toolbar



See [Animating Images](#)



See [Cut Plane Analysis](#)



See [Amplification Magnitude](#)



See [Extrema Detection](#)



See [Information](#)



See [Images Layout](#)



See [Simplifying Representation](#)



# Analysis Results Toolbar



See [Reporting](#)



See [Advanced Reporting](#)



See [Historic of Computation](#)



See [Elfini Listing](#)

# Analysis Symbol

A CATAnalysis file is composed of:

1. **Links Manager**, which references the part or the product to be analyzed.
2. **Connection Design Manager**, which contains the analysis design connections.
3. **Finite Element Model**, which contains the specifications of finite element model.



## Analysis Manager



### Links Manager

The **Links Manager** gives you the directory path and the main information on the linked documents or files.

- Product
- Part
- Results and Computations: gives you the directory path of the CATAnalysisComputations and the CATAnalysisResults files .



### Connection Design Manager

The **Connection Design Manager** is composed of:



General Design Connection



Point Design Connection



Point Design Connection within one Part



Line Design Connection



Line Design Connection within one Part





## Finite Element Model

The **Finite Element Model** is composed of:



Nodes and Elements



Properties



Modulation



Group



Analysis Case

# Customizing



This section describes the different type of setting customization you can perform in the Analysis workbenches using the **Tools -> Options...** submenu.

This type of customization is stored in permanent setting files: these settings will not be lost if you end your session.



1. Select the **Tools -> Options...** submenu.

The Options dialog box appears.

2. Select the **Analysis and Simulation** category.

The following tab appears:

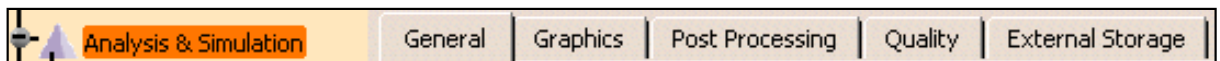

These tabs lets you define the:

- o [general settings](#)
- o [graphic settings](#)
- o [post processing settings](#)
- o [quality settings](#)
- o [external storage settings](#)

3. Change the desired parameters.
4. Click **OK** in the Options dialog box when done.



# General



This task explains how to customize Analysis and Simulation general settings.

The General tab deals with the following settings:

- [Default Analysis Case](#)
- [Specification Tree](#)

## Default Analysis Case

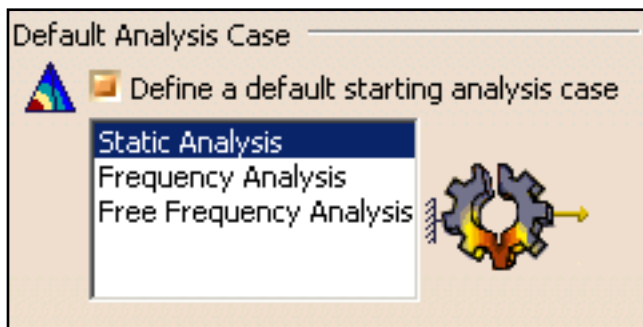

## Define a default starting analysis case

This option lets you define a default analysis case that will be inserted each time you enter the Generative Structural Analysis workbench or the Advanced Meshing Tools workbench.

Before defining a default analysis case using **Tools->Options** command, make sure you started the Analysis & Simulation (Generative Structural Analysis or Advanced Meshing Tools) workbench at least once.

The default starting analysis case is Static Analysis. You can decide that the new default case will be:

- **Static Analysis**
- **Frequency Analysis**
- **Free Frequency Analysis**



The cases will only be displayed if an analysis workbench has been loaded at least once because the listed cases are linked to the Analysis workbenches last loaded.

 By default, this option is deactivated.

## Specification Tree

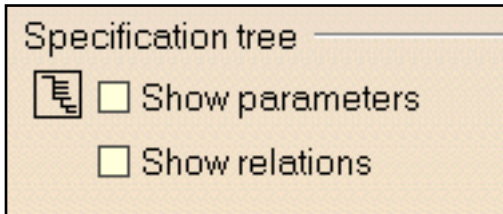

### Show parameters

This option lets you display parameters in the specification tree.

 By default, this option is deactivated.

### Show relations

This option lets you display relations in the specification tree.

 By default, this option is deactivated.

# Graphics



This page deals with the following options:

- [Nodes](#)
- [Elements](#)

## Nodes

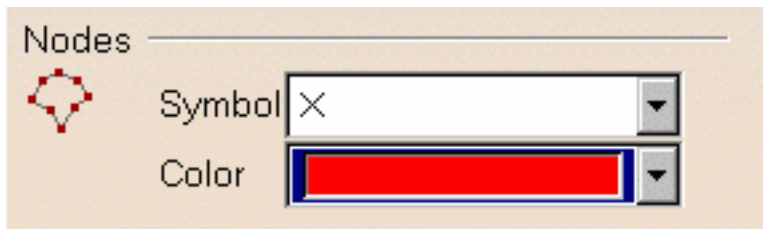

This option lets you select the symbol and color you wish to assign to the nodes.

## Elements

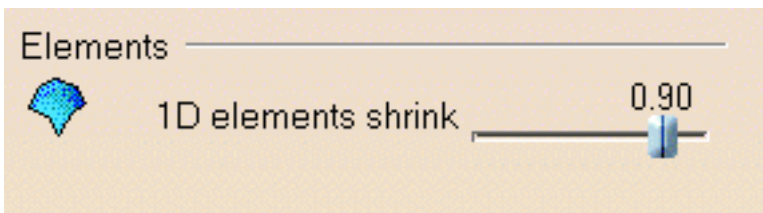

This option lets you define the shrink of 1D elements.

# Post Processing



This task explains how to customize Analysis and Simulation post processing image settings.

- [Save as new template](#)
- [Image edition](#)

## Save As New Template Folder

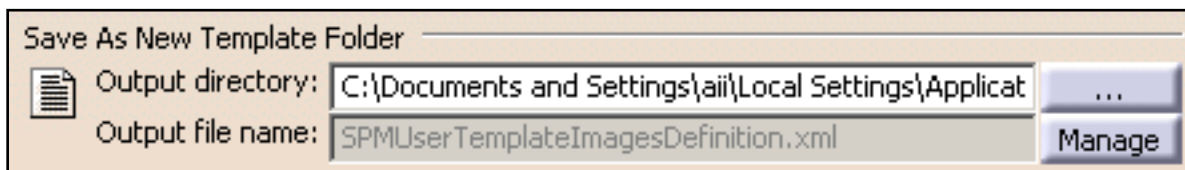

You can define the location of the **SPMUserTemplateImageDefinition.xml** file or manage this file.

This file contains all the generated images that have been saved with the **Save As New Template** contextual menu.

### Output directory

This option lets you choose the directory in which you want to store the **.xml** file.

 By default, this field is empty.

### Output file name

This option indicates the name of the associated **.xml** file. You can rename or remove the stored images.



Images must have been saved with the **Save As New Template** contextual menu and a **.CATAnalysis** document must be launched (in the opposite case, the **Manage** button is not available).

If you click the **Manage** button, the Available Images dialog box appears.

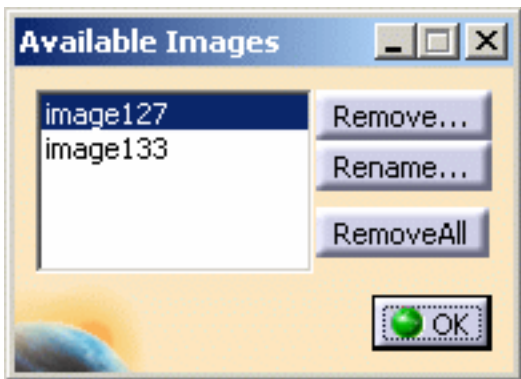

- **Remove...:** lets you remove the selected images (multi-selection is available).
- **Rename...:** lets you rename a selected image.



- **Remove All:** lets remove all the images that are stored in the xml file.



All modifications are updated only if you click **OK** in the Options dialog box.

For example: if you change the path directory after managing images and without clicking **OK** in the Options dialog box, your modifications are not preserved.



# Image Edition



## Automatic preview mode

This option lets you preview automatically the changes you done in the Image Edition dialog box.

If this option is deactivated, the **Preview** button will be available in the Image Edition dialog box: the visualization will be launched only if you click the **Preview** button.

 By default, this option is activated.



# Quality



This page deals with the following options:

- [Export Default Directory](#)
- [Default Standard File](#)
- [Quality Criteria](#)

## Export Default Directory



This option lets you define the default directory in which the criteria configuration have been saved.

👉 By default, the **Export Default Directory** field is empty.



While a default directory is not defined, you cannot use the **Export Criteria** option in the **Quality Analysis** functionality in the Advanced Meshing Tools workbench (for more details, please refer to the *Advanced Meshing Tools User's Guide - Analyzing Element Quality*).

## Default Standard File





This option lets you define the list of quality criteria that will be used by default.

👉 By default, the **Default Standard File** field is empty and so all the **Quality Criteria** are taken into account.



# Quality Criteria



Quality Criteria

Criteria		
<input type="checkbox"/> Taper	0.5	0.7
<input type="checkbox"/> Skewness	0.7	0.9
<input type="checkbox"/> Distortion	35	45
<input type="checkbox"/> Jacobian	0.2	0
<input type="checkbox"/> Warp Factor	5	10
<input type="checkbox"/> Warp Angle	30	60
<input type="checkbox"/> Skew Angle	60	30
<input type="checkbox"/> Stretch	0.3	0.1
<input type="checkbox"/> Min. Length	0.0001	1e-006
<input type="checkbox"/> Max. Length	10000	1e+005
<input type="checkbox"/> Shape Factor	0.3	0.1
<input type="checkbox"/> Length Ratio	5	10

This frame lets you visualize the quality criteria that are taken into account and their limit values between:

-  good and poor elements
-  poor and bad elements

 By default, all the **Quality Criteria** are taken into account.

The limit values change as you define the **Default Standard File** option.

# External Storage



This page deals with the following options:

- [Default CATAnalysisResults File Folder](#)
- [Default CATAnalysisComputations File Folder](#)
- [Default Temporary External Storage Folder](#)
- [Computations Data Management on Save](#)
- [File Name Management on Save](#)

## Default CATAnalysisResults File Folder

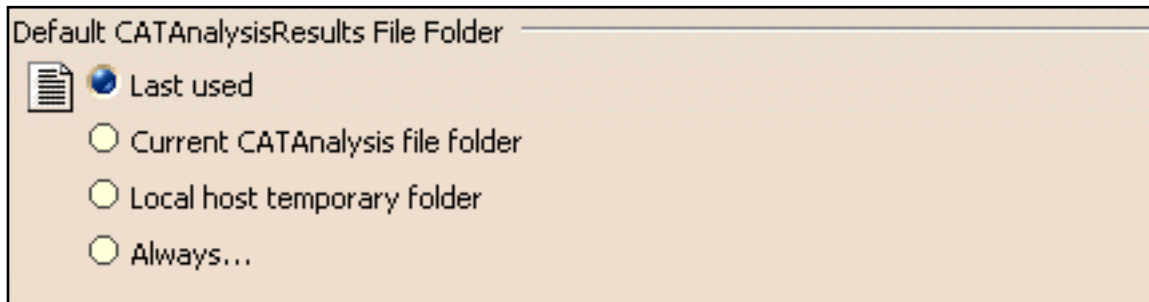

This option lets you change the default directory location of the CATAnalysisResults file.

- **Last used:** lets you choose the last selected default directory location (CATSettings).
- **Current CATAnalysis file folder:** lets you choose the same default directory as the current CATAnalysis directory.
- **Local host temporary folder:** lets you choose the temporary directory.
- **Always...:** lets you define a default directory that will be always the same. You have to define the path directory.

 By default, the **Last used** option is activated.

# Default CATAnalysisComputations File Folder

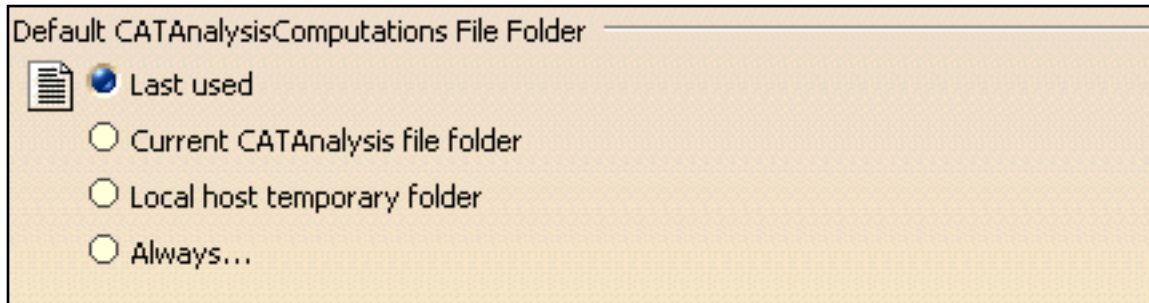

This option lets you change the default directory location of the CATAnalysisComputations file.

- **Last used:** lets you choose the last selected default directory location (CATSettings).
- **Current CATAnalysis file folder:** lets you choose the same default directory as the current CATAnalysis directory.
- **Local host temporary folder:** lets you choose the temporary directory.
- **Always...:** lets you define a default directory that will be always the same. You have to define the path directory.

 By default, the **Last used** option is activated.

# Default Temporary External Storage Folder

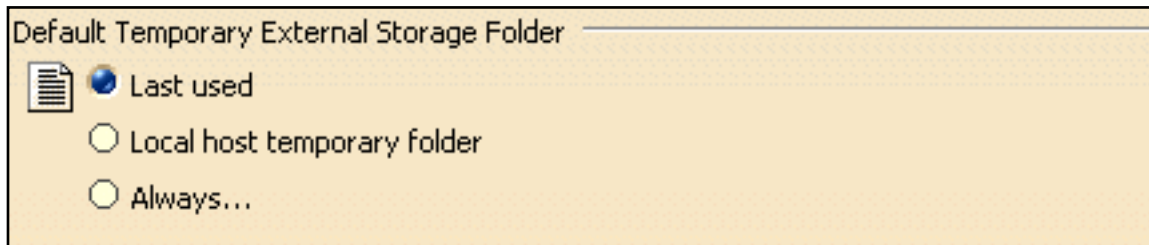

This option lets you specify the default directory location of temporary data.

- **Last used:** lets you choose the last selected default directory location (CATSettings).
- **Local host temporary folder:** lets you choose the temporary directory.
- **Always...:** lets you define a default directory that will be always the same. You have to define the path directory.

 By default, the **Last used** option is activated.

## Computation Data Management on Save

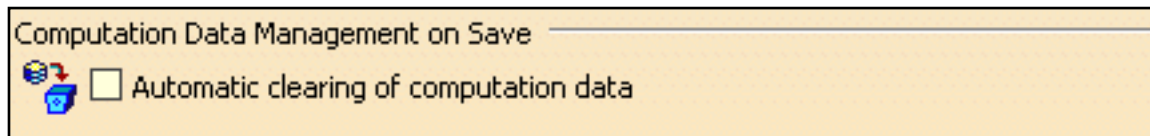

### Automatic clearing of computations data

This option lets you set the automatic clearing of computations data before saving documents.

 By default, this option is deactivated.

## File Name Management on Save

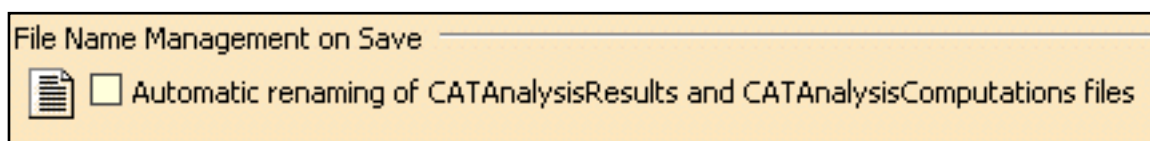

### Automatic renaming of CATAnalysisResults and CATAnalysisComputations files

This option lets you rename automatically the CATAnalysisResults and CATAnalysisComputations files when you save a CATAnalysis document (using the **Save as...** menu or the **Save Management** menu) with the new name of the associated CATAnalysis document.

 By default, this option is deactivated.

# Reference Information

This section provides essential information on the following topics:

[Image Edition](#)

[Advanced Edition for Images and Local Sensors](#)

[Filtering Mesh Parts](#)

[Integration with Product Engineering Optimization](#)

# Image Edition



This task describes the Image Edition dialog box.

The names of the images depend on:

- 1. physical type (for example: **Displacement**)
- 2. visualization type (for example: **Symbol** or **Text**)
- 3. criterion (for example: **Norm** or **Vector component**)



You will find in the following table the available tabs and buttons in the Image Edition dialog box.

	<b>Mono-occurrence solutions</b>	<b>Multi-occurrence solutions</b>
<b>Deformed Mesh image</b> <b>Mesh Visualization image</b>	Mesh Selections Preview	Mesh Selections Occurrences Preview
Other images	Visu Selections More Preview	Visu Selections Occurrences More Preview

## Mesh Tab



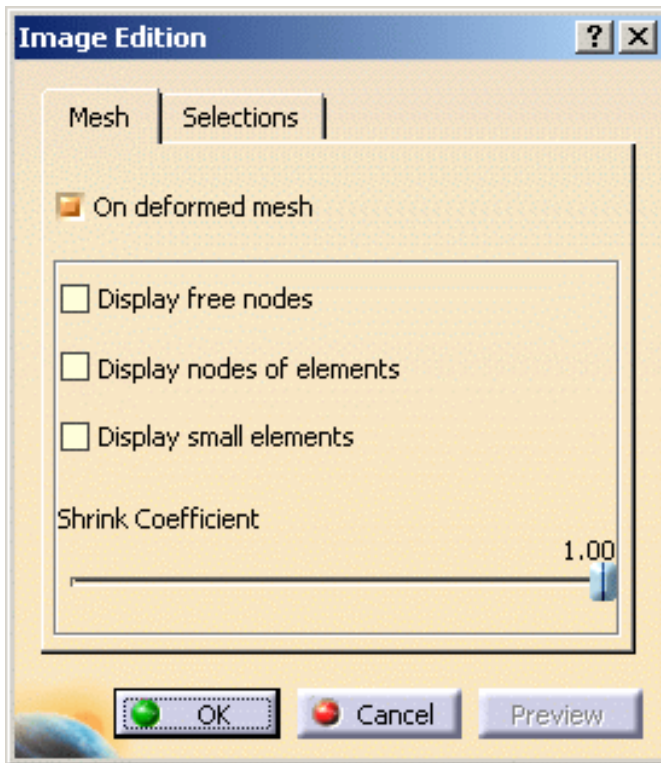

- **On deformed mesh:** lets you visualize results in deformed mode.



In the case of Dynamic Response Analysis Case (Harmonic or Transient) with restraint excitation, you can specify if you want to visualize the image in an absolute axis (Absolute option) or in a relative axis (Relative option).

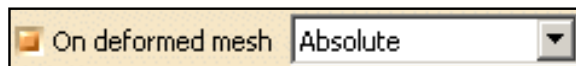

- **Absolute:** lets you visualize both the displacement and the elastic deformation of the part.
- **Relative:** lets you visualize only the elastic deformation of the part.
- **Display free nodes:** lets you display free nodes (nodes that are referenced by any element).
- **Display nodes of elements:** lets you visualize nodes of elements.
- **Display small elements:** lets you choose to display or not the very small elements.
- **Shrink Coefficient:** lets you shrink the element visualization.



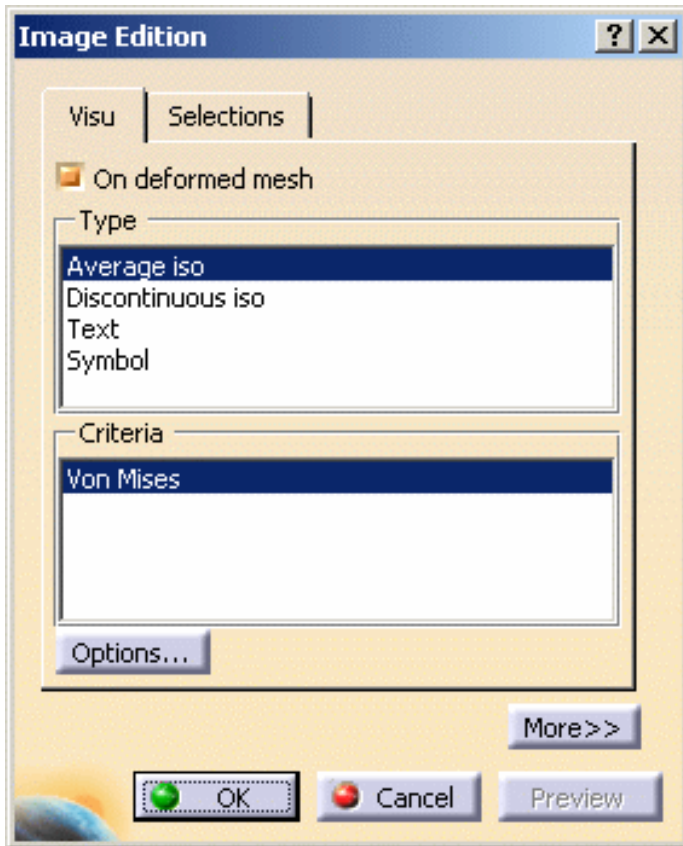



- **On deformed mesh:** lets you visualize the deformation.

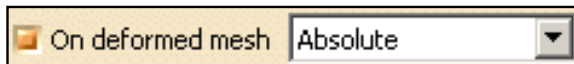

In the case of Dynamic Response Analysis Case (Harmonic or Transient) with restraint excitation, you can specify if you want to visualize the image in an absolute axis (Absolute option) or in a relative axis (Relative option).



- **Absolute:** lets you visualize both the displacement and the elastic deformation of the part.
  - **Relative:** lets you visualize only the elastic deformation of the part.
- **Type:** provides a list with visualization types (*how*). The list of visualization types depends on the selected image.
    - **Average iso:** lets you visualize isolines at nodes.
      -  This visualization type uses the **Material Rendering** capabilities.
    - **Discontinuous iso:** lets you visualize isolines at nodes of element.
      -  This visualization type uses the **Material Rendering** capabilities.
    - **Fringe:** lets you color an element, a face of element or an edge of element according to the scalar value defined for this entity.
    - **Text:** lets you visualize results using text.
    - **Symbol:** lets you visualize results using symbol. The available symbols depend on the values to be displayed.

- **Criteria:** provides a list of visualization criteria.  
The list of visualization criteria depends on the physical type of the selected image and the selected **Type**.
- **Options...:** lets you define visualization options.



Only available if you installed the **ELFINI Structural Analysis** product.

The dialog box that appears depends on the **Type** option you previously selected.

For more details about this button, please click [here](#).



## Options... button

Here you will find the available visualization options you obtain using the **Options...** button:

- if you selected the **Discontinuous iso**, **Average iso** or **Fringe** type, the Visualization Options dialog box appears as shown bellow:

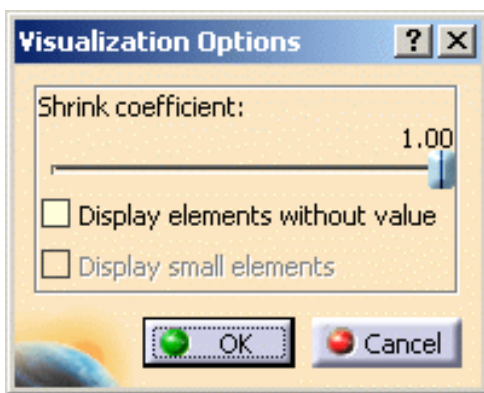

- **Shrink Coefficient:** lets you shrink the element visualization
- **Display elements without value:** lets you display elements with or without value
- **Display small elements:** lets you choose to display or not the very small elements



This option is only available if you selected the **Fringe** type.

- if you selected the **Symbol** type, the Visualization Options dialog box appears as shown bellow:

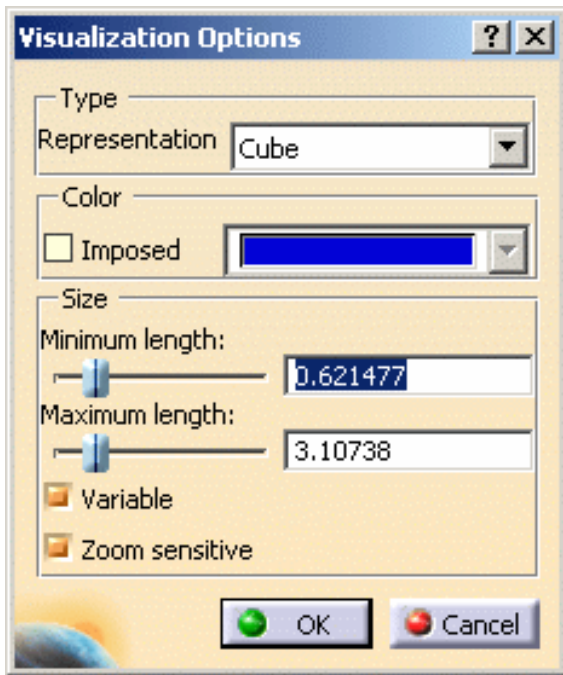

- **Type:**
    - **Representation:** lets you choose between the symbol representation types. The number of the available representations depends on the visualization **Type** and **Criteria**.
  - **Color:**
    - **Imposed:** enables the color to be fixed.  
If this option is selected, you can use the Color Chooser.
  - **Size:**
    - **Minimum length:** lets you define the minimum symbol length.
    - **Maximum length:** lets you define the maximum symbol length.
    - **Variable:** enables the variability of the symbols in function of the value.
    - **Zoom sensitive:** enables the length of the symbols to be zoom sensitive.
- if you selected the **Text** type, the Visualization Options dialog box appears as shown bellow:

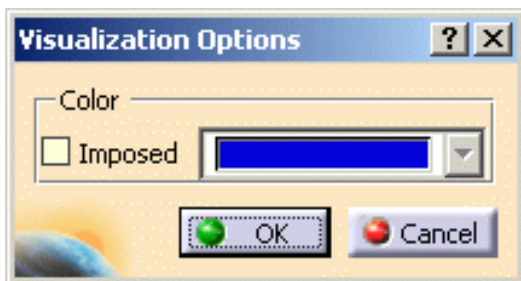

- **Color:**
    - **Imposed:** enables the color to be fixed.  
If this option is selected, you can use the Color Chooser.
-

# Selections Tab

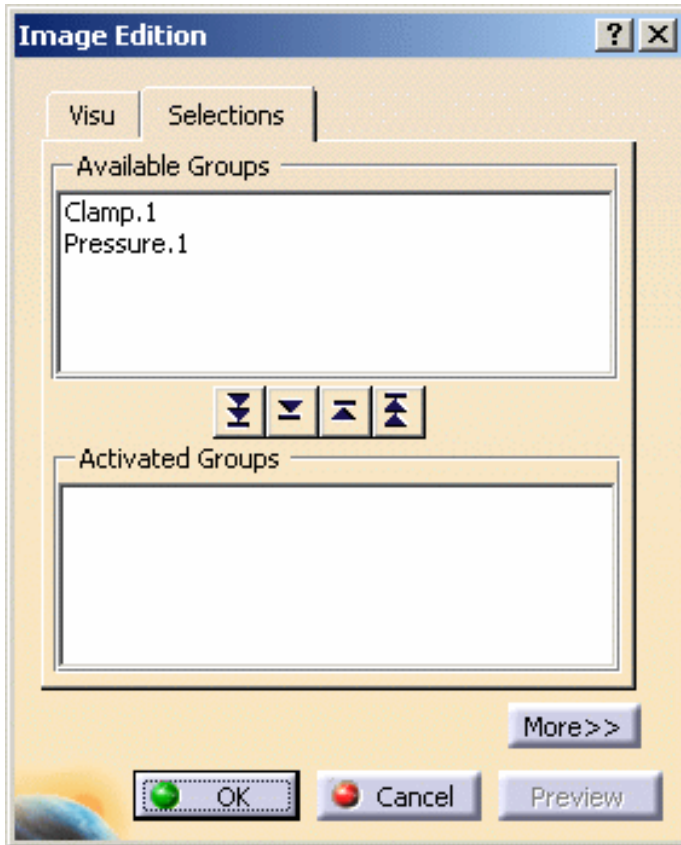

The **Selections** tab lets you limit the image visualization to a list of entities.

- **Available Groups:** gives you the list of the available entities.





The available entities could be:

- mesh parts (under the **Nodes & Elements** set in the specification tree)
- pre-processing specifications (under the **Restraints, Loads** and **Masses** sets in the specification tree)
- user groups (under the **Groups** set in the specification tree)



You can filter the list of the available entities using the **Filter groups...** contextual menu.

For more details, please click [here](#).

-  button: lets you activate the visualization of all the available entities contained in the **Available Groups** frame.
-  button: lets you activate the visualization of entities selected in the **Available Groups** frame.
-  button: lets you deactivate the visualization of entities selected in the **Activated Groups** frame.
-  button: lets you deactivate the visualization of all the selected entities contained in the **Activated Groups** frame.

- **Activated Groups:** shows you the list of the entities you have activated the visualization.



- Multi-selection is available.  
In this case, the resultant selection is the union of the selected entities.
- You can double-click an entity to activate or deactivate the entity visualization.
- You can select entities directly in the specification tree or in the viewer.
- Minimum value and the maximum value of the color palette depend on the selected entities.
- If the **Activated Groups** field is empty, all the entities listed in the **Available Groups** field will be visualized.



In case of pre-processing specifications, the type of entities contained in a selection may be different from a specification to another.

For example:

- a **Clamp** symbolizes a list of nodes
- a **Lineic Force** symbolizes a list of edges
- a **Pressure** symbolizes a list of faces



## Filtering Groups

- Right-click in the **Available Groups** frame and select the **Filter Groups...** contextual menu as shown bellow:



The Filter Groups dialog box appears.

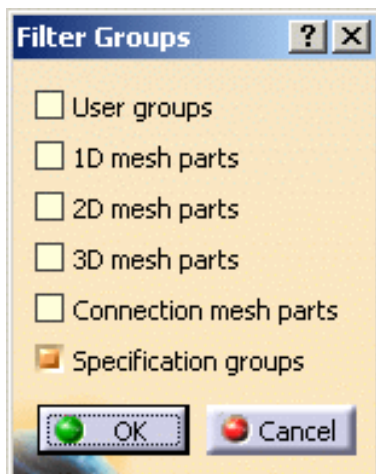

- **User groups:** lets you activate all the groups under the **Groups** set in the specification tree.

- o **1D mesh parts:** lets you activate all the 1D mesh parts under the **Nodes and Elements** set in the specification tree.
- o **2D mesh parts:** lets you activate all the 2D mesh parts under the **Nodes and Elements** set in the specification tree.
- o **3D mesh parts:** lets you activate all the 3D mesh parts under the **Nodes and Elements** set in the specification tree.
- o **Connection mesh parts:** lets you activate all the connection mesh parts under the **Nodes and Elements** set in the specification tree.
- o **Specification groups:** lets you activate all the entity under the **Restraints, Loads and Masses** sets in the specification tree.

**b.** Set the desired options.

**c.** Click **OK** in the Filter Groups dialog box.

For example, with the following analysis specification tree:

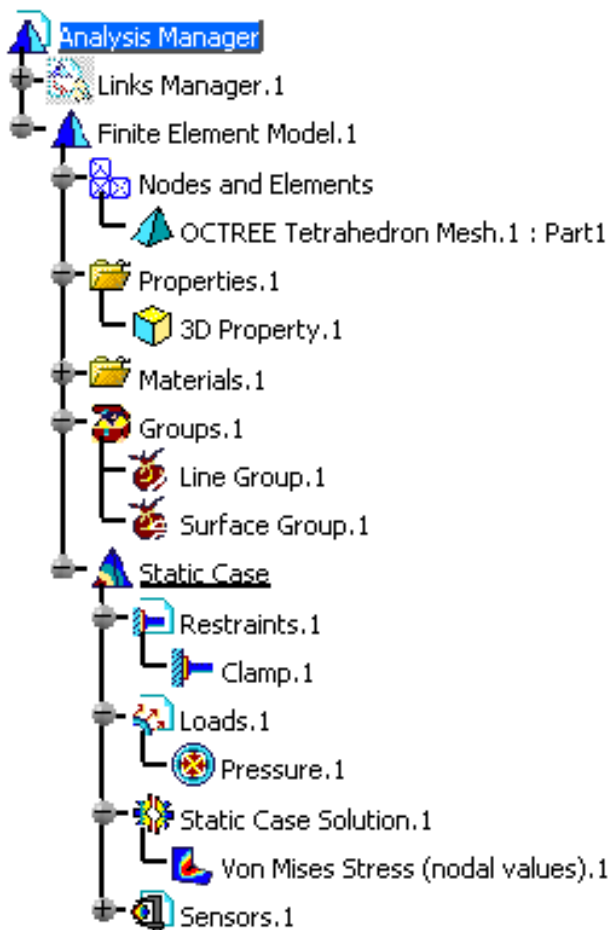

- if you activate the **User groups** and the **Specification groups** options, the **Available Groups** frame is updated as shown below:

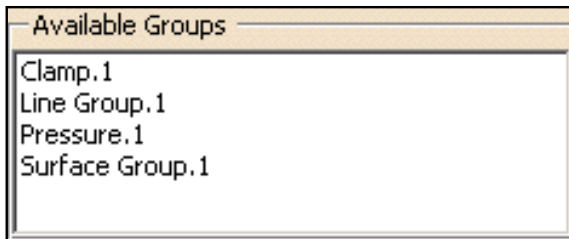

- if you activate the **3D mesh parts** and the **Specification groups** options, the **Available Groups** frame is updated as shown below:

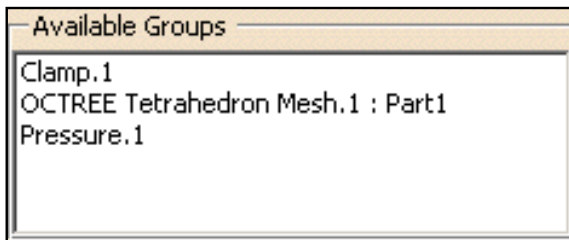

## Occurrences Tab



The **Occurrences** tab is available in the Image Edition dialog box only for multi-occurrence solutions.

This tab gives you the list of modes with the associated:

- frequencies (Hz) for a **Frequency Case** and a **Harmonic Dynamic Response Case**

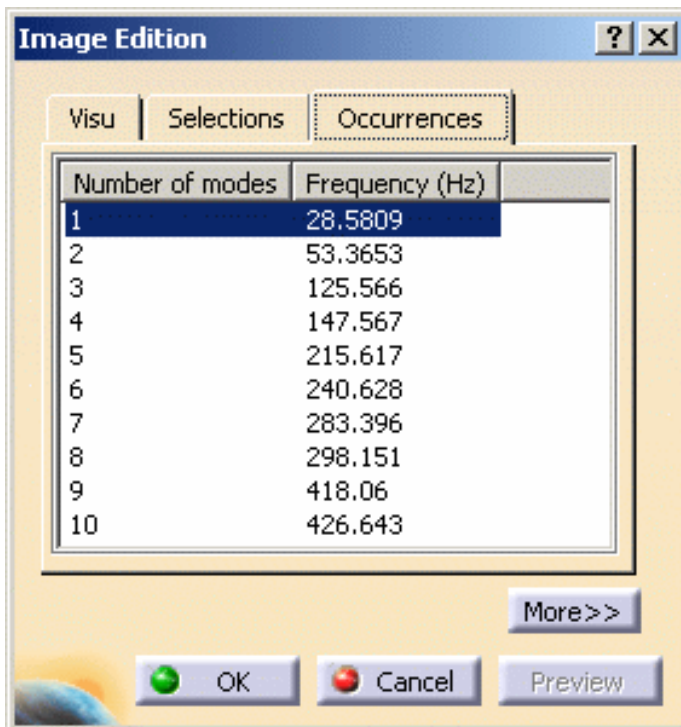

- **Buckling factor** for a **Buckling Case**



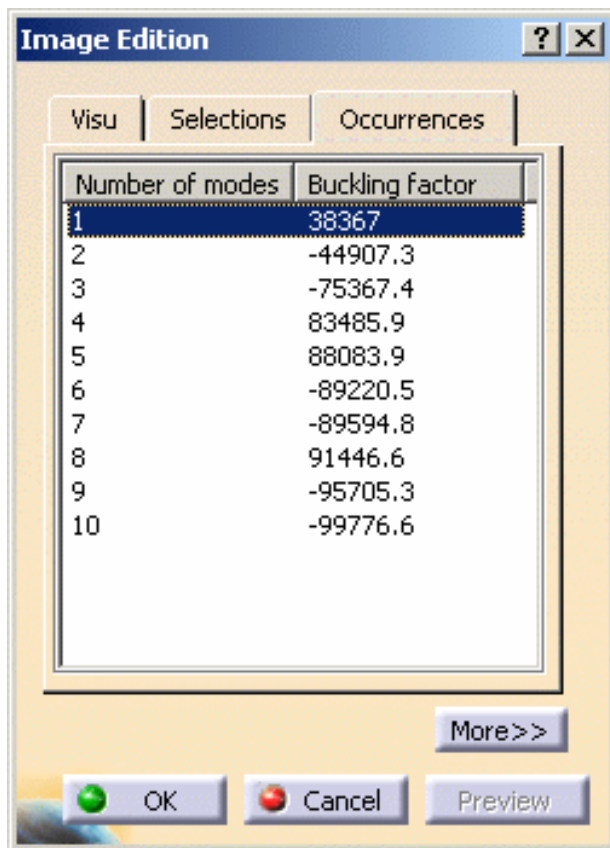

- **Time (s) for a Transient Dynamic Response Case**

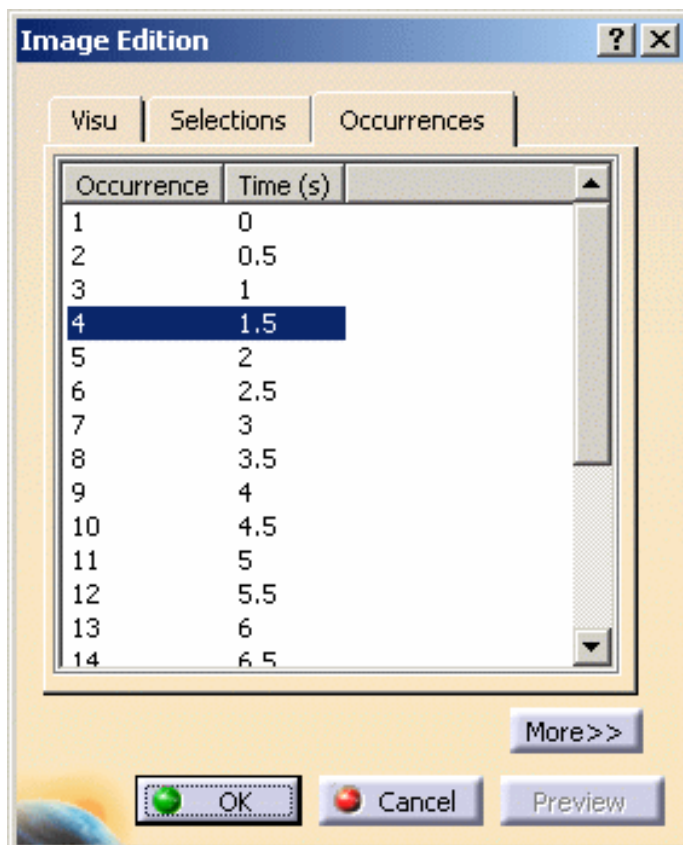



You can then activate separately each mode of the multi-occurrence solution.



## More and Less Buttons

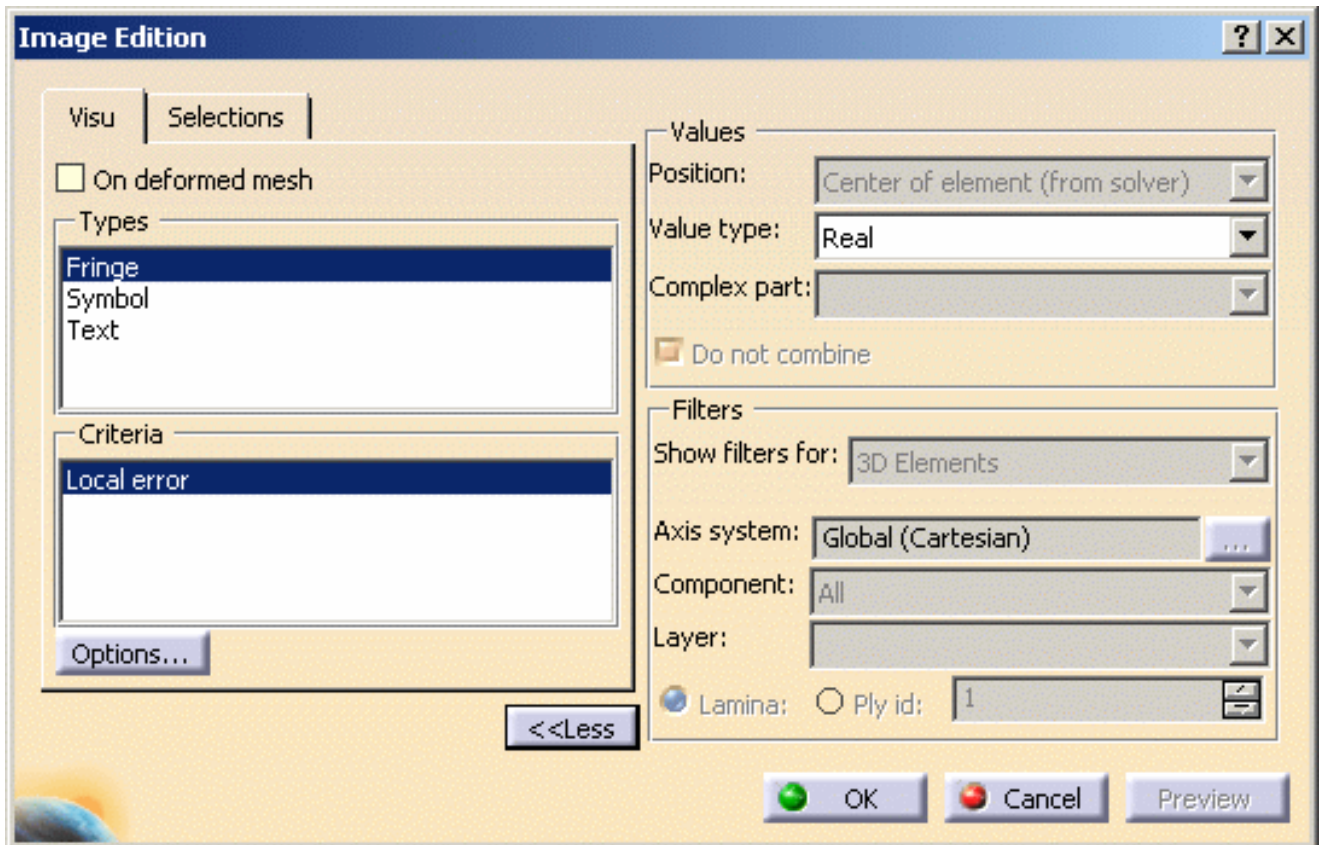

For more details on **Values** and **Filters** options, please click [here](#).



## Preview button



By default, the visualization process is launched after each modification in the Image Edition dialog box.

The **Preview** button allows you to launch the visualization process after performing all the needed changes in the Image Edition dialog box.



The **Preview** button is available only if you deactivate the **Automatic preview mode** option in the Options dialog box (**Tools** -> **Options...** menu).

For more details, please refer to the *Customizing - Post Processing* section of the *Generative Structural Analysis User's Guide*.



# Advanced Edition for Images and Local Sensors



This task describes the advanced edition of the values that are taken into account for the visualization (advanced edition of images) or for the local sensors.

A screenshot of a software dialog box with two main sections: 'Values' and 'Filters'. The 'Values' section includes dropdown menus for 'Position' (set to 'Node'), 'Value type' (set to 'Real'), and 'Complex part'. Below these is a checkbox labeled 'Do not combine' which is checked. The 'Filters' section includes a dropdown for 'Show filters for:' (set to 'Nodes of 3D Elements'), a dropdown for 'Axis system' (set to 'Global (Cartesian)'), a checkbox for 'Display locally' which is unchecked, a dropdown for 'Component' (set to 'All'), a dropdown for 'Layer', and a section for 'Lamina' with a dropdown set to '1' and a radio button for 'Ply id' which is unselected.

- **Values:**
  - Position
  - Value type
  - Complex part
  - Do not combine
- **Filters:**
  - Show filters for
  - Axis system
  - Display locally
  - Component
  - Layer
  - Lamina
  - Ply id

# Values



— Values —

Position:

Value type:

Complex part:

Do not combine

- **Position:** the position depends on the selected **Type** and **Criteria** option in the **Visu** tab.

Position:

Value type:

Complex part:

<b>Node</b>	Linked to the mesh nodes. For each node, there is only one value.
<b>Node of element</b>	For each node, there is as many values as elements linked to this node.
<b>Center of element</b>	For each element center, there is only one value.
<b>Edge of element</b>	For each edge element, there is only one value.
<b>Face of element</b>	For each face element, there is only one value.
<b>Element</b>	For each element, there is only one value.
<b>Gauss point of element</b>	The position of the Gauss points depend on the type of element. For more details, please refer to the <i>Finite Element Reference Manual</i> .

"(from solver)" indicates that the position is provided by the solver.

To know more about the authorized position according to a selected **Visu Type**, please

refer to the *Frequently Asked Section - Post-Processing and Visualization* section of the *Generative Structural Analysis User's Guide*.

- **Value type:** corresponds to the type of the value (integer, real, double precision, complex, complex with double precision).
- **Complex part:** the complex part is available when the selected **Value Type** is complex and complex with double precision.
- **Do not combine:**
  - if this option is not activated, combined values will be displayed whenever available. The desired resulting force will be displayed.
  - if this option is activated, each specification (force, restraints and so forth) can be displayed separately. You will use the **Value set** list box to choose the desired value set.

For example, if three forces were applied on a single surface, three values will be available in the **Value set** combo box. You can then select the desired **Value set**.

---

## Filters

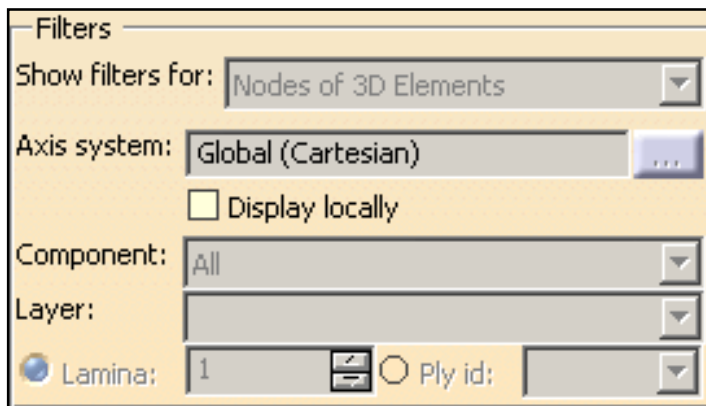

- **Show filters for:** lets you select the entity type on which you will change the **Axis System**, **Component**, **Layer**, **Lamina** and **Ply id** options.



The **Show filters for** option does not modify the feature you are editing.

The following options are available:

- **Nodes of 1D elements**, **Nodes of 2D elements** or **Nodes of 3D elements** for a **Node** position type.
  - **1D elements**, **2D elements** or **3D elements** for an **Element** position type.
- **Axis System:** lets you select the current axis system to be used. For this, click the ... button.



- The **Axis system** functionality is only available if you installed the **ELFINI Structural Analysis (EST)** product.
- The ... button is only available if you have selected **Vector**, **Tensor**, **Vector component** or **Tensor component** as **Criteria** option.
- **Global**: lets you select the main axis system.

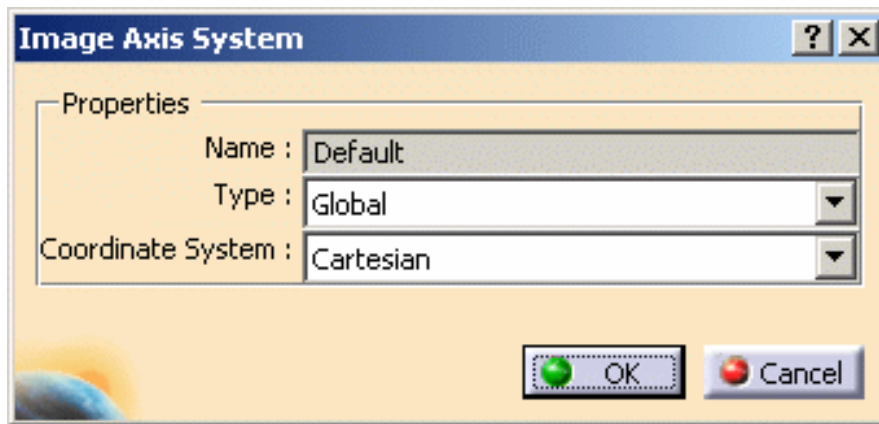

- **User**: lets you select an axis system feature (created in the **Part Design** workbench or the **Generative Shape Design** workbench).

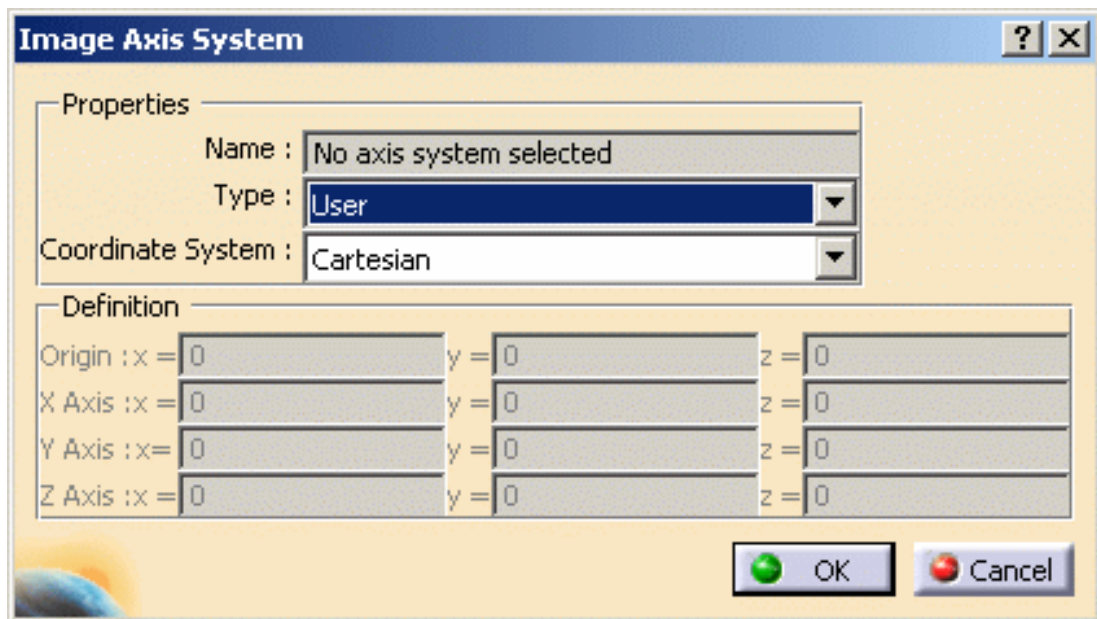

- **Manual**: lets you specify an axis system by defining the origin coordinates and the different directions.

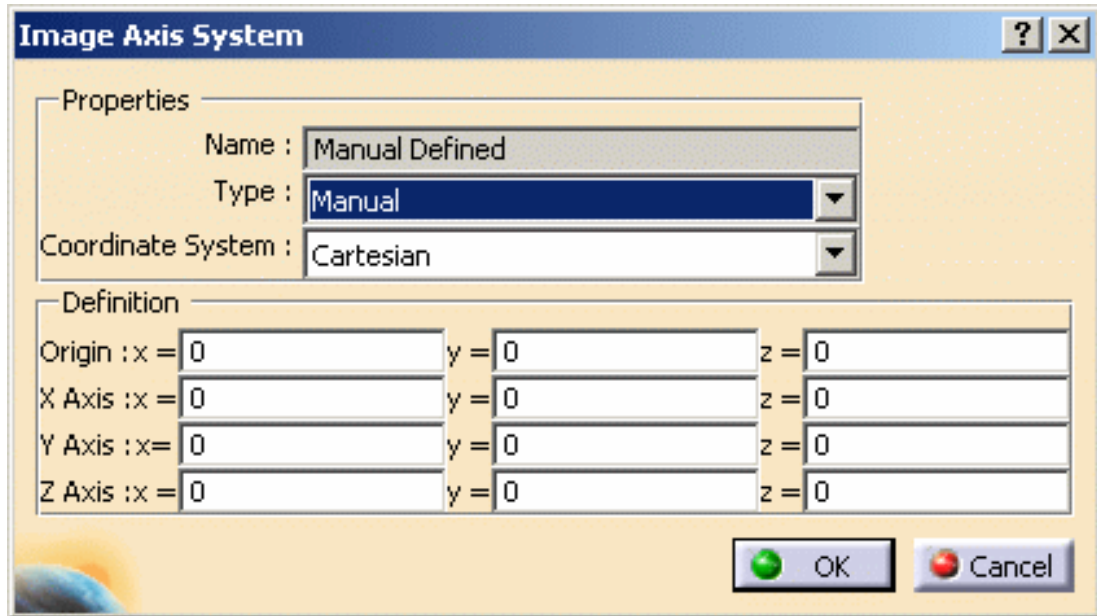

- **Local:** lets you select an axis system that is locally defined (related to a finite element).

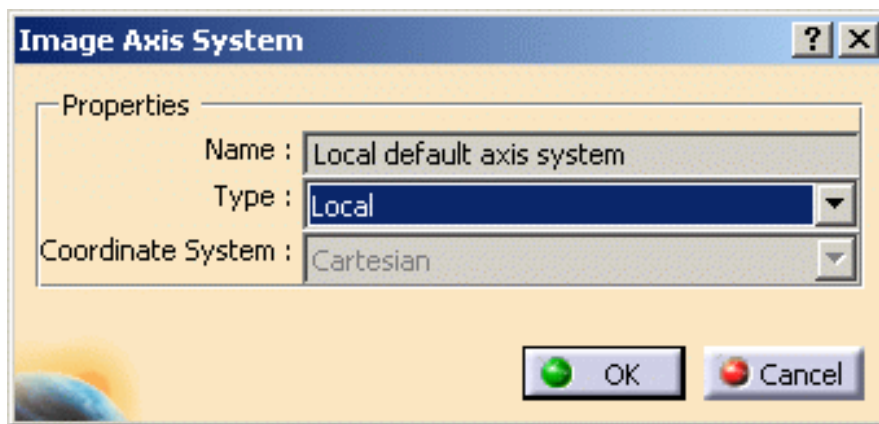

- **Display locally:** lets you visualize the axis on each entity.



The **Display locally** functionality is only available

- if you installed the **ELFINI Structural Analysis (EST)** product.
- in the image edition context.

- **Display locally** option deactivated with a **Global** axis system

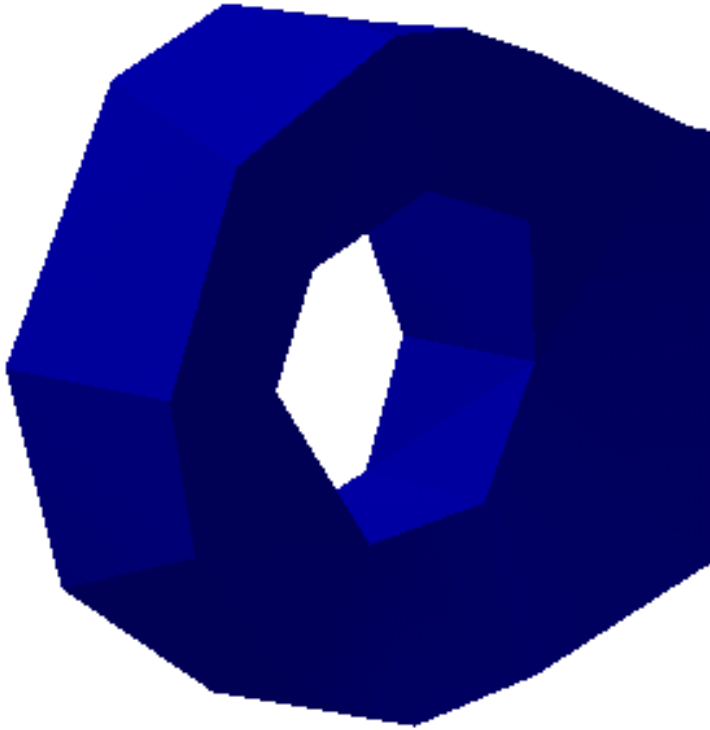

- **Display locally** option activated with a **Global** axis system

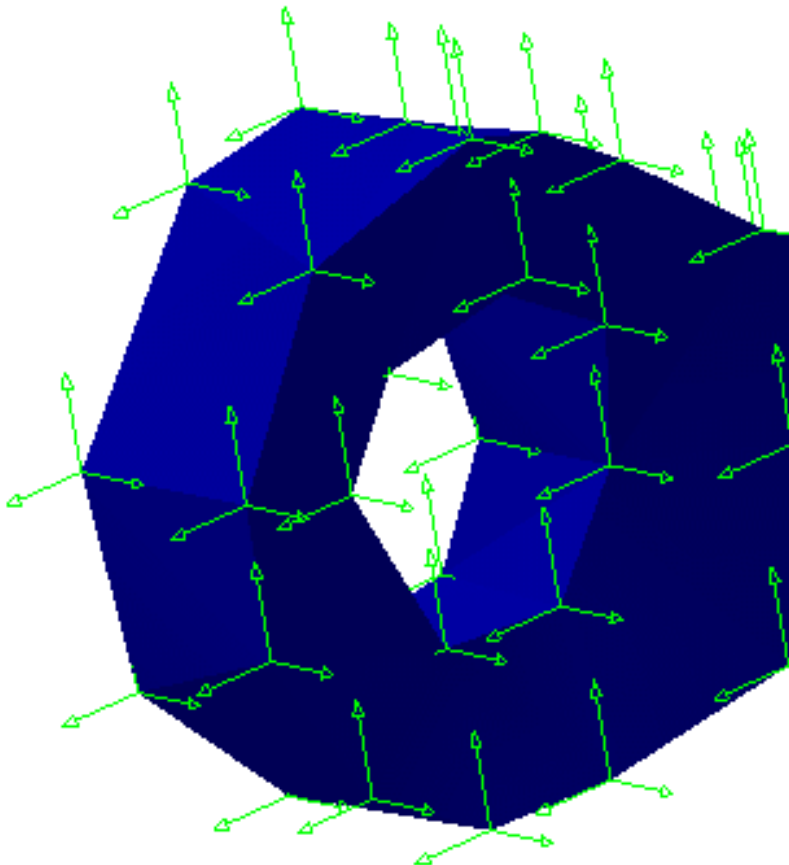

- **Component:** lets you select the component to visualize.

- For example, if you select a **Translational displacement symbol** image, you will get the following **Component** options:
  - **ALL**: all the components
    - C1**: components according to x in the current axis system
    - C2**: components according to y in the current axis system
    - C3**: components according to z in the current axis system
 You can also have a combination of these components (for example, **C1 & C2**).
  
- For **Stress principal tensors** image:
  - In the case of **3D elements**:
    - C11**: is the maximum principal stress
    - C22**: is the middle principal stress
    - C33**: is the minimum principal stress
 You can also have a combination of these components (for example, **C11 & C22**).
  
  - In the case of **2D elements**:
    - C1**: is the maximum principal stress
    - C2**: is the minimum principal stress
  
- **Layer**: (only available in the case of 2D elements).  
 In a lamina, you can select the **Upper**, **Middle** or **Lower** layer from which the results will be computed.



If you installed the **ELFINI Structural Analysis (EST)** product, you can display both the upper and lower layers according to local normal orientation using the **Upper and lower** option.

- **Lamina**: (only available in the case of 2D elements with composite property).



You can select the **Lamina** from which the results will be visualized.

- **Ply id**: (only available in the case of 2D elements with composite property).



You can select the **Ply id** from which the results will be visualized.







# Filtering Mesh Parts



This task shows you how to use the **Mesh Part Selection** button in the *Advanced Meshing Tools* workbench.



1. Click the **Mesh Part Filter** button .

The Mesh Part Selector dialog box appears.

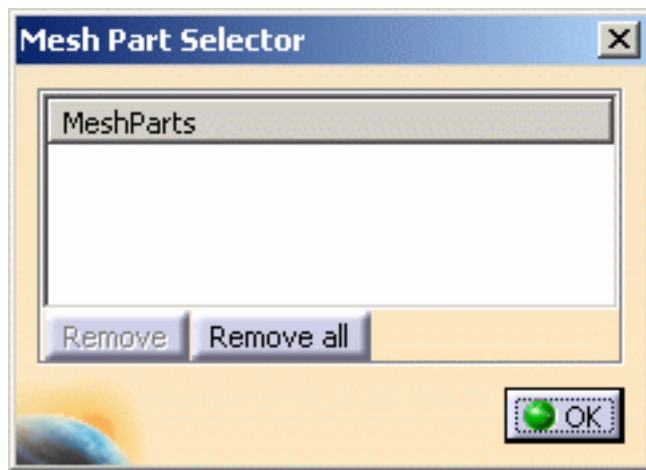

- **Mesh Parts:** lets you select the desired mesh parts.
  - **Remove:** lets you remove a previously selected mesh part.
  - **Remove all:** lets you remove all the selected mesh parts.
2. Select the desired Mesh Part.
  3. Click **OK** in the Mesh Part Selector dialog box.





# Integration with Product Engineering Optimization

This section gives you information about the analysis data authorized in the **Product Engineering Optimization (PEO)** product.



For more details about the algorithm for constraints and derivatives providers, please refer to the *Product Engineering Optimization User's Guide - Basic Tasks - Using a Dedicated Structural Analysis Algorithm*.

[What are the authorized sensors?](#)  
[What are the restrictions?](#)

---

## What are the authorized sensors?



You can find here what are the analysis sensors authorized in the algorithm for derivatives providers of the **Product Engineering Optimization (PEO)** product.

	Authorized Sensors
Global Sensors	<b>Mass</b>
Local Sensors	All (except the <b>Von Mises Stress</b> local sensor) *

\* only if the local sensor has been defined with **None** or **Average** as **Post-Treatment** option.

---

## What are the restrictions?



You can find here the restrictions when using analysis sensors in the derivatives computation.

- Only the structural parameters (parameters that do not impact the mesh) will be taken into account in the derivatives computation.

The geometrical parameters (those whose the variation invalidates the mesh) must not be taken into account in the derivatives computation.

In the case of an analysis containing a 2D body and a 3D body:

- The **Thickness** parameter (defined in the **2D Property**) can be referenced in the optimization because its variation does not impact the 2D mesh.
  - The **Length** parameter (defined in the **Pad**) cannot be referenced in the optimization because its variation impacts the 3D mesh.
- Analysis sensors will have to expose one single output parameter to be used as objectives inside the **Product Engineering Optimization (PEO)** product:
    - local sensor with post-treatment
    - global sensor with a single output parameter
  - The sensors must have been defined in a mono-occurrence solution.

You cannot use analysis sensors belonging to a multi-occurrence solution (**Frequency Case**, a **Buckling Case** or **Dynamic Response Case**) in the derivatives computation.

# Frequently Asked Questions

Here is a non-exhaustive list of frequently asked questions about the analysis products.

[Entering the Generative Structural Analysis Workbench](#)

[Associativity](#)

[Connection](#)

[Data Mapping](#)

[Dynamic Response Analysis](#)

[Solver Computation](#)

[Post-processing and Visualization](#)

[Frequent Error Messages](#)

[Licensing](#)

[Integration with Product Engineering Optimization](#)

# Entering the Generative Structural Analysis Workbench

This section gives you information about problems you may encounter when entering the Analysis Generative Structural Analysis workbench.

[Why is no mesh part created when entering the workbench?](#)  
[How to create a mesh part?](#)

---

## Why no mesh part is created when entering the workbench?



Sometimes, no mesh part is created when entering the Generative Structural Analysis workbench. You did not indicate in the Generative Shape Design workbench which geometry you want to be analyzed.



For more information, please refer to [How to create a mesh part?](#)

---

## How to create a mesh part?



Sometimes, no mesh part is created when entering the Generative Structural Analysis workbench. For more information, please refer to [Entering the Generative Structural Analysis Workbench](#).

You can create a mesh part in:

- a Generative Shape Design context.  
For this, select **Tools** -> **External View** commands from the menu bar in the Generative Shape Design workbench and select the geometry to be analyzed
- an analysis context.  
For this, use the mesh creation functionalities:
  - [Creating 1D Mesh Parts](#).
  - [Creating 2D Mesh Parts](#).
  - [Creating 3D Mesh Parts](#).

# Associativity

Associativity means that any part modifications occurring outside the Analysis workbench are automatically reflected when performing tasks within the Analysis workbench. In particular, any parametric changes on the parts are automatically accounted for.

Analysis specifications (load, restraints, masses and virtual parts) can be applied to different types of supports (or features):

- Mechanical Feature (Pad, Fill, ...)
- Geometrical Feature (Vertex, Face, ...)
- Analysis Feature (Virtual Part, Mesh Part, Geometrical Groups, **Free Groups**, **Proximity Groups**, ...)

You will see in this section on which support analysis specifications can be applied.



In the following tables, the  symbol indicates that the feature is authorized.

If the only authorized **Geometrical Feature** is **Face**, the following supports are available (if they are authorized):

- all the faces of pad, or all the faces of a hole, ... as **Mechanical Feature**.
- **Surface Group** as **Geometrical Groups**.
- **Surface Group by Neighborhood** as **Proximity Groups**.

For example:



pressure is applied on pad means that pressure is applied to faces of pad.

- On which supports can loads be applied?
- On which supports can restraints be applied?
- On which supports can masses be applied?
- On which supports can properties be applied?
- On which supports can virtual parts be applied?

# On which supports can loads be applied?







Load specifications can be applied to different types of supports (or features):

		Supports					
		Geometrical Feature	Mechanical Feature	Analysis Feature			
				Free Groups	Geometrical Groups	Proximity Groups	Others
	Pressure	Face	▲	▲	▲	▲	
	Distributed Force	Point/Vertex Edge Face (homogeneous selection)	▲	▲	▲	▲	Virtual Part
	Moment	Point/Vertex Edge Face (homogeneous selection)	▲	▲	▲	▲	Virtual Part

	Bearing Load	Cylindrical Surface Cone Revolution surface					
	Imported Force	Point/Vertex Face					
	Imported Moment	Point/Vertex Face					
	Acceleration	Body 1D Body 2D Body 3D					Mesh Part Virtual Part
	Rotation Force	Body 1D Body 2D Body 3D					Mesh Part Virtual Part
	Line Force Density	Edge					
	Surface Force Density	Face					
	Volume Force Density	Body 3D					Mesh Part





















	Force Density	Edge Face Body  (homogeneous selection)					
	Enforced Displacement						Restraint
	Creating Temperature Field	Face Body					Mesh Part

## On which supports can restraints be applied?



Restraint specifications can be applied to different types of supports (or features):

		Supports					
		Geometrical Feature	Mechanical Feature	Analysis Feature			
				Free Groups	Geometrical Groups	Proximity Groups	Others
	Clamps	Point/Vertex Edge Face					Virtual Part
	Surface Sliders	Face					

















	Sliders							Virtual Part
	Sliding Pivots							Virtual Part
	Ball Joints	Point/Vertex						Virtual Part
	Pivots							Virtual Part
	Advanced Restraints	Point/Vertex Edge Face						Virtual Part

## On which supports can masses be applied?



Mass specifications can be applied to different types of supports (or features):



	<b>Supports</b>					
	<b>Geometrical Feature</b>	<b>Mechanical Feature</b>	<b>Analysis Feature</b>			
			<b>Free Groups</b>	<b>Geometrical Groups</b>	<b>Proximity Groups</b>	<b>Others</b>

	Distributed Mass	Point/Vertex Edge Face Homogeneous selection					Virtual Part
	Line Mass Densities	Edge					
	Surface Mass Densities	Face					
	Inertia on Virtual Parts						Virtual Part

## On which supports can properties be applied?



Properties specifications can be applied to different types of supports (or features):

		Supports					
		Geometrical Feature	Mechanical Feature	Analysis Feature			
				Free Groups	Geometrical Groups	Proximity Groups	Others
	1D Property	Body 1D					Mesh Part

	Local 1D Property	Edge		?			
	Imported Beam Property	Body 1D					
	2D Property	Body 2D					Mesh Part
	Local 2D Property	Face		?			
	Composite Property	Body 2D					Mesh Part
	3D Property	Body 3D					Mesh Part

## On which supports can virtual parts be applied?

Virtual Part specifications can be applied to different types of supports (or features):

	Supports					
	Geometrical Feature	Mechanical Feature	Analysis Feature			
			Free Groups	Geometrical Groups	Proximity Groups	Others
All Virtual Parts	Edge Face					

# Connection

This section gives you information about connections and properties available in the **Generative Assembly Structural Analysis (GAS)** product.

What types of modeling do connections generate?  
What type of property for what type of connection?

## What types of modeling do connections generate?

When you associate a Connection Property to a Connection, finite elements will be automatically generated.

The following table gives you the correspondence between connection properties and generated finite element.

Connection Properties Type	Connection Property	Generated Finite Element
<b>Face Face</b>	Slider Connection Property	Slider Join
	Contact Connection Property	Contact Join
	Fastened Connection Property	Fastened Join
	Fastened Spring Connection Property	Fastened Join Spring
	Pressure Fitting Connection Property	Fitting Join
	Bolt Tightening Connection Property	Tightening Join
<b>Distant</b>	Rigid Connection Property	Rigid Spider
	Smooth Connection Property	Smooth Spider
	Virtual Rigid Bolt Tightening Connection Property	Tightening Beam Rigid Spider
	Virtual Spring Bolt Tightening Connection Property	Tightening Beam Spring Smooth Spider



To know more about finite element, please refer to the [Finite Element Reference Manual](#).

---

## What type of property for what type of connection?

When you want to use the connection properties of the Generative Assembly Structural Analysis product, you first need to define a connection that the connection property will reference.

You can apply connection properties on **Analysis Connections**, **Assembly Constraints**, **Welding Joints** or **Joint Connections**.

To know which connection properties can be applied on the desired connection, please refer to the [About Connection Properties](#) section.



Certain connection properties need a few precisions.

For more details, please refer to the [Precisions and Restrictions](#) paragraph.

# Data Mapping

This section gives you information about the Data Mapping process.

Note that: this functionality is only available with the **ELFINI Structural Analysis (EST)** product .

[What is Data Mapping?](#)

[How are Data Mapping files filled?](#)

[Which algorithm is used for Data Mapping?](#)

[In which functionalities is the Data Mapping process available?](#)

---

## What is Data Mapping?



Data Mapping is a functionality allowing load import described by a scalar field from a text (.txt) or an Excel (.xls) file. This file must respect a pre-defined format.

You can re-use data that are external data (experimental data or data coming from in-house codes or procedures).

The imported values will be interpolated at the center of gravity of each element.

You can also integrate user loading knowledge and processes into this version.

The selected external data file will be either a .txt file (columns separated using the **Tab** key) or a .xls file. This file must respect a [pre-defined format](#).

Data Mapping is useful when you want to re-use a load field created without CATIA or with a former version of CATIA.

---

## How are Data Mapping files filled?



Data Mapping files are text files (.txt) or Excel files (.xls) that must respect a pre-defined format.

- For pressure, line force density, surface force density, body load, temperature and shell property functionalities, the data mapping file must respect the following format:
  - four columns
  - the first three columns allow you to specify **X**, **Y** and **Z** point coordinates in the global axis. Unit symbol written between parentheses must be specified.
  - the last one allows you to specify the amplification coefficient  
No unit symbol must be specified for the last column (the amplification coefficient is not assigned to a dimensional value).

Example of data mapping for a pressure:

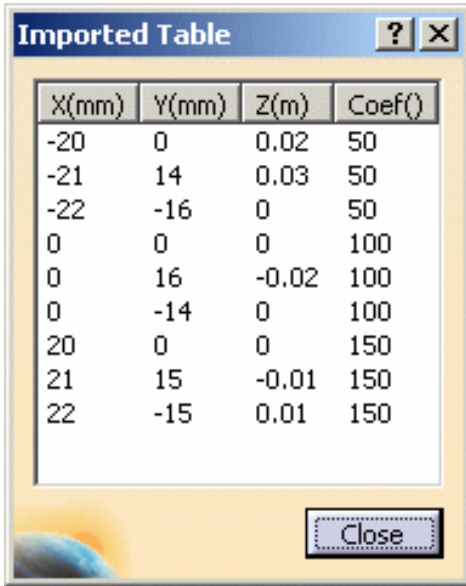

X(mm)	Y(mm)	Z(m)	Coef()
-20	0	0.02	50
-21	14	0.03	50
-22	-16	0	50
0	0	0	100
0	16	-0.02	100
0	-14	0	100
20	0	0	150
21	15	-0.01	150
22	-15	0.01	150

- For imported force and imported moment functionalities, the data mapping files must respect the following format:
  - six columns
  - the first three columns allow you to specify **X**, **Y** and **Z** point coordinates in the global axis. Unit symbol written between parentheses must be specified.
  - the last three columns allow you to specify **FX**, **FY** and **FZ** force coordinates in the global axis in case of imported forces or **MX**, **MY** and **MZ** moment coordinates in case of imported moment. Unit symbol written between parentheses must be specified.

Example of data mapping for an imported force:



X(mm)	Y(mm)	Z(mm)	Fx(N)	Fy(N)	Fz(N)
-167	0.0000000000175078	15	0.0423091	1.60566	0.113629
-167	0.0000000000175078	6.97443E-15	-0.0768273	1.58255	-0.100305
-133	0.0000000000175078	15	8.56993	-36.1512	25.6339
-133	0.0000000000175078	6.97443E-15	42.0573	180.965	-4.77655
-175	0.0000000000175078	0.0000000000000194...	0	0	0
-128.057	11.9793	0.000000000000015456	0	0	0
-175	0.0000000000175078	15	0	0	0
-125	0.0000000000175078	15	0	0	0
-125	0.0000000000175078	5	0	0	0
-126.029	7.09701	5	0	0	0
-126.029	7.09701	10	0	0	0
-128.057	11.9793	10	0	0	0

## Which algorithm is used for Data Mapping?



There are three steps in this algorithm:

1. Checking that the center of gravity of each element of the recipient mesh is inside the axis-aligned bounding box of the source mesh (automatic tolerance:  $1.0 \text{ e}^{-6} \text{ m}$ ).
2. Matching the center of gravity of each element of the recipient mesh with some of the nearest points of the scalar field.
  -  These points are processed as if they were the vertex of a finite element.
  - The matching is done at the centers of gravity of the recipient mesh elements, and not at their nodes, because it is the resulting loads location.
3. Interpolating the scalar field of the source mesh on the recipient mesh using the nodal functions of the finite element.

---

## In which functionalities is the Data Mapping process available?



The Data Mapping process is available in the following functionalities:

- pressure
- line force density
- surface force density
- body load
- temperature field
- shell property
- imported force
- imported moment

# Dynamic Response Analysis

This section gives you formulas to calculate excitation in a harmonic dynamic response case or in a transient dynamic response case.

To know more about the load excitation and the restraint excitation, please refer to [Defining a Load Excitation Set](#) and [Defining a Restraint Excitation Set](#).

Note that: Excitation is only available with the **Generative Dynamic Response Analysis (GDY)**

product .

Load excitation in frequency domain  
Load excitation in time domain  
Restraint excitation in frequency domain  
Restraint excitation in time domain

---

## Load excitation in frequency domain

The formula corresponding to the Load Excitation Set dialog box in a harmonic dynamic response case is:

$$F(f) = \sum_k C_k \cdot F_k \cdot M_k(f) \cdot e^{ift + \varphi_k}$$

where:

- $f$  is a frequency
- $F_k$  is the static load
- $M_k(f)$  is the frequency modulation
- $\varphi_k$  is the phase
- $C_k$  is the factor

The user interface looks like:

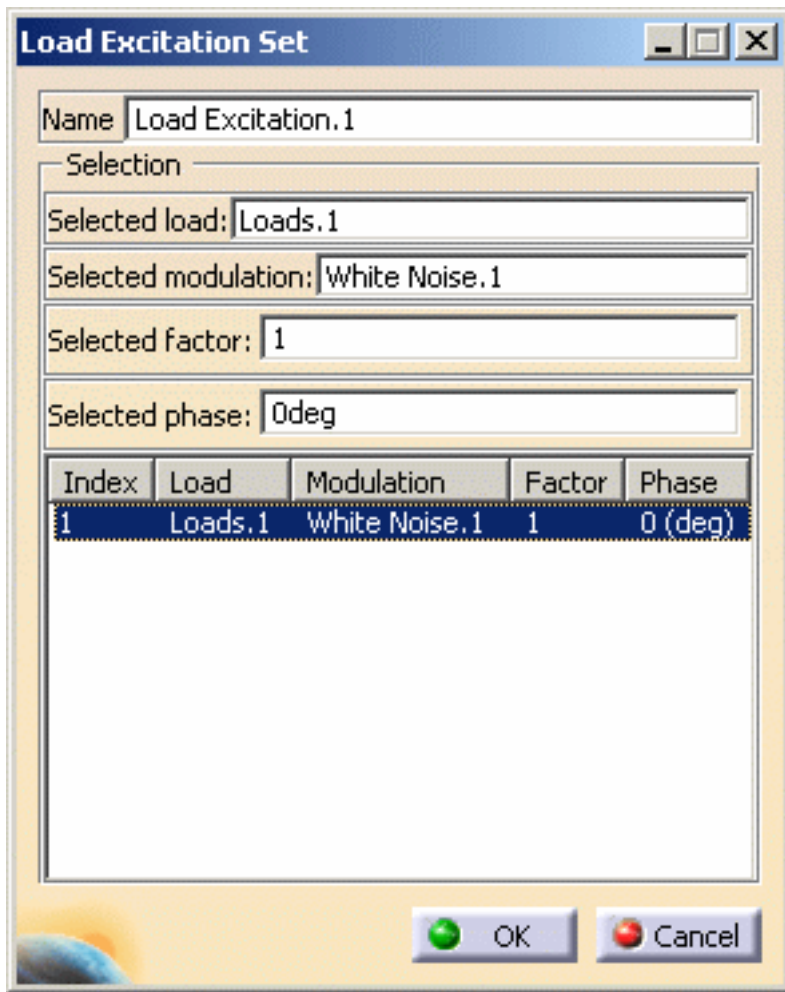

In this particular example:

$k = 1$  ;  $F_1 = \text{Loads.1}$  ;  $M_1(f) = \text{White Noise.1} = 1 \forall f$  ;  $C_1 = 1$  ;  $\varphi_1 = 0 \text{ deg} = 0 \text{ rad}$

$$F(f) = F_1 e^{ift} = F_1 (\cos(ft) + i \sin(ft))$$

## Load excitation in time domain

The formula corresponding to the Load Excitation Set dialog box in a transient dynamic response case is:

$$F(t) = \sum_k C_k \cdot F_k \cdot M_k(t)$$

where:

- $t$  is the time
- $F_k$  is the static load

- $M_k(t)$  is the time modulation
- $C_k$  is the factor

The user interface looks like:

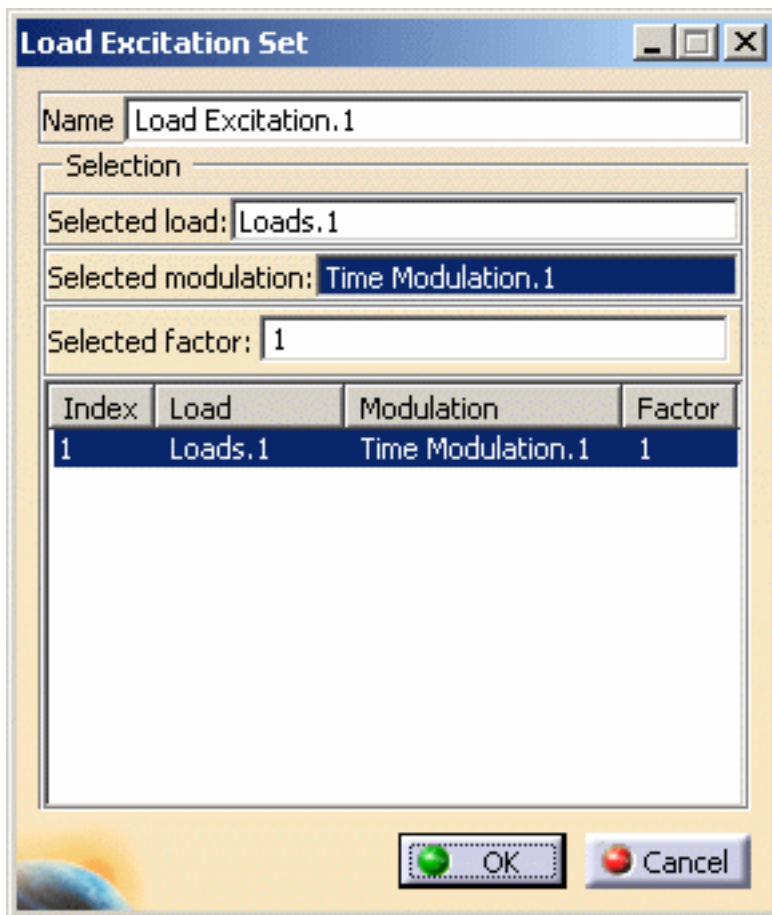

In this particular example:

$k = 1$  ;  $F_1 = \text{Loads.1}$  ;  $M_1(t) = \text{Time Modulation.1}$  ;  $C_1 = 1$

$$F(t) = F_1 M_1(t)$$

---

## Restraint excitation in frequency domain



The formula corresponding to the Restraint Excitation Set dialog box in a harmonic dynamic response case is:

$$\ddot{\mathbf{q}}(\mathbf{f}) = \begin{pmatrix} \ddot{q}_1 \cdot M_1(\mathbf{f}) \cdot e^{i\mathbf{f}t + \varphi_1} \\ \ddot{q}_2 \cdot M_2(\mathbf{f}) \cdot e^{i\mathbf{f}t + \varphi_2} \\ \ddot{q}_3 \cdot M_3(\mathbf{f}) \cdot e^{i\mathbf{f}t + \varphi_3} \\ \ddot{q}_4 \cdot M_4(\mathbf{f}) \cdot e^{i\mathbf{f}t + \varphi_4} \\ \ddot{q}_5 \cdot M_5(\mathbf{f}) \cdot e^{i\mathbf{f}t + \varphi_5} \\ \ddot{q}_6 \cdot M_6(\mathbf{f}) \cdot e^{i\mathbf{f}t + \varphi_6} \end{pmatrix}$$

where:

- $\mathbf{f}$  is the frequency
- $\ddot{q}_i$  is the value of acceleration corresponding to the degree  $i$  of the vector
- $M_i(\mathbf{f})$  is the frequency modulation corresponding to the degree  $i$  of the vector
- $\varphi_i$  is the phase corresponding to the degree  $i$  of the vector

The user interface looks like:

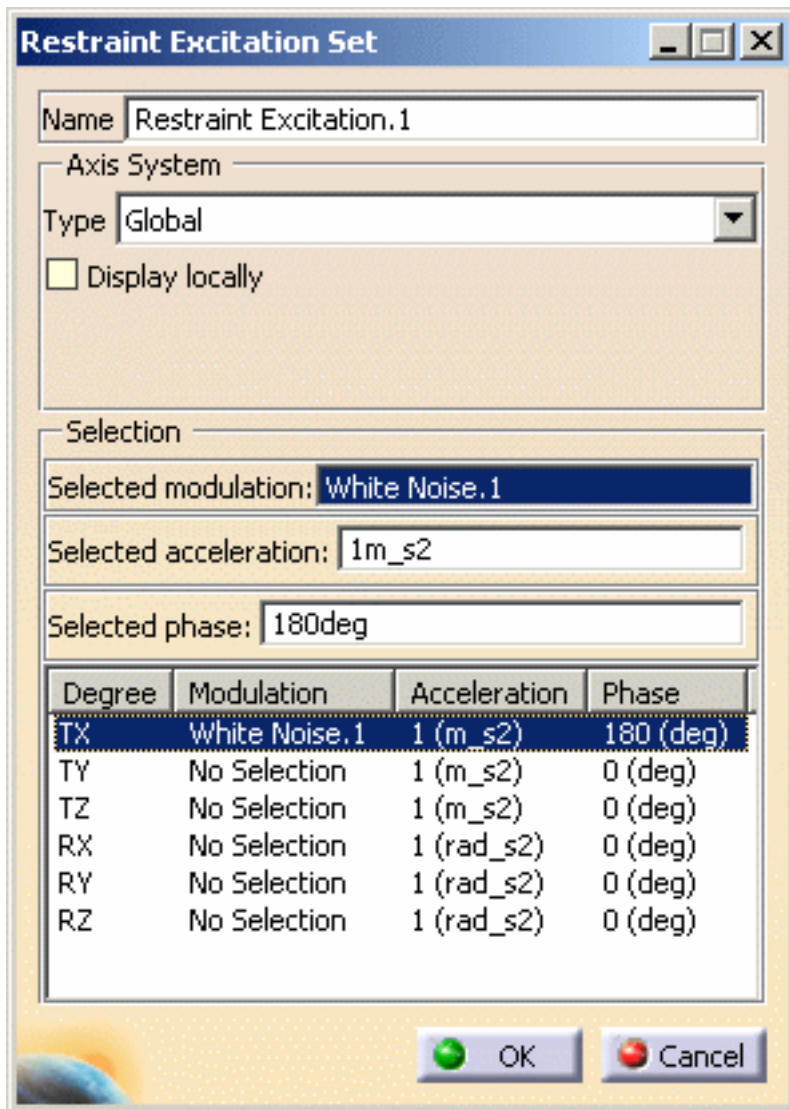

In this particular example:

$$\ddot{q}_1 = \ddot{q}_2 = \dots = \ddot{q}_6 = 1 \text{ m.s}^2 ; M_1(f) = \text{White Noise.1} = 1 \forall f ; M_2(f) = \dots = M_6(f) = 0 ; \varphi_1 = 180 \text{ deg} = \pi \text{ rad}$$

$$\ddot{q}(f) = \begin{pmatrix} e^{ift+\pi} \\ 0 \\ 0 \\ 0 \\ 0 \\ 0 \end{pmatrix} = \begin{pmatrix} \cos(ft + \pi) + i \sin(ft + \pi) \\ 0 \\ 0 \\ 0 \\ 0 \\ 0 \end{pmatrix}$$

---

## Restraint excitation in time domain



The formula corresponding to the Restraint Excitation Set dialog box in a transient dynamic response case is:

$$\ddot{\mathbf{q}}(t) = \begin{Bmatrix} \ddot{q}_{TX}(t) \\ \ddot{q}_{TY}(t) \\ \ddot{q}_{TZ}(t) \end{Bmatrix} = \begin{Bmatrix} \ddot{q}_1 \cdot M_1(t) \\ \ddot{q}_2 \cdot M_2(t) \\ \ddot{q}_3 \cdot M_3(t) \end{Bmatrix}$$

where:

- $t$  is the time
- $\ddot{q}_i$  is the value of acceleration corresponding to the degree  $i$  of the vector
- $M_i(t)$  is the time modulation corresponding to the degree  $i$  of the vector

The user interface looks like:



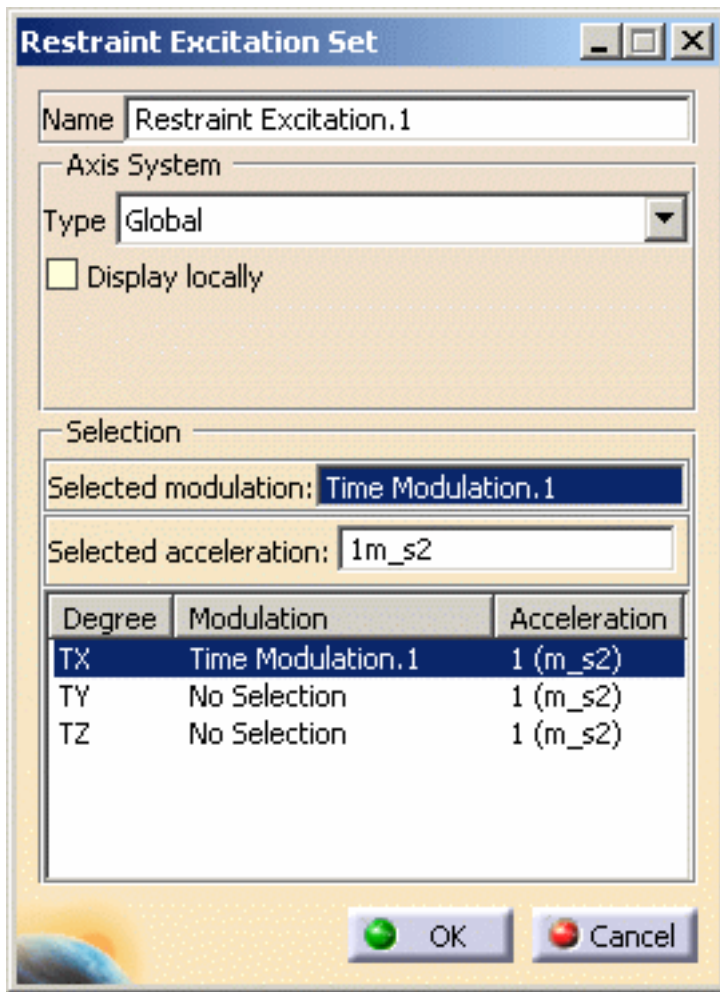

In this particular example:

$$\ddot{q}_1 = \ddot{q}_2 = \ddot{q}_3 = 1 \text{ m.s}^2 ; \mathbf{M}_1(t) = \text{Time Modulation.1} ; \mathbf{M}_2(t) = \mathbf{M}_3(t) = \mathbf{0}$$

$$\ddot{\mathbf{q}}(t) = \begin{Bmatrix} \mathbf{M}_1(t) \\ 0 \\ 0 \end{Bmatrix}$$

# Solver Computation

This section gives you information about the computation process.

How are element stresses computed?

How are node stresses computed?

How is error computed?

How are result and computation files managed?

---

## How are element stresses computed?



Element stresses at Gauss points are the product of the Comportment Law and the Strain Deformation.

$$\sigma = D \cdot \varepsilon$$

- $\sigma$  is the element stress
- $D$  is the Comportment Law, computed as a function of the following parameters, where:
  - $\nu$  is the Poisson Ratio
  - $E$  is the Young's Modulus
- $\varepsilon$  is the Strain deformation, computed according to the displacement.  
For example, with a 2D displacement:

$$\varepsilon = \frac{1}{2} \left( \frac{\partial u}{\partial x} + \frac{\partial v}{\partial y} \right)$$

where  $\frac{\partial u}{\partial x}$  and  $\frac{\partial v}{\partial y}$  are the two partial derivatives.

---

## How are node stresses computed?



Node stresses are extrapolations of element stresses.

The method consists in defining a continuous stress field within the element:

$$\sigma^* = \langle N \rangle \sigma_n$$

where:

- $\langle N \rangle$  are the element shape functions
- $\sigma_n$  are the node stresses to be computed

These nodal stresses values are obtained using the least square minimization method:

$$\text{Min}_{\sigma_n} \left[ \int_{\Omega} (\sigma^* - \hat{\sigma})^T (\sigma^* - \hat{\sigma}) d\Omega \right]$$

where  $\hat{\sigma}$  are the stresses computed with the finite element method from the nodal displacements.

---

## How is error computed?



There are two steps in the error computation:

### 1. Stress smoothing.

This method consists in computing a weighted nodal stress value at each nodes.



For more information about the nodal stresses values, please refer to [How are computed node stresses?](#)

### 2. Error estimation.

Once the nodal stresses values have been found, a continuous stress field is defined for each element:

$$\sigma^* = \langle N \rangle \sigma_n$$

where:

- $\langle N \rangle$  are the element shape functions
- $\sigma_n$  are the smoothed nodal stresses



For more information about the nodal stresses values, please refer to [How are computed node stresses?](#)

The error for each element (local error) is:

$$e_i = \int_{\Omega_i} (\sigma^* - \hat{\sigma}) D^{-1} (\sigma^* - \hat{\sigma}) d\Omega_i$$

where:

- $\hat{\sigma}$  is the finite element solution field
- $D$  is the Comportment Law



For more information about the nodal Comportment Law, please refer to [How are computed element stresses?](#)

The total error (Estimated Precision) is the sum of all the local errors:

$$e = \sum_i e_i$$

And the Global Estimated Error Rate is:

$$\eta = 100 \sqrt{\frac{e/2}{E + e/2}}$$

where  $E$  is the global strain energy.

---

## How are result and computation files managed?



You can manage analysis results (contained in **.CATAnalysisResults** files) and analysis computations (contained in **.CATAnalysisComputations** files):

- Specify the path of an external storage file directory.  
For more details, please refer to [Specify External Storage](#).
- Clear Elfini Storage in order to save space on your disk.  
For more details, please refer to [Clear External Storage](#).
- Specify a temporary data directory for the CATElfini stored data and computation results.  
For more details, please refer to [Specify Temporary Data Directory](#).

You can also customize analysis default external storage (computation and result data) settings.  
For more details, please refer to [External Storage](#).

# Post-processing and Visualization

This section gives you information about the visualization results.

What is the difference between Hide/Show and Activate/Deactivate?

How do you visualize the mesh?

What are the authorized position according to a visualization type?

How are Von Mises Stress computed?

How are local extrema computed?

---

## What is the difference between Hide/Show and Activate/Deactivate?



- The **Hide/Show** contextual menu allows you to move the selected element to the invisible space.



Note that you can visualize and modify elements you have hidden (using the **Hide/Show** contextual menu) in the invisible space (as a second workspace).

To work in the invisible space and display the hidden elements, click the **Swap Visible**

**Space** icon .

- The **Activate/Deactivate** contextual menu allows you to destroy the screen representation of the selected element and to regenerate its screen representation later. This functionality is useful with a large size model to improve your computer performance.

---

## How do you visualize the mesh?



You can visualize:

- **mesh**, if you are working with the **Nodes and Elements** set
- **deformed mesh**, if you are working with an **Analysis Case** set

### Visualizing Mesh

1. Launch the computation.

For this, click the **Compute** icon, select the **Mesh only** option and click **OK** in the Compute dialog box.



For more information, please refer to [Results Computation](#).

2. Right-click the **Nodes and Elements** set from the specification tree and select the **Mesh Visualization** contextual menu.



If you select the **Mesh Visualization** contextual menu before the computation, a warning message appears to inform you that the mesh needs to be updated.

This operation may take some time.

If you decide to update the mesh, a mesh only computation will be launched.

## Visualizing Deformed Mesh

1. Launch the computation.

For this, click the **Compute** icon, select the **All** option and click **OK** in the Compute dialog box.



For more information, please refer to [Results Computation](#).

2. Generate a Deformed Mesh image on the part.

For more information, please refer to [Visualizing Deformations](#).

# What are the authorized positions according to a visualization type?



The authorized positions depend on the representation type:

VISU Type	Node Position	Element Position					
	Node	Edge of element	Face of element	Element	Gauss point of element	Center of element	Node of element
Average iso							
Discontinuous iso							
Fringe							
Symbol							
Text							

The solver process gives results only for certain positions that are not always authorized or really useful.

Results need to be post-treated.

The post-treatment can be either a smoothing (element to node) or an extrapolation (node to element).



For a smoothing post-treatment, the way of computing average values changed according to the different versions of CATIA:

- **before CATIA V5 Release 5:**

The solver process takes into account all the linked elements.

- **from CATIA V5 Release 5 to CATIA V5 Release 9:**

The solver process takes into account an element only if this element had at least two nodes on the skin.

- **from CATIA V5 Release 10:**



The solver process takes into account all the elements linked to a node, but a weighting is done according to the distance between this node and the center of gravity of the elements.

---

## How are Von Mises Stress computed?



You can obtain a **Von Mises Stress (nodal values)** image using the:

1. dedicated icon

For this, click the **Von Mises Stress** icon .

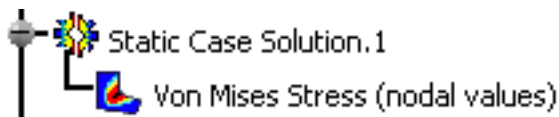

2. image edition (only available if you installed the **ELFINI Structural Analysis (EST)** product).

- a. Click the **Principal Stress** icon .

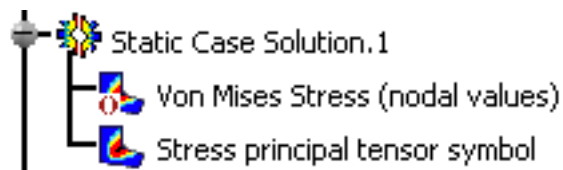

- b. Double-click the **Stress principal tensor symbol** image in the specification tree
    - c. Select the **Average iso** visualization type and then the **Von Mises** criteria in the Image Edition dialog box:

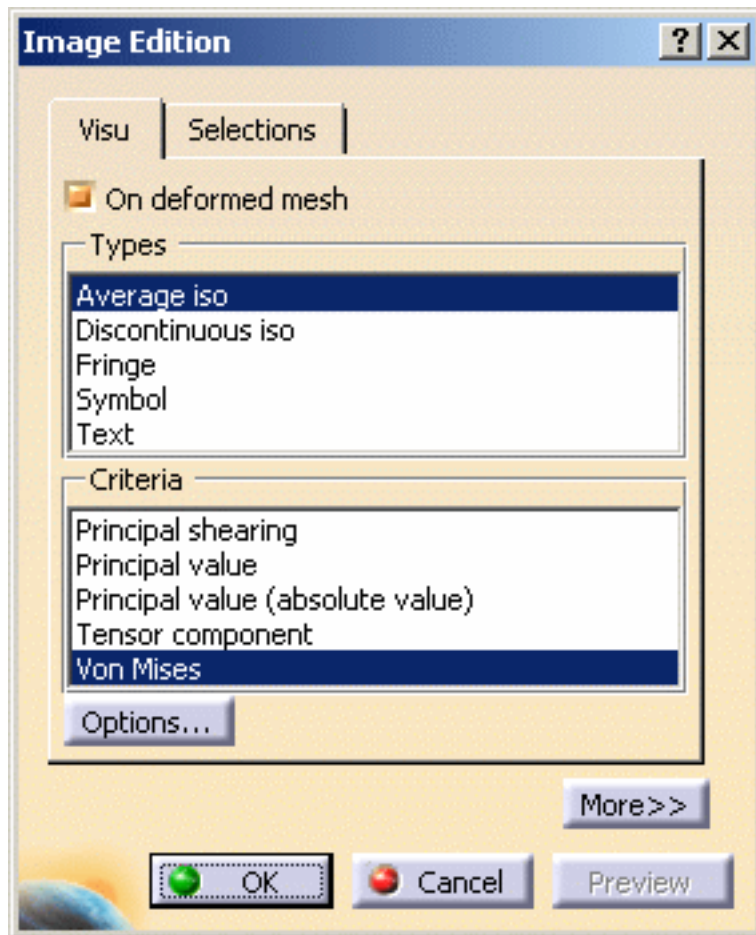

- d. Click **OK** in the Image Edition dialog box.

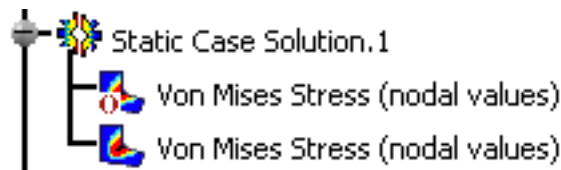

The **Von Mises Stress (nodal values)** values displayed using the **Von Mises Stress** icon and the **Von Mises Stress (nodal values)** values displayed from the edition of the **Stress principal tensor symbol** image can locally produce different results due to two computation modes:

1. In the first case (icon), the solver computation gives directly the result and then the post-processing performs a smoothing (element to node).
2. In the second case (edit), the solver calculates the principal stress tensor, then the post-processing performs a smoothing (element to node), diagonalizes the matrix, and calculates values using the following formula:  $\sqrt{(\sigma_1 - \sigma_2)^2 + (\sigma_2 - \sigma_3)^2 + (\sigma_3 - \sigma_1)^2}$  where  $\sigma_1$ ,  $\sigma_2$  and  $\sigma_3$  are the principal stresses.

The first method requires less time and less performance.

---

## How are local extrema computed?



A node (or an element) is a local extrema if it is an extrema compared to the nodes (or elements) belonging to the two rings.

The number of maximum local extrema is defined by an ascending sort; the number of minimum local extrema is defined by a descending sort.

These rings are defined as follow:

- For a node:

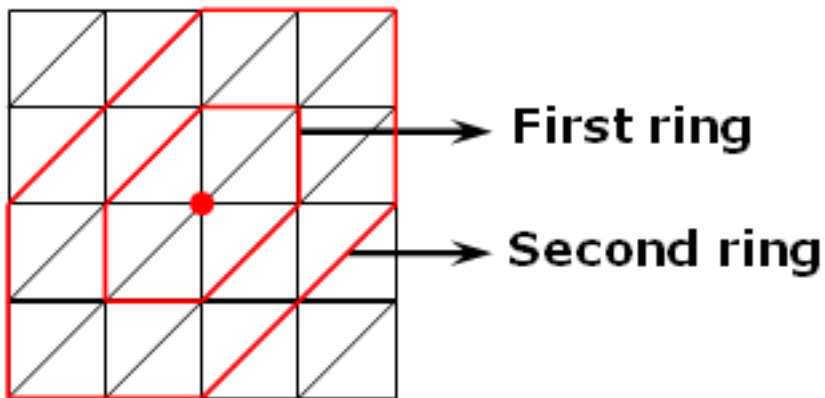

- For an element:

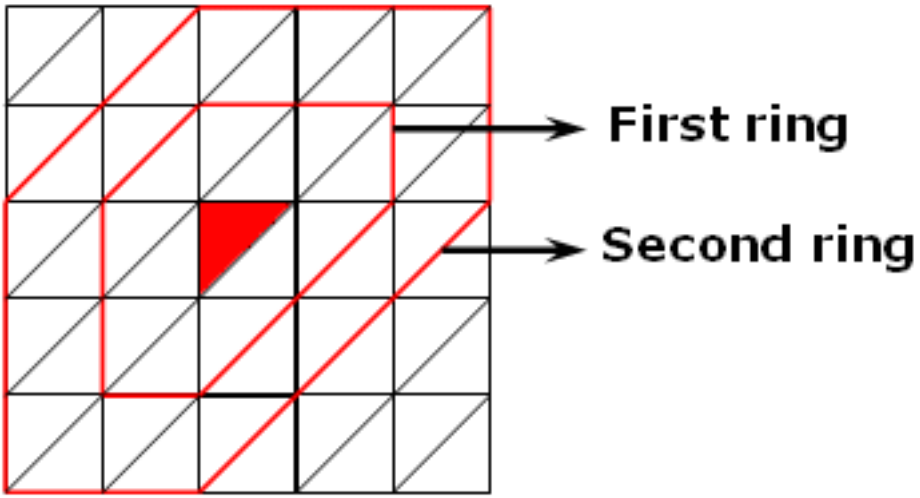

# Frequent Error Messages

This section gives you information and solutions when an error message appears.

[Why does the "Singularity detected" error message appear?](#)  
[Why does the "Entity cannot be updated" error message appear?](#)

---

## Why does the "Singularity detected" error message appear?

If a singularity is detected while launching the computation operation, the following error message appears:

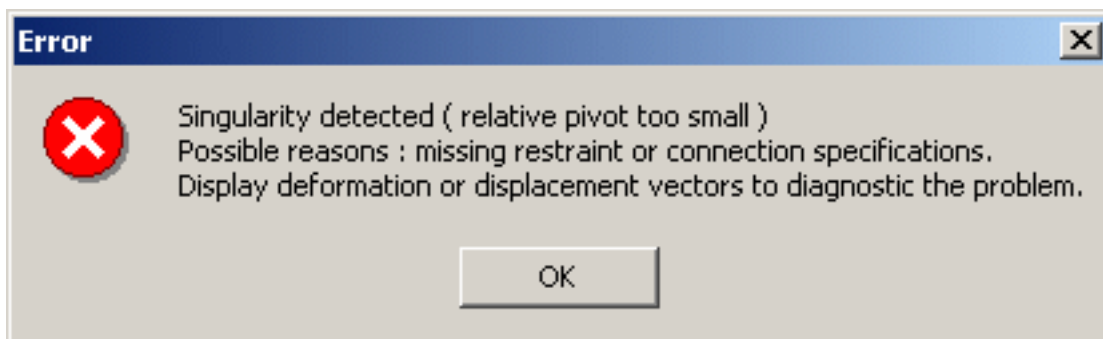

The part or the product is not fully constrained. You have to add the missing specifications.



To find the missing specifications you can generate deformations images ([Visualizing Deformations](#)) or displacements image ([Visualizing Displacements](#)) and then animate the generated image ([Animating Images](#)).



For example, you can open the [sample31.CATAnalysis](#) document from the samples directory.



1. Click the **Compute** icon , select the **All** option in the Compute dialog box and click **OK**.

As a result an error message appears.



In addition, an exclamation mark  lets you know in the specification tree (assigned to the Case solution feature) that a singularity was detected. This exclamation mark will appear either when you expand/collapse the tree or still when adding or updating a generated image. In other words, you will be able to know, visually speaking, which computed solutions are singular and which computed solutions are not singular.

2. Click **OK** in the Error message dialog box.

3. Click the **Deformation** icon . Note that as the computation failed, only the Deformation type of image is available.

4. Click the **Animate** icon  to understand why singularity was detected. Most commonly, the reasons are that a restraint or a connection is missing.

5. In this particular case, you need to assign a restraint (for example a **Clamps** ) to the part.

6. Click the **Compute** icon .

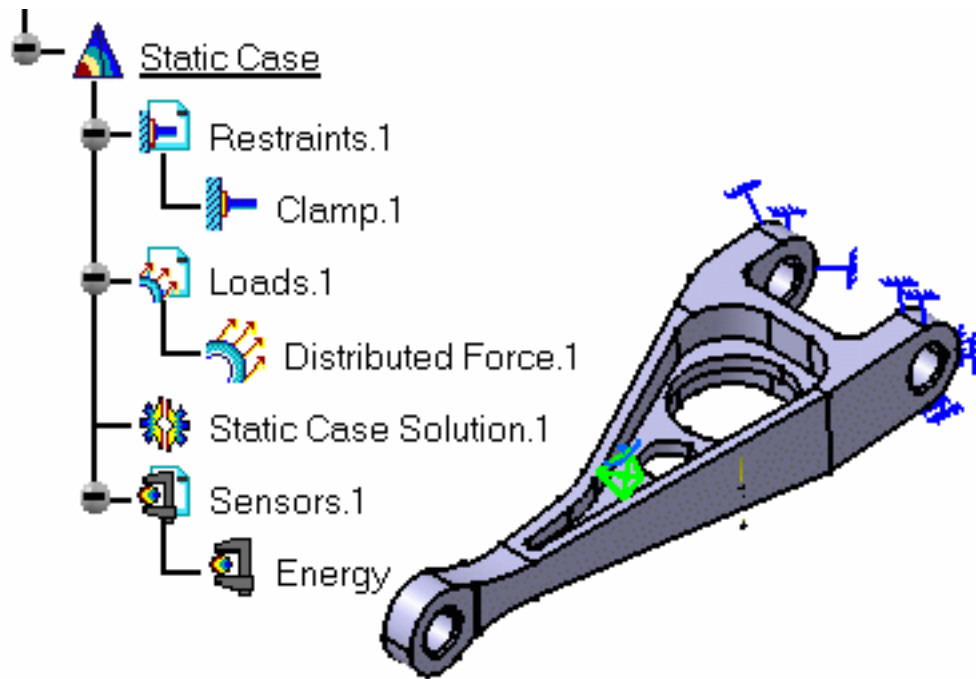

Why does the "Entity cannot be updated" error message appear? 

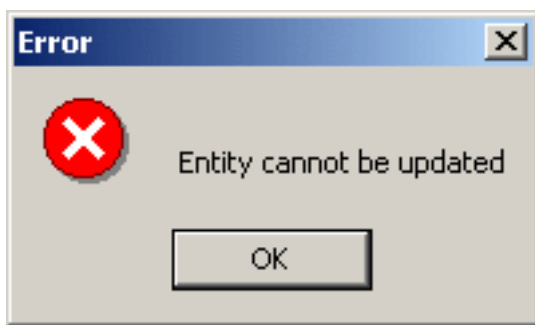

Some inconsistencies were found on the part or the product.



[Check the model](#) to find which specifications are not consistent with the part or the product.

# Licensing

This section gives you information about the licensing in the Generative Structural Analysis workbench.

What are the available products in the Generative Structural Analysis Workbench?  
Which functionality belongs to which product?  
Which contextual menu belongs to which product?

---

## What are the available products in the Generative Structural Analysis workbench?



The Generative Structural Analysis workbench includes the following products:

### **GPS: Generative Part Structural Analysis (P2)**

Addresses transparent and automatic stress and vibration analysis for parts, integrating simulation and design specifications, with the core application of V5 analysis.

### **EST: ELFINI Structural Analysis (P2)**

Performs advanced pre, post processing and solving with complementary analysis options.

### **GAS: Generative Assembly Structural Analysis (P2)**

Addresses transparent, integrated and automatic stress and vibration analysis for assemblies of parts integrating simulation and design specifications.

### **GDY: Generative Dynamic Response Analysis (P2)**

Gives access to the functionalities of dynamic computations.

## Positioning the products

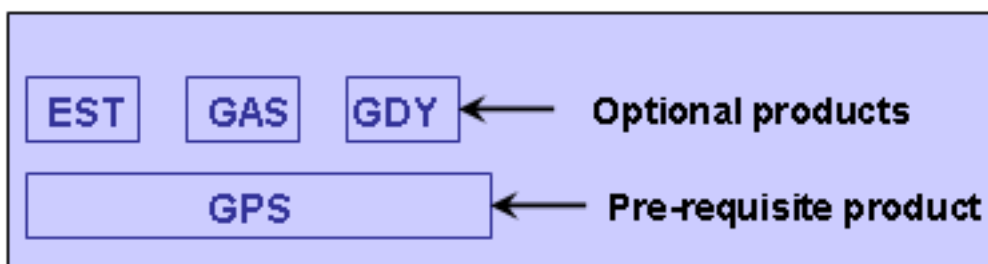









































































# Which functionality belongs to which product?



The following table shows you in which product you will access the analysis functionalities:

<b>Analysis Cases</b>		<b>GP1</b>	<b>GPS</b>	<b>EST</b>	<b>GAS</b>	<b>GDY</b>
	Static Case	 *	 *			
	Static Constrained Case					
	Frequency Case		 *			
	Buckling Case					
	Combined Case					
	Harmonic Dynamic Response					
	Transient Dynamic Response					
<p>* some functionalities in these commands are only available if you previously installed EST product (for more details see the documented task itself).</p>						
<b>Modulation</b>		<b>GP1</b>	<b>GPS</b>	<b>EST</b>	<b>GAS</b>	<b>GDY</b>
	White Noise Modulation					
	Import Frequency Modulation					
	Import Time Modulation					
<b>Model Manager</b>		<b>GP1</b>	<b>GPS</b>	<b>EST</b>	<b>GAS</b>	<b>GDY</b>
	3D Mesh Part					
	2D Mesh Part					
	1D Mesh Part					
	Local Mesh Sizes					

	Local Mesh Sags					
	Element Type					
	3D property					
	2D property					
	Imported composite property					
	1D property					
	Imported Beam Property					
	Check the Model					
	User Material					

\* some functionalities in these commands are only available if you previously installed EST product (for more details see the documented task itself).

Mesh Specifications		GP1	GPS	EST	GAS	GDY
---------------------	--	-----	-----	-----	-----	-----

	Adaptivity Boxes					
---	------------------	--	---	---	--	--

Groups		GP1	GPS	EST	GAS	GDY
--------	--	-----	-----	-----	-----	-----

	Group Points					
---	--------------	--	--	---	--	--

	Group Lines					
---	-------------	--	--	---	--	--

	Group Surfaces					
---	----------------	--	--	---	--	--

	Group Bodies					
---	--------------	--	--	---	--	--

	Box Group					
---	-----------	--	--	---	--	--

	Sphere Group					
---	--------------	--	--	---	--	--































	Point Group by Neighborhood					
---	-----------------------------	--	--	---	--	--































	Line Group by Neighborhood					
---	----------------------------	--	--	---	--	--

	Surface Group by Neighborhood					
---	-------------------------------	--	--	---	--	--































	Analysis Connections					
---	----------------------	--	--	--	--	--

Analysis Connections		GP1	GPS	EST	GAS	GDY
----------------------	--	-----	-----	-----	-----	-----

	General Connections					
	Point Analysis Connections					
	Point Analysis Connections within one Part					
	Line Analysis Connections					
	Line Analysis Connections within one Part					
	Surface Analysis Connections					
	Surface Analysis Connections within one Part					
<b>Connection Properties</b>		<b>GP1</b>	<b>GPS</b>	<b>EST</b>	<b>GAS</b>	<b>GDY</b>
	Fastened Connection Property					
	Fastened Spring Connection Property					
	Slider Connection Property					
	Contact Connection Property					
	Pressure Fitting Connection Property					
	Bolt Tightening Connection Property					
	Virtual Rigid Bolt Tightening Connection Property					
	Virtual Spring Bolt Tightening Connection Property					
	Rigid Connection Property					
	Smooth Connection Property					
	User-Defined Distant Connection Properties					
	Spot Welding Connection Properties					
	Seam Weld Connection Properties					

	Surface Weld Connection Properties					
<b>Virtual Parts</b>		<b>GP1</b>	<b>GPS</b>	<b>EST</b>	<b>GAS</b>	<b>GDY</b>
	Rigid Virtual Parts					
	Smooth Virtual Parts					
	Contact Virtual Parts					
	Rigid Spring Virtual Parts					
	Spring Smooth Virtual Parts					
	Periodicity Conditions					
<b>Mass Equipment</b>		<b>GP1</b>	<b>GPS</b>	<b>EST</b>	<b>GAS</b>	<b>GDY</b>
	Distributed Mass		 *			
	Line Mass Densities		 *			
	Surface Mass Densities		 *			
	Inertia on Virtual Parts					







\* some functionalities in these commands are only available if you previously installed EST product (for more details see the documented task itself).

<b>Restraints</b>		<b>GP1</b>	<b>GPS</b>	<b>EST</b>	<b>GAS</b>	<b>GDY</b>
	Clamps	 *	 *			
	Surface Sliders	 *	 *			
	Ball Joints	 *	 *			
	Sliders	 *	 *			
	Pivots	 *	 *			
	Sliding Pivots	 *	 *			
	Advanced Restraints	 *	 *			
	Iso-static Restraints	 *	 *			





















\* some functionalities in these commands are only available if you previously installed EST product (for more details see the documented task itself).

<b>Loads</b>		<b>GP1</b>	<b>GPS</b>	<b>EST</b>	<b>GAS</b>	<b>GDY</b>
	Pressures	 *	 *			
	Distributed Force	 *	 *			
	Moment	 *	 *			
	Bearing Load					
	Importing Forces					
	Importing Moments					
	Line Force Density	 *	 *			
	Surface Force Density	 *	 *			
	Body Force	 *	 *			
	Force Density					
	Acceleration	 *	 *			
	Rotation Force	 *	 *			
	Enforced Displacement	 *	 *			
	Creating Temperature Field					













\* some functionalities in these commands are only available if you previously installed EST product (for more details see the documented task itself).

















<b>Sensors</b>		<b>GP1</b>	<b>GPS</b>	<b>EST</b>	<b>GAS</b>	<b>GDY</b>
	Create Global Sensors					
	Create Local Sensors		 *			
	Create Reaction Sensors					

\* some functionalities in these commands are only available if you previously installed EST product (for more details see the documented task itself).

<b>Results Computation</b>		<b>GP1</b>	<b>GPS</b>	<b>EST</b>	<b>GAS</b>	<b>GDY</b>
	Specify External Storage					
	Clear External Storage					
	Temporary Data Directory					
	Computing Object sets	 *	 *			
	Computing with Adaptivity		 *			
	Computing using a Batch					























\* some functionalities in these commands are only available if you previously installed EST product (for more details see the documented task itself).

















<b>Results Visualization</b>		<b>GP1</b>	<b>GPS</b>	<b>EST</b>	<b>GAS</b>	<b>GDY</b>
	Visualize Deformation	 *	 *			
	Visualize Von Mises Stresses	 *	 *			
	Visualize Displacements	 *	 *			
	Visualize Principal Stresses	 *	 *			
	Visualize Precisions	 *	 *			
	Reporting					
	Advanced Reporting					
	Historic of Computation					
	Elfini Listing					
	Animate Image					
	Cut Plane Analysis					

	Amplification Magnitude					
	Extrema Detection					
	Information					
	Images Layout					
	Simplified Representation					
<p>* some functionalities in these commands are only available if you previously installed EST product (for more details see the documented task itself).</p>						

## Which contextual menu belongs to which product?

The following table shows you in which products you will access the contextual menus.

Contextual Menu	GP1	GPS	EST	GAS	GDY
 Update Group					
 Update All Groups					
 Analyse Group					
 Local 2D Property					
 Local Beam Property					
Change Type					
 Local Adaptivity					
 Mesh Visualization on Finite Element Model set					
 Restraint visualization on mesh restraints					

 Pressure visualization on mesh pressure					
 Generate Image					
 Save As New Template					
 Report					
 Export Data					
 Generate 2D Display for sensor					
 Generate 2D Display for modulation					
 Generate 2D Display for dynamic response solutions					

\* some functionalities in these contextual menus are only available if you previously installed EST product (for more details see the documented task itself).





# Integration with Product Engineering Optimization

This section gives you information about the analysis data authorized in the **Product Engineering Optimization (PEO)** product.



For more details about the algorithm for constraints and derivatives providers, please refer to the *Product Engineering Optimization User's Guide - Basic Tasks - Using a Dedicated Structural Analysis Algorithm*.

[What are the authorized sensors?](#)  
[What are the restrictions?](#)

---

## What are the authorized sensors?



You can find here what are the analysis sensors authorized in the algorithm for derivatives providers of the **Product Engineering Optimization (PEO)** product.

	Authorized Sensors
Global Sensors	<b>Mass</b>
Local Sensors	All (except the <b>Von Mises Stress</b> local sensor) *

\* only if the local sensor has been defined with **None** or **Average** as **Post-Treatment** option.

---

## What are the restrictions?



You can find here the restrictions when using analysis sensors in the derivatives computation.

- Only the structural parameters (parameters that do not impact the mesh) will be taken into account in the derivatives computation.

The geometrical parameters (those whose the variation invalidates the mesh) must not be taken into account in the derivatives computation.

Open the [sample17.CATAnalysis](#) document from the samples directory. In this particular example, you can find a 2D body and a 3D body.

- The **Thickness** parameter (defined in the **2D Property**) can be referenced in the optimization because its variation does not impact the 2D mesh.
- The **Length** parameter (defined in the **Pad**) cannot be referenced in the optimization because its variation impacts the 3D mesh.
- Analysis sensors will have to expose one single output parameter to be used as objectives inside the **Product Engineering Optimization (PEO)** product:
  - local sensor with post-treatment
  - global sensor with a single output parameter
- The sensors must have been defined in a mono-occurrence solution.

You cannot use analysis sensors belonging to a multi-occurrence solution (**Frequency Case**, a **Buckling Case** or **Dynamic Response Case**) in the derivatives computation.

# Glossary



## A

### **acceleration**

A [load](#) that generates a uniform acceleration field over a part.

### **adaptivity boxes**

The local specifications relative to the maximum error in the approximate computed solution relative to the exact solution.

### **adaptivity process**

Any specification required for managing the process that will let you perform adaptivity computation (re-meshing).

### **assembly**

A set of parts, each parts being associated with a material and linked possibly to another one by the means of a connection. Assemblies can be modeled with the product *Generative Assembly Structural Analysis*.

### **analysis connection**

An assembly connections used to specify the boundary interaction between bodies in an assembled system. Once the geometric assembly positioning constraints are defined at the Product level, the user can specify the physical nature of the constraints.

## **axis system**

A combination of three normal and unit sized vectors which defines a reference to express geometric entities coordinates. There are two different axis systems called:

- reference axis system (which corresponds to the model Axis System).
- local axis system, whose vectors are normal or tangent to the selected geometry. The presence of material on one side of the selected geometry does not influence the choice of the vectors directions but the nature of the geometric element determinates whether the local axis system will be Cartesian, circular or revolute.

The reference axis system is symbolized at two locations: the bottom and right side of the workbench (without its origin) and at its real place: the model origin.



## **B**

### **ball joint**

A **restraint** (or *boundary condition*) that generates spherical joints (balls), which allow a rigid body to rotate about a given point (fixes all translation degrees of freedom of a point).

### **bearing load**

A **load** that simulates contact loads applied to cylindrical parts.

### **body force**

A **load** type including volume body force and **mass** body force. This load type is based on the body of the part (that is, its geometry and possibly its mass density). Therefore, body forces represent intensive (volume density-type) quantities, as opposed to forces which are extensive (resultants, i.e., integrals over regions) quantities.

**bolt tightening connection**

An analysis connection that takes into account pre-tension in bolt-tightened assemblies by simulating the tightening between a bolt and a screw.

**boundary condition**

Please refer to [restraint](#).

**buckling case**

A procedure for the computation of the system buckling critical [loads](#) and buckling modes for a given Static Analysis Case.

**C****clamp**

A [restraint](#) (or *boundary condition*) applied to surface or line geometries of the part, for which all points are to be blocked (by imposing their translation value) in the subsequent analysis.

**computation data**

Path to an external storage file directory.

**connection**

A set of constraints between parts at their common interface or a set of constraint modeled by the means of a virtual body between two parts. Using connections, the user can model an assembly prior to analyze it.

**CONSTR-N**

A Finite Element type enabling points of a geometry that are linked together and free to translate in order to preserve the average behavior.

For example, imposing a translation to such a linked group enables all of the included points, free to translate differently than the imposed translation but the center of [mass](#) of the group must correspond to the imposed behavior: the imposed translation. According to the type of the imposed mechanical behavior (kinematical

constraint or [load](#)) the corresponding kinematical, static or dynamic tensor will be respected at the center of mass of the selected group.

This particular element is sufficient to model a smooth interface.

### **contact element**

A Finite Element type enabling two linked points free to translate prevented that the linear contact condition is respected. Once the linear contact condition is reached, the contact element behaves like a RIG-BEAM element. The linked points are only free to translate along the two normal directions of the beam.

### **contact connection**

An analysis connection that prevents bodies from penetrating each other at a common interface.

## D

### **distributed force**

A [load](#) that generates a distributed force system equivalent to a pure force at a point (given force resultant and zero moment resultant).

### **distributed mass equipment**

A non-structural lumped [mass](#) distribution equivalent to a total mass concentrated at a given point.

## E

### **enforced displacement**

A [load](#) that assigns non-zero displacement values to restrained geometric selections.



## **external storage**

A file of the directory where this structured computed data is stored. The link between the .CATAnalysis document and the External Storage is maintained after the end of a session, in a way similar to the link between a .CATPart document and the associated .CATAnalysis document.



## **F**

### **fastened connection**

An analysis connection that fastens bodies together at their common interface.

### **finite element model**

Models with representations used for performing computer-aided engineering analysis (CAEA) of products. They are complementary to computer-aided design (CAD) models, which are mainly geometric representations of products.

### **force**

A force-type [load](#), including tractions, distributed forces and forces transmitted through a virtual rigid body. The latter includes contact, rigid and smooth transmission types.

### **frequency case**

A procedure for the computation of the system vibration frequencies and normal modes for a given non-structural [mass](#) distribution under given [restraints](#).



## **I**

### **image**

A 3D visualization of analysis results on the Finite Element Modeler mesh.

**iso-static restraint**

A statically speaking determinated support generated on a part.

**L****line mass density**

A scalar line **mass** field of given uniform intensity on a curve geometry.

**line force density**

A **load** that generates a line force field of given uniform intensity on a part edge.

**links manager**

All the links managed from the CATAnalysis document to other documents: a part, result data or computation data.

**load**

A distributed force system equivalent to given static resultants, force densities of given intensity or acceleration fields.

**M****mass**

Non-structural mass densities of given intensity.

**mass equipment**

An additional **mass** attached to the geometry (point, line or surface) of the part. It represents a scalar, purely inertial (non-structural) **load**.

**material property**

A link to the material (either 2D or 3D) assigned to the part: name, support and thickness.





**moment**

A transmitted moment-type [load](#), which includes rigid and smooth transmission types.

A load that generates a distributed force system equivalent to a pure couple (given moment resultant and zero force resultant).

**O****OCTREE tetrahedron mesh**

Automatic mesh specifications generating tetrahedron mesh elements and using OCTREE methods.

**P****part**

A 3D entity obtained by combining different features in the Part Design workbench. Please see *Part Design User's Guide* for further information.

**pivot**

A [restraint](#) (or *boundary condition*) that generates conical joints (hinges), which allow a rigid body to rotate around a given axis (fixes all degrees of freedom of a point, except for one rotation).

**pressure**

A [load](#) that generates pressure loads over a surface.

**pressure fitting**

An assembly type which can be modeled with a virtual [restraint](#) or a force, both transmitted through contact. Only normal [loads](#) can be applied or transmitted with such modeling. So moment transmission through this interface cannot be analyzed.

**pressure fitting connection**

An analysis connection that prevents bodies from penetrating each other at a common interface.



## **properties**

Any specification linked to physical properties: material and thickness (surface).

## **R**



### **restraint**

*or boundary conditions*

Any combination of degrees of freedom on a geometry selection.

Generated restraining joins, either on a geometry selection or on a virtual part or still various types of degree of freedom restraints.

### **resultant**

For the Generative Part Structural Analysis product, the resultant indicates an extensive quantity, an integral over a region, opposed to an intensive quantity which indicates a surface (or volume) density-type quantity.

### **result data**

Path to an external storage file directory.

### **RIG-BEAM**

A Finite Element type that rigidly links two points.

### **rigid connection**

An analysis connection that fastens bodies together at a common rigid interface.

### **rotation force**

A [load](#) that generates a linearly varying acceleration field over a part.

## **S**



**sag**

Global sag is the general maximum tolerance between discretization and the real part used for the computation.

Local sag is the maximum tolerance between discretization and the real part applied locally, to a chosen area of the model specified by the user.

**sensors**

A synthesis of analysis results which provide measures that can be re-used in Knowledgeware.

**sensor set**

A set of different types of object can be generated:

- Static case: **misesmax** (Maximum von Mises), **dispmax** (Maximum Displacement), **reaction** (Reaction on geometry associated to restrain and connection specifications) and **globalerror**
- Frequency case: **Frequency** (Represents the frequency value) and **Frequencies** (Represents the list of the frequency values)
- Buckling case: **Buckling Factor**

**size**

Global size is the general size of the longest edge of the finite elements used for the computation.

Local size is an element size different to the general element size and applied locally, to a chosen area of the model specified by the user.

**spot welding connection**

An analysis connection that fastens bodies together at a common soft interface.

**SPRING**

Finite element type which has an elastic behavior along all its degrees of freedom. This element models ideally elastic interfaces between parts.

<b>slider</b>	A generalization of the clamp <a href="#">restraint</a> in the sense that you can release some of the clamped directions thus allowing the part to slide along the released translation directions.
<b>slider connection</b>	An analysis connection that fastens bodies together at their common interface in the normal direction while allowing them to slide relative to each other in the tangential directions.
<b>sliding pivot</b>	A <a href="#">restraint</a> (or <i>boundary condition</i> ) that generates cylindrical joints (actuators) which allow a rigid body to translate about and rotate around a given axis (fixes all degrees of freedom of a point, except for one translation and one rotation).
<b>smooth connection</b>	An analysis connection that fastens bodies together at a common soft interface.
<b>static case</b>	A procedure for the computation of the system response to applied static <a href="#">loads</a> under given <a href="#">restraints</a> .
<b>storage (external)</b>	An optional computation mode that enables the user to define a directory path where a temporary file will receive solver data during the computation.
<b>surface force density</b>	A <a href="#">load</a> that generates a surface traction field of given uniform intensity on a part face.
<b>surface mass density</b>	A scalar surface <a href="#">mass</a> field of given uniform intensity on a surface geometry.

## **surface slider**

A [restraint](#) (or *boundary condition*) that generates surface constraint joins, which allow points of a surface to slide along a coinciding rigid surface (fixes the translation degree of freedom for a surface in the direction of the local normal).



## **T**

### **traction**

An intensive (surface density-type) quantity, as opposed to forces which are extensive (that is, resultant) quantities.



## **V**

### **virtual restraint**

A [restraint](#) applied indirectly to the part, through the action of a *virtual rigid body*. The interface specifications (smooth rigid or contact transmission) are selected by the user.

### **virtual rigid bolt tightening connection**

An analysis connection that takes into account pre-tension in a bolt-tightened assembly with a non-included bolt and an ideal screw.

### **virtual spring bolt tightening connection**











An analysis connection that specifies the boundary interaction between bodies in an assembled system.



# Index









## Numerics

- 1D mesh 
- 1D Property
  - command 
- 2D display
  - editing parameters 
  - for dynamic response solution 
  - for modulation 
  - for sensors 
- 2D mesh 
- 2D Property
  - command 
- 3D mesh 
- 3D Property
  - command 



## A

- Acceleration
  - command 
- Activate/Deactivate
  - contextual menu 
- Adaptivity
  - toolbar 
- adaptivity
  - global 
  - local 
- adaptivity, managing 
- advanced edition for images and local sensors 

advanced report 

Advanced Reporting

command 

Advanced Restraint

command 

Amplification Magnitude

command 

Analysis Assembly

toolbar 

analysis assembly 

basic concept 

graph 

methodology 

Analysis Assembly 2D Viewer

command 

analysis case 

buckling 

combined 

frequency 

harmonic dynamic response 

static 

static constrained 

transient dynamic response 

analysis connection 

general 

line 

line within one part 

point 















point within one part 

surface 

surface within one part 







Analysis Connections

toolbar 

analysis external storage   
analysis general settings   
analysis graphical settings   
analysis post processing setting   
analysis quality settings   
Analysis Results  
    toolbar   
analysis results   
analysis settings  
    customizing   
analysis symbol   
Analysis Tools  
    toolbar   
Analyze Group  
    contextual menu   
Animate  
    command   
animating, image   
associativity 



## B

Ball Join  
    command   
Basic Analysis Report  
    command   
basic concept  
    analysis assembly   
batch, computing using a  
beam  
    mesh   
Beam Mesher  
    command   
beam property, importing 



## Bearing Load

command 

bearing load, creating 

## Body Force

command 

## Body Group

command 

body, grouping 

## Bolt Tightening Connection Property

command 

## Box Group

command 

box, grouping based on 

## buckling

computing a buckling solution 

inserting a buckling case 



# C

## Change Type

contextual menu 

changing element type 

checking, model 

## Clamp

command 

## color palette

editing 

locking 

combined case, inserting 





































## command































1D Property 

2D Property 

3D Property 

Acceleration 

- Advanced Reporting 
- Advanced Restraint 
- Amplification Magnitude 
- Analysis Assembly 2D Viewer 
- Animate 
- Ball Join 
- Basic Analysis Report 
- Beam Mesher 
- Bearing Load 
- Body Force 
- Body Group 
- Bolt Tightening Connection Property 
- Box Group 
- Clamp 
- Compute       
- Compute with Adaptivity 
- Contact Connection Property 
- Contact Virtual Part 
- Cut Plane Analysis 
- Deformation 
- Displacement 
- Distributed Force 
- Distributed Mass 
- Element Type 
- Elfini Listing 
- Enforced Displacement 
- External Storage 
- External Storage Clean-up 
- Fastened Connection Property 
- Fastened Spring Connection Property 
- Force Density 

General Analysis Connection   
Historic of Computations   
Image Extrema   
Image Layout   
Import From File   
Imported Beam Property   
Imported Composite Property   
Imported Force   
Imported Moment   
Inertia on Virtual Part   
Information   
Isostatic Restraint   
Line Analysis Connection   
Line Analysis Connection Within One Part   
Line Force Density   
Line Group   
Line Group by Neighborhood   
Line Mass Density   
Local Mesh Sag   
Local Mesh Size   
Model Check   
Moment   
New Adaptivity Entity   
Octree Tetrahedron Mesher   
Octree Triangle Mesher   
Periodicity Conditions   
Pivot   
Point Analysis Connection   
Point Analysis Connection Within One Part   
Point Group   
Point Group by Neighborhood 

Precision 

Pressure 

Pressure Fitting Connection Property 

Principal Stress 

Rigid Connection Property 

Rigid Spring Virtual Part 

Rigid Virtual Part 

Rotation 

Seam Weld Connection Property 

Slider 

Slider Connection Property 

Sliding Pivot 

Smooth Connection Property 

Smooth Spring Virtual Part 

Smooth Virtual Part 

Sphere Group 

Spot Welding Connection Property 

Stress Von Mises 

Surface Analysis Connection 

Surface Analysis Connection Within One Part 

Surface Force Density 

Surface Group 

Surface Group by Neighborhood 

Surface Mass Density 

Surface Slider 

Surface Weld Connection Property 

Temperature Field 

Temperature Field from Thermal Solution 

Temporary External Storage 

Time Modulation Imported From File 

User Material 

User-Defined Distant Connection Property 

Virtual Bolt Tightening Connection Property 

Virtual Spring Bolt Tightening Connection Property 

White Noise 

composite 

computation

error 

node stresses 

reading a historic 

stresses 

Compute

command       

toolbar 

Compute with Adaptivity

command 

computing

buckling solution 

frequency solution 

harmonic dynamic response solution 

objects sets 

static constrained solution 

static solution 

transient dynamic response solution 

using a batch 

Connection 

toolbar 

connection property 









bolt tightening 

contact 

fastened 

fastened spring 

pressure fitting 

- rigid 
- seam weld 
- slider 
- smooth 
- spot welding 
- surface weld 
- user-defined distant 
- virtual bolt tightening 
- virtual spring bolt tightening 

Contact Connection Property

- command 















Contact Virtual Part

- command 

contextual menu









- Activate/Deactivate 
- Analyze Group 
- Change Type 
- Create Global Sensor 
- Create Local Sensor 
- Create Reaction Sensor 
- Export Data 
- Expot Data... 
- Generate 2D Display   
- Generate Image 
- Load 
- Local 1D Property 
- Local 2D Property 
- Local Adaptivity 
- Save As New Template 
- Unload 
- Update All Groups 
- Update Group 

Create Global Sensor

contextual menu   
Create Local Sensor  
contextual menu   
Create Reaction Sensor  
contextual menu   
creating  
clamp   
distributed force   
global sensor   
local sensor   
moment   
reaction sensor   
creating images   
creation, extrema   
customizing  
analysis settings   
cut plane   
Cut Plane Analysis  
command 



## D

damping   
data mapping   
Deformation  
command   
deformation, visualizing   
deformed mesh   
Displacement  
command   
displacement, visualizing   
Distributed Force  
command 

## Distributed Mass

command 

dynamic excitation formula 

dynamic response

dynamic response set 

inserting a harmonic dynamic response case 

inserting a transient dynamic response case 



## E

editing

2D display parameters 

color palette 

image 

user isotropic material 

Element Type

command 

element type, changing 

Elfini Listing

command 

Enforced Displacement

command 

entering the Generative Structural Analysis 

error

computation 

error maps, visualizing 

error messages 

estimated local error image 

export 2D Display data 

Export Data







contextual menu 

Expot Data...

contextual menu 











External Storage



- command 
- external storage
  - clearing 
  - specifying 
  - temporary 
- External Storage Clean-up
  - command 
- extrema, creation 



























## F

- Fastened Connection Property
  - command 
- Fastened Spring Connection Property
  - command 
- FICELF file 
- finite element model, creating 
- force
  - importing 
- Force Density
  - command 
- free groups 
- frequency
  - computing a frequency solution 
  - inserting a frequency case 
- frequency modulation
  - imported from an existing file 
- frequent error messages 





## G

- general
  - analysis connection 
- General Analysis Connection

command   
Generate 2D Display  
contextual menu     
Generate Image  
contextual menu   
generating, image   
geometrical groups   
global  
adaptivity   
global sensor   
group   
free   
geometrical   
proximity   
grouping  
based on box   
based on sphere   
body   
line   
point   
surface   
grouping by neighborhood  
line   
point   
surface   
Groups  
toolbar 



## H

harmonic dynamic response solution  
computing   
historic of computation, reading a 

## Historic of Computations

command 



## I

### Image

toolbar 

### image

animating 

editing 

generating 



image creation 

Image Edition dialog box 

### Image Extrema

command 

### Image Layout

command 

### images

advanced edition 

### Import From File

command 

### Imported Beam Property

command 

### Imported Composite Property

command 

### Imported Force

command 

### Imported Moment

command 

### importing

force 

moment 

temperature field 

improving performances on multi-processor computers 

### Inertia on Viratual Part

command 

inertia relief 

Information

command 

inserting

buckling case 

combined case 

frequency case 

harmonic dynamic response case 

static case 

static constrained case 

transient dynamic response case 

integration with Product Engineering Optimization  

Isostatic Restraint

command 



## K

knowledge parameters for sensors 



## L

licensing 

line

analysis connection 

Line Analysis Connection

command 

Line Analysis Connection Within One Part

command 

Line Force Density

command 

Line Group

command 

## Line Group by Neighborhood

command 

## Line Mass Density

command 

## line within one part

analysis connection 

## line, grouping

## line, grouping by neighborhood

## listing

## Load

contextual menu 

toolbar 

## load

acceleration 

bearing load 

body force 

distributed force 

enforced displacement 

force density 

imported force 

line force density 

moment 

pressure 

rotation force 

surface force density 

temperature field 

temperature field from thermal solution 

## load excitation

## local

adaptivity 

## Local 1D Property

contextual menu 

## Local 2D Property

contextual menu 

Local Adaptivity

contextual menu 

Local Mesh Sag

command 

Local Mesh Size

command 

local sensor 

local sensors

advanced edition 

locking

color palette 



## M

managing, adaptivity 

Mass

toolbar 

mass

distributed mass 

line mass density 

surface mass density 

mass equipment 

material

physical properties 

mesh

1D or beam 

2D 

3D 

methodology

analysis assembly 

Model Check

command 

Model Manager

toolbar 

model manager 

Modulation

toolbar 

modulation 

white noise 

Moment

command 

moment

creating 

importing 

multi-processor computers 



## N

New Adaptivity Entity

command 

node stresses

computation 



## O

Octree Tetrahedron Mesher

command 

Octree Triangle Mesher

command 



## P

Periodicity Conditions

command 

physical properties

material 

Pivot

command 

point

analysis connection 

Point Analysis Connection

command 

Point Analysis Connection Within One Part

command 

Point Group

command 

Point Group by Neighborhood

command 

point within one part

analysis connection 

point, grouping 

point, grouping by neighborhood 

post-processing 

results and images 

Precision

command 

precision, visualizing 

Pressure

command 

Pressure Fitting Connection Property

command 

Principal Stress

command 

principal stress, visualizing 

property

1D 

2D 

3D 

composite 

imported beam 

local 1D 

local 2D 



proximity group 



## R

reaction sensor 

report 

Restraint

    toolbar 

restraint 

    advanced 

    ball joint 

    clamp 

    iso-static restraint 

    pivot 

    slider 

    sliding pivot 

    surface slider 

restraint excitation 

result visualization 

Rigid Connection Property

    command 

Rigid Spring Virtual Part

    command 

Rigid Virtual Part

    command 

rigid virtual part 

Rotation

    command 

rotation force 



## S

Save As New Template

contextual menu 

Seam Weld Connection Property

command 

self-balancing on loads set 

sensor 

displaying knowledge parameters 

global 

local 

reaction 

singularity 

slave process 

Slider

command 

Slider Connection Property

command 

Sliding Pivot

command 

Smooth Connection Property

command 

Smooth Spring Virtual Part

command 

Smooth Virtual Part

command 

solver computation 

solver process 

Solver Tools toolbar 

specification

local mesh sag 

local mesh size 

specification tree, analysis 

Sphere Group

command 

sphere, grouping based on 

Spot Welding Connection Property

command 

static

computing a static solution 

inserting a static case 

static constrained

computing a static constrained solution 

inserting a static constrained case 

Stress Von Mises

command 

stresses

computation 

surface

analysis connection 

Surface Analysis Connection

command 

Surface Analysis Connection Within One Part

command 

Surface Force Density

command 

Surface Group

command 

Surface Group by Neighborhood

command 

Surface Mass Density

command 

Surface Slider

command 

Surface Weld Connection Property

command 

surface within one part

analysis connection 

surface, grouping 

surface, grouping by neighborhood 



# T

Temperature Field

command 

Temperature Field from Thermal Solution

command 

template, save as new 

Temporary External Storage

command 

temporary external storage, specifying  
time modulation 

imported from an existing file 

Time Modulation Imported From File

command 

toolbar

Adaptivity 

Analysis Assembly 

Analysis Connections 

Analysis Results 

Analysis Tools 

Compute 

Connection 

Groups 

Image 

Load 

Mass 

Model Manager 

Modulation 

Restraint 

Solver Tools 

Virtual Part 

Tools Options - Analysis and Simulation 

External Storage 

General 

Graphics 

Post Processing 

Quality 

transient dynamic response solution

computing 

translational displacement 



## U

Unload

contextual menu 

Update All Groups

contextual menu 

Update Group

contextual menu 

user isotropic material

editing 

User Material

command 

User-Defined Distant Connection Property

command 

utility

AnalysisUpdateBatch 



## V

Virtual Bolt Tightening Connection Property

command 

Virtual Part

toolbar 

virtual part 

contact 

rigid 

rigid spring 

smooth 

smooth spring 

Virtual Spring Bolt Tightening Connection Property

command 

visualization 

visualization, results 

visualizing

deformation 

displacement 

precision 

principal stress 

Von Mises Stress 

Von Mises Stress, visualizing 



## W

White Noise

command 

white noise modulation 

