



CATIA V5 Training
Foils

Generative Assembly Structural Analysis

Version 5 Release 19
September 2008
EDU_CAT_EN_GAS_FI_V5R19

Copyright DASSAULT SYSTEMES

Instructor Notes:

About this course

Objectives of the course

Upon completion of this course you will be able to:

- Understand what types of hypotheses are used for an assembly analysis
- Define analysis connections between assembly components
- Use existing assembly constraints to automatically create connections
- Assign a connection property to the appropriate analysis connection
- Compute a static analysis for an assembly
- Create and manage an analysis assembly model from existing meshed parts

Targeted audience

Mechanical Designers

Prerequisites

Students attending this course should have knowledge of CATIA V5 Fundamentals, Generative Part Structural Analysis Fundamentals



1 Day

Copyright DASSAULT SYSTEMES

Instructor Notes:

Table of Contents (1/3)

• Introduction to GAS	6
• What is Generative Assembly Structural Analysis	7
• Assembly Analysis Overview	9
• Analysis Assembly Overview	10
• what is GAS	11
• Hypotheses Used for Analysis	12
• To sum Up	13
• Analysis Connections	14
• What is Analysis Connection	15
• General Analysis Connection	21
• Defining Line Analysis Connections	25
• Defining Point Analysis Connections	32
• Defining Surface Analysis Connections	38
• Points to Points Analysis Connection	45
• Set of Analysis Connections	48
• To Sum Up	52
• GAS Connection Properties	53
• Face Face Connection Properties	54

Copyright DASSAULT SYSTEMES

Instructor Notes:

Table of Contents (2/3)

◆ Distant Connection Properties	76
◆ Welding Connection Properties	95
◆ Nodes to Nodes Connection Property	102
◆ To Sum Up	105
◆ Analysis Assembly Management	106
◆ What is Analysis Assembly	107
◆ Why Use Analysis Assembly	108
◆ Analysis Assembly Process	109
◆ What is Shape Representation	110
◆ How to Attach Shape to Part	111
◆ How to Attach Analysis Document in Product Tree	113
◆ How to Attach Orphan Mesh Analysis Document	115
◆ What is Analysis Assembly 2D Viewer	117
◆ How to Use Analysis Assembly 2D Viewer	118
◆ Analysis Assembly Recap Exercise	119
◆ To Sum Up	121
◆ Master Exercise	123
◆ Assembly Analysis Presentation	124

Instructor Notes:

Table of Contents (3/3)

◆ Static Analysis on an Assembly (1): Pre-Processing	125
◆ Static Analysis on an Assembly (2): Computation	126
◆ Static Analysis on an Assembly (3): Results Visualization	127
◆ Static Analysis on an Assembly (4): Publishing Report	128

Copyright DASSAULT SYSTEMES

Instructor Notes:

Introduction to GAS

You will learn the rules necessary to a good understanding and use of GAS

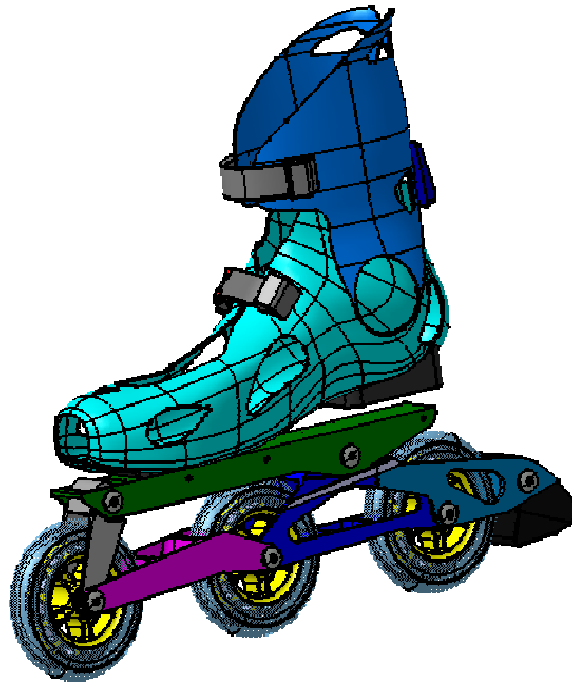

Copyright DASSAULT SYSTEMES

Instructor Notes:

What is Generative Assembly Structural Analysis (1/2)

Generative Assembly Structural Analysis (GAS) is a tool to perform structural analysis of assemblies. It provides features to model physical assemblies into Finite Element Assemblies.

While designing, structural analysis of individual parts is performed. These parts are commonly components of a product.

For example, analysis of crank shaft helps to understand structural, dynamic behavior under applied load, and to improve the design.



Crank shaft is one part of engine assembly which also contains connecting rod, pin, piston, bolts etc.



Once these individual parts are assembled, it is necessary to understand structural and dynamic behavior of assembly. Therefore, assembly analysis is required.

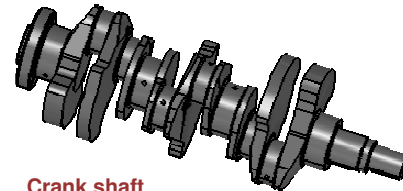

Crank shaft

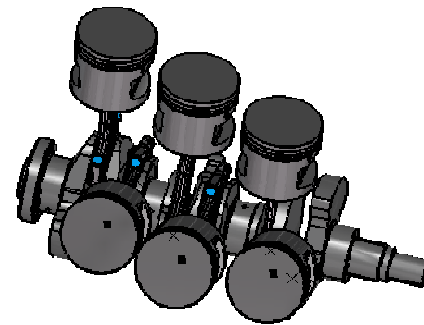

Crank shaft in engine assembly

Instructor Notes:

What is Generative Assembly Structural Analysis (2/2)

We have two basic approaches to perform Generative Assembly Structural analysis.

Assembly Analysis:

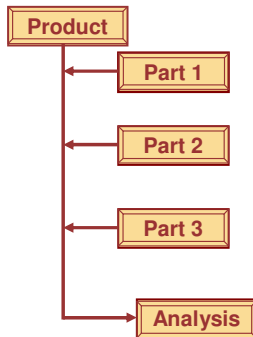

In this approach you create the assembly and analyze it.

Analysis Assembly:

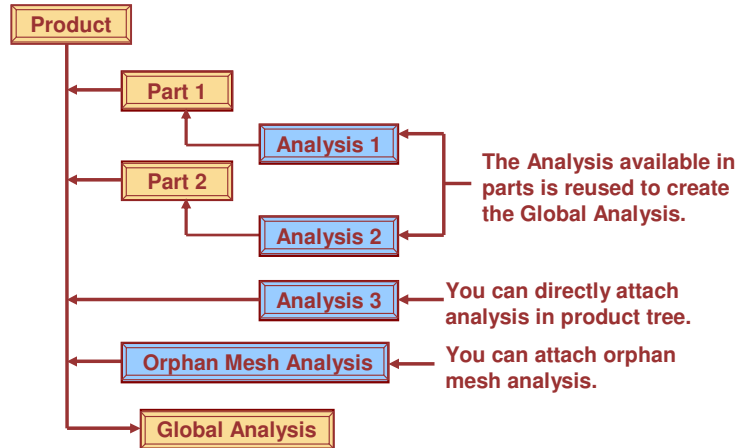

In this approach, analyses of individual parts in product are available. This analyses are assembled to form 'Analysis Assembly' and then final analysis called 'Global analysis' is performed.

Copyright DASSAULT SYSTEMES

Instructor Notes:

Assembly Analysis Overview



1 Assign Finite Element properties to parts in assembly

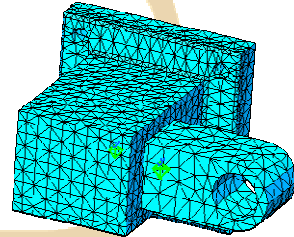

2 Assign connection and connection properties

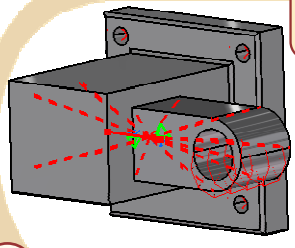

3 Perform analysis and view results

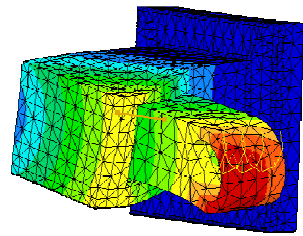

Copyright DASSAULT SYSTEMES

Instructor Notes:

Analysis Assembly Overview

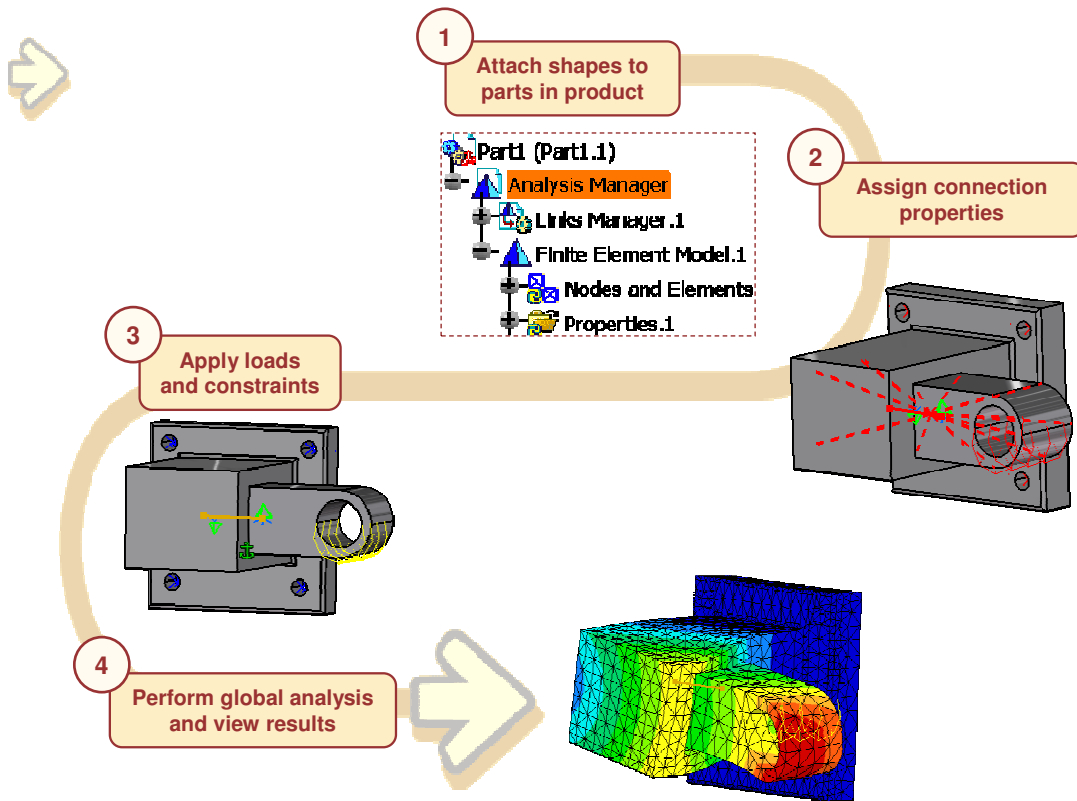

Instructor Notes:

What is GAS

The GAS license provides functionalities for analysis of assembly, through the GPS workbench. It allows you to define connections between assembly components and assign different types of connection properties to these connections to simulate the real connection behavior.

In other words, 'GAS' allows you to define real constraints besides assembly constraints using connection properties. It lets you define four different kinds of connection properties:

- Face/Face Connection properties



- Distant Connection properties



- Welding Connection properties



- Point Based Connection Properties

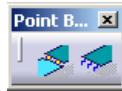

However, you must have previously defined 'Assembly constraints' or 'Analysis Connections' using GAS Workbench to be able to create the connection properties between the parts of assemblies. By the way, you must make sure that your assembly is not over-constrained.

You may also need to add assembly constraints at a given distance (this constraint goes through a virtual point) so that you can simulate a part that is not designed.

Copyright DASSAULT SYSTEMES

Instructor Notes:

Hypotheses Used for Analysis

When you work with the Analysis workbench, three types of hypotheses are made:

- Small displacements (translation and rotation)
- Small strain
- Linear constitutive law: linear elasticity

Thus, If there is no contact feature (either virtual or real), no pressure fitting property and no bolt tightening (being virtual or not) feature, then the problem is linear, which means that the displacement is a linear function of the load.

On the other hand, If there is at least one contact feature (either virtual or real) or pressure fitting property or bolt tightening (being virtual or not) feature, then the problem is non linear, which means that the displacement is a non linear function of the load.

Instructor Notes:

To Sum Up ...

You have learned following things about GAS

- What is Generative Structural Assembly Analysis
- Generative Structural Assembly Analysis approaches
- Hypothesis used for Analysis

Copyright DASSAULT SYSTEMES

Instructor Notes:

Analysis Connections

In this lesson, you will see what are the different types of GAS Analysis Connections, necessary to define support for Analysis Connection properties.

- What is Analysis Connection
- General Analysis Connection
- Defining Line Analysis Connections
- Defining Point Analysis Connections
- Defining Surface Analysis Connections
- Points to Points Analysis Connection
- Set of Analysis Connections
- To Sum Up

Instructor Notes:

Analysis Connection

You will learn what is Analysis Connection and why it is required.

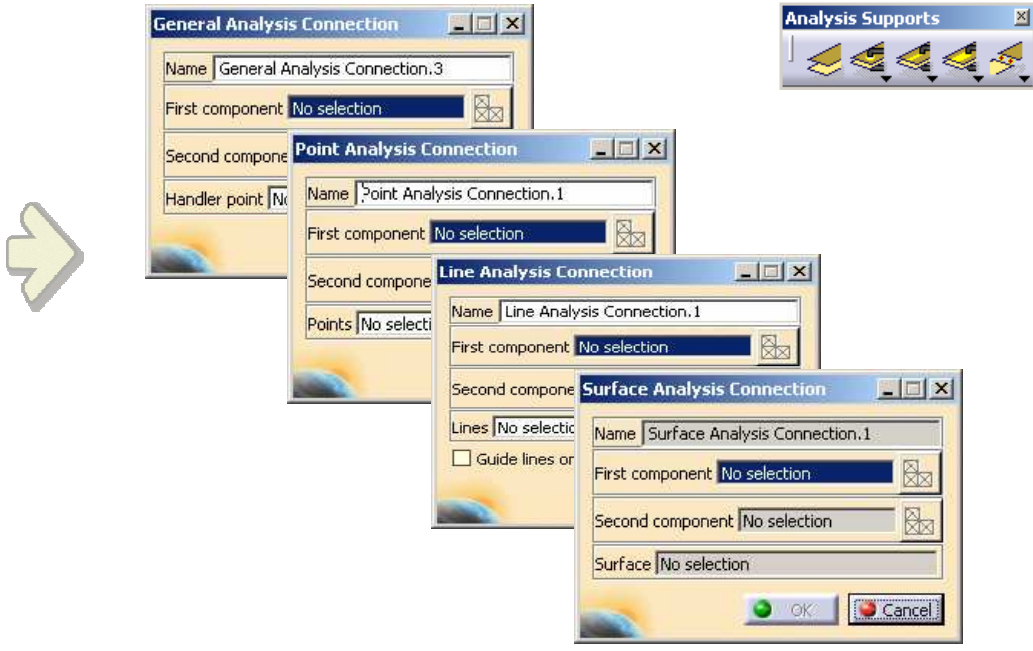

Copyright DASSAULT SYSTEMES

Instructor Notes:



Why Use Connections and Connection Properties

GAS has made conversion of physical assemblies to FE assemblies very easy by means of connection and their connection properties. Wide variety of connection types and connection properties are provided to model physical assembly connections.

When parts are connected to each other, they transmit rotational and translational DOFs in a well defined manner. In addition to this, connection itself has structural properties which need to be taken into account.

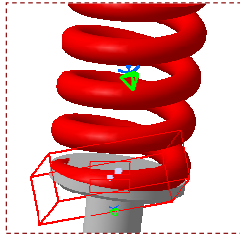

For example, when two parts are connected through spring joint, the spring stiffness will also play a role. This stiffness will dictate the amount of displacement transferred from one part to another. This can also be viewed for welded or bolted assemblies.

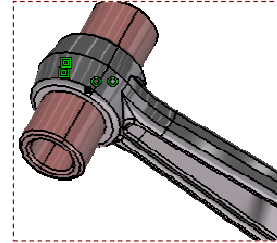

Connection defines which parts in assembly are connected and connection property assigns related physical properties to those connections. You can also effectively utilize the constraints defined in assembly as support in connection properties.

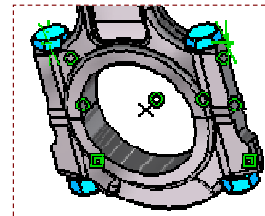

Copyright DASSAULT SYSTEMES













Instructor Notes:

Using Assembly Constraints for Analysis Connections

You can use either following assembly constraints or corresponding analysis connection as support for creating connection property. Thus, if Assembly constraints are already defined then there is no need to create analysis connection as a support for creating connection property.

You need to create analysis connection if assembly constraint is not available for required joint. You will see which are the most appropriate constraints for each kind of connection.



	Coincidence constraint			General Analysis Connection
	Contact constraint			Line Analysis Connection
	Offset constraint			Point Analysis Connection
	Fix constraint			Surface Analysis Connection











The following matrices show you, with respect to the connection type, what constraints are necessary for their creation. You will notice that, some connections (like rigid or smooth) can be applied on different kinds of constraints while others can be applied on a specific constraint only.

Copyright DASSAULT SYSTEMES

Instructor Notes:

What Assembly Constraint to Use for What Connection

You will see which are the most appropriate constraints for each kind of connection.

Connections	Point / Point	Point / Line	Point / Face	Line / Line	Line / Face	Face / Face
Slider 				Contact	Contact	Contact
				Coincidence	Coincidence	Coincidence
Contact 				Contact	Contact	Contact
				Coincidence	Coincidence	Coincidence
Fastened 				Contact	Contact	Contact
				Coincidence	Coincidence	Coincidence
Fastened Spring 				Contact	Contact	Contact
				Coincidence	Coincidence	Coincidence
Pressure Fitting 				Contact	Contact	Contact
				Coincidence	Coincidence	Coincidence
Bolt Tightening 				Contact	Contact	Contact
				Coincidence	Coincidence	Coincidence
Rigid 		Contact	Contact	Contact *	Contact *	Contact *
Smooth 		Contact	Contact	Contact *	Contact *	Contact *
Virtual Rigid Bolt Tightening 		Contact	Contact	Contact	Contact	Contact
		Coincidence	Coincidence	Coincidence	Coincidence	Coincidence
Virtual Spring Bolt Tightening 		Contact	Contact	Contact	Contact	Contact
		Coincidence	Coincidence	Coincidence	Coincidence	Coincidence
		Offset	Offset	Offset	Offset	Offset
User-Defined 	Contact	Contact	Contact	Contact	Contact	Contact

* with optional handler point

Copyright DASSAULT SYSTEMES

Instructor Notes:

How to Use Assembly Constraints in Connection Property

You can use appropriate assembly constraints as support in connection property. It is not necessary to create Analysis Connection if corresponding Assembly constraint is available.

1 Click on Smooth Connection Property



2 Select Surface contact constraint as in supports

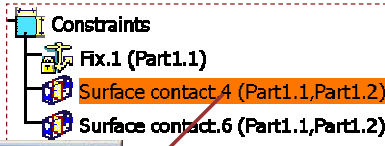

3 Click OK

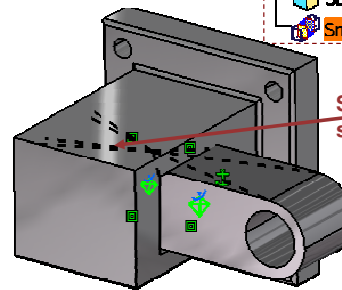
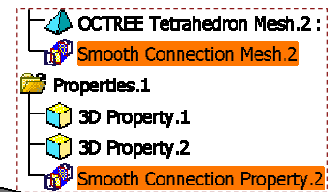

Smooth connection symbol. (dotted lines)

Copyright DASSAULT SYSTEMES

Instructor Notes:

Common Tools

All “seam” connections (Point, Line, Surface connections) can be applied directly on mesh parts

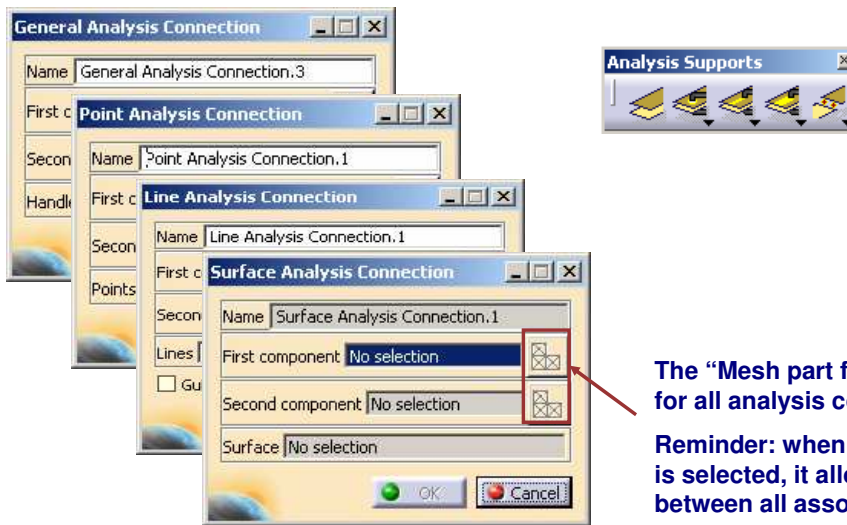

The “Mesh part filter” tool is available for all analysis connections

Reminder: when a geometrical support is selected, it allows you to choose between all associated mesh parts



It enables connection definition for orphan meshes (imported meshes)

Copyright DASSAULT SYSTEMES

Instructor Notes:

General Analysis Connection

You will learn how to define a General Analysis Connection and when to use it

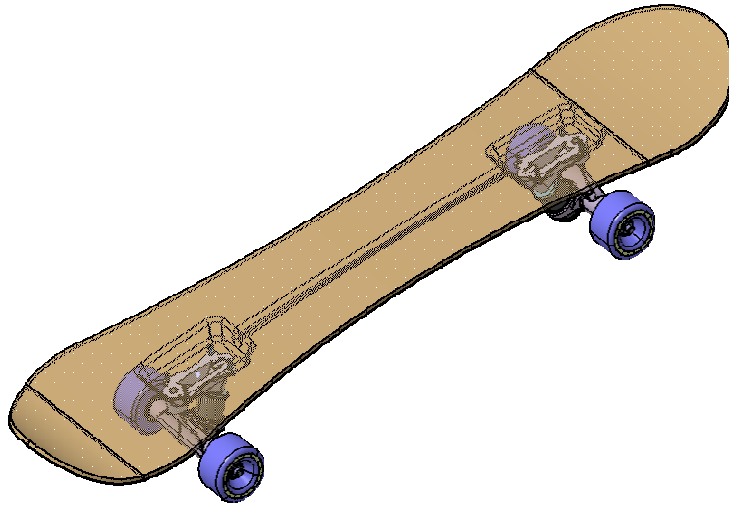

Copyright DASSAULT SYSTEMES

Instructor Notes:

What is a General Analysis Connection

General Analysis Connection is used for connecting any part from an assembly with or without point type geometrical elements.

The “General” connection is available in the “Analysis Connections” toolbar:

It can be performed between any type of geometry.

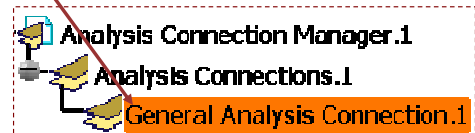
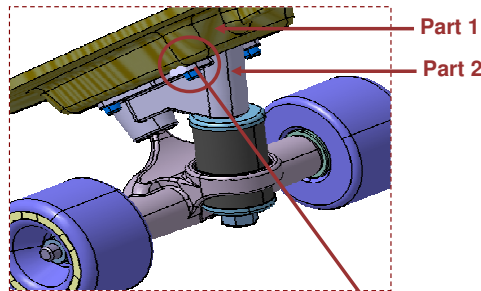
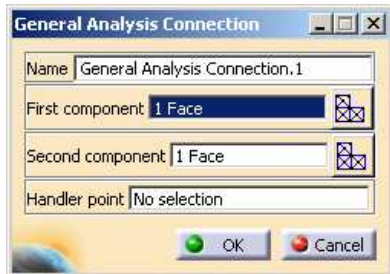

Copyright DASSAULT SYSTEMES

Instructor Notes:

How to apply a General Analysis Connection

1 Click on the "General Connection" icon

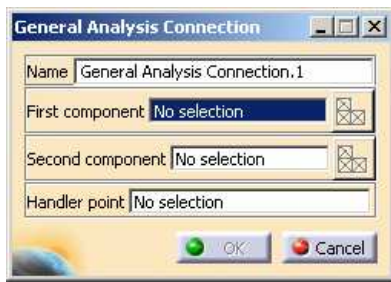

2 Select the first component

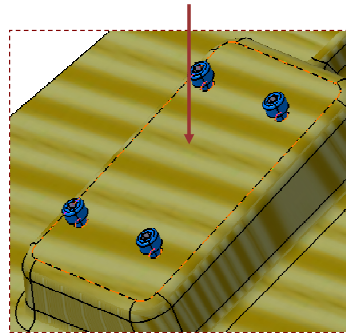

3 Select the 2nd component

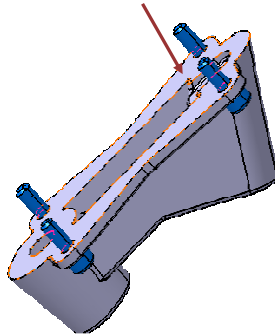

4 Click on Ok

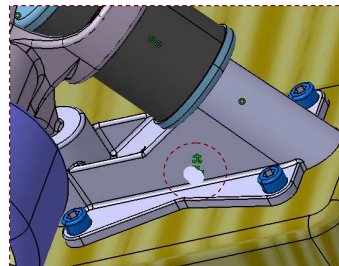











Copyright DASSAULT SYSTEMES

Instructor Notes:

When to Use the General Analysis Connection

In most cases, a General Analysis Connection can be used as support for the following connection properties.

Connection Properties		Point / Point	Point / Line	Point / Face	Point / Mechanical Feature	Line / Line	Line / Face	Line / Mechanical Feature	Face / Face	Face / Mechanical Feature	Mechanical Feature / Mechanical Feature
Slider			Yes	Yes	Yes	Yes	Yes	Yes	Yes	Yes	Yes
Contact			Yes	Yes	Yes	Yes	Yes	Yes	Yes	Yes	Yes
Fastened			Yes	Yes	Yes	Yes	Yes	Yes	Yes	Yes	Yes
Fastened Spring			Yes	Yes	Yes	Yes	Yes	Yes	Yes	Yes	Yes
Pressure Fitting Bolt			Yes	Yes		Yes	Yes		Yes		
Tightening			Yes	Yes		Yes	Yes		Yes		
Rigid			Yes	Yes	Yes	Yes*	Yes*	Yes*	Yes*	Yes*	Yes*
Smooth			Yes	Yes	Yes	Yes*	Yes*	Yes*	Yes*	Yes*	Yes*
Virtual Rigid Bolt		Yes	Yes	Yes		Yes	Yes		Yes		
Virtual Spring Bolt		Yes	Yes	Yes		Yes	Yes		Yes		
Tightening User-Defined		Yes	Yes	Yes	Yes	Yes	Yes	Yes	Yes	Yes	Yes

* with optional handler point

Copyright DASSAULT SYSTEMES

Instructor Notes:

Defining Line Analysis Connections

In this lesson you will learn about the different types of Line Analysis Connections.

- ▣ Line Analysis Connection
- ▣ Line Analysis Connection within one Part

Copyright DASSAULT SYSTEMES

Instructor Notes:

Line Analysis Connection

You will learn how to define a Line Analysis connection and how to use it

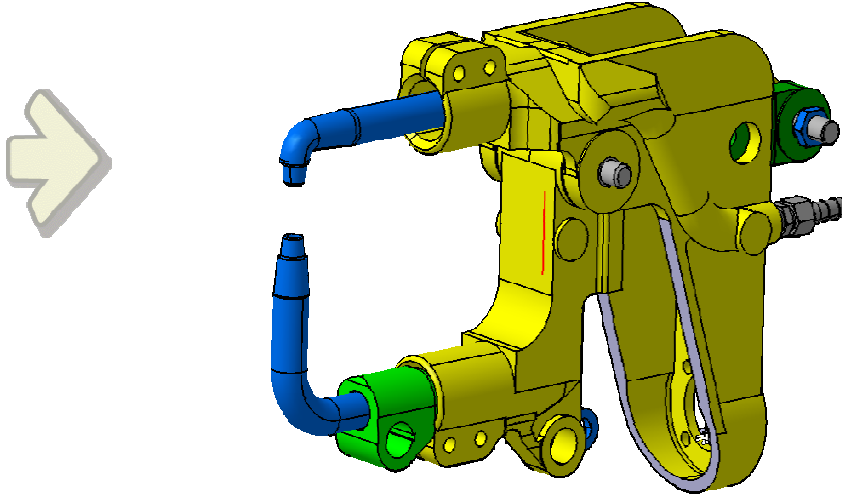

Copyright DASSAULT SYSTEMES

Instructor Notes:

What is Line Analysis Connection



Line Analysis Connections are used to simulate seam welding.

As you can see, the Line Analysis connection needs a line (previously created i.e from GSD).
This line is where the seam welding will be located.

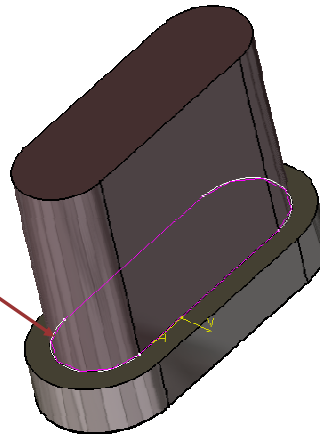
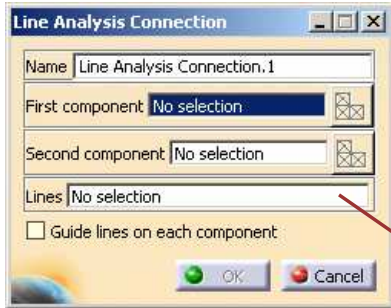

Copyright DASSAULT SYSTEMES

Instructor Notes:

Guide Lines

You can select guide lines on each component.

The option “Guide Lines on each component” allows you to guide the connection orientation by selecting two lines.

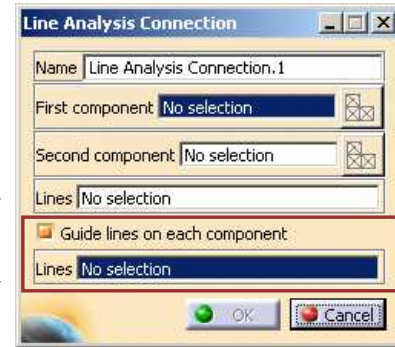
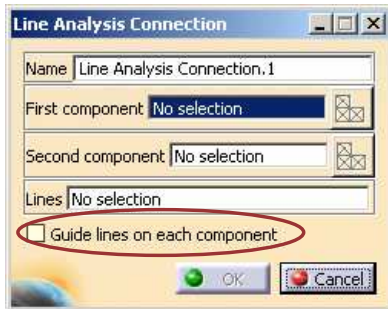

It will provide a better precision for seam weld orientation and enables welding on non-parallel parts

Instructor Notes:

How to apply a Line Analysis Connection

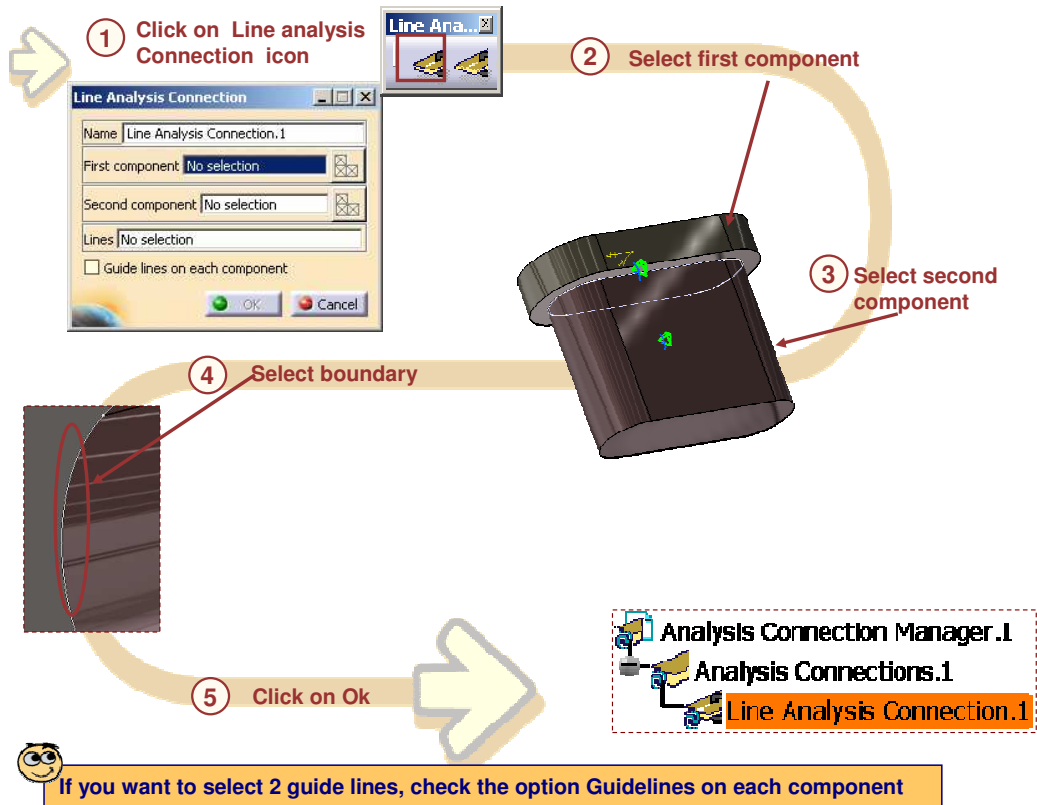

Copyright DASSAULT SYSTEMES

Instructor Notes:

Line Analysis Connection within one Part

You will learn how to define a Line Analysis Connection within one Part and how to use it

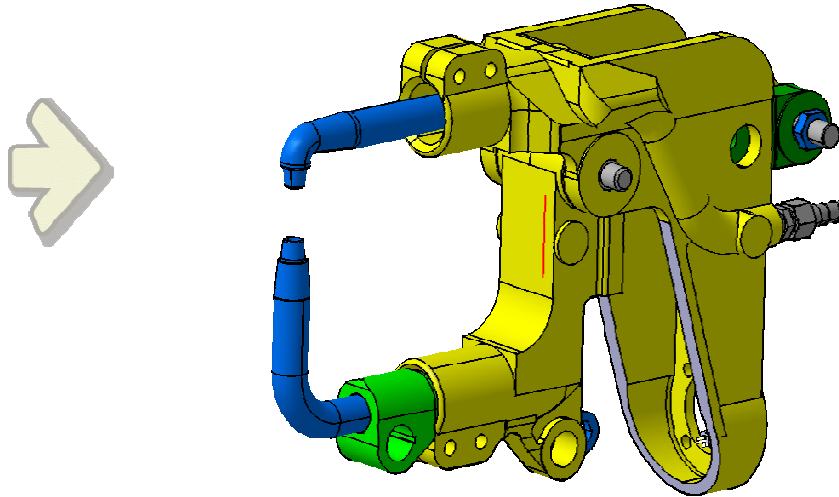

Copyright DASSAULT SYSTEMES

Instructor Notes:

What about Line analysis Connection within one Part

You have to define this kind of analysis connection if you want to seam weld a part on itself.

If your objective is to seam weld two different edges, you have to define a Line Analysis Connection With One Part beforehand. A standard Line Analysis Connection is not appropriate because it needs two components to work properly.



To define a such design connection just proceed as if you wanted to define a Line Analysis Connection but select one component only.

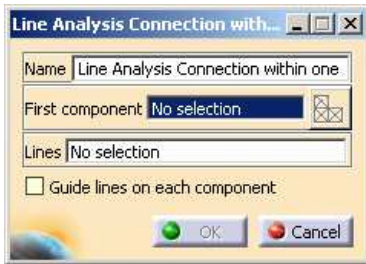

The gap of the cylinder was increased for a better display but is not representative of the reality

Copyright DASSAULT SYSTEMES

Instructor Notes:

Defining Point Analysis Connections

In this lesson you will learn the different types of Point Analysis Connections.

- Point Analysis Connections
- Point Analysis Connection within one Part

Copyright DASSAULT SYSTEMES

Instructor Notes:

Point Analysis Connection

You will learn how to define a "Point Analysis" connection and how to use it

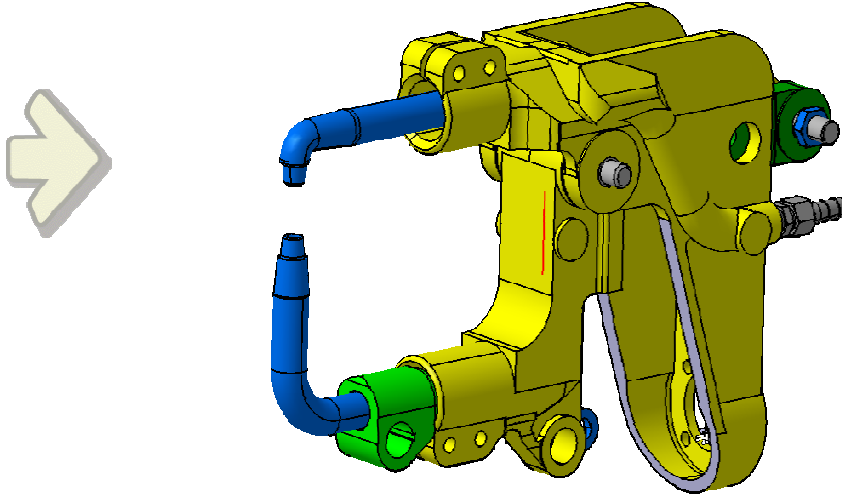

Copyright DASSAULT SYSTEMES

Instructor Notes:

What is a Point Analysis Connection



Point Analysis connections are used for projecting welding points onto parallel faces, on an assembly model.

Thus, you need to define a Point analysis connection to be able to use the “Spot welding” connection. Point analysis connection can be performed between any type of geometry.



As you can see, the “Point Analysis” connection needs some points (previously created i.e from GSD). These points are the places where the spot welding will be applied.

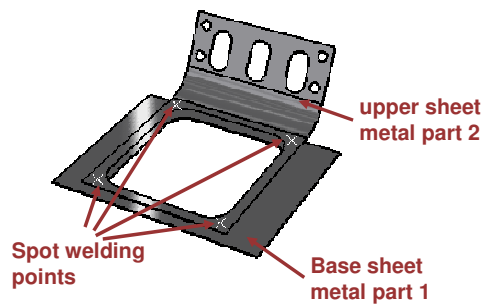
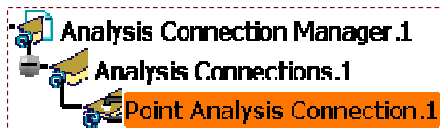

Copyright DASSAULT SYSTEMES

Instructor Notes:

How to Apply a Point Analysis Connection

1 Click on the Point Analysis connection icon

2 Select the first component (i.e cylinder's face)

3 Select the 2nd component

4 Select the points

5 Click on Ok

Point Analysis Connection dialog box fields:
 Name: Point Analysis Connection.2
 First component: No selection
 Second component: No selection
 Points: No selection

Copyright DASSAULT SYSTEMES

Instructor Notes:

Point Analysis Connection within one Part

You will learn how to define a Point Analysis Connection Within one Part and how to use it

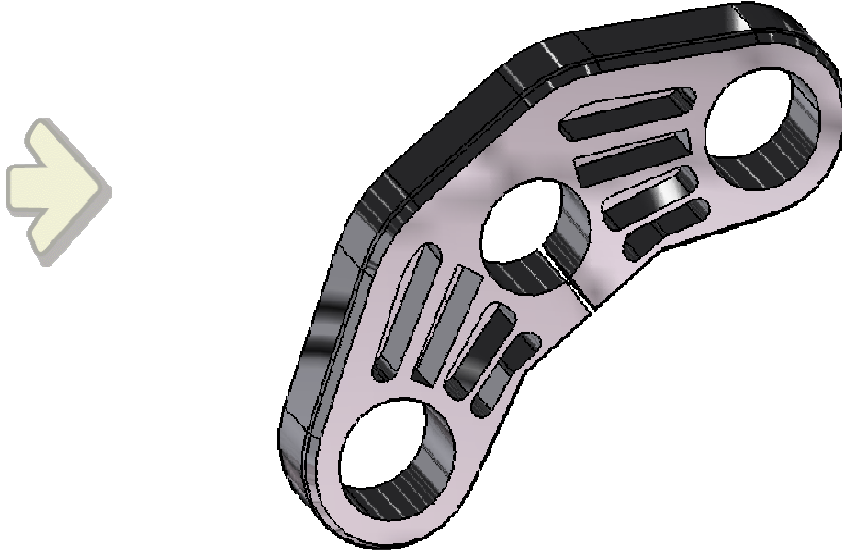

Copyright DASSAULT SYSTEMES

Instructor Notes:

What about Point Analysis Connection within one Part

This tool allows you to weld a part on itself only.



If your objective is to spot weld 2 different areas on a same part, you have to use previously this tool:

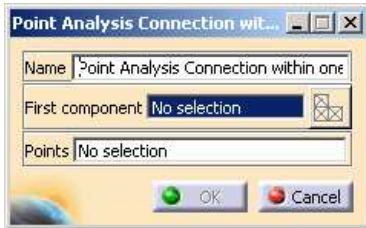

For example, with this tool you can define a spot welding between the 2 edges of the cylinder: They must have in common 1 or several points.

To define a such design connection just proceed as if you wanted to define a 'Point Analysis Connection' but select one component only.

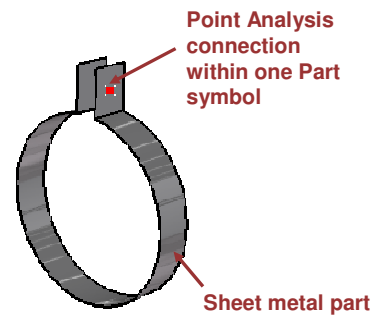

Copyright DASSAULT SYSTEMES

Instructor Notes:

Defining Surface Analysis Connections

In this lesson, you will see how to define Surface Analysis Connections

- Surface Analysis Connection
- Surface Analysis Connection within one Part

Copyright DASSAULT SYSTEMES

Instructor Notes:

Surface Analysis Connection

You will see what is Surface Analysis Connection and how to define it

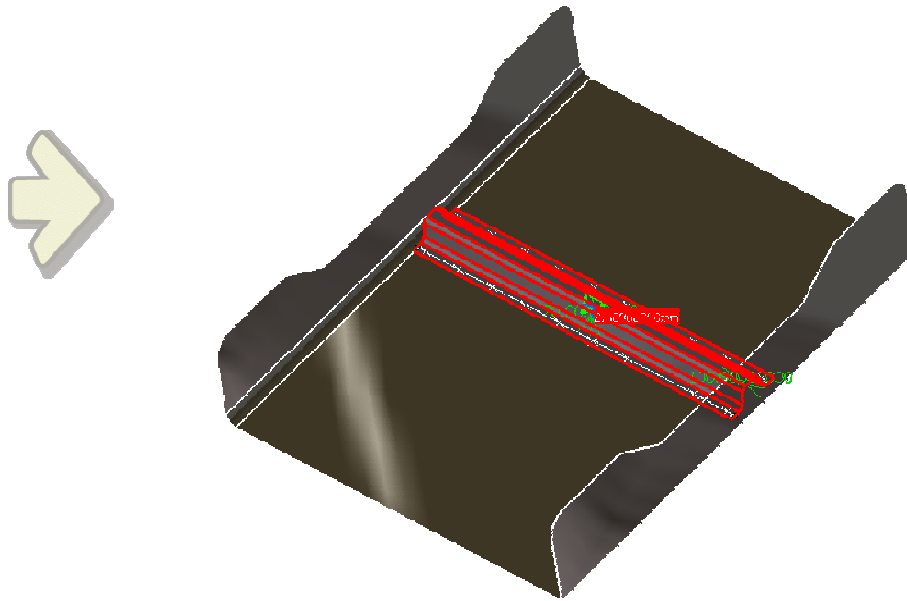

Copyright DASSAULT SYSTEMES

Instructor Notes:

What is a Surface Analysis Connection

A Surface Analysis Connection allows you to connect two supports, controlled by an input surface.

It can be used to define adhesive property connections made of hexahedron elements.

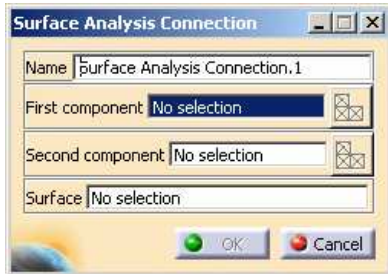

To define a Surface Analysis Connection you need to select two faces (one per component) and a common surface.

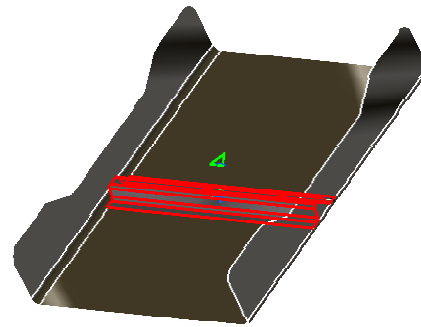

Instructor Notes:

How to Define a Surface Analysis Connection (1/2)

Reminder: A Surface Analysis Connection allows you to connect two supports, controlled by an input surface.

① Click on surface analysis connection

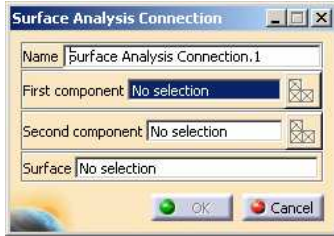

② Select first component

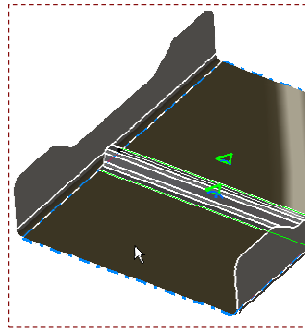

③ Select second component

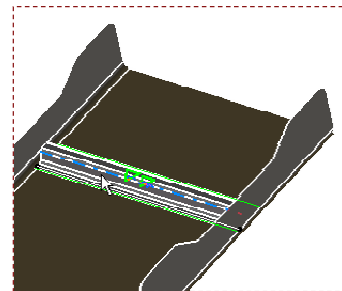

Copyright DASSAULT SYSTEMES

Instructor Notes:

How to Define a Surface Analysis Connection (2/2)

④ Select the surface

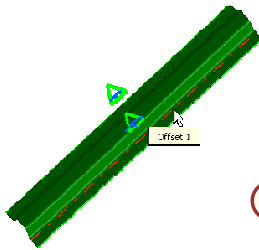

⑤ Click on Ok to validate

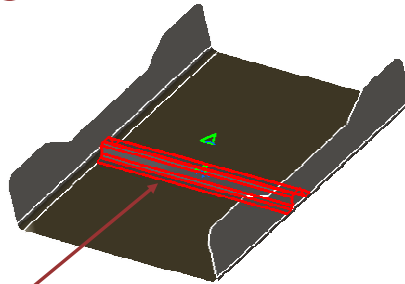

The surface analysis connection is symbolized by the red lines and accessible in the specification tree.

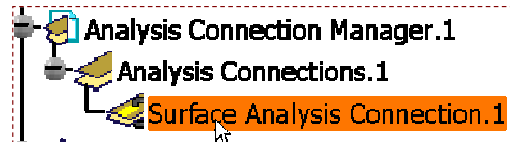

Copyright DASSAULT SYSTEMES

Instructor Notes:

Surface Analysis Connection within One Part

You will see how to define a “Surface Analysis” connection within one Part

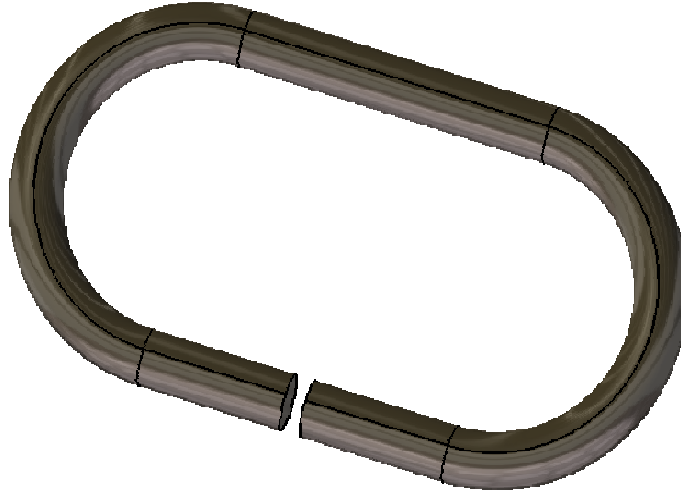

Copyright DASSAULT SYSTEMES

Instructor Notes:

What about Surface Analysis Connection within one Part

Surface analysis connections within one part are used for simulating welding surface onto parallel faces, belonging to the same part.

In the picture below you can see a chain link. It is not “closed” and you want to weld it.

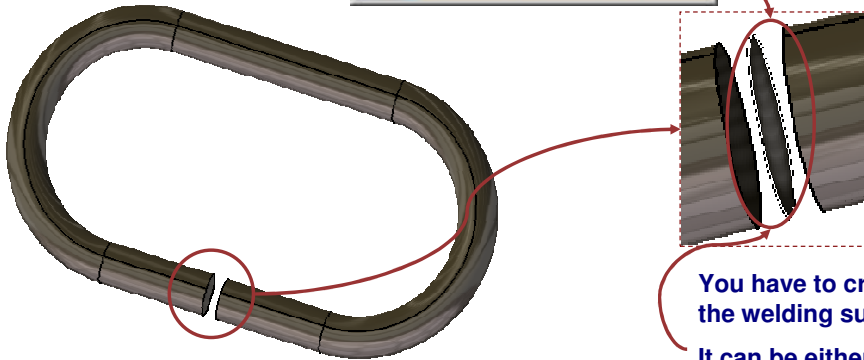
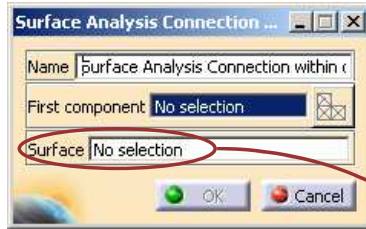

You have to create a Body 2D to model the welding surface.
It can be either between the faces you want to connect together (as above) or on one of them.

Copyright DASSAULT SYSTEMES

Instructor Notes:

Points to Points Analysis Connection

A Points To Points Analysis Connection is introduced to establish Analysis connection between two mesh parts using points.

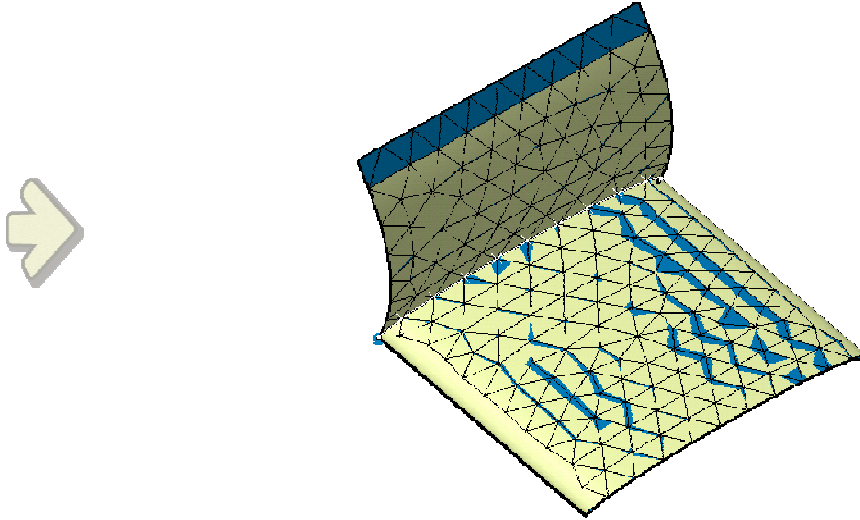

Copyright DASSAULT SYSTEMES

Instructor Notes:

About Points to Points Analysis Connection



Points to Points Analysis connection is introduced to connect part meshes to each other through point or sets of points.

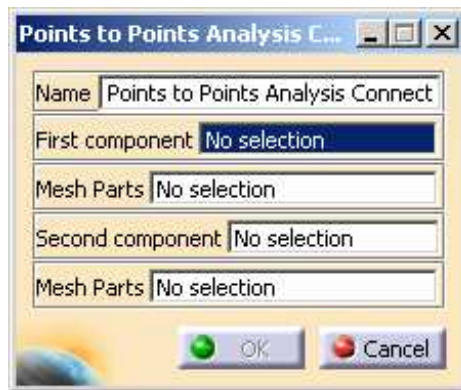

Copyright DASSAULT SYSTEMES

Instructor Notes:

How to Apply the Points to Points Analysis Connection

Points To Points Analysis Connection is used to connect two part meshes using set of points.

1 Select the 'Points to Points Analysis Connection' command

2 Select the vertex/points of part and corresponding mesh in 'First component' and 'Mesh Parts'

3 Select vertex/points of the part and the corresponding mesh in 'Second Component' and 'Mesh Parts'

4 Click OK to confirm

Vertex/Points on curve

Vertex/Points on curve

Analysis Manager

- Links Manager.1
- Analysis Connection Manager.1
 - Analysis Connections.1
 - Points to Points Analysis Connection.1
- Finite Element Model.1

Copyright DASSAULT SYSTEMES

Instructor Notes:

Set of Analysis Connections

You will learn how to create the Set of Analysis Connections.

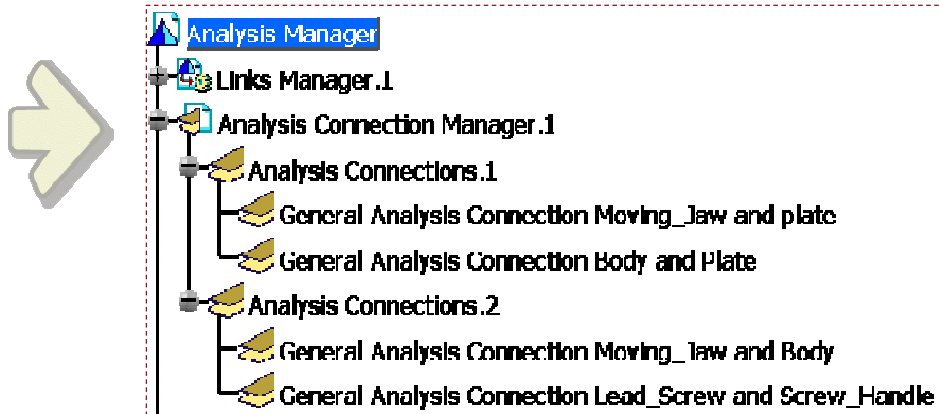

Copyright DASSAULT SYSTEMES

Instructor Notes:

What is Set of Analysis Connections

You can create different sets of analysis connections under the Analysis Connection Manager. A set can contain different kinds of analysis connections. It is possible to group the analysis connections as per user convenience.

By default one set of analysis connections is present under the node Analysis Connection Manager. You can insert extra sets as per requirement and create analysis connection under the required set.

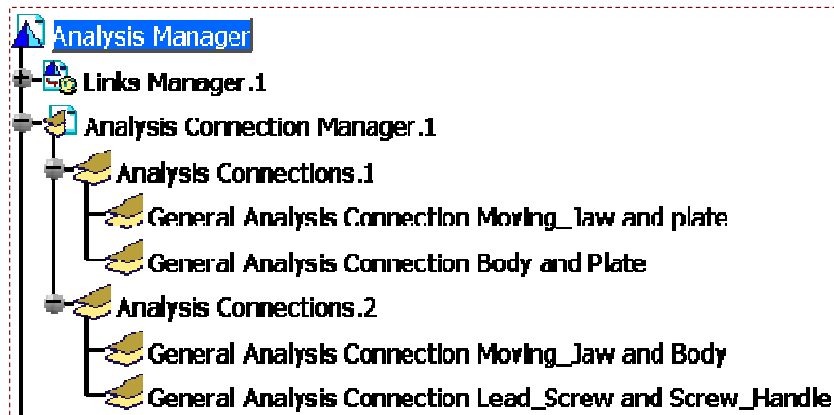

Copyright DASSAULT SYSTEMES

Instructor Notes:

How to Insert Set of Analysis Connections

- 1 Right Click on the Analysis Connection Manager node in the specification tree

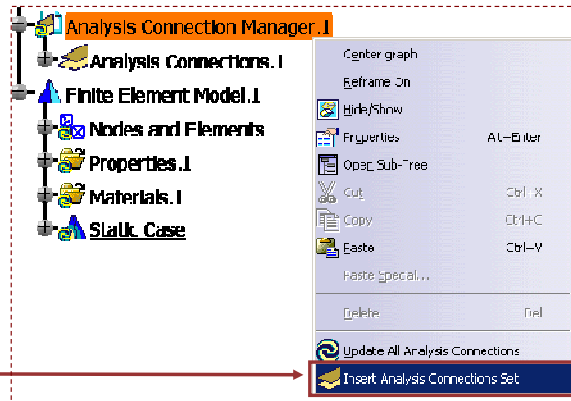

- 2 Select Insert Analysis Connections Set from the contextual menu

- 3 Set of Analysis connections gets added under the Analysis Connection Manager.

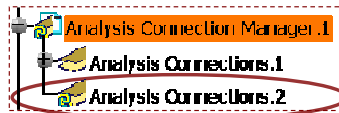

This Contextual menu is available only if at least one analysis connection is created.

Copyright DASSAULT SYSTEMES

Instructor Notes:

How to Create Analysis Connection under Specific Set

1 Click on the General Analysis Connection icon



2 Select the set of analysis connections under which you want to create the analysis connection. (Select Analysis connection.2)

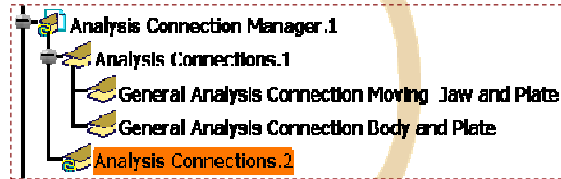

4 Select the First component and second component as per requirement

3 The General Analysis Connection Window appears. Name the analysis connection as General Analysis Connection Moving_Jaw and Body

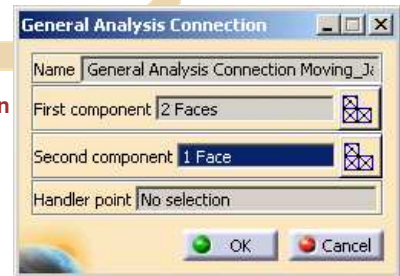

5 Click OK. General Analysis connection appears under the chosen set of analysis connections

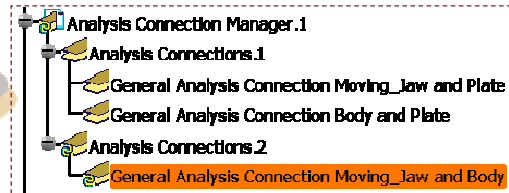

Copyright DASSAULT SYSTEMES

Instructor Notes:

To Sum Up ...

You have seen CATIA V5 Tools for Analysis Connections

- What is Analysis connection**
- General Analysis Connection**
- Point Analysis Connection**
- Line Analysis Connection**
- Surface Analysis Connection**
- Points to Points Analysis Connection**
- Set of Analysis Connections**

Copyright DASSAULT SYSTEMES

Instructor Notes:

GAS Connection Properties

In this lesson, you will see what are the different types of GAS Connection Properties.

- Face Face Connection Properties
- Distant Connection Properties
- Welding Connection Properties
- Nodes to Nodes Connection Property
- To Sum Up

Instructor Notes:

Face Face Connection Properties

You will see what are different Face Face Connection Properties.

- Fastened Connection Property
- Fastened Spring Connection Property
- Contact Connection Property
- Slider Connection Property
- Pressure Fitting Connection Property
- Bolt Tightening Connection Property
- Face Face Connections Property Recap Exercise

Copyright DASSAULT SYSTEMES

Instructor Notes:

Fastened Connection Property

You will learn how to define a fastened connection property and when to use it

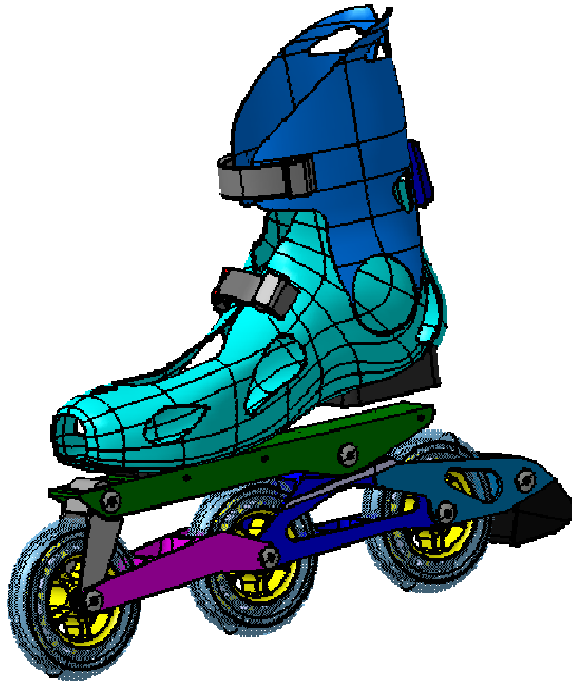

Copyright DASSAULT SYSTEMES

Instructor Notes:

What is a Fastened Connection Property

A Fastened Connection property is the link between two bodies which are fastened together at their common boundary.

From a finite element model point of view, this is equivalent to the situation where corresponding nodes of two compatible meshes are merged together. Consequently, two bodies will behave as if they were a single one. However, they can have different material properties.

Fastened Connection relations take into account the elastic deformability of interfaces.

Example of a Fastened connection between a wheel and a tire:

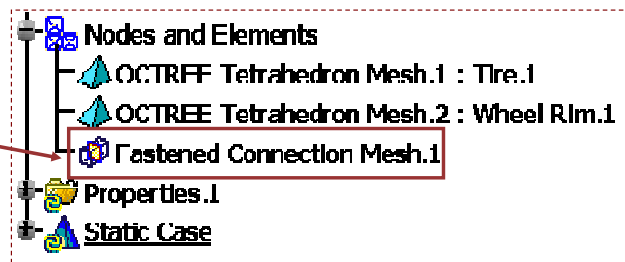
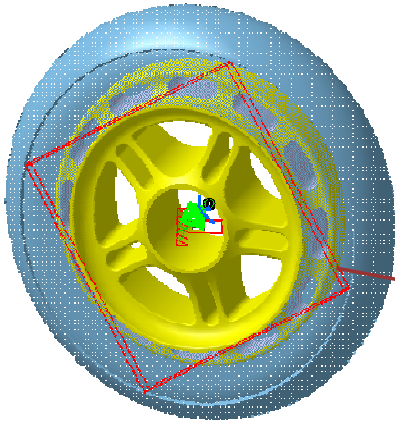

Copyright DASSAULT SYSTEMES

Instructor Notes:

How to apply a Fastened Connection Property

Before you begin, make sure you have defined a static case analysis and you have created the appropriate constraints.

1 Click on the “Fastened Connection Property” icon 



2 Select the constraint previously created in the Assembly Design/Analysis Connection workbench

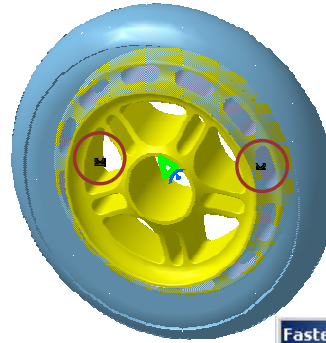

3 Click on Ok
A symbol representing the Fastened Connection appears

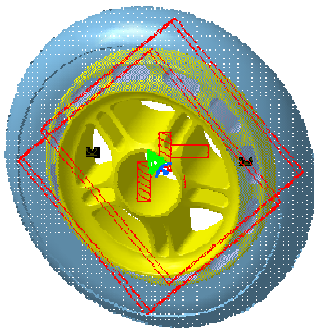

Copyright DASSAULT SYSTEMES

Instructor Notes:

Fastened Spring Connection Property

You will learn how to define a fastened spring connection property and when to use it

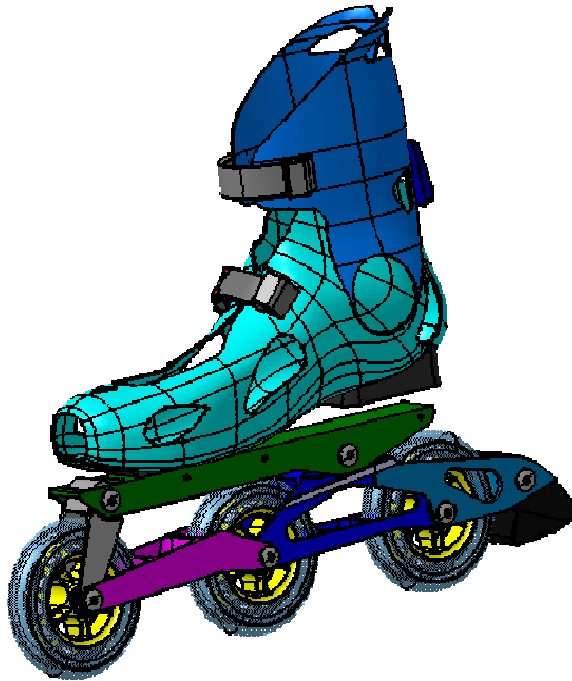

Copyright DASSAULT SYSTEMES

Instructor Notes:

What is a Fastened Spring Connection Property

A Fastened Spring Connection is an elastic link between two faces.

From a finite element model viewpoint, this is equivalent to the situation where the corresponding nodes of two compatible meshes are merged together but, the rigidity is defined interactively. However, since bodies can be meshed independently, the Fastened Spring Connection is designed to handle incompatible meshes.

Example of a Fastened Spring Connection between a wheel and a tire:

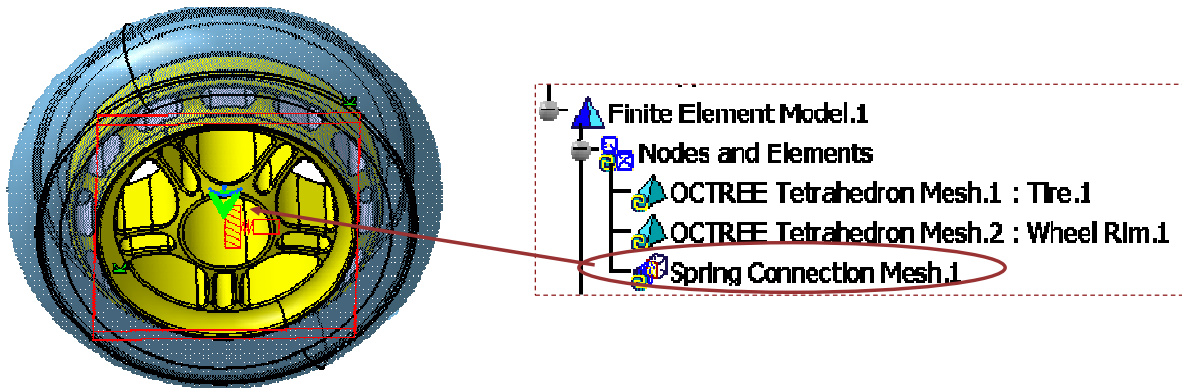

Copyright DASSAULT SYSTEMES

Instructor Notes:

How to Apply a Fastened Spring Connection Property

Before you begin, make sure you have defined a static case analysis and you have created the appropriate constraints.

- 1 Click on the “Fastened Spring Connection Property” icon



- 2 Select the constraint previously created in the Assembly

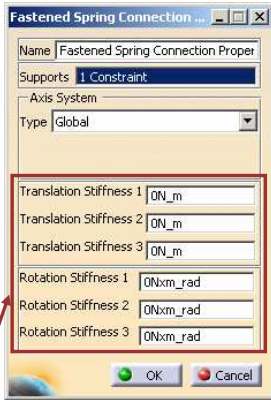

- 3 Customize the translation and rotation stiffness

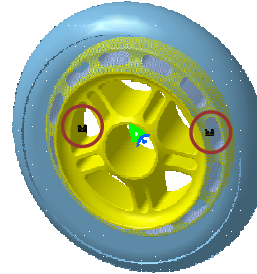

- 4 Click on Ok

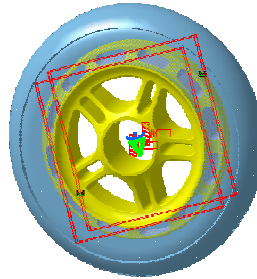

A symbol representing the Fastened Spring Connection appears

Copyright DASSAULT SYSTEMES

Instructor Notes:

Contact Connection Property

You will learn how to define a contact connection property and when to use it

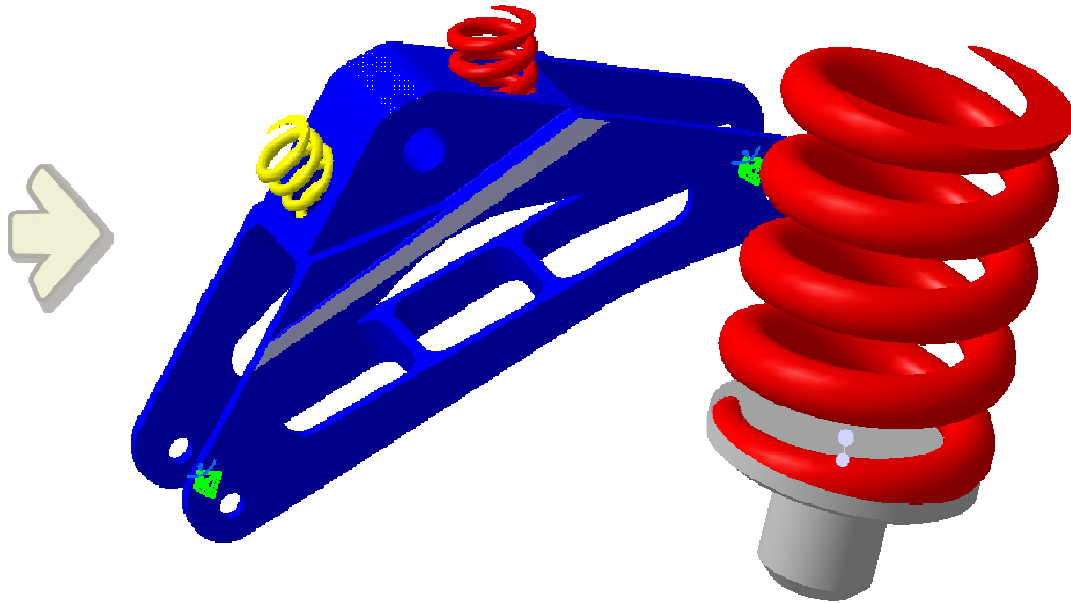

Copyright DASSAULT SYSTEMES

Instructor Notes:

What is a Contact Connection Property

A Contact Connection is the link between two part bodies which are prevented from interpenetrating at their common boundary.

They will behave in the same way, as if they were allowed to move arbitrarily relative to each other as long as they do not come into contact within a user-specified normal clearance. When they come into contact, they can still separate or slide relative to each other in the tangential plane, but they cannot reduce their relative normal clearance.

The Contact Connection is designed to handle incompatible meshes and take into account the elastic deformability of the interfaces.

Example of a Contact Connection (applied on a Face/Face constraint):

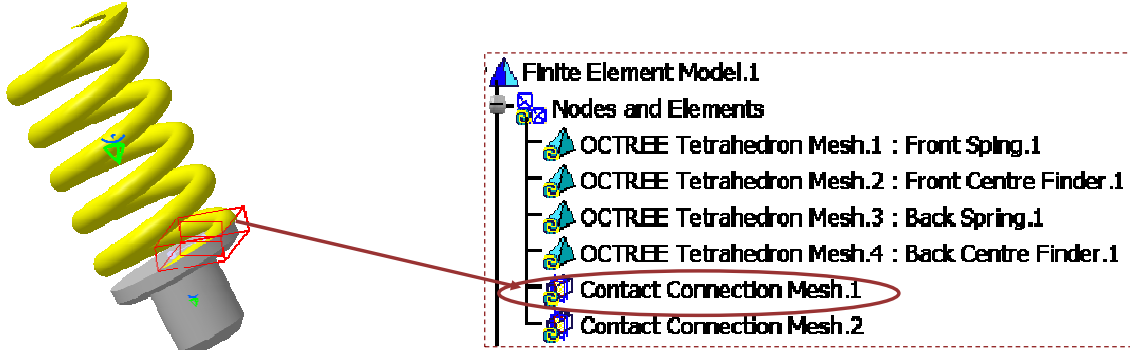

Copyright DASSAULT SYSTEMES

 The Contact Connection Property can be assigned between two surfaces or between a surface and a part.

Instructor Notes:

How to apply a Contact Connection Property

Before you begin, make sure you have defined a static case analysis and you have created the appropriate constraints.

1 Click on the “Contact Connection Property” icon 

2 Select the constraint previously created in the Assembly Design/Analysis Connection workbench

3 Click on Ok

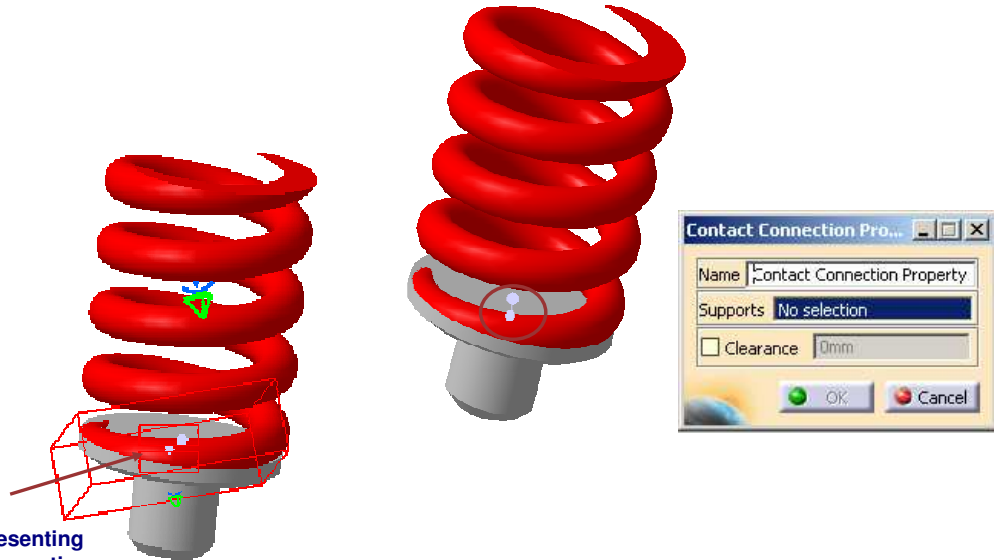

A symbol representing the contact Connection appears

Copyright DASSAULT SYSTEMES

Instructor Notes:

Slider Connection Property

You will learn how to define a slider connection property and when to use it

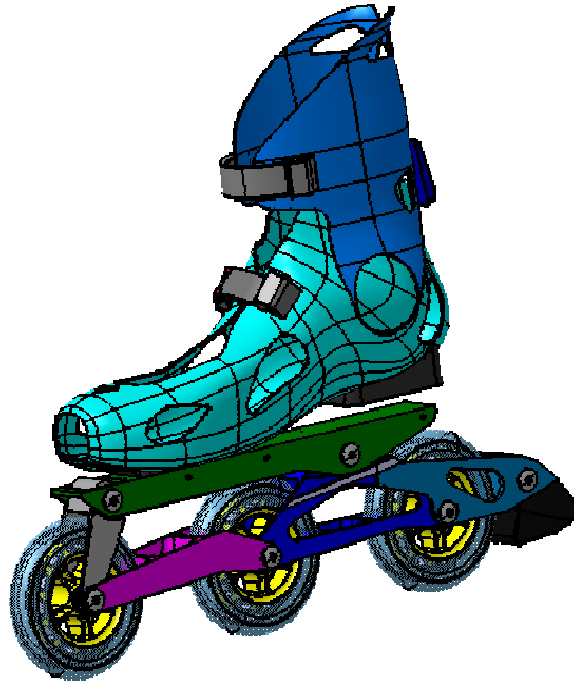

Copyright DASSAULT SYSTEMES

Instructor Notes:

What is a Slider Connection Property

A Slider Connection is a link between two bodies which are constrained to move together in the local normal direction at their common boundary.

These two bodies will behave in the same way, as if they were allowed to slide relative to each other in the local tangential plane. The Slider Connection takes into account the elastic deformability of the interfaces.

Example of a Slider Connection (applied on a Face/Face constraint):

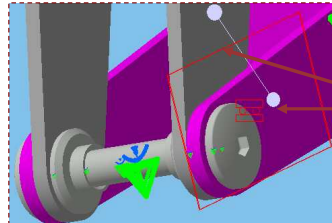
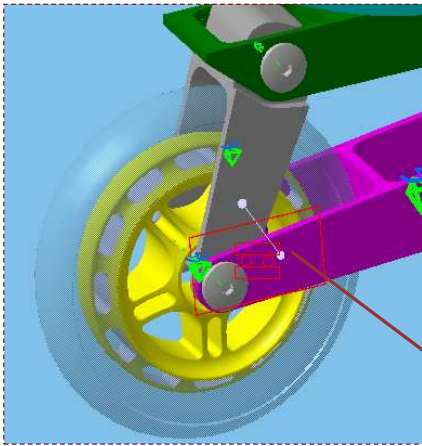

The Face/Face constraint was defined between the outer gray surface and the inner pink surface

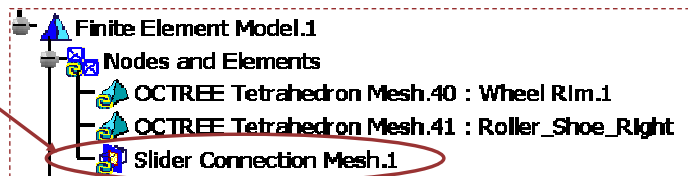

Copyright DASSAULT SYSTEMES

Instructor Notes:

How to Apply a Slider Connection Property

Before you begin, make sure you have defined a static case analysis and you have created the appropriate constraints.

- ① Click on the “Slider Connection Property” icon 



- ② Select the constraint previously created in the Assembly Design/Analysis Connection workbench

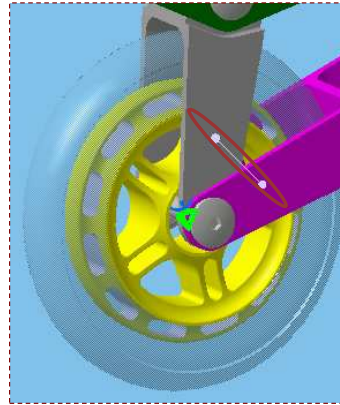

- ③ Click on Ok

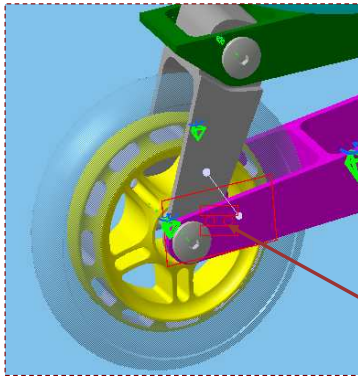

A symbol representing the Slider Connection Property appears

Copyright DASSAULT SYSTEMES

Instructor Notes:

Pressure Fitting Connection Property

You will learn how to define a pressure fitting connection property and when to use it

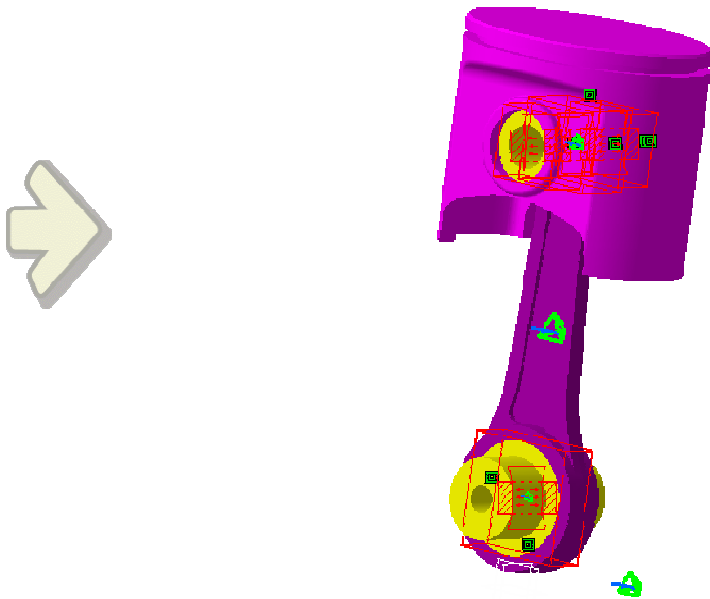

Copyright DASSAULT SYSTEMES

Instructor Notes:

What is a Pressure Fitting Connection Property

A Pressure Fitting Connection is a link between two parts which are assembled in a Pressure Fitting configuration, which means there are interferences or overlaps between them.

Along the surface normal, the connection behaves as a contact connection with negative clearance value (positive overlap). The difference lies in the tangential directions where both parts are linked together.

The Pressure Fitting Connection relations take into account the elastic deformability of the interfaces and handle incompatible meshes.

Example of a Contact Pressure Fitting Connection (applied on a contact constraint):

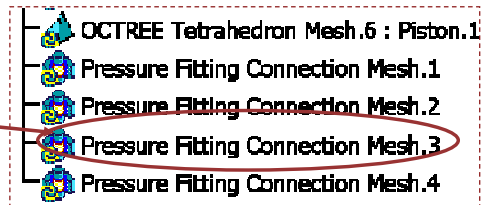
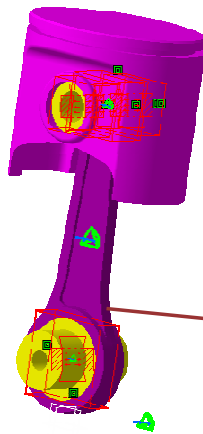

Copyright DASSAULT SYSTEMES

Instructor Notes:

How to apply a Pressure Fitting Connection Property

Before you begin, make sure you have defined a static case analysis and you have created the appropriate constraints.

- 1 Click on the Pressure Fitting Connection icon 



- 2 Select the constraint previously created in the Assembly Design/Analysis Connection workbench

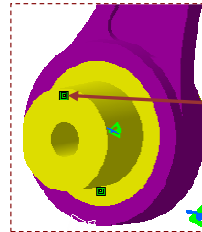

- 3 Click on Ok

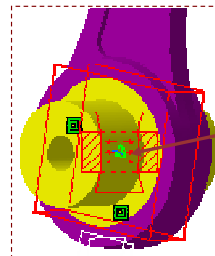

Copyright DASSAULT SYSTEMES

Instructor Notes:

Exercise



Exercises marked with this callout will work in P2 configuration only

'Pressure Fitting' Connections between Rod and Axis



20 min



In this exercise you will perform an analysis of Pressure Fitting Joint. You will use an existing Assembly Constraint to create the Connection Property.

You will:

- Define a Pressure Fitting Connection property
- Define a Clamp Restraint
- Compute the Analysis and visualize the Von Mises Stress
- Locally optimize the common mesh elements of the two parts
- Compare the Results

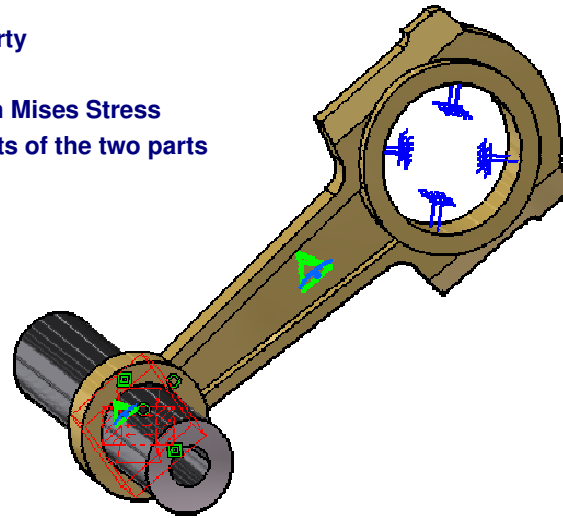
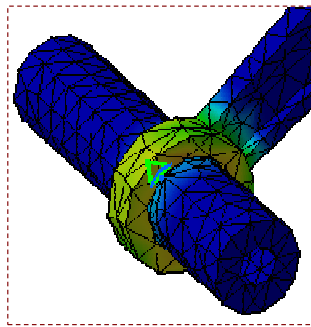

Copyright DASSAULT SYSTEMES

Instructor Notes:

Bolt Tightening Connection Property

You will learn how to define a Bolt Tightening Connection Property and when to use it

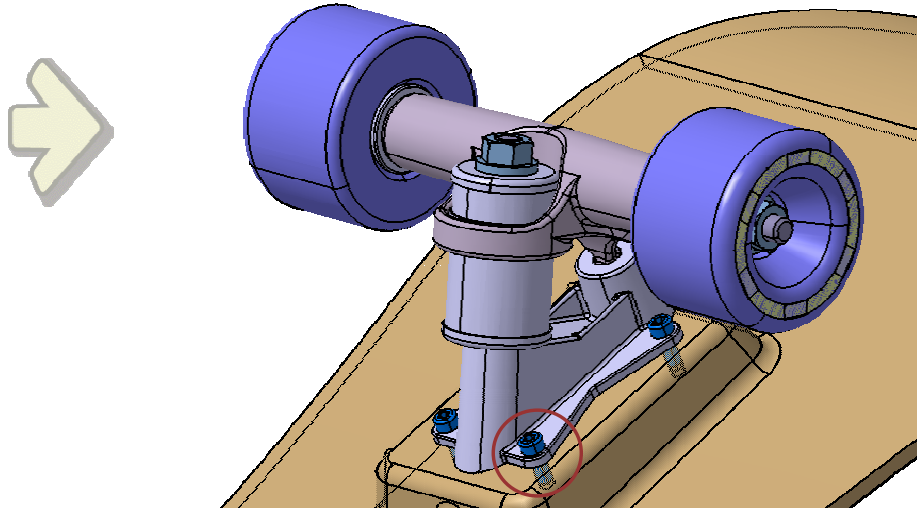

Copyright DASSAULT SYSTEMES

Instructor Notes:

What is a Bolt Tightening Connection Property

A Bolt Tightening Connection is a connection that takes into account pre-tension in bolt-tightened assemblies.

The computation is carried out in two steps:

- 1 First the model is submitted to tension forces relative to bolt tightening by applying opposite forces respectively on the bolt thread and on the support tapping;
- 2 Then, the relative displacement of these two surfaces (obtained in the first step) is imposed while the model is submitted to user loads.

During these two steps, the bolt and the support displacements are linked in the direction normal to the bolt axis.

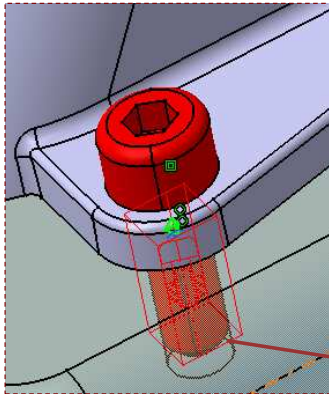

Bolt Tightening Connection requires a 'surface contact' assembly constraint between the bolt thread and the bolt support tapping. These surfaces must be coincident.



- OCTREE Tetrahedron Mesh.4
- OCTREE Tetrahedron Mesh.5
- OCTREE Tetrahedron Mesh.6 : Support Skateboard.2
- Tightening Connection Mesh.1**

Copyright DASSAULT SYSTEMES

Instructor Notes:

How to apply a Bolt Tightening Connection Property (1/2)

Before you begin, make sure that all the needed assembly constraints were created.

In this section view, you can see the screw, the skate board's truck and the board. To be able to define a "Bolt Tightening" connection some constraints must have been previously defined:

1. "Surface Contact" constraint between the screw and the truck
2. "Surface Contact" constraint between the truck and the board
3. "Coincident" constraint between the screw and the holes board axis
4. "Surface Contact" constraint between the outer surface of the screw and the inner surface of the board hole.

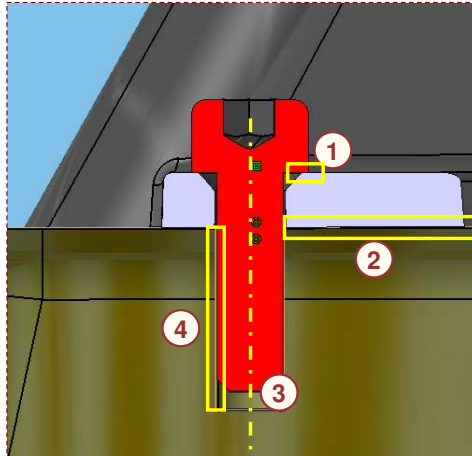

Instructor Notes:

How to apply a Bolt Tightening Connection Property (2/2)

Before you begin, make sure that all the needed assembly constraints were created.

- 1 Click on the “Bolt Tightening Connection Property” icon 



A symbol representing the Bolt Tightening Connection property appears

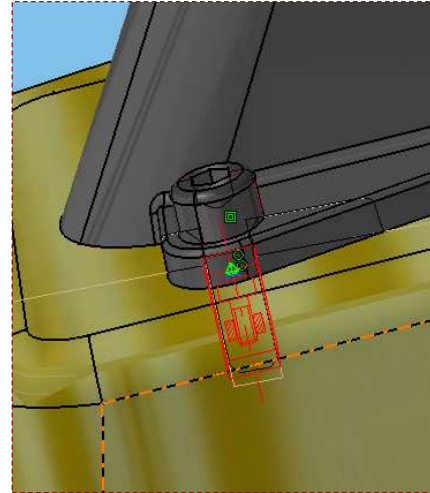

- 2 Select the “Surface contact” constraint previously created (the one between the screw and the board’s hole).

- 3 Enter a force value
And click on Ok



Copyright DASSAULT SYSTEMES

Instructor Notes:

Exercise P2

'Face Face' Connection Properties Recap Exercise



In this exercise you will apply different Face Face Connection Properties to the foot peg assembly's part constraints.

You will use:

- Slider Connections
- Fastened connections
- Contact connections with springs

Then you will perform a static analysis on the foot peg assembly

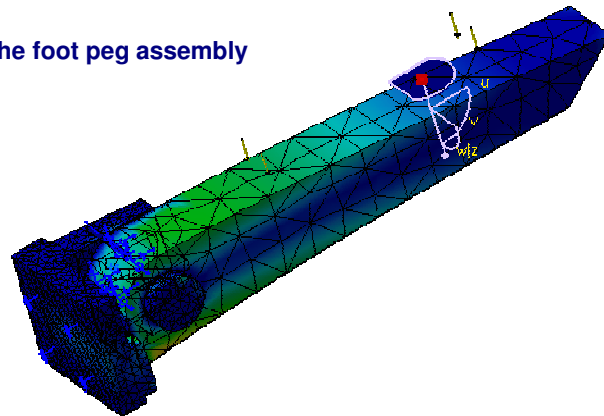

Copyright DASSAULT SYSTEMES

Instructor Notes:

Distant Connection Properties

You will see what are different Distant Connection Properties.

- ▣ Rigid Connection Property
- ▣ Smooth Connection Property
- ▣ Virtual Bolt Tightening Connection Property
- ▣ Virtual Spring Bolt Tightening Connection Property
- ▣ User-defined Connection Property
- ▣ Distant Connections Recap Exercise

Copyright DASSAULT SYSTEMES

Instructor Notes:

Rigid Connection Property

You will learn how to define a Rigid connection property and when to use it

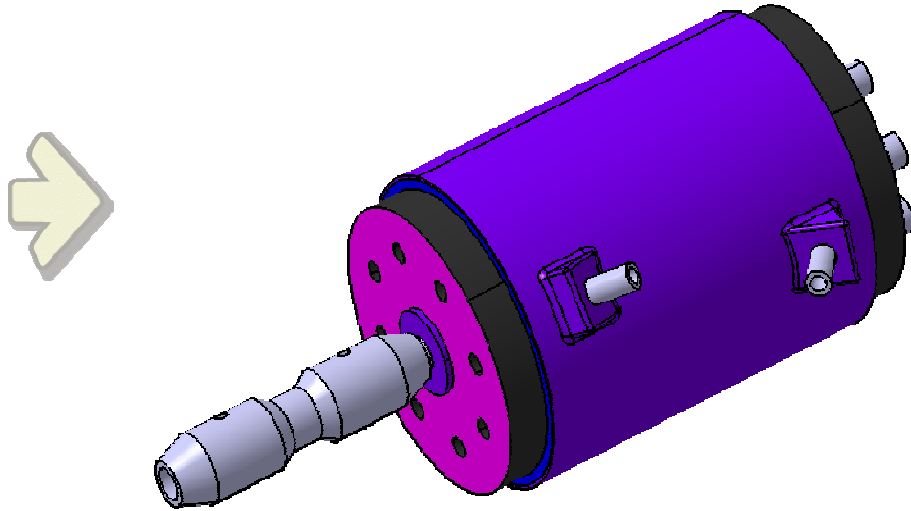

Copyright DASSAULT SYSTEMES

Instructor Notes:

What is a Rigid Connection Property

A Rigid Connection is the link between two bodies which are stiffened and fastened together at their common boundary, and will behave as if their interface was infinitely rigid.

The Rigid Connection relations do not take into account the elastic deformability of the interfaces.

A central node is created at the midpoint between centroids of the two systems of points represented by the nodes of the two meshes. This node is connected by a rig-beam element to each node of the first and of the second meshes.

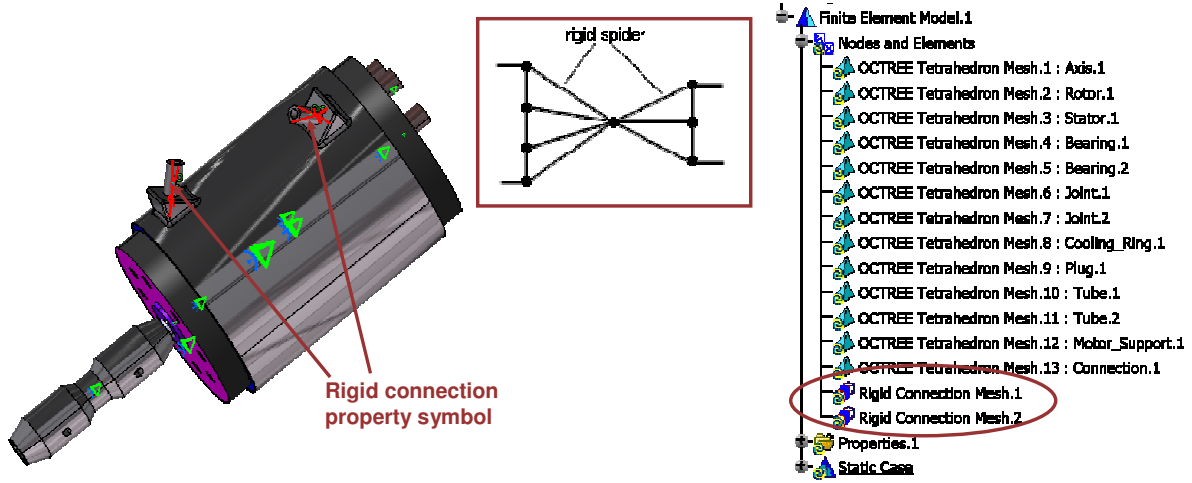

Instructor Notes:

How to apply a Rigid Connection Property

Before you begin, make sure that all the needed assembly constraints were created.

- 1 Click on the "Rigid Connection Property" icon



- 2 Select an assembly constraint i.e "coincidence"

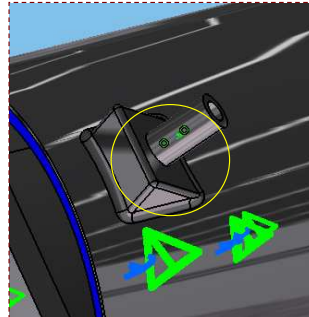

The product below is a small scale model Brushless motor.

- 3 Check the Transmitted Degrees of Freedom option.

If needed, you can also transmit some Degrees of Freedom to the distant connection

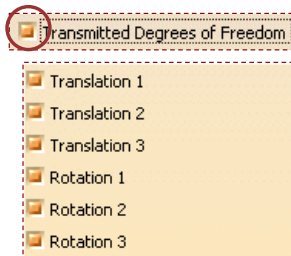

- 4 Click on Ok

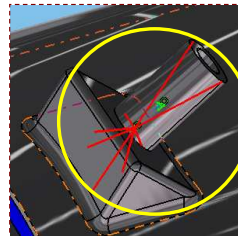

Copyright DASSAULT SYSTEMES

Instructor Notes:

Smooth Connection Property

You will learn how to define a Smooth connection property and when to use it

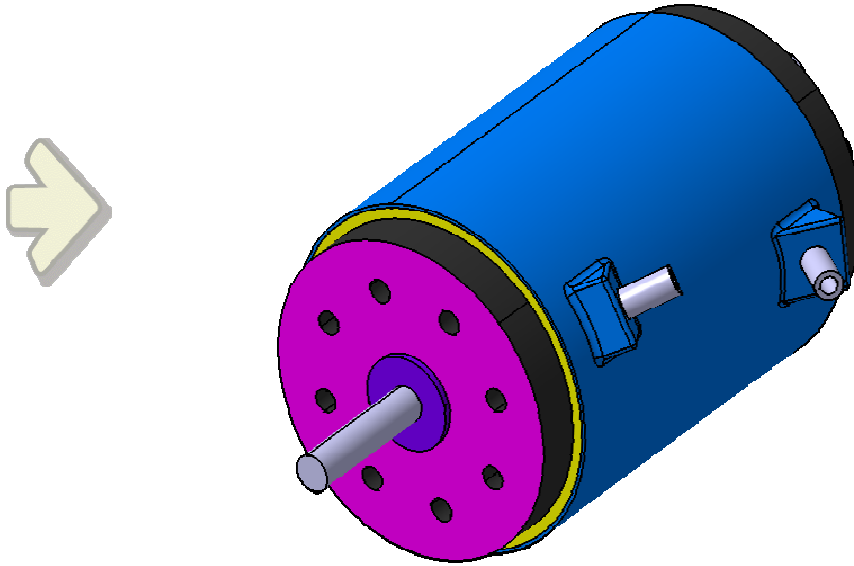

Copyright DASSAULT SYSTEMES

Instructor Notes:









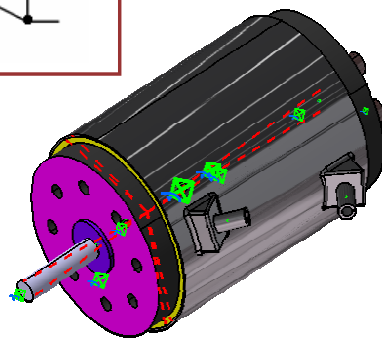
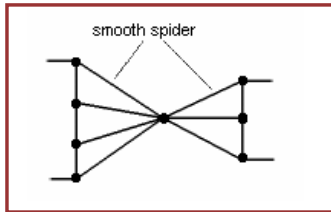

What is a Smooth Connection Property

A Smooth Connection is the link between two bodies which are fastened together at their common boundary, and will behave approximately as if their interface was soft.

The Smooth Connection relations take approximately into account the elastic deformability of the interfaces.

A central node is created at the midpoint between centroids of the two systems of points represented by the nodes of the two meshes. This node is connected by two spider elements to all nodes of the first and of the second meshes.



-  OCTREE Tetrahedron Mesh.4 : Bearing.1
-  OCTREE Tetrahedron Mesh.5 : Bearing.2
-  OCTREE Tetrahedron Mesh.6 : Joint.1
-  OCTREE Tetrahedron Mesh.7 : Joint.2
-  OCTREE Tetrahedron Mesh.8 : Cooling_Ring.1
-  OCTREE Tetrahedron Mesh.9 : Plug.1
-  OCTREE Tetrahedron Mesh.10 : Tube.1
-  OCTREE Tetrahedron Mesh.11 : Tube.2
-  OCTREE Tetrahedron Mesh.12 : Motor_Support.1
-  OCTREE Tetrahedron Mesh.13 : Connection.1
-  Smooth Connection Mesh.1

Copyright DASSAULT SYSTEMES

Instructor Notes:

How to apply a Smooth Connection Property

Before you begin, make sure that all the needed assembly constraints were created.

- 1 Click on the "Smooth Connection Property" icon
- 2 Select an assembly constraint i.e "coincidence"

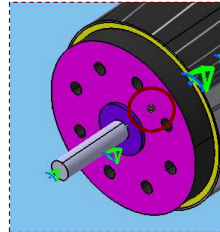

The product below is a small scale model Brushless motor

- 3 Optional: Check the "Transmitted Degrees of Freedom" option to transmit required DOF to the distant connection



- 4 Click on Ok

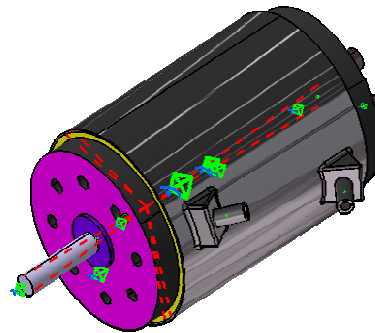

Copyright DASSAULT SYSTEMES

Instructor Notes:

Virtual Bolt Tightening Connection Property

You will learn how to define a Virtual Bolt Tightening Connection Property and when to use it

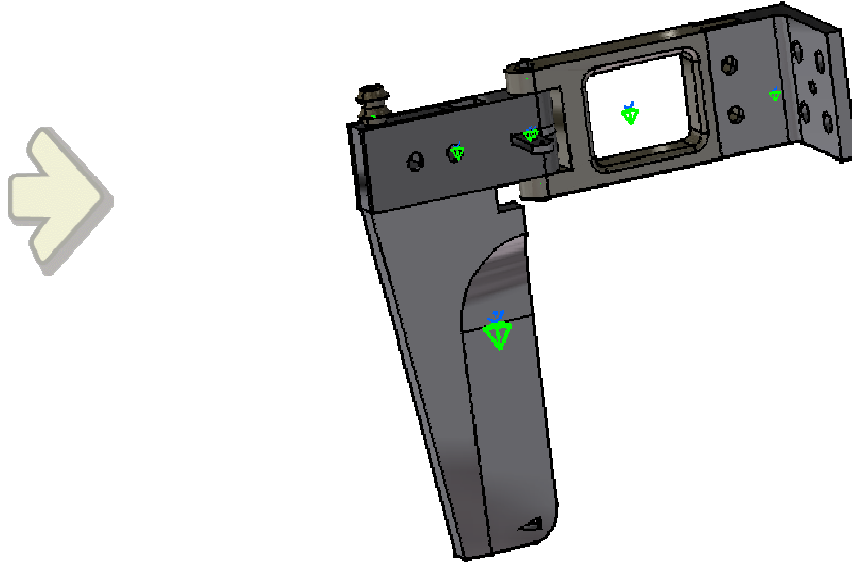

Copyright DASSAULT SYSTEMES

Instructor Notes:

What is a Virtual Bolt Tightening Connection Property

A Virtual Rigid Bolt Tightening Connection is a connection that takes into account pre-tension in a bolt-tightened assembly in which the bolt is not included.

The computation is carried out in two steps:

- The model is submitted to tension forces relative to bolt tightening by applying opposite forces respectively on the first surface (S1) and the second surface (S2) of the assembly constraint;
- Then, the relative displacement of these two surfaces (obtained in the first step) is imposed while the model is submitted to user loads.

During these two steps, the rotations of both surfaces and the translations perpendicular to the coincidence constraint axis are linked together, while taking into account the elastic deformability of the surfaces.

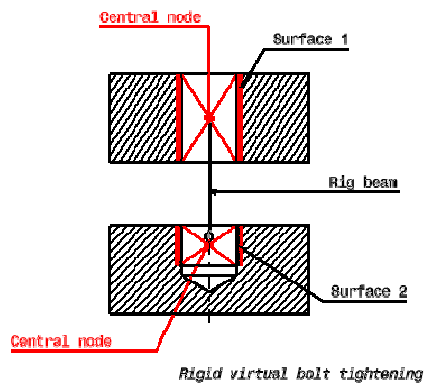

Once the geometric assembly **positioning constraints** are defined at the Product level (Assembly or Analysis Connection workbenches), the user can specify the **physical nature of the constraints: Virtual Rigid Bolt Tightening Connection**.

When creating this connection, all the positioning constraints can be selected.



You can define this property even when analysis connection is defined between two points. In this case, the bolt tightening orientation will be defined by the direction between these two points.

Instructor Notes:

Applying a Virtual Bolt Tightening Connection Property

Before you begin, make sure that all the needed assembly constraints were created.

- 1 Click on the “Virtual Bolt Tightening ” icon 



- 2 Select an assembly constraint i.e “coincidence”

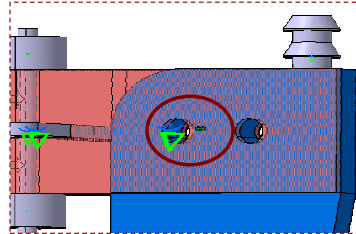

- 3 Enter a tightening force value and click on Ok

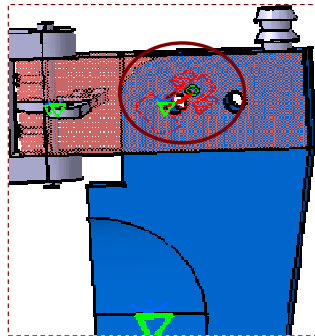

The product shown is a small scale model off- shore's rudder

Copyright DASSAULT SYSTEMES

Instructor Notes:

Virtual Spring Bolt Tightening Connection

You will learn how to define a Virtual Spring Bolt Tightening Connection Property and when to use it

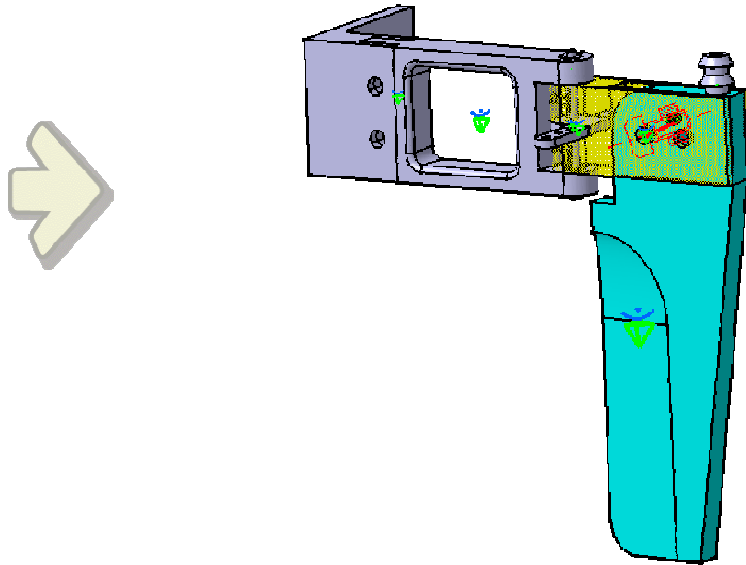

Copyright DASSAULT SYSTEMES

Instructor Notes:

What is a Virtual Spring Bolt Tightening Connection Property

A Virtual Spring Bolt Tightening Connection is a connection that takes into account pre-tension in a bolt-tightened assembly in which the bolt is not included.



The computation is carried out in two steps:

- the model is submitted to tension forces relative to bolt tightening by applying opposite forces respectively on the first surface (S1) and the second surface (S2) of the assembly constraint;
- Then, the relative displacement of these two surfaces (obtained in the first step) is imposed while the model is submitted to user loads.

During these two steps, the rotations of both surfaces and the translations perpendicular to the coincidence constraint axis are linked together, while taking into account the elastic deformability of the surfaces.

- A **central node** is created at the centroid of each surface.

- For each surface/central node couple, a set of mean **rigid body** is generated to link the **average displacement** of the central nodes and the nodes of the surface.

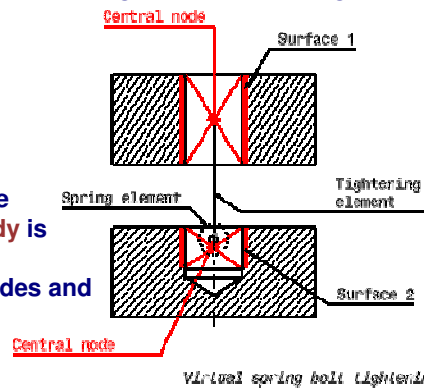

- The **first central node** is linked to the duplicata of the second central node using a **tightening element**.

- The **second central node** is linked to its duplicata using a **spring element** the characteristics of which are defined by the user.



You can define this property even when analysis connection is defined between two points. In this case, the bolt tightening orientation will be defined by the direction between these two points.

Copyright DASSAULT SYSTEMES

Instructor Notes:

Applying a Virtual Spring Bolt Tightening Connection

Before you begin, make sure that all the needed assembly constraints were created.

- 1 Click on the “Virtual Spring Bolt Tightening” icon 

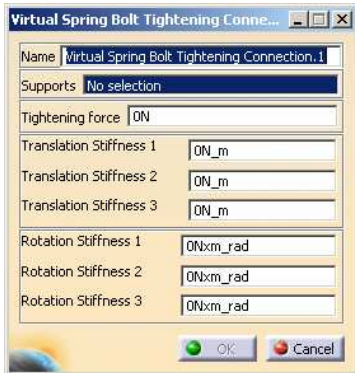

- 2 Select an assembly constraint i.e “coincidence”

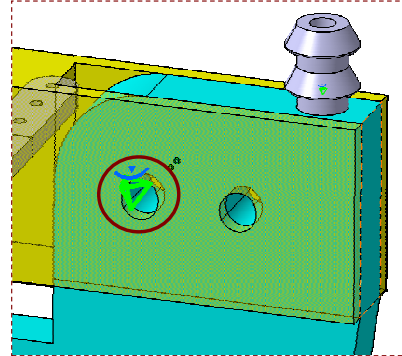

The product below is a small scale model off- shore's rudder

- 3 Enter the value of the force and stiffness parameters and click Ok

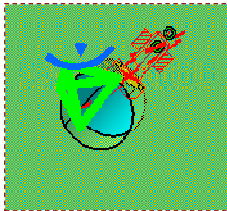

Copyright DASSAULT SYSTEMES

Instructor Notes:

User-defined Connection Property

You will learn how to define a User-defined Connection Property and when to use it

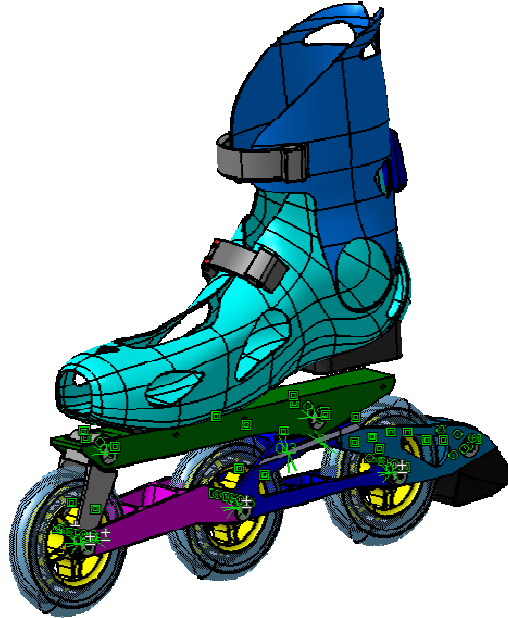

Copyright DASSAULT SYSTEMES

Instructor Notes:

What is a User-defined Connection Property

User-Defined Connection Property allow you to specify the types of elements as well as their associated properties included inside a distant connection.

The User-Defined Connection Property is the tool that allows you to define any type of constraints. All the connections you have seen so far are a particular case of this tool.

You have to specify the nature of **3 connections** at **3 different places**: Start/Middle/End.

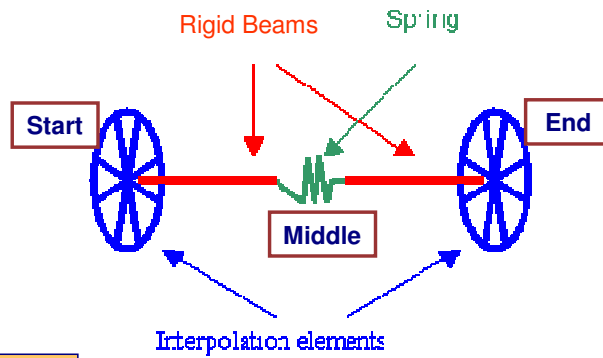

You can define this property even when analysis connection is defined between two points. In this case, the bolt tightening orientation will be defined by the direction between these two points.

Copyright DASSAULT SYSTEMES

Instructor Notes:

What are the Possible Combinations

You will define which types of element will be featured in the connection

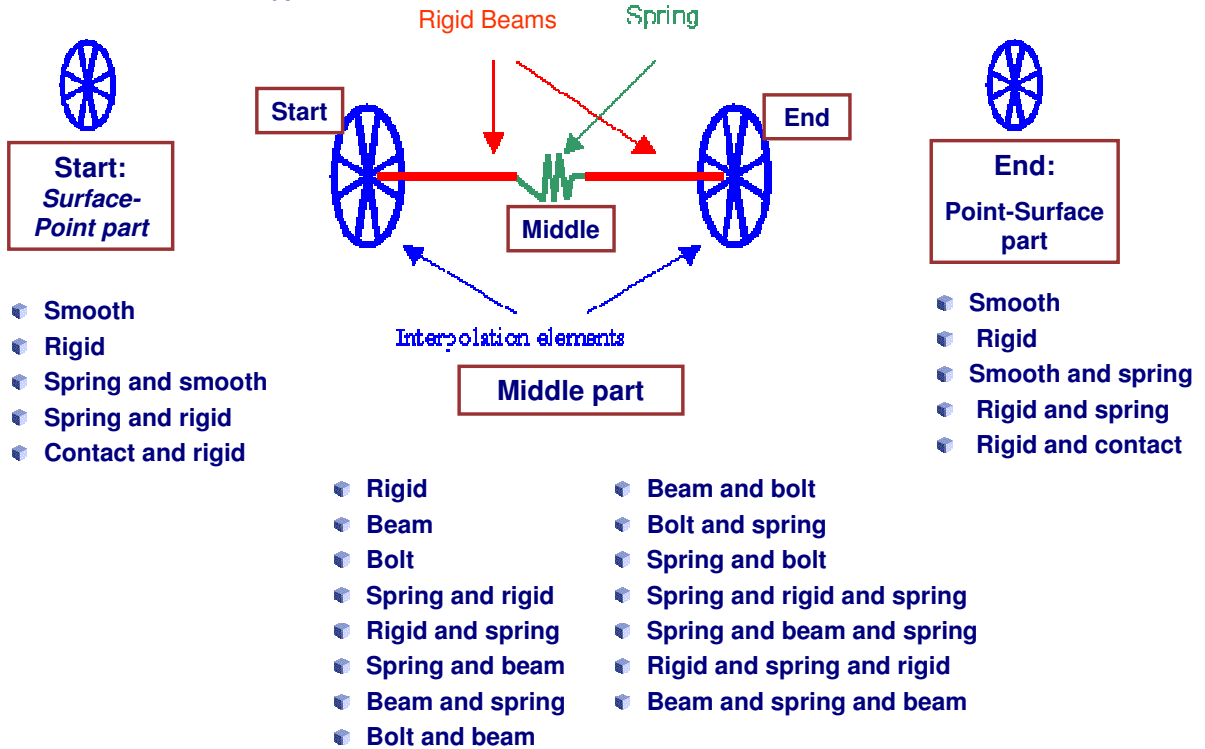

Copyright DASSAULT SYSTEMES

Instructor Notes:

How to apply a “User Defined Distant” Connection?

Before you begin, make sure that all the needed assembly constraints were created.

- 1 Click on the “User Defined Distant Connection Property” icon



- 3 Define the types of the elements to be featured in the connection: Start, Middle and End

Depending on the “Start” connection, Middle and End elements will be proposed to you.

- 4 Click on the icon below if available and enter the expected data

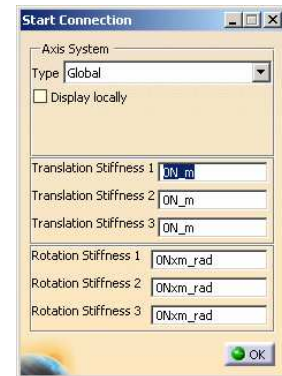

Depending on the selected combination type, the appropriate properties will be proposed.

- 2 Select the constraint or Analysis connection to be used as support, either from the specification tree or from the assembly

- 5 Click on Ok

Copyright DASSAULT SYSTEMES

Instructor Notes:

Exercise



Distant Connection Property Recap Exercise



60 min

In this exercise you will compute a Tightness Analysis in the case of an under-pressure tank.
You will:

- Define Virtual Bolt Tightening Connections and apply a pressure inside the tank
- Perform a Static Analysis
- Re-compute Analysis with Adaptivity

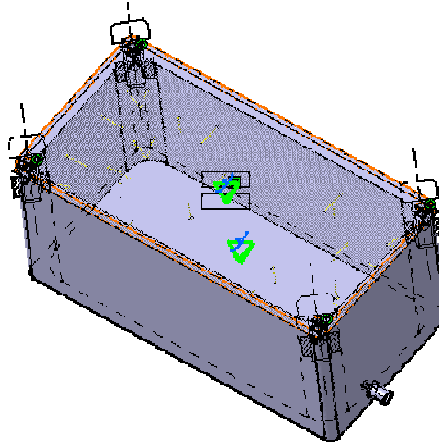

Copyright DASSAULT SYSTEMES

Instructor Notes:

Design Process: Under-pressure tank Tightness Analysis

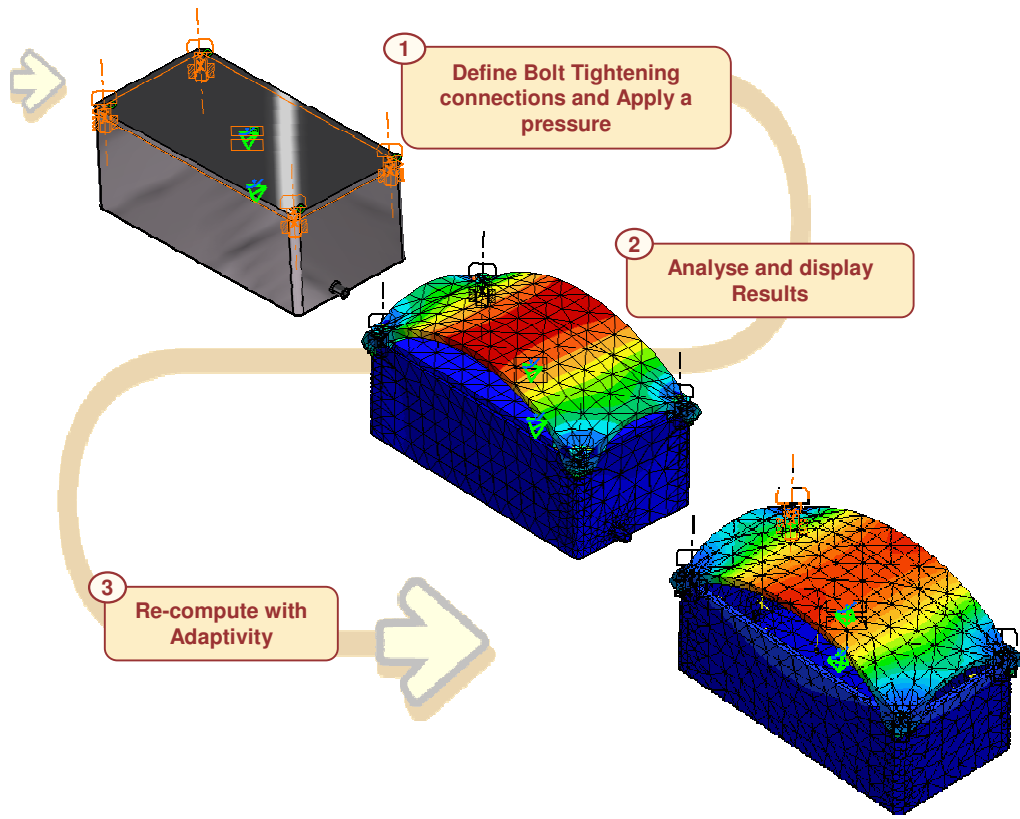

Copyright DASSAULT SYSTEMES

Instructor Notes:

Welding Connection Properties

You will see what are different Welding Connection Properties.

- ▣ Spot Welding Connection Property
- ▣ Seam Welding Connection Property

Copyright DASSAULT SYSTEMES

Instructor Notes:

Spot Welding Connection Property

You will learn how to define a Spot Welding connection property and when to use it

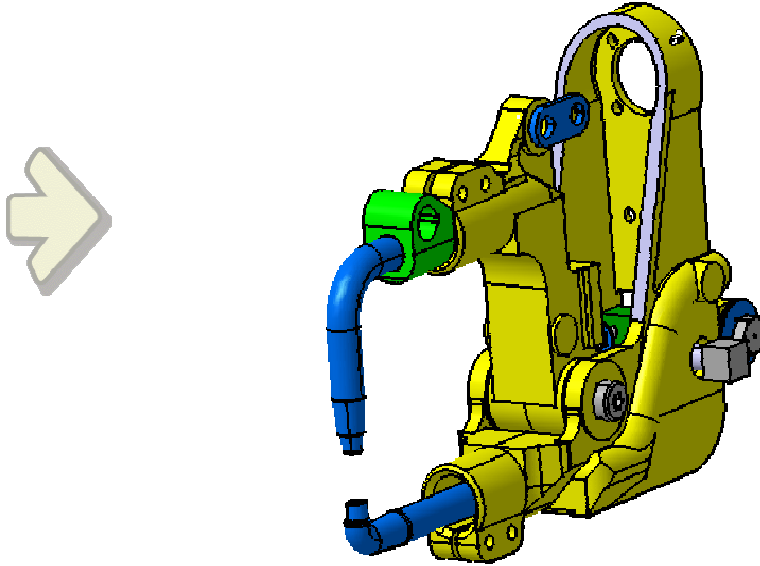

Copyright DASSAULT SYSTEMES

Instructor Notes:

What is a Spot Welding Connection Property

This type of connection allows to simulate “spot welding” between two parts.

Spot Welding Connections need as support, some Point Analysis Connections , which need themselves some points to be applied on.

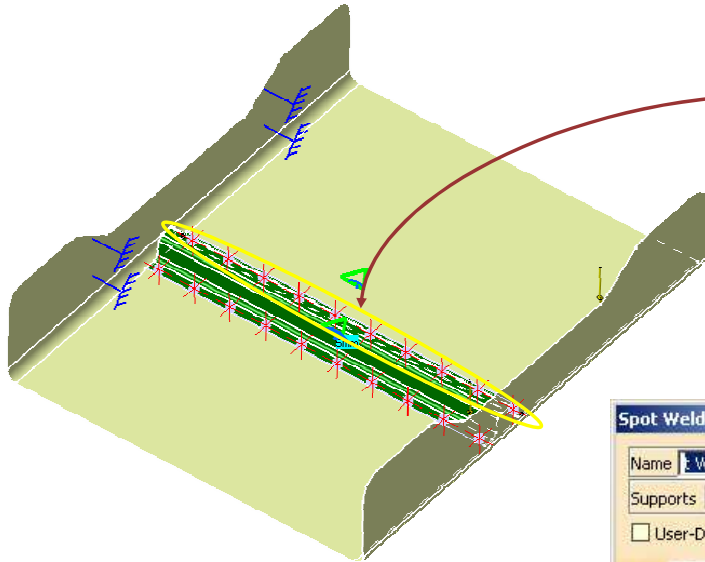

The red crosses symbolize the spot weld. They are applied on each analysis connection (gray spheres) that are themselves applied on some GSD points.

ZOOM:

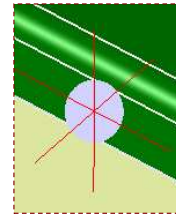

Copyright DASSAULT SYSTEMES

Instructor Notes:

How to apply a Spot Welding Connection Property

Before you begin, make sure that all the needed assembly constraints were created.

- ① Click on the "Spot Welding Connection Property" icon 



- ③ Click on Ok

Below is what you obtain: You can see the red crosses on the analysis connections.

- ② Select the support (spot welding analysis connection) to be assigned to spot welding connections and Type.

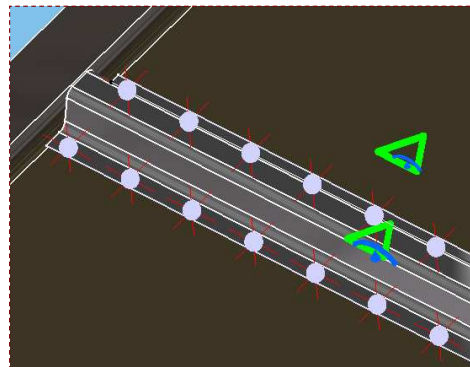
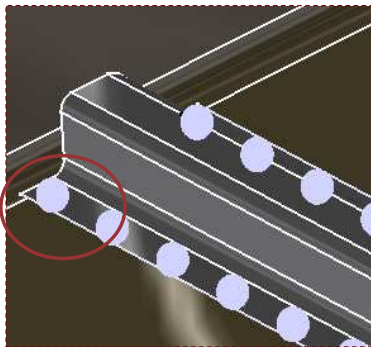

Copyright DASSAULT SYSTEMES

Instructor Notes:

Seam Welding Connection Property

You will learn how to define a Seam Welding Connection Property and when to use it

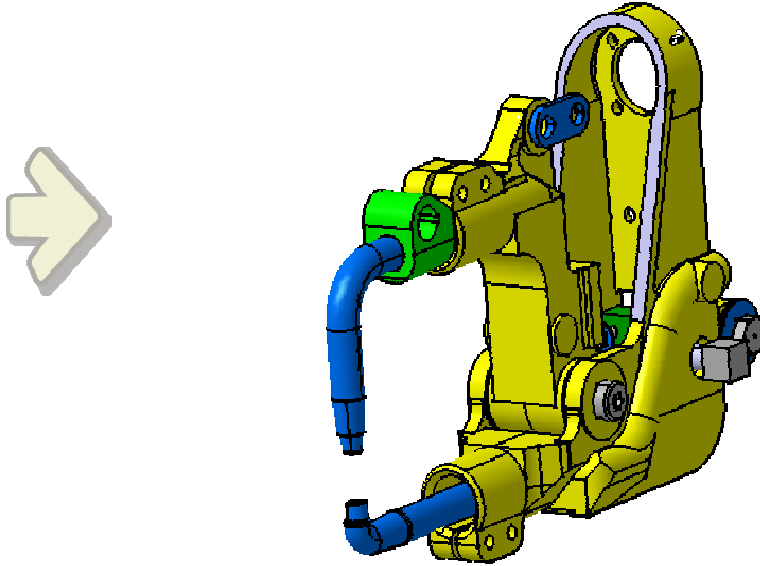

Copyright DASSAULT SYSTEMES

Instructor Notes:

What is a Seam Welding Connection Property

This type of connection allows to simulate Seam welding between two parts.

Seam Weld Connection Properties need Seam Weld Analysis Connections as support, which need themselves some lines to be applied on.

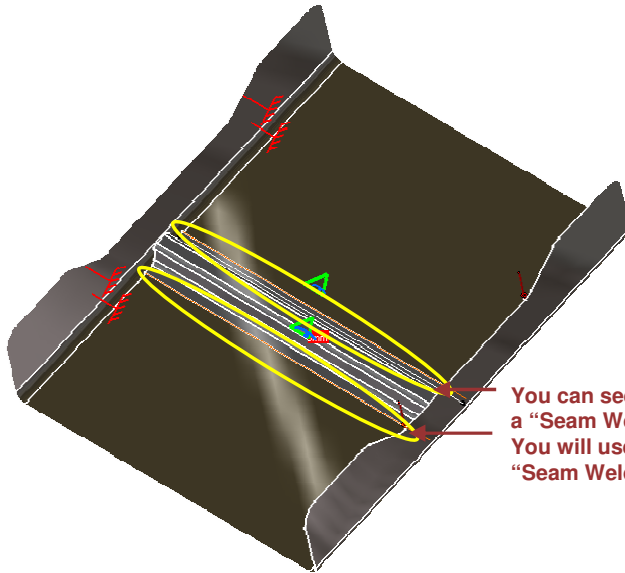

You can see a red line that is actually a "Seam Weld" analysis connection. You will use it as support for the "Seam Weld" Connection property.

Copyright DASSAULT SYSTEMES

Instructor Notes:

How to apply a Seam Welding Connection Property

Before you begin, make sure that all the needed assembly constraints were created.

- 1 Click on the Seam Welding Connection Property icon 



- 2 Select a support (an Analysis Connection) and a Type

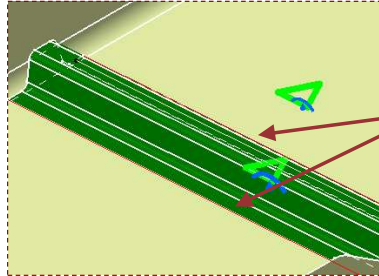

The red lines are two Seam weld Analysis connections

- 3 Click on Ok

Below is the result:

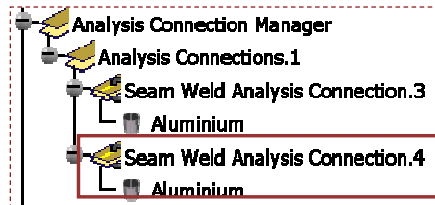
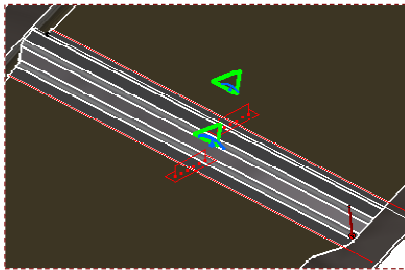

Copyright DASSAULT SYSTEMES

Instructor Notes:

Nodes to Nodes Connection Property

The Nodes to Nodes Connection Property has been introduced to transmit DOFs between two mesh parts using the Points to Points Analysis Connection.

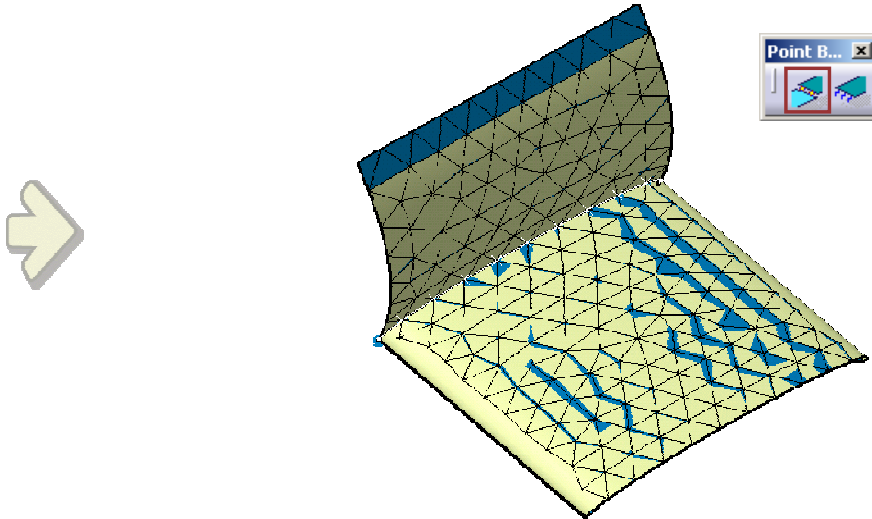

Copyright DASSAULT SYSTEMES

Instructor Notes:

What is Nodes to Nodes Connection Property

The 'Nodes to Nodes Connection Property' is applied on a Points to Points Analysis Connection. This enables to transmit the Degrees Of Freedom (DOFs) between mesh parts in an Analysis Assembly.

Two types of physical properties are available.

- ▣ **Rigid:** The connection is meshed using bar elements and a Rigid property. It creates two noded BAR elements with 3 DOF (3 translations) per node in connection mesh.
- ▣ **Coincidence:** The connection is meshed using coincident elements with Rigid Body Motion property. This creates two coincident node NSBAR elements with 6 DOF (3 translations and 3 rotations) per node in connection mesh.

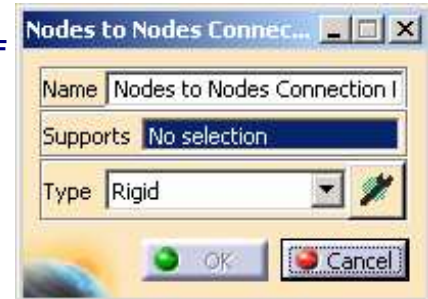

Both properties have the option to release DOFs. Once the property is applied it will create a Points to Points Connection Mesh.

Instructor Notes:

How to Apply the Nodes to Nodes Connection Property

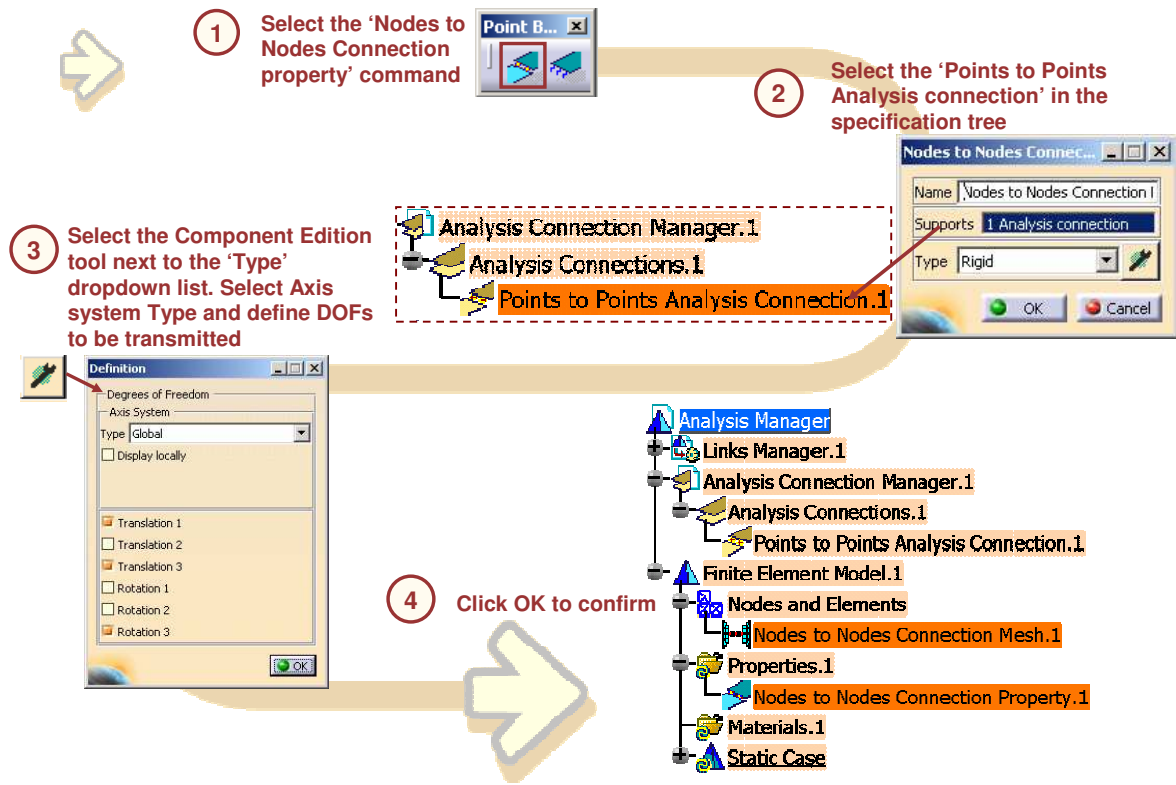

Instructor Notes:

To Sum Up ...

You have seen CATIA V5 GAS connections:

- How to define Face Face Connection Properties
- How to define Distant Connection Properties
- How to define Welding Connection Properties
- How to define Nodes to Nodes Connection Properties

Copyright DASSAULT SYSTEMES

Instructor Notes:

Analysis Assembly Management

You will learn how to use the technique of Analysis Assembly to reuse analysis created on parts.

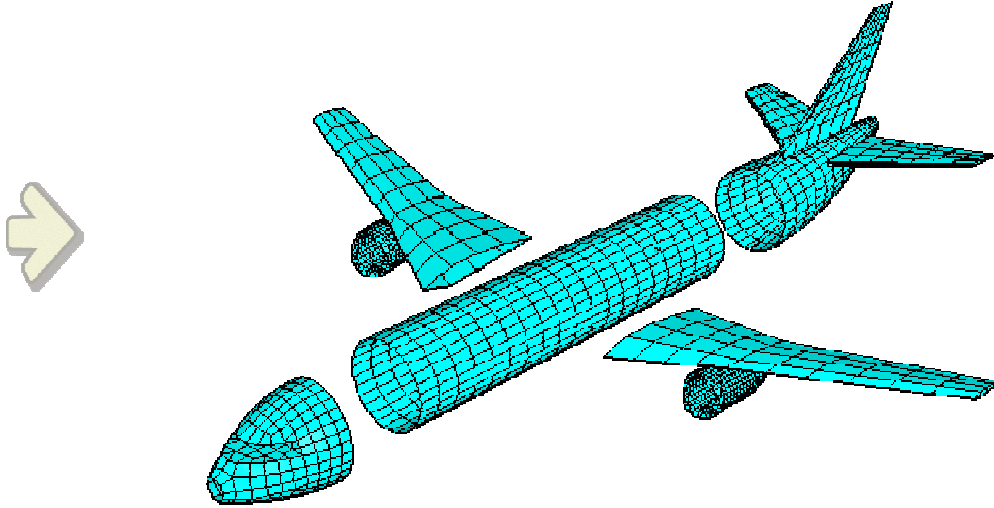

Copyright DASSAULT SYSTEMES

Instructor Notes:

What is Analysis Assembly

In this approach, analyses of individual parts in a product are available. These analyses are assembled to form an 'Analysis Assembly' and then a final 'Global Analysis' is performed for the product.

While following this approach you have the option of using an available product with assembly constraints. In case a product is not available, you can create one with all the necessary parts. Individual part analysis files are then attached to the corresponding parts in both the cases.

These analysis files must be computed with at least 'Mesh only' option ,so that it contains Mesh and complete FE property information .

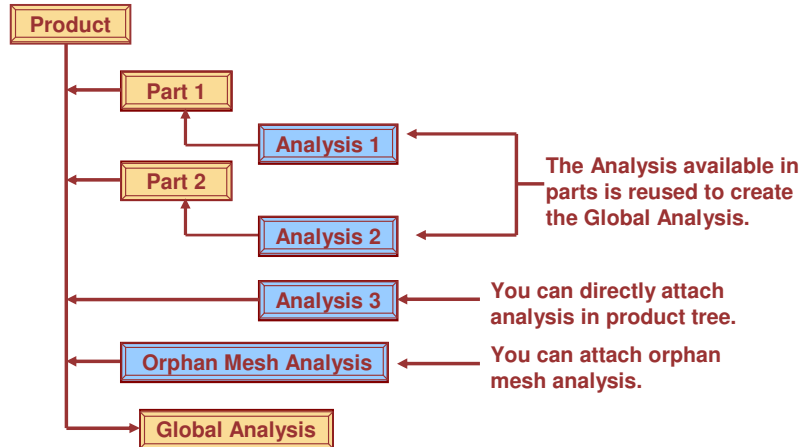

Copyright DASSAULT SYSTEMES

Instructor Notes:

Why Use Analysis Assembly

Prior to the availability of this function, analyst will have to mesh a part twice, first in an individual part context and then in an assembly context. The Analysis Assembly approach has following advantages:

- ▣ It uses already meshed individual parts and imported orphan mesh parts effectively.
- ▣ When a single part is used in multiple assemblies, you need to mesh that part only once.
- ▣ It enables concurrent engineering of FE Analysis. It is possible to mesh individual parts in an assembly simultaneously by different users at different locations.
- ▣ It reduces the time required to analyze large assemblies.
- ▣ It facilitates management of analysis data.

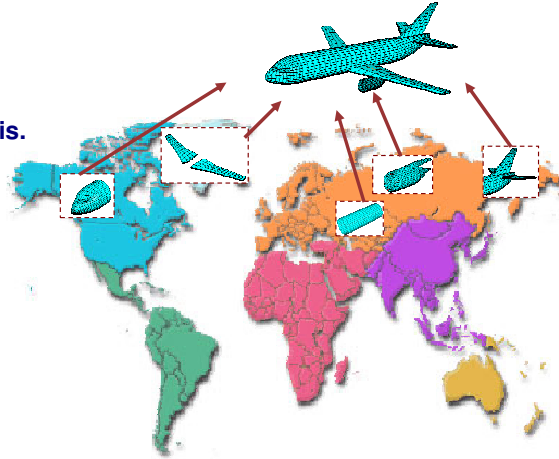

Copyright DASSAULT SYSTEMES

Instructor Notes:

Analysis Assembly Process



1 Attach shapes to parts in product

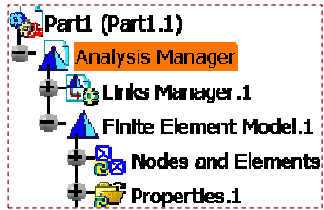

2 Assign connection properties

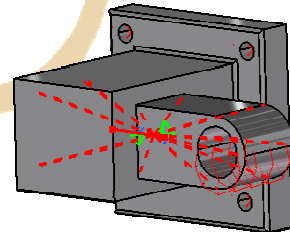

3 Apply loads and constraints

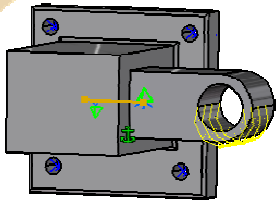

4 Perform global analysis and view results

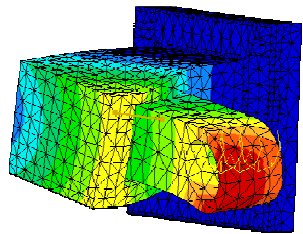

Copyright DASSAULT SYSTEMES

Instructor Notes:

What is Shape Representation

The analysis document is an alternate shape representation of the Part document. Attaching the FE analysis document to a part is known as attaching shape representation to part. It is defined by using the 'Manage Shape Representation' option in the product's contextual menu.

- For a given part there can be more than one shape representation.
- You can attach any number of shape representations to a part.
- At a time only one shape can be active.

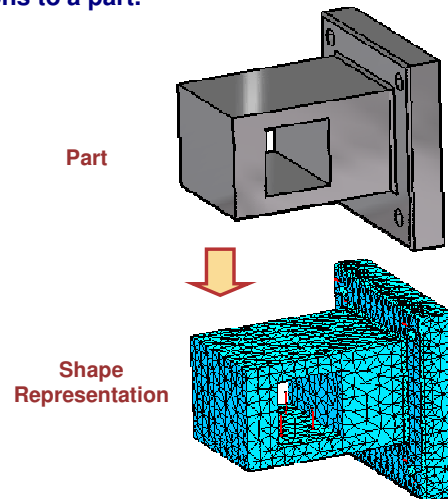
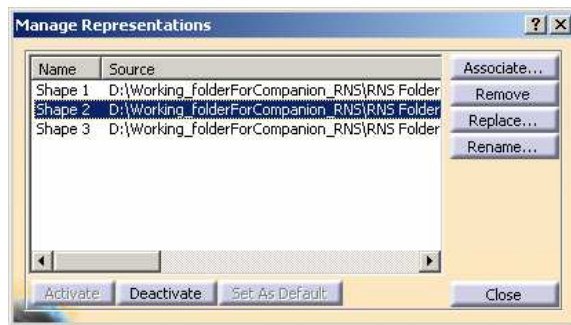

Copyright DASSAULT SYSTEMES

Instructor Notes:

How to Attach Shape to Part (1/2)

1 Open product document. Go to 'Analysis & simulation' workbench



2 Double Click on Links Manager



3 Double Click on Link to get Product tree

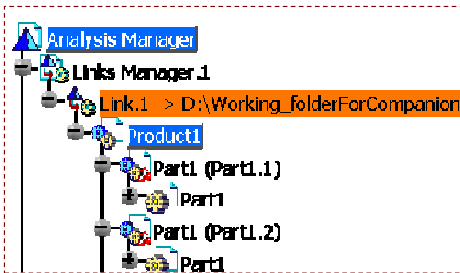

4 Double Click on Product

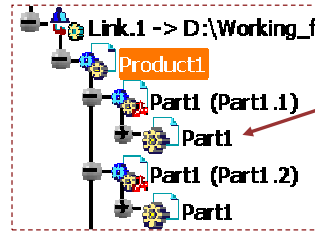

Only Part information



Part Model

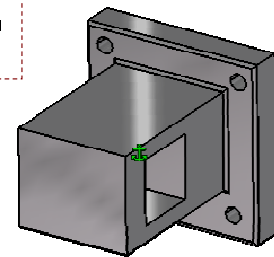

Copyright DASSAULT SYSTEMES

Instructor Notes:

How to Attach Shape to Part (2/2)

5 Click on Part contextual Menu Representations ->Manage Representations

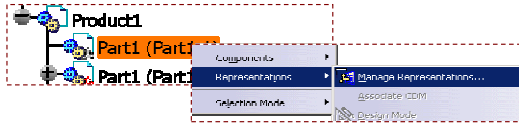

6 Click on Associate Button

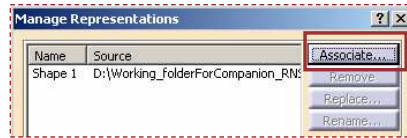

7 Select desired CATAnalysis File(shape) related to that part



8 Click on the same file in Manage Representation window and press activate button

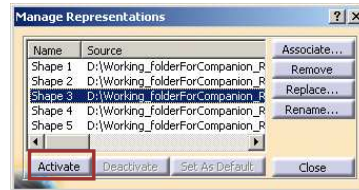

9 Click Close button

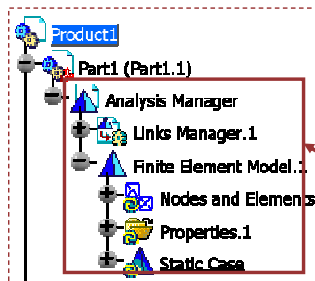

Mesh and FE properties information of part attached to part model

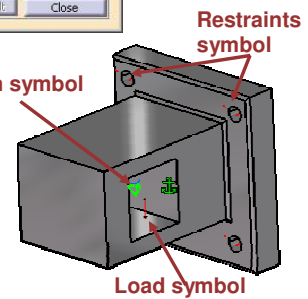

Copyright DASSAULT SYSTEMES

Instructor Notes:

How to Attach Analysis Document in Product Tree (1/2)

You can directly attach Analysis document in product tree.

- 1 Right-click on the product structure to open contextual menu. Click on components.

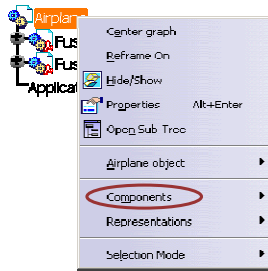

Existing product structure

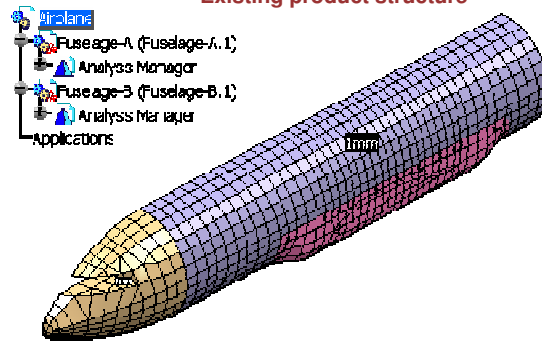

- 2 Click on existing components

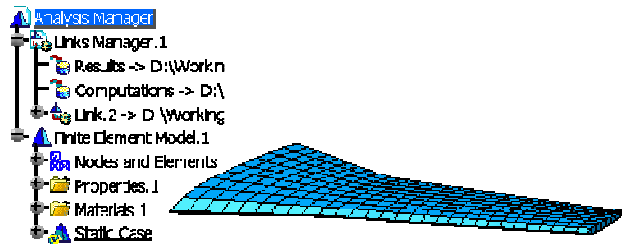
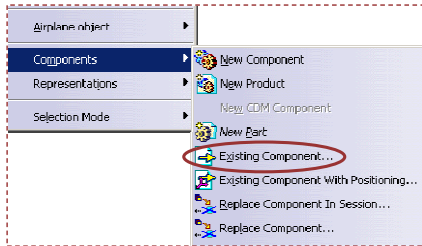

Wing Part Analysis document to be directly attached in Existing product structure

Copyright DASSAULT SYSTEMES

Instructor Notes:

How to Attach Analysis Document in Product Tree (2/2)

- 3 Select the required CATAnalysis file and click 'Open' to attach the file.

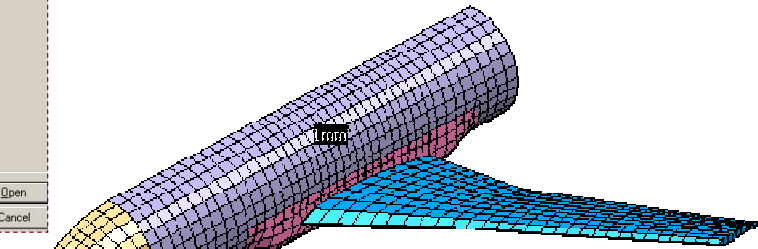
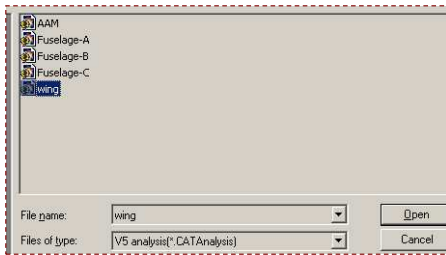

Wing Part Analysis document attached in Existing product structure

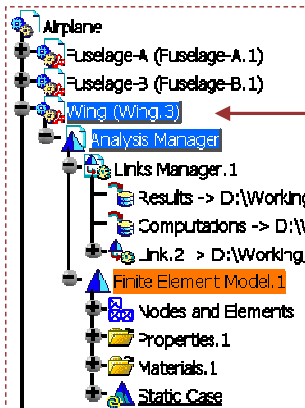

You can see the part document automatically gets attached in product structure and the selected CATAnalysis document gets attached as shape to part document. You can check this using Representations > Manage Representations in Part Contextual menu in specification tree

Copyright DASSAULT SYSTEMES

Instructor Notes:

How to Attach Orphan Mesh Analysis Document (1/2)

You can directly attach orphan mesh analysis document in product tree. Orphan mesh analysis is analysis of imported mesh having no geometric support.

- 1 Right-click on the product structure to open contextual menu. Click on components.

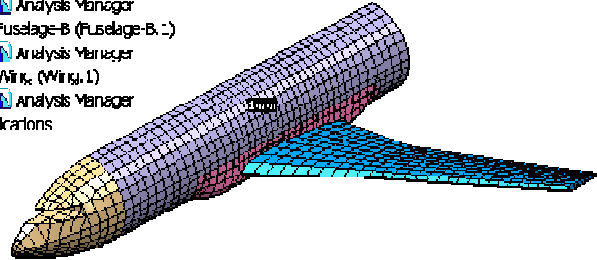
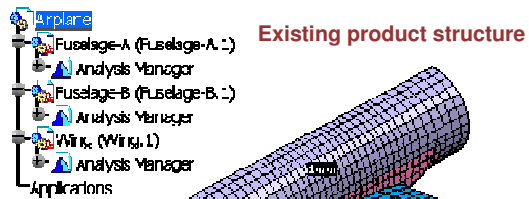
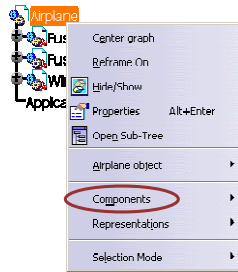

- 2 Click on existing components

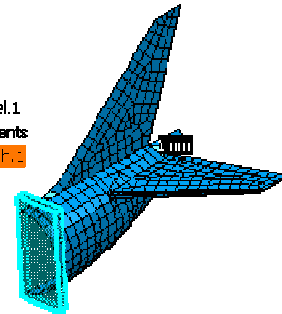
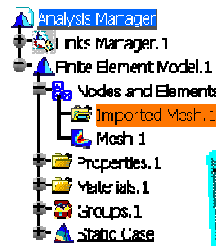
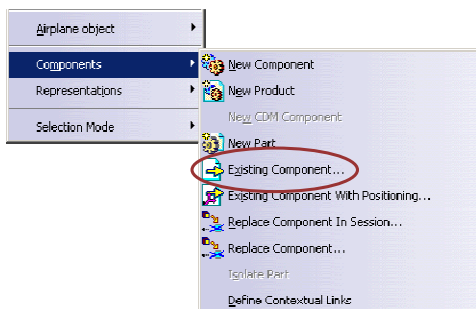

Orphan mesh analysis to be assembled in Existing product structure

Copyright DASSAULT SYSTEMES

Instructor Notes:

How to Attach Orphan Mesh Analysis Document (2/2)

- 3 Select the required CATAnalysis file and click 'Open' to attach the file.

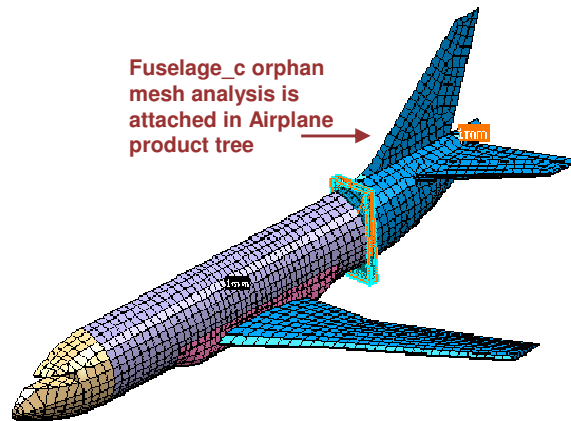
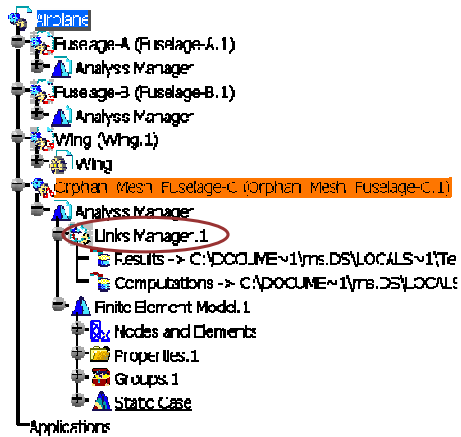
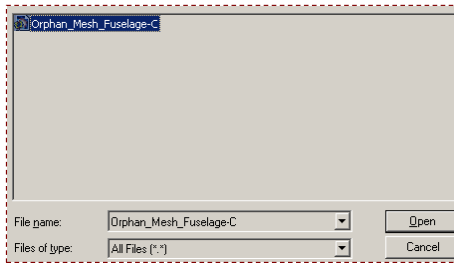

Fuselage-c orphan mesh analysis in Airplane product tree

You can observe that there is no link for geometric support in 'Links Manager.1'

Copyright DASSAULT SYSTEMES

Instructor Notes:

What is Analysis Assembly 2D Viewer

Analysis Assembly 2D Viewer enables you to add or remove a shape, activate or deactivate an existing shape, and add or remove a product component in Analysis Assembly. These changes in the Analysis Assembly document is updated using the Analysis Assembly 2D viewer.

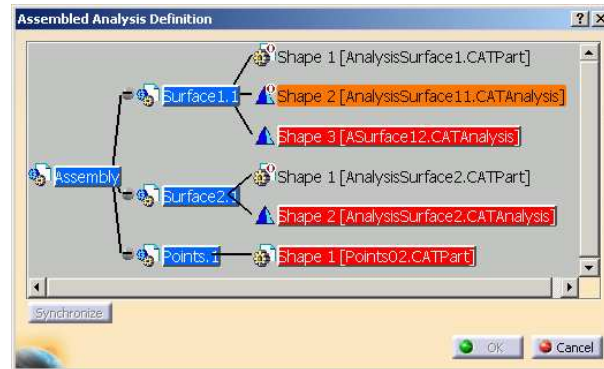

Copyright DASSAULT SYSTEMES

Instructor Notes:

How to Use Analysis Assembly 2D Viewer

The Analysis Assembly 2D Viewer is used when shapes are activated or deactivated, and when a part is added or removed from the Analysis Assembly Tree.

1 Double click Analysis Manager

2 Click on Analysis Assembly 2D viewer

3 Click on Synchronize button and press OK

Red color shows newly attached shape is current shape

Earlier attached shape

Newly attached shape to same part to be updated

Copyright DASSAULT SYSTEMES

Instructor Notes:

Analysis Assembly Recap Exercise

This exercise will help you to grasp the concepts of Analysis Assembly Management.

Analysis Assembly of Airplane Recap Exercise

Copyright DASSAULT SYSTEMES

Instructor Notes:

Analysis Assembly

Recap Exercise



This exercise is composed of four main steps:

- ▣ Attach shape to each part in assembly
- ▣ Create Analysis Connections between components
- ▣ Assign Analysis Connection Property to each Analysis Connection
- ▣ Apply loads and restraints
- ▣ Compute global analysis and view results

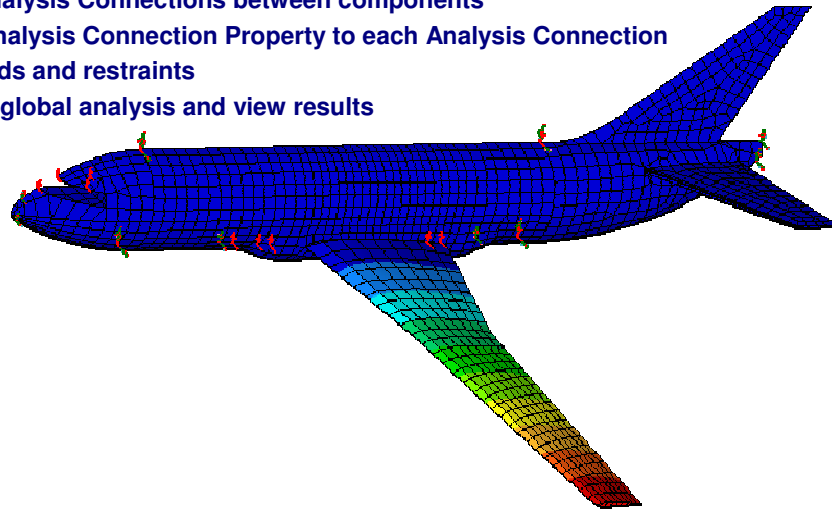

Copyright DASSAULT SYSTEMES

Instructor Notes:

To Sum Up ...

You have seen Analysis Assembly Management:

- What is Analysis Assembly
- Why use Analysis Assembly
- Analysis Assembly Process
- What is Shape Representation
- What is Analysis Assembly 2D Viewer

Copyright DASSAULT SYSTEMES

Instructor Notes:

To Sum Up ...

You have seen CATIA V5 Generative Assembly Structural Analysis:

- Introduction to GAS
- How to define Analysis Connections
- How to define Face Face Connection Properties
- How to define Distant Connections Properties
- How to define Welding Connections Properties
- How to define Nodes to Nodes Connection Property
- Analysis Assembly Management

Copyright DASSAULT SYSTEMES

Instructor Notes:

Master Exercise

You will practice concepts learned throughout the course by building the master exercise and following the recommended process

- ▣ **Assembly Analysis Presentation**
- ▣ **Static Analysis on an Assembly (1): Pre-Processing**
- ▣ **Static Analysis on an Assembly (2): Computation**
- ▣ **Static Analysis on an Assembly (3): Results Visualization**
- ▣ **Static Analysis on an Assembly (4): Publishing Report**

Copyright DASSAULT SYSTEMES

Instructor Notes:

Exercise



Static Analysis on an Assembly: Presentation



90 min

In this exercise you will run a static analysis on an assembly.

You will:

- Define the Analysis Connections between the parts
- Define the Restraints and a Load
- Compute the Analysis
- Visualize the Von Mises Stresses and the Deformed Mesh
- Publish an Analysis Report

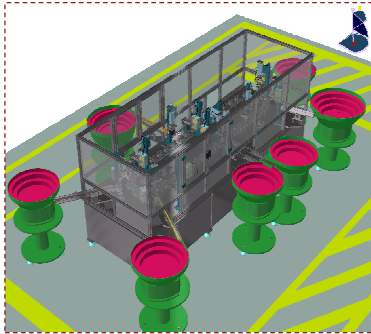

Copyright DASSAULT SYSTEMES

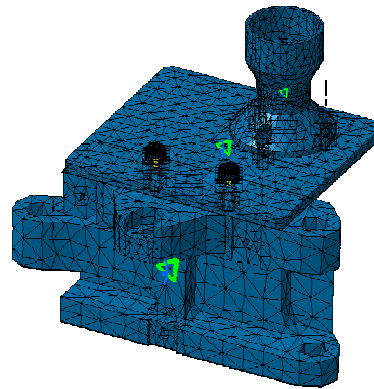

Instructor Notes:

Exercise

Static Analysis on an Assembly (Step1): Pre-Processing



40 min

Objectives:

- Define the Analysis Connection
- Define the restraints
- Define the load

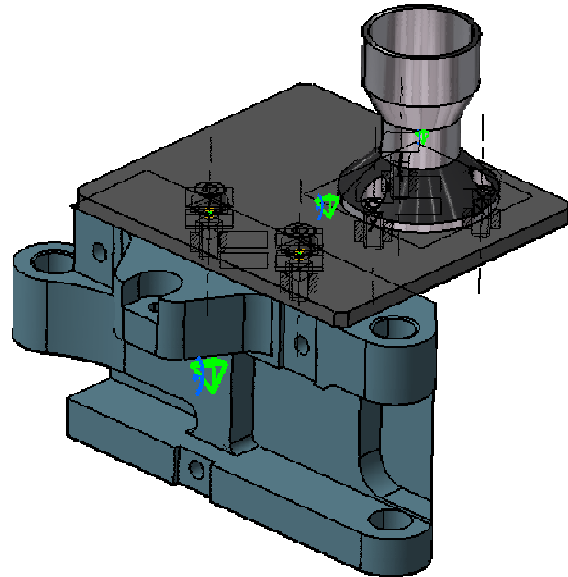

Copyright DASSAULT SYSTEMES

Instructor Notes:

Exercise

Static Analysis on an Assembly (Step2): Computation



5 min

Objectives:

- Define the storage location
- Compute the analysis

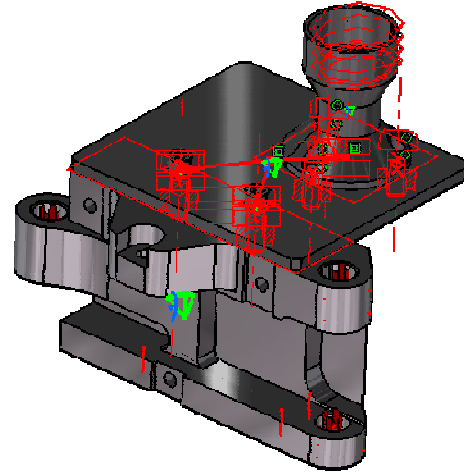

Copyright DASSAULT SYSTEMES

Instructor Notes:

Exercise

Static Analysis on an Assembly (Step3): Result Visualization



35 min

Objectives:

- Visualize the Von Mises stress
- Visualize the stress on specific parts
- Optimize the Color Map for a better display
- Use the “Cut Plane analysis”
- Animate the deformed mesh

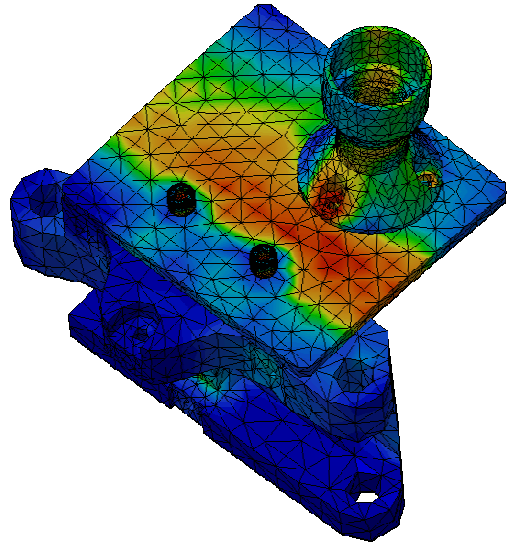

Copyright DASSAULT SYSTEMES

Instructor Notes:

Exercise

Static Analysis on an Assembly (Step 4): Publishing Report



10 min

Objectives:

- Publish an Analysis Report as HTML file
- Customize this Report
- Visualize it

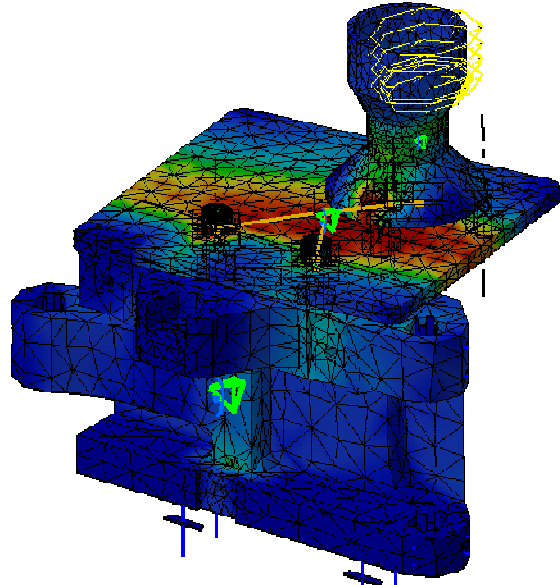

Copyright DASSAULT SYSTEMES

Instructor Notes: