

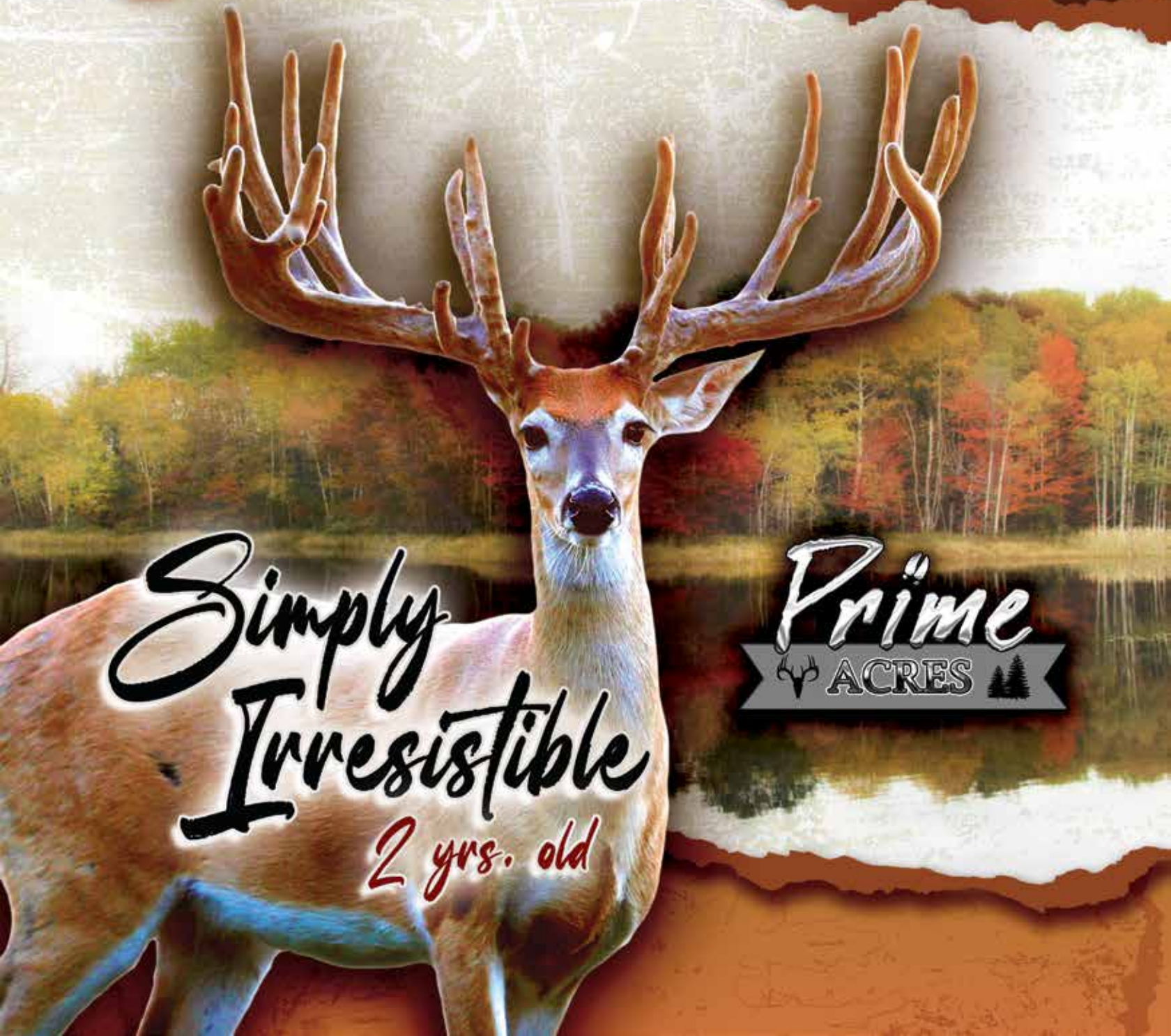

Alabama

DEER ASSOCIATION

FALL 2022



*Simply
Irresistible*
2 yrs. old

Prime

ACRES

JOSÉ @3

SUDDEN EXPRESS / OVERNIGHT EXPRESS / BAMBI 727 / EDI

CONVENTIONAL & SEXED SEMEN AVAILABLE



NADR# 322338

**BACKWOODS
WHITETAILS**

Dane Dorsett » (205) 577-0524

**THE
ANTLER
COMPANY**

Reid Faucett » (256) 677-1554

FOR LEASE

DEER FARM ESTABLISHED FOR OVER 35 YEARS!

Deer Handling Facility + 8 Breeder Pens

- CONSULTATIONS ALSO AVAILABLE -

- Deer Acquisition
- Medications Needed
- Artificial Insemination
- Custom Deer Trailer Rental
- Handling Procedures
- Deer Health
- Disease Control
- Semen
- Pasture Content
- Preferred Feeds

*Just in Time for
Breeding Season!*

29874 McKee Rd.
Toney, AL 35773

**CALL
(256) 990-3838**

Terry & Belinda Kennedy were one of the first Alabama Deer Farms to begin Artificial Insemination years ago. Their

COMPREHENSIVE HANDLING FACILITY

includes their unique "OCTAGON" SEPARATOR with another SEVEN 8'x8' HOLDING STALLS.

THIS ENTIRE AREA is insulated, heated & cooled.

THE BREEDING PENS were designed with 80% pasture & 20% woods as desired for raising deer, with several of the pastures having heavy clover content already.



Terry & Belinda of Southern Yankees Deer Farm have downsized to a few pet deer!

CALL (256) 990-3838



SKEET SHOOT

THURSDAY SEPTEMBER 29

LUNCH INCLUDED 1ST, 2ND, & 3RD PRIZES

LOWER WETUMPKA SHOTGUN SPORTS CLUB
9:30 A.M.

DOOR PRIZES

BRING YOUR OWN AMMO OR BUY ON SITE.
BRING YOUR OWN GUN OR RENT ON SITE.

ENTRY FEE \$1000 PER TEAM (UP TO 4 PEOPLE)

SIGN UP WITH CASEY OR BILLY
YOU WILL RECEIVE A PAYMENT LINK.
(PAY WITH CREDIT CARD OR CHECK)

DONATIONS AND SPONSORS ARE BEING COLLECTED.
PLEASE REACH OUT TO ANY OF THE BOARD MEMBERS
IF YOU HAVE ANY QUESTIONS.

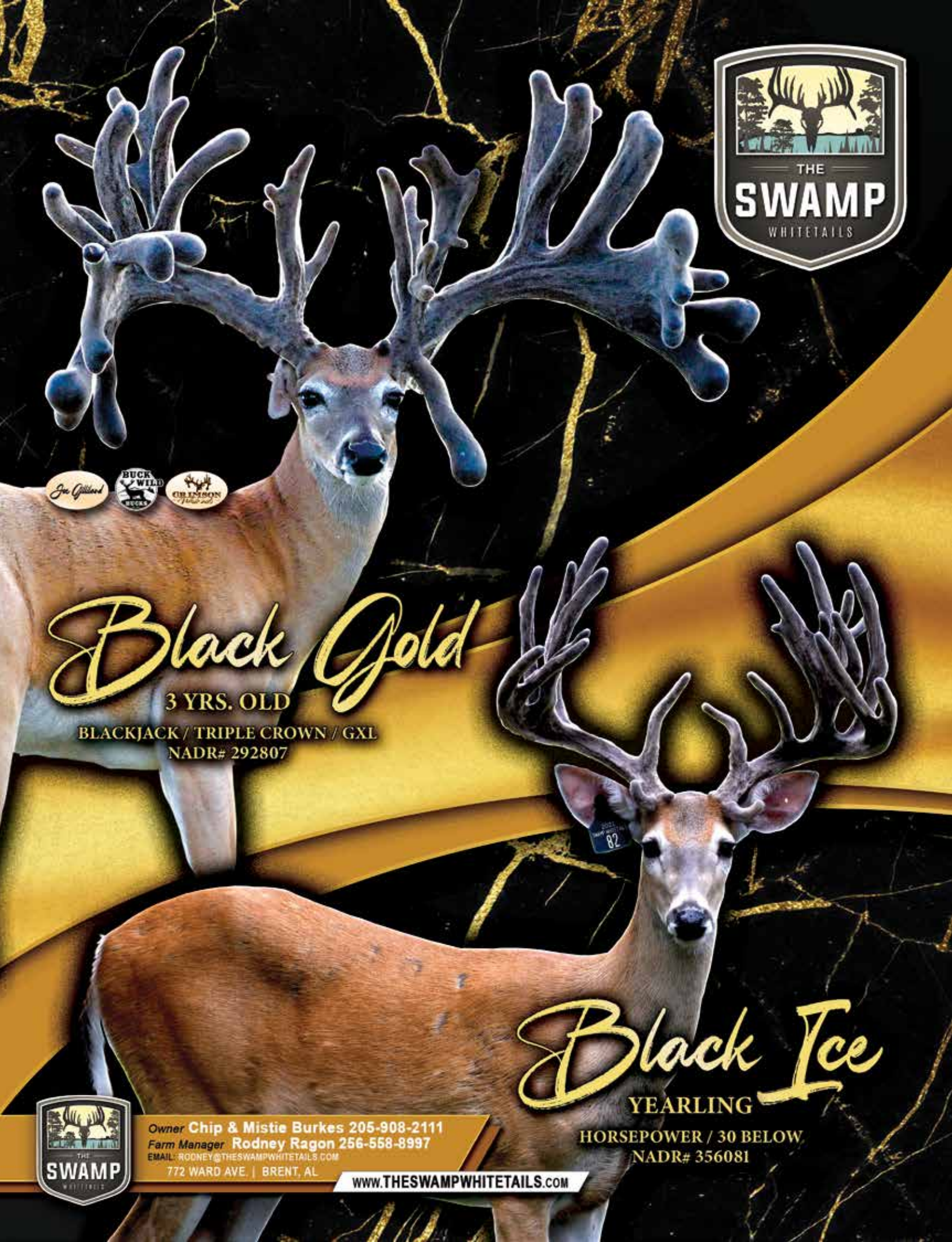

Black Gold

3 YRS. OLD

BLACKJACK / TRIPLE CROWN / GXL
NADR# 292807

Black Ice

YEARLING

HORSEPOWER / 30 BELOW
NADR# 356081



Owner Chip & Mistie Burkes 205-908-2111
Farm Manager Rodney Ragon 256-558-8997
EMAIL: ROONEY@THESWAMPWHITETAILS.COM
772 WARD AVE. | BRENT, AL

WWW.THESWAMPWHITETAILS.COM

GOH

GAME OF HORNS RANCH

EXPERIENCE THE HUNT OF A LIFETIME
BUCKS | DOES | BREEDERS | STOCKERS



BIG HICKORY

007 BOND

THOR

ELVIS

BIG DAVE

MR. PERFECT

BIG BO

FOR INFORMATION ON HUNTS, CONTACT JERRY SMYLY
(334) 216-0195 • INFO@GAMEOFHORNSRANCH.US • GAMEOFHORNSRANCH.US
2765 COUNTY RD. 44 FAUNSDALE, AL. 36738

TABLE OF CONTENTS

■ CATALOG ONLINE @ ALABAMADEERASSOCIATION.COM

ADA PRESENTS

- ADA Skeet Shoot..... 2
- ADA Facebook..... 5
- ADA Membership Application 6
- 2022-23 ADA Board of Directors 7
- ADA Save The Date ~ SPRING AUCTION 2023 9
- ADA Quarterly Magazine Media Packet 10
- ADA Lifetime Members..... 14-15

ARTICLES

18 **Antler Growth Process**
by Mickey W. Hellickson, Ph.D.

31 **Semen Storage & Handling**
by AI Diversified, Inc.



ADVERTISERS

- Advanced Deer Genetics..... 22
- Alabama Game Fence..... 17
- Backwoods Whitetails..... I.S. Front Cover
- Blackjack Whitetails 28
- Blessed Bayou Elite Genetics 32
- Blue Creek Whitetails 13
- Cross Canyon Whitetails 33
- Dugger Mountain Whitetails 19
- Game of Horns 4
- Guntersville Animal Hospital..... 30
- Hidden Antler Whitetails 26-27
- Limitless Genetics 39
- Lonehollow/ZFG 4, 20-21
- MVP Whitetails 29
- Parris Hollow Farms 16
- Pnuedart..... 40
- Prime Acres Front Cover, I.S. Back Cover
- Purina 36
- Record Rack..... 38
- Soggy Bottom Lodge..... 12
- SOUTHERN YANKEES..... 1
- Straight Shooter Game Fence..... 35
- Tannenwood Whitetails..... 25
- The Swamp Whitetails..... 2, Back Cover
- Whitetail Marketing Inc. 11

CONSIDER JOINING THE ALABAMA DEER ASSOCIATION
& see what great benefits ADA has to offer with your membership commitment!
There are two memberships available, Platinum Membership & Diamond Membership.

Everyone Benefits from Healthier Deer & Better Harvests.

Give us a call for more info!
Contact Amy Murphy at 205-928-2906
or email at Amy@TheSwampWhitetails.com



@ALABAMA DEER ASSOCIATION



ALABAMA DEER ASSOCIATION
2 Industrial Rd. • Brent, AL 35034
MEMBERSHIP APPLICATION



ADA 2022-2023 Board of Directors
Rodney Ragon, Cameron Oden, Billy Norris, Casey Mitchell

Troy Zachini, Dane Dorsett, Matt Watts, Chris Wiggly, Jason Edmondson, Joe Headley, Jeff Beaver, John Biddle, Chad McMichael, Dustin Reid

Member Name: _____

Partner/Spouse: _____

Farm or Business Name: _____

Address: _____

City: _____ State: _____ Zip: _____

CHECK ALL THAT APPLY: Preserve Breeder Associate Broker Hunter

Website: _____ Home Ph#: _____

Business #: _____ Cell Ph#: _____

Fax #: _____ E-Mail: _____

CODE OF ETHICS

I hereby make application for membership in the ALABAMA DEER ASSOCIATION agreeing to conform to the ALABAMA DEER ASSOCIATION CODE OF ETHICS and BYLAWS governing this Association.

Signature: _____ Date: _____

CLASSIFICATIONS (Please check one)

Bronze Member: Annual Dues Amount: \$35.00

Each Bronze Member shall be entitled to receive quarterly ADA magazine. Bronze Memberships renew every year at the Annual Membership Meeting. NO VOTING RIGHTS.

Silver Member: Annual Dues Amount: \$50.00

Each Silver Member is understood to provide goods and/or services to the industry. Silver Members shall be entitled to receive quarterly ADA magazine. Silver Memberships renew every year at the Annual Membership Meeting. NO VOTING RIGHTS.

Gold Member: Annual Dues Amount: \$100.00

Each Gold Member shall be entitled to attend all ADA meetings and receive quarterly ADA magazine. Gold Memberships renew every year at the Annual Membership Meeting. VOTING RIGHTS IN STATE MEMBERS ONLY.

Diamond Member: 5 YEAR MEMBERSHIP Dues for 5 Years Amount: \$500.00

Each Diamond Member shall be entitled to attend all ADA meetings and receive quarterly ADA magazine. VOTING RIGHTS IN STATE MEMBERS ONLY. DIAMOND MEMBERS WILL BE RECOGNIZED ON THE ADA WEBSITE AND IN ALL MAGAZINES FOR 5 YEARS.

Lifetime Member: LIFETIME MEMBERSHIP One-Time Dues Amount: \$1,000.00

Each Platinum Member shall be entitled to attend all ADA meetings and receive quarterly ADA magazine. VOTING RIGHTS IN STATE MEMBERS ONLY. PLATINUM MEMBERS WILL BE RECOGNIZED ON THE ADA WEBSITE AND IN ALL MAGAZINES AND TRADESHOWS FOR THE LIFE OF THE MEMBER.

The Board may change dues from time to time.

Payment method: Paid with Enclosed Check
 Visa Mastercard Discover American Express

Card # _____

Exp. Date _____ CW _____ Signature: _____

Return by Mail to ADA: 2 Industrial Rd. • Brent, AL 35034



NEXT AD DEADLINE
ALABAMA DEER PUBLICATION
Winter Issue
NOV 1

ADA MAGAZINE AD RATES

ANNUAL AD PRICING

2 Page Spread (All Four Issues) \$2,500.00
Full Page (All Four Issues) \$1,500.00
Half Page (All Four Issues) \$750.00

PER ISSUE PRICING

2 Page Spread (One Issue) \$650.00
Full Page (One Issue) \$375.00
Half Page (One Issue) \$175.00

The Alabama Deer Association
2 Industrial Rd. | Brent, AL 35034

PUBLICATIONS

Amy Murphy

Cell: 205-928-2906, Email: Amy@TheSwampWhitetails.com

Casey Mitchell

Cell: 205-531-9600, Email: CMitchell455@gmail.com

The Publications Committee and the ADA do not guarantee nor accept liability for the accuracy or correctness of this publication. We will however do our best to provide you with good usable information.

The ADA Publications Values Your Input!

Send News, Ideas, Classifieds, Advertising, Articles, etc. to:

Email Amy at
Amy@TheSwampWhitetails.com

MEMBERSHIP RENEWAL

Stay Current & Up to Date in the State!

NEW!! You Can Now
**RENEW YOUR ANNUAL
ADA MEMBERSHIP ONLINE!!!**

ALABAMADEERASSOCIATION.COM

BOARD OF DIRECTORS

MEET THE ADA 2022-23 TEAM



Dane Dorsett
205-577-0524
danedorsett@gmail.com



Troy Zachini
334-346-2255
info@troyshuntclub.com



RODNEY RAGON
256-558-8997
Rodney@theswampwhitetails.com

PRESIDENT



Matt Watts
(205) 361-2298



Chris Wigley
256-738-5059
cwigley@bloutboe.net

VICE PRESIDENT



Cameron Odom
251-689-7321
fiveosranch@gmail.com



Joe Headley
256-287-1691
headley25@aol.com



Jason Edmondson
205-296-0062
bisonalabama@yahoo.com

TREASURER



Billy Norris
205-275-4686
deerplace16@gmail.com



Jeff Beaver
256-571-5054
jeff@olympiaconstruction.net



John Biddle
205-337-4521

SECRETARY



Casey Mitchell
205-531-9600
cmitchell455@gmail.com



Chad McMichael
256-295-3945



Dustin Reid
256-239-2457
piedmontfencing@cableone.net

QUESTIONS?
CONTACT ADA!!

LONEHOLLOW

WHITETAILS

PARTNERED WITH



VOLT^{@2}

BUCKY RICHARDSON • ZFG WHITETAILS • 251.331.4978 • BUCKY@MANGRANDS.COM

GRANT GARNER • 936.355.6171

WWW.LONEHOLLOWWHITETAILS.COM

ADA SPRING AUCTION

FEB 24 & 25

2023

NEW LOCATION



Brick Haven
1889 US-278
Cullman, AL 35057



Mark Your Calendar

ADA SPRING AUCTION

2022-2023 MEDIA KIT

AD SPECS & RATES

FULL PAGE AD

Final Ad Size w/ Bleed
8.75" x 11.25"
Live Area
8" x 10.5"

LIVE AREA

Keep All Important Elements (type, logos, etc.) inside this area.

MARGIN (1/4" Margin on all 4 sides)

Safety Zone between the advertisement live area and the page trim. Paper may move while cutting and this area may be trimmed from the page.

BLEED (1/8" Bleed on all 4 sides)

Outside of the page trim, necessary to prevent a white line around the advertisement. All elements in this area will be cut off.

FILE REQUIREMENTS

Resolution: 300 dpi
Color Format: cmyk
File Type: .jpg or .pdf
(file saved as Company Name)

HALF PAGE HORIZONTAL

Final Ad Size w/ Bleed
8.75" x 5.625"
Live Area
8" x 4.875"

2 PAGE SPREAD

Final Ad Size w/ Bleed
17.25" x 11.25"
Live Area
16.5" x 10.5"



Everyone Benefits with ADA...
Healthier Deer, Better Harvests

ADVERTISE TODAY IN THE ADA QUARTERLY MAGAZINE!

Informative articles on current topics
& news can be found in each issue
and will benefit you.

Don't Miss Out!

These pages are **ONLY** offered
to the highest bidder at the
Annual ADA Spring Auction!

- Front Cover
- Inside Back
- Inside Front
- Back Cover
- Centerfold
- Spotlight Articles

ADA MAGAZINE

Winter	Spring	Summer	Fall
--------	--------	--------	------

To Advertise in the ADA Quarterly Magazine
please call for additional information.

WINTER ISSUE

Ad Deadline: November 1

SPRING AUCTION CATALOG

Ad & Consignment Deadline: December 31
This is a **FIRM DEADLINE** No Extensions, No Exceptions

SUMMER ISSUE

Ad Deadline: April 15

FALL ISSUE

Ad Deadline: September 1

ADA MAGAZINE AD RATES

Ad Size	4X	1X
2 Pg. Spread	\$2,500	\$650
Full Page	\$1,500	\$375
Half Page	\$750	\$175

RESERVE YOUR SPOT TODAY!

205-928-2906

Amy@TheSwampWhitetails.com
www.AlabamaDeerAssociation.com



GET THE MOST BANG OUT OF YOUR BUCKS

AD DESIGN & LAYOUT, CUSTOM CATALOGS
TRADESHOW DISPLAYS & PRINT ADVERTISING
WEBSITES, E-BLASTS, & So Much More!



KRISTY SCHWARTZ
PRESIDENT, Graphic Designer & Illustrator



cell: 262.949.5041
fax: 1.262.364.2123



whitetailmarketing@gmail.com
www.WhitetailMarketing.com

SOGGY BOTTOM LODGE

WWW.SOGGYBOTTOMLODGE.COM



WHITE TAIL DEER HUNTING • ELK HUNTS • FALLOW DEER HUNTS
DUCK HUNTS • QUAIL HUNTS • PHEASANT TOWER SHOOT
FISHING • SKEET SHOOTING • KAYAKING • GUIDED BUGGY RIDES
WEDDINGS • CORPORATE MEETINGS • MASSAGES

FOR MORE INFORMATION, CONTACT:

BRANDON SMITH:
BRANDON@SOGGYBOTTOMLODGE.COM
(334) 654-4750

BRANDY LEWIS:
BRANDY@SOGGYBOTTOMLODGE.COM
(334) 295-5430



ARE YOU READY?

SUDDEN EXPRESS / FREEZE FRAME / G HAMMER / TASHA



(361) 935-8821 • JIMMIE@BLUECREEKWHITETAILS.COM • BLUECREEKWHITETAILS.COM



LIFETIME MEMBERS

LIFETIME MEMBERS

RECOGNIZED ADA LIFETIME MEMBERS

RECOGNIZED ADA LIFETIME MEMBERS



JASON COE
Oneonta, AL

Alabama's Finest
Hunting Lodge

JOE HEADLEY
Clanton, AL



BRIAN DOEGE
Elberta, AL



BO PIERCE
Camden, AL



JEFF BEAVER
Alberville, AL



STAN PARKER
Morris, AL



DARRELL CHAMPION



LEE HULSEY



JASON CARVER
Salem, AL



EDWARD MURPHREE
Columbiana, AL



STEPHEN FRED BECK
Tuscaloosa, AL



BRETT DAVIS
Brent, AL



DAVID DIVINE
Glencoe, AL



DUSTIN REID
Piedmont, AL



CAMERON ODOM
Citronelle, AL



BRIAN WARD
Mobile, AL



J.J. MEEKS



SCOTTY HOOPER
Cullman, AL



WES HOLLINGSWORTH



JASON PILGER
Mobile, AL



SCOTT BOUTWELL
Phenix City



CURT EDDY
Odenville, AL



CHRIS WIGLEY
Horton, AL



AMY NOLD
Urich, MO



**PARRIS HOLLOW FARMS
FYFFE, AL
JOHNNY PARRIS
Fyffe, AL**



Williamsport, PA



RICKY SPRATLIN
Tuskegee, AL



LEE HARKINS
Pelham, AL

Scottie's Whitetail
Deer Farm

SCOTTIE KELLEY
Alberville, AL



TIMOTHY SPILLER
Ariton, AL



TERRY KENNEDY
Toney, AL



TONIO SWORDS
Horton, AL



CHAD TANNER
Davisboro, GA



CHIP BURKES
Brent, AL



LEWIS BEAR
Pensacola, FL



TROY ZACCHINI
Forest Home, AL



MARK CLARK
Tibbie, AL



JUSTIN BUTTS
AL



KENNETH WALKER
Baileyton, AL



RUSTY WEAVER
Vestavia, AL

Thank You Lifetime Members!!

Your Support is Very Much Appreciated!



GEORGE CAGLE
Millbrook, AL



VALLERIE & SCOTT PARKER
Jemison, AL



RICKY BECK
Geneva, AL

Xtreme Whitetails
of Alabama

RICKY CLEVELAND
Oneonta, AL

BELINDA KENNEDY
TIM LIGHTSEY
TY ASHBERRY

WILL AINSWORTH
JOEY GILLILAND
CHRIS CENTAFONT

PARRIS HOLLOW FARMS

Parris Hollow Farms & Triple B Whitetails would like to invite our Alabama Breeder friends to consider using Quality **ALAMO** Sexed or Conventional Semen this up coming breeding season.

ALAMO is a proven producer of clean wide typical whitetail bucks that the shooter market is demanding.



CONTACT INFORMATION:

JOHNNY AND REGINA PARRIS
 PHONE: 256.630.2478 EMAIL: JDPARRIS@LIVE.COM
 ADDRESS: 1751 CO. RD. 18, FYFFE, AL 35971

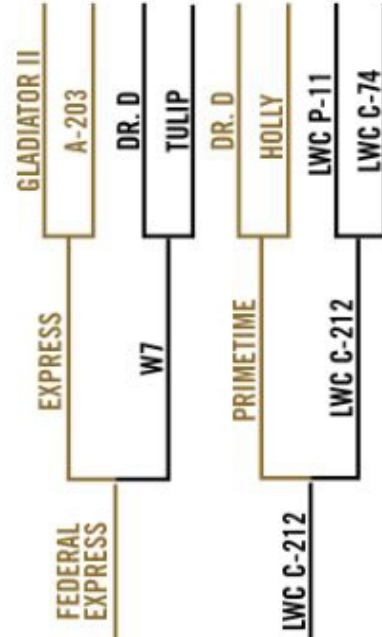

Brian, Brandy, & Brody Oden
 Fruithurst, AL
 (205) 789-0844



Quality Fencing Nationwide



WE WORK THROUGHOUT THE COUNTRY

BUILDING RELATIONSHIPS ONE FENCE AT A TIME!

256.221.1076
 BO@ALABAMAGAMEFENCE.COM

We offer FREE, Onsite Estimates!



ANTLERS!

...by Mickey W. Hellickson, Ph.D.

GROWTH PROCESS



ANTLERS...

There is something magical and mystical about deer antlers. Part of their allure is that every antler is different and unique. However, our fascination with deer antlers has its roots in our ancestors, who have hunted antlered game since mans' existence! Our ancestors used antlers for tools and in religious ceremonies. Today, we are still captivated by antlers.

HOW ANTLERS GROW AND WHY THEY ARE SHED each year is a source of wonder and curiosity. Antlers are one of nature's most remarkable accomplishments. Deer, which are capable of regrowing antlers every year, are the only mammals with this capacity to regenerate these complex appendages. The speed at which antlers grow, also makes them the fastest growing structure in the animal kingdom.

Antler growth in bucks begins when they are fawns. However, buck fawns never grow antlers larger than short "buttons", or pedicles, which on rare occasions become hardened. These pedicles then develop into the buck's first spike or branched antlers when he is a yearling (1.5 years old). Antler

size then continues to increase each additional year until peaking at age 6.5.

Deer farmers first discovered that if buck fawns were castrated before pedicle formation, they would never grow antlers. If females are given testosterone, small pedicles develop on their forehead that occasionally further develop into hardened antlers. Scientists have even succeeded in growing antlers on the legs and hips of deer by grafting a portion of the skull bone, where the pedicle forms, to these areas!

Bucks begin growing their antlers in late-winter or early spring, within weeks of when the previous year's antler are shed. Antlers grow very slowly at

DUGGER MOUNTAIN WHITETAILS

SUDDEN EXPRESS/FREEZE
FRAME/G-HAMMER/TASHA

ARE YOU READY @ 2

ALABAMA SEMEN AVAILABLE

DUSTIN & CHERYL REID
256-239-2457
piedmontfencing.reid@gmail.com

BULLWINKLE
LARGEST FALLOW BUCK
IN THE WORLD OVER 400"



ZFG
WHITETAILS



GEBV -0.245
GS @ 96

IN PARTNERSHIP WITH



LONEHOLLOW
WHITETAILS

NADR #250820

BLITZ

G3 OVER PHENOM'S DAM

ZFG WHITETAILS

BUCKY RICHARDSON · BUCKY@MANGRANDS.COM · 251.331.4978



ZFG
WHITETAILS

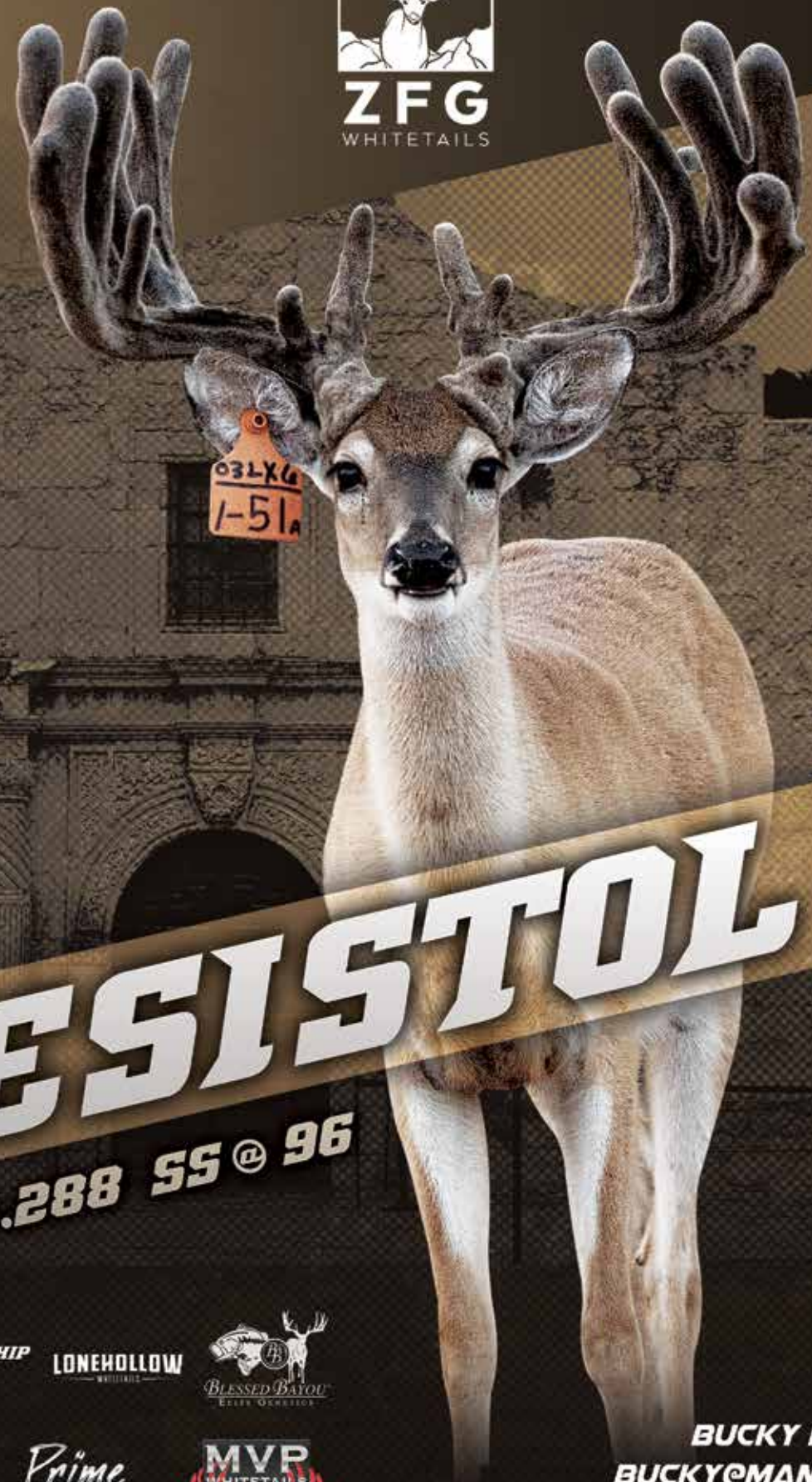

RESISTOL @1

GEBV -0.288 SS @ 96

IN PARTNERSHIP WITH:

LONEHOLLOW
WHITETAILS



Prime
YACKS



BUCKY RICHARDSON
BUCKY@MANGRANDS.COM
251.331.4978

THE DEER REPRO PIONEERS AND SPECIALISTS

Dr. Jason Coe, Veterinarian



ADG pioneered many of the deer AI and ET systems used today.

ADG is an International company with clients in USA, NZ, China, Korea, Europe, Africa, Canada, Mexico.

ADG has a state of the art mobile semen processing unit, based in Texas, offering service throughout the USA.

ADG performed all the initial sexed semen research with Sexing Technologies.

ADG has vast experience in reproductive work with whitetail, mule deer, red deer, elk, fallow deer, sika, marlu, sheep, goats and exotic species.

ADG is successfully running Elk and Fallow deer ET programs.
CALL US FOR YOUR BOOKING.

ADVANCED DEER GENETICS

CALL US FOR YOUR ALL YOUR REPRO NEEDS:

Semen collection and processing
Embryo flushing & transfer
Laparoscopic & Cervical A.I.

Principle: Dr. Jason Coe, Veterinarian
205.446.9386 -jcoe2001@gmail.com
Office 705.526.7414
camehaffey@earthlink.net



Dr. Mike Bringans, Consultant



WHY ARE THERE ANNUAL CYCLES IN ANTLER GROWTH?

Believe it or not, the 23 degree tilt of the earth's axis is the ultimate cause for the annual cycles in deer antlers. If the earth were perpendicular in it's orbit around the sun, there would be no changes in temperature and day length and no need for calendars. This tilt is what causes earth's annually recurring seasons. Deer have adapted their



first, but by late-May, antlers are rapidly growing. Antler growth is usually complete by the end of August. The velvet then hardens and falls off during September. The hardened, polished antlers remain until they are shed during January through March.

velveted antler to harden and the velvet to shed. Unlike antler shedding, velvet shedding usually occurs within a 24-hour period.

The antler cycle lags several months behind the changes in day length because the hormonal changes take time. During fall, decreasing day lengths cause melatonin production to increase, resulting in decreased production of both luteinizing hormone and testosterone. Decreasing testosterone levels then cause the antlers to shed.

physiology and behavior to these seasonal changes, including antler growth.

The environmental cue that regulates antler growth is the amount of day length or photoperiod. The physiological cue is the male hormone testosterone.

The way this works is complicated, but changing day lengths are sensed by the eyes, which send this message, via the optic nerve, to the pineal gland. The pineal gland, a pea-sized organ at the back of the brain, produces many different hormones. One hormone produced is the luteinizing hormone, which controls the amount of testosterone produced in the testes.

The pineal gland also produces a hormone called melatonin, which acts to suppress the production of luteinizing hormone, holding back production of testosterone. Melatonin is produced in higher and higher quantities as the amount of darkness during each day increases. During early summer, as the nights get shorter and day lengths increase, the production of melatonin decreases, allowing the pituitary to produce luteinizing hormone. Increasing amounts of this hormone then result in increased testosterone production, which triggers the



CAN THE CYCLES BE ALTERED?

When the day length cycles are artificially changed, deer grow antlers according to the new cycle. Scientists have shortened day length cycles to six months instead of one year. This doubling of the annual cycle caused deer to grow two separate sets of antlers in the same year! When scientists tripled the annual cycle (one annual cycle completed every three months), bucks grew three sets of antlers in one year, but the antlers only grew to about half of normal size. Scientists have also lengthened day length cycles, causing deer to grow antlers only every other year. These antlers still only grow to normal size, but the length of time bucks are in velvet increases.

In the past, scientists have also relocated deer from one hemisphere to another, such as the transplants of different deer species from North America and Europe (northern hemisphere) to New Zealand (southern hemisphere). These transplanted deer adapt their antler cycles to the opposite day length cycles of the new hemisphere, even though temperatures at the new location decrease as day length increases. Deer that live on the equator, where there are no seasonal fluctuations in day length, are able to breed year-round. However, breeding and antler growth in individual animals still occur on 12-month cycles that depend on the animal's birth date.

WHEN DOES ANTLER SIZE PEAK?

We have very conclusive data when it comes to knowing when antler size peaks for bucks in south Texas. We have now randomly live-captured over 4,000 bucks from the wild of south Texas. We have aged all of these buck by tooth wear and measured all of the racks according to Boone and Crockett Club (BCC) guidelines. On average, antler size and gross BCC score does not reach its maximum until a buck is at least five-and-a-half years old. In fact, many bucks do not peak in antler size until they are six-and-a-half or seven-and-a-half years old. Many of the body characteristics we have measured during past buck captures have also indicated that several body measurements do not peak until these same ages.

Clearly then, if you wish to allow bucks the opportunity to reach their full antler growth potential, they need to be allowed to live until at least five-and-a-half years old. However, many bucks will die of natural causes before reaching full maturity.

Dr. Mickey Hellickson is an internationally recognized expert on white-tailed deer and has given countless public presentations throughout the eastern and central U.S. and northern Mexico. He is a staff writer for the Journal of the Texas Trophy Hunter and past contributor to Quality Whitetails and Deer and Deer Hunting. He is an avid outdoorsman and has hunted big game on three continents.

MARIACHI @ 3

WITCH DR / DOS ANCHO / EXPRESS / MONARCH / 2WIDE'S WOMB

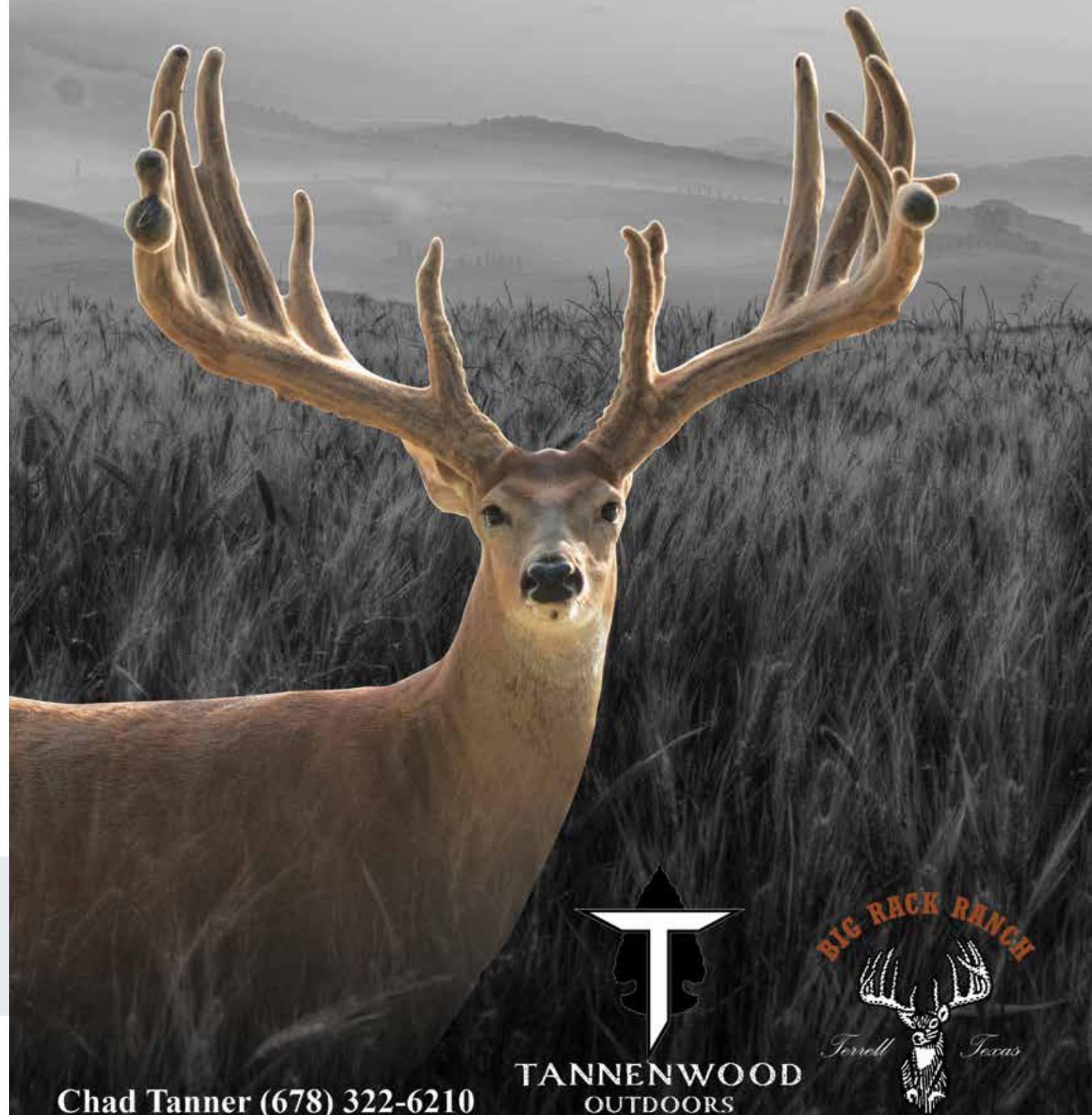

Chad Tanner (678) 322-6210

TANNENWOOD
OUTDOORS

MALE SEXED SEMEN!

OTHER SEMEN AVAILABLE

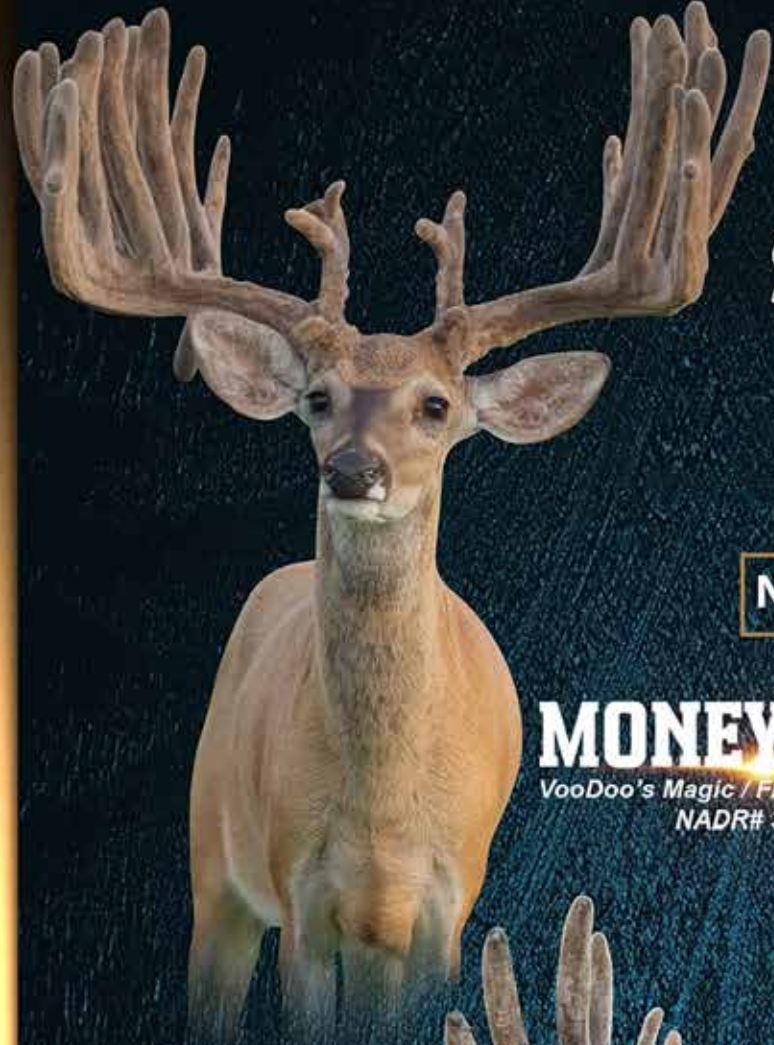

**HYPNOTIC
SOLD OUT IN
3 DAYS
LAST YEAR!**

Next Collection October 20th

MONEY SHOT

VooDoo's Magic / Freeze Frame / GXL
NADR# 333070

@2



HYPNOTIC

VooDoo's Magic / Reno / DBL Big Boy
NADR# 233961

@5

Randy Corparron

(281) 814-6580

www.hiddenantlerwhitetails.com



High
Caliber

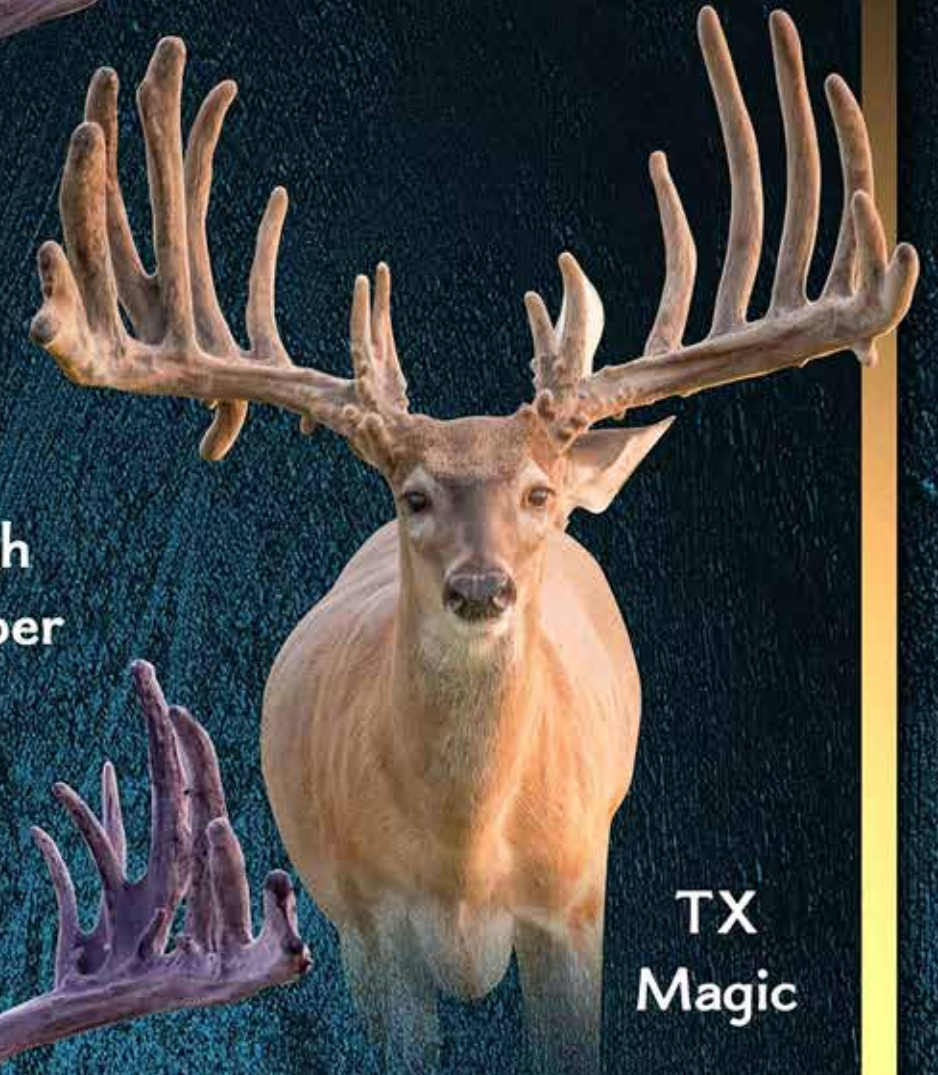

TX
Magic



Falkor

**CONVENTIONAL
SEMEN AVAILABLE &
LIMITED MALE SEXED
SEMEN AVAILABLE**

WE'VE GOT WHAT YOU NEED



Ozzy @2 NADR# 283434
Venom / 727 / Daggerdrop / Orange 6
(Yellow Diamond's Dam Womb Sis)

Hank @2 NADR# 284829
Waylon / Express / Jake The Dreambuck

Bonanza @4 NADR# 252320
Guardrail / Handsome / Yankee Doodle Dandy

Wallace @5 NADR# 266502
Perfect Dream / Stitches / Mighty Thor



BLACKJACK WHITETAILS
www.blackjackwhitetails.com

ROBERT MYERS
210.889.3962
Robert.myers@blackjackwhitetails.com

DAVID KOLAJA
210.639.0051
David.kolaja@blackjackwhitetails.com

ICEMAN

AT 2 YEARS OLD



THANKS FOR PARTNERING



ALABAMA SEMEN RIGHTS

NORTHERN SEMEN RIGHTS



SIZE MATTERS HITETAIL
MICHIGAN SEMEN RIGHTS

- OWNERS -

JADE WEBSTER • 214-683-9906
jade@mvpwhitetails.com
JALEN WEBSTER • 214-926-8575
jalen@mvpwhitetails.com



- RANCH MANAGERS -

MICHAEL BENDER • 361-449-5606
michael@mvpwhitetails.com



**ALABAMA WHITETAIL
VETERINARY SERVICES**
with GUNTERVILLE ANIMAL
HOSPITAL & SURGERY CENTER



AWVS offers
a complete line
of services dedicated
to keep your
**DEER FARMING
OPERATIONS**
ON THE CUTTING EDGE
of the industry.

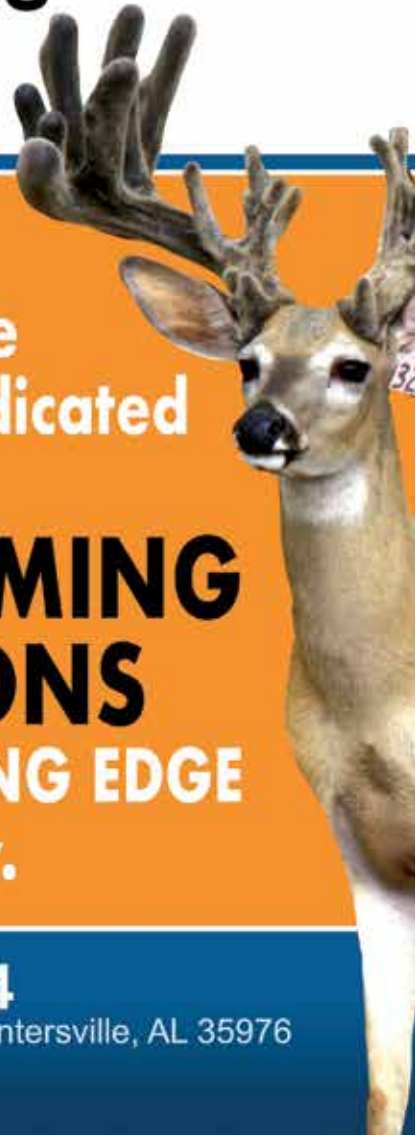

WhitetailVet.com 256-582-3184
1609 Henry Street | Gunterville, AL 35976

SEMEN STORAGE & HANDLING

...by Al Diversified, Inc.

GENERAL CARE

There has been many questions asked about semen handling and shipping, general care of a semen tank. I hope to clear up some of your questions today.

There have been many strides made in the semen collection and handling over the years. The most important is the straw, freezing and thawing process has led to improved sperm cell recovery if we can avoid the mistake of mishandling the straws.

We now have a huge increase in direct sales from producer to animal owner and inseminators. Recommendations for handling semen vary among inseminators and handling facilities so I will try to hit the highlights and give a general understanding of the semen tank and straw handling methods. By education, understanding and ending some confusion, the end result may be higher conception rates.

Semen tanks are available with six to eight month liquid nitrogen holding times. The maintenance of very low liquid nitrogen temperatures in the inside chamber is due to the high quality of solid insulation material and vacuum in the outer chamber. Any tank is susceptible to damage from mishandling. Accumulation of frost at the top of the tank indicates a rapid evaporation of liquid nitrogen. When I am

traveling from breeder to breeder and my tank has been jostled by the travel, I notice this from time to time. I check my levels of nitrogen every day and if I find a place to fill up with nitrogen I will stop and top off my tank.

There have been several field studies that have indicated there is no significant damage to semen stored in properly managed farm tanks. However, the State of Washington discovered during a field study liquid nitrogen completely evaporated in 3 of 60 tanks. This may not seem significant unless you are the producer with a significant amount of semen stored in this tank.





ROWDY

GEBV -.079 GG @ 96

2021 DBC GOLDEN BUCK

IN PARTNERSHIP WITH:



RESISTOL

GEBV -.288 SS @ 96

IN PARTNERSHIP WITH:



BLESSED BAYOU
ELITE GENETICS

INFO@BLESSEDBAYOU.COM | 281-739-7048 | BLESSEDBAYOU.COM



CROSS CANYON
WHITE TAILS

HOLLYWOOD
Monarch Supreme x Monarch Classic Sister



AFFIRMED
Triple Ex / Express / OPAL (Dreambo sister)

APOLLO

Triple Ex x Jenna (HARDCORE / GLADIATOR / TASHA)

CALL / TEXT: 512-635-4327 EMAIL: info@crosscanyondeer.com

WWW.CROSSCANYONDEER.COM

To help avoid this, follow some simple management practices:

- 1** Avoid excessive movement or abuse of the tank.
- 2** Routinely check nitrogen levels and keep records of levels (dates and depth). You can purchase a handy measuring stick made just for this.
- 3** Store semen tank in area with good light but not in direct sunlight. I also recommend a room that is not too hot, like the barn in summertime. Once a semen tank fails, it goes quickly. Have an alternate plan!
- 4** Always keep tank elevated above concrete floor or other wet surfaces. I find a wood pallet works great. Corrosion of the outer tank will shorten the life and possibly cause failure of the tank!
- 5** Store only the amount of semen needed for six months or one breeding season.

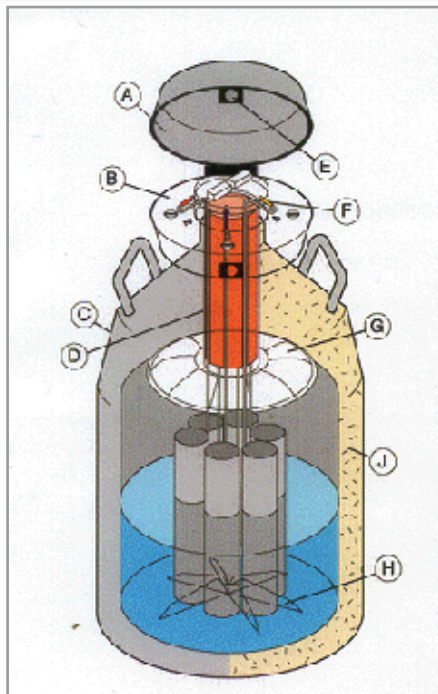

Liquid Nitrogen Semen Tank
 A. Durable, tamper-proof lid design
 B. Easy maintenance lid design
 C. Superior strength, lightweight aluminum construction
 D. High strength neck tube reduces liquid nitrogen loss
 E. Locking tab
 F. Color-coded canister/lid numbering system
 G. Advanced Chemical Vacuum Retention System - Designed for superior vacuum performance over the life of the product
 H. Spider design - for easy retrieval and insertion of product canisters
 J. Insulation - MVE's advanced insulation system provides maximum thermal performance

In a typical farm semen tank, dangerous temperatures exist in the upper half of the neck tube. See following:

Location in Neck Tube	Range in Temp (F)
Top	+36 to +54
1 inch from top	+5 to -8
2 inches from top	-40 to -51
4 inches from top	-148 to -184
6 inches from top	-292 to -313

Exposure to these differences in temperature can occur when semen is transferred from tank to tank or when handling semen within the neck while trying to locate a particular unit. Once the thermal injury is done to a straw it is permanent and cannot be corrected by returning semen to liquid nitrogen.

Following semen handling practices are recommended to minimize thermal damage.

- 1** Transfer of semen between tanks must be coordinated and rapid. Two people should be involved, and tanks sitting side by side. Try to have tanks filled before transfer. Raise canisters only to a level necessary to locate and appropriate the cane of semen you require.

- 2** Keep a semen inventory system and mount it on the wall or attach it to the tank. Try to cover the inventory and keep it from being destroyed. **I like to see the cane code, bull name and which canister it is stored in along with the number of straws you have in it.** As it is used, change the inventory.

- 3** When pulling a straw of semen for thawing raise the canister into the lower portion of the neck, identify the cane where straw is located. Lower the canister further into the neck to protect other straws from thermal damage. You may need to bend the top tab of the cane to a 45 degree angle to reduce the chance of bending the straw. Use tweezers to transfer straw to bath and quickly lower the cane back into canister and lower into tank.

STRAIGHT SHOOTER GAME FENCING



Services Provided

- Endlosures
- Breeder Pens
- Predator Wire
- Shade Cloth
- Custom Gates
- Clearing
- Water Gaps
- Lifetime Workmanship Warranty
- Agriculture Fence

Material Sales

- All Net Fence
- Gates
- Galv. Pipe & T-Post
- Fence Tools

FREE CONSULTATION!

**Installing Peace of Mind
...One Job at a Time
Since 1997**



**3527 Blue Road, Tuscumbia, AL 35674
(256) 381.2675 • www.ssgamefence.com**

A DIFFERENCE YOU CAN SEE
MAXIMIZE THEIR POTENTIAL

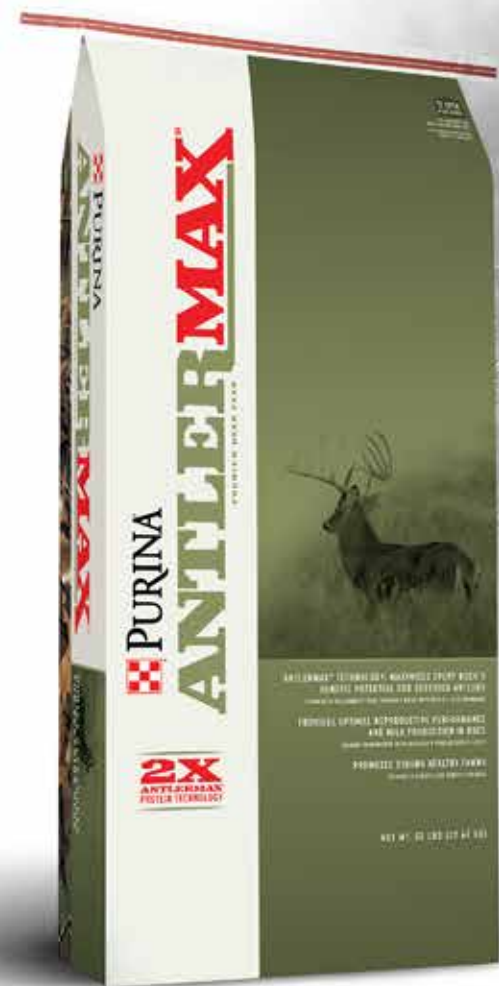

PURINA ANTLEMAX
ENHANCED WITH **CLIMATE GUARD**

©2021 Purina Animal Nutrition LLC. All rights reserved.

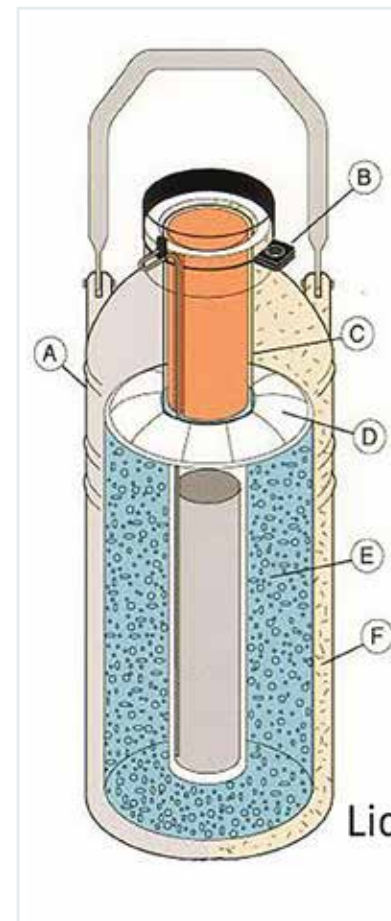

Liquid Nitrogen Dry Shipper
A. Outer vessel
B. Lockable cover
C. Neck tube
D. Chemical vacuum retention
E. Absorbent
F. Insulation

I strongly recommend if you are purchasing semen from another producer and are transferring semen from their tank to yours you follow these safe practices from beginning to end. Each time a tank is opened, a canister raised and a straw handled the semen has a risk of being compromised. This could very well damage your conception results.

Next is the problem of private producers shipping semen. This is called a dry shipper and is generally sent by UPS. These have a super absorbent material inside. These have to be “charged” with liquid nitrogen and are supposed to be able to hold a -150 F temperature for 14 days. I never plan on 14 days!!! Once again, the same semen transfer rules apply from storage to shipper. But for shipping please make sure you get the tank charged properly and sent in a very timely manner. I have been on a breeder’s farm when we opened the tank and there was NO vapor and it was dry and all semen ruined. When you receive a shipper your best bet is to just leave it in a cool place until your ai time is close. If it will be a few days, open the shipper, check for vapor and if you have a place you can get nitrogen you can go fill it. The semen shipping companies usually send a 3 day call tag. You just follow the directions to close and lock the tank and set it back where UPS can pick it up.

I hope I have helped with some understanding of the semen tank. I highly recommend finding a storage facility if you have large amounts of units to be stored. When

needed you make a call and they ship semen for you and take care of the professional work. They can then transfer semen UNDER liquid nitrogen and reduce the percentage of lost viability. I have used the same facility for 25 years and my loss has been so minimal I recommend this to all of my clients.





SERIOUS NUTRITION

When it comes to building world-class herds, Record Rack® super premium deer feeds are changing the game. With our exclusive nutrition innovations, we've developed formulations to help your herd achieve record-breaking results. Unmatched scores and superior herd development are now attainable with our state-of-the-art feed management program. From the moment they are born, to the champion they are born to be, given them the proven performance you can only get from Record Rack® feed.

- Fawn Starter
- Fawn Milk Replacer
- Breeder 18% Textured
- Elite Breeder 20:4
- Elite Breeder 16:4
- Elite Breeder 16:8
- Breeder HF 20:6
- BC Elite Treats



For More Information Contact:
Kip Childers 256.303.3382



SEMEN AVAILABLE INCEPTION

NADR# 296320 BRAIN FREEZE ♦ EXPRESS ♦ 329

3 YRS



GEBV/GS - 0.131

2 YRS

THE
ANTLER
COMPANY

ALABAMA SEMEN RIGHTS

RW
ROYAL WHITETAILS
Blountsville • AL

ALABAMA SEMEN RIGHTS

San Jose
RANCH
FREETEXAS

PARTNER

MR
Mossy Rock WTS & Exotics
Cross Plains, Texas

PARTNER



LIMITLESS
GENETICS

LIMITLESSGENETICS.COM

JESSE BOGER • 281-330-9519
JESSE@LIMITLESSGENETICS.COM

**LIGHTER WEIGHT.
MORE EFFECTIVE.
MINIMAL TRAUMA.**

**IF YOU HAVEN'T TRIED PNEU-DART'S RDDS,
YOU'RE MISSING MORE THAN YOUR TARGET**

Did you know impact trauma can negatively influence medical treatment? We do. Which is why we've spent 50+ years perfecting the ideal remote delivery device. Shorter in length and lightest on the market, our disposable RDDS provide ultimate accuracy while reducing the potential for problematic hematomas.

Don't miss your target. Hit it with Pneu-Dart.

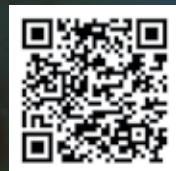

PNEU-DART INC

PneuDart.com > 866.299.DART



WANTED

SUDDEN EXPRESS / TRIPLE EX / TRIPLE CROWN / MISS KITTY

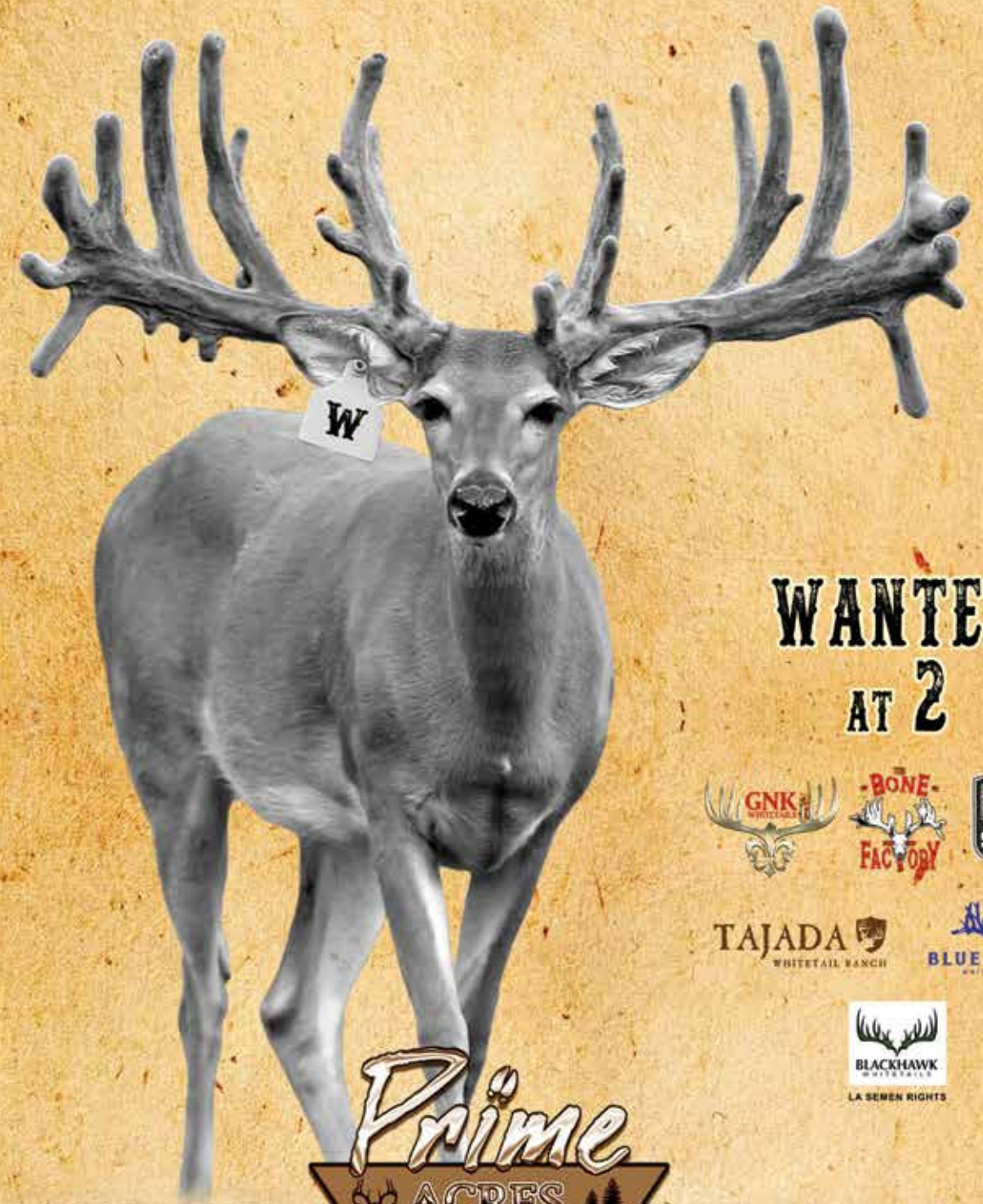

**WANTED
AT 2**



**Prime
ACRES**

WHERE LEGENDS ARE GROWN
BRAD HASSIG | 970-260-8656

WELCOME TO THE NEW AGE

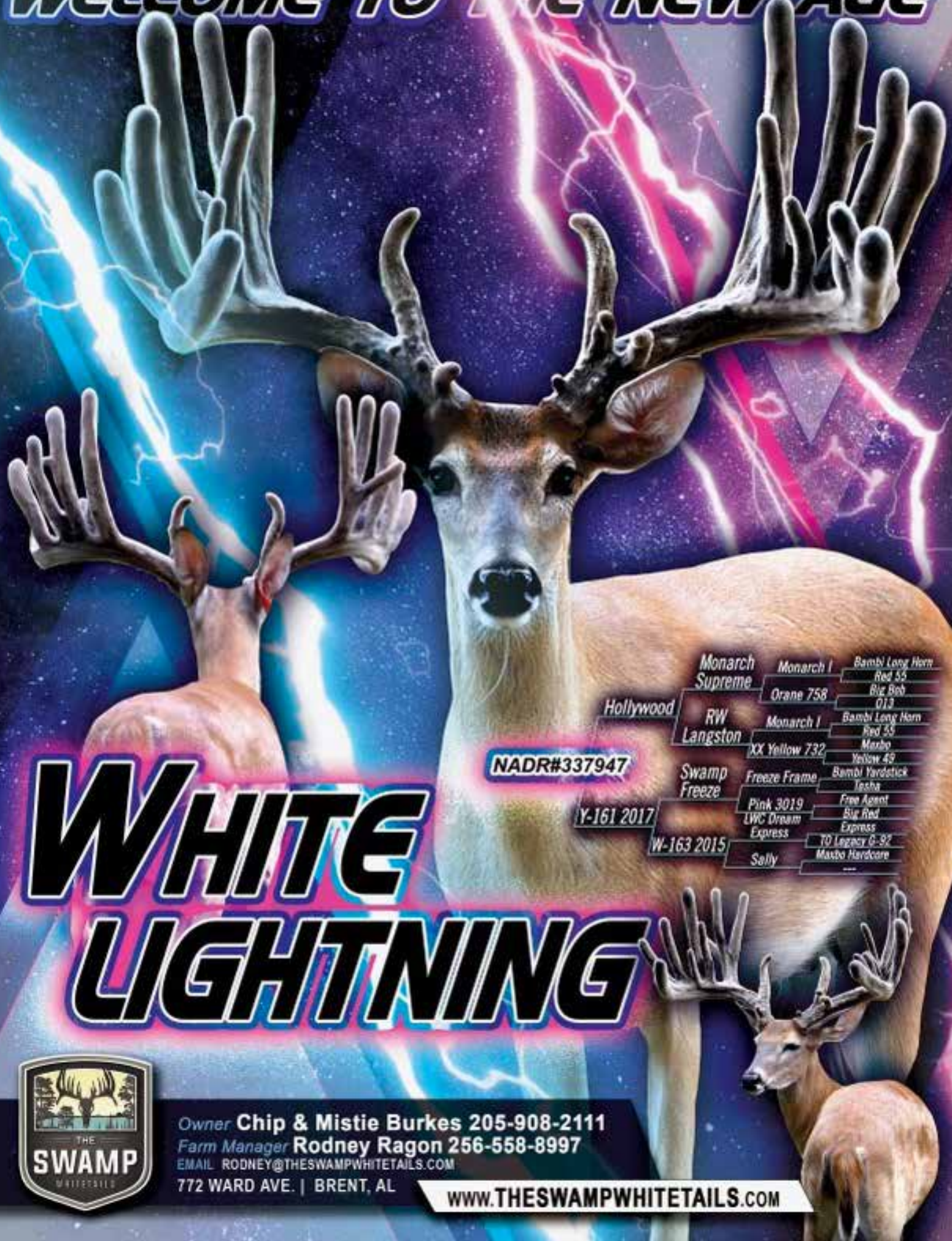

NADR#337947

WHITE LIGHTNING

- | | | |
|-----------------|-------------------|------------------------|
| Monarch Supreme | Monarch I | Bambi Long Horn Red 55 |
| Hollywood | Orane 758 | Biz Bob 013 |
| RW Langston | Monarch I | Bambi Long Horn Red 55 |
| Swamp Freeze | XX Yellow 732 | Merbo Yellow 49 |
| Y-161 2017 | Freeze Frame | Bambi Yardsick Tesha |
| W-163 2015 | Pink 3019 | Free Agent |
| | LWC Dream Express | Big Red Express |
| | Sally | TO Legacy 0-92 |
| | | Maxto Hardcore |



Owner **Chip & Mistie Burkes 205-908-2111**
 Farm Manager **Rodney Ragon 256-558-8997**
 EMAIL RODNEY@THESWAMPWHITETAILS.COM
 772 WARD AVE. | BRENT, AL

WWW.THESWAMPWHITETAILS.COM