

MELISSA DAVIS

ART DEPARTMENT PORTFOLIO 2024

MELISSA DAVIS – CV



CONTACT ME



+44 7779571257



meli.sarah.davis@gmail.com



Based in London and Essex

REFERENCES

Caroline Amies – Production Designer
productiondesign@nfts.co.uk
+447973411379

Paul Ghirardani – Supervising Art Director
paulghirardani@me.com
+447713074702

CONNECT

WEBSITE - ONLINE PORTFOLIO AND CV –
www.melissadavisartdepartment.co.uk

INSTAGRAM –
[@melissadavisdesign](https://www.instagram.com/melissadavisdesign)

LINKEDIN -
Melissa Davis

INTERESTS

- Making people laugh
- Gaming
- Ships and Boat architecture
- Singing, dancing and acting
- Film and TV
- Spending time with my Miniature Schnauzer



I have a full, clean UK driving license and
I have my own car

Employment History

- Art Department Assistant – ‘28 YEARS LATER – THE BONE TEMPLE’ – June 2024 – October 2024 (CURRENT)
Under **Production Designers, Gareth Pugh and Carson McColl** and **Supervising Art Director, Paul Ghirardani**
Directed by Nia DaCosta
- Art Department Assistant – ‘28 YEARS LATER’ – February 2024 - June 2024
Under **Production Designers, Gareth Pugh and Carson McColl** and **Supervising Art Director, Paul Ghirardani**
Directed by Danny Boyle
- Art Department Assistant – 2-Week Work Experience Placement
Under **Production Designer, Kevin Jenkins** and **Supervising Art Director, James Lewis** Disney Star Wars Television Show, ‘Acolyte’ - 2022

Education

- MA in Production Design at **The National Film and Television School** – (2022-24)
- BA (Hons) Film Production Degree and Hand Drafting at *San Diego State University, CA, USA* (2019-2020)
Under the tutelage of *Jiarui Bai and David Morong*, Senior Lecturers of Production Design at the
American Film Institute Conservatory. Graduating grade – 3.94/ 4 GPA
- BA (Hons) Comparative Literature and Film degree at the *University of Kent* (2017-2021). Graduating grade – First

Skills - Practical

- Hand Drafting
- Computer Drafting
- Set Construction, i.e. painting, lining, plastering
- Wood Graining and Aging Techniques
- White Card Model Making
- Managing budget
- Colour Model Making
- Prop Making
- Prop Sourcing
- Set Dressing
- Graphic Design

- Emotional intelligence ☺
- I make great tea and coffee!
- I really enjoy teamwork
- Energy boosting!
- Radiating positivity
- Eager to learn!

Skills - Software

- AutoCAD 2023 Drafting
- 3D Sketchup Modelling
- Microsoft Office 365 – Word, Excel, PowerPoint, Outlook etc.
- Rhino 8 3D – Basic Level
- Procreate
- Adobe – Photoshop, InDesign, Acrobat etc.
- Unreal Engine
- Midjourney, ChatGPT and other AI softwares
- Zoom, Teams, and other video chat software

Thank you very much for your consideration!

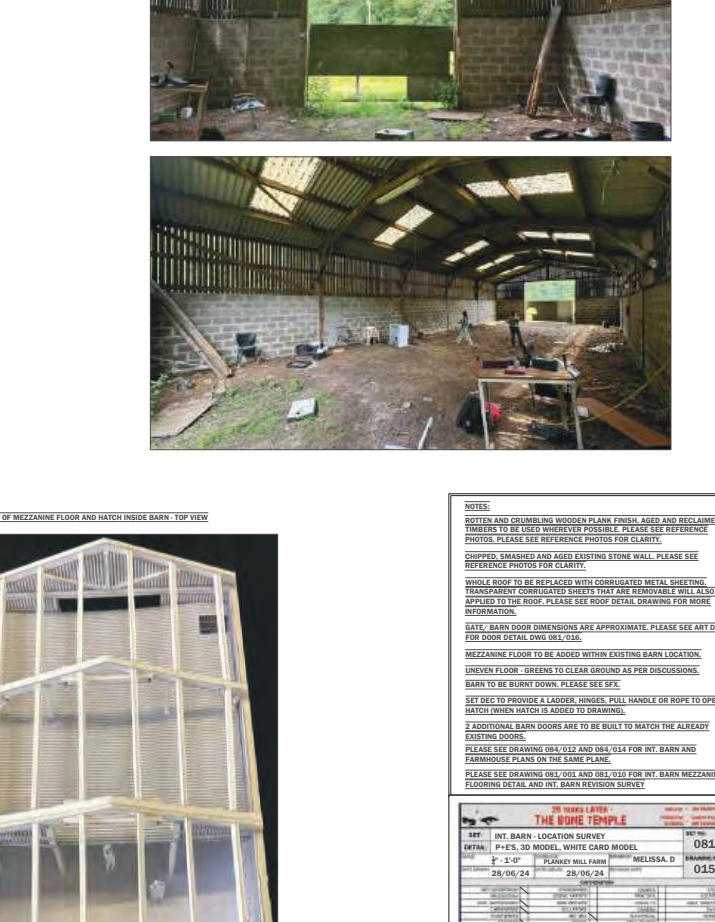
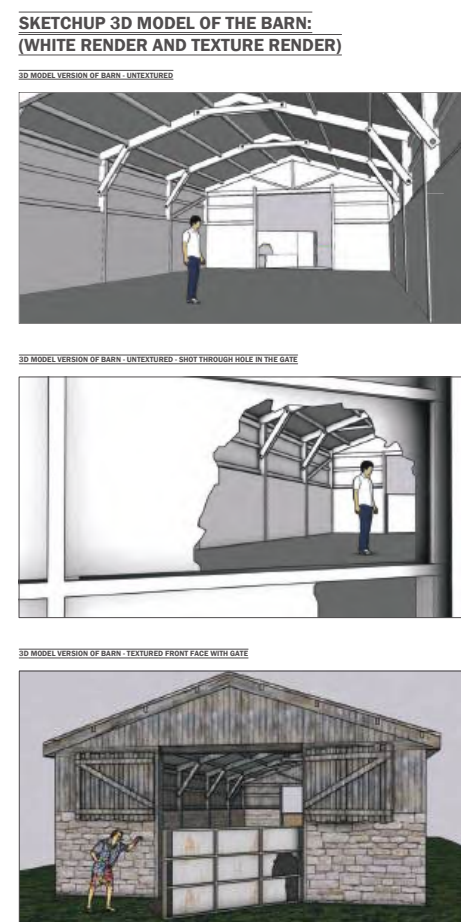
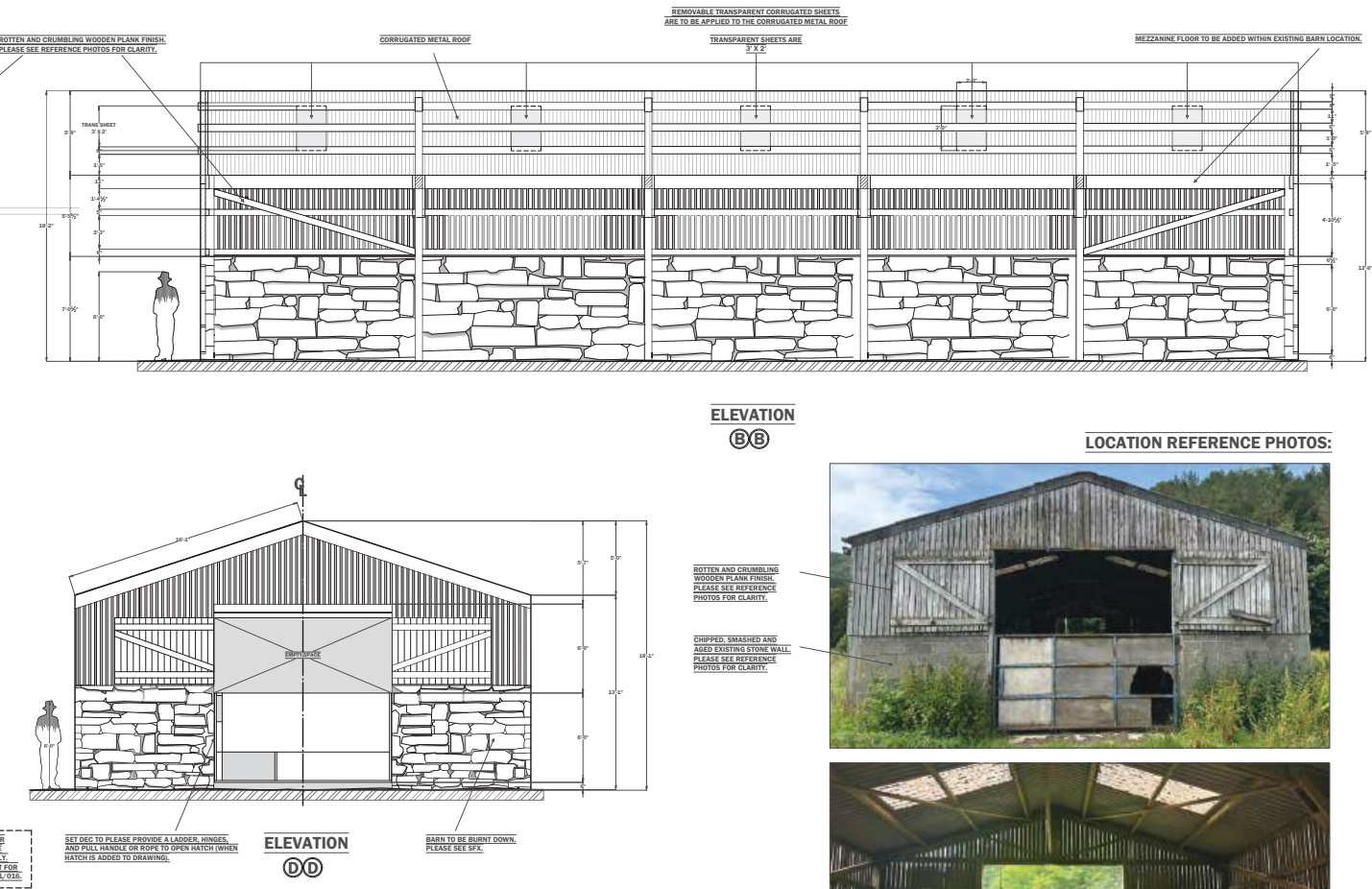
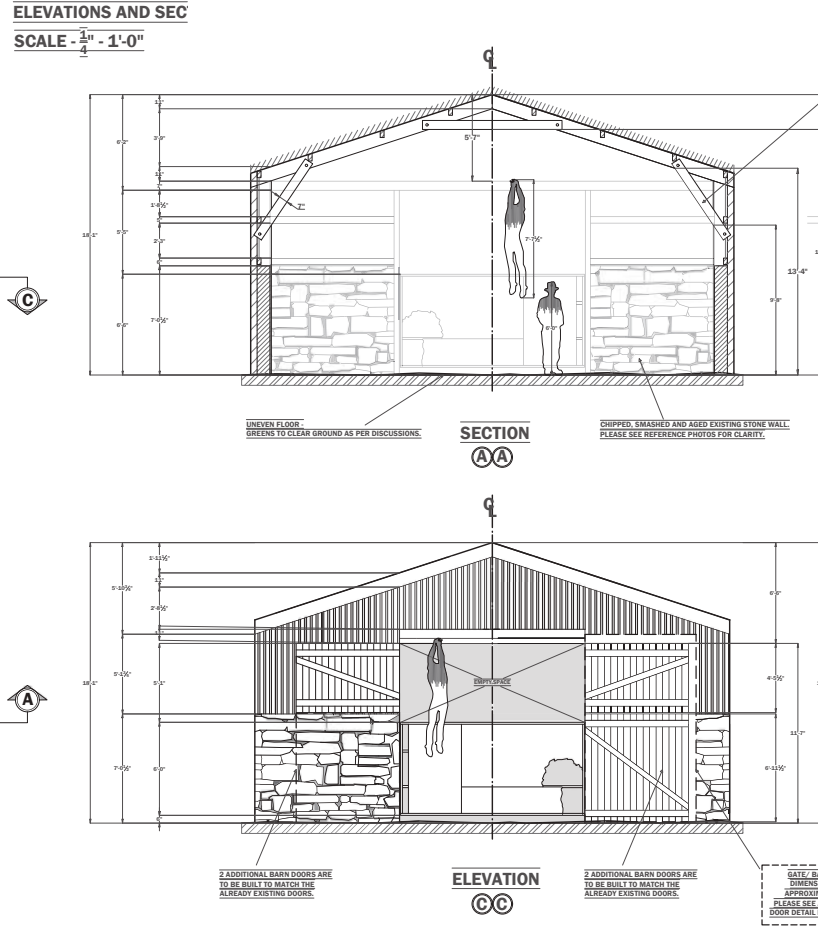
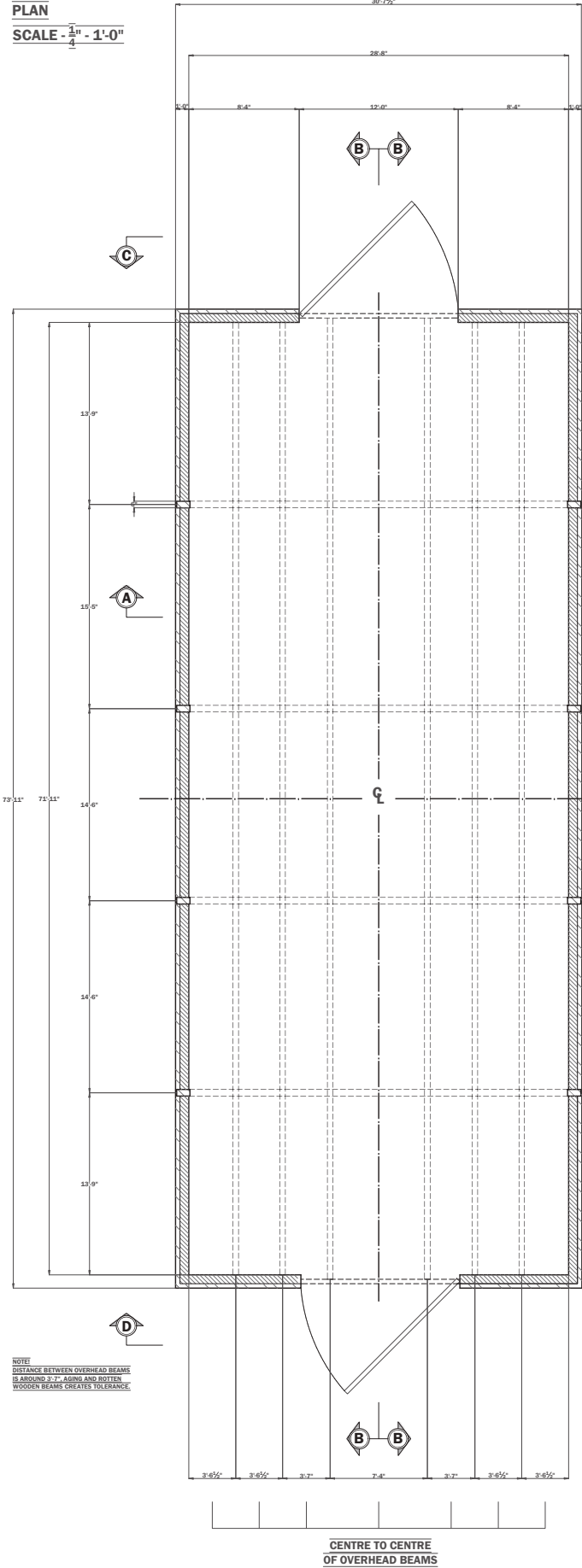

NOTES:

- ROTTEN AND CRUMBLING WOODEN PLANK FINISH, AGED AND RECLAIMED THUSERS TO BE USED WHEREVER POSSIBLE. PLEASE SEE REFERENCE PHOTOS. PLEASE SEE REFERENCE PHOTOS FOR CLARITY.
- CHIPPED, SMASHED AND AGED EXISTING STONE WALL. PLEASE SEE REFERENCE PHOTOS FOR CLARITY.
- WHOLE ROOF TO BE REPLACED WITH CORRUGATED METAL SHEETS. TRANSPARENT CORRUGATED SHEETS THAT ARE REMOVABLE WILL NEED TO BE APPLIED TO THE ROOF. PLEASE SEE ROOF DETAIL DRAWING FOR MORE INFORMATION.
- 60% BARN DOOR DIMENSIONS ARE APPROXIMATE. PLEASE SEE ART COPY FOR DOOR DETAIL DWG 081/015.
- MEZZANINE FLOOR TO BE ADDED WITHIN EXISTING BARN LOCATION.
- UNEVEN FLOOR. GREENS TO CLEAR GROUND AS PER DISCUSSIONS.
- BARN TO BE BURNT DOWN. PLEASE SEE SPX.
- SET DEC TO PROVIDE A LADDER, HINGES, PULL HANDLE OR ROPE TO OPEN HATCH (WHEN HATCH IS ADDED TO DRAWING).
- 3 ADDITIONAL BARN DOORS ARE TO BE BUILT TO MATCH THE ALREADY EXISTING DOORS.
- PLEASE SEE DRAWING 081/012 AND 081/014 FOR INT. BARN AND FARMHOUSE PLANS FOR THE SAME PLANS.
- PLEASE SEE DRAWING 081/001 AND 081/013 FOR INT. BARN MEZZANINE FLOORING DETAIL AND INT. BARN REVISION SURVEY.

28 YEARS LATER - THE BONE TEMPLE			
REF.	INT. BARN - LOCATION SURVEY	DATE	081
DETAIL	P+E'S, 3D MODEL, WHITE CARD MODEL		
SCALE	1/4" = 1'-0"	CLIENT	HILL FARM
DATE	28/06/24	DESIGNER	MELISSA D
		DATE	28/06/24
		NO.	015

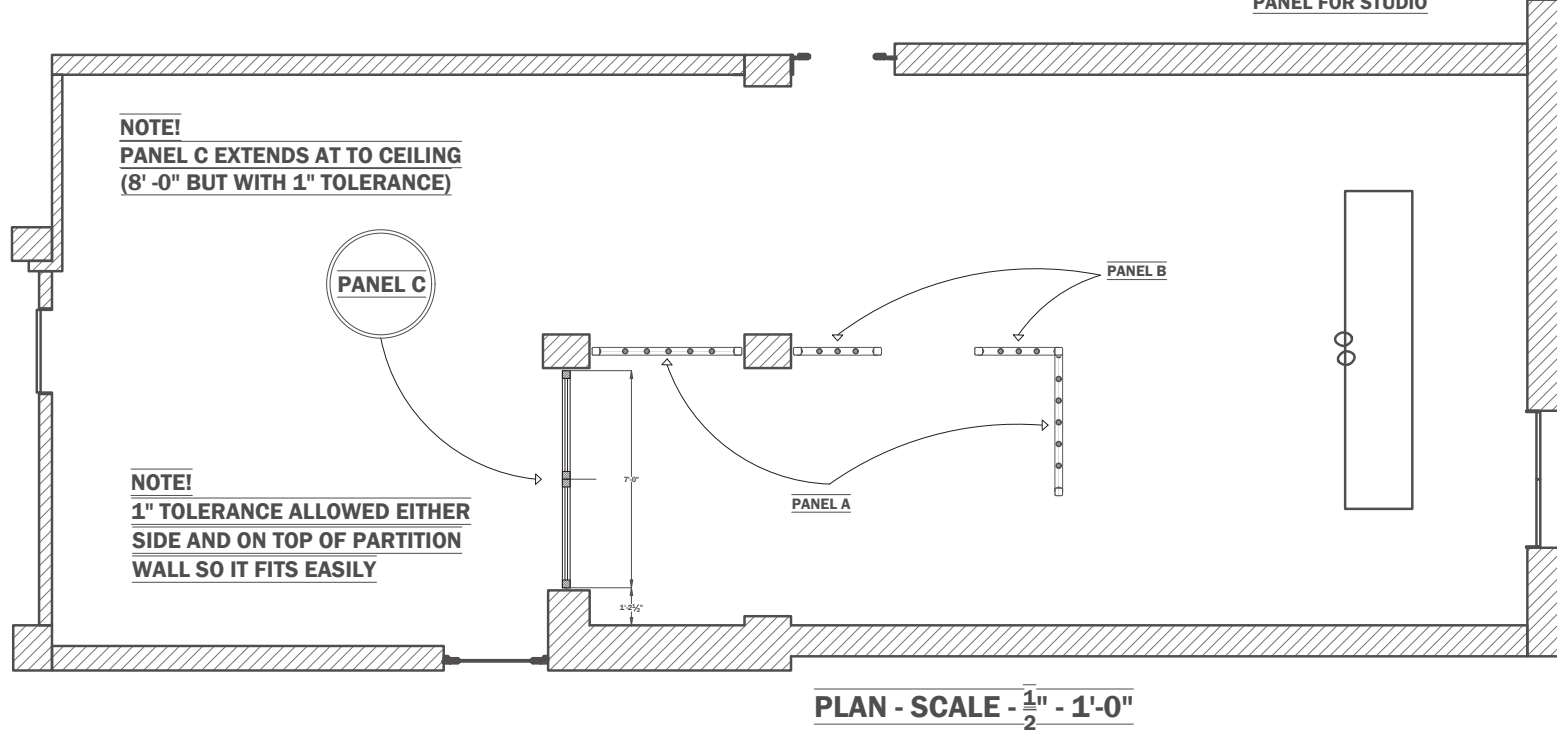
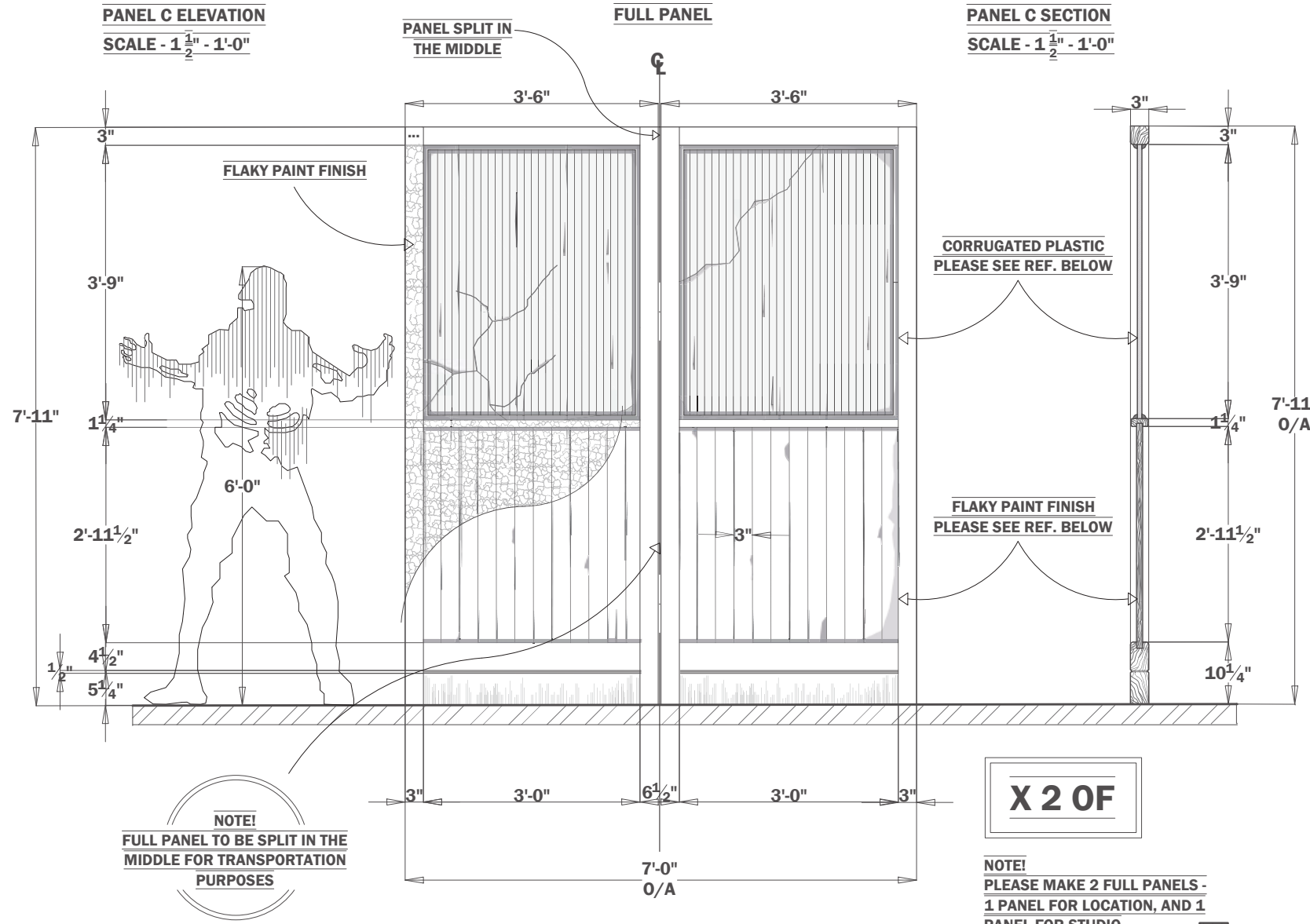

PHOTOS OF FINISHED PANEL ON SET



FULL SIZE DETAIL

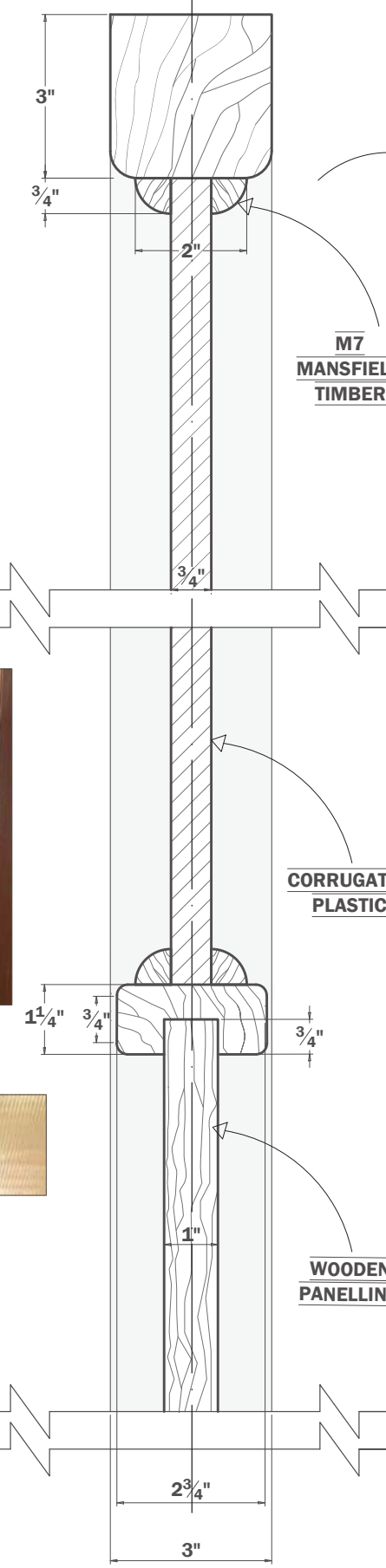

FULL SIZE DETAIL CONT.

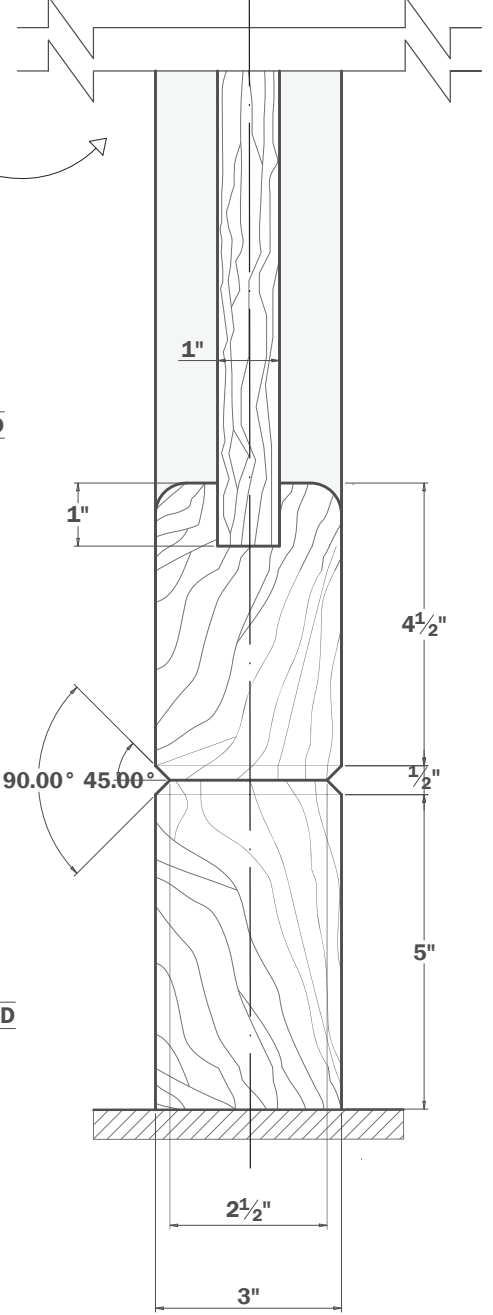

REFERENCE IMAGES

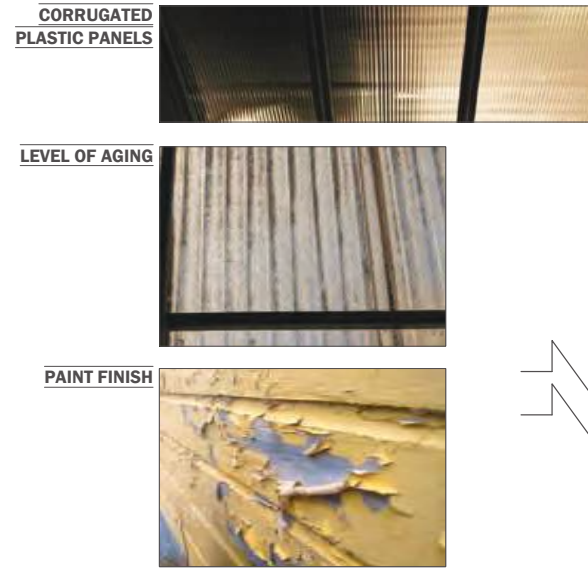

NOTES:

1" TOLERANCE ALLOWED EITHER SIDE AND ON TOP OF PARTITION WALL SO IT FITS EASILY

PLEASE MAKE 2 FULL PANELS - 1 PANEL FOR LOCATION, AND 1 PANEL FOR STUDIO

FULL PANEL TO BE SPLIT IN THE MIDDLE FOR TRANSPORTATION PURPOSES

FINISH: CORRUGATED PLASTIC AND PAINTED WOOD, COLOUR T.B.C. HEAVILY AGED / DIRTY / PEELING PAINT. AGED PAINT FINISH TO BE MATCHED TO OTHER PANEL PAINT FINISH AS PER DRAWING 049/006. SEE FINISH REF IMAGE.

PLEASE SEE DRAWING 049/001 FOR FULL SET DRAWINGS - PLAN AND ELEVATIONS

PLEASE SEE DRAWING 049/004 FOR OTHER PARTITION WALL DRAWING - PLAN, ELEVATIONS, SECTIONS AND DETAIL

28 YEARS LATER		DATE: 28/05/24	SCALE: 1/2" = 1'-0"
INT. HAPPY EATER DINER		PROJECT NO: 049	DWG NO: 006
LARGE PARTITION WALL - PLAN, ELEVATION, SECTION DETAIL		DESIGNER: MELISSA D	DRAWN BY: MELISSA D
HAPPY EATER		DATE: 28/05/24	SCALE: 1/2" = 1'-0"

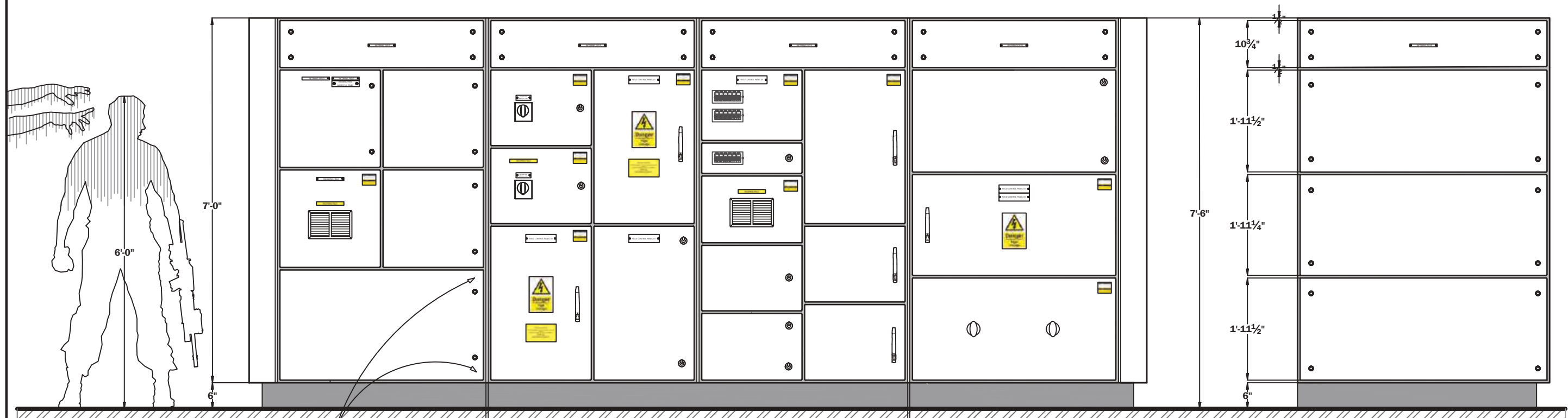

NOTE! -
FILLET RADIUS = $\frac{3}{16}$ "
ON EVERY CORNER

ELEVATION
(A) (A)

NOTE! -
ELEVATION B AND C ARE MIRRORED.
DIMENSIONS ARE IDENTICAL

ELEVATION
(B) (B)

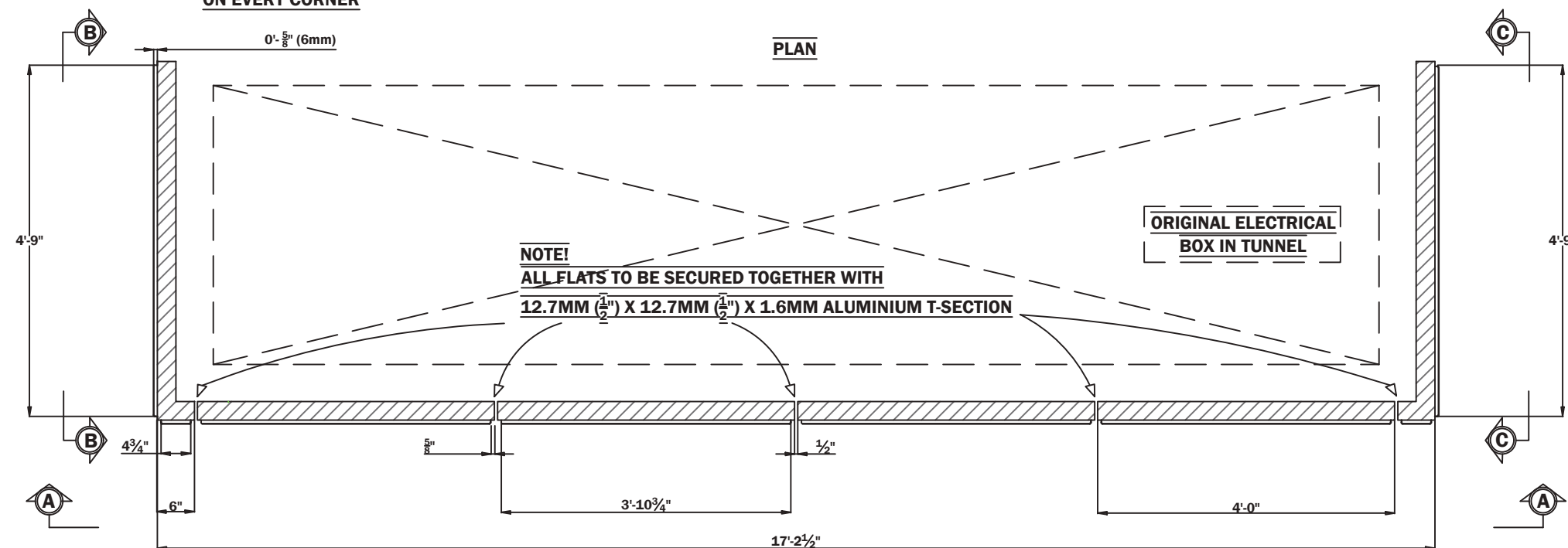

ORIGINAL ELECTRICAL
 BOX IN TUNNEL

NOTE!
ALL FLATS TO BE SECURED TOGETHER WITH
12.7MM ($\frac{1}{2}$ ") X 12.7MM ($\frac{1}{2}$ ") X 1.6MM ALUMINIUM T-SECTION

IN PROGRESS PHOTOS - ELECTRICAL BOX



AS AN ART DEPARTMENT ASSISTANT ON '28 YEARS LATER', I WAS IN CHARGE OF DESIGNING, DRAWING AND CREATING AN ELECTRICAL BOX COVER, TO SIT INSIDE THE KIELDER DAM TUNNEL. I SOURCED ALL THE ELECTRICAL PROP ELEMENTS AND DRESSED/FIXED THE DECOR TO THE BOX MYSELF.

I WORKED CLOSELY WITH CONSTRUCTION, SET DEC, AND OUR SCENIC PAINTERS IN ORDER TO REALISE AND AGE THE ELECTRICAL BOX DOWN AS IF IT HADN'T WORKED OR BEEN USED FOR 28 YEARS.

I FELT VERY LUCKY TO BE TRUSTED WITH THE PRODUCTION OF THIS SET PIECE. THIS WAS SUCH A WONDERFUL SOLO PROJECT TO COMPLETE, AND I LEARNT AN INCREDIBLE AMOUNT FROM TALKING TO ALL THE DIFFERENT DEPARTMENTS INVOLVED.

FINISHED ELECTRICAL BOX ON LOCATION



ELEVATION
(C) (C)

NOTES:
 AN ORIGINAL ELECTRICAL BOX ALREADY PRESENT ON LOCATION WILL SIT INSIDE THE NEW ELECTRICAL BOX. PLACEMENT OF ORIGINAL ELECTRICAL BOX IS INDICATED ON THE PLAN.
 PLEASE ALLOW 6" TOLERANCE AROUND THE EDGE OF THE ORIGINAL ELECTRICAL BOX TO PREVENT DAMAGE.
 ELEVATION B AND C ARE MIRRORED, DIMENSIONS ARE IDENTICAL.
 FILLET RADIUS - $\frac{3}{16}$ " - THE SAME FILLET RADIUS APPEARS ON EVERY CORNER OF THE FABRICATED PANELS ON THE BOX FRONT AND TOPS.
 ALL FLATS TO BE SECURED TOGETHER WITH ALUMINIUM T-SECTIONS - 12.7MM ($\frac{1}{2}$ ") X 12.7MM ($\frac{1}{2}$ ") X 1.6MM

28 YEARS LATER	
INT. DAM TUNNEL	046
DETAIL - ELECTRICAL BOX COVER	MELISSA D
1/2" = 1'-0"	001
30/04/24	

RIGHT:
Research Images

National Film and Television School Project
'Film Architecture'
INT. AND EXT. The Chief's Farm
Russia 1425

Paper Project Brief –

Design a period set from a book.
The book I chose was *'The Bear and the Nightingale'*
written by Kathrine Arden.

The story is set in medieval Russia, on the outskirts of rural Moscow,
and incorporates elements of Russian folklore.

Vasya Petrovna is a young girl who can communicate with
demons, sprites and mythological creatures, at a time when
Orthodox Christianity is attempting to stamp out all belief in such
beings.



RIGHT:
Core Research Image

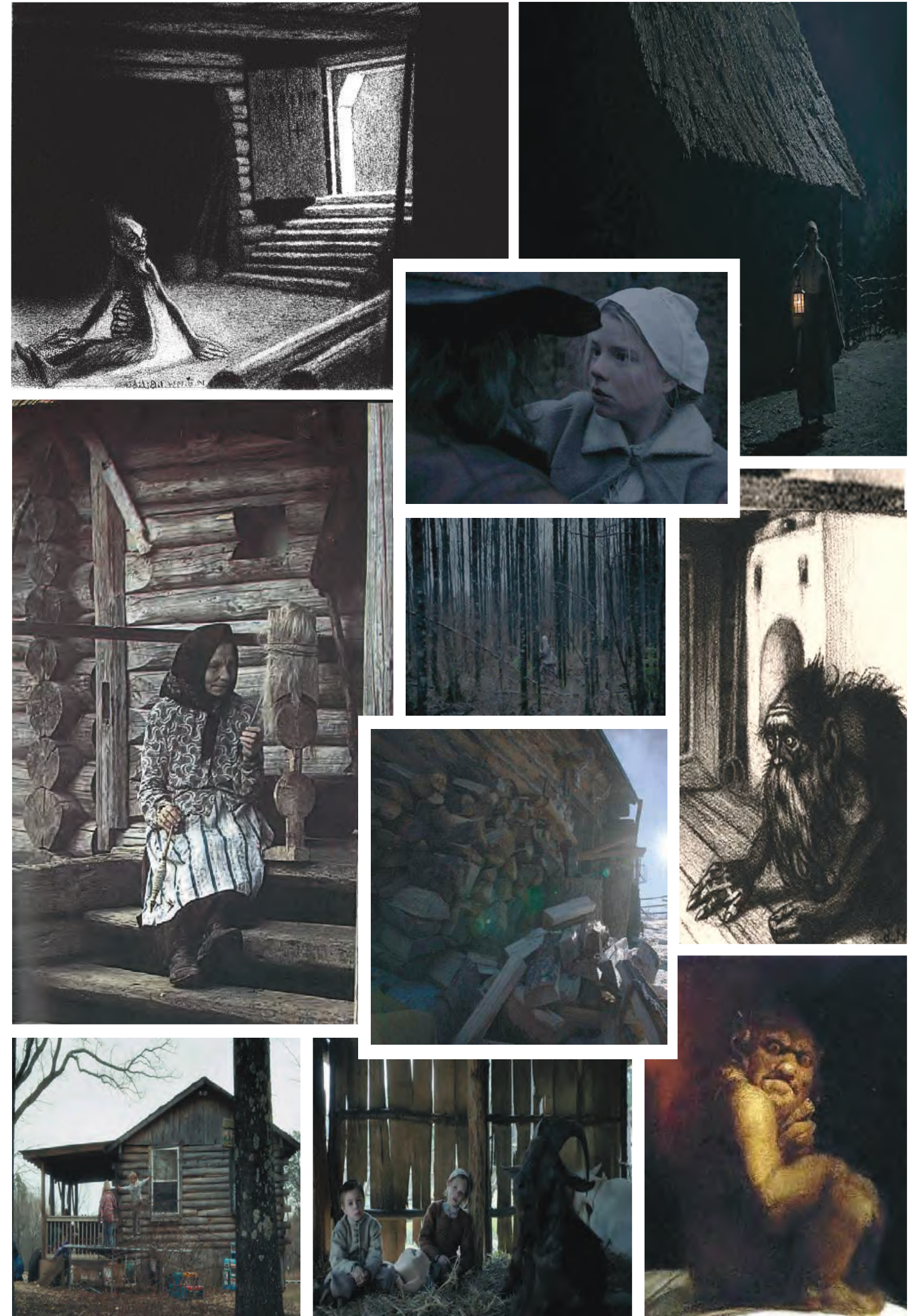

'Film Architecture' – Concept Art



ABOVE: Concept of the Izba and farm set design, completed on Photoshop and Procreate

'FILM ARCHITECTURE' - INT. & EXT. "THE CHIEFS' HOUSE AND FARM" - SCALE 1/4" = 1'-0"

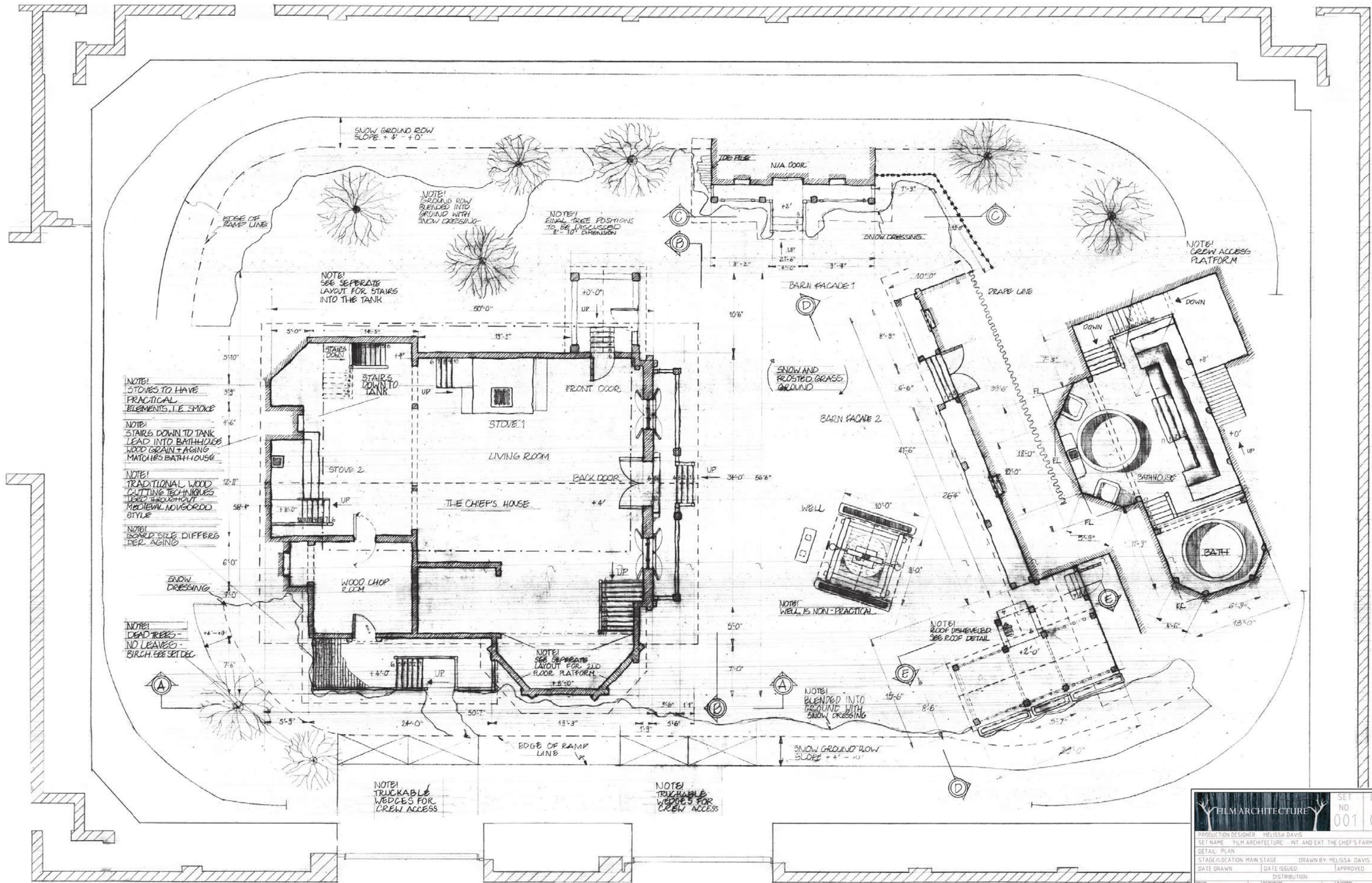

		SET NO 001	DRWG NO 001
PRODUCTION DESIGNER: MELISSA DAVIS SET NAME: 'FILM ARCHITECTURE' - INT. AND EXT. 'THE CHIEF'S FARM' DETAIL: PLAN STAGE/LOCATION: MAIN STAGE DATE DRAWN: _____ DATE ISSUED: _____ DRAWN BY: MELISSA DAVIS APPROVED: _____			
DISTRIBUTION:			
ARCHITECT MELISSA DAVIS	SET DESIGNER MELISSA DAVIS	PRODUCTION DESIGNER MELISSA DAVIS	ART DIRECTOR MELISSA DAVIS

FILM ARCHITECTURE - EXT. THE CHIEF'S HOUSE # FARM - ELEVATIONS - SCALE 1/4" = 1'-0"



		SET NO 001	DRWG NO 002
PRODUCTION DESIGNER: MELISSA DAVIS SET NAME: "FILM ARCHITECTURE" - INT AND EXT. THE CHIEF'S FARM DETAIL: ELEVATIONS STAGE/LOCATION: MAIN STAGE DRAWN BY: MELISSA DAVIS DATE DRAWN: _____ DATE ISSUED: _____ APPROVED: _____			
DISTRIBUTION		COMMENTS	
NAME: _____	DATE: _____	NAME: _____	DATE: _____
NAME: _____	DATE: _____	NAME: _____	DATE: _____

National Film and Television School Project
'Date with Death'
Solo Set Build

Production Designer Role –
INT. Death's Restaurant

The film has been entered into 3 BIFTA and
BAFTA qualifying festivals,
Norwich Film Festival 2023,
Bolton International Film Festival 2023
and
Aesthetica Short Film Festival 2023

'Date with Death' is a short surreal comedy film set in 'Limbo'.

Liv, depressed after losing her fiancé in a car crash, goes on a blind date on a last-ditch effort to find a lust for life. However, when she arrives at the restaurant, she finds that her date is with Death himself.



RIGHT:
Concepts of the restaurant set done on Procreate

'Date with Death' - Solo Set Build - Still From Set



ABOVE: Still of restaurant set build, with prop scythe

Research Images



ABOVE: Research Images

ELEVATIONS - SCALE - 1/2" - 1'-0"

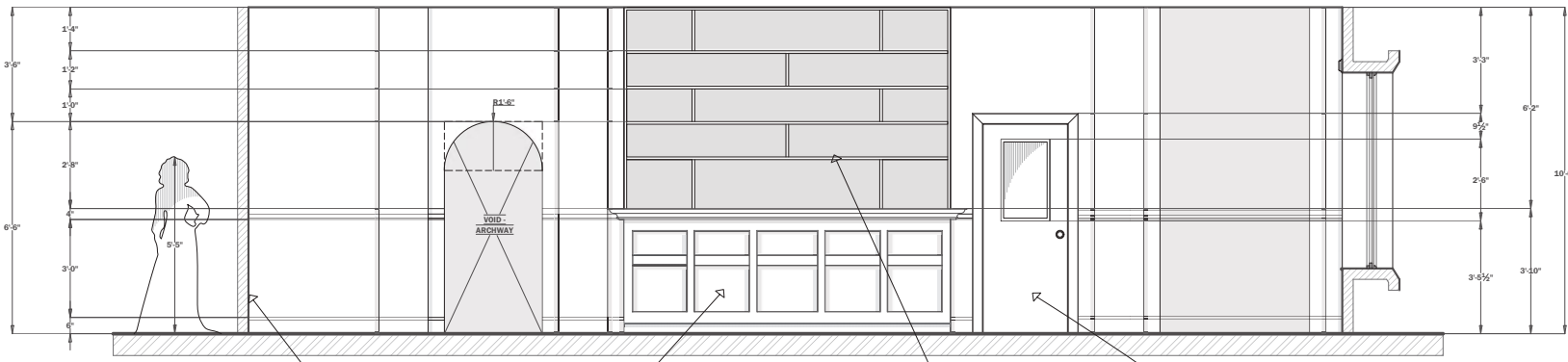

SET CUTS OFF ABRUPTLY AT ONE END TO ALLOW FOR FURTHER CONSTRUCTION OF TUNNEL EXTENSION. PLEASE SEE DRAWING 001/003.

DETAIL 1 - WOODEN BAR

ELEVATION A A

DETAIL 2 - BAR SHELVE

DETAIL 3 - STAFF DOOR

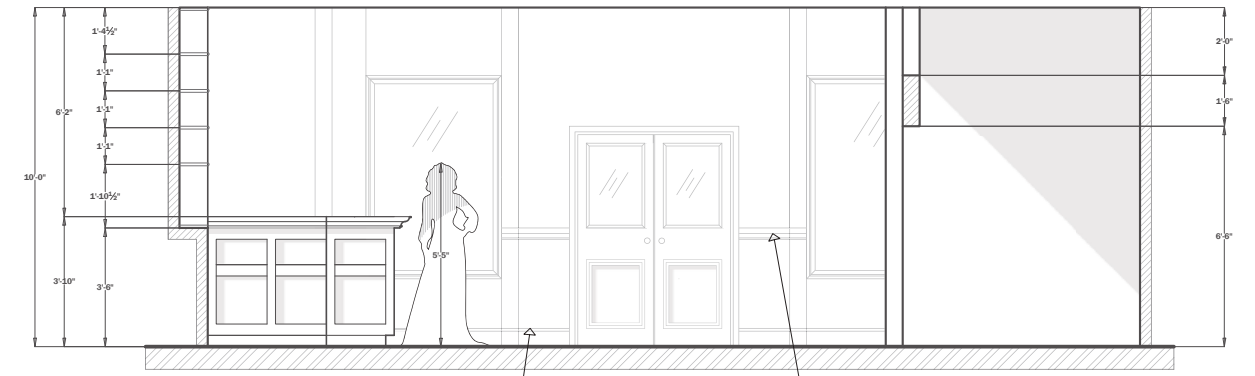

SET CUTS OFF ABRUPTLY AT ONE END TO ALLOW FOR FURTHER CONSTRUCTION OF TUNNEL EXTENSION. PLEASE SEE DRAWING 001/003.

DETAIL 4 - SKIRTING BOARD

ELEVATION B B

DETAIL 5 - CHAIR RAIL

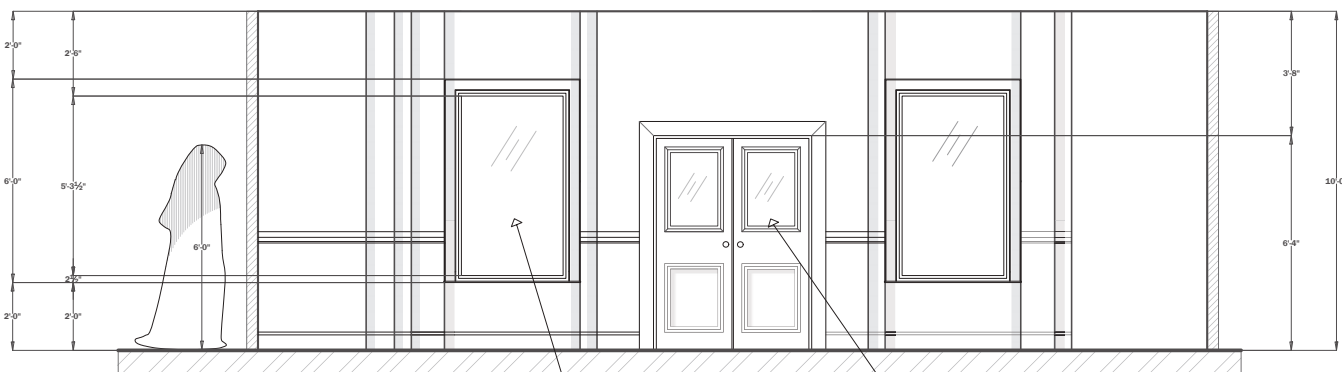

STOCKING MOULDING USED - WINDOW FRAME - M55 WINDOW SILL - M59 STILE - M67B

DETAIL 6 - WINDOWS

ELEVATION C C

DETAIL 7 - FRONT DOOR

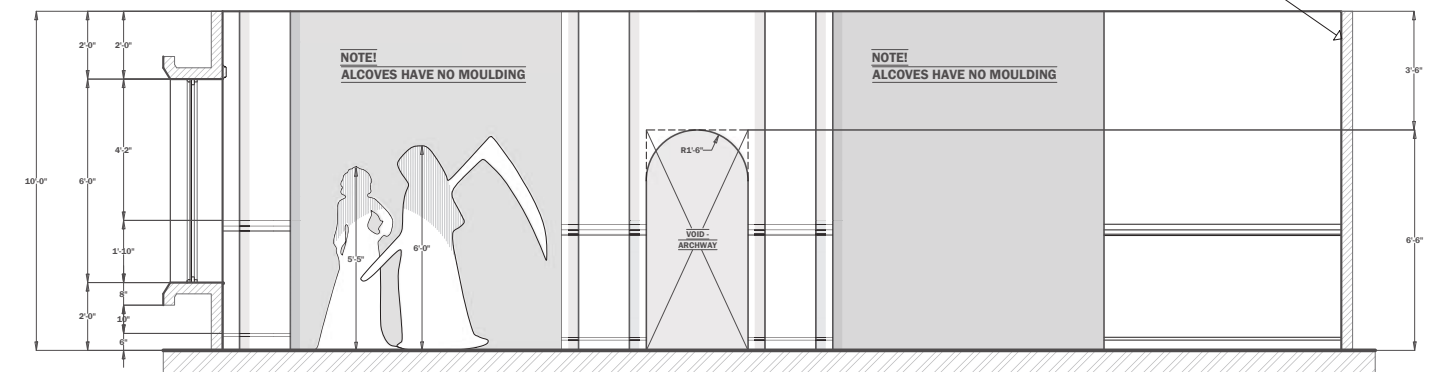

ELEVATION D D

PLAN - SCALE - 1/4" - 1'-0"

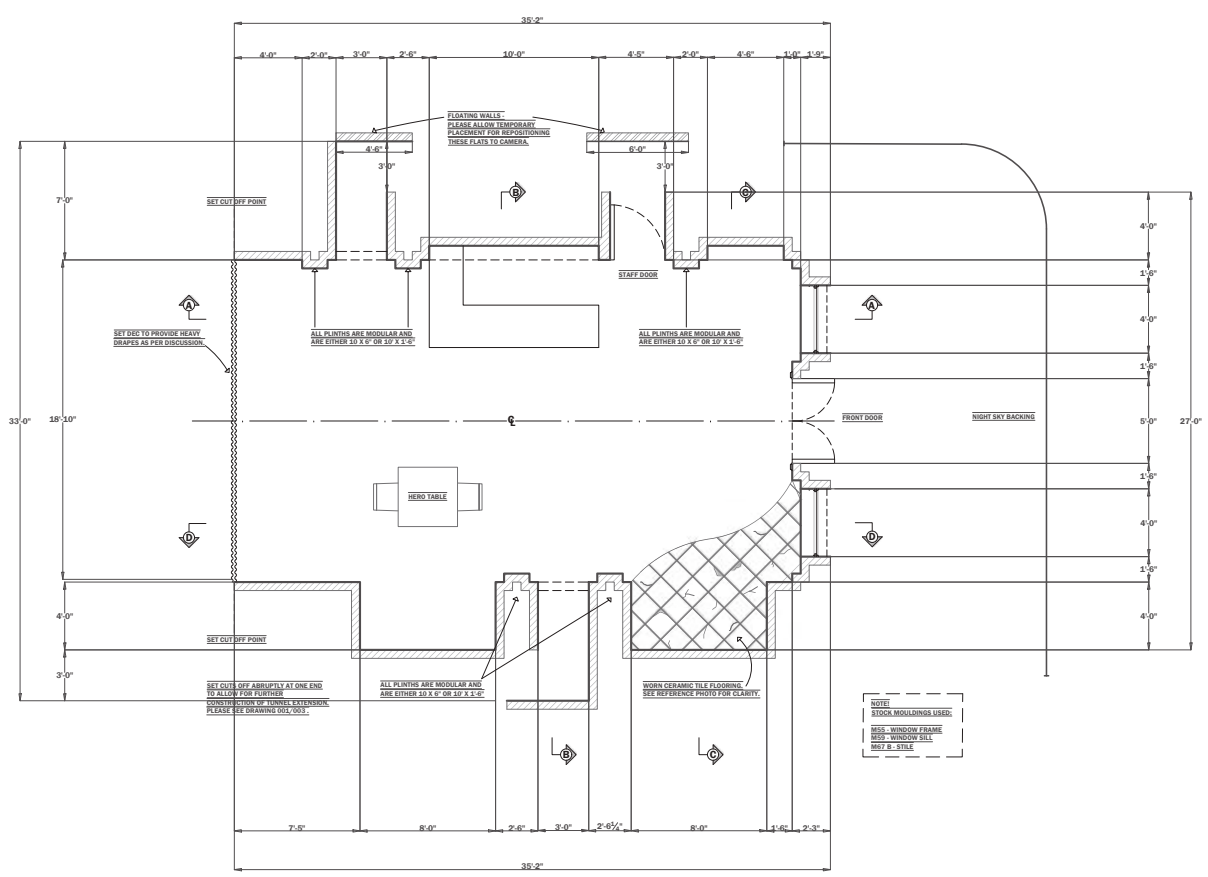

DETAIL 1 - BAR COUNTER - SCALE - 1" - 1'-0"



ELEVATION A-A



ELEVATION B-B

ELEVATION C-C

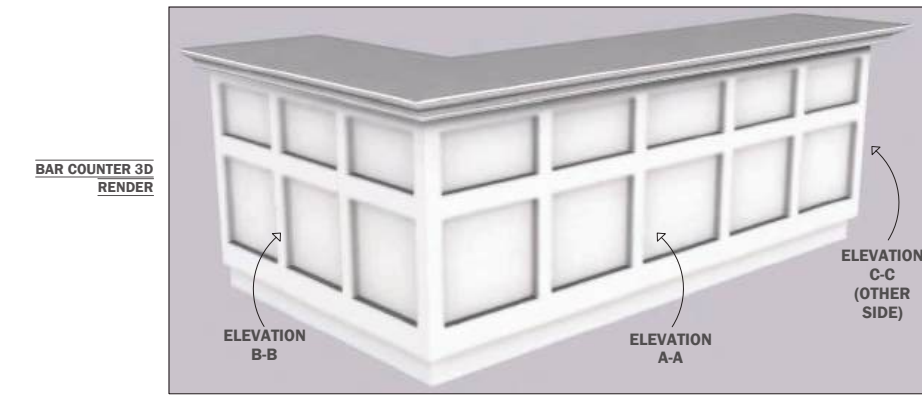

BAR COUNTER 3D RENDER

ELEVATION C-C (OTHER SIDE)

COLOURED AND TEXTURED 3D MODEL

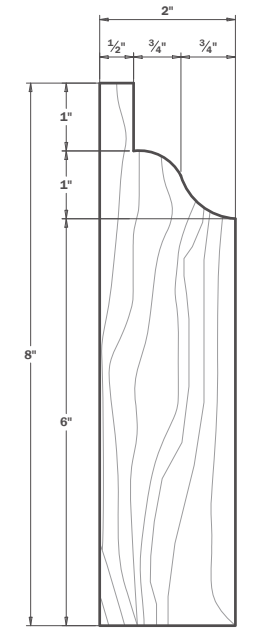

DETAIL 4 - SKIRTING BOARD - FULL SIZE

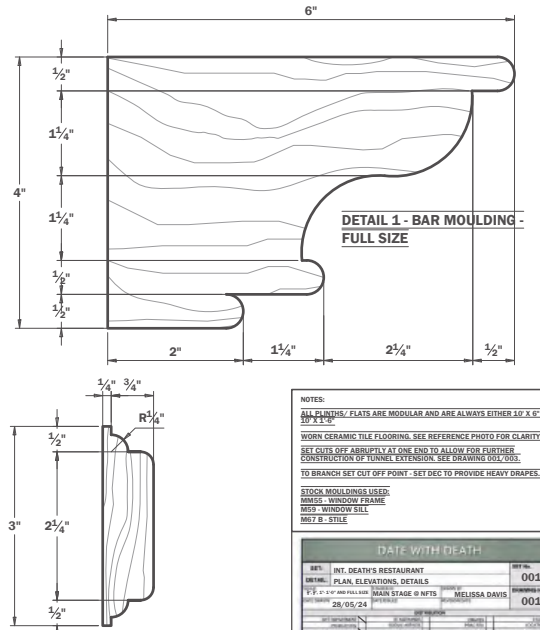

DETAIL 5 - CHAIR RAIL - FULL SIZE

NOTES:
 ALL PLINTHS, FLATS ARE MODULAR AND ARE ALWAYS EITHER 2 1/2" X 4" OR 2" X 4"
 ALL PLINTHS ARE MODULAR AND ARE ALWAYS EITHER 2 1/2" X 4" OR 2" X 4"
 WORK CERAMIC TILE FLOORING. SEE REFERENCE PHOTO FOR CLARITY.
 SET CUTS OFF ABRUPTLY AT ONE END TO ALLOW FOR FURTHER CONSTRUCTION OF TUNNEL EXTENSION. SEE DRAWING 001/003 TO BRANCH SET CUT OFF POINT - SET DEC TO PROVIDE HEAVY SHAPE.
 STOCK MOULDINGS USED:
 M55 - WINDOW FRAME
 M59 - WINDOW SILL
 M67B - STILE

DATE WITH DEATH	
REV: INT. DEATH'S RESTAURANT	001
DATE: 28/05/24	001
DESIGNED BY: MELISSA DAVIS	
DRAWN BY: MELISSA DAVIS	

'Date with Death' - Solo Set Build - Before and After Images



ABOVE : Progress photos of the set construction



ABOVE : Set photograph of the Restaurant

Sketchup 3D Model of Restaurant Set



'Date with Death' - Solo Set Build - Stills From Set



ABOVE : Set photograph of the 'Stay Alive' board game



ABOVE: Dressed and lit bar area photographs

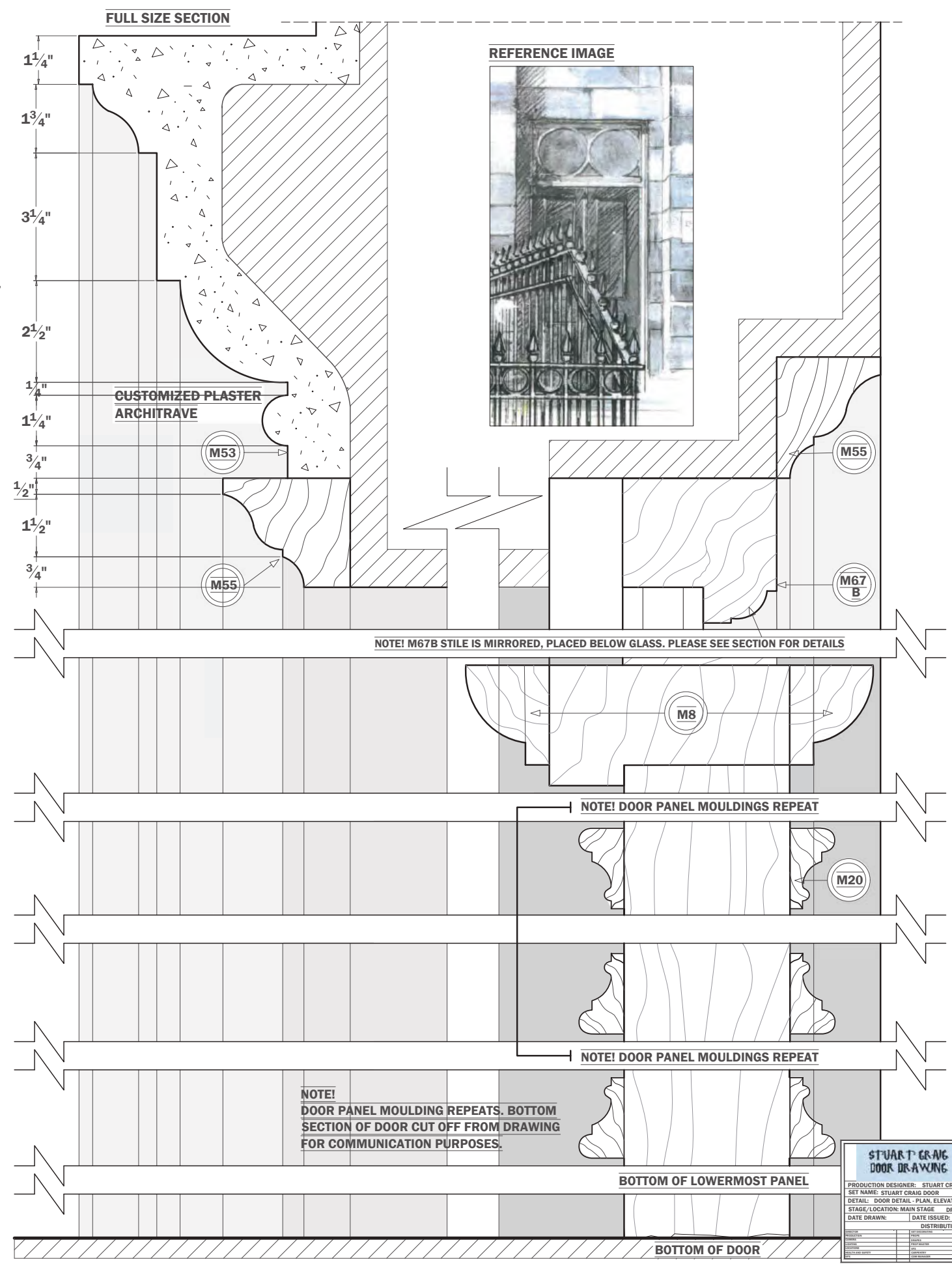
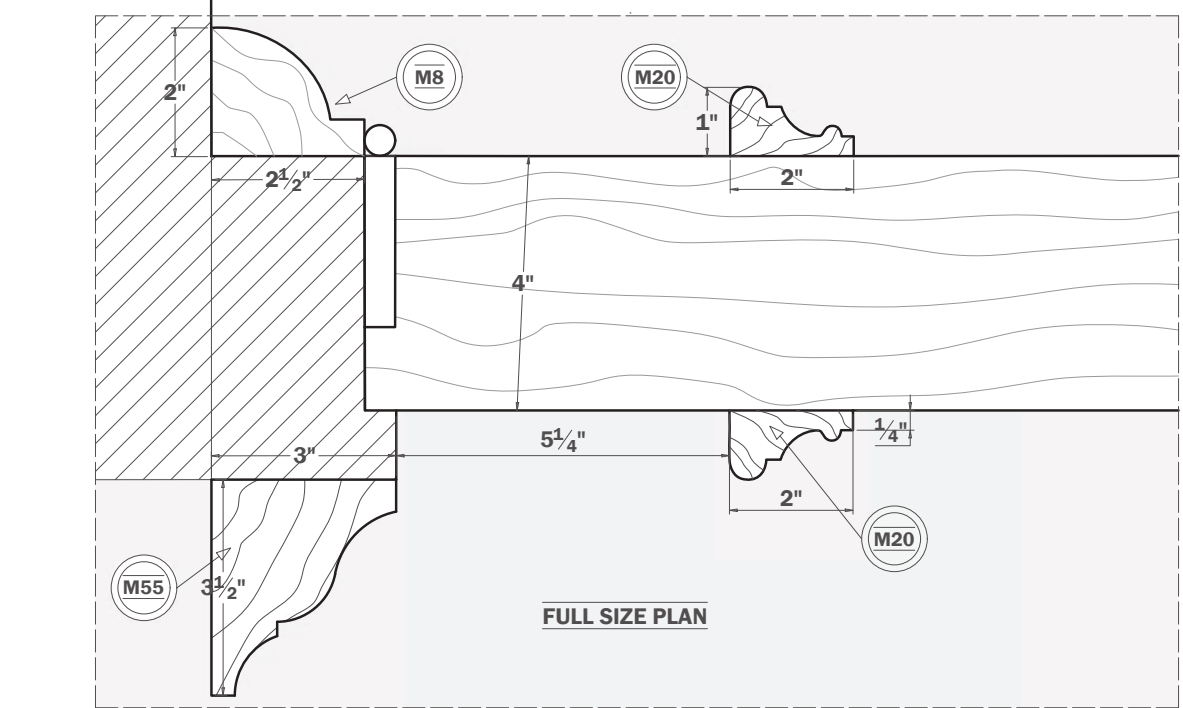
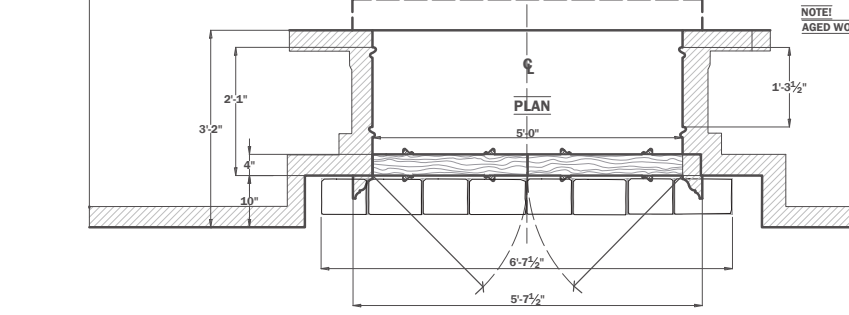
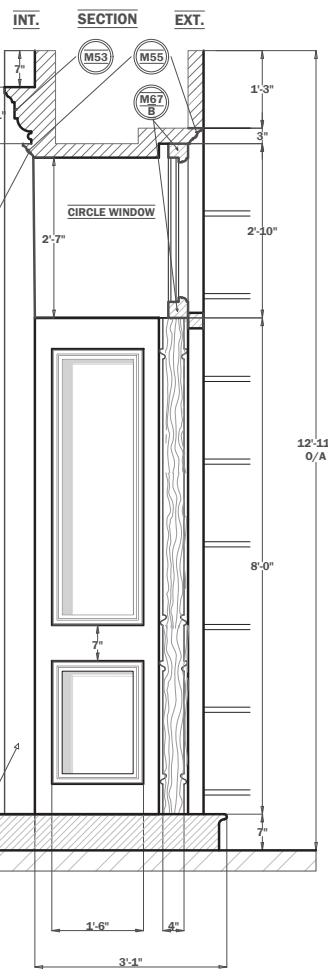
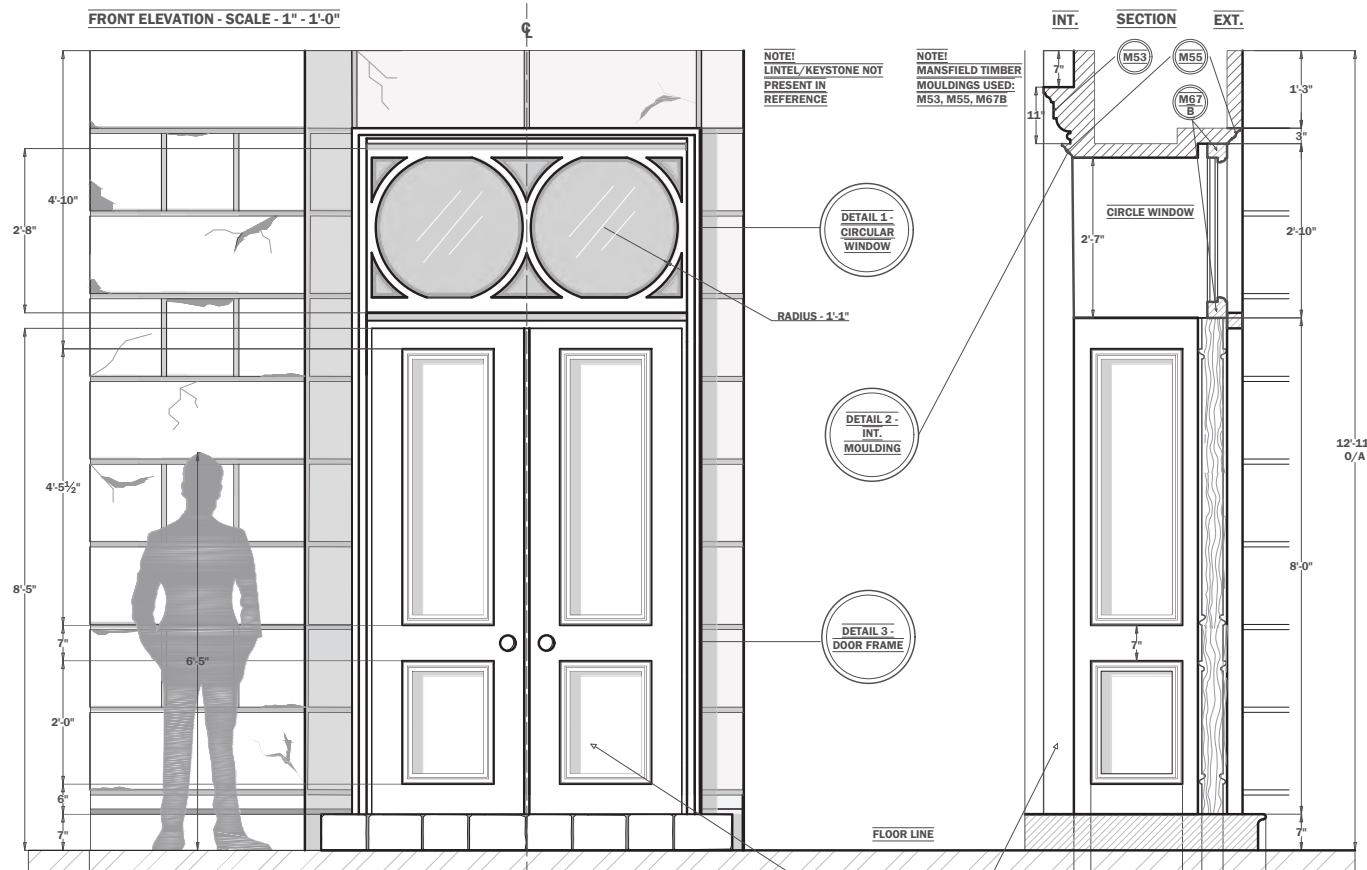

STUART CRAIG DOOR DRAWING		SET NO. 001	DRWG NO. 001
PRODUCTION DESIGNER: STUART CRAIG			
SET NAME: STUART CRAIG DOOR			
DETAIL: DOOR DETAIL - PLAN, ELEVATIONS, SECTION, DETAIL			
STAGE/LOCATION: MAIN STAGE DRAWN BY: MELISSA DAVIS			
DATE DRAWN:	DATE ISSUED:	APPROVED:	
DISTRIBUTION:			

GEORGIAN SLIDING SASH WINDOW - PLANS, ELEVATIONS + SECTION EXT. + INT. SCALE - 1 1/2" = 4'-0"

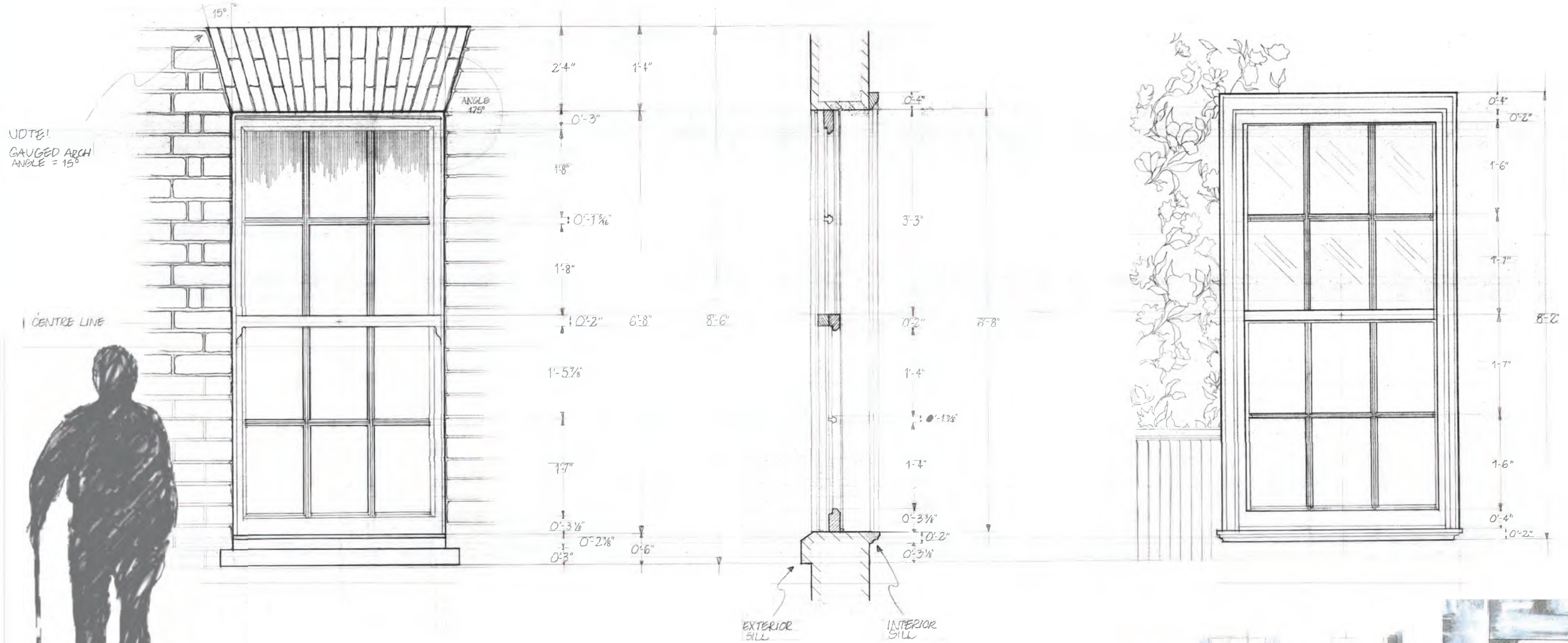

-INT.-

-EXT.-

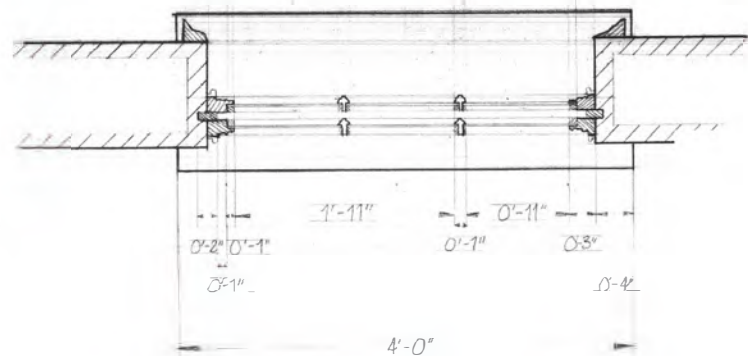

PLAN

NOTE: - STOCK MOULDINGS USED
 M65 C - RAIL
 M65 B - SILL
 M65 A - BAR

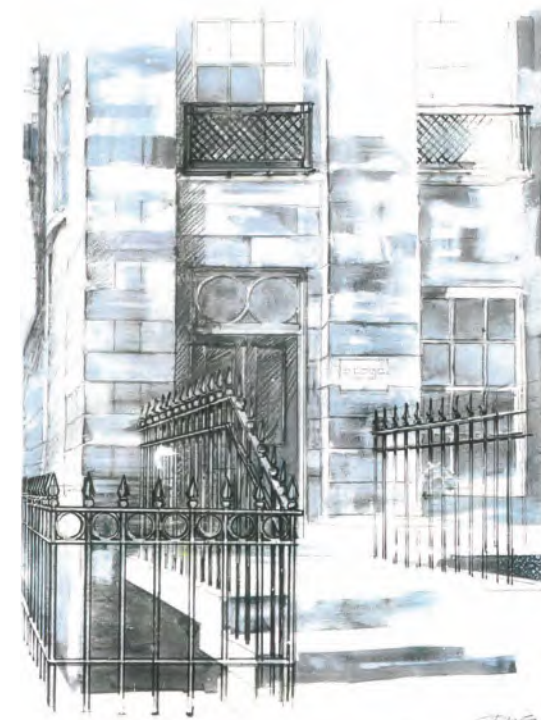

STUART CRAIG WINDOW DRAWING		SET NO 001	DRWG NO 002
PRODUCTION DESIGNER: MELISSA DAVIS			
SET NAME: STUART CRAIG DOOR			
DETAIL: WINDOW DETAIL			
STAGE/LOCATION: MAIN STAGE		DRAWN BY: MELISSA DAVIS	
DATE DRAWN	DATE ISSUED	APPROVED	
DISTRIBUTION			
BY	DATE	TO	REMARKS

National Film and Television School Project

'FANTASY'

Project Brief -

Design a fantastical world with no budget limits,
to fit in Pinewood Stage A

Story -

Set in a post-apocalyptic Victorian London, an
estranged scientist experiments on life and death, living
out the rest of his days in a faraway ice cave.

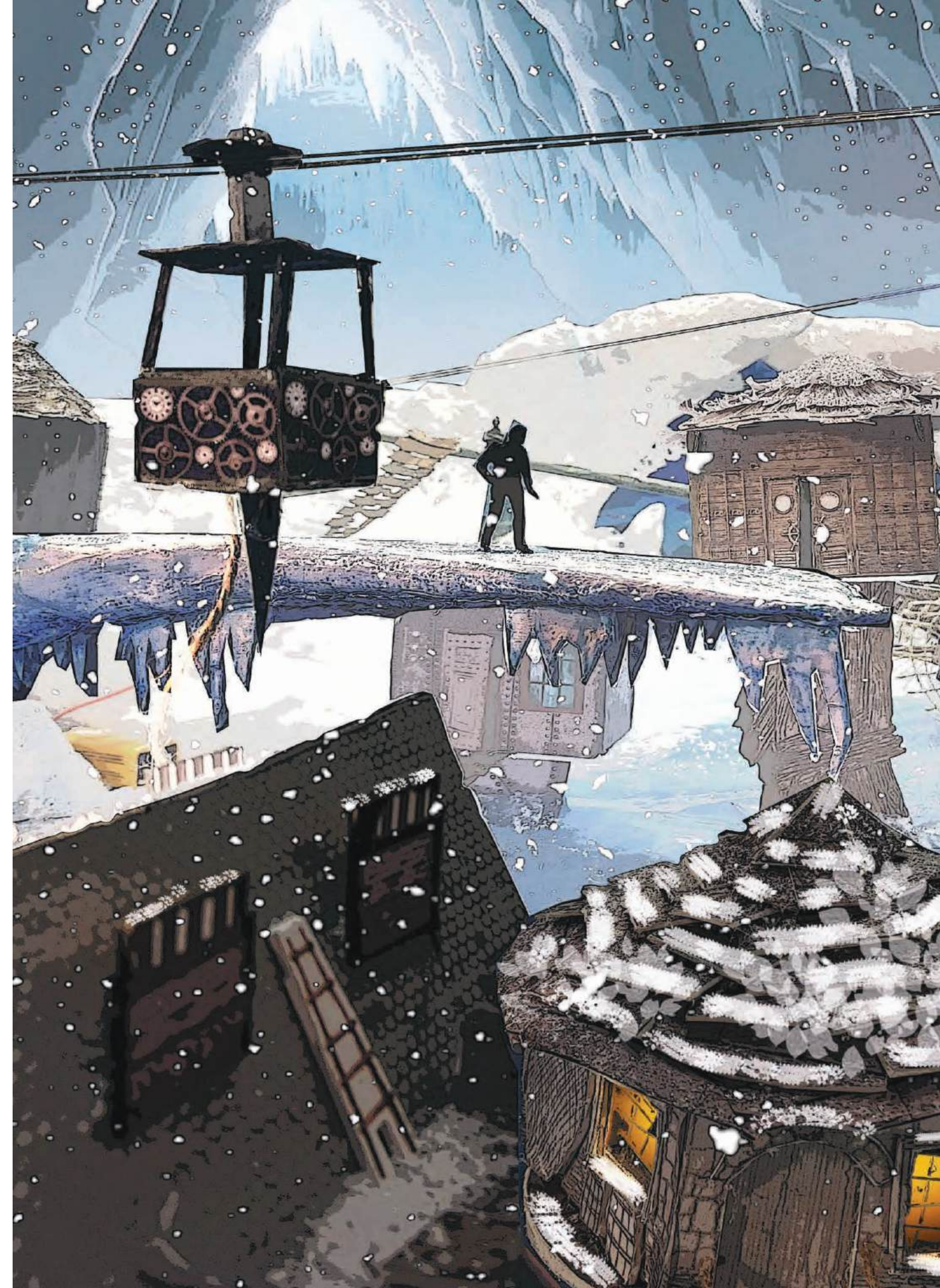

RIGHT:
Interior concept art completed on
Photoshop and Procreate

'FANTASY' Model Photos



ABOVE: Model photographs

Research Images

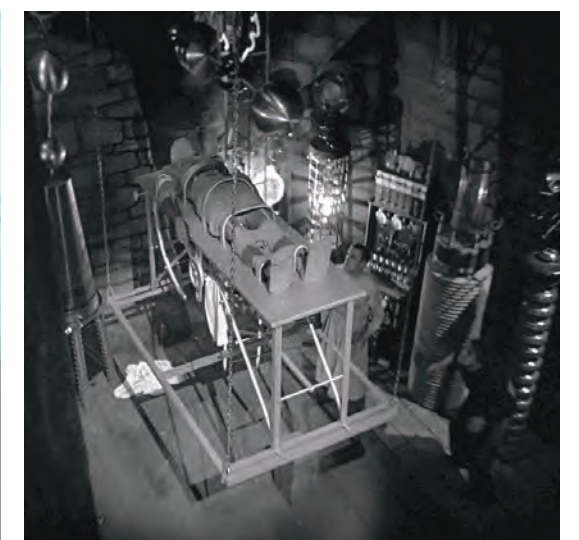
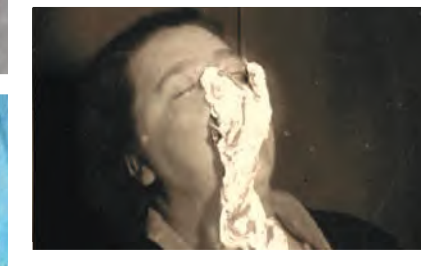
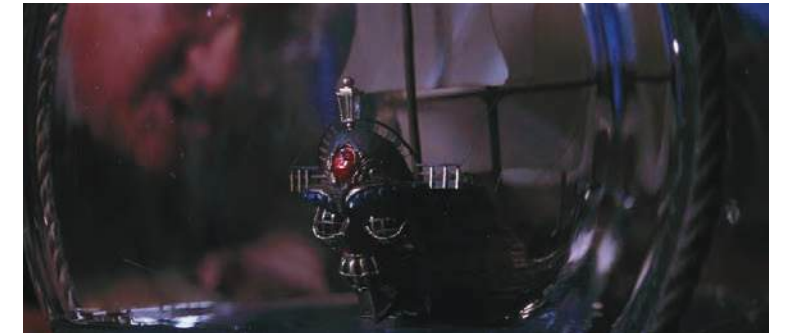
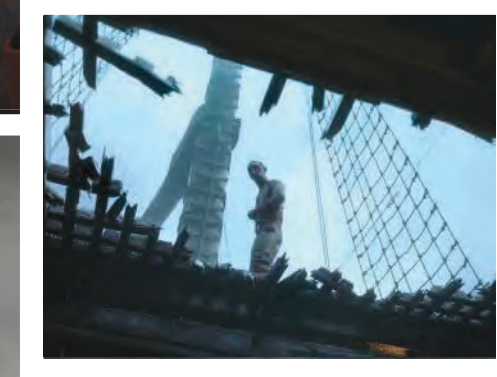

ABOVE: Research Images

"FANTASY" INT. & EXT. "THE BOOK OF DEAD DAYS" - ICE CAVE • 1/4" = 1'0" PLAN A STAGE PINEWOOD

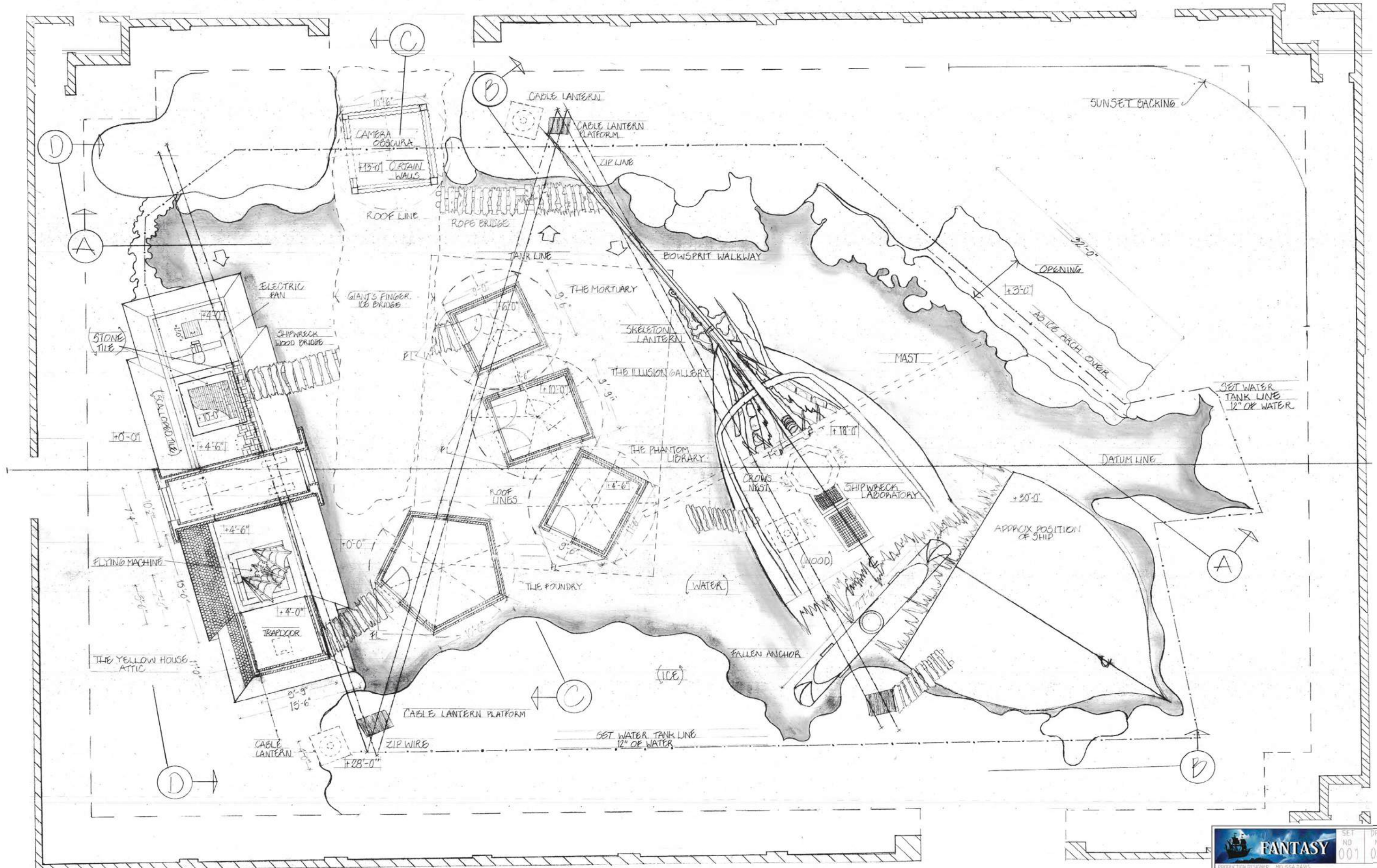

FANTASY		SET NO 001	PRWG NO 001
PRODUCTION DESIGNER: MELISSA DAVIS			
SET NAME: "FANTASY" - INT ICE CAVE			
DETAIL: PLAN			
STAGE/LOCATION: MAIN STAGE		DRAWN BY: MELISSA DAVIS	
DATE DRAWN	DATE ISSUED	APPROVED	
DISTRIBUTION			
TO: DIRECTOR	DATE: _____	BY: _____	REVISION: _____
TO: PRODUCTION DESIGNER	DATE: _____	BY: _____	REVISION: _____
TO: SET DESIGNER	DATE: _____	BY: _____	REVISION: _____
TO: COSTUME DESIGNER	DATE: _____	BY: _____	REVISION: _____
TO: HAIR/MAKEUP	DATE: _____	BY: _____	REVISION: _____
TO: PROP MASTER	DATE: _____	BY: _____	REVISION: _____
TO: STAGEHANDS	DATE: _____	BY: _____	REVISION: _____
TO: LIGHTING	DATE: _____	BY: _____	REVISION: _____
TO: SOUND	DATE: _____	BY: _____	REVISION: _____
TO: VISUAL EFFECTS	DATE: _____	BY: _____	REVISION: _____

"FANTASY" INT. & EXT. "THE BOOK OF DEAD DAYS" - ICE CAVE - 1/4" = 1'-0" ELEVATIONS - 'A' STAGE - PINEWOOD

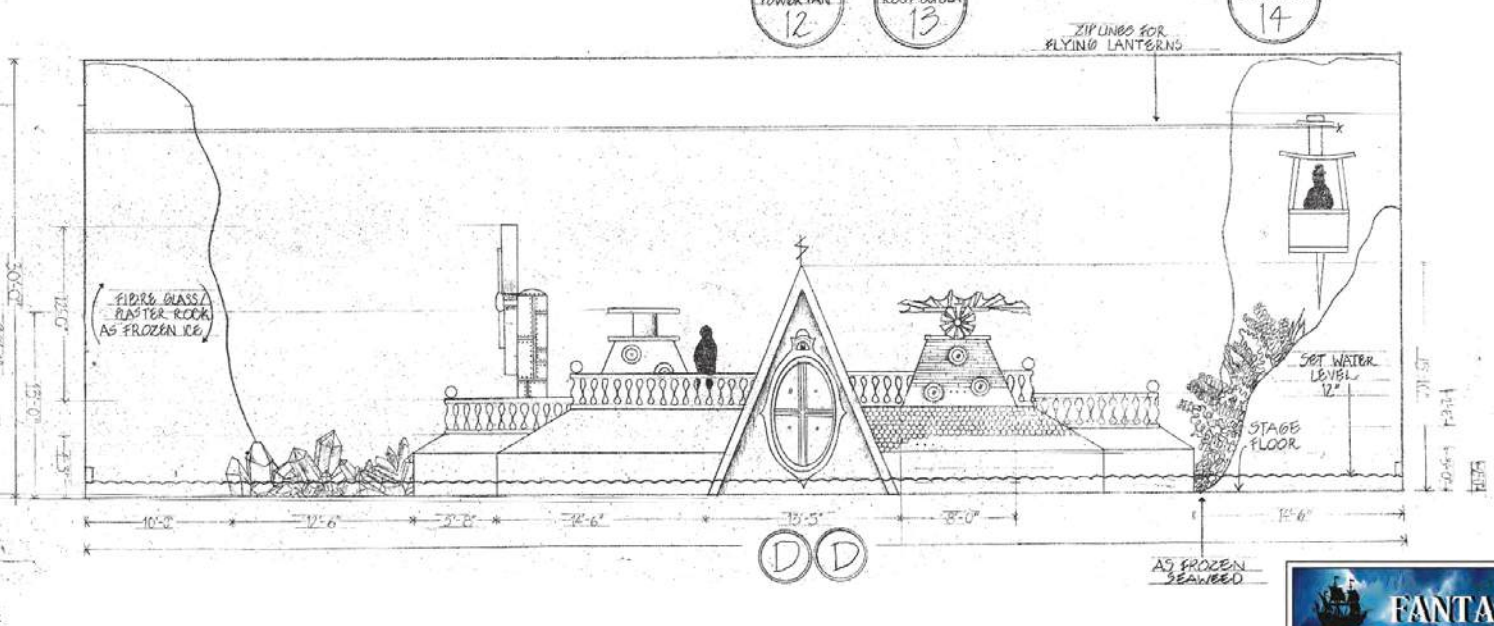
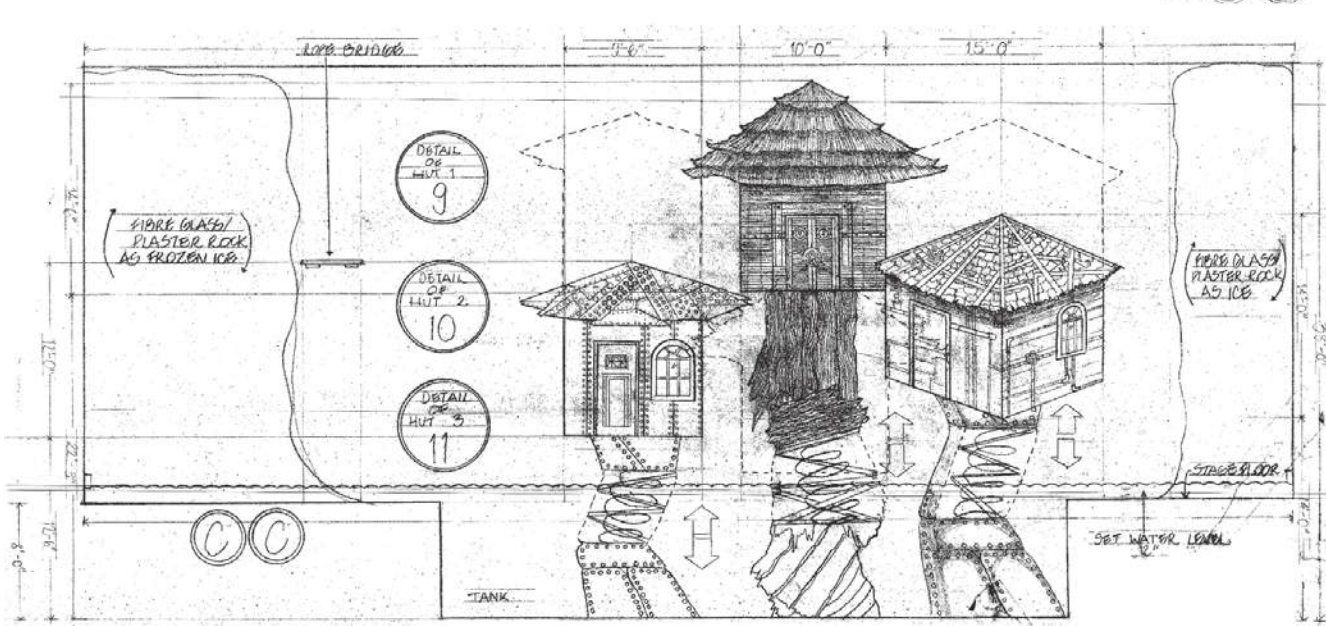
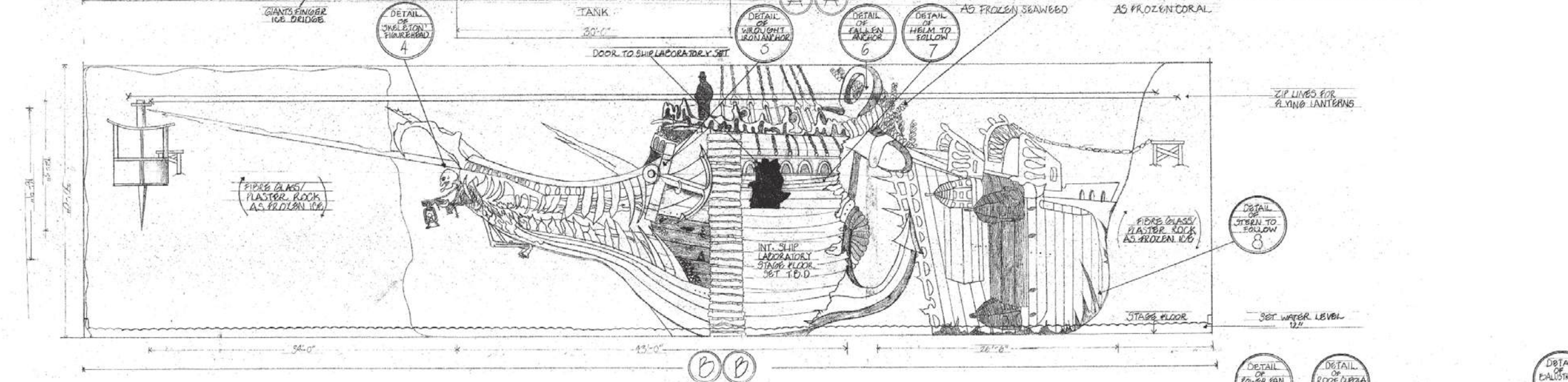
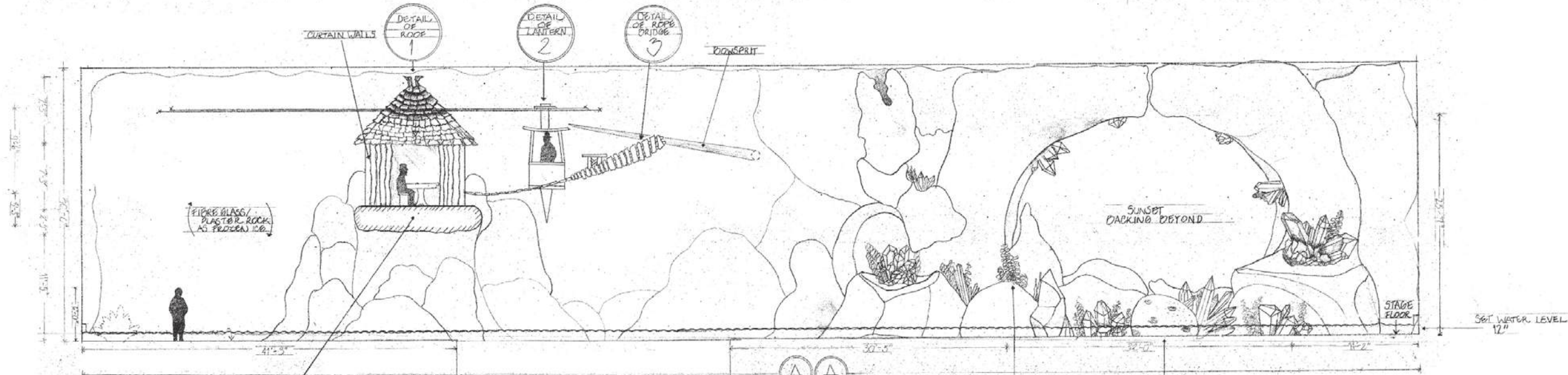

FANTASY		SET NO	DRWG NO
		001	002
PRODUCTION DESIGNER: MELISSA DAVIS			
SET NAME: "FANTASY" - INT ICE CAVE			
DETAIL: ELEVATIONS			
STAGE LOCATION: MAIN STAGE			
DATE DRAWN		DRAWN BY: MELISSA DAVIS	
DATE ISSUED		APPROVED	
DISTRIBUTION			
NAME	DATE	BY	FOR

'FANTASY' - Pirate Ship Model and Illustrations

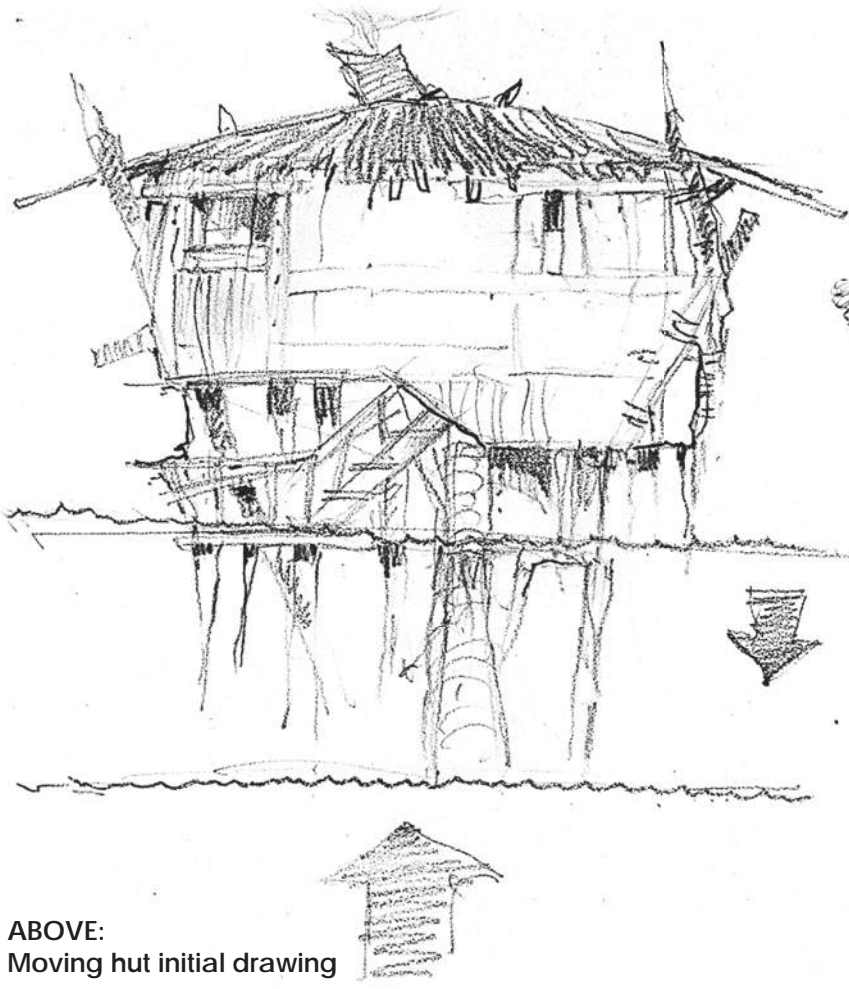

ABOVE:
Moving hut initial drawing

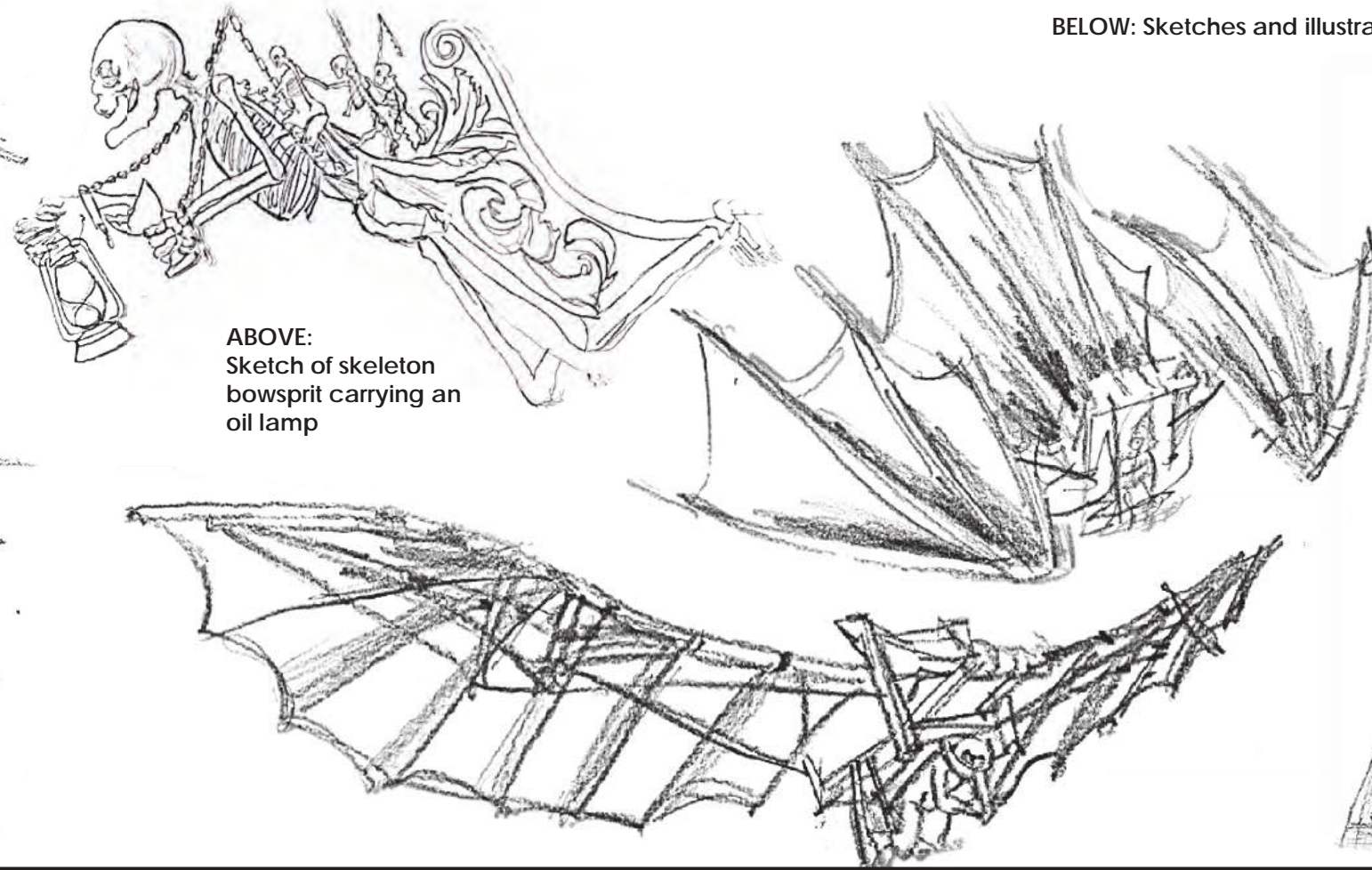

ABOVE:
Sketch of skeleton
bowsprit carrying an
oil lamp

BELOW: Sketches and illustrations





Unreal Engine – ‘The Chicken Shop-ocalypse’

I love horror films, the gorier and sillier the better, and so thought about what a satirical world would look like if a zombie apocalypse took place in the local chicken shop.

As an experiment I undertook in learning how to use Unreal Engine, and how to use the software as a tool for the Art Department, I designed and built a Chicken Shop Set full of zombies.

I created the set design, lighting, 3D modelling, character movement, chose the camera angles, as well as sourced, placed and created my own 3D assets, such as the chairs and tables.

LEFT: Two stills of the Unreal Engine environment

BELOW: Work in progress shots



ABOVE: Wide shot of the chicken shop set from ‘The Chicken Shopocalypse’

'Moor Park – INT. Ballroom'
Location Survey

National Film and Television School
Drafting Exercise

Paper Project Brief –

I was tasked with surveying a specific room in a stately home called 'Moor Park'.

I was given the ballroom and the adjoining annex.

BELOW: Photograph of the 'Moor Park' Ballroom



MOOR PARK SURVEY - INT. BALLROOM & ANNEX - PLAN, ELEVATIONS - SCALE 1/4" = 1'-0"



MOOR PARK		SET NO 001	DRWG NO 001
PRODUCTION DESIGNER: MELISSA DAVIS			
SET NAME: MOOR PARK SURVEY			
DETAIL: PLAN, ELEVATIONS, REFERENCES			
STAGE/LOCATION: MAIN STAGE			
DATE DRAWN:	DATE ISSUED:	DRAWN BY: MELISSA DAVIS	
DISTRIBUTION:		APPROVED:	
NAME:	ROLE:	DATE:	INITIALS:

'TROUBLE'

National Film and Television School
Final Graduation Film –
Production Designer Role

Attained Final Status in the
Student Oscars/ Academy Awards

Set dressing a family home + art studio
from a bare location

'TROUBLE' is a short fiction family drama about an artistic family who are disrupted one evening, by the surprise arrival of their chaotic ex-wife/mother.



LEFT :
Living Room Set
Photograph



'TROUBLE' - Solo Set Dress - Still From Set



ABOVE: Still of the art studio set

Research Images



ABOVE: Research Images

'TROUBLE' - Solo Set Dress - Concept Art



ABOVE: Concept art of the location living room, completed on Procreate

'TROUBLE' - Solo Set Dress - Stills from Set



ABOVE: Living Room, Kitchen and Art Studio Set Photographs