

# EUROPA

## PISCINAS



**El Grup SFP,  
con sus años de  
experiencia y la  
extensa red de  
profesionales  
del sector de la  
piscina con la que  
trabaja, os brinda  
el placer de gozar  
de vuestra piscina,  
un valor a añadir  
a vuestra vida y a  
vuestro hogar.**



**SFP Group,  
with years of  
experience  
and the vast  
network of pool  
professionals  
working with,  
offers to you the  
pleasure to enjoy  
your swimming  
pool, a value to  
add to your life  
and to your home**

**Europa Piscinas** junto con el grup SFP es un grupo consolidado, cuya actividad principal se centra en la fabricación y distribución por todo el mercado nacional, incluyendo las Islas Baleares y las Canarias, así como Portugal, y también en estos últimos años se ha expandido con gran crecimiento en mercados internacionales.

La trayectoria del **Grup SFP** arranca en el año 1988 con la inauguración de la primera fábrica en Vilaür (Girona), y prosiguiendo con la apertura de nuevas fábricas a lo largo de los años. La gran fuerza que aporta esta continua evolución nos permite proporcionar un mejor servicio y una calidad inigualable, ya que, desde los inicios, utilizamos materias primas de última generación, renovándonos constantemente y apostando por los nuevos materiales presentados en el mercado, destacando nuestro absoluto respeto por el medioambiente.

El **Grup SFP** sabe adaptarse a la demanda de sus clientes y por ello dispone de una amplia variedad de modelos de piscinas, de todos los estilos, distinguiéndose por la armonía de sus líneas, la originalidad de sus formas y la dulzura de sus curvas y ángulos, al mismo tiempo que por su robustez incomparable, resultando autoportantes y de fácil, al igual que de rápida, instalación en su jardín, terraza, azotea, etc. Año tras año incorporamos nuevos modelos, con diseños fuera de lo común, a nuestra gama con el objetivo de ofrecer la máxima satisfacción, primando la calidad y la eficacia del buen trabajo, y contamos para ello con más de 150 distribuidores, expertos que saben ajustarse a las preferencias y necesidades de quienes en ellos confían.

***Europa Piscinas** is a consolidated group, whose main activity is centred on the manufacture and distribution in the domestic market, including Balearic and Canary Islands, as well as Portugal, and in recent years has expanded with great growth in international markets.*

*The **SFP Group** evolution started in 1988 with the inauguration of the first factory in Vilaür (Girona), continuing with the opening of the new factories over the years. The great power that gives this continuous progress permits us to provide better service and unequalled quality, since, from the beginning, we use state-of-the-art raw materials, constantly updating ourselves and betting on the new materials presented on the market, emphasizing our absolute respect for the environment.*

***SFP Group** knows how to adapt to the demand of its customers and that's why it has got a wide variety of pool models, all styles, being distinguished by their harmonious lines, their original shapes and their soft curves and angles, at the same time as by their incomparable strength, resulting self-supporting, just like easy and quick-to-install in your garden, terrace, terrace roof, etc. Year after year we add new models, with unusual designs, to our range in order to offer the greatest satisfaction, giving priority to the good work quality and efficiency, and, for this, we count on more than 150 distributors, experts who know how to comply with the preferences and needs of those who trust in them.*

## Eco pools

Gracias a los acabados no porosos de nuestras piscinas, será necesario el consumo de menos producto químico ya que la aparición de las algas será menor para atacar estas superficies más suaves. Si se utilizan limpiafondos automáticos, estos trabajarán menos tiempo para obtener la limpieza de su piscina, lo que supondrá un ahorro en el consumo eléctrico.

Las piscinas de fibra no confían en los paneles de acero o las mallas de estructura de refuerzo de acero, ya que estas no tienen el potencial para absorber el producto químico y podrían ser filtrados a las aguas subterráneas tal como si haría una piscina convencional.

Las piscinas de fibra en general actúan como aislante natural y su equipación (filtro, bomba de calor,..) Se utiliza mucho menos que en piscinas de obra o liner. Dependiendo del clima y del tamaño de la piscina un propietario puede llegar a ahorrar mensualmente en el mantenimiento y consumo de su piscina versus a los otros tipos de piscinas (obra/liner).

Con cada vez más gente concienciada con su entorno y el medio ambiente, nuestras piscinas sostenibles, son ya las piscinas del mañana, no solo nuestras piscinas necesitan de menos producto químico para su mantenimiento y menos consumo de energía y de agua, sino que además no necesitan ser recubiertas lo que supone un menor gasto en su ejecución.

## Las piscinas del mañana disponibles hoy

### Nuestras piscinas más sostenibles

- Ahorro en el consumo de agua mensual
- Necesarios menos productos químicos
- Menos gasto en ejecución y relleno de tierra
- Zero pérdidas de químicos y corrosión al subsuelo
- No es necesario el recubrimiento



*The non-porous, smooth finish of our pools prevents the appearance of algae which in turn means that they require less chemical treatment. If you use an automatic pool cleaner, it will take you less time to clean your pool, also saving on your electricity.*

*Like conventional pools, fibreglass swimming pools do not have steel panels or steel mesh reinforcement structures. They therefore do not have the potential to absorb the chemical products which could filter through to the groundwater.*

*Fibreglass swimming pools in general act as natural insulators and their equipment (filter, heat pump, etc) is used much less than in concrete or lined swimming pools. Depending on the climate and the size of the pool, you can save up to monthly on maintenance and consumption costs compared to other types of swimming pools (concrete/liners).*

*People are increasingly aware of sustainability and their obligations towards the environment. Our sustainable swimming pools are the swimming pools of tomorrow. Not only do our pools need less chemical treatment, they also consume less energy and water. In addition, they do not need to be coated, which reduces the running costs.*

## The swimming pool of tomorrow - available today

### Our most sustainable swimming pool

- Savings on monthly water consumption
- You'll need fewer chemical products
- Lower running costs and less fill required
- No corrosion or loss of chemicals into the subsoil
- You don't need to cover it



## SFP Coating process

**SFP Coating** es un proceso que lleva aplicándose más de 30 años y siempre buscando las nuevas tecnologías para estar a la vanguardia y mejorar día a día nuestro producto.

Nuestro proceso **SFP Coating** está basado en la obtención de la mejor calidad en nuestras piscinas y que esta sujeto a una innovación constante. Cada piscina supera unos estrictos controles que garantizan la longevidad de su inversión.

Nuestro proceso **SFP Coating** esta basado en la aplicación de un gelcoat que permite obtener una superficie no porosa y resistente a los químicos, a los rayos uva y una menor decoloración. Nuestro sándwich de laminación con un mat entrelazado estructural en nuestra fabricación nos permiten obtener primero una barrera química en la piscina para protegerla de la aparición de ampollas y la obtención final de un producto de alta resistencia y durabilidad.

Los materiales usados para la fabricación de nuestras piscinas, son materiales de la más alta calidad, utilizados también en otros campos como son el náutico y el aeroespacial. La utilización de estos materiales nos permite obtener unas piscinas con una mayor dureza, resistencia y durabilidad.

*The **SFP Coating** process is more than 30 years old and continuously seeks to incorporate cutting edge technology in order to improve our product.*

*Our **SFP Coating** process aims to achieve high quality in our swimming pools and undergoes constant innovation. Every pool passes strict quality tests that guarantee the longevity of your investment.*

*Our **SFP Coating** process includes the application of a gelcoat that produces a non-porous surface. This surface is chemical and uva ray resistant and will therefore discolour less. Our sandwich laminate has an interwoven structural mesh which enables us to create a chemical barrier in the pool. This prevents bubbles appearing and as a result produces a highly resistant, durable product.*

*The materials used to manufacture our swimming pools are of the highest quality and are also used in other industries such as shipping and aerospace. Using these materials enables us to produce tougher, more resistant and more durable swimming pools.*

- 1 Gelcoat
- 2 Barrera química de alta resistencia
- 3 4 Capas de fibra de vidrio en laminación
- 5 Sandwich estructural de fibra de vidrio
- 6 Hierro galvanizado para una mayor rigidez y durabilidad
- 7 Refuerzos horizontales y verticales obtención de mayor resistencia estructural
- 8 Proyectado con fibra de vidrio y resina exclusiva para la protección del laminado

- 1 Gelcoat
- 2 High resistance chemical barrier
- 3 4 Laminated fibreglass layers
- 5 Fibreglass structural sandwich
- 6 Galvanised iron for high rigidity and durability
- 7 Horizontal and vertical reinforcements for greater structural resistance
- 8 Exclusively designed with fibreglass and resin to protect the laminate



# Gel-coat

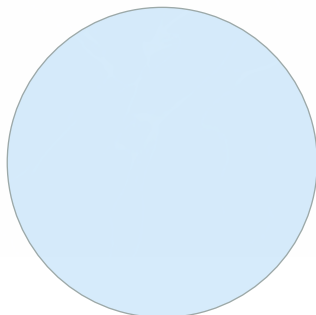

Azul  
Blue

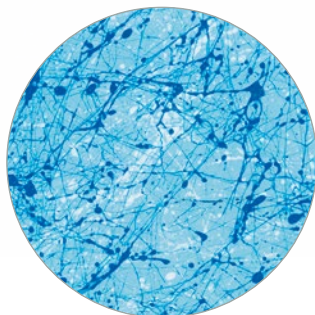

Azul goutteletes  
Blue goutteletes



Las dimensiones aproximadas corresponden al rectángulo en el cual está inscrita la piscina

*The estimated dimensions correspond to the rectangle in which the swimming pool is inscribed*

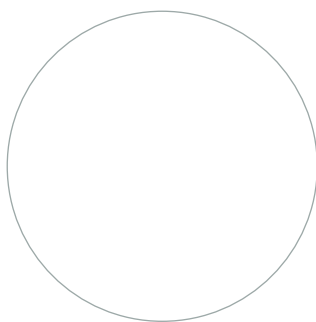

Blanco  
White

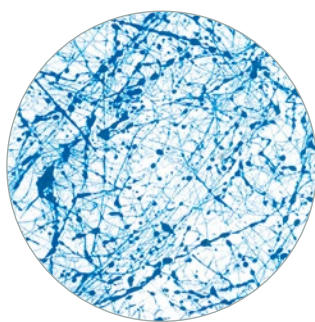

Blanco goutteletes  
White goutteletes

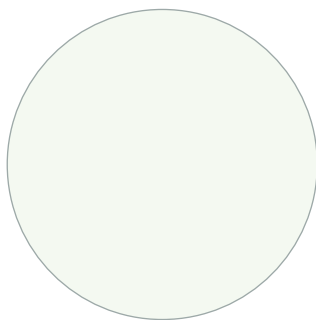

Blanco-Verde  
White-Green

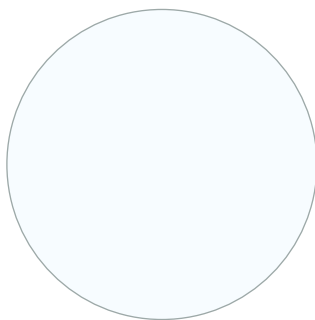

Blanco-Azul  
White-Blue

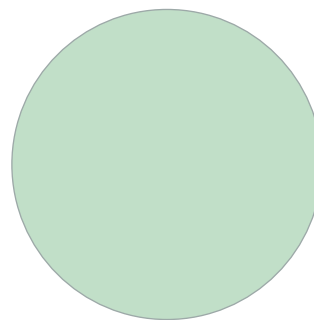

Verde  
Green

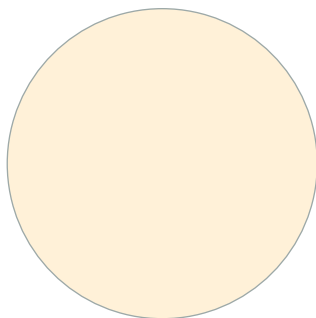

Beige  
Brown Clear

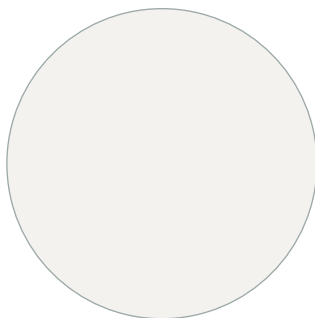

Gris Claro  
Grey Clear

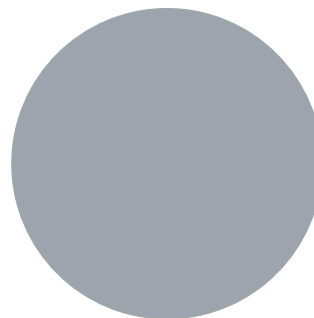

Gris 7040  
Grey 7040

# Proceso de fabricación

## *Manufactured process*



1 Preparación del molde y acondicionamiento para un fácil desmoldeo y una obtención final de gran calidad

*Preparation of the mold and conditioning for easy withdrawal and finally obtaining great quality*



2 Aplicación de nuestro gelcoat exclusivo

*Application our exclusive gelcoat*



3 Aplicación de la barrera química de alta resistencia

*Application of high resistance chemical barrier*



4 Aplicación manual de fibra de vidrio y resina

*Manual application of fiberglass and resin*



5 Colocación de refuerzos verticales y horizontales y hierro galvanizado para la obtención de una mayor dureza y resistencia al impacto

*Placement vertical and horizontal reinforcements and galvanized iron for obtaining higher hardness and resistance to the impact*

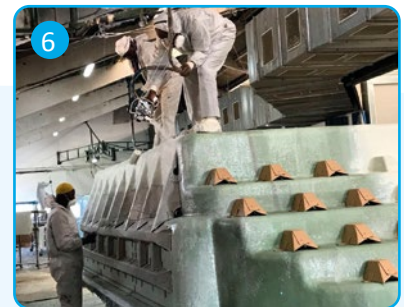

6 Proyectado con fibra de vidrio y resina exclusiva para la protección del laminado

*Projected with fiberglass and exclusive resin for laminate protection*



7 Desmoldeo

*Remove swimming pool*



8 Acabado final y control de calidad

*Finishing and quality control*



9 Piscina terminada para ser entregada

*Pool finished to be delivered*

# Proceso de instalación

## *Installation process*



1  
Excavación  
*Digging*



2  
Preparación del terreno  
*Ground preparing*



3  
Colocación  
*Placing*



4  
Puesta a nivel  
*Levelling*



5  
Rellenado  
*Filling*



6  
Conducciones periféricas  
*Peripheral pipes*



7  
Asientos de brocales  
*Coping stone placing*

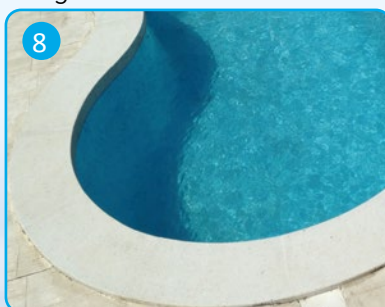

8  
Colocación de brocales  
*Coping stone fixing*





SPACE 650

# SPACE

650 / 750 / 850 / 950



SPACE 750



SPACE 750

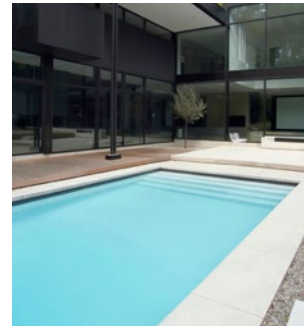

SPACE 950

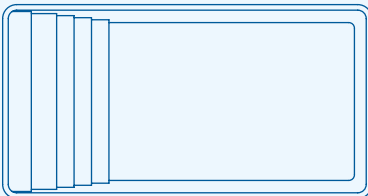
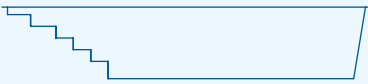

**SPACE 650**  
6.50 x 3.25 m | Prof. 1.50 m

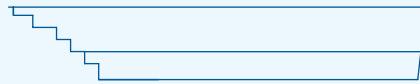

**SPACE 750**  
7.50 x 3.60 m  
Prof. 1.50 m

**SPACE 850**  
8.50 x 3.90 m  
Prof. 1.50 m

**SPACE 950**  
9.50 x 3.90 m  
Prof. 1.50 m





STAR 7

# STAR

4 / 5 / 6 / 7 / 8 / 9



STAR 6



STAR 9

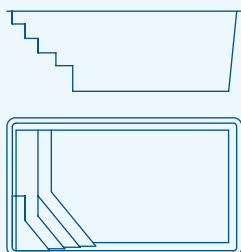

**STAR 4**  
4.20 x 2.40 m  
Prof. 1.50 m

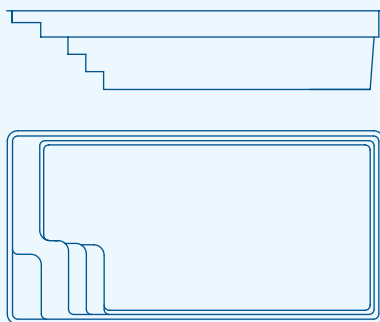

**STAR 5**  
5.40 x 2.70 m | Prof. 1.50 m

**STAR 6**  
6.00 x 3.00 m | Prof. 1.50 m

**STAR 7**  
7.00 x 3.50 m | Prof. 1.50 m

**STAR 8**  
8.00 x 4.00 m | Prof. 1.50 m

**STAR 9**  
9.00 x 4.00 m | Prof. 1.50 m



SKY 9

# SKY

7 / 9



SKY 9



SKY 4

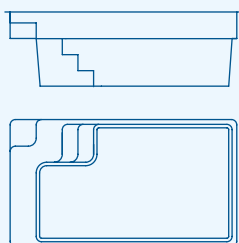

**SKY 4**  
4.18 x 2.38 m | Prof. 1.40

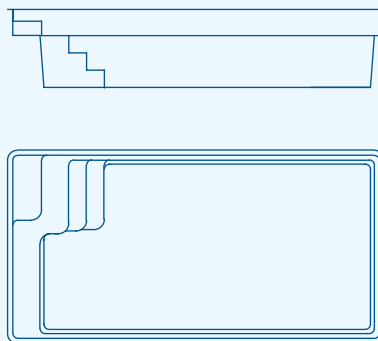

**SKY 7**  
7.00 x 3.50 m | Prof. 1.50 m

**SKY 9**  
9.00 x 4.00 m | Prof. 1.50 m



# SWIM

6 / 8 / 10 / 12

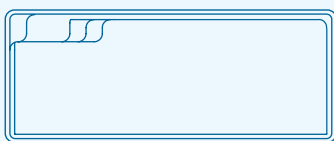
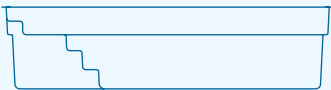
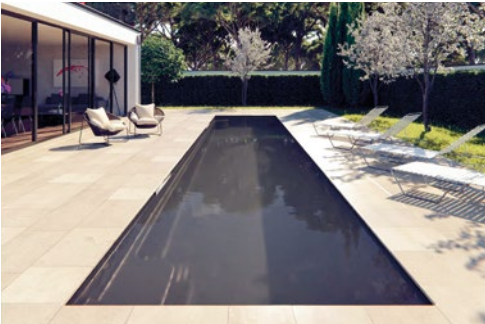

**SWIM 6**  
6.00 x 2.30 m | Prof. 1.50 m

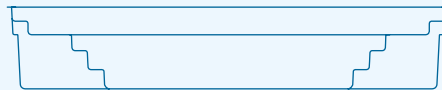

**SWIM 8**  
8.00 x 2.30 m | Prof. 1.50 m

**SWIM 10**  
10.00 x 2.30 m | Prof. 1.50 m

**SWIM 12**  
12.00 x 2.30 m | Prof. 1.50 m



# PLAYA

750 / 850 / 950

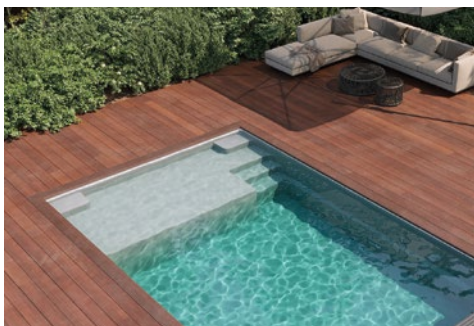

PLAYA 850

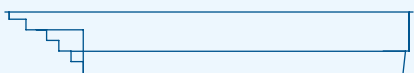
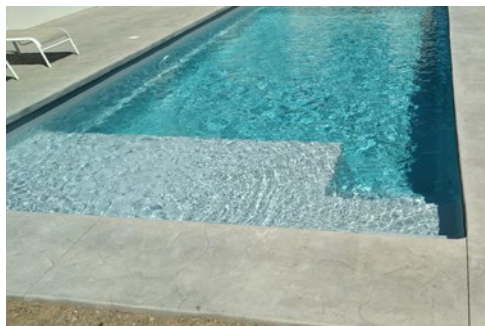

## PLAYA 750

7.50 x 3.60 | Prof. 1.50 m

## PLAYA 850

8.50 x 3.90 | Prof. 1.50 m

## PLAYA 950

9.50 x 3.90 | Prof. 1.50 m



# SPACE

850 / 950 VOLET



SPACE 850 VOLET

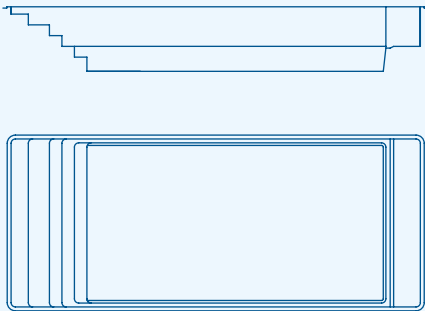

**SPACE 850 VOLET**

8.50 x 3.90 | Prof. 1.50 m

**SPACE 950 VOLET**

9.50 x 3.90 | Prof. 1.50 m



# STAR

4 / 6 / 8 / 9 VOLET



STAR 8 VOLET

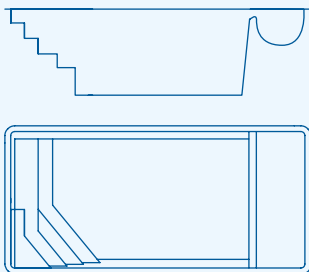

**STAR 4**  
5.05 x 2.40 m  
Prof. 1.50 m

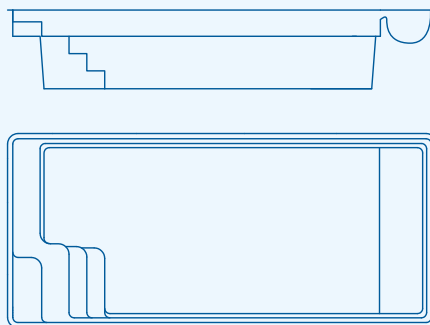

**STAR 6 VOLET**  
7.10 x 3.00 m | Prof. 1.46 m

**STAR 8 VOLET**  
9.10 x 4.00 m | Prof. 1.50 m

**STAR 9 VOLET**  
10.10 x 4.00 m | Prof. 1.50 m



SKY 7

# SKY

7 / 9 VOLET

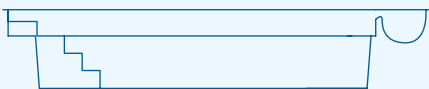
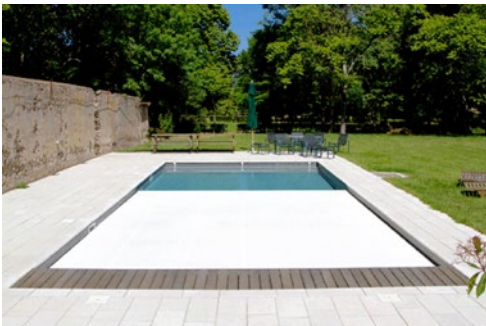

**SKY 7 VOLET**  
8.10 x 3.50 m | Prof. 1.50 m



**SKY 9 VOLET**  
10.10 x 4.00 m | Prof. 1.50 m



PLAYA 850

# PLAYA

850 / 950 VOLET



PLAYA 850 VOLET



PLAYA 950 VOLET

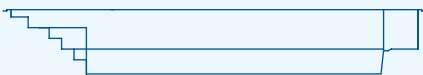

**PLAYA 850 VOLET**

8.50 x 3.90 | Prof. 1.50 m

**PLAYA 950 VOLET**

9.50 x 3.90 | Prof. 1.50 m



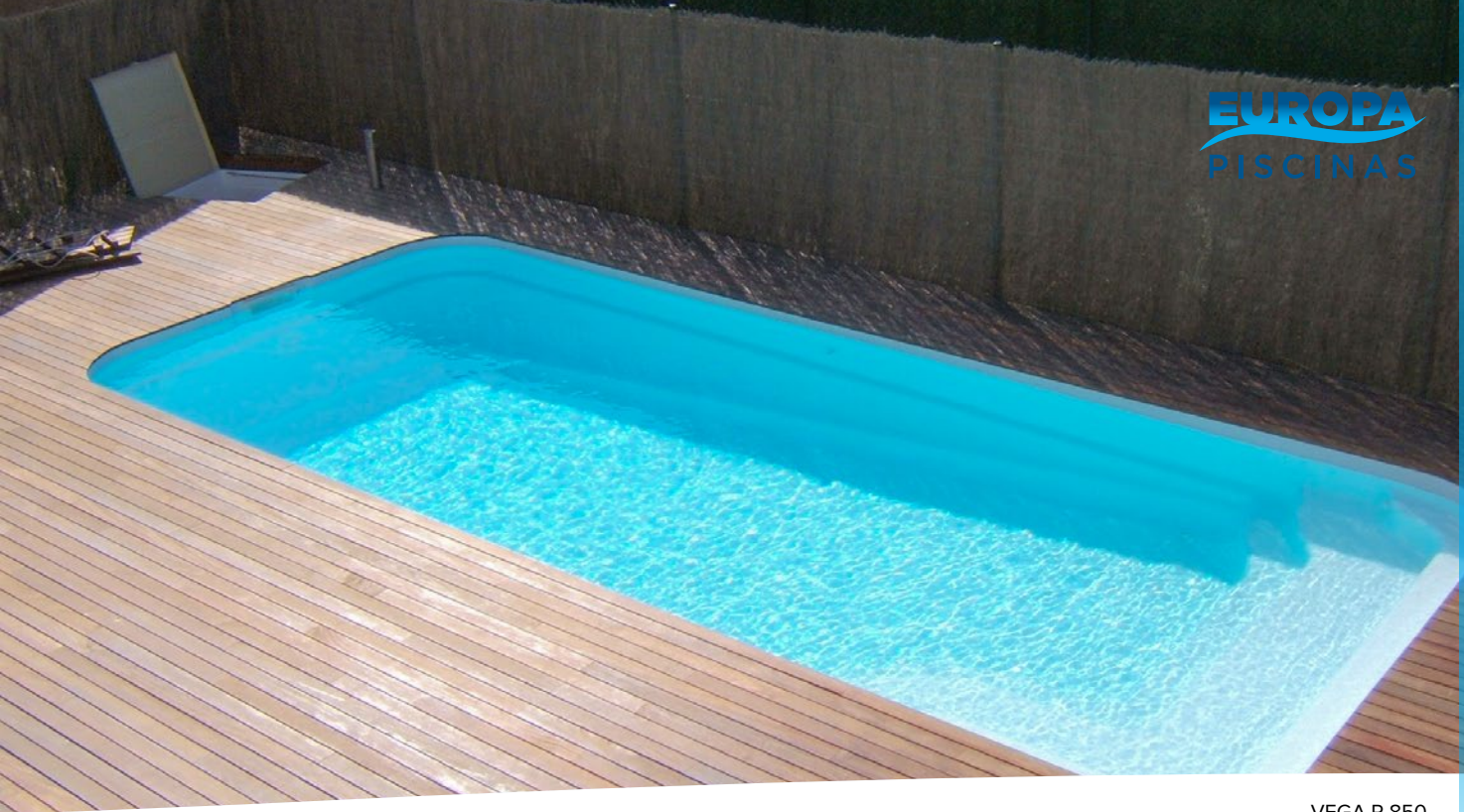

VEGA P 850

# VEGA

850 / P 850 / P 950



VEGA 850



VEGA P 950

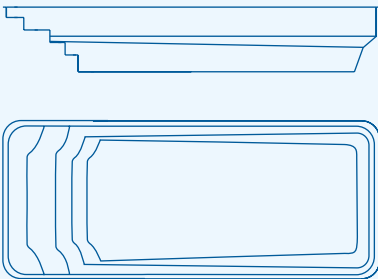

**VEGA 850**  
8.50 x 3.65 m | Prof. 1.50 m

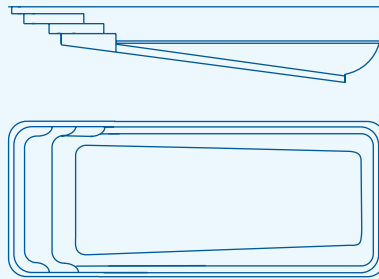

**VEGA P 850**  
8.50 x 3.50 m  
Prof. 0.90/1.70 m

**VEGA P 950**  
9.50 x 3.80 m  
Prof. 0.85/1.85 m



MICRO POOL

# NEW POOL

MICRO POOL / BABY POOL 2 / MAXI POOL



BABY POOL



MAXI POOL

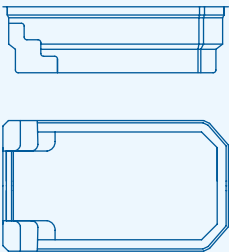

**MICRO POOL**  
3.90 x 2.25 m  
Prof. 1.20 m

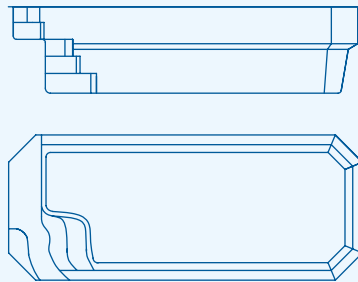

**BABY POOL 2**  
5.50 x 2.30 m | Prof. 1.38 m

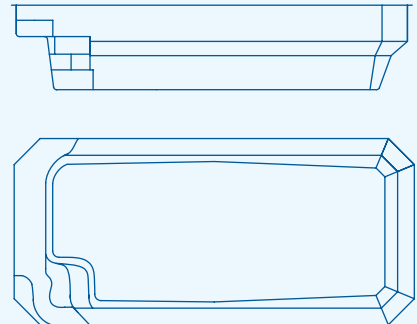

**MAXI POOL**  
6.50 x 3.00 m | Prof. 1.40 m



GEMINI 2

# MINI

## GEMINI 2

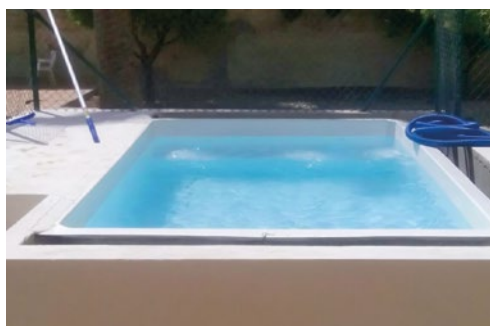

GEMINI 2



GEMINI 2

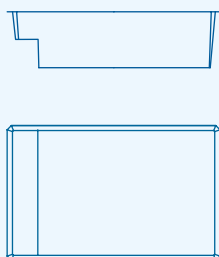

**GEMINI 2**  
3.00 x 1.89 m  
Prof. 0.90 m



BUBBLE 2 DESB

# RELAX

BUBBLE 2 / BUBBLE 2 DESB / HYDRA 460 / IBIZA



BUBBLE 2 DESB



HYDRA 460



IBIZA



**BUBBLE 2**  
Ø 2.00 m  
Prof. 1.05 m



**BUBBLE 2 DESB**  
Ø 2.00 m  
Prof. 1.05 m



**HYDRA 460**  
4.50 x 2.15 m  
Prof. 1.23 m

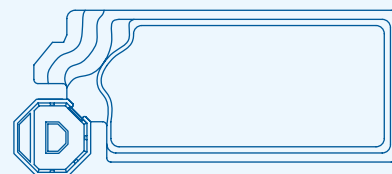
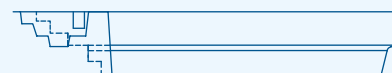

**IBIZA**  
9.35 x 4.00/3.70 m  
Prof. 1.60 m



DENE B 7

# DENE B

P 6 / P 7 / 7



DENE B P 6



DENE B P 7

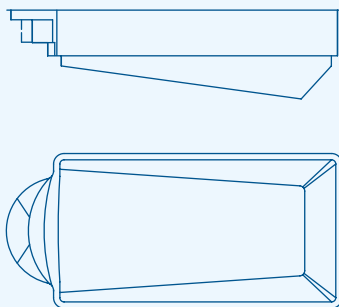

**DENE B P 6**  
6.40 x 2.95 | Prof. 1.10/1.75 m

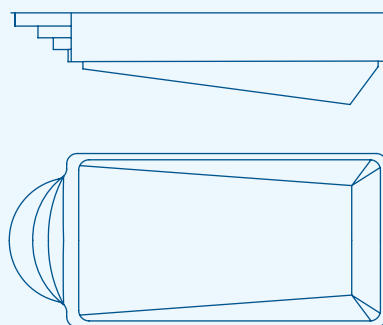

**DENE B P 7**  
7.25 x 3.30 m | Prof. 1.10/1.70 m

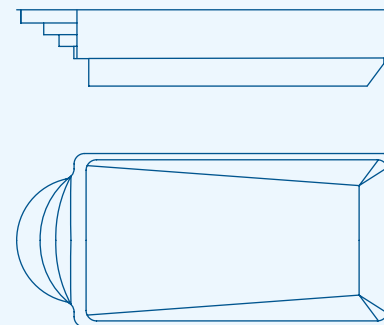

**DENE B 7**  
7.25 x 3.30 m | Prof. 1.50 m



FLORENCIA

# UNION

PARIS / ROMA / FLORENCIA



PARIS



ROMA

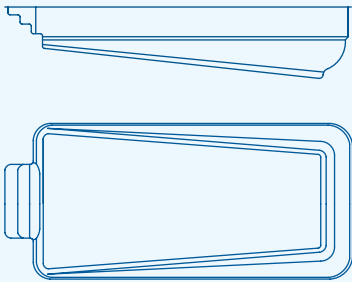

**PARIS**  
8.50 x 3.80  
Prof. 1.05/1.85 m

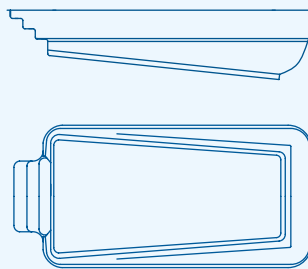

**ROMA**  
7.30 x 3.50 m  
Prof. 1.00/1.75 m

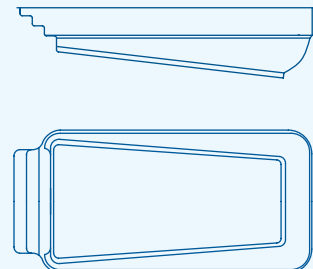

**FLORENCIA**  
7.25 x 3.45  
Prof. 1.00/1.75 m



4900

# ROMANAS

S 770 R / 4900 / S 970 R / S 1070 R



S 770 R



S 970 R

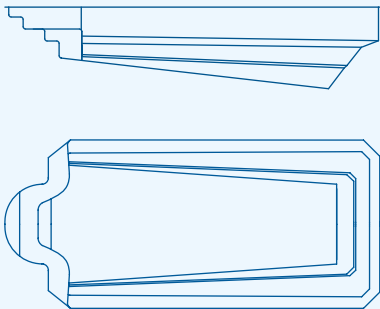

## S 770 R

7.70 x 3.65 | Prof. 1.05/1.70 m

## 4900

8.95 x 4.00 m | Prof. 1.10/2.05 m

## S 970 R

9.70 x 4.00 | Prof. 1.05/2.05 m

## S 1070 R

10.75 x 4.15 | Prof. 0.90/2.10 m



DUBLIN

# ROMANAS

DUBLIN / PONTEVEDRA



DUBLIN



PONTEVEDRA

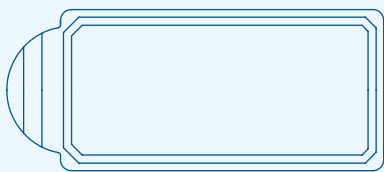

**DUBLIN**  
7.00 x 3.00 m | Prof. 1.40 m



**PONTEVEDRA**  
8.00 x 3.80 m | Prof. 1.05/1.80 m





HYDRUS 7

# HYDRUS

6 / 7 / 8



HYDRUS 7



HYDRUS 7

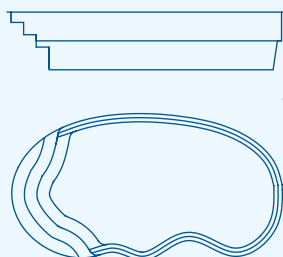

**HYDRUS 6**  
6.50 x 3.56 m | Prof. 1.40 m

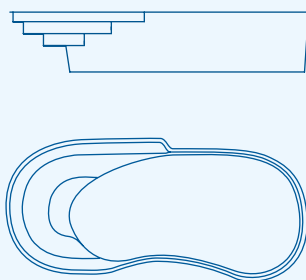

**HYDRUS 7**  
7.40 x 3.40 m | Prof. 1.50 m

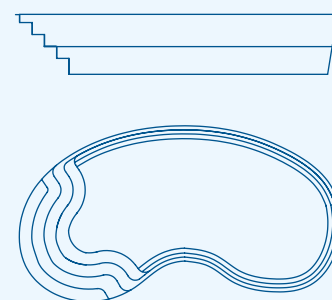

**HYDRUS 8**  
8.00 x 4.35/3.60 m  
Prof. 1.50 m



MADRID

# KIDNEY

LANZAROTE / MENORCA / MADRID



LANZAROTE



MENORCA

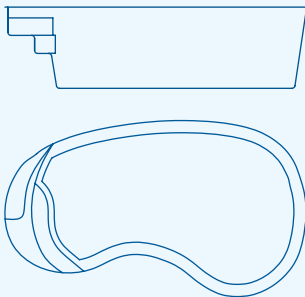

**LANZAROTE**  
4.95 x 2.10/2.90 m | Prof. 1.35 m

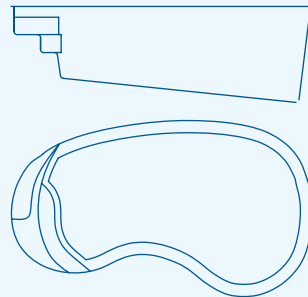

**MENORCA**  
4.95 x 2.10/2.90 m  
Prof. 1.20/1.60 m

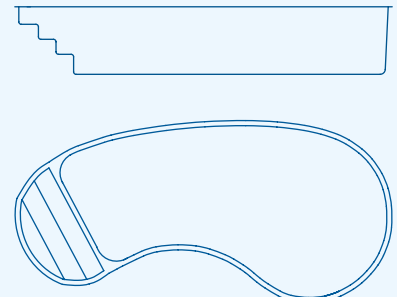

**MADRID**  
7.65 x 3.25/3.85 m | Prof. 1.35 m



OPORTO

# KIDNEY

LISBOA / OPORTO



LISBOA



OPORTO

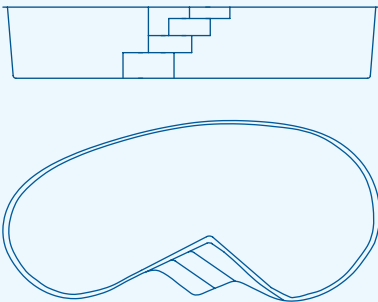

**LISBOA**  
6.40 x 2.40/3.00 m | Prof. 1.25 m

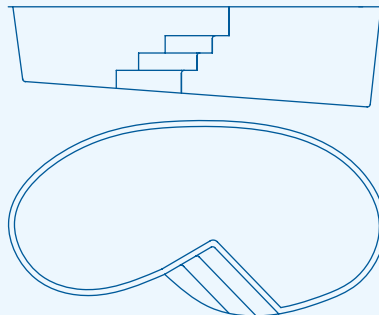

**OPORTO**  
6.40 x 2.95/3.30 m | Prof. 1.75/1.25 m



ELIPSA 800

# ELIPSA

800 / 1000



ELIPSA 800



ELIPSA 1000

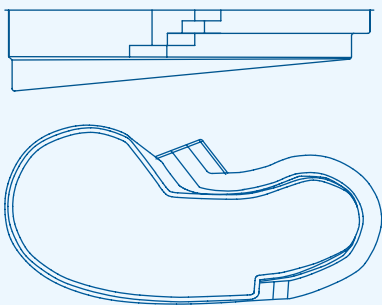

**ELIPSA 800**  
8.05 x 3.95/3.30 m | Prof. 1.75/1.05 m

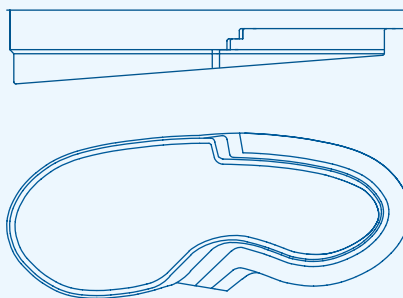

**ELIPSA 1000**  
9.95 x 4.25/3.85 m | Prof. 1.80/1.05 m



ISTAMBUL

# ISTAMBUL

4 / 5

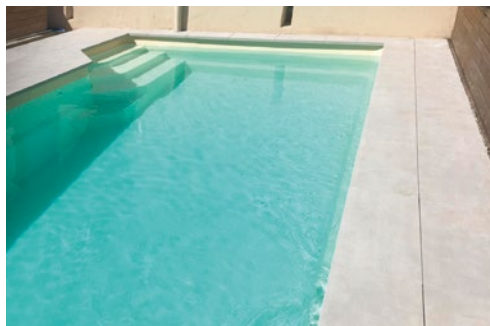

ISTAMBUL

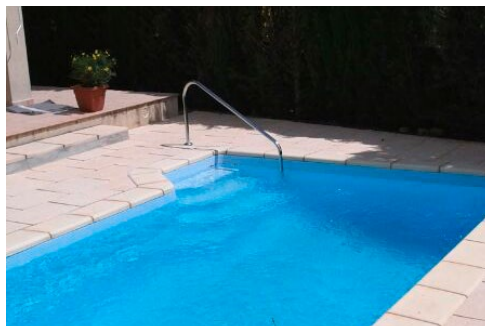

ISTAMBUL

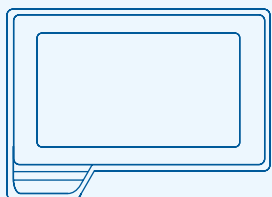
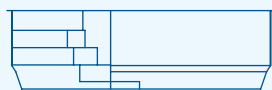

**ISTAMBUL 4**  
4.25 x 3.00 m | Prof. 1.30 m

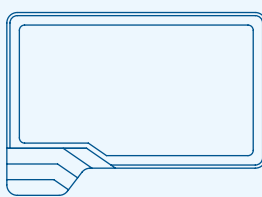
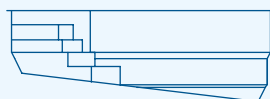

**ISTAMBUL 5**  
4.95/3.50 m | Prof. 1.20/1.75 m



DX 8

# DX

7 / 8



DX 7



DX 8

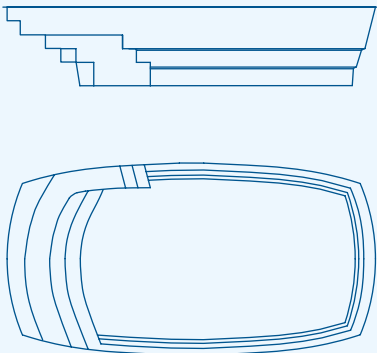

**DX 7**  
7.00 x 3.65 m | Prof. 1.55 m

**DX 8**  
8.00 x 3.90 m | Prof. 1.55 m



ATENAS

# CUSTOM

## S 307 / MALLORCA



S 307



MALLORCA

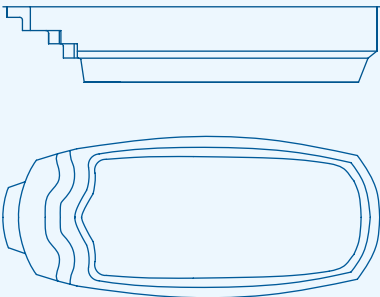

**S 307**  
7.00 x 3.00 m | Prof. 1.40 m

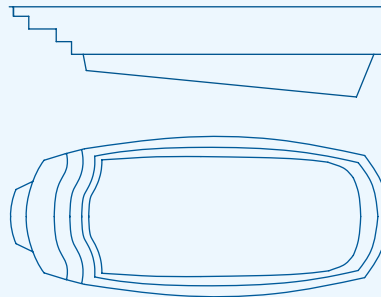

**MALLORCA**  
7.00 x 3.00 m | Prof. 1.20/1.70 m



MALLORCA

# CUSTOM

## ATENAS / LONDRES



ATENAS



LONDRES

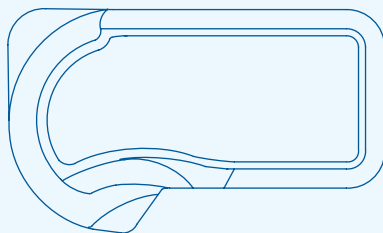
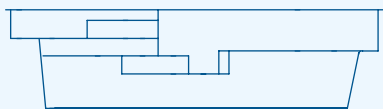

**ATENAS**  
5.95 x 3.50/2.85 m  
Prof. 1.60 m

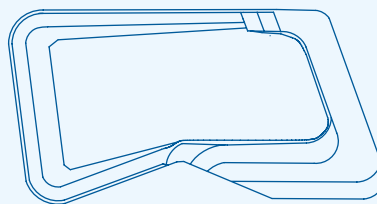

**LONDRES**  
6.60 x 3.40 m  
Prof. 1.70/1.10 m





LIRA 9

# CUSTOM

TIERRA 8 / LIRA 9



TIERRA 8



LIRA 9

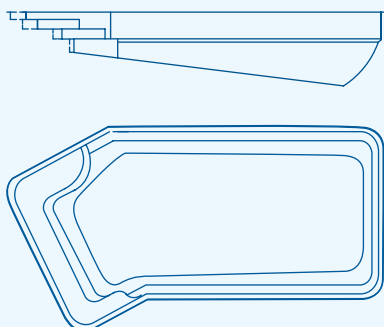

**TIERRA 8**  
8.50 x 3.95 m | Prof. 0.90/1.70 m

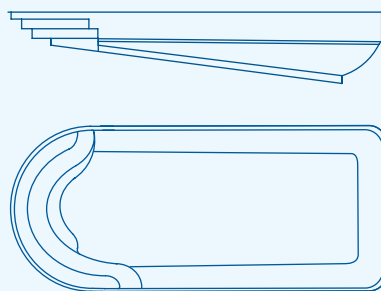

**LIRA 9**  
9.50 x 3.80 m | Prof. 0.85/1.85 m

## BIG POOL A EVASION

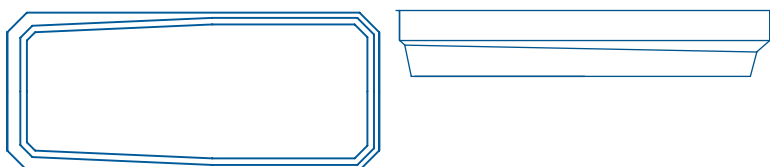

8.50 x 3.60 m | Prof. 1.50 m

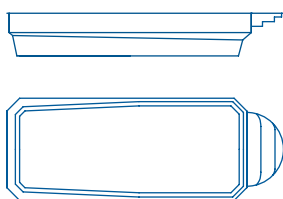

**ROMAINE**  
9.65 x 3.60 | Prof. 1.50 m

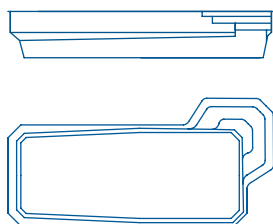

**PRIVILEGE**  
9.50 x 4.60 | Prof. 1.50 m

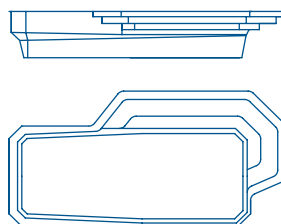

**PALACE**  
9.50 x 4.80 | Prof. 1.50 m

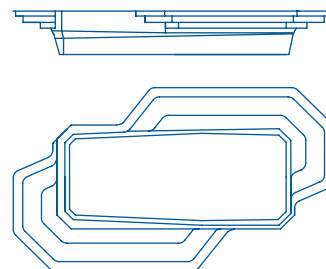

**PRESTIGE**  
10.50 x 6.00 | Prof. 1.50 m

## BIG POOL B EVASION

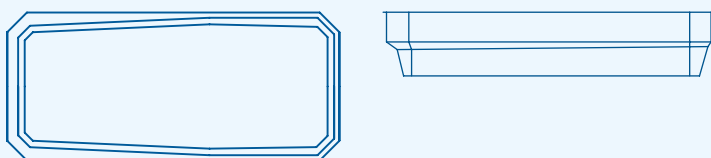

7.60 x 3.40 m | Prof. 1.50 m

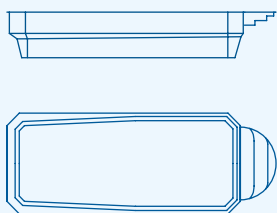

**ROMAINE**  
8.75 x 3.40 | Prof. 1.50 m

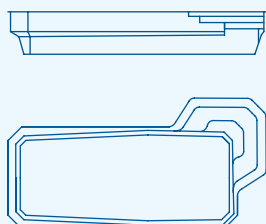

**PRIVILEGE**  
8.60 x 4.40 | Prof. 1.50 m

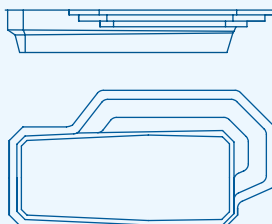

**PALACE**  
8.60 x 4.60 | Prof. 1.50 m

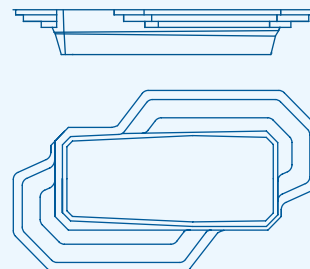

**PRESTIGE**  
9.60 x 5.80 | Prof. 1.50 m



# MEGA POOL

## EVASION

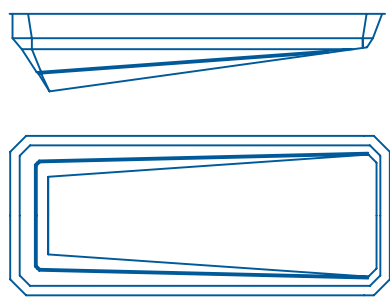

**EVASION**  
10.00 x 4.20 m  
Prof. 2.10/0.85 m

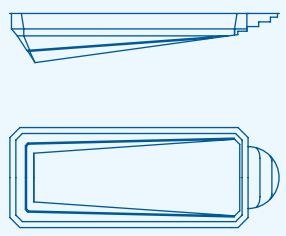

**ROMAINE**  
11.40 x 4.20 m  
Prof. 2.10/0.85 m

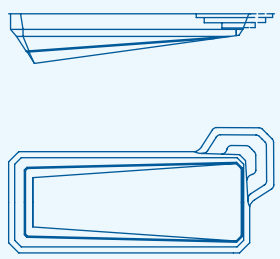

**PRIVILEGE**  
11.40 x 5.20 m  
Prof. 2.10/0.85 m

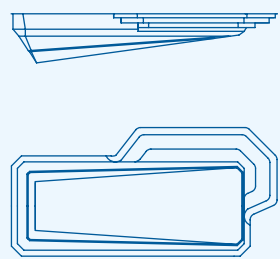

**PALACE**  
11.00 x 5.40 m  
Prof. 2.10/0.85 m

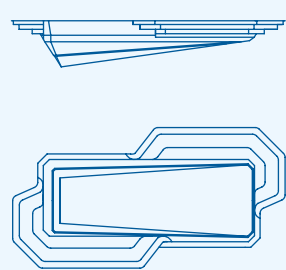

**PRESTIGE**  
12.0 x 6.60 m  
Prof. 2.10/0.85 m