



LED Outdoor Lighting

Westgate's full line of LED Outdoor lighting products is designed using high performance 5th generation COB technology and carries a industry first, full 7-year warranty.

LWP2

A1

LED FULL CUTOFF WALL PACKS

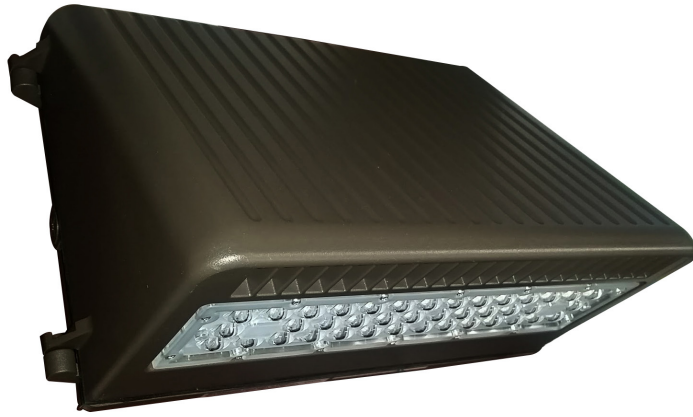

TECHNICAL SPECIFICATIONS:

- :: Full cutoff, dark sky compliant
- :: Die-cast aluminum with powder coat finish (Dark Bronze)
- :: Philips Lumileds Lexeon 3030 high flux LED
- :: Polycarbonate Optic Lens
- :: 120~277V
- :: Includes mounting hardware
- :: Redesigned for high-performance LED
- :: CRI: >80
- :: Power Factor: 95%
- :: Operating Temp: -4°F to 104°F
- :: 70,000 hour rated life
- :: 7-year warranty
- :: Suitable for Wet Locations, IP54

APPLICATIONS:

- :: Ideal for general site lighting, alleys, loading docks, doorway, pathway and parking areas.
- :: Replace existing HID flood lights/ wall packs
- :: Great for use with motion sensors or other instant on/off controls

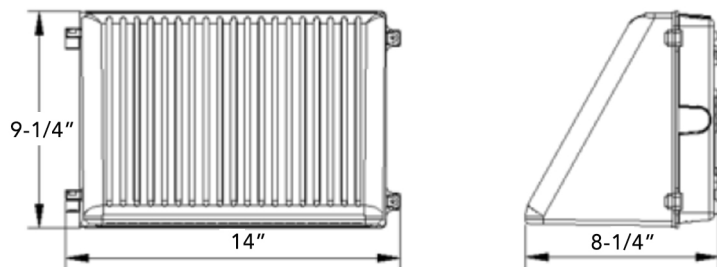

LED FULL CUTOFF WALL PACK

CATALOG NO.	WATTS	LUMENS	COLOR TEMP	REPLACEMENT RANGE	DIMENSIONS
LWP2-50-CW	50W	5700LM	5000K	175~250 MH	14" (w) x 9-1/4" (H) x 8-1/4" (D)
LWP2-50-WW	50W	5600LM	3000K	175~250 MH	
LWP2-80-CW	80W	9100LM	5000K	320~400 MH	
LWP2-80-WW	80W	8700LM	3000K	320~400 MH	

LWA



12W, 20W, 30W, 50W
Available in white

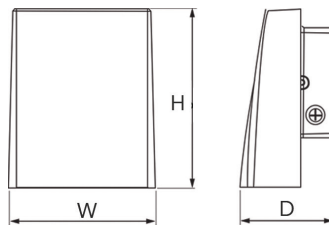

TECHNICAL SPECIFICATIONS:

- :: Full cutoff, dark sky compliant
- :: Die-cast aluminum with powder coat finish (Dark Bronze or White)
- :: Philips Lumileds Lexeon 3030 high flux LED
- :: Polycarbonate Optic Lens
- :: 120~277V
- :: CRI: >80
- :: Power Factor: 95%
- :: Operating Temp: -4°F to 104°F
- :: 70,000 hour rated life
- :: 7-year warranty
- :: Suitable for Wet Locations, IP54

APPLICATIONS:

- :: Ideal for general site lighting, alleys, loading docks, doorway, pathway and parking areas.
- :: Replace existing HID flood lights/ wall packs
- :: Great for use with motion sensors or other instant on/off controls



LED CUTOFF & ADJUSTABLE WALL PACK

CATALOG NO.		WATTS	LUMENS	COLOR TEMP	REPLACEMENT RANGE	DIMENSIONS
BRONZE	WHITE					
LWA-12-WW	LWA-12-WW-WH	12W	1100LM	3000K	50~70 MH	5" (w) x 6" (H) x 4" (D)
LWA-12-CW	LWA-12-CW-WH	12W	1200LM	5000K	50~70 MH	
LWA-20-WW	LWA-20-WW-WH	20W	2000LM	3000K	70~100 MH	8" (w) x 9" (H) x 4.5" (D)
LWA-20-CW	LWA-20-CW-WH	20W	2200LM	5000K	70~100 MH	
LWA-30-WW	LWA-30-WW-WH	30W	3000LM	3000K	100~125 MH	
LWA-30-CW	LWA-30-CW-WH	30W	3200LM	5000K	100~125 MH	
LWA-50-WW	LWA-50-WW-WH	50W	4900LM	3000K	150~200 MH	11" (w) x 13" (H) x 6" (D)
LWA-50-CW	LWA-50-CW-WH	50W	5200LM	5000K	150~200 MH	
LWA-80-WW	-	80W	8800LM	3000K	200~300 MH	
LWA-80-CW	-	80W	9000LM	5000K	200~300 MH	
LWA-120-WW	-	120W	13700LM	3000K	300~400 MH	
LWA-120-CW	-	120W	13700LM	5000K	300~400 MH	

LWA-KNU



1/2" knuckle adaptor with back plate and screws, for 20W and 30W only

WML2

A3

LED NON-CUTOFF WALL PACKS SECOND GENERATION



Bottom LED array ensures seamless coverage in proximity of the fixture

TECHNICAL SPECIFICATIONS:

- :: Die-cast aluminum housing with powder coat finish (Dark Bronze)
- :: Same footprint as traditional HID wall packs
- :: Polycarbonate Optic Lens
- :: Includes mounting hardware
- :: Four 1/2" hubs: 1 top, 1 on each side, 1 rear
- :: Chip: Philips Lumileds LEDs
- :: CRI: >70
- :: Power Factor: 95%
- :: Operating Temp: -4°F to 104°F
- :: 50,000 hour rated life
- :: 5-year warranty
- :: Suitable for Wet Locations, IP65

APPLICATIONS:

- :: Ideal for general site lighting, alleys, loading docks, doorway, pathway and parking areas



LED NON-CUTOFF WALL PACKS SECOND GENERATION

CATALOG NO.	WATTS	LUMENS/WATT	LUMENS	COLOR TEMP	REPLACEMENT RANGE	DIMENSIONS
WML2-28W-50K-HL-SM	28W	121	3400LM	5000K	100~150 MH	10"(W) x 5-3/4"(H) x 5-1/2"(D)
WML2-28W-40K-HL-SM	28W	121	3400LM	4000K	100~150 MH	
WML2-28W-30K-HL-SM	28W	121	3400LM	3000K	100~150 MH	
WML2-50W-50K-SM	50W	112	5600LM	5000K	100~200 MH	
WML2-50W-40K-SM	50W	112	5600LM	4000K	100~200 MH	14-1/4"(W) x 9-1/4"(H) x 7-3/8"(D)
WML2-50W-30K-SM	50W	112	5600LM	3000K	100~200 MH	
WML2-50W-50K-HL	48W	135	6500LM	5000K	175~250 MH	
WML2-50W-40K-HL	48W	135	6500LM	4000K	175~250 MH	
WML2-50W-30K-HL	48W	135	6500LM	3000K	175~250 MH	18-1/2"(W) x 9"(H) x 8-1/2"(D)
WML2-80W-50K-HL	80W	126	10100LM	5000K	250~400 MH	
WML2-80W-40K-HL	80W	126	10100LM	4000K	250~400 MH	
WML2-80W-30K-HL	80W	126	10100LM	3000K	250~400 MH	
WML2-120W-50K-HL-LG	120W	132	15900LM	5000K	250~450 MH	18-1/2"(W) x 9"(H) x 8-1/2"(D)
WML2-120W-40K-HL-LG	120W	132	15900LM	4000K	250~450 MH	
WML2-120W-30K-HL-LG	120W	132	15900LM	3000K	250~450 MH	
WML2-150W-50K-LG	150W	120	18000LM	5000K	250~450 MH	
WML2-150W-40K-LG	150W	120	18000LM	4000K	250~450 MH	18-1/2"(W) x 9"(H) x 8-1/2"(D)
WML2-150W-30K-LG	150W	120	18000LM	3000K	250~450 MH	

WML

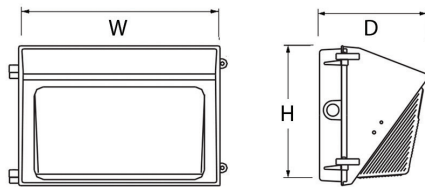

TECHNICAL SPECIFICATIONS:

- :: Die-cast aluminum with powder coat finish (Dark Bronze), optimized for LED
- :: Same footprint as traditional HID wall packs
- :: Prismatic borosilicate glass lens
- :: Four 1/2" hubs: 1 top, 1 on each side, 1 rear
- :: Chip: Philips Lumileds LEDs
- :: CRI: >80
- :: Power Factor: 95%
- :: Operating Temp: -4°F to 104°F
- :: 70,000 hour rated life
- :: 7-year warranty
- :: Suitable for Wet Locations, IP54

APPLICATIONS:

- :: Ideal for general site lighting, alleys, loading docks, doorway, pathway and parking areas.
- :: Replace existing HID wall packs
- :: Great for use with photocell



A4

LED NON-CUTOFF WALL PACKS (MEDIUM & LARGE)

LED NON-CUTOFF WALL PACKS

CATALOG NO.	WATTS	LUMENS	COLOR TEMP	REPLACEMENT RANGE	DIMENSIONS
WML-30CW-SM	30W	3300LM	5000K	100~150 MH	8-1/2"(W) x 9"(H) x 7-1/4"(D)
WML-30NW-SM	30W	3240LM	4000K	100~150 MH	
WML-30WW-SM	30W	2400LM	3000K	100~150 MH	
WML-50CW	50W	5400LM	5000K	100~200 MH	13-1/4"(W) x 9-1/2"(H) x 7-1/2"(D)
WML-50NW	50W	5300LM	4000K	100~200 MH	
WML-50WW	50W	3840LM	3000K	100~200 MH	
WML-60CW	60W	6600LM	5000K	175~250 MH	
WML-60NW	60W	6400LM	4000K	175~250 MH	
WML-60WW	60W	4840LM	3000K	175~250 MH	
WML-80CW	80W	9100LM	5000K	250~400 MH	18-1/4"(W) x 9"(H) x 9-1/4"(D)
WML-80NW	80W	9000LM	4000K	250~400 MH	
WML-80WW	80W	7040LM	3000K	250~400 MH	
WML-120CW-LG	120W	12000LM	5000K	250~450 MH	18-1/4"(W) x 9"(H) x 9-1/4"(D)
WML-120NW-LG	120W	12000LM	4000K	250~450 MH	
WML-120WW-LG	120W	12000LM	3000K	250~450 MH	

LW360

A5

LED ROTATABLE WALL PACKS



LW360-60W
LW360-80W



LW360-25W
LW360-40W

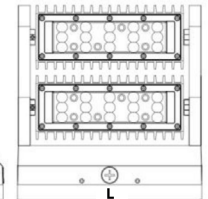
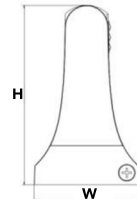
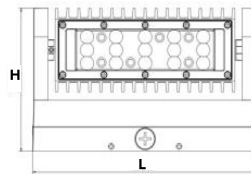

TECHNICAL SPECIFICATIONS:

- :: Rotatable heads (both in 60W & 80W) with set screw
- :: Die-cast aluminum housing with powder coat finish (Dark Bronze)
- :: TIR optic lens - TYPE II
- :: Voltage: 120~277V
- :: Includes mounting hardware
- :: Three 1/2" threaded hubs: 1 top, 1 on each side
- :: Chip: Philips Lumileds LEDs
- :: CRI: >70
- :: Power Factor: 95%
- :: Operating Temp:-4°F to 104°F
- :: 50,000 hour rated life
- :: 7-year warranty
- :: Suitable for Wet Locations, IP65

APPLICATIONS:

- :: Ideal for general site lighting, alleys, loading docks, doorway, pathway and parking areas



LED ROTATABLE WALL PACKS

CATALOG NO.	WATTS	LUMENS	COLOR TEMP	BEAM ANGLE	NO. OF LIGHT HEADS	REPLACEMENT RANGE	DIMENSIONS
LW360-25W-30K	25W	3375LM	3000K	60°	1	100~150 MH	5.4"(H) x 5.2"(W) x 9.1"(L)
LW360-25W-50K	25W	3375LM	5000K	60°	1	100~150 MH	
LW360-40W-30K	40W	5400LM	3000K	60°	1	100~200 MH	
LW360-40W-50K	40W	5400LM	5000K	60°	1	100~200 MH	
LW360-60W-30K	60W	8100LM	3000K	60°	2	200~300 MH	8.8"(H) x 5.2"(W) x 9.1"(L)
LW360-60W-50K	60W	8100LM	5000K	60°	2	200~300 MH	
LW360-80W-30K	80W	10800LM	3000K	60°	2	250~400 MH	
LW360-80W-50K	80W	10800LM	5000K	60°	2	250~400 MH	

VTU
UNIVERSAL
ALL MOUNTING OPTIONS IN ONE BOX

120~277V

TECHNICAL SPECIFICATIONS:

- :: Silver powder-coated finish
- :: Die-cast housing and guard
- :: Frosted borosilicate glass
- :: Voltage: 120~277V
- :: Wattage: 12W & 20W
- :: Lumens: 900LM & 1785LM
- :: LED Chip: LUMINUS XNOVA COB
- :: Beam Angle: 175°
- :: CRI: >80
- :: Junction box can be replaced with standard round weatherproof boxes.
- :: Power Factor: 95%
- :: UL listed
- :: NEMA 3R, IP65

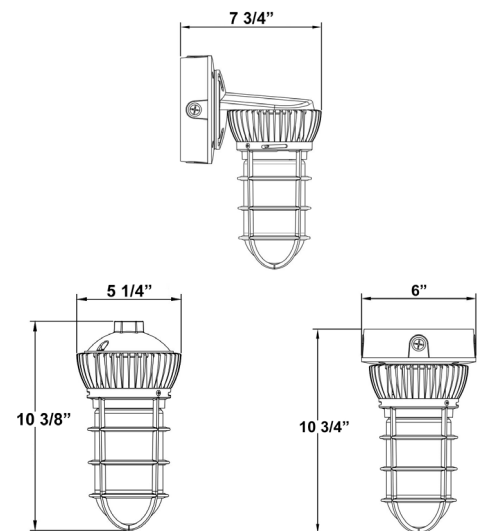
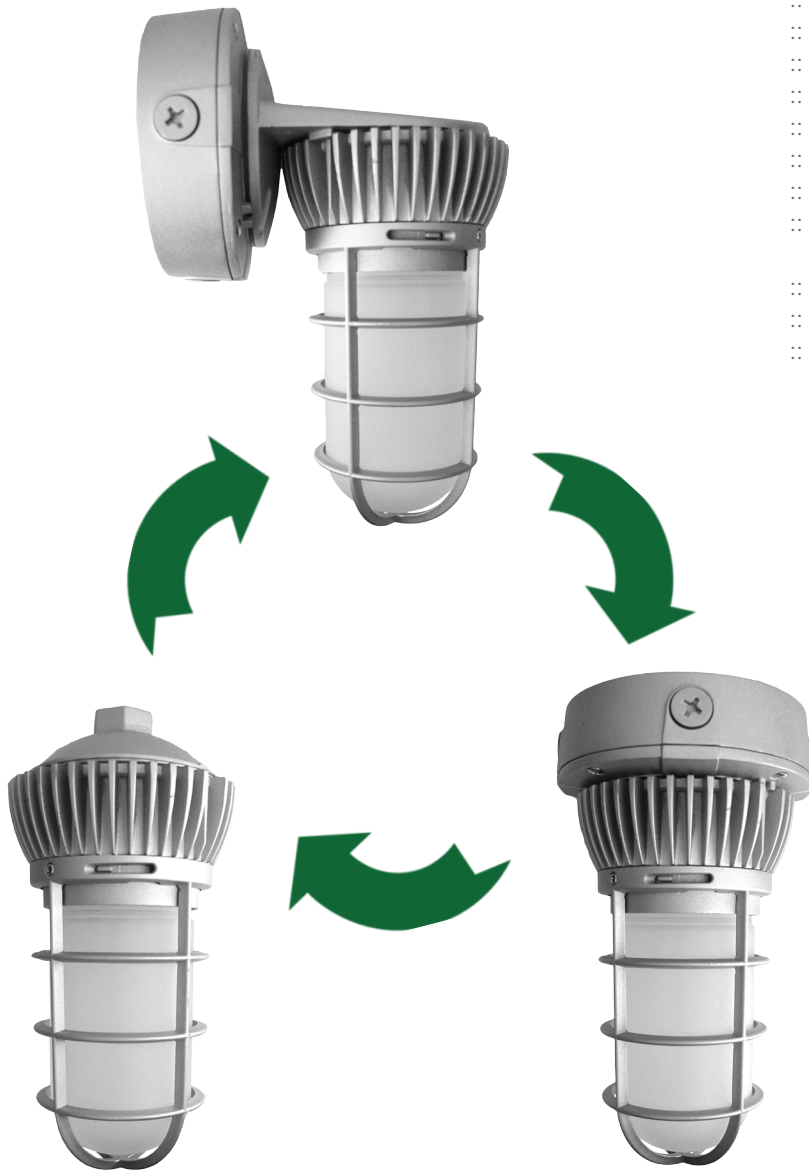

A6

LED VAPOR LIGHTS

LED UNIVERSAL VAPOR LIGHTS

CATALOG NO.	WATTS	LUMENS	COLOR TEMP	DIMENSIONS
VTU-12W-30K	12W	900LM	3000K	10 3/4"(H)
VTU-12W-50K	12W	900LM	5000K	
VTU-20W-30K	20W	1785LM	3000K	
VTU-20W-50K	20W	1785LM	5000K	

LSW

A7

LED NON-CUTOFF WALL PACKS



TECHNICAL SPECIFICATIONS:

- :: Back plate: Die-cast aluminum with mounting/gasket installed. Threaded 1/2" HUB provided
- :: Front: Polycarbonate lens and housing
- :: Includes pre-wired photo electric control, prewired to 120 volts
- :: 120~277V
- :: Non-cutoff optics ideal for maximum light distribution
- :: Vandal resistant housing ideal for exposed areas
- :: CRI: >80
- :: Power Factor: 95%
- :: Operating Temp: -4°F to 104°F
- :: 70,000 hour rated life
- :: 7-year warranty
- :: Suitable for Wet Locations, IP54

APPLICATIONS:

- :: Ideal for general site lighting, loading docks, doorway, pathway and parking areas.



1/2" hub located on the back and bottom of housing for mounting versatility

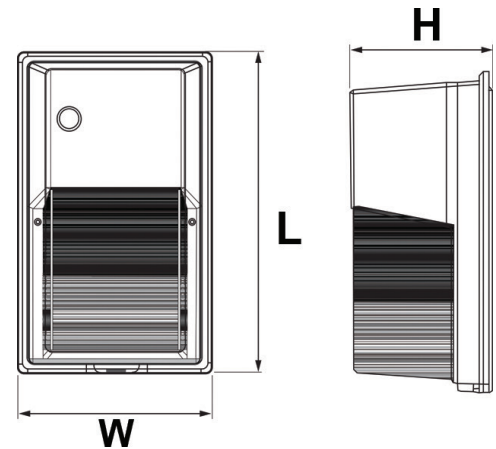

LED NON-CUTOFF WALL PACKS WITH PHOTOCELL

CATALOG NO.	WATTS	LUMENS	COLOR TEMP	REPLACEMENT RANGE	DIMENSIONS
LSW-22CW-PC	20W	2100LM	5000K	50~100 MH	11"(L) x 6-3/4"(W) x 5-1/8"(H)
LSW-22WW-PC	20W	2000LM	3500K	50~100 MH	
LSW-30CW-PC	30W	3000LM	5000K	100~125 MH	
LSW-30WW-PC	30W	2800LM	3500K	100~125 MH	

LTW



Redesigned housing for LED

TECHNICAL SPECIFICATIONS:

- :: Die-cast aluminum with powder coat finish (Dark Bronze), optimized for LED
- :: Polycarbonate front housing and prismatic lens provide vandal resistance
- :: Four 1/2" HUBS: 1 top, 1 on each side, 1 rear
- :: Chip: Philips Lumileds LEDs
- :: CRI: >80
- :: Power Factor: 95%
- :: Operating Temp:-4°F to 104°F
- :: 70,000 hour rated life
- :: 7-year warranty
- :: Suitable for Wet Locations, IP54

APPLICATIONS:

- :: Ideal for general site lighting, alleys, loading docks, doorway, pathway and parking areas.
- :: Replace existing HID flood lights/ wall packs
- :: Great for use with photocell

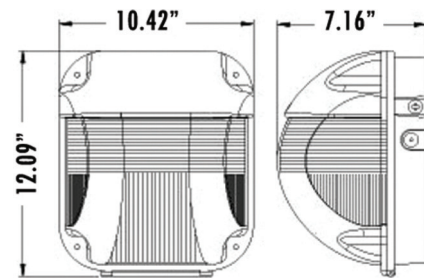

LED SEMI-CUTOFF VANDAL-PROOF WALL PACK

CATALOG NO.	WATTS	LUMENS	COLOR TEMP	REPLACEMENT RANGE
LTW-50-CW	50W	4400LM	5000K	150~250 MH
LTW-50-WW	50W	4400LM	3000K	150~250 MH

LF3-KN

A9

LF3 SERIES



LF3-15-KN



LF3-30-KN



LF3-50-KN

Available in White



TECHNICAL SPECIFICATIONS:

- :: Housing: Die-cast aluminum housing with powder coat finish (Dark Bronze or White)
- :: Philips Lumileds Lexeon 3030 high flux LED
- :: TIR optic lens - TYPE II
- :: 13" #18 AWG stranded wires
- :: Voltage: 120~277V; 60Hz AC
- :: Operating Temp: -4°F to 104°F
- :: Up to 110 lumens per watt
- :: CRI: 82~84
- :: Beam Angle: 104°
- :: 70,000 hour rated life
- :: 7-year warranty
- :: Suitable for Wet Locations, IP65
- :: Solid state lighting technology for long life, no maintenance needed and high-efficiency

APPLICATIONS:

- :: Ideal for general site lighting, alleys, loading docks, doorway, pathway and parking areas.
- :: Replace existing HID flood lights/ wall packs
- :: Great for use with motion sensors or other instant on/off controls

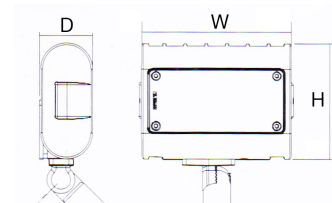

LF3 FLOOD LIGHT SERIES WITH 1/2" KNUCKLE

CATALOG NO.		WATTS	LUMENS	COLOR TEMP	REPLACEMENT RANGE	DIMENSIONS
BRONZE	WHITE					
LF3-15CW-KN	LF3-WH-15CW-KN	15W	1600LM	5000K	50~70 MH	4-1/4"(W) x 3-1/7"(H) x 1-1/2"(D) x 2-1/3"(K)
LF3-15WW-KN	LF3-WH-15WW-KN	15W	1500LM	3000K	50~70 MH	
LF3-30CW-KN	LF3-WH-30CW-KN	30W	3500LM	5000K	70~100 MH	6-3/4"(W) x 5-1/8"(H) x 1-3/5"(D) x 3-2/3"(K)
LF3-30WW-KN	LF3-WH-30WW-KN	30W	3400LM	3000K	70~100 MH	
LF3-50CW-KN	LF3-WH-50CW-KN	50W	6000LM	5000K	100~175 MH	8-1/2"(W) x 6"(H) x 1-4/5"(D) x 3-2/3"(K)
LF3-50WW-KN	LF3-WH-50WW-KN	50W	5600LM	3000K	100~175 MH	

LF3-TR



LF3-15-TR



LF3-30-TR



LF3-50-TR



1/2" strain-relief connector for TR series up to 50W

TECHNICAL SPECIFICATIONS:

- :: Housing: Die-cast aluminum housing with powder coat finish (Dark Bronze or White)
- :: Philips Lumileds Lexeon 3030 high flux LED
- :: TIR optic lens - TYPE II
- :: 18" SJTW 18/3 AWG cable
- :: Voltage: 120~277V; 60Hz AC
- :: Operating Temp: -4°F to 104°F
- :: Up to 110 lumens per watt
- :: CRI: 82~84
- :: Beam Angle: 104°
- :: 70,000 hour rated life
- :: 7-year warranty
- :: Suitable for Wet Locations, IP65
- :: Solid state lighting technology for long life, no maintenance needed and high-efficiency

APPLICATIONS:

- :: Ideal for general site lighting, alleys, loading docks, doorway, pathway and parking areas.
- :: Replace existing HID flood lights/ wall packs
- :: Great for use with motion sensors or other instant on/off controls

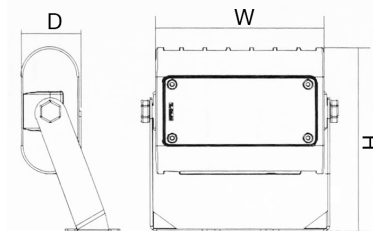

LF3 FLOOD LIGHT SERIES WITH TRUNNION

CATALOG NO.		WATTS	LUMENS	COLOR TEMP	REPLACEMENT RANGE	DIMENSIONS
BRONZE	WHITE					
LF3-15CW-TR	-	15W	1600LM	5000K	50~70 MH	4-1/4"(W) x 3-1/7"(H) x 1-1/2"(D)
LF3-15WW-TR	-	15W	1500LM	3000K	50~70 MH	4-1/4"(W) x 3-1/7"(H) x 1-1/2"(D)
LF3-30CW-TR	-	30W	3500LM	5000K	70~100 MH	6-3/4"(W) x 5-1/8"(H) x 1-3/5"(D)
LF3-30WW-TR	LF3-WH-30WW-TR	30W	3400LM	3000K	70~100 MH	6-3/4"(W) x 5-1/8"(H) x 1-3/5"(D)
LF3-50CW-TR	-	50W	6000LM	5000K	100~175 MH	8-1/2"(W) x 6"(H) x 1-4/5"(D)
LF3-50WW-TR	-	50W	5600LM	3000K	100~175 MH	8-1/2"(W) x 6"(H) x 1-4/5"(D)
LF-THREAD	1/2" hub adaptor for fixtures with trunnion bracket (on fixtures up to 50W)					

LF3-TR

A11

LF3 SERIES



LF3-80-TR
LF3-100-TR
LF3-150-TR



LF3-PK
Photocell Kit for LF3

TECHNICAL SPECIFICATIONS:

- :: Housing: Die-cast aluminum housing with powder coat finish (Dark Bronze or White)
- :: Philips Lumileds Lexeon 3030 high flux LED
- :: TIR optic lens - TYPE II (TYPE III & IV see page A45)
- :: 18" SJTW 18/3 AWG cable
- :: Voltage: 120~277V; 60Hz AC
- :: Operating Temp:-4°F to 104°F
- :: Up to 110 lumens per watt
- :: CRI: 82~84
- :: Beam Angle: 104°
- :: 70,000 hour rated life
- :: 7-year warranty
- :: Suitable for Wet Locations, IP65
- :: Solid state lighting technology for long life, no maintenance needed and high-efficiency
- :: 1/2" HUB for photocell or sensor installation

APPLICATIONS:

- :: Ideal for general site lighting, alleys, loading docks, doorway, pathway and parking areas.
- :: Replace existing HID flood lights/ wall packs
- :: Great for use with motion sensors or other instant on/off controls

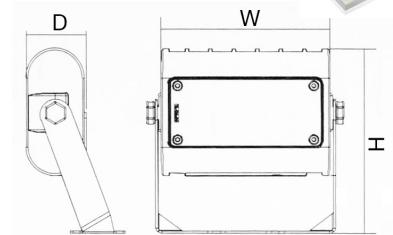

LF3 FLOOD LIGHT SERIES WITH TRUNNION

CATALOG NO.	WATTS	LUMENS	COLOR TEMP	REPLACEMENT RANGE	DIMENSIONS
LF3-80CW-TR	80W	9800LM	5000K	150~250 MH	12-1/2"(W) x 12-1/2"(H) x 2-1/2"(D)
LF3-80WW-TR	80W	9600LM	3000K	150~250 MH	
LF3-100CW-TR	100W	11500LM	5000K	200~400 MH	
LF3-100WW-TR	100W	10000LM	3000K	200~400 MH	
LF3-150CW-TR	150W	18000LM	5000K	320~400 MH	
LF3-150WW-TR	150W	15500LM	3000K	320~400 MH	
LF3-PK	Photocell Kit for LF3 series, Field installed				

LF3-TR



LF3-220-TR
LF3-300-TR

TECHNICAL SPECIFICATIONS:

- :: Housing: Die-cast aluminum housing with powder coat finish (Dark Bronze or White)
- :: Philips Lumileds Lexeon 3030 high flux LED
- :: TIR optic lens - TYPE II (TYPE III & IV see page A45)
- :: 18" SJTW 18/3 AWG cable
- :: Voltage: 120~277V; 60Hz AC
- :: Operating Temp:-4°F to 104°F
- :: Up to 110 lumens per watt
- :: CRI: 82~84
- :: Beam Angle: 104°
- :: 70,000 hour rated life
- :: 7-year warranty
- :: Suitable for Wet Locations, IP65
- :: Solid state lighting technology for long life, no maintenance needed and high-efficiency
- :: 1/2" HUB for photocell or sensor installation

APPLICATIONS:

- :: Ideal for general site lighting, alleys, loading docks, doorway, pathway and parking areas.
- :: Replace existing HID flood lights/ wall packs
- :: Great for use with motion sensors or other instant on/off controls

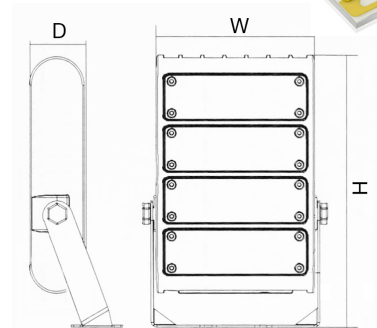

LF3 FLOOD LIGHT SERIES WITH TRUNNION

CATALOG NO.	WATTS	LUMENS	COLOR TEMP	REPLACEMENT RANGE	DIMENSIONS
LF3-220CW-TR	220W	25000LM	5000K	350~400 MH	12-1/2"(W) x 20"(H) x 2-3/4"(D)
LF3-220WW-TR	220W	22000LM	3000K	350~400 MH	
LF3-300CW-TR	300W	33000LM	5000K	1000 MH	
LF3-300WW-TR	300W	30800LM	3000K	1000 MH	
LF3-PK	Photocell Kit for LF3 series, Field installed				

LF3-SF



LF3-PK
Photocell Kit for LF3

A13

LF3 SERIES

TECHNICAL SPECIFICATIONS:

- :: Housing: Die-cast aluminum housing with powder coat finish (Dark Bronze)
- :: Installed slip fitter for mounting on mounting tubes (tenon) of max 2-3/4" O.D.
- :: Voltage: 120~277V; 60Hz AC
- :: 0~10V dimming (except 80W)
- :: TIR optic lens - TYPE II (TYPE III & IV see page A45)
- :: 13" #18 AWG stranded wires
- :: Power Factor: .9~.97
- :: Operating Temp: -4°F to 104°F
- :: Up to 110 lumens per watt
- :: CRI: 82~84
- :: Beam Angle: 104°
- :: 70,000 hour rated life
- :: 7-year warranty
- :: Suitable for Wet Locations, IP65
- :: 1/2" HUB for photocell or sensor installation

APPLICATIONS:

- :: Ideal for general site lighting, alleys, loading docks, doorway, pathway and parking areas.
- :: Replace existing HID flood lights/ wall packs
- :: Great for use with motion sensors or other instant on/off controls



4" square pole adaptor with 2-3/8" tenon (see accessories) page A41

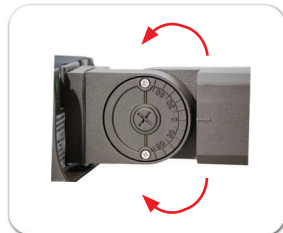

Slip fitter adjust 90° above and below center. Fits on up to 2-3/4" O.D. tenons.

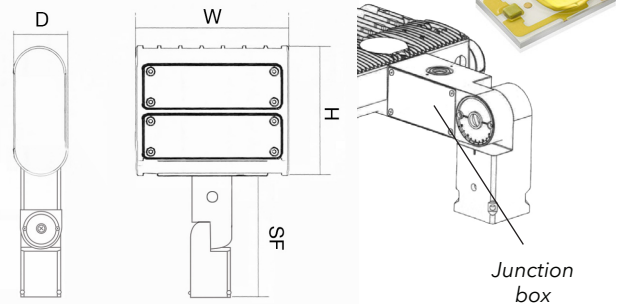

LF3 FLOOD LIGHT SERIES WITH SLIP FITTER

CATALOG NO.	WATTS	LUMENS	COLOR TEMP	REPLACEMENT RANGE	DIMENSIONS
LF3-80CW-SF	80W	9800LM	5000K	150~250 MH	12-1/2"(W) x 9-3/4"(H) x 2-1/2"(D) x 12-1/4"(SF)
LF3-80WW-SF	80W	9600LM	3000K	150~250 MH	
LF3-100CW-SF	100W	11500LM	5000K	200~400 MH	
LF3-100WW-SF	100W	10000LM	3000K	200~400 MH	
LF3-150CW-SF	150W	18000LM	5000K	320~400 MH	
LF3-150WW-SF	150W	15500LM	3000K	320~400 MH	
LF3-PK	LF3-PK Photocell Kit for LF3 80W, 100W & 150W Field installed				

LF3-SF



TECHNICAL SPECIFICATIONS:

- :: Housing: Die-cast aluminum housing with powder coat finish (Dark Bronze)
- :: Installed slip fitter for mounting on mounting tubes (tenon) of max 2-3/4" O.D.
- :: Voltage: 120~277V; 60Hz AC
- :: 0~10V dimming (except 80W)
- :: TIR optic lens - TYPE II (TYPE III & IV see page A45)
- :: 13" #18 AWG stranded wires
- :: Power Factor: .9~.97
- :: Operating Temp: -4°F to 104°F
- :: Up to 110 lumens per watt
- :: CRI: 82~84
- :: Beam Angle: 104°
- :: 70,000 hour rated life
- :: 7-year warranty
- :: Suitable for Wet Locations, IP65
- :: 1/2" HUB for photocell or sensor installation

APPLICATIONS:

- :: Ideal for general site lighting, alleys, loading docks, doorway, pathway and parking areas.
- :: Replace existing HID flood lights/ wall packs
- :: Great for use with motion sensors or other instant on/off controls



4" square pole adaptor with 2-3/8" tenon (see accessories) page A41

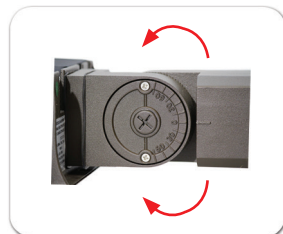

Slip fitter adjust 90° above and below center. Fits on up to 2-3/4" O.D. tenons.

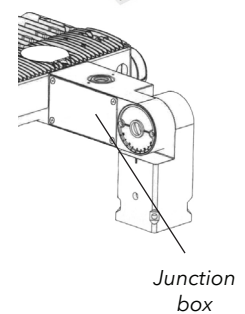
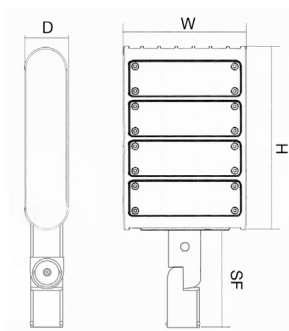

LF3 FLOOD LIGHT SERIES WITH SLIP FITTER

CATALOG NO.	WATTS	LUMENS	COLOR TEMP	REPLACEMENT RANGE	DIMENSIONS
LF3-220CW-SF	220W	25000LM	5000K	350~400 MH	12-1/2"(W) x 17"(H) x 2-3/4"(D) x 12-1/4"(SF)
LF3-220WW-SF	220W	22000LM	3000K	350~400 MH	
LF3-300CW-SF	300W	33000LM	5000K	1000 MH	
LF3-300WW-SF	300W	30800LM	3000K	1000 MH	

LF3 WITH MOUNTING OPTIONS



LF3-220-YK
LF3-300-YK

LF3-80-YK
LF3-100-YK
LF3-150-YK

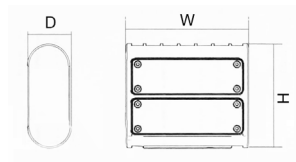
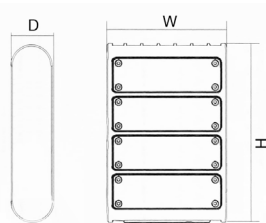

TECHNICAL SPECIFICATIONS:

- :: Mounting yoke included in the package - not mounted
- :: Housing: Die-cast aluminum housing with powder coat finish (Dark Bronze)
- :: Voltage: 120~277V; 60Hz AC
- :: Cord type:
- :: 0~10V dimming (except 80W)
- :: TIR optic lens - TYPE II (TYPE III & IV see page A45)
- :: 6" SJTW 18/3 AWG cable
- :: Power Factor: .9~.97
- :: Operating Temp: -4°F to 104°F
- :: Up to 110 lumens per watt
- :: CRI: 82~84
- :: 70,000 hour rated life
- :: Suitable for Wet Locations, IP65

APPLICATIONS:

- :: Ideal for general site lighting, alleys, loading docks, doorway, pathway and parking areas.
- :: Great for use with motion sensors or other instant on/off controls



LF3 FLOOD LIGHT SERIES WITHOUT MOUNTING (120V-277V)

CATALOG NO.	WATTS	LUMENS	COLOR TEMP	REPLACEMENT RANGE	DIMENSIONS
LF3-80CW-YK	80W	9800LM	5000K	150~250 MH	12-1/2"(W) x 9-3/4"(H) x 2-1/2"(D)
LF3-80WW-YK	80W	9600LM	3000K	150~250 MH	
LF3-100CW-YK	100W	11500LM	5000K	200~400 MH	
LF3-100WW-YK	100W	10000LM	3000K	200~400 MH	
LF3-150CW-YK	150W	18000LM	5000K	320~400 MH	
LF3-150WW-YK	150W	15500LM	3000K	320~400 MH	12-1/2"(W) x 17"(H) x 2-3/4"(D)
LF3-220CW-YK	220W	25000LM	5000K	350~400 MH	
LF3-220WW-YK	220W	22000LM	3000K	350~400 MH	
LF3-300CW-YK	300W	33000LM	5000K	1000 MH	
LF3-300WW-YK	300W	30800LM	3000K	1000 MH	

LF3-PK

Photocell Kit for LF3 series, Field installed

Optional mounts - Field installed, must be ordered separately



LF3-EXTARM
Extension arm
(4" wide to fit 4" pole)



LF3-STR
Street light arm
(6" long to fit 2"-2-1/2" pipe)



LF3-PK
Photocell Kit for
LF3 80W, 100W & 150W
Field installed



LF3-YOK
Included in the box
Not used when other mounting options ordered

Ordering example: LF3-220CW-YK + LF3-EXTARM

LF3-480V



LF3-220-480V-YK
LF3-300-480V-YK



LF3-150-480V-YK

TECHNICAL SPECIFICATIONS:

- :: Mounting yoke included in the package - not mounted
- :: Housing: Die-cast aluminum housing with powder coat finish (Dark Bronze)
- :: Voltage: 347~480V
- :: 0~10V dimming (except 80W)
- :: TIR optic lens - TYPE II (TYPE III & IV see page A45)
- :: 6" SJTW 18/3 AWG cable
- :: Power Factor: .9~.97
- :: Operating Temp: -4°F to 104°F
- :: Up to 110 lumens per watt
- :: CRI: 82~84
- :: 70,000 hour rated life
- :: Suitable for Wet Locations, IP65

APPLICATIONS:

- :: Ideal for general site lighting, alleys, loading docks, doorway, pathway and parking areas.
- :: Great for use with motion sensors or other instant on/off controls

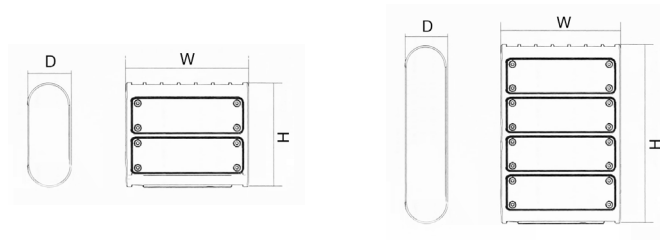

LF3 FLOOD LIGHT SERIES WITH MOUNTING OPTIONS (347V-480V)

CATALOG NO.	WATTS	LUMENS	COLOR TEMP	REPLACEMENT RANGE	DIMENSIONS
LF3-150CW-480V-YK	150W	18000LM	5000K	320~400 MH	12-1/2"(W) x 9-3/4"(H) x 2-1/2"(D)
LF3-220CW-480V-YK	220W	25000LM	5000K	350~400 MH	12-1/2"(W) x 17"(H) x 2-3/4"(D)
LF3-300CW-480V-YK	300W	34017LM	5000K	1000 MH	
LF3-PK	Photocell Kit for LF3 series, Field installed				

Optional mounts - Field installed, must be ordered separately

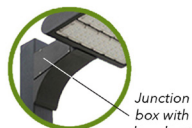

LF3-EXTARM
Extension arm
(4" wide to fit 4" pole)



LF3-STR
Street light arm
(6" long to fit 2"~2-1/2" pipe)



LF3-PK
Photocell Kit for
LF3 80W, 100W & 150W
field installed



LF3-YOK
Included in the box
Not used when other mounting options ordered

Ordering example: LF3-220CW-480V-YK + LF3-EXTARM

LF4-KN

A17

LF4 SERIES



LF4-12W-KN

LF4-30W-KN



BACK VIEW

LF4-50W-KN

TECHNICAL SPECIFICATIONS:

- :: Housing: Die-cast aluminum housing with powder coat finish (Dark Bronze)
- :: Voltage: 120~277V; 60Hz AC
- :: TIR optic lens - TYPE II
- :: 13" #18 AWG stranded wires
- :: Power Factor: .9~.97
- :: Operating Temp: -4°F to 104°F
- :: Up to 110 lumens per watt
- :: CRI: 82~84
- :: 70,000 hour rated life
- :: Suitable for Wet Locations, IP65

APPLICATIONS:

- :: Ideal for general site lighting, alleys, loading docks, doorway, pathway and parking areas.
- :: Great for use with motion sensors or other instant on/off controls

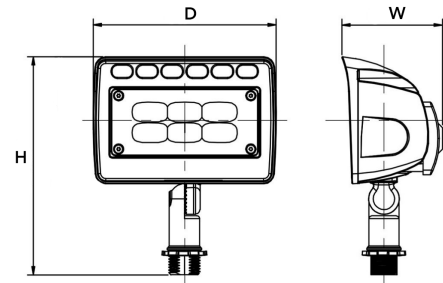

LF4 ARCHITECTURAL SERIES WITH 1/2" ADJUSTABLE KNUCKLE (120V-277V)

CATALOG NO.	WATTS	LUMENS	COLOR TEMP	REPLACEMENT RANGE	DIMENSIONS
LF4-12CW-KN	12W	1300LM	5000K	50~70 MH	5.6"(H) x 4.7"(W) x 2.5"(D)
LF4-12WW-KN	12W	1200LM	3000K	50~70 MH	
LF4-30CW-KN	30W	3300LM	5000K	70~100 MH	4.7"(H) x 6.8"(W) x 3.07"(D)
LF4-30WW-KN	30W	3100LM	3000K	70~100 MH	
LF4-50CW-KN	50W	5600LM	5000K	100~175 MH	9.4"(H) x 8.6"(W) x 3.54"(D)
LF4-50WW-KN	50W	5400LM	3000K	100~175 MH	

LF4-TR



LF4-80W-TR
LF4-100W-TR



LF4-12W-TR



LF4-30W-TR



LF4-150W-TR



LF4-50W-TR

TECHNICAL SPECIFICATIONS:

- :: Housing: Die-cast aluminum housing with powder coat finish (Dark Bronze)
- :: Voltage: 347~480V
- :: 0~10V dimming (except 80W)
- :: TIR optic lens - TYPE II
- :: 18" SJTW 18/3 AWG cable
- :: Power Factor: .9~.97
- :: Operating Temp:-4°F to 104°F
- :: Up to 110 lumens per watt
- :: CRI: 82~84
- :: 70,000 hour rated life
- :: Suitable for Wet Locations, IP65

APPLICATIONS:

- :: Ideal for general site lighting, alleys, loading docks, doorway, pathway and parking areas.
- :: Great for use with motion sensors or other instant on/off controls

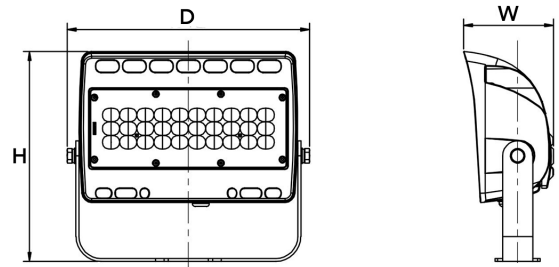

LF4 ARCHITECTURAL SERIES WITH TRUNNION(120V-277V)

CATALOG NO.	WATTS	LUMENS	COLOR TEMP	REPLACEMENT RANGE	DIMENSIONS
LF4-12CW-TR	12W	1300LM	5000K	50~70 MH	4.9"(H) x 4.7"(W) x 2.5"(D)
LF4-12WW-TR	12W	1200LM	3000K	50~70 MH	
LF4-30CW-TR	30W	3300LM	5000K	70~100 MH	7.2"(H) x 6.8"(W) x 3.07"(D)
LF4-30WW-TR	30W	3100LM	5000K	70~100 MH	
LF4-50CW-TR	50W	5600LM	3000K	100~175 MH	8.2"(H) x 8.6"(W) x 3.54"(D)
LF4-50WW-TR	50W	5400LM	5000K	100~175 MH	
LF4-80CW-TR	80W	9500LM	3000K	100~175 MH	16.4"(H) x 10.9"(W) x 8.4"(D)
LF4-80WW-TR	80W	9500LM	5000K	100~175 MH	
LF4-100CW-TR	100W	11200LM	3000K	150~250 MH	
LF4-100WW-TR	100W	11200LM	5000K	150~250 MH	
LF4-150CW-TR	150W	17000LM	3000K	200~400 MH	12.4"(H) x 13.3"(W) x 9.3"(D)
LF4-150WW-TR	150W	17000LM	5000K	200~400 MH	

LF4-SF

A19

LF4 SERIES



LF4-80W-SF
LF4-100W-SF



LF4-150W-SF



BACK VIEW

TECHNICAL SPECIFICATIONS:

- :: Housing: Die-cast aluminum housing with powder coat finish (Dark Bronze)
- :: Voltage: 120~277V; 60Hz AC
- :: 0~10V dimming
- :: TIR optic lens - TYPE II
- :: 13" #18 AWG stranded wires
- :: Power Factor: .9~.97
- :: Operating Temp: -4°F to 104°F
- :: Up to 110 lumens per watt
- :: CRI: 82~84
- :: 70,000 hour rated life
- :: Suitable for Wet Locations, IP65

APPLICATIONS:

- :: Ideal for general site lighting, alleys, loading docks, doorway, pathway and parking areas.
- :: Great for use with motion sensors or other instant on/off controls

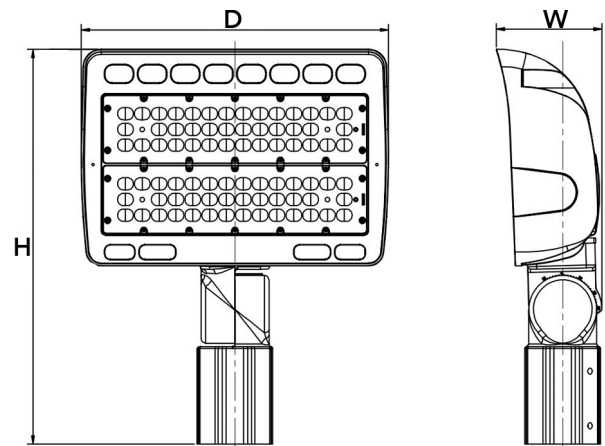

LF4 ARCHITECTURAL SERIES WITH SLIP FITTER (120V-277V)

CATALOG NO.	WATTS	LUMENS	COLOR TEMP	REPLACEMENT RANGE	DIMENSIONS
LF4-80CW-SF	80W	9500LM	5000K	150~250 MH	11.8"(H) x 10.9"(W) x 8.4"(D)
LF4-80WW-SF	80W	9500LM	3000K	150~250 MH	
LF4-100CW-SF	100W	11200LM	5000K	200~400 MH	
LF4-100WW-SF	100W	11200LM	3000K	200~400 MH	
LF4-150CW-SF	150W	17000LM	5000K	320~400 MH	17"(H) x 13.3"(W) x 9.3"(D)
LF4-150WW-SF	150W	17000LM	3000K	320~400 MH	

LF5

380W

120~277V & 480V

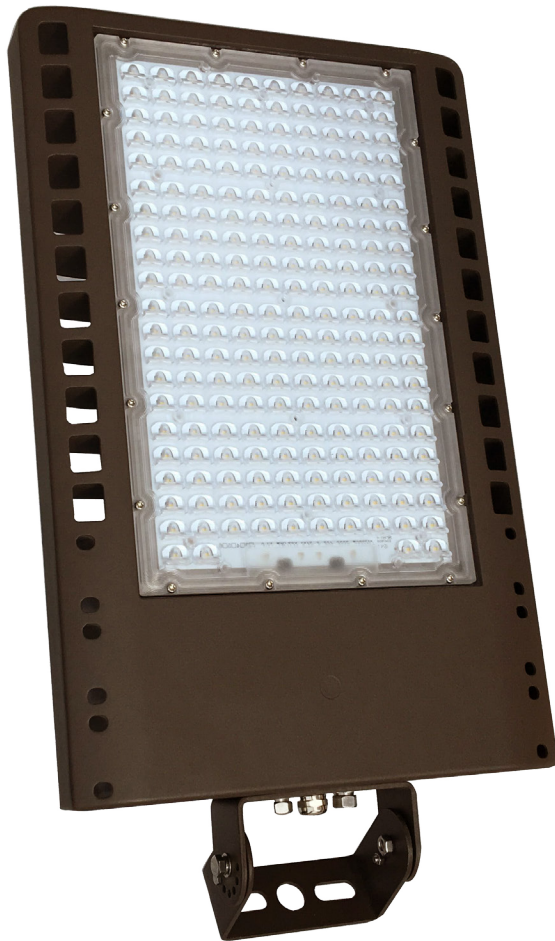

TECHNICAL SPECIFICATIONS:

- :: Housing: Die-cast aluminum housing with powder coat finish (Dark Bronze)
- :: Mounting yoke provided in the package, not installed
- :: Voltage: 120~277V & 347~480V
- :: 0~10V dimming
- :: TIR optic lens - TYPE III (TYPE II & IV by request)
- :: 6" SJTW 18/3 AWG cable
- :: Power Factor: .9~.97
- :: Operating Temp: -4°F to 104°F
- :: Up to 110 lumens per watt
- :: CRI: 82~84
- :: 70,000 hour rated life
- :: Suitable for Wet Locations, IP65

APPLICATIONS:

- :: Ideal for general site lighting, alleys, loading docks, doorway, pathway and parking areas.
- :: Great for use with motion sensors or other instant on/off controls

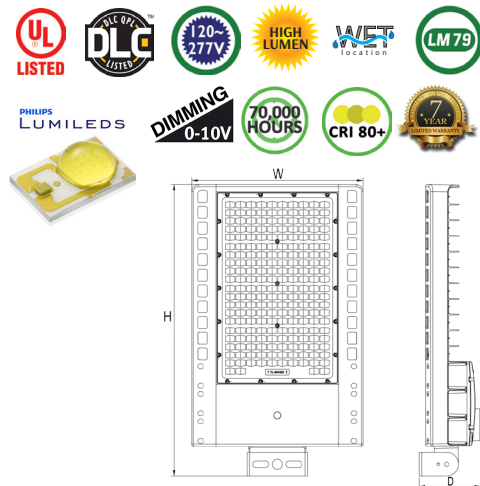

LF5 SERIES WITH MOUNTING OPTIONS

CATALOG NO.	WATTS	LUMENS	COLOR TEMP	REPLACEMENT RANGE	VOLTAGE	DIMENSIONS
LF5-380CW-YK	380W	46000LM	5000K	1000~1200 MH	120-277V	21.7"(H) x 14.2"(W) x 4.7"(D)
LF5-380CW-480V	380W	46000LM	5000K	1000~1200 MH	347-480V	
LF-AD-SF	Slips onto pol top 2" Dim. Fixture mounts directly on the side or top of this device					
LF5-EXTARM	Used to mount fixture directly on side of square poles. discard mounting yoke when this mounting is used. For round poles use PSR4 adapter (see accessories page).					



LF-AD-SF
Slip Fitter Adapter



LF5-EXTARM
Extension Arm Adapter

LOHB

WALL WASH / SIGN / SUSPENDED

A21

LED OUTDOOR HIGHBAY / AREA / SIGN LIGHTS



Mounting options on opposite page



TECHNICAL SPECIFICATIONS:

- :: Ideal for Wall Wash, Sign, Suspended Outdoor/ Indoor Lighting
- :: Housing: Die-cast aluminum housing with black powder coat
- :: Voltage: 120~277V; 60Hz AC
- :: 0~10V dimming
- :: Power Factor: .9~.97
- :: Beam Angle: 90°
- :: Operating Temp:-4°F to 104°F
- :: CRI: >70
- :: 50,000 hour rated life
- :: Suitable for Wet Locations, IP65

APPLICATIONS:

- :: Ideal for indoor or outdoor highbay lighting, small stadium and tracks, sign lighting.

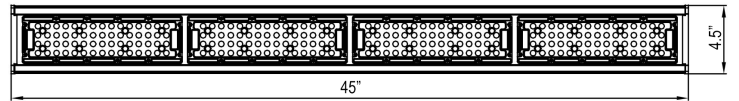
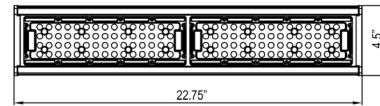

LED OUTDOOR HIGHBAY / AREA / SIGN LIGHTS (120V-277V)

CATALOG NO.	WATTS	LUMENS	COLOR TEMP	REPLACEMENT RANGE	DIMENSIONS
LOHB-2FT-50W-30K	50W	6700LM	3000K	150~250 MH	22.75"(L) x 3"(H) x 4.5"(W)
LOHB-2FT-50W-50K	50W	6500LM	5000K	150~250 MH	
LOHB-4FT-120W-30K	120W	15000LM	5000K	200~400 MH	45"(L) x 3"(H) x 4.5"(W)
LOHB-4FT-120W-50K	120W	15000LM	3000K	200~400 MH	

LOHB MOUNTING ACCESSORIES

A22

LOHB MOUNTING ACCESSORIES

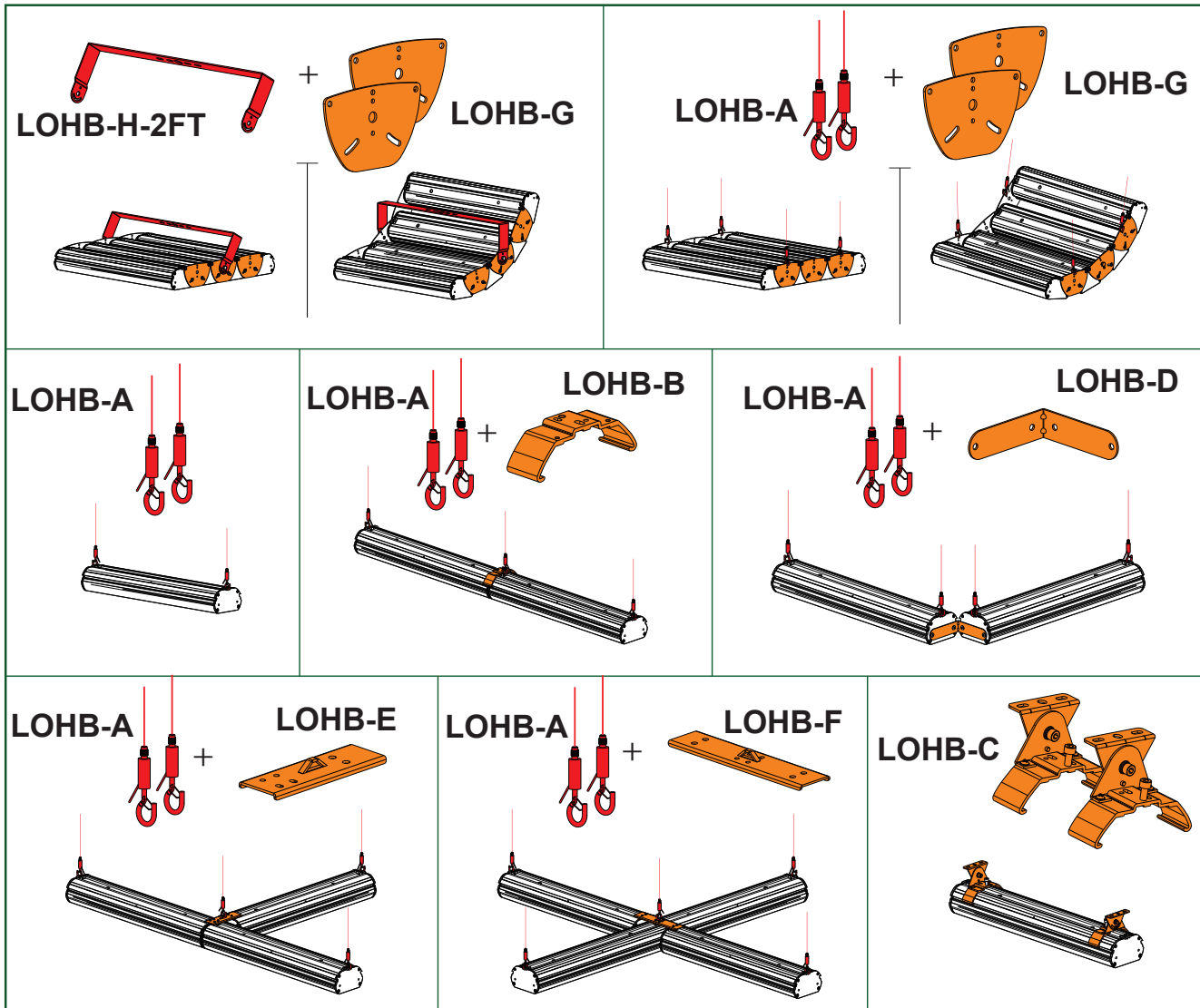

LOHB MOUNTING ACCESSORIES

CATALOG NO.	Description
LOHB-A	Set of 2, 3.3 Ft. Adjustable Aircraft Suspension Cables with hooks and 2.5" round ceiling mounting plate
LOHB-B	Tandem Coupling Bracket, Die-cast Aluminum
LOHB-C	Surface Mounting Brackets, Adjustable angle (set of 2), Die-cast Aluminum
LOHB-D	"L" Bracket, Stainless Steel
LOHB-E	"T" Mounting Bracket, Stainless Steel
LOHB-F	"X" Mounting Bracket, Stainless Steel
LOHB-G	Side by Side Fixture Coupling Brackets (set of 2), allows curve installation, Stainless Steel
LOHB-H-2FT	2Ft. Mounting Bracket, Hot-Rolled Steel

FLD2

120~277V

TECHNICAL SPECIFICATIONS:

- :: Westgate's powerful bullets
- :: LED: Philips LUMILEDs
- :: Optical Lens: High transmittance PC, anti-UV and fire resistant
- :: 13" #18 AWG stranded wires
- :: 60° beam angle
- :: Housing: Cast aluminum with powder coat finish (Bronze)
- :: Mounting: 1/2" NPT knuckle
- :: Voltage: 120~277V AC, 50/60Hz
- :: Operating Temp: -4°F to 104°F
- :: CRI: >80
- :: Power Factor: >0.9
- :: Maintenance free
- :: 70,000 hour rated life
- :: 7-year warranty
- :: Suitable for Wet Locations, IP65

APPLICATIONS:

- :: Ideal for general site lighting, alleys, loading docks, doorway, pathway and parking areas.
- :: Replace existing HID flood lights/ wall packs
- :: Great for use with motion sensors or other instant on/off controls



See page A41 for shrouds

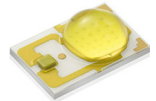
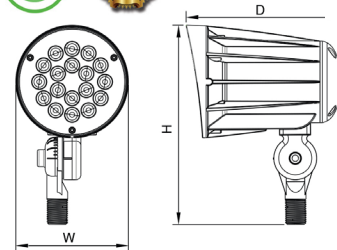

FLD2-15-KN



FLD2-28-KN



FLD2-42-KN



FLD2-50-KN

LED BULLET FLOOD LIGHTS WITH KNUCKLE

CATALOG NO.	WATTS	LUMENS	COLOR TEMP	REPLACEMENT RANGE	DIMENSIONS
FLD2-15CW-KN	15W	1500LM	5000K	50~70 MH	3"(W) x 5-1/2"(H) x 4-1/4"(D)
FLD2-15WW-KN	15W	1500LM	3000K	50~70 MH	3"(W) x 5-1/2"(H) x 4-1/4"(D)
FLD2-28CW-KN	28W	2800LM	5000K	70~100 MH	4"(W) x 7-1/2"(H) x 5-3/4"(D)
FLD2-28WW-KN	28W	2800LM	3000K	70~100 MH	4"(W) x 7-1/2"(H) x 5-3/4"(D)
FLD2-42CW-KN	42W	4200LM	5000K	100~175 MH	4-1/2"(W) x 8"(H) x 6-1/4"(D)
FLD2-42WW-KN	42W	4200LM	3000K	100~175 MH	4-1/2"(W) x 8"(H) x 6-1/4"(D)
FLD2-50-CW-KN	50W	5000LM	5000K	175~225 MH	5.4"(W) x 8.8"(H) x 8.14"(D)
FLD2-50WW-KN	50W	5000LM	3000K	175~225 MH	5.4"(W) x 8.8"(H) x 8.14"(D)

FLD2

120~277V

TECHNICAL SPECIFICATIONS:

- :: Westgate's powerful bullets
- :: LED: Philips LUMILEDs
- :: Optical Lens: High transmittance PC, anti-UV and fire resistant
- :: 18" SJTW 18/3 AWG cable
- :: 60° beam angle
- :: Housing: Cast aluminum with powder coat finish (Bronze)
- :: 1/2" hole on bracket for mounting with LF-THREAD (see accessories) or other strain-relief connectors
- :: Voltage: 120~277V AC, 50/60Hz
- :: Operating Temp: -4°F to 104°F
- :: CRI: >80
- :: Power Factor: >0.9
- :: Maintenance free
- :: 70,000 hour rated life
- :: 7-year warranty
- :: Suitable for Wet Locations, IP65

APPLICATIONS:

- :: Ideal for general site lighting, alleys, loading docks, doorway, pathway and parking areas.
- :: Replace existing HID flood lights/ wall packs
- :: Great for use with motion sensors or other instant on/off controls



See page A41 for shrouds

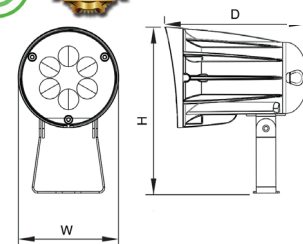

A24

LED BULLET FLOOD LIGHTS WITH TRUNNION

LED BULLET FLOOD LIGHTS WITH KNUCKLE

CATALOG NO.	WATTS	LUMENS	COLOR TEMP	REPLACEMENT RANGE	DIMENSIONS
FLD2-15CW-TR	15W	1500LM	5000K	50~70 MH	3"(W) x 5"(H) x 4-1/4"(D)
FLD2-15WW-TR	15W	1500LM	3000K	50~70 MH	3"(W) x 5"(H) x 4-1/4"(D)
FLD2-28CW-TR	28W	2800LM	5000K	70~100 MH	4-1/2"(W) x 7-3/4"(H) x 5-3/4"(D)
FLD2-28WW-TR	28W	2800LM	3000K	70~100 MH	4-1/2"(W) x 7-3/4"(H) x 5-3/4"(D)
FLD2-42CW-TR	42W	4200LM	5000K	100~175 MH	4-1/2"(W) x 8-1/2"(H) x 6-1/4"(D)
FLD2-42WW-TR	42W	4200LM	3000K	100~175 MH	4-1/2"(W) x 8-1/2"(H) x 6-1/4"(D)
FLD2-50CW-TR	50W	5000LM	5000K	175~225 MH	5.4"(W) x 8.8"(H) x 8.14"(D)
FLD2-50WW-TR	50W	5000LM	3000K	175~225 MH	5.4"(W) x 8.8"(H) x 8.14"(D)

WMS

TECHNICAL SPECIFICATIONS:

- :: Die-cast aluminum with powder coat finish (Dark Bronze), optimized for LED
- :: Polycarbonate front housing and prismatic lens provide vandal resistance
- :: Four 1/2" HUB
- :: LED: Philips Lumileds LEDs
- :: Voltage: 100~277V AC, 50/60Hz
- :: CRI: >80
- :: Power Factor: 95%
- :: Operating Temp: -4°F to 104°F
- :: 70,000 hour rated life
- :: 7-year warranty
- :: Suitable for Wet Locations, IP54

APPLICATIONS:

- :: Ideal for general site lighting, alleys, loading docks, doorway, pathway and parking areas.
- :: Great for use with photocell



Available in White



Bottom View

Mounting Posts on opposite page

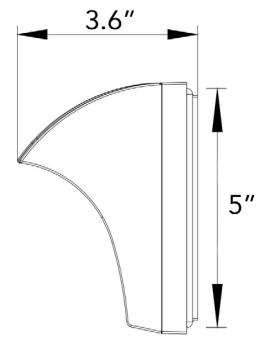
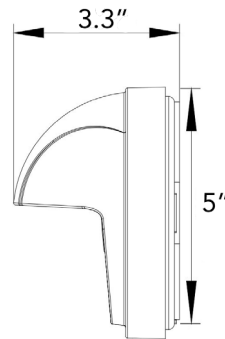

LED WALL/STEP LIGHTS

CATALOG NO.		WATTS	LUMENS	COLOR TEMP	SHAPE
BRONZE	WHITE				
WMS-S-50K-BR	WMS-S-50K-WH	6W	4400LM	5000K	SQUARE
WMS-S-30K-BR	WMS-S-30K-WH	6W	4400LM	3000K	
WMS-R-50K-BR	WMS-R-50K-WH	6W	4400LM	5000K	ROUND
WMS-R-30K-BR	WMS-R-30K-WH	6W	4400LM	3000K	

WMS-POST

FIXTURES NOT INCLUDED

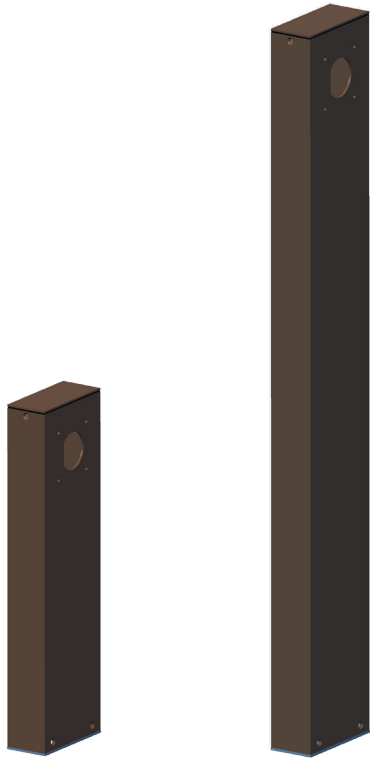

WMS-POST1-18
WMS-POST2-18

WMS-POST1-36
WMS-POST2-36

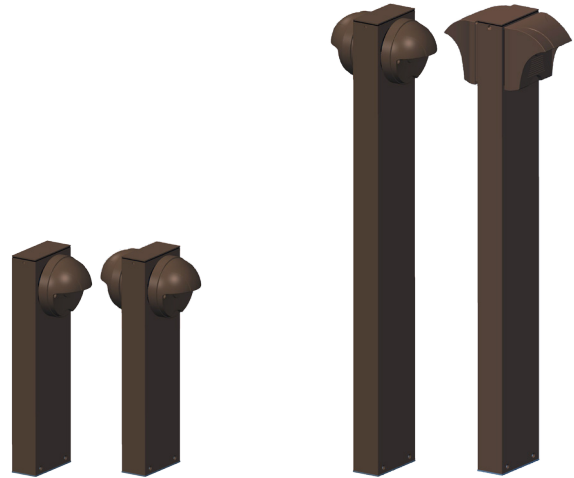
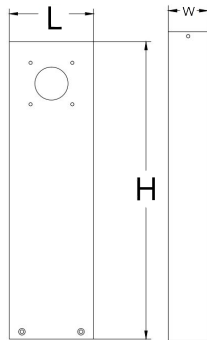

Mounting Options
(Fixtures not included)

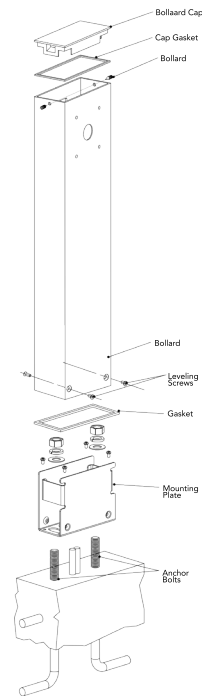

A26

LED STEP LIGHTS

LED WALL/STEP LIGHTS

CATALOG NO.	DESCRIPTION	DIMENSIONS
WMS-POST1-18	18" One side post for WMS series	18"(H) x 5"(L) x 2.3"(W)
WMS-POST2-18	18" Two side post for WMS series	
WMS-POST1-36	36" One side post for WMS series	36"(H) x 5"(L) x 2.3"(W)
WMS-POST2-36	36" Two side post for WMS series	

FLS

120V

TECHNICAL SPECIFICATIONS:

- :: Die-cast aluminum with powder coat finish
- :: Cover type: Transparent PC
- :: White Reflector
- :: Driver: Non-dimmable driver
- :: 13" #18 AWG stranded wires
- :: Power: 10W
- :: Lumens: 950LM
- :: Light Efficiency: 95LM/W
- :: Voltage: 100~130V, 50/60Hz
- :: CRI: >80
- :: Source: COB
- :: Beam Angle: 100°
- :: IP Rating: Wet Location
- :: Rotating directional hood

APPLICATIONS:

- :: A modern replacement for weatherproof PAR38 lamp holders and 100W quartz fixtures

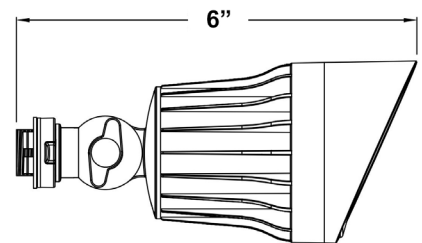
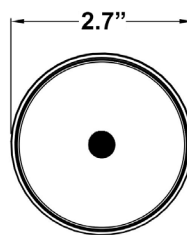

120V LED WEATHERPROOF FLOOD HEAD

CATALOG NO.	WATTS	LUMENS	COLOR TEMP	FINISH	DIMENSIONS
FLS-10W-30K-BR	10W	950LM	3000K	Bronze	6"(L) x 2.7"(D)
FLS-10W-50K-BR	10W	950LM	5000K	Bronze	
FLS-10W-30K-WH	10W	950LM	3000K	White	
FLS-10W-50K-WH	10W	950LM	5000K	White	

A27
120V LED FLOOD HEAD

STL



STL-30W



STL-60W
STL-90W



STL-100W
STL-150W



STL-220W
STL-300W

TECHNICAL SPECIFICATIONS:

- :: Die-cast aluminum with powder coat finish (Light Grey)
- :: 30W with optical TYPE III TYPE II, TYPE III or TYPE IV lens (specify)
- :: 40" SJTW 18/3 AWG cable
- :: With 2 brackets for 1.5" and 2.5" poles
- :: Driver located in isolated compartment for improved thermal management
- :: Optional Nema Twist-lock photocell (add "-P")
- :: CRI: >80
- :: 70,000 hour rated life
- :: 7-year warranty
- :: Suitable for Wet Locations, IP65



DIMMING
0-10V
Except 30W

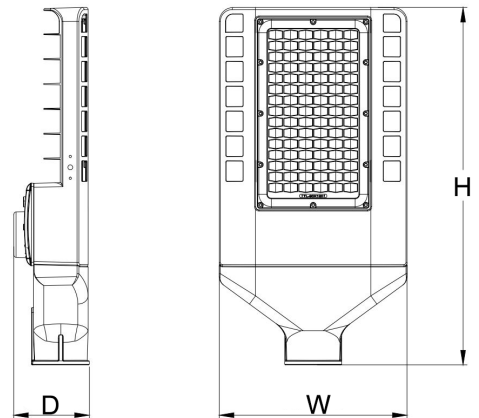

LED STREET/ROADWAY LIGHTS WITH NEMA TWIST-LOCK PHOTOCELL OPTION

CATALOG NO.	WATTS	LUMENS	COLOR TEMP	VOLTAGE	DIMENSIONS
STL-30W-50K(-P)	30W	3450LM	5000K	100-277	17.4"(L) x 6.3"(H) x 4.4"(D)
STL-60W-50K(-P)	60W	6900LM	5000K	100-277	19"(L) x 9.5"(H) x 5.25"(D)
STL-90W-50K(-P)	90W	10500LM	5000K	100-277	
STL-100W-50K-480V(-P)	100W	11500LM	5000K	277-480	20.6"(L) x 10.8"(H) x 4.3"(D)
STL-120W-50K(-P)	120W	13800LM	5000K	100-277	
STL-150W-50K(-P)	150W	17250LM	5000K	100-277	
STL-150W-50K-480V(-P)	150W	17250LM	5000K	277-480	26"(L) x 12.2"(H) x 4"(D)
STL-220W-50K(-P)	220W	25300LM	5000K	100-277	
STL-220W-50K-480V(-P)	220W	25300LM	5000K	277-480	
STL-300W-50K(-P)	300W	34500LM	5000K	100-277	
STL-300W-50K-480V(-P)	300W	34500LM	5000K	277-480	

LR2

A29

LED YARD AND ROADWAY LIGHTS



LR2-50CW-P



LR2-80CW-P
LR2-120CW-P

TECHNICAL SPECIFICATIONS:

- :: Die-cast aluminum with powder coat finish (Dark Bronze)
- :: Polycarbonate lens
- :: Driver located in isolated compartment for improved thermal management
- :: Twist lock, UL listed dusk-to-dawn photocell
- :: CRI: >80
- :: 70,000 hour rated life
- :: 7-year warranty
- :: Suitable for Wet Locations, IP65



DIMMING
0-10V
Except 50W

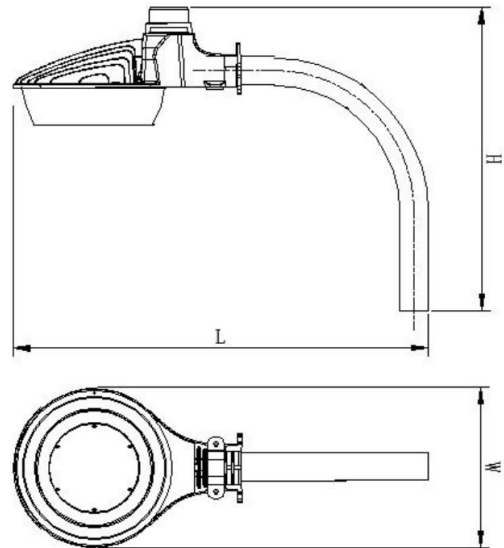

LED YARD/ROADWAY LIGHTS WITH NEMA TWIST-LOCK PHOTOCELL

CATALOG NO.	WATTS	LUMENS	COLOR TEMP	BEAM ANGLE	REPLACEMENT RANGE	DIMENSIONS
LR2-50CW-P	50W	5050LM	5000K	103°	100-175 MH	24"(L) x 9.5"(W) x 21 1/4"(H)
LR2-80CW-P	80W	9500LM	5000K	90°	250-300 MH	24"(L) x 11"(W) x 21 1/4"(H)
LR2-120CW-P	120W	14000LM	5000K	90°	320-400 MH	

GS



TECHNICAL SPECIFICATIONS:

- :: New pattern design
- :: LED: SMD technology (PHILIPS LUXEON 3030 2D)
- :: Mounts to standard junction boxes
- :: Easy installation
- :: Recessed or shoebox installation available
- :: High light efficiency: 130LM/W
- :: Eliminate the relamping cycle
- :: Ultra slim at 18mm
- :: IP66, providing a reliable weather-tight seal
- :: Efficiency: Up to 130LM/W
- :: Power efficiency: More than 95%
- :: CRI: >80
- :: Color temperature: 5000K
- :: Working temperature: 30°F~130°F
- :: Life span: 70,000hrs.
- :: Warranty: 5 years

A30

LED CANOPIES

APPLICATIONS:

- :: Airport, auto dealership, corporate and office, education, government, healthcare, industrial and warehouse, municipal, parking, gas station and convenience stores, recreation and public venues, restaurants and hospitality, retail and grocery.



GS-CANOPY-SMB

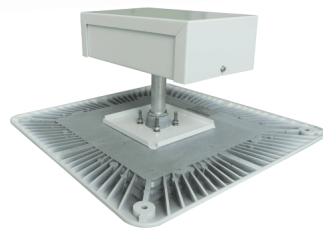

Top view

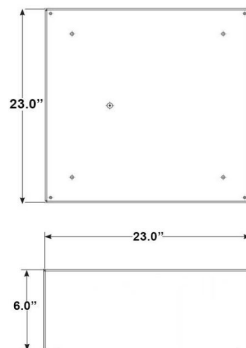

GS-CANOPY-SMB

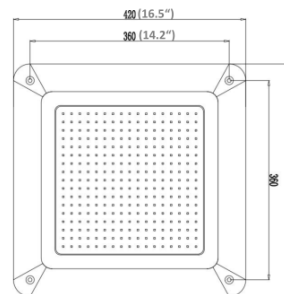

GS-CANOPY

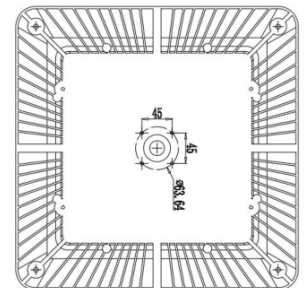

LED GAS STATION/CANOPIE LIGHTS

CATALOG NO.	WATTS	LUMENS	COLOR TEMP	DIMENSIONS
GS-CANOPY-100W-50K	100W	13600LM	5000K	
GS-CANOPY-120W-50K	120W	16300LM	5000K	16" square x 8"-3/5 (H)
GS-CANOPY-150W-50K	150W	20558LM	5000K	
GS-CANOPY-SMB	Optional surface mounting shoebox - fixture not included			18" square x 5" (H)

CDL2

TECHNICAL SPECIFICATIONS:

- :: Housing: Die-cast aluminum with prismatic polycarbonate lens redesigned for LED
- :: 1/2" threaded hubs located on two sides of the housing
- :: Voltage: 120~277V; 60Hz AC
- :: CRI: >80
- :: Power Factor: 90%
- :: Operating Temp: -40°F to 104°F

APPLICATIONS:

- :: Ideal for indoor parking lots, commercial buildings, schools, warehouses, retail centers, apartment complexes. Designed for 9 to 16-foot mounting heights.



Back view

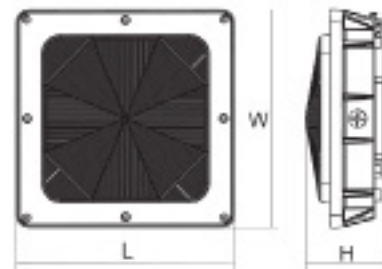

LED LOW PROFILE CANOPY/GARAGE LIGHT

CATALOG NO.	WATTS	LUMENS	COLOR TEMP	BEAM ANGLE	REPLACEMENT RANGE	DIMENSIONS
CDL2-45CW	45W	4400LM	5000K	150°	100~150 MH	10" (L) x 10" (W) x 8" (H)
CDL2-45NW	45W	4300LM	4000K	150°	100~150 MH	
CDL2-45WW	45W	4200LM	3000K	150°	100~150 MH	
CDL2-60CW	60W	7400LM	5000K	120°	150~200 MH	14" (L) x 14" (W) x 4" (H)
CDL2-60NW	60W	7100LM	4000K	120°	150~200 MH	
CDL2-60WW	60W	7100LM	3000K	120°	150~200 MH	
CDL2-80CW	80W	9500LM	5000K	120°	250~320 MH	
CDL2-80NW	80W	9400LM	4000K	120°	250~320 MH	
CDL2-80WW	80W	9400LM	3000K	120°	250~320 MH	

CDL2-M

WITH MICROWAVE MOTION SENSOR



TECHNICAL SPECIFICATIONS:

- :: Housing: Die-cast aluminum with prismatic polycarbonate lens redesigned for LED
- :: 1/2" threaded hubs located on two sides of the housing
- :: Voltage: 120~277V; 60Hz AC
- :: CRI: >80
- :: Power Factor: 90%
- :: Operating Temp: -40°F to 104°F

APPLICATIONS:

- :: Ideal for indoor parking lots, commercial buildings, schools, warehouses, retail centers, apartment complexes. Designed for 9 to 16-foot mounting heights.



Microwave Motion Sensor

1. Daylight sensor turns light on when ambient light falls below preset illumination level.
2. When movement is detected, light is switched on.
3. No motion detected, dims to preset level after hold time.
4. After dimmed stand-by period, if no movement is detected, fixture is switched off.

All above settings are adjustable by DIP switches on the sensor

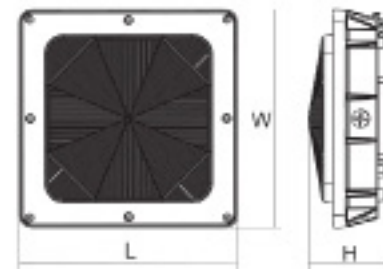

LED LOW PROFILE CANOPY / GARAGE LIGHT WITH MICROWAVE MOTION SENSOR

CATALOG NO.	WATTS	LUMENS	COLOR TEMP	BEAM ANGLE	REPLACEMENT RANGE	DIMENSIONS
CDL2-45CW-M	45W	4400LM	5000K	150°	100~150 MH	10" (L) x 10" (W) x 8" (H)

WMC

TECHNICAL SPECIFICATIONS:

- :: Housing: Die-cast aluminum
- :: Outdoor Wall Cylinders
- :: Finish: Bronze & Brushed Nickel
- :: LED: COB technology with prismatic reflector and frosted lens
- :: Input voltage: 120V
- :: Wattage: 15W (Down light); 20W (Up/Down light, 10W per end)
- :: Beam angle: 40° for each side
- :: CRI: >80
- :: IP65, providing a reliable weather-tight seal



Bronze Finish
(Up/Down Light)



Brushed Nickel Finish
(Up/Down Light)



Bronze Finish
(Down Light)



Brushed Nickel Finish
(Down Light)

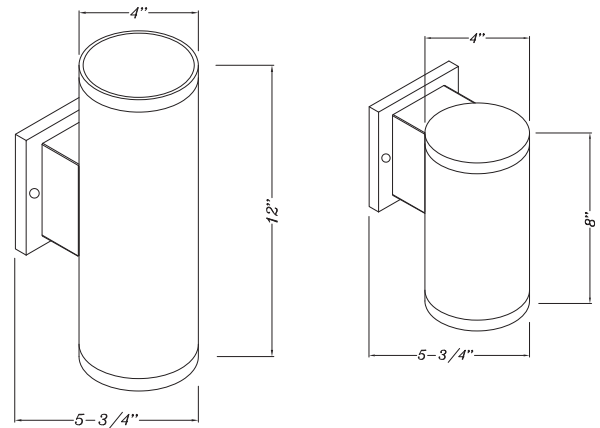

LED WALL MOUNT CYLINDER LIGHTS

CATALOG NO.	DESCRIPTION	WATTS	LUMENS	COLOR TEMP	DIMENSIONS
WMC-DL-15W-30K-BR	Down light	15W	1144LM	3000K	4" x 8" x 5-3/4"
WMC-DL-15W-50K-BR	Down light	15W	1144LM	5000K	
WMC-UDL-20W-30K-BR	Up/Down light	20W	1667LM	3000K	4" x 12" x 5-3/4"
WMC-UDL-20W-50K-BR	Up/Down light	20W	1667LM	5000K	
WMC-DL-15W-30K-BN	Down light	15W	1144LM	3000K	4" x 8" x 5-3/4"
WMC-DL-15W-50K-BN	Down light	15W	1144LM	5000K	
WMC-UDL-20W-30K-BN	Up/Down light	20W	1667LM	3000K	4" x 12" x 5-3/4"
WMC-UDL-20W-50K-BN	Up/Down light	20W	1667LM	5000K	

WMO



TECHNICAL SPECIFICATIONS:

- :: Housing: Die-cast aluminum
- :: Outdoor Wall Cylinders
- :: Finish: Bronze & Brushed Nickel
- :: LED: COB technology
- :: Input voltage: 120V
- :: Wattage: 15W (Down light); 20W (Up/Down light, 10W per end)
- :: Beam angle: 40° for each side
- :: CRI: >80
- :: IP65, providing a reliable weather-tight seal

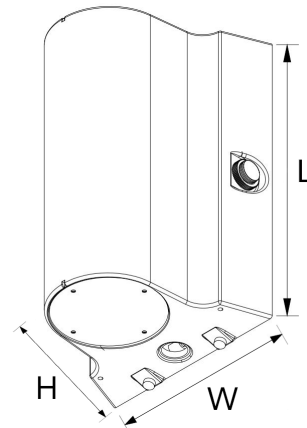

A34

LED CYLINDER LIGHTS

LED WALL MOUNT CYLINDER LIGHTS

CATALOG NO.	DESCRIPTION	WATTS	LUMENS	COLOR TEMP	DIMENSIONS
WMC-DL-15W-30K-BR	Down light	15W	1144LM	3000K	4" x 8" x 5-3/4"
WMC-DL-15W-50K-BR	Down light	15W	1144LM	5000K	
WMC-UDL-20W-30K-BR	Up/Down light	20W	1667LM	3000K	4" x 12" x 5-3/4"
WMC-UDL-20W-50K-BR	Up/Down light	20W	1667LM	5000K	
WMC-DL-15W-30K-BN	Down light	15W	1144LM	3000K	4" x 8" x 5-3/4"
WMC-DL-15W-50K-BN	Down light	15W	1144LM	5000K	
WMC-UDL-20W-30K-BN	Up/Down light	20W	1667LM	3000K	4" x 12" x 5-3/4"
WMC-UDL-20W-50K-BN	Up/Down light	20W	1667LM	5000K	

CL | A/C
(BALLAST
OVERRIDE)



TECHNICAL SPECIFICATIONS:

- :: Input voltage: 120~277V AC
- :: CCT: 3000K and 5000K
- :: CRI: 84
- :: Lamp base: E26 medium base (mogul base adaptors optional)
- :: Chip: Samsung LED chips with Rubycon driver
- :: Beam angle: 360°
- :: Operating Temp: 4°F~149°F

APPLICATIONS:

- :: Ideal for retrofitting existing HID highbay, shoebox, flood light or wall pack fixtures
- :: Can be used in enclosed luminaires

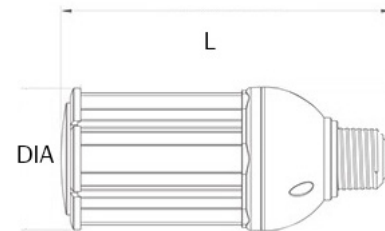

LED CORN LAMPS

CATALOG NO.	WATTS	BASE	LUMENS	COLOR TEMP	REPLACEMENT RANGE	DIMENSIONS
CL-18W-50K-E26	18W	E26	2450LM	5000K	50~100 MH	6-1/2" (L) x 2-3/4" (Dia)
CL-18W-30K-E26	18W	E26	2304LM	3000K	50~100 MH	
CL-36W-50K-E39	36W	E39	4788LM	5000K	70~150 MH	9-1/4" (L) x 3-3/4" (Dia)
CL-36W-30K-E39	36W	E39	4456LM	3000K	70~150 MH	
CL-45W-50K-E39	45W	E39	5985LM	5000K	100~175 MH	9-1/4" (L) x 3-3/4" (Dia)
CL-45W-30K-E39	45W	E39	5580LM	3000K	100~175 MH	

E26 MEDIUM BASE

ENLARGES E26 BULB TO BE USED IN E39 SOCKET

CL

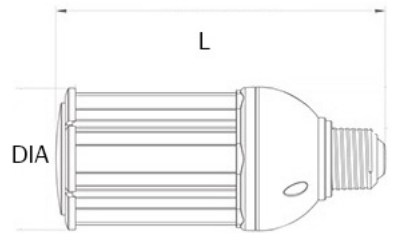

TECHNICAL SPECIFICATIONS:

- :: Input voltage: 120~277V AC
- :: CCT: 3000K and 5000K
- :: CRI: 84
- :: Lamp base: E26 medium base for CL-54W; E39 mogul base for CL-120W and CL-200W
- :: Chip: Samsung LED chips with Rubycon driver (200W with external Meanwell driver)
- :: Beam angle: 360°
- :: Operating Temp: 4°F~149°F

APPLICATIONS:

- :: Ideal for retrofitting existing HID highbay, shoebox, flood light or wall pack fixtures
- :: Can be used in enclosed luminaires



A36

LED CORN LAMPS

LED CORN LAMPS

CATALOG NO.	WATTS	BASE	LUMENS	COLOR TEMP	REPLACEMENT RANGE	DIMENSIONS
CL-54W-50K-E39	54W	E39	7182LM	5000K	100~175 MH	10-1/2" (L) x 3-3/4" (Dia)
CL-54W-30K-E39	54W	E39	6696LM	3000K	100~175 MH	
CL-120W-50K-E39	120W	E39	15960LM	5000K	200~400 MH	12" (L) x 5-3/4" (Dia)
CL-120W-30K-E39	120W	E39	14880LM	3000K	200~400 MH	
CL-200W-50K	200W	E39	27200LM	5000K	320~400 MH	14-1/4" (L) x 5" (Dia)
CL-200W-50K-480V	200W	E39	27200LM	5000K	320~400 MH	

E39 MOGUL BASE

REDUCES E39 BULB TO BE USED IN E26 SOCKET

CL-EZ2

A/C DIRECT OR BALLAST COMPATIBLE



CL-EZ2-16W

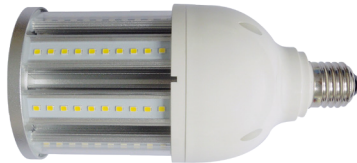

CL-EZ2-27W

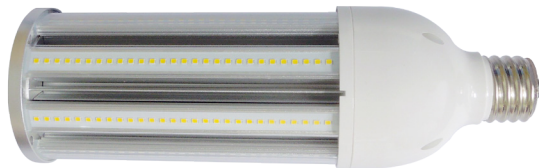

CL-EZ2-75W



CL-EZ2-100W

TECHNICAL SPECIFICATIONS:

- :: Input voltage: 120~277V AC or use with HID ballast
- :: CRI: 84
(mogul base adaptors optional)
- :: Chip: Samsung LED chips with Rubycon driver
- :: Beam angle: 360°
- :: Operating Temp: 4°F~149°F

APPLICATIONS:

- :: Ideal for retrofitting existing HID highbay, shoebox, flood light or wall pack fixtures
- :: Can be used in enclosed luminaires



2 EASY WAYS TO INSTALL:

- Bypass ballast and directly connect to 120~277V AC
- Use with existing HID ballast

WARNING

HID ballast consumes electricity when the switch is on. For best energy-saving results, ballast should be bypassed.

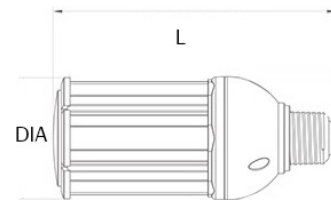

LED CORN LAMPS EZ2 (BALLAST COMPATIBLE)

CATALOG NO.	WATTS	BASE	LUMENS	COLOR TEMP	REPLACEMENT RANGE	DIMENSIONS
CL-EZ2-16W-50K	16W	E26	1650LM	5000K	50~100 MH	7" (L) x 2-3/4" (Dia)
CL-EZ2-16W-30K	16W	E26	1650LM	3000K	50~100 MH	
CL-EZ2-27W-50K	27W	E39	2168LM	5000K	70~150 MH	7-3/4" (L) x 3-1/2" (Dia)
CL-EZ2-27W-30K	27W	E39	2168LM	3000K	70~150 MH	
CL-EZ2-75W-50K	75W	E39	5048LM	5000K	150~320 MH	11-3/4" (L) x 3-3/4" (Dia)
CL-EZ2-75W-30K	75W	E39	4720LM	3000K	150~320 MH	
CL-EZ2-100W-50K-HL	100W	E39	12290LM	5000K	320~400 MH	11-1/2" (L) x 4-3/4" (Dia)
CL-EZ2-100W-30K-HL	100W	E39	12280LM	3000K	320~400 MH	

E26 ENLARGER TO MOGUL BASE

ENLARGES E26 BULB TO BE USED IN E39 SOCKET

E39 REDUCER TO MEDIUM BASE

REDUCES E39 BULB TO BE USED IN E26 SOCKET

STG

24 FT. 12 LED LAMPS



TECHNICAL SPECIFICATIONS:

- :: Westgate's linkable LED string lights
- :: 24 Ft. long, 12 lamps
- :: Lamp Base: E26 (Medium)
- :: Lamp type: LED S14 1W, 2700K, Clear
- :: 2 Spare lamps included
- :: Heavy duty 16/3 AWG cable
- :: Linkable, 1 Male and 1 female ends for chain connection
- :: Connect up to 18 sets end to end
- :: Check spec sheet for number of sets if original lamps are changed
- :: Wet location, IP65
- :: CRI: >70
- :: Light beam angle: 120°
- :: Wattage: 12W total
- :: Voltage: 120V
- :: Life span: 15,000hrs.



A38

LED STRING LIGHTS

ALL SEASON - INDOOR/OUTDOOR

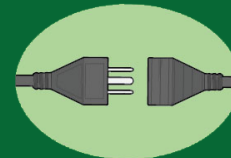

CONNECT UP TO 18 SETS

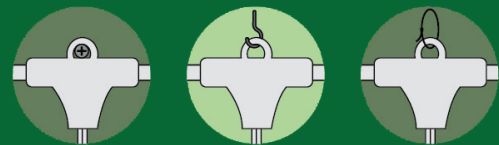

FLEXIBLE MOUNTING OPTIONS (NOT INCLUDED)



LED BULBS INCLUDED (2 SPARE)

LED STRING LIGHTS WITH S14 BULBS

CATALOG NO.	WATTS	LUMENS	COLOR TEMP	TOTAL LED
STG-2412-27K	1W per bulb	75LM per S14 bulb	2700K	12

SL



SL-20W-BZ-50K
SL-20W-BZ-30K



SL-20W-WHT-50K
SL-20W-WHT-30K

TECHNICAL SPECIFICATIONS:

- :: Westgate's versatile 2-head flood lights with motion sensor and photocell options
- :: Mounts flush on wall or 4" round weatherproof box
- :: Housing: Die-cast aluminum wqith powder coat finish
- :: Cover type: clear lens
- :: LED: COB technology
- :: Wattage: 20W (10W per head)
- :: Voltage: 90~135V AC 50/60Hz
- :: CRI: 80
- :: Temperature: -4°F~104°F
- :: Power factor: .90~.97
- :: Beam angle: 100°
- :: Suitable for wet locations, IP65

APPLICATIONS:

- :: Ideal for doorway, pathway and alleys
- :: Great for use with optional motion sensors or photocell



MOTION SENSORS



SL-PIR-WH
180°, 200W Max Load,
Outdoor Motion Sensor
(White & Bronze)



SL-PIR-BZ
180°, 200W Max Load,
Outdoor Motion Sensor
(White & Bronze)



SL-HPIR-WH
240°, 500W Max Load
Outdoor Motion Sensor
(White & Bronze)



SL-HPIR-BZ
240°, 500W Max Load
Outdoor Motion Sensor
(White & Bronze)



SL-PC
UL-listed mini
photocell for SL
series security
lights only

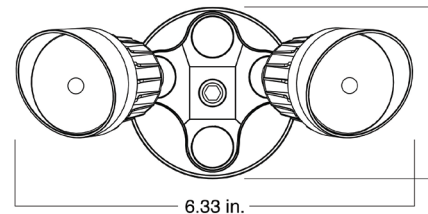

LED SECURITY LIGHTS WITH OPTIONAL MOTION SENSOR OR PHOTOCELL

CATALOG NO.	WATTS	LUMENS	COLOR TEMP	REPLACEMENT RANGE
SL-20W-WHT-50K	20W	950LM/HEAD	5000K	70~100 MH
SL-20W-WHT-30K	20W	950LM/HEAD	3000K	70~100 MH
SL-20W-BZ-50K	20W	950LM/HEAD	5000K	70~100 MH
SL-20W-BZ-30K	20W	950LM/HEAD	3000K	70~100 MH
SL-PIR-BZ SL-PIR-WH	120V AC, 180°, 200W Max Load, OUTDOOR MOTION SENSOR (WHITE or BRONZE)			
SL-HPIR-BZ SL-HPIR-WH	120V AC, 240°, 500W Max Load, OUTDOOR MOTION SENSOR (WHITE or BRONZE)			
SL-PC	120V AC, Optional Photocell Component for the above series security lights, Incl. WH & BR trims to match security light color			

A39 LED SECURITY LIGHTS

SLW & SLB



SLW-212-30K-P
SLW-212-50K-P



SLB-212-30K-P
SLB-212-50K-P



SLW-312-30K-P
SLW-312-50K-P



SLB-312-30K-P
SLB-312-50K-P

TECHNICAL SPECIFICATIONS:

- :: Westgate's powerful security lights
- :: For flush mounting on recessed junction boxes
- :: Die-cast aluminum construction
- :: Tempered glass lens
- :: Wet location, IP65
- :: CRI: 82
- :: Temperature: -4°F~104°F
- :: Power factor: .90~.97
- :: Lumens: 1050 lumens per head
- :: Light beam angle: 270°
- :: Wattage: 12W per head
- :: Voltage: 100V~120V AC
- :: Sensor angle: 270°

APPLICATIONS:

- :: Ideal for doorway, pathway and alleys

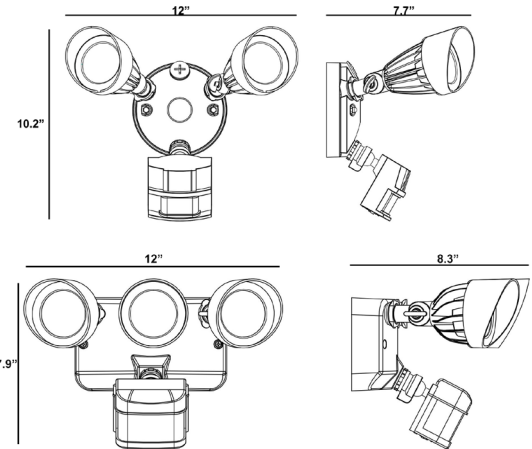

LED SECURITY LIGHTS WITH PIR SENSOR

CATALOG NO.	FINISH	WATTS	LUMENS	COLOR TEMP	REPLACEMENT RANGE
SLW-212-50K-P	White	2 x 12W	2 x 1050LM	5000K	70~100 MH
SLW-212-30K-P	White	2 x 12W	2 x 1050LM	3000K	70~100 MH
SLB-212-50K-P	Bronze	2 x 12W	2 x 1050LM	5000K	70~100 MH
SLB-212-30K-P	Bronze	2 x 12W	2 x 1050LM	3000K	70~100 MH
SLW-312-50K-P	White	3 x 12W	3 x 1050LM	5000K	100~150 MH
SLW-312-30K-P	White	3 x 12W	3 x 1050LM	3000K	100~150 MH
SLB-312-50K-P	Bronze	3 x 12W	3 x 1050LM	5000K	100~150 MH
SLB-312-30K-P	Bronze	3 x 12W	3 x 1050LM	3000K	100~150 MH

FIXTURE ACCESSORIES



FLSHROUD-A
FLSHROUD-B
FLSHROUD-C
FLSHROUD-D
 Fits FLD2-15W, FLV12-6W
 Fits FLD2-28W, FLV12-12W & 24W
 Fits FLD2-42W, FLV12-32W
 Fits FLD2-50W



SPS-75
 4" SQ. Swivel-Type cover
 3/4" hub with 1/2" reducer

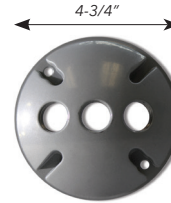

WRC-3-BRZ
 Weatherproof
 cover with three
 (3) 1/2" hubs

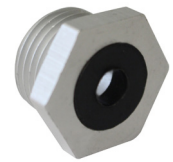

LF-THREAD
 1/2" hub adaptor for fixtures
 with trunnion bracket
 (on fixtures up to 50W)

MOUNTING ACCESSORIES FOR LF3 SERIES

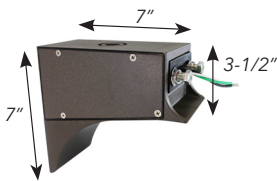

LF3-EXTARM
 Straight extension arm for
 shoe box application, with
 K/O to install PC or sensor
 (LF3-80, 100, 150,
 220 & 300)

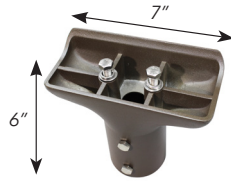

LF3-STR
 Street light arm with 20" wire
 and strain relief connector
 (LF3-80, 100, 150, 220 &
 300)

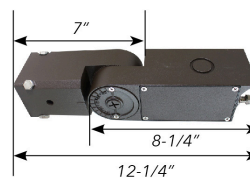

LF3-SF
 Adjustable slip fitter for
 pole mount 2"-2-1/2"
 with K/O to install PC or
 sensor (LF3-80, 100, 150,
 220 & 300)

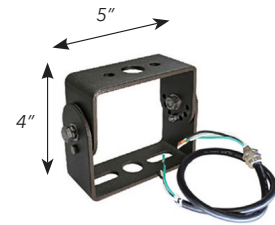

LF3-YOK
 Adjustable U-shaped
 yoke mount with 20" wire
 & strain relief connector
 (LF3-80, 100, 150,
 220 & 300)

POLE ACCESSORIES / ADAPTORS



PSS4SVTZ (4")
PSS5SVTZ (5")
 4" or 5" square pole
 vertical tenon, bronze.
 Goes on 4" or 5" pole to
 accept 2" slip fitter.



PRPT3 (3")
PRPT4 (4")
 Tenon adaptor,
 3" or 4" round pole,
 to standard
 tenon, bronze

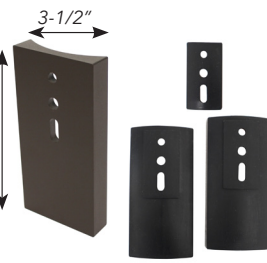

PSR4
 Adaptor kit for
 3", 4" and 5" round poles
 Separate gasket provided for
 each size pole.

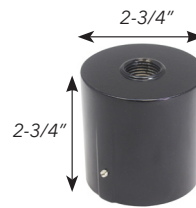

LF-AD-KNU
 2" slip fitter adaptor with
 1/2" NPT hub in the top.
 Goes on 2" pipe and
 accepts a knuckle
 fixture.

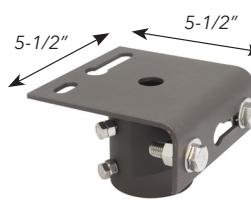

LF-AD-SF
 2" slip fitter adaptor for LF
 flood lights with trunnion.
 Goes on 2" pipe and
 accepts a trunnion fixture.

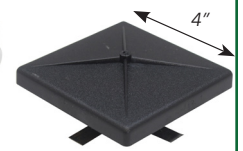

PSS4C
 Pole cap
 polycarbonate

WALL MOUNT ACCESSORIES

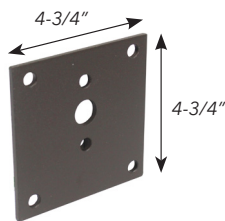

ACC-WM1
 Wall mount plate
 bronze 4-3/4" square

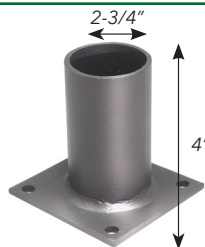

ACC-WM2
 Wall mount bracket bronze with 2"
 tenon to be used with
 Westgate slip fitter fixtures (-SF)

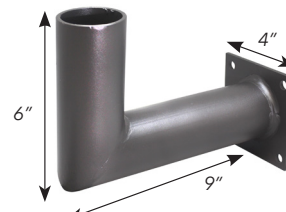

ACC-WM3
 Wall mount bracket 90°, bronze
 with 2" tenon to be used with
 Westgate slip fitter fixtures (-SF)

BULLHORNS

PT2-180
42-7/8"
Double in-line at 180°, 1' (H), 3' between centers

PT2-180-S
42-7/8"
Double in-line at 180°, 1' (H), 3' between centers, slips on 4" pole

PT3-180
30-1/4" 30-1/4"
Double in-line at 180°, 1' (H), 2'-7" between centers, slips on 2-3/8" pole

PT4-180
30-1/4" 30-1/4" 30-1/4"
Quad in-line at 180°, 1' (H), 2'-7" between centers, slips on 2-3/8" pole

PT3-120
120° 18" 31" 13"
Triple at 120°, 1' (H), 3'-5" between centers, slips on 2-3/8" tenon

PT4-090
31" 46" 22"
Quad at 90°, 1' (H), 2'-10" between centers, slips on 2-3/8" tenon

TENONS

PSS4T180HTZ
12" 6"
Square (twin) horizontal tenon, 180°, bronze. Slips on 4" pole. No adaptor needed.

PSS4T90HTZ
8" 8" 6"
Square (twin) horizontal tenon, 90°, bronze. Slips on 4" pole. No adaptor needed.

PSS4TR90HTZ
12" 6"
Square (triple) horizontal tenon, 90°, bronze. Slips on 4" pole. No adaptor needed.

PSS4Q90HTZ
12" 6"
Square (quad) horizontal tenon, 90°, bronze. Slips on 4" pole. No adaptor needed.

PSS4Q90VTZ
31-1/2" 26" 8"
4" 90° quad square vertical tenon

PSS4TVTZ
31-1/2" 26" 8"
Twin square vertical tenon for 4" square pole, slips 2-3/8" vertical tenon. Two 2-3/8" vertical tenons.

PSS4TRVTZ
57-1/2" 26" 26" 8"
Triple square vertical tenon for 4" square pole, slips 2-3/8" vertical tenon. Three 2-3/8" vertical tenons.

OUTDOOR MOTION SENSORS

A43

ACCESSORIES



PRODUCT FEATURES:

- :: Polycarbonate construction
- :: Ideal for dusk to dawn operation
- :: 1/2 NPT threads fit into 1/2" weatherproof box outlets
- :: Wet location listed (NEMA 3R rated)
- :: Full one year warranty



OUTDOOR MOTION SENSORS

CATALOG NO.	DESCRIPTION
MSO-IP66-KN	Outdoor Bi-Level Programmable Microwave Motion Sensor with 1/2" knuckle (4 1/16" Diameter)
MSO-REMOTE1	Remote for MSO-IP66-KN
SK618	Outdoor Bi-Level PIR Motion Sensor
SK618-601X	Mounting Box for SK618 Sensor, fits on LF3 series
SK618-RC	Remote Control for SK618 Sensor
SL-PIR-BZ	180°, 200W Max Load, Outdoor Motion Sensor (White & Bronze)
SL-PIR-WH	
SL-HPIR-BZ	240°, 500W Max Load, Outdoor Motion Sensor (White and Bronze)
SL-HPIR-WH	

OUTDOOR PHOTOCONTROLS

PRODUCT FEATURES:

- :: Polycarbonate construction
- :: Ideal for dusk to dawn operation
- :: 1/2 NPT threads fit into 1/2" weatherproof box outlets*
- :: Wet location listed (NEMA 3R rated)
- :: Full one year warranty



PC-B1



PC-B1-W



PC-FS1



PC-SM1



PC-SMWS1



PC-B2



PC-SM2

A44

ACCESSORIES

PHOTOCONTROLS (120V)

CATALOG NO.	DESCRIPTION	RATING
PC-B1	BUTTON PHOTOCONTROL 120V MAX 500W	120V/500W
PC-B1-W	BUTTON PHOTOCONTROL 120V WITH WALL PLATE MAX 500W	120V/500W
PC-FS1	PHOTOCONTROL SWIVEL 120V MAX 1800W	120V/1800W
PC-SM1	STEM-MOUNT PHOTOCONTROL 120V MAX 1800W	120V/1800W
PC-SMWS1	STEM-MOUNT PHOTOCONTROL WITH SWIVEL 120V MAX 1800W	120V/1800W

PHOTOCONTROLS (240V)

CATALOG NO.	DESCRIPTION	RATING
PC-B2	BUTTON PHOTOCONTROL 240V MAX 500W	240V/500W
PC-SM2	BUTTON PHOTOCONTROL 240V WITH WALL PLATE MAX 1800W	240V/500W

TYPE III & TYPE IV LENSES FOR LF3 FLOOD SERIES

A45

LF3 LENSES



TECHNICAL SPECIFICATIONS:

- :: Optical PC Precision lenses designed for Westgate LF3 Series Flood Lights
- :: These lenses are replaceable by the factory or field replaced by installers
- :: See opposite page for selection guide
- :: Each table entry below represents 1 lens panel. Order the correct number of panels depending on your fixture size (See images below)



Order 2 Lens Panels for LF3 SEIRES 80W, 100W, & 150W

Order 4 Lens Panels for LF3 SEIRES 220W & 300W

TYPE 3 & TYPE 4 LENSES FOR LF3 SERIES

CATALOG NO.	DESCRIPTION
LF3-TYPEIII-150W/300W	TYPE 3 lens for LF3 series 150W & 300W (Order 2 for 150W or 4 for 300W)
LF3-TYPEIII-80W/100W/220W	TYPE 3 lens for LF3 series 80W, 100W, & 220W (Order 2 for 80W & 100W or 4 for 220W)
LF3-TYPEIV-150W/300W	TYPE 4 lens for LF3 series 150W & 300W (Order 2 for 150W or 4 for 300W)
LF3-TYPEIV-80W/100W/220W	TYPE 4 lens for LF3 series 80W, 100W, & 220W (Order 2 for 80W & 100W or 4 for 220W)

LENS TYPES EXPLAINED

SELECTING THE BEST DISTRIBUTION TYPE FOR YOUR OUTDOOR PROJECT

“Distribution Type” defines how far forward of the luminaire (i.e., on the streetside) the effective output reaches.

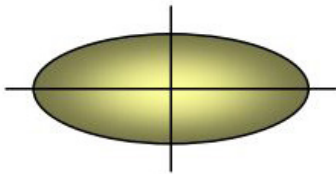

Type 2 is still lineal but wider in the front to accommodate 4 lane roadways, or wider drive lanes.

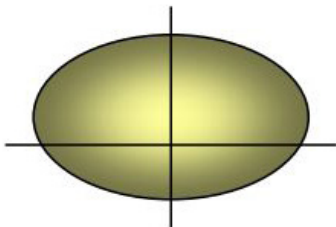

Type 3 (commonly known as a “Bat-Wing”) is suitable for perimeters, often where other interior pole placements fill the site.

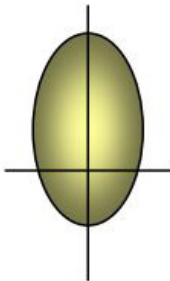

Type 4 (commonly known as a “Forward Throw” or Asymmetric) is best along perimeters where spill light is a concern or there are no place to add poles within a site.

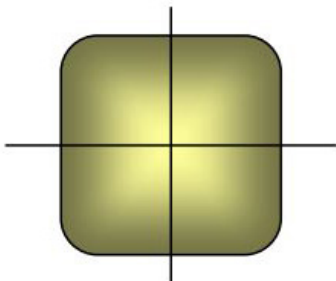

Type 5 – is available in a round or square pattern. Best suited for interior areas within a site or on the median of 4-6 lane roadways.

WL12

12V

TECHNICAL SPECIFICATIONS:

- :: Input Voltage: AC85-265V using plug-in transformer
- :: Wattage: 10W and 20W
- :: Lumens: 800L and 1600L
- :: Color Temp: DL 6000K
- :: 4 modes: 1st press—100% brightness, 2nd press—85% brightness, 3rd press—60%, 4th press—red flash
- :: USB port (5-volt DC) for charging phones and other electronic devices even when light is on.
- :: Can be used while in charge
- :: Li-ion Battery: 4400mAh/7.4V
- :: Charging Time: ≥4Hrs; Recharging
- :: Battery life:
 - WL12-10CW: 5hrs. (Full blast)/11hrs. (Mid level)/15hrs. (Lowest)
 - WL12-20CW: 3hrs. (Full blast)/6hrs. (Mid level)/9hrs. (Lowest)
- :: 120° beam angle
- :: IP65

A47

12V LED WORK LIGHTS



WL12-10CW



EASY-TO-CARRY BOX

MAGNETIC FEET



ACCESSORIES:



CAR CHARGER

12V TRANSFORMER



WL12-20CW



MAGNETIC BASE



4-LEVEL LIGHT:

- 1st press: 100% brightness
- 2nd press: 85% brightness
- 3rd press: 60% brightness
- 4th press: Red flashing light

  USB port (5V DC) at the Light bottom for charging phones and other electronic devices even when the light is on.



12V LED WORK LIGHTS

CATALOG NO.	WATTS	LUMENS	COLOR TEMP	REPLACEMENT RANGE	DIMENSIONS
WL12-10CW	10W	800LM	6000K	50~70 MH	5-3/4"(W) x 9-1/4"(H) x 6-1/2"(D)
WL12-20CW	20W	1600LM	6000K	50~70 MH	8-1/2"(W) x 11"(H) x 7-1/2"(D)

