

Deb Tucker's
Studio 180
Design

Square Squared®

A Trim Down Tool for
One of Quilting's Most
Basic Units

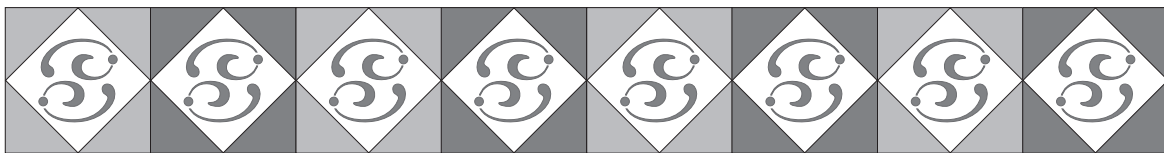

Basic Instructions

Right Handed and Left Handed Instructions
High Precision for 6 Different Size Units

© Studio 180 Design, Ltd.

Square Squared® Basic Instructions

Tool Basics

The **Center Square Section** has window templates that are drafted to give you high precision center squares. Each square's diagonal measurement is exactly the finished size of the Square Squared unit. Because these squares often involve ugly math, we have you cut them from strips that are slightly oversized. The recommended strip width for each specific size square is listed on the tool along the edge of the window template.

The **Size Chart for Triangles** gives the recommended size squares to cut that, when cut in half once diagonally, will yield two slightly oversized triangles for constructing the unit.

The **Trim Down Section** gives you guidelines to align with the seams of the pieced Square Squared unit so you can trim each to a precise size with a proper $\frac{1}{4}$ " seam allowance on all sides.

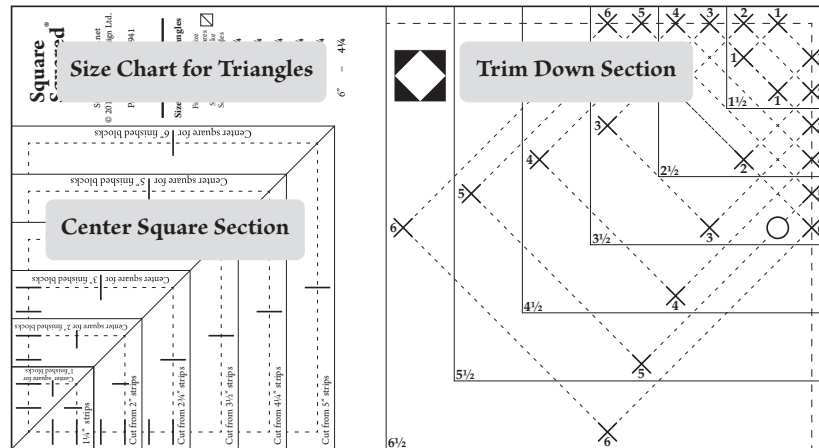

How to Use Your Square Squared® Tool

Step 1 - Determine the desired finished size of your Square Squared unit.

Step 2 - Use the **Center Square Section** to cut the center squares from your fabric. Locate the window template for the finished size unit/block you wish to make. You can use the window template to fussy cut your center squares for a special effect or cut them from strips.

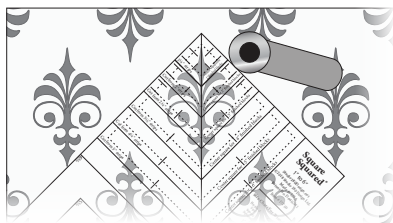

Right Handed

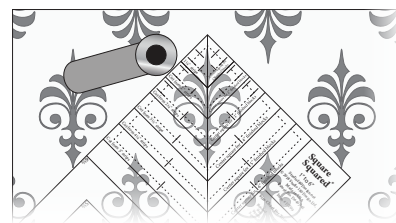

Left Handed

Step 2 - Fussy Cut Centers

In addition to the instructions included here, you can also watch video demonstrations for using your Square Squared® tool at: Studio180Design.net



Step 3 - To cut from strips, locate the recommended strip size for your chosen center square (along the edge of the window template for the specific size you will be using). Note the listed strips are slightly wider than the center square window templates. Lay the oversized strip on the cutting mat, clean up the short edge, and place the window template on the raw edges of the strip end. Cut up the side and across the top to trim each square to a precision size. If you are right handed, orient the tool horizontally and then cut your pieces left to right across your strips. If you are left handed, orient the tool vertically and then cut your pieces from right to left. Cut through as many layers as you feel comfortable, but use extra care here to make certain the squares are the correct size.

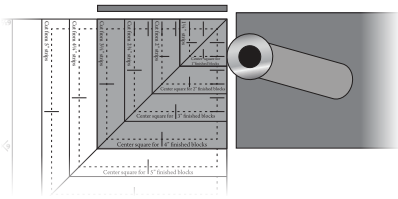

Right Handed

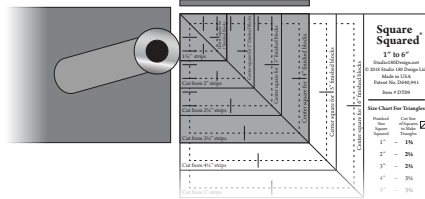

Left Handed

Step 3 - Cut Centers from Strip

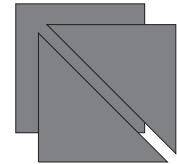

Step 4 - Cut Triangles

Step 4 - Cut surrounding triangles. Use the *Size Chart for Triangles* on the tool to determine what size squares to cut for the oversized triangles that will be added to the center square. Each square will be cut on the diagonal once to produce two triangles. You will need two squares for each center square.

Step 5 - Position two triangles on opposite sides of the center square. No need to fuss with matching the middles, as the triangles are larger than they need to be. Just basically center them and keep the raw edges aligned.

Step 6 - Stitch the two triangles using an accurate $\frac{1}{4}$ " seam. Sew with the square on top for best visibility and accuracy.

Step 7 - Press seams away from the center square.

Step 8 - Position the remaining two triangles on the remaining two sides of the center square. Again, don't fuss too much with aligning the triangles, just get them close.

Step 9 - Stitch these two triangles using an accurate $\frac{1}{4}$ " seam. Again, sew with the center square on top for best results.

Step 10 - Press the seams away from the center square.

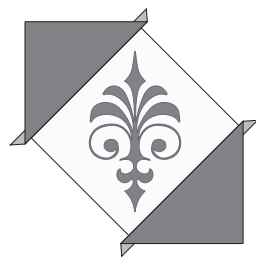

Steps 5 to 7 - Position, Stitch, and Press

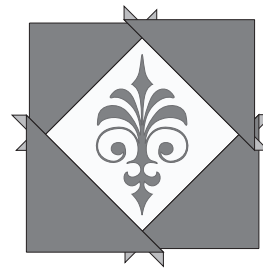

Steps 8 to 10 - Position, Stitch, and Press Again

Studio 180 Design, Ltd.

PO Box 67, Cedar Grove, NC 27231

© 2024 Deb Tucker, Studio 180 Design, Ltd. All rights reserved.

Step 11 - Use the *Trim Down Section* to trim the units to size. Locate the “X’s” marked with the size of the unit you are constructing. There will be four “X’s” with the same number. Position those “X’s” and the broken lines connecting them over the seam intersections and seam lines of the sewn unit as shown in the diagram. Trim the first two sides.

Right-handed quilters: position the tool horizontally over the unit and trim up the right side and across the top.

Left-handed quilters: position the tool vertically over the unit and trim up the left side and across the top.

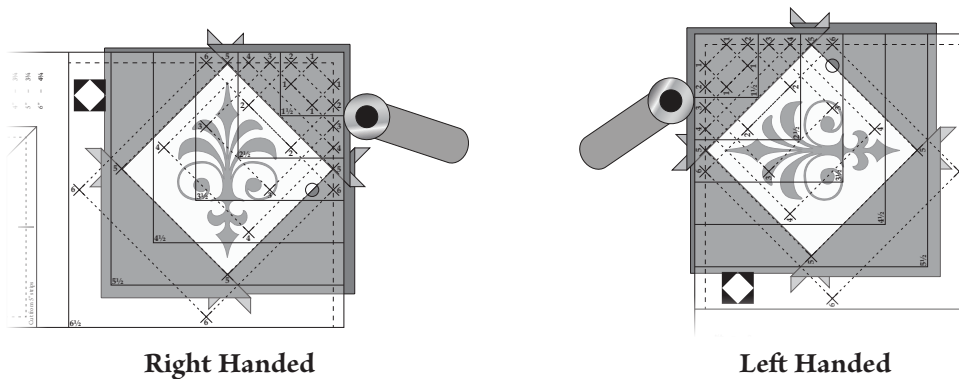

Step 11 - Trim

Note: This is what your trim down should look like. If, when you align your “X’s” over your pieced unit, not everything is lined up perfectly, we suggest that you simply center the tool over the stitched area, essentially finding the middle ground of all four marks over the four seam intersections.

Slightly adjusting the width of your seam allowance will easily rectify this issue for future units.



Step 12 - Lift the tool and rotate the fabric unit 180° on the cutting mat.

Step 13 - For the second trim, position the tool on top of the unit, again lining up the “X’s”, and also lining up the cleanup lines on the tool with the edges previously trimmed. This assures that you end up with a square that has proper 1/4” seams on all sides and is exactly the correct size to use in your quilt project. And like all Deb’s units, the edges are on the straight of grain and there’s very little wasted fabric.

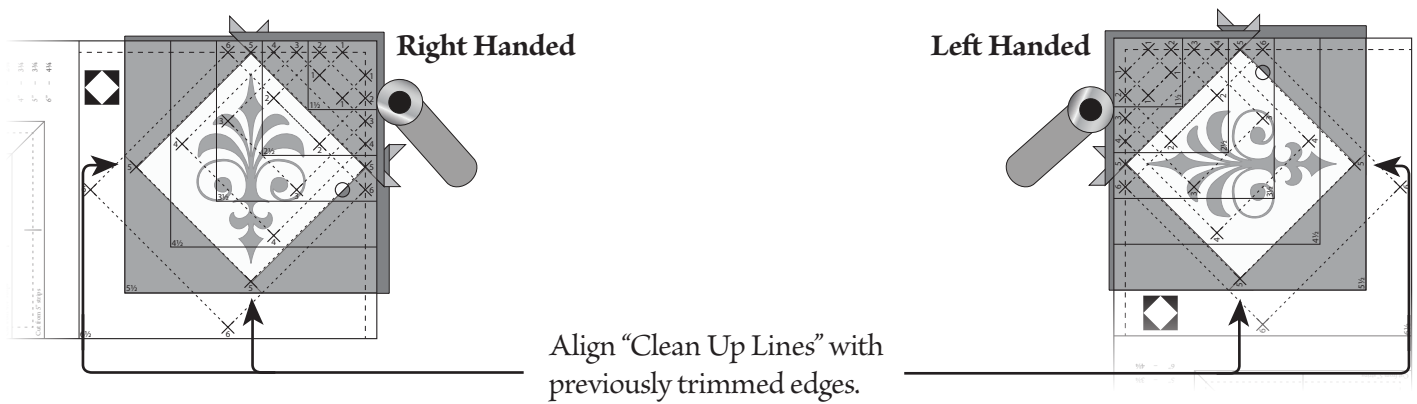

Align “Clean Up Lines” with previously trimmed edges.

Step 13 - Trim