



ARISTON
H O S P I T A L I T Y

CASEGOODS • SEATING • MILLWORK

Welcome to
Ariston Hospitality
where **your vision**
becomes
our mission.



For more than 60 years, Ariston Hospitality has been creating distinctive furnishings to exacting specifications. Our commitment is to originality and sophistication, with an Old World approach to craftsmanship. At Ariston, we design custom seating and casegoods solutions for high-traffic environments from boutique hotels to corporate offices. By combining state-of-the-art construction methods and time-tested production techniques, our highly skilled team handcrafts every item; expertly fashioning raw materials into handsome, durable pieces of furniture.

As a multi-national, family-owned manufacturing operation, Ariston caters to your unique requirements, provides inspiration, and sources materials from all over the globe.

Our diligent management team oversees operations in the US, Asia, and Europe to bring abundant resources to bear as we collaborate on manufacturing and design. In concert with sourcing production components and materials, we strive to identify and reduce the impact our operations have on the environment. At Ariston, we achieve such efficiencies while implementing practices that conserve and protect our natural resources.

The lumber we use is harvested by suppliers who reseed and manage their lands using advanced reforestation techniques. All of our components and materials, such as exotic woods, are chosen from responsible suppliers. Our production facilities incorporate a variety of environmentally friendly manufacturing technologies and innovative procedures to conserve energy and reduce waste.

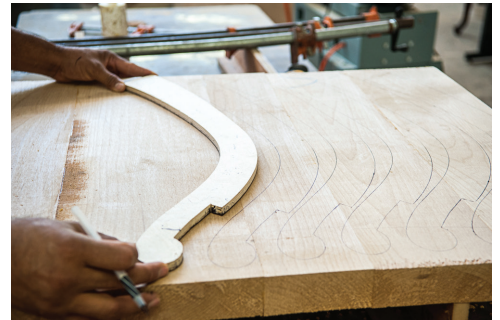

Ariston's staff works as a team to accommodate your every design challenge and communicate with you through every step of the process (from initial concept drawings through production) to ensure on-time delivery. Skilled and dedicated production personnel, many of whom are second generation craftsmen, deliver well-fitting upholstery, superb woodwork and stunning finishes.

We take pride in meeting the creative needs of design professionals around the world who share our commitment to distinctive hospitality and commercial furnishings, quality construction, refined design and comfort. Whether for guestroom, board room, lounge or lobby we offer you beautiful, custom-made furniture that seamlessly combines our global aesthetic and your individual vision.



2-8435 Weaver Chair
4-367 Axis Occasional Table

Contact us to explore the limitless possibilities.

US Headquarters and Manufacturing Facility
1124 Westminster Ave.
Alhambra, CA 91803
T- 626.458.8668 | F- 626.458.8642
info@aristonhospitality.com | www.aristonhospitality.com

Production Facilities in:
California
North Carolina
Asia
Europe

ARISTON IS CUSTOM

Ariston's family-owned factories in California and Asia develop and manufacture a wide array of furnishings for hospitality and commercial properties.

Ariston offers a treasure trove of custom products for you to select from or to use as inspiration; with expertise ranging from traditional carved designs to transitional, mid-century modern to fashion forward, mixed media, contemporary products. Having worked with designers, owners and purchasing companies on hundreds of projects requiring thousands of custom pieces, we understand the intricacies required to manufacture products that are at once aesthetically pleasing, functional, durable and cost effective.

In addition to hotel and resort guestroom furnishings, we also produce seating, casegoods and millwork for

public areas, country clubs, assisted living, multi-unit dwellings and restaurants. Our dedicated staff and nationwide representatives have worked with virtually every major hotel flag including Marriott, Hilton, Waldorf Astoria, Wynn and Embassy Suites, as well as many other types of properties across a variety of market channels. Ariston's manufacturing capabilities in the US and overseas afford us the flexibility to handle virtually any project requirement or design challenge our clients have.

Proactive customer service and production teams are dedicated to ensuring your custom projects are completed on time and to your discerning specifications.

We look forward to adding you to our list of loyal and valued customers.

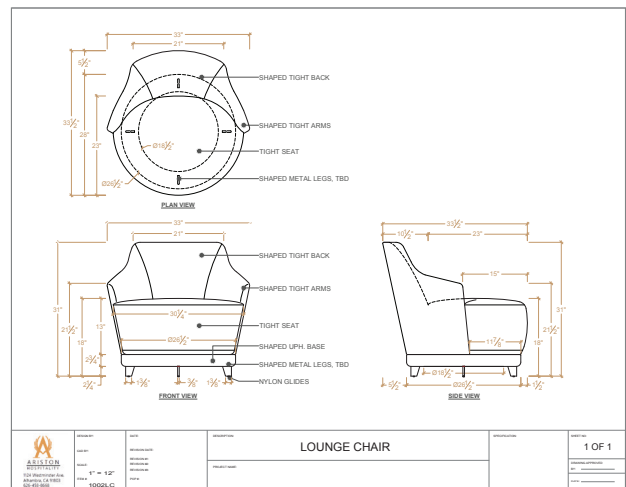



At Ariston, custom means working with designers to create distinctive seating and casegoods to your exacting specifications. We provide detailed CAD drawings to insure every detail meets with your approval before the first piece of wood is cut.

1-7408 Porthole Side Chair

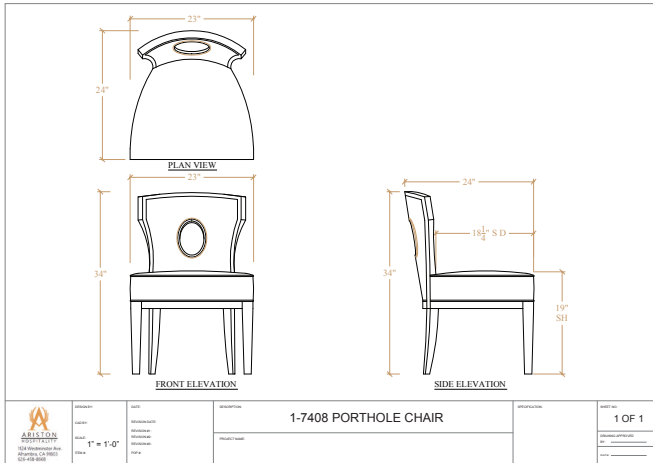

23" W x 24" D x 34"H, 19" SH
COM 2.5 yds

2-8021 Almond Sofa

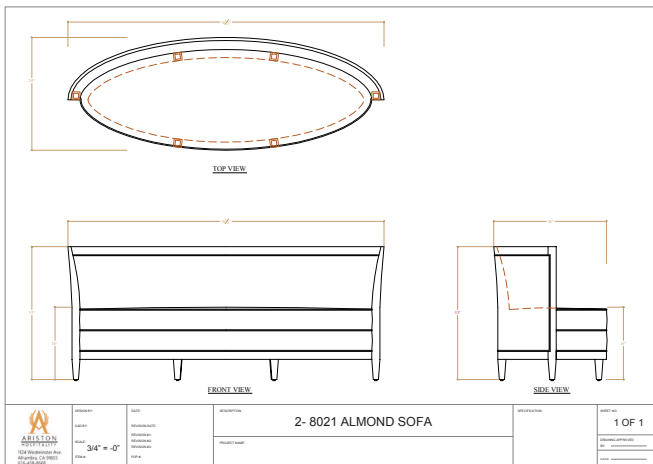

78.5" W x 31" D x 33"H, 19" SH
COM 11 yds

2-8446 Rocky Lounge Chair

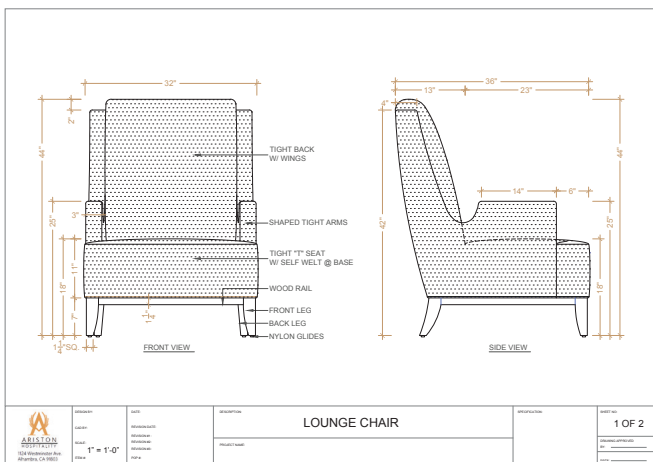

32" W x 36" D x 44"H, 18" SH, 25" AH
COM 7 yds

3-422 Debonair Barstool

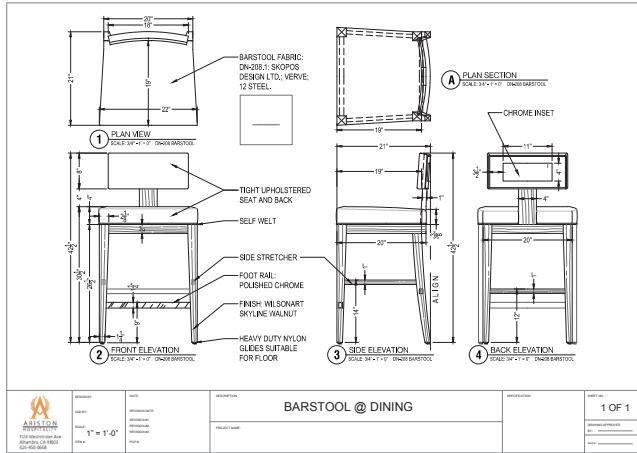

4-097 Captain Focal Table

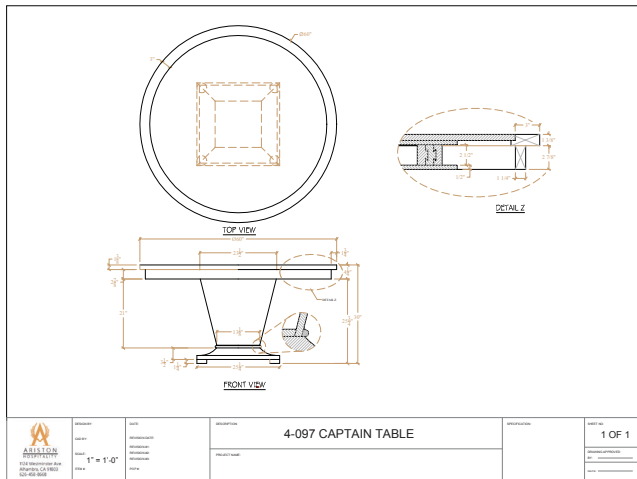

4-292 Marcel Coffee Table

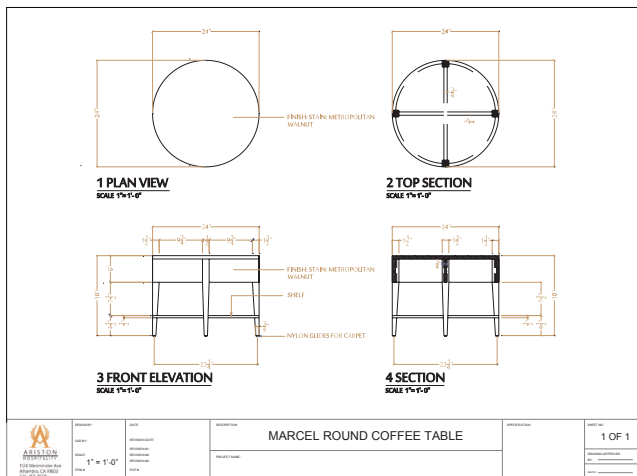

4-296 Miraggio Console Table

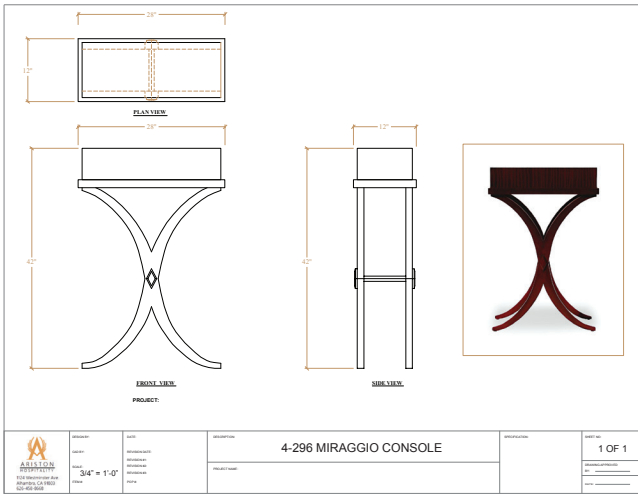

24" W x 18" D x 26" H

4-317 Principe Console Table

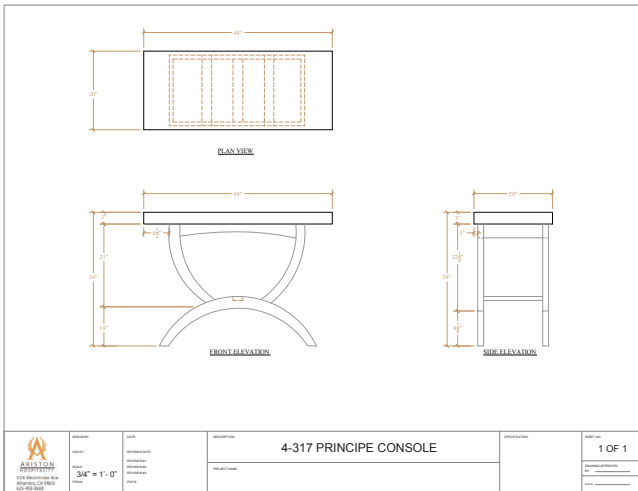

48" W x 20" D x 34" H

5-555 Lenox Desk

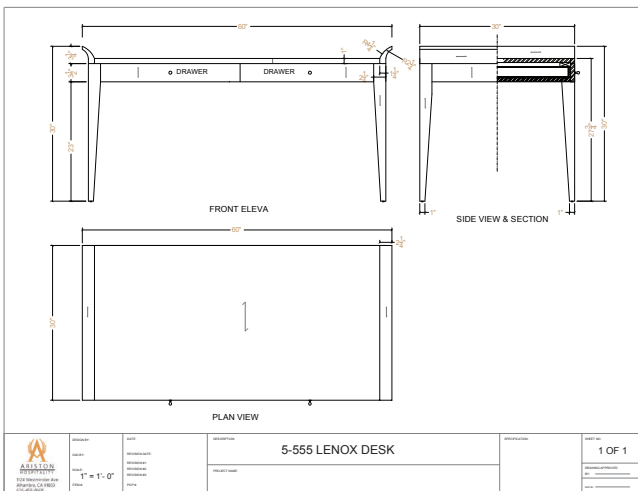

60" W x 30" D x 30" H

6-928 Madison Tall Chest

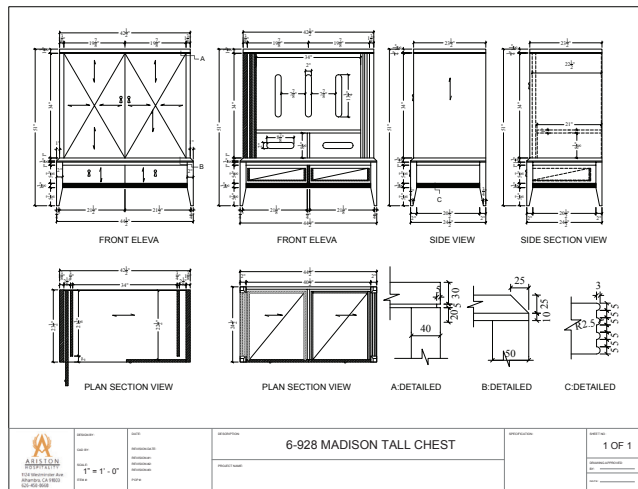

44.5" W x 24.5" D x 51"H

6-537 Fanfare Credenza

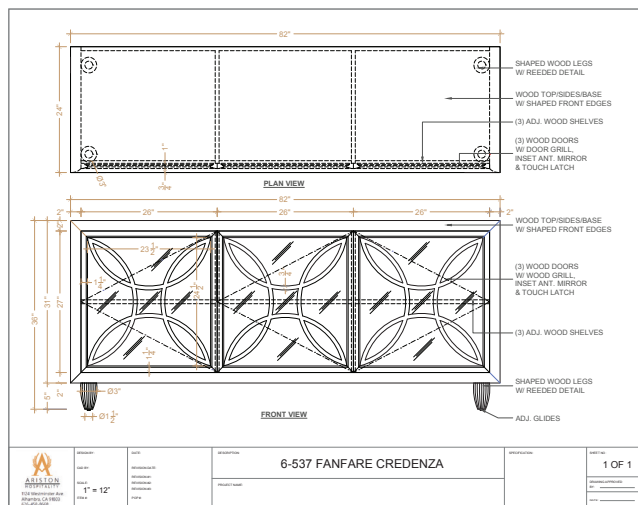

82" W x 24" D x 36"H



When you work with Ariston, you're empowered with a resource that has a stellar reputation for integrity, professionalism and expertise across our multi-national manufacturing facilities.

GUESTROOM FURNISHINGS

The strength of Ariston Hospitality lies in our ability to manufacture guestroom furniture that meets the design concept, specifications, timeline and budget for any brand or boutique hotel. Our unique position in the marketplace - owning our factories in both California and China, as well as our recently acquired collection of standard, inline seating and occasional tables based in High Point, NC - allows for a broad range of capabilities to meet the requirements of both the specifier and purchaser for these types of furnishings. We look forward to being included in the bid list for your next project.

Ariston's design and engineering teams work in concert with all our clients, from initial sketches and

specification writing to creation of CAD renderings in order to ensure each detail is considered and approved. We produce virtually every type of custom case good or millwork product imaginable and we build them to your specifications.

Guestroom furnishings include headboards with integrated connectivity, nightstands, credenzas, desks, and dressers. For suites, concierge and hospitality lounges we also offer dining tables, entertainment centers, vanities, consoles, cocktail tables, side tables, buffets and focal tables.





Hotel Republic San Diego

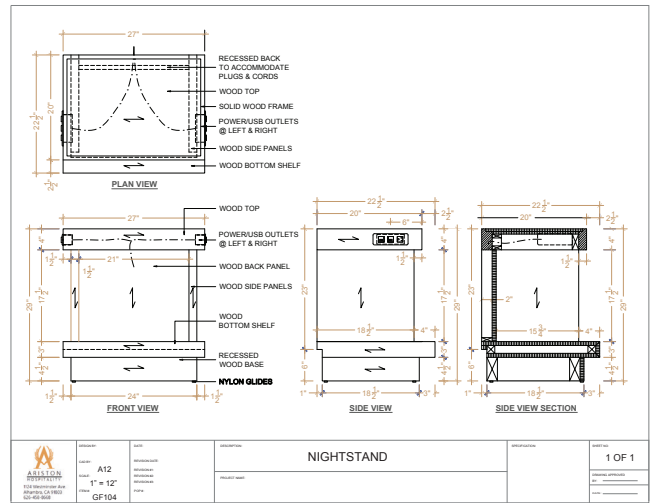
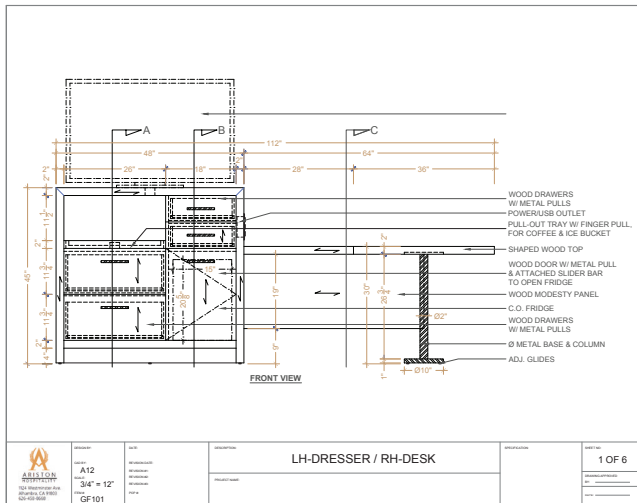



Mission Inn Hotel & Spa, Riverside

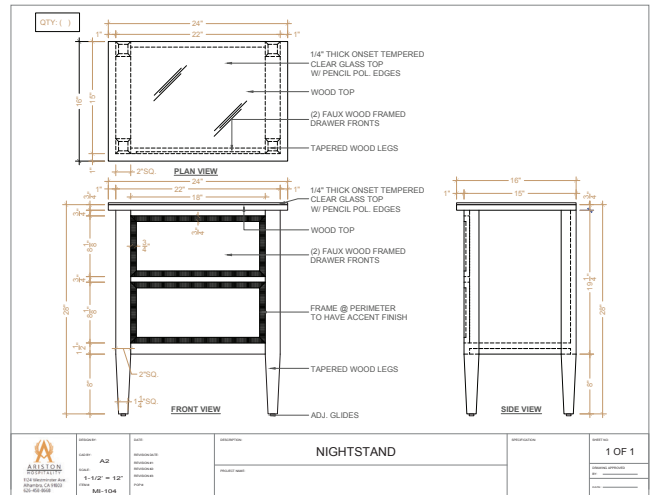
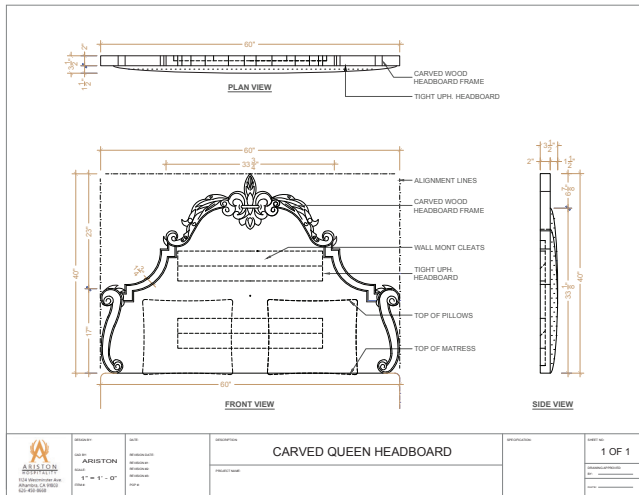



Santa Ana Star Casino Hotel,
Santa Ana Pueblo

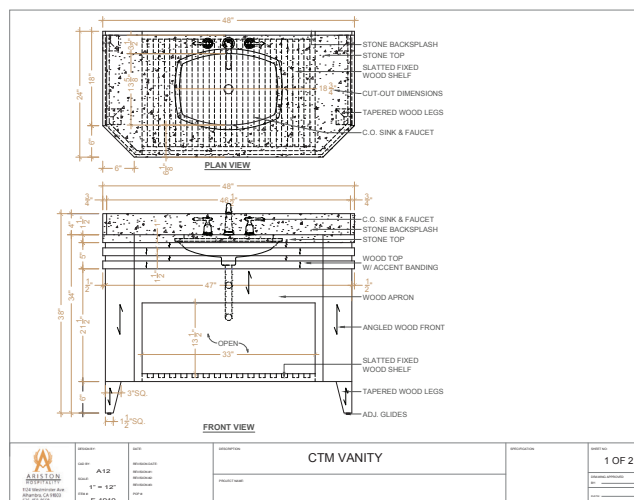
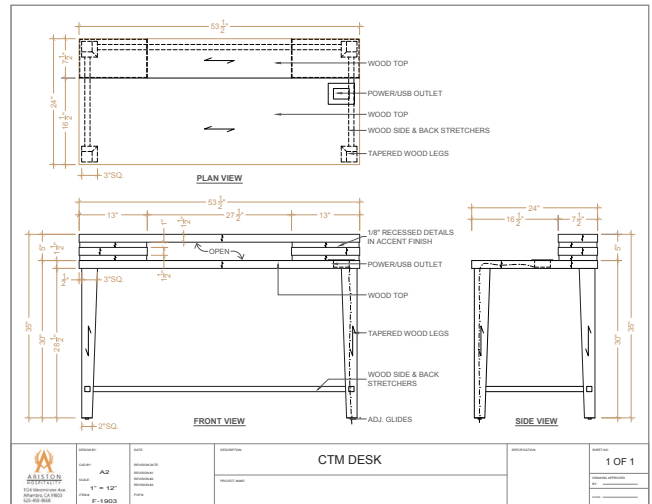
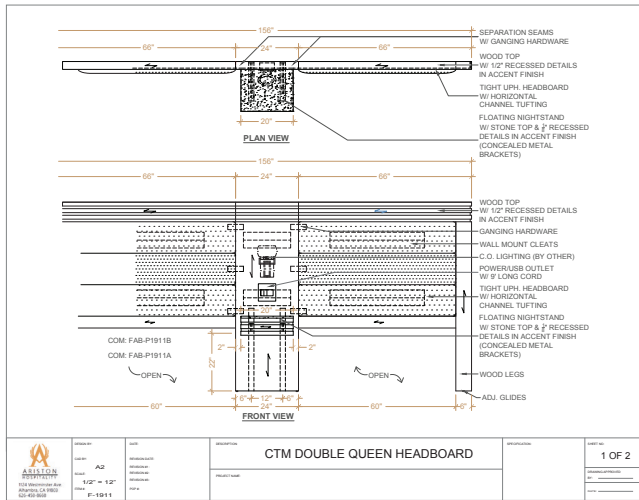



Mosaic Hotel Beverly Hills

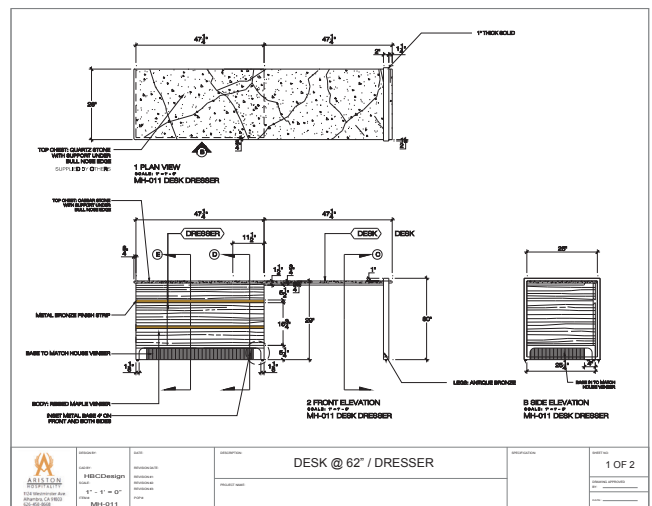
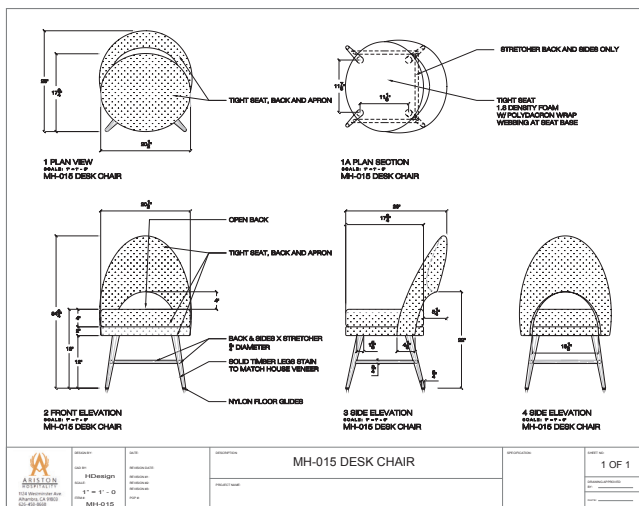
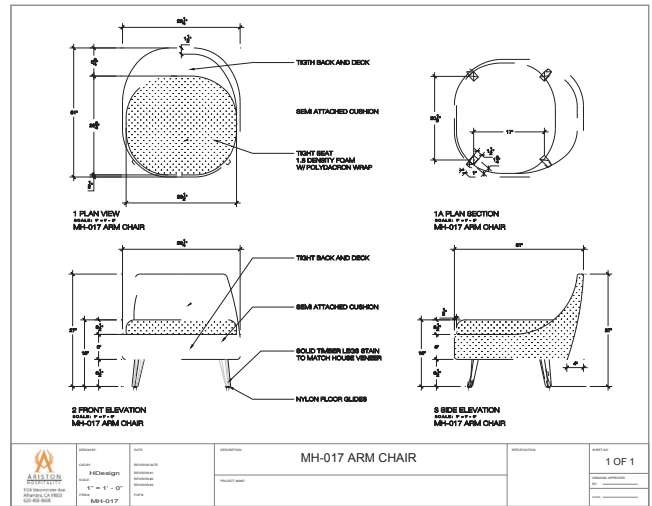
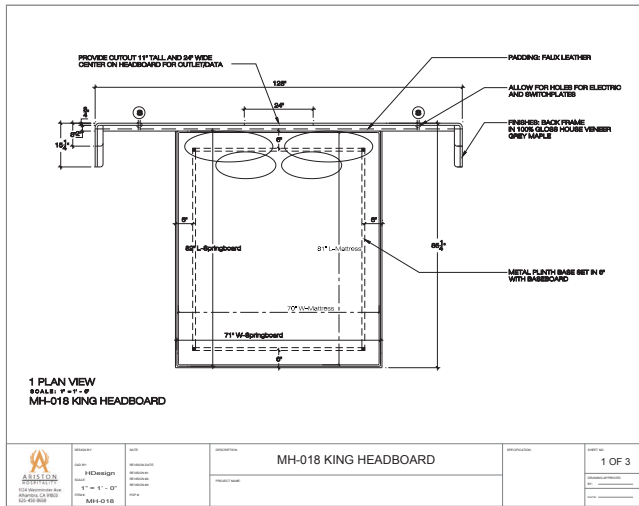



Waldorf Astoria,
Orlando



Woodfield Country Club,
Boca Raton

Ariston Hospitality proudly shares this sampling of properties for which we have manufactured public or guestroom furniture.

- Ace Hotel - New Orleans, LA
- Beverly Center - Los Angeles, CA
- Chileno Bay Resort - Cabo San Lucas, Mexico
- Courtyard by Marriott - Anaheim, CA
- DoubleTree - Rancho Bernardo, CA
- Element Hotel - Anaheim, CA
- Embassy Suites Downtown - Austin, TX
- Encore at Wynn - Las Vegas, NV
- Four Point Sheraton - Oklahoma City, OK
- Hilton - Fort Wayne, IN
- Hilton - San Francisco, CA
- Hilton Garden Inn - Bozeman, MT
- Home2 - Dallas, TX
- Home2 - Eagan, MN
- Hyatt High Sierra Lodge - Reno, NV
- Isleta Sports Bar - Albuquerque, NM
- Kansas City Marriott Country Club, KS

- Marriott Downtown - Portland, OR
- Marriott - Kansas City, MO
- Marriott - Riverside, CA
- Metropolis - Los Angeles, CA
- Monteraeu - Tulsa, OK
- Monarch Casino - Black Hawk, CO
- Ocean Club - Ft. Lauderdale, FL
- Orlando Reunion Penthouse X, FL
- Park Lane - Monterey, CA
- Pendry - West Hollywood, CA
- Seaport at Congress - Boston, MA
- Summer Bay Resort - Clermont, FL
- Sunset Suites at Emerald Grande - Destin, FL
- Talking Stick - Scottsdale, AZ
- The Cosmopolitan - Las Vegas, NV
- The New Orleans - Riverside, CA
- Wynn Hotel, Las Vegas, NV

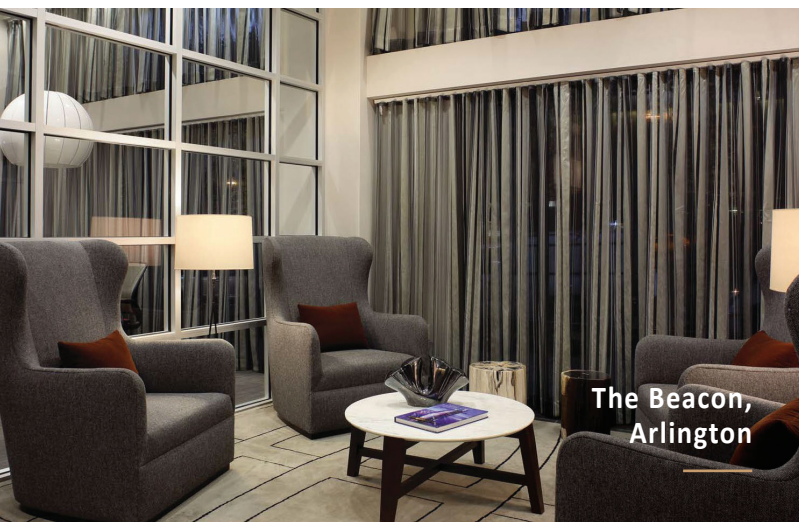

The Beacon,
Arlington



Embassy Suites,
Charlotte

DESIGN. CREATE. INSPIRE.

Ariston Hospitality manufactures custom seating and casegoods
for guestrooms, lobbies, lounges, and restaurants
that meet your vision, budget, and installation requirements.



1124 Westminster Ave.
Alhambra, CA 91803
T - 626.458.8668 F - 626.458.8642
info@aristonhospitality.com
www.aristonhospitality.com

