

RANCO INSTALLATION INSTRUCTIONS

Sold by: [Honey Run Apiaries - www.HoneyRunApiaries.com](http://www.HoneyRunApiaries.com)

Form No. 7515003-001 Rev. C

ETC SINGLE STAGE ELECTRONIC TEMPERATURE CONTROL

PRODUCT DESCRIPTION

The Ranco ETC is a microprocessor-based family of electronic temperature controls, designed to provide on/off control for commercial heating, cooling, air conditioning and refrigeration. The ETC is equipped with a liquid crystal display (LCD) that provides a constant readout of the sensed temperature, and a touch keypad that allows the user to easily and accurately select the set point temperature, differential and heating/cooling mode of the operation. Models are available that operate on either line voltage (120/208/240 VAC) or low voltage (24VAC)

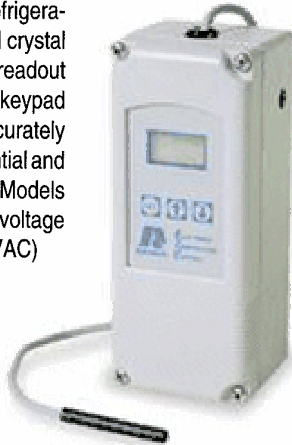

APPLICATIONS

With its wide temperature setpoint range and selectable heating or cooling modes, the ETC can be used for a wide variety of applications including refrigerated display cases, walk-in and reach-in refrigerators, milk coolers, refrigerated warehouses, chillers, beer and beverage coolers, tank heating, space and return air temperature control and condenser fan cycling.

FEATURES

- Wide setpoint temperature range (-30°F to 220°F) and differential adjustment (1°F to 30°F).
- Simple keypad programming of setpoint temperature, differential and cooling/heating modes.
- LCD readout of sensor temperature, control settings, relay status and onboard diagnostics.
- Remote temperature sensing up to 400 feet.
- SPDT output relay.
- User-selectable Fahrenheit/Celsius scales.
- Lockout switch to prevent tampering by unauthorized personnel.
- Choice of line voltage and low voltage models available.
- Optional 0 to 10 volt analog output available for remote temperature indication.

SPECIFICATIONS

Input Voltage	120 or 208/240 VAC (24 VAC optional), 50/60 Hz
Temperature Range	-30°F to 220°F
Differential Range	1°F to 30°F
Switch Action	SPDT
Sensor	Thermistor, 1.94 in. long x 0.25 in. diameter with 8 ft. cable
Power Consumption	120/208/240 VAC: 100 Milliamps 24 VAC: 2 - 6 VA

Relay Electrical Ratings

	120V	208/240V
NO Contact		
Full-load amps	16 A	8 A
Locked rotor amps	96 A	48 A
Resistive amps	15 A	8 A
Horsepower	1 hp	1 hp
NC Contact		
Full-load amps	5.8 A	2.9 A
Locked rotor amps	34.8 A	17.4 A
Resistive amps	5.8 A	2.9 A
Horsepower	1/4 hp	1/4 hp

Pilot Duty: 125 VA at 120/208/240 VAC

Control Ambient Temperature

Operating	-20°F to 140°F (-29°C to 60°C)
Storage	-40°F to 176°F (-40°C to 80°C)
Ambient Humidity	0 to 95%, RH, Non-condensing
0 to 10 V Output Impedance	1K
Enclosure	NEMA 1, Plastic
Agency Approvals	UL Listed, File E94419, Guide XAPX CSA Certified, File LR68340, Class 4813 02

ETC ORDERING INFORMATION

Code Number	Input Voltage	No. of Stages	0 - 10 V Output
ETC-111000-000	120/240	1	No
ETC-111100-000	120/240	1	Yes
ETC-112000-000	24	1	No
ETC-112100-000	24	1	Yes

OPERATION

Liquid Crystal Display (LCD)

The LCD display provides a constant readout of the sensor temperature and indicates if the output relay is energized. When the **S1** annunciator is constantly illuminated during operation, the relay is energized. The display is also used in conjunction with the keypad to allow the user to adjust the setpoint temperature, differential and heating/cooling modes.

Control Setup

The temperature setpoint refers to the temperature at which the normally open (NO) contacts of the output relay will open. Determine the load (s) to be controlled and the operating mode required, cooling or heating. Refer to Figure 1 for a visual representation.

- When the cooling mode is chosen, the differential is above the setpoint. The relay will de-energize as the temperature falls to the setpoint.
- When the heating mode is chosen, the differential is below the setpoint. The relay will de-energize as the temperature rises to the setpoint.

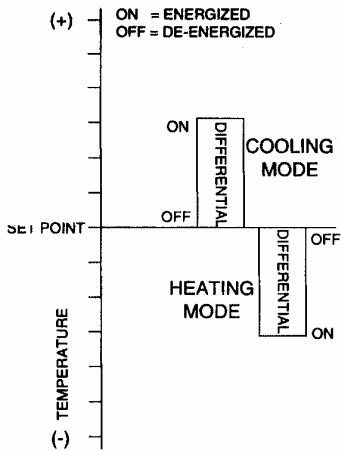

Figure 1: Setpoint and Differential Settings. Diagram indicates relay on and off points in either the heating or cooling modes.

Programming Steps and Display

The ETC can be programmed in four simple steps using the LCD display and the three keys on the face of the control.

- Step 1- To start programming, press the **SET** key once to access the Fahrenheit/Celsius mode. The display will show the current status, either **F** for degrees Fahrenheit or **C** for degrees Celsius. Then press either the up \uparrow or down \downarrow arrow key to toggle between the **F** or **C** designation.
- Step 2- Press the **SET** key again to access the setpoint. The LCD will display the current setpoint and the **S1** annunciator will be blinking on and off to indicate that the control is in the setpoint mode. Then press either the up \uparrow key to increase or the down \downarrow key to decrease the setpoint to the desired temperature.
- Step 3- Press the **SET** key again to access the differential. The LCD will display the current differential and the **DIF 1** annunciator will be blinking on and off to indicate that the control is in the differential mode. Then press either the up \uparrow key to increase or the down \downarrow key to decrease the differential to the desired setting.
- Step 4- Press the **SET** key again to access the cooling or heating mode. The LCD will display the current mode, either **C1** for cooling or **H1** for heating. Then press either the up \uparrow or down \downarrow key to toggle between the **C1** or **H1** designation. Press the **SET** key once more and programming is complete.

Step	Annunciator	Description	Display
1	F or C	Fahrenheit or Celsius Scale	
2	S1 (blinking)	Setpoint Temperature	
3	DIF 1 (blinking)	Differential Temperature	
4	C1/H1	Cooling or Heating Mode	

NOTE: The ETC will automatically end programming if no keys are depressed for a period of thirty seconds. Any settings that have been input to the control will be accepted at that point.

All control settings are retained in non-volatile memory if power to ETC is interrupted for any reason. Re-programming is not necessary after power outages or disconnects unless different control settings are required.

Lockout Switch

The ETC is provided with a lockout switch to prevent tampering by unauthorized personnel. When placed in the **LOCK** position, the keypad is disabled and no changes to the settings can be made. When placed in the **UNLOCK** position, the keypad will function normally.

To access the lockout switch, disconnect the power supply and open the control. The switch is located on the inside cover about 2 inches above the bottom. (see Figure 2). To disable the keypad, slide the switch to the left **LOCK** position. To enable the keypad, slide the switch to the right **UNLOCK** position. All ETC controls are shipped with this switch in the **UNLOCK** position.

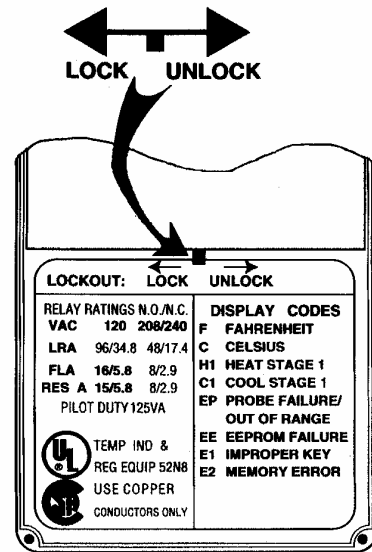

Figure 2: Lockout Switch

TROUBLESHOOTING ERROR MESSAGES

Display Messages

- E1** - Appears when either the up \uparrow or down \downarrow key is pressed when not in the programming mode.
To correct: If the E1 message appears even when no keys are being pressed, replace the control.
- E2** - Appears if the control settings are not properly stored in memory.
To correct: Check all settings and correct if necessary.
- EP** - Appears when the probe is open, shorted or sensing a temperature that is out of range.
To correct: Check to see if the sensed temperature is out of range. If not, check for probe damage by comparing it to a known ambient temperature between -30°F and 220°F. Replace the probe if necessary.
- EE** - Appears if the EEPROM data has been corrupted.
To correct: This condition cannot be field repaired. Replace the control.
- CL** - Appears if calibration mode has been entered.
To correct: Remove power to the control for at least five seconds. Reapply power. If the **CL** message still appears, replace the control.

INSTALLATION INSTRUCTIONS

IMPORTANT

1. All ETC series controls are designed as operating controls only. If an operating control failure could result in personal injury or loss of property, a separate safety control and /or alarm should be installed.
2. The schematic drawings and other information included in these installation instructions are for the purpose of illustration and general reference only.
3. These instructions do not expand, reduce, modify or alter the Ranco Terms in any way; and no warranty or remedy in favor of the customer or any other person arises out of these instructions.
4. Ranco ETC controls have been approved by Underwriter's Laboratories as UL listed; however, approval does not extend to their use for any other purpose. Ranco assumes no responsibility for any unconventional application of its control unless such application has been approved in writing by Ranco.
5. It is the responsibility of the installer and the user to assure that his or its application and use of all Ranco products are in compliance with all federal, state and local requirements, including, without any limitation, all requirements imposed under the National Electric Code and any applicable building codes.

CAUTION

To prevent possible electrical shock or equipment damage, disconnect electrical power to the unit before and during installation. **DO NOT** restore electrical power to unit until the control is properly installed and the cover is assembled. **DO NOT** locate the control in an explosive atmosphere as a safety hazard can result due to possible spark generation in the control. Controls are not to be located in areas of significant moisture, dirt or dust, or in a corrosive explosive atmosphere. Use of control in such environments may result in injury or damage to the persons or property (or both) and are likely to shorten the control life; **Ranco assumes no responsibility for any such use.**

CONTROL MOUNTING

Mount the ETC to a wall or any flat surface using a combination of any two or more of the slotted holes located on the back of the control case. The control's components are not position sensitive, but should be mounted so that they can be easily wired and adjusted. Avoid excessive conditions of moisture, dirt, and corrosive atmosphere.

The ETC has provisions for 1/2 inch conduit connections. The conduit hub should be secured to the conduit before securing the hub to the plastic housing of the control. When using the conduit entry in the rear of the case, a standard plug should be inserted into the conduit hole in the bottom. Caution should be exercised not to damage the control circuit board or wiring when installing a conduit connector.

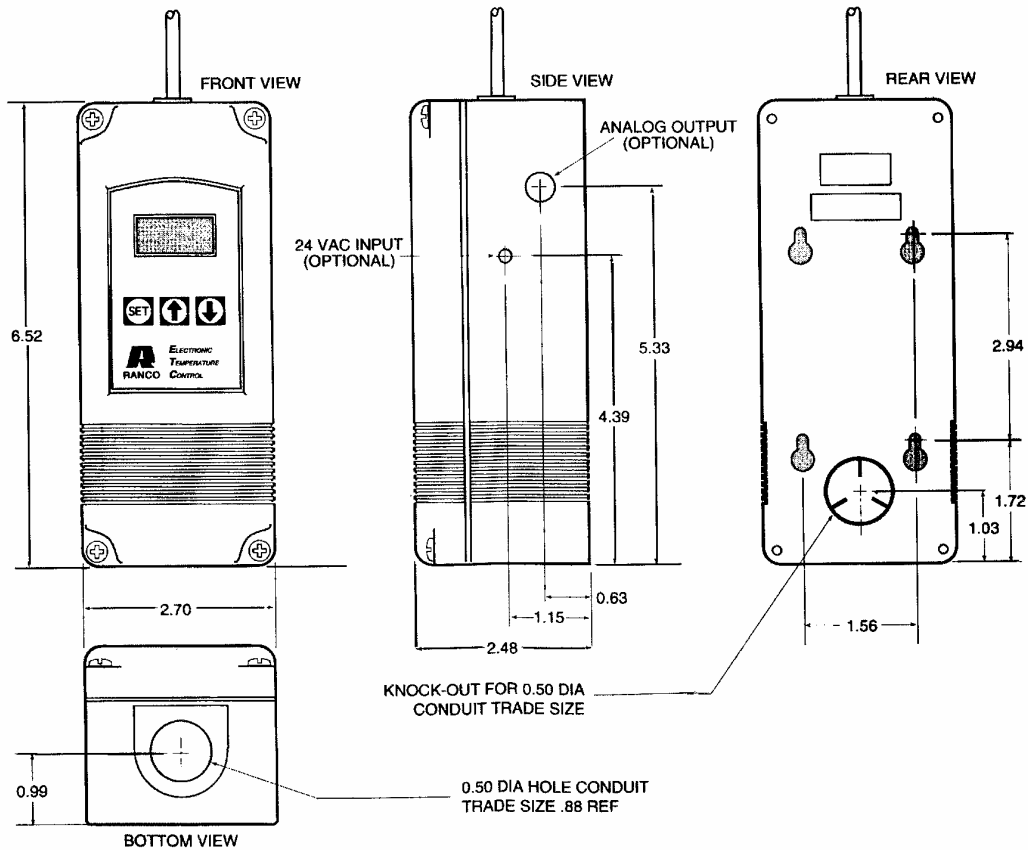

Figure 3: Dimensions (Inches)

CONTROL WIRING

General

- All wiring should conform to the National Electric Code and local regulations.
- The total electrical load must not exceed the maximum rating of the control (see Specifications).
- Use copper conductors only.
- Electrical leads should not be taut; allow slack for temperature change and vibration.

Input and Output Wiring

For typical wiring diagrams, refer to Figures 4, 5 and 6. All connections are made to the power (lower) circuit board. When using the 24 VAC powered models, the 24 VAC input lines must enter through the sidewall of the case. Refer to figure 3 for location of the entry hole. Figure 7 for wiring.

Analog Output

ETC models are available with an optional 0 to 10 volt analog output. This signal is a linear representation of the sensor temperature with 0 volts = -30°F and 10 volts = 220°F. See figure 8 for wiring information and figure 3 for location of the entry hole. The reference for this output is designated by the "-" symbol on the wiring diagram. The output signal is designated by the "+" symbol.

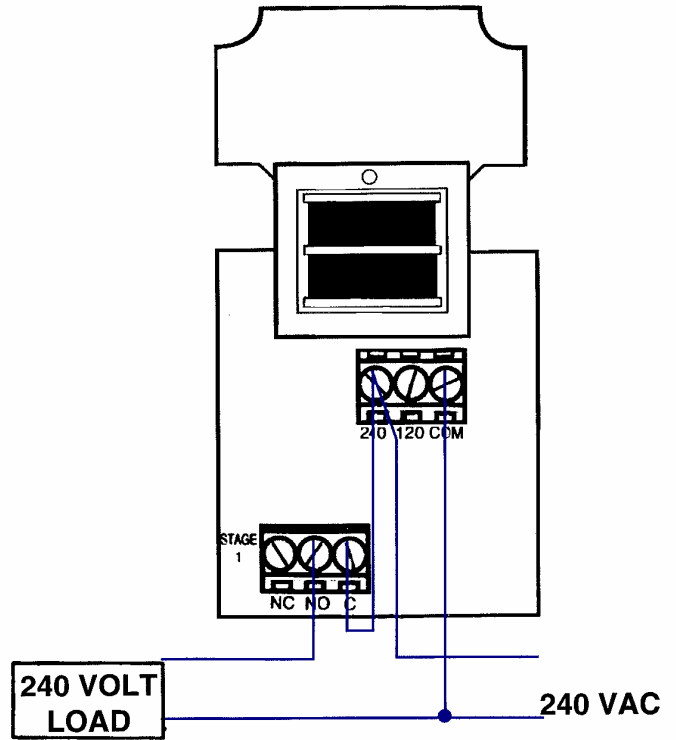

Figure 5: Typical Wiring Diagram for 240 VAC Power Input and Line Voltage Switching.

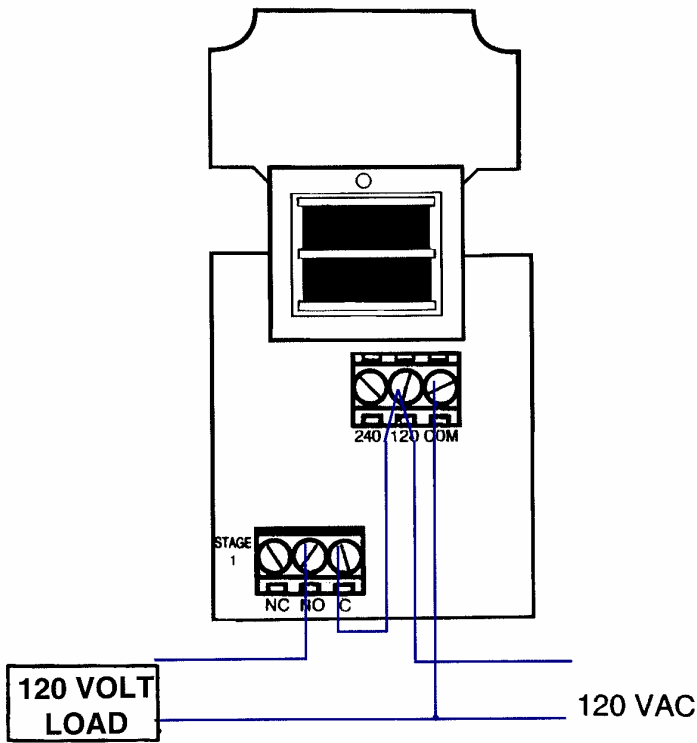

Figure 4: Typical Line Voltage Wiring Diagram.

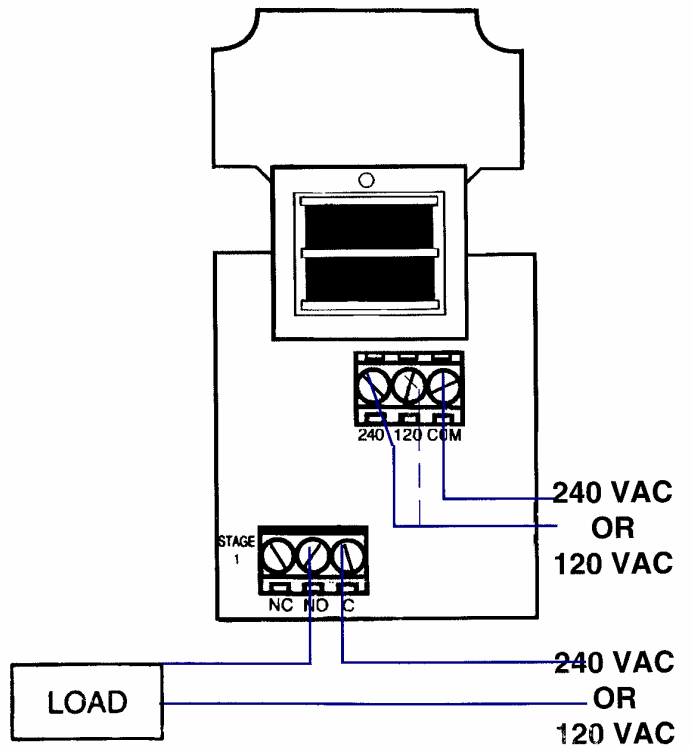

Figure 6: Different Voltage to Control and Different Voltage Load.

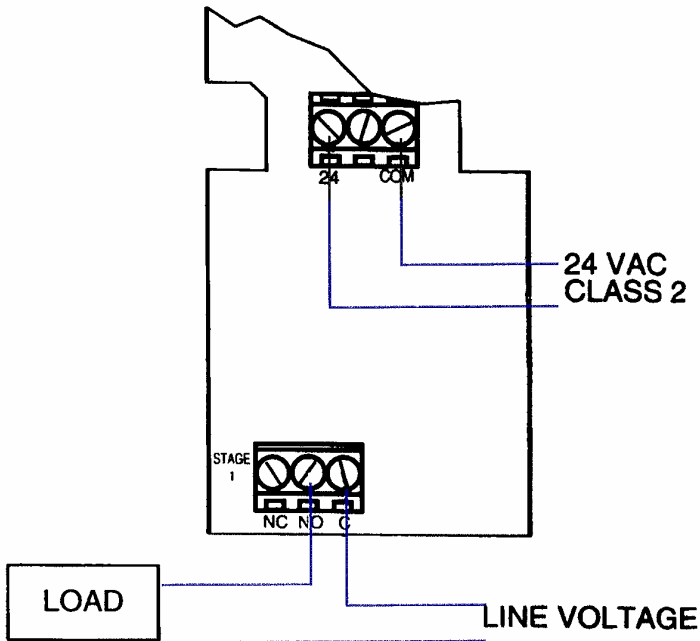

Figure 7: Typical Wiring Diagram for 24 VAC Power Input and Line Voltage Switching.

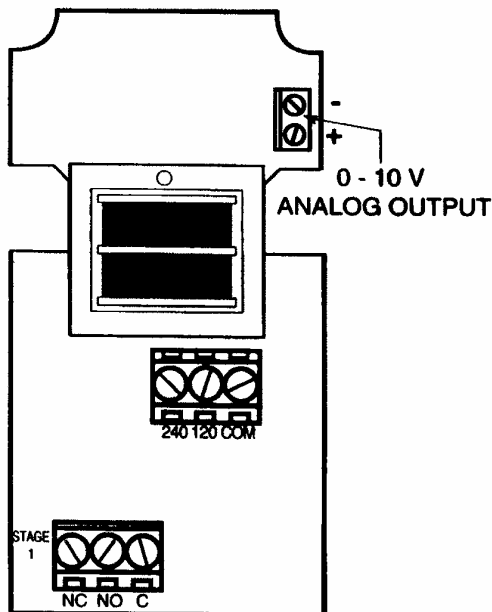

Figure 8: 0-10 V Analog Output Located on Power (Lower) Circuit Board.

FIELD REPAIRS

Field calibrating or repairs to the ETC control must not be attempted. Sensors and replacement controls are available through Ranco wholesalers.

SENSOR MOUNTING

For space sensing, mount the sensor where it will be unaffected by heat/cool discharge or radiated heat sources. Spot sensing requires the sensor to be in good contact with the surface being sensed. The sensor can be inserted in a bulb well for immersion sensing.

EXTENDING SENSOR

CAUTION: Sensor wiring splices may be made external from the control. **DO NOT** attempt to unsolder the sensor at the control circuit board!

CAUTION: Disconnect power to control before wiring to avoid possible electrical shock or damage to the controller.

Additional cable can be spliced to the sensor cable to increase the length beyond the standard 8 feet. It can be extended up to 400 feet. The cable should be at least 22 AWG or larger to keep additional resistance to a minimum.

All splices and wire lengths added to the sensor cable should be made according to acceptable wiring practices and should conform to the National Electrical Code and local regulations. Use copper conductors only. Shielded cable is not required.

Checkout Procedure

1. Before applying power, make sure installation and wiring connections are correct.
2. Apply power to the control and observe one or more cycles of operation.
3. If performance indicates a problem, check sensor resistance to determine if sensor or control is at fault.
4. To check sensor resistance, disconnect sensor and measure the resistance across the leads while measuring temperature at the sensor.

TEMPERATURE AVERAGING

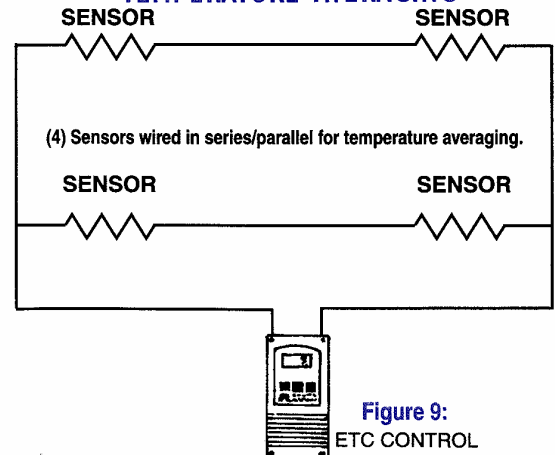

Figure 9:
ETC CONTROL

**Replacement Sensor - Order
Part No. 1309007-044**

SPECIFICATIONS

The 1309007-044 sensor is a negative temperature coefficient (NTC) thermistor sensor. The sensor resistance decreases with temperature increase. It is .25 x 1.94 long with 8 feet #22 AWG cable. The thermistor has a reference resistance of 30,000 ohms at 77°F (25°C).

IMPORTANT

The schematic drawings and other information included in these instructions are for the purpose of illustration and general reference only. Ranco assumes no responsibility for any unconventional application of this control, unless such application has been approved in writing by Ranco.

**Sold By:
Honey Run Apiaries**

**330 Sunderland Road
Delphos, Ohio 45833**

419-371-1742

www.HoneyRunApiaries.com
tarheit@honeyrunapiaries.com

ETC-111000-000 ..\$59.99*

ETC-111100-000 ..\$74.99*

1309007-044\$18.99*

*Prices subject to change. Call or visit the website for current pricing information.

Deg. C.	Deg. F.	RES. Nom.
-40	-40	1,010,000
-30	-22	531,000
-20	-4	291,200
-10	14	166,000
0	32	97,960
10	50	59,700
20	68	37,470
25	77	30,000
30	86	24,170
40	104	15,980
50	122	10,810
60	140	7,464
70	158	5,200
80	176	3,774
90	194	2,753
100	212	2,036
110	230	1,531

Figure 10 :

Resistance vs Temperature of 1309007-044. Sensor including 8 foot cable.



RANCO

**Ranco North America
8115 U.S. Rt. 42 North
Plain City, Ohio 43064**



An Invensys Company