



The The next generation laminate flooring is here.

**NexxaCore**<sup>TM</sup>  
The next generation flooring

Introducing the Next Generation of Laminate Flooring.

NexxaCore is proud to offer the latest flooring that redefines the previous image of laminate flooring. This new generation of performance laminate flooring passes NexxaCore's quality standards and offers exceptional durability and aesthetic style within two collections, **IKEBANA** and **BONSAI**.

From the AC4 Commercial Melamine Wear Layer featuring Aluminum Oxide to the innovative NexxaCore HDF-5 Core, this flooring offers unparalleled water resistance and stability. The included 3mm EVA underlayment ensures a quiet and comfortable living environment, and its organic, biodegradable fiberwood core brings it closer to real hardwood floors.

However, what truly distinguishes NexxaCore is its fashion style. Curated with the top trending colors by our designers, this performance laminate flooring is on the cutting edge of interior design, offering a range of clean, wide neutrals and rich brown tones.

The Matte Zero Finish technology brings a high quality, low gloss finish for authentic, oil-finished flooring looks. The flooring is resistant to wear, stains, and impacts, making it ideal for both residential and medium commercial spaces. Moreover, it's Floorscore Compliant for Indoor Air Quality, with no detectable formaldehyde, and can be installed in areas prone to moisture.

Elevate your space with NexxaCore's next generation laminate flooring – the perfect fusion of style and functionality.





NexxaCore™  
**HDF5**

**Introducing NexxaCore HDF5 organic fiber cores**

Nexxacore features a high-density, organic fiberwood core featuring proprietary 5% maximum flooring thickness swell rate per North American Laminate Flooring Association (NALFA) LF-01 Sect 3.2. This 24hr testing measures the ability of laminate flooring to resist increase in thickness after being exposed to water. A thickness swell rate under 10% means little to no noticeable change in flooring bevel edge or flooring surface lift.

**Thickness Swell Rate Test Results**

Swell rates measures how flooring reacts to moisture—critical for lasting quality. A higher swell rate means the planks are absorbing more water.

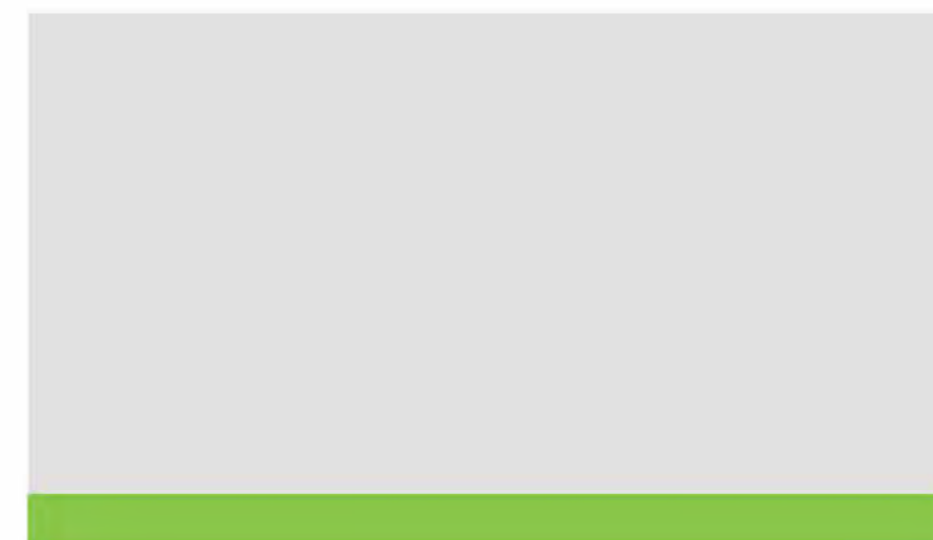

**NEXXACORE PERFORMANCE LAMINATES**

Swell Rate 5% (EXCELLENT)

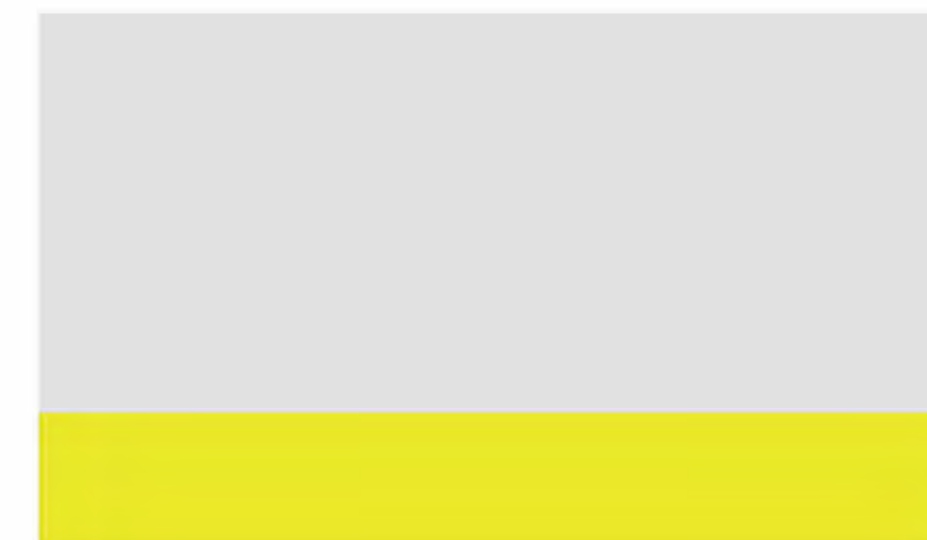

**LEADING "WATERPROOF" LAMINATES**

Swell Rate 10% (AVERAGE)



**STANDARD LAMINATES**

Swell Rate 18% (POOR)



Featuring NexxaCore HDF-5™ organic fiber cores

# NexxaCore™ HDF5

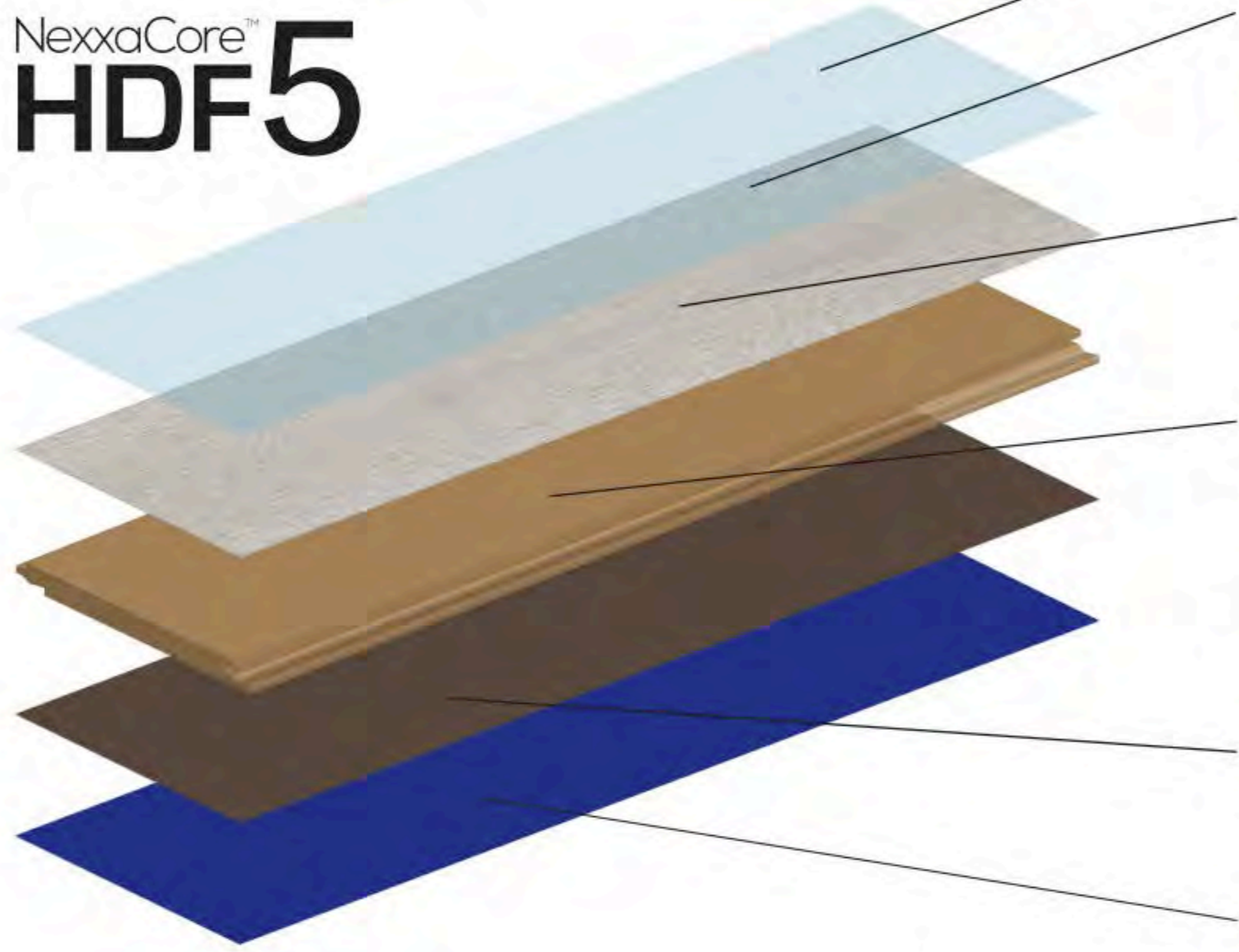

**Matte Zero Finish Technology**

**AC4 Overlay**  
Commercial Abrasion Class  
Melamine Wear Layer with  
Aluminum Oxide

**Wood Vision™ 3D**  
HD Visual Decorpaper with  
Dynamic EIR Texturetech

**NexxaCore HDF-5™ Core**  
12mm. Superior 5% Max Swell  
Rate (vs. Industry residential  
18%; NALFA LF-01 Sec 3.2)  
Organic-based Fibers,  
Recyclable, Degradeable

**Balancing Layer**  
Melanine Film

**Silencio™ Performance Underlay**  
Attached Acoustic & Impact  
Rated Underlayment (3 mm)





# IKEBANA



Ultra wide, ultra long

the IKEBANA COLLECTION showcases a clean, understated color palette to let you truly express yourself. It's ultra-wide 9.3" x 72.25" planks add a sense of expansiveness to any room. Relax and enjoy this premiere collection knowing that it's water-resistant and the multi-layer construction makes it as sturdy as it is beautiful.



# IKEBANA

Ultra wide, ultra long

Plank size: 9.3" x 72"

15mm overall thickness

12mm core + 3mm EVA pad

Pattern Repeat every 10 planks

AC4 Wear Layer

30° micro-bevel

EIR texture

Uniclic locking

Lifetime residential

10-year medium commercial

18.65 sf/ctn

60 ctns/plt

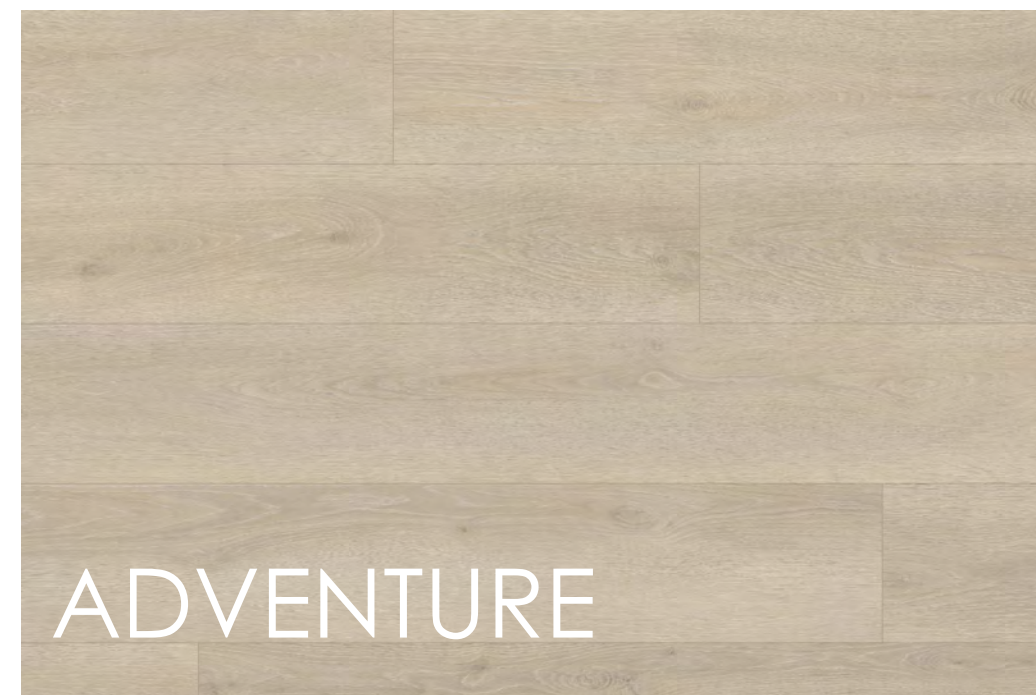

ADVENTURE



# IKEBANA

Ultra wide, ultra long

Plank size: 9.3" x 72"

15mm overall thickness

12mm core + 3mm EVA pad

Pattern Repeat every 10 planks

AC4 Wear Layer

30° micro-bevel

EIR texture

Uniclic locking

Lifetime residential

10-year medium commercial

18.65 sf/ctn

60 ctns/plt

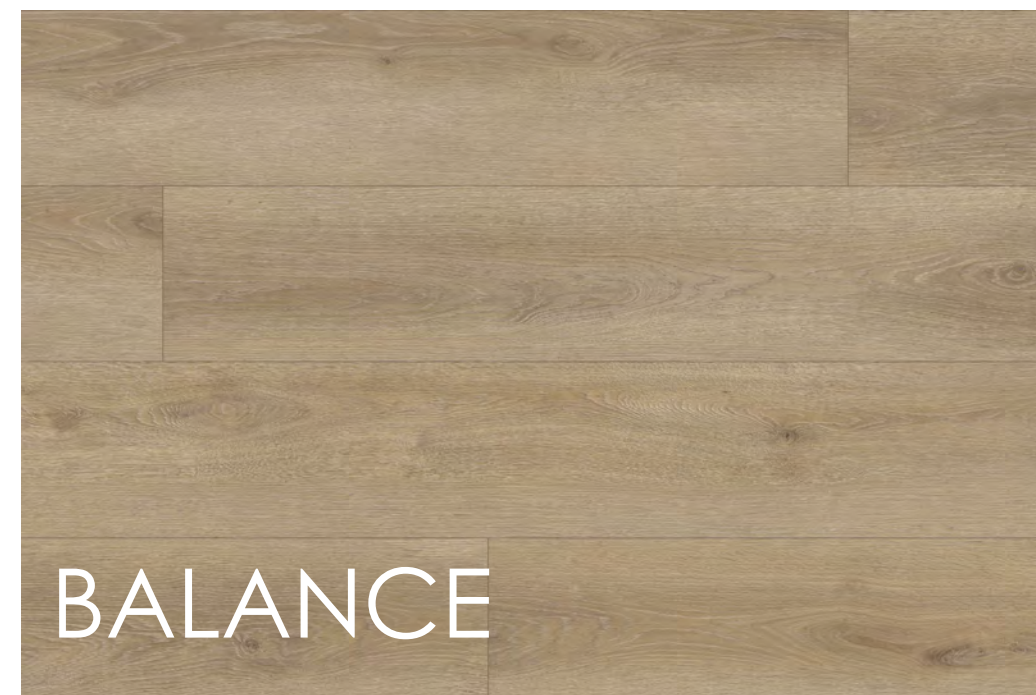

# IKEBANA

Ultra wide, ultra long

Plank size: 9.3" x 72"

15mm overall thickness

12mm core + 3mm EVA pad

Pattern Repeat every 10 planks

AC4 Wear Layer

30° micro-bevel

EIR texture

Uniclic locking

Lifetime residential

10-year medium commercial

18.65 sf/ctn

60 ctns/plt

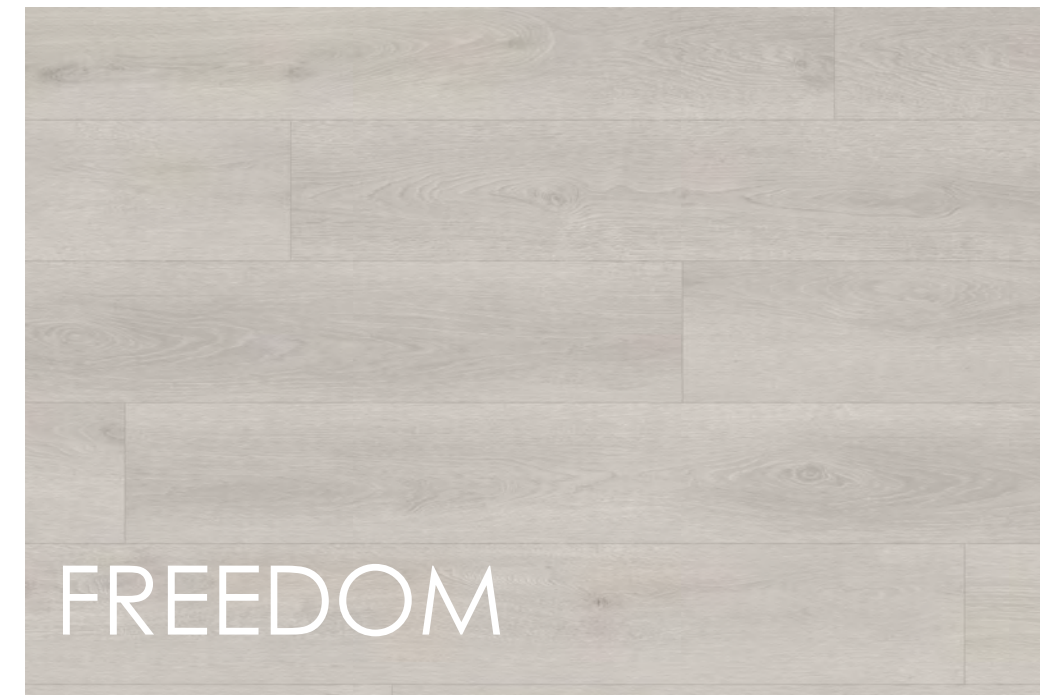

# IKEBANA

Ultra wide, ultra long

Plank size: 9.3" x 72"

15mm overall thickness

12mm core + 3mm EVA pad

Pattern Repeat every 10 planks

AC4 Wear Layer

30° micro-bevel

EIR texture

Uniclic locking

Lifetime residential

10-year medium commercial

18.65 sf/ctn

60 ctns/plt

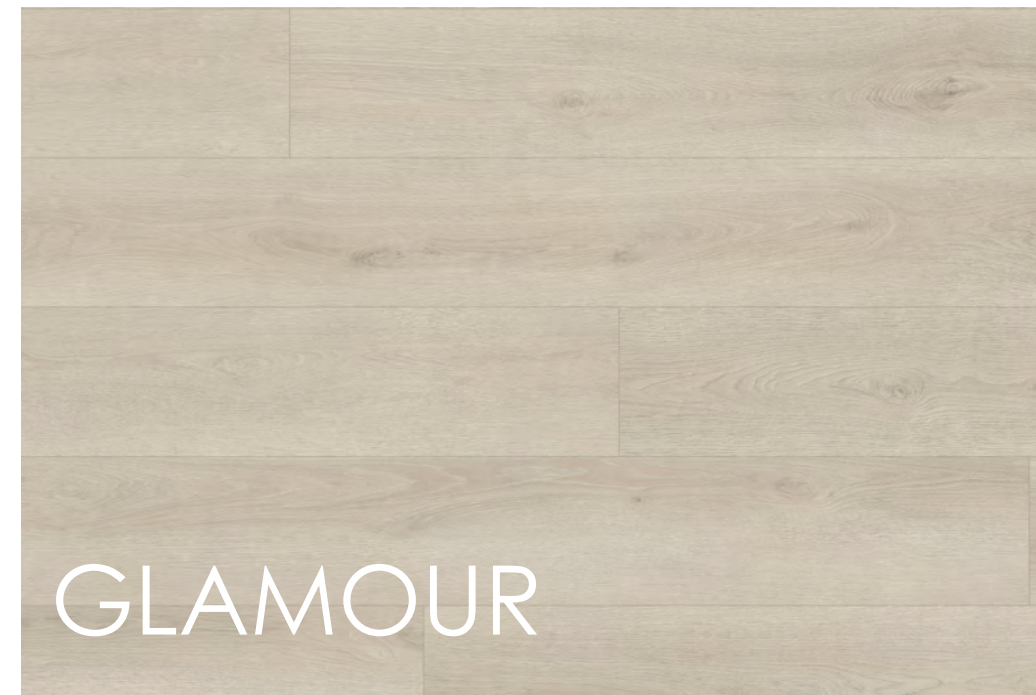

# IKEBANA

Ultra wide, ultra long

Plank size: 9.3" x 72"

15mm overall thickness

12mm core + 3mm EVA pad

Pattern Repeat every 10 planks

AC4 Wear Layer

30° micro-bevel

EIR texture

Uniclic locking

Lifetime residential

10-year medium commercial

18.65 sf/ctn

60 ctns/plt



# IKEBANA

Ultra wide, ultra long

Plank size: 9.3" x 72"

15mm overall thickness

12mm core + 3mm EVA pad

Pattern Repeat every 10 planks

AC4 Wear Layer

30° micro-bevel

EIR texture

Uniclic locking

Lifetime residential

10-year medium commercial

18.65 sf/ctn

60 ctns/plt

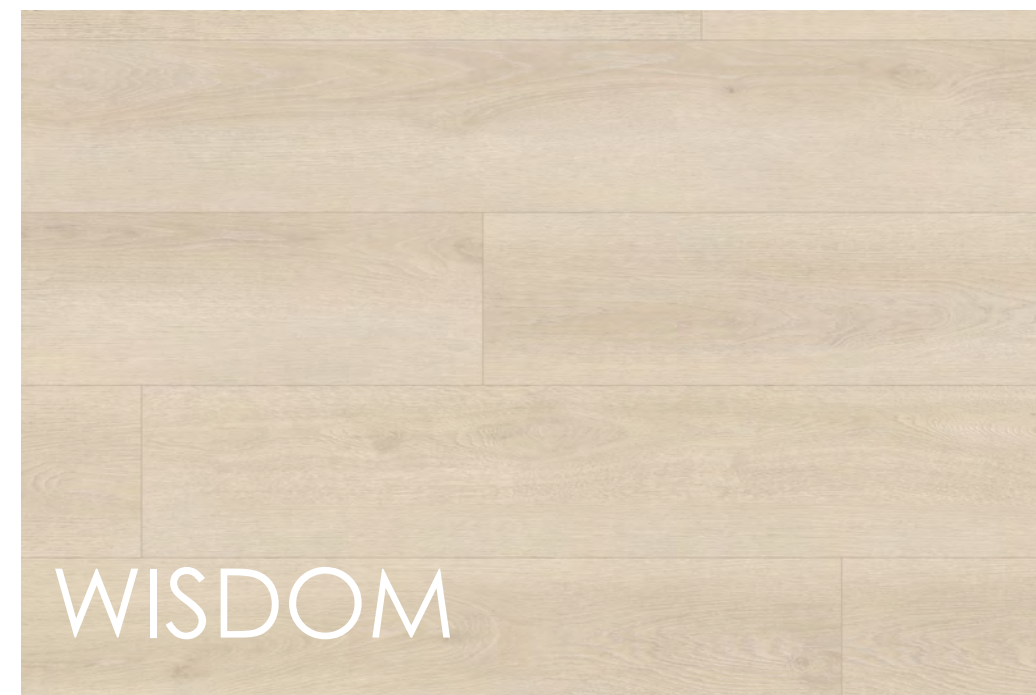



# BONSAI

Redefining standard laminate

The BONSAI COLLECTION is the premiere next generation performance laminate flooring offering classic colors with a modern design. Ideal for any living space, BONSAI features earthy warm neutrals with planks that measure 7.67" wide by 60" long for a striking look. The multi-layer construction and water-resistant features ensure its durability, making it an ideal choice for active families. Redefine your living space with the BONSAI COLLECTION.



# BONSAI

Redefining standard laminate

Plank size: 7.67" x 60"

15mm overall thickness

12mm core + 3mm EVA pad

Pattern Repeat every 6 planks

AC4 Wear Layer

30° micro-bevel

EIR texture

Uniclic locking

Lifetime residential

10-year medium commercial

19.08 sf/ctn

50 ctns/plt

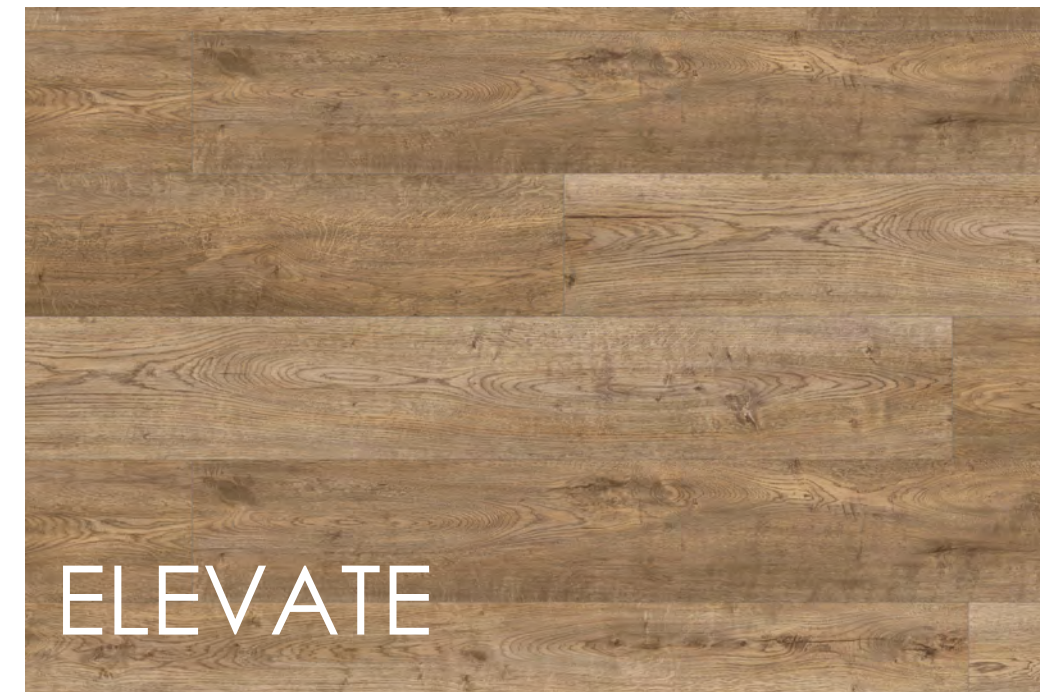

# BONSAI

Redefining standard laminate

Plank size: 7.67" x 60"

15mm overall thickness

12mm core + 3mm EVA pad

Pattern Repeat every 6 planks

AC4 Wear Layer

30° micro-bevel

EIR texture

Uniclic locking

Lifetime residential

10-year medium commercial

19.08 sf/ctn

50 ctns/plt



# BONSAI

Redefining standard laminate

Plank size: 7.67" x 60"

15mm overall thickness

12mm core + 3mm EVA pad

Pattern Repeat every 6 planks

AC4 Wear Layer

30° micro-bevel

EIR texture

Uniclic locking

Lifetime residential

10-year medium commercial

19.08 sf/ctn

50 ctns/plt



# BONSAI

Redefining standard laminate

Plank size: 7.67" x 60"

15mm overall thickness

12mm core + 3mm EVA pad

Pattern Repeat every 6 planks

AC4 Wear Layer

30° micro-bevel

EIR texture

Uniclic locking

Lifetime residential

10-year medium commercial

19.08 sf/ctn

50 ctns/plt

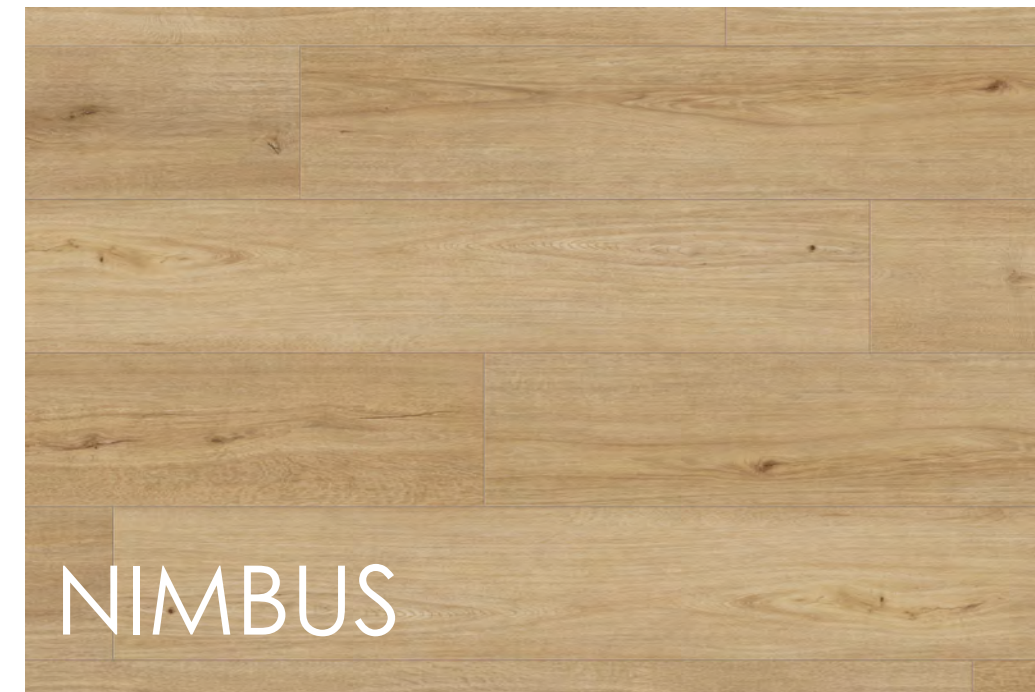

# BONSAI

Redefining standard laminate

Plank size: 7.67" x 60"

15mm overall thickness

12mm core + 3mm EVA pad

Pattern Repeat every 6 planks

AC4 Wear Layer

30° micro-bevel

EIR texture

Uniclic locking

Lifetime residential

10-year medium commercial

19.08 sf/ctn

50 ctns/plt

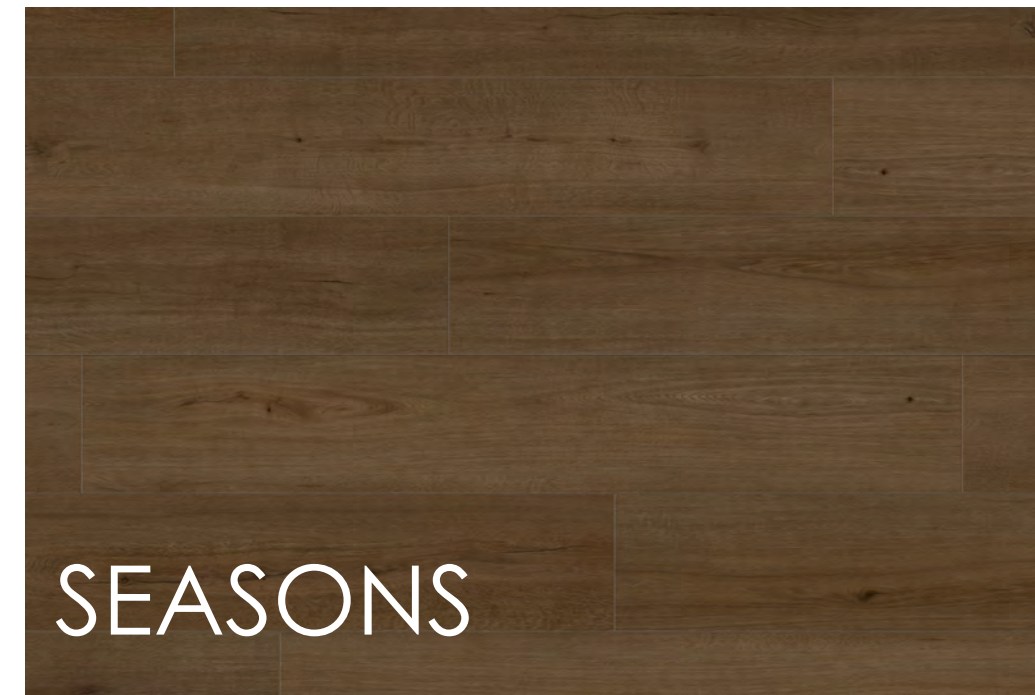

# BONSAI

Redefining standard laminate

Plank size: 7.67" x 60"

15mm overall thickness

12mm core + 3mm EVA pad

Pattern Repeat every 6 planks

AC4 Wear Layer

30° micro-bevel

EIR texture

Uniclic locking

Lifetime residential

10-year medium commercial

19.08 sf/ctn

50 ctns/plt

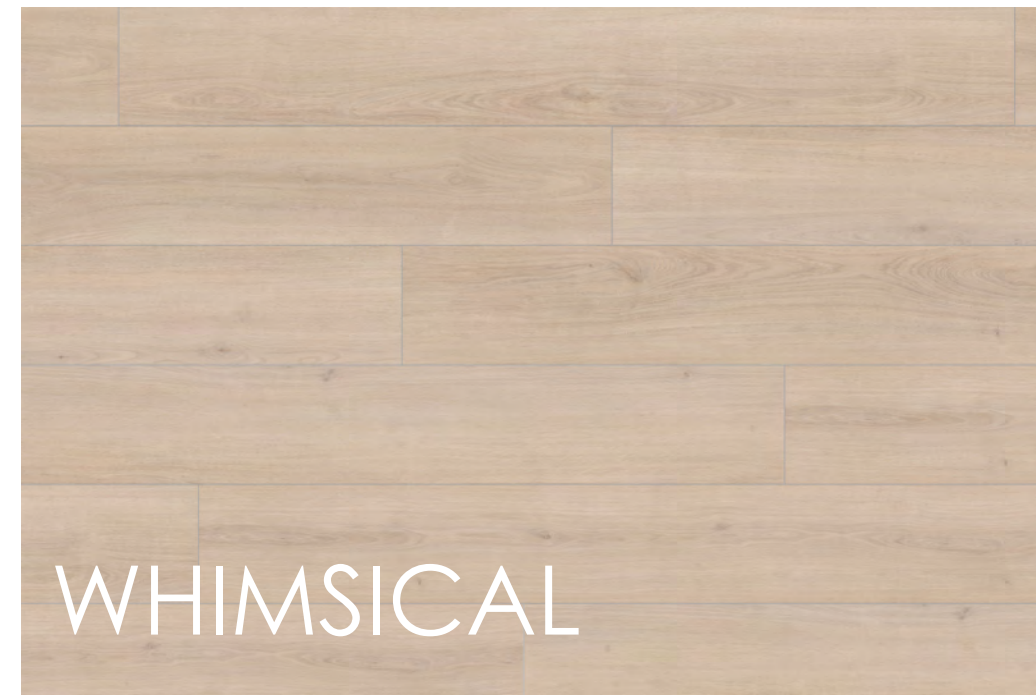

# TRANSITIONS

Water-resistant HDF mouldings

94" Reducer

94" T-moulding

94" End-cap

94" Quarter round

94" Flush square stairnose

94" Flush stairnose

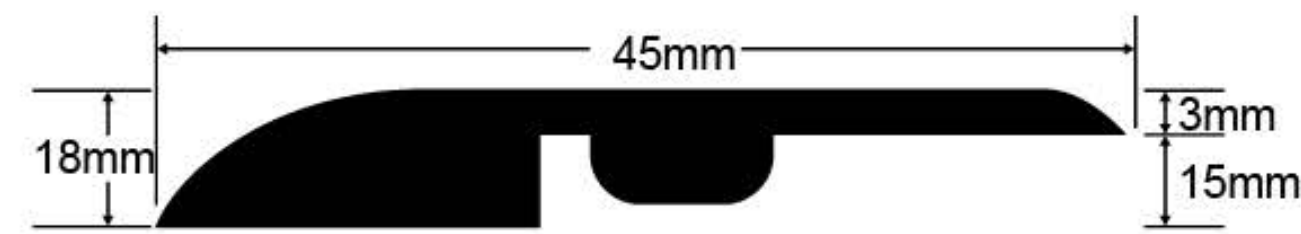

*Reducer*

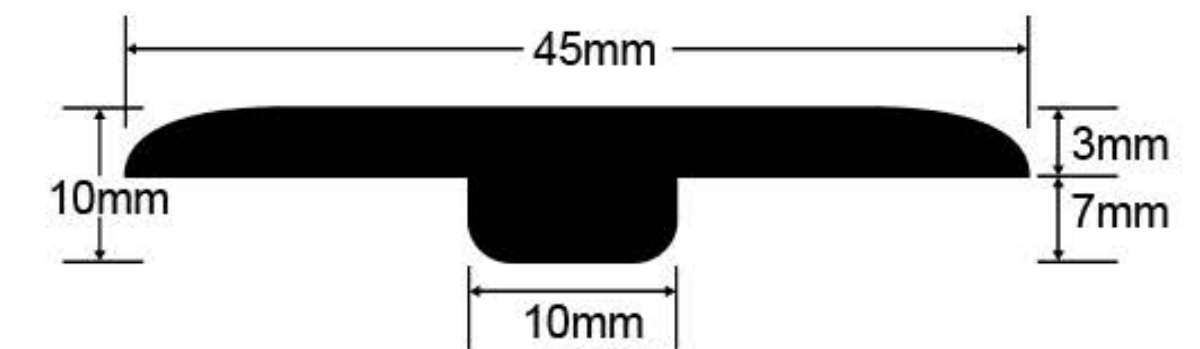

*T-moulding*

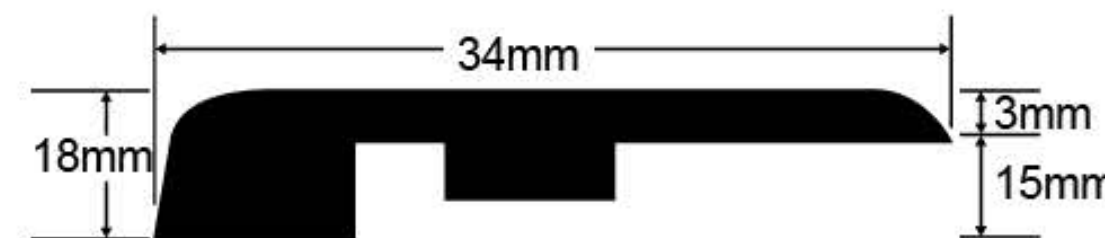

*End-cap*

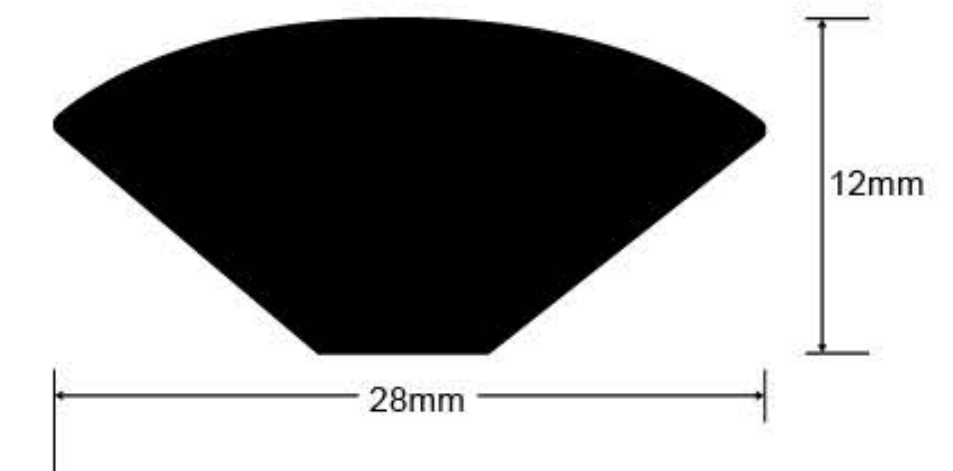

*Quarter round*



*Flush square stairnose*

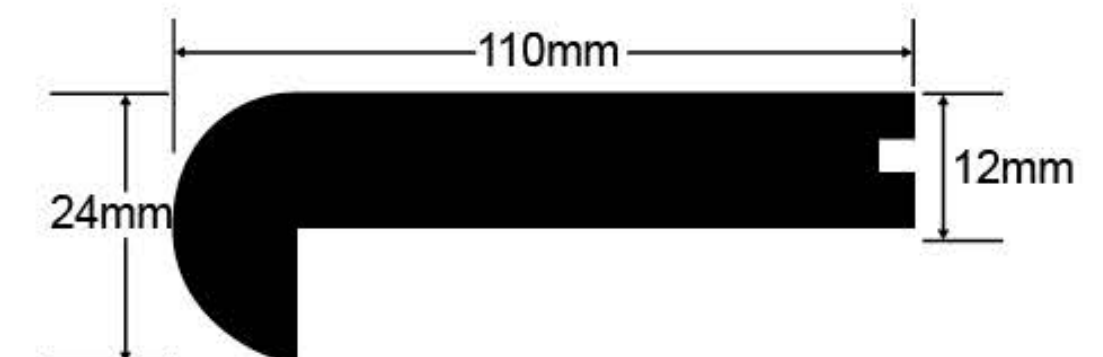

*Flush stairnose*

## DISPLAY 12 SKU Waterfall

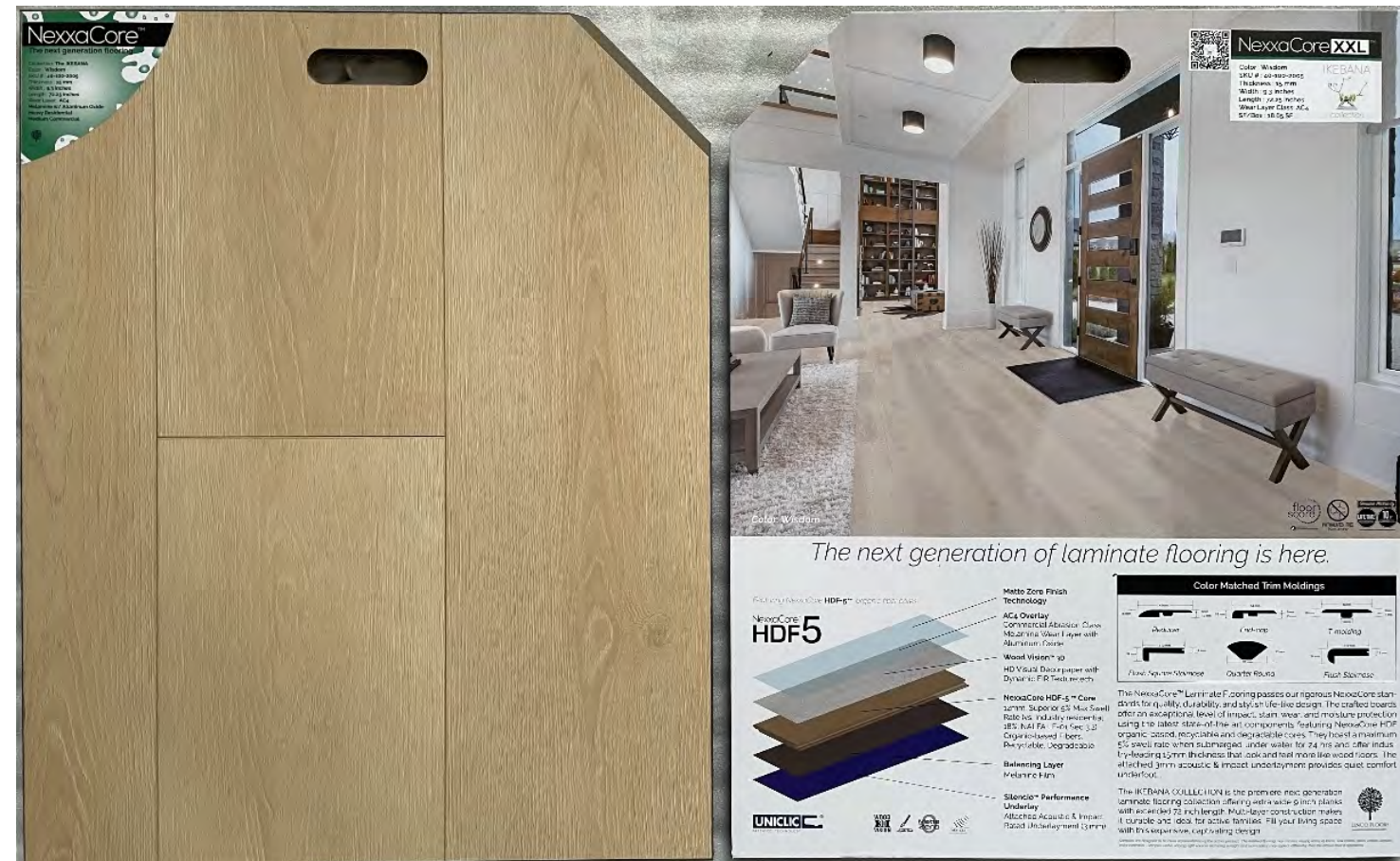

POP color back labels showcase key product features and view in room QR codes



<p>SEE THIS IN MY ROOM</p>  <p><b>Freedom</b> Ikebana 2001</p>	<p>SEE THIS IN MY ROOM</p>  <p><b>Seasons</b> Bonsai SH013-54</p>	<p>SEE THIS IN MY ROOM</p>  <p><b>Glamour</b> Ikebana 2002</p>	<p>SEE THIS IN MY ROOM</p>  <p><b>Elevate</b> Bonsai 15003-1</p>
<p>SEE THIS IN MY ROOM</p>  <p><b>Nimbus</b> Bonsai SH013-52</p>	<p>SEE THIS IN MY ROOM</p>  <p><b>Posh</b> Ikebana 2004</p>	<p>SEE THIS IN MY ROOM</p>  <p><b>Adventure</b> Ikebana 2003</p>	<p>SEE THIS IN MY ROOM</p>  <p><b>Balance</b> Ikebana 2006</p>
<p>SEE THIS IN MY ROOM</p>  <p><b>Whimsical</b> Bonsai 15050-1</p>	<p>SEE THIS IN MY ROOM</p>  <p><b>Elusive</b> Bonsai 15003-4</p>	<p>SEE THIS IN MY ROOM</p>  <p><b>Generations</b> Bonsai SH013-53</p>	<p>SEE THIS IN MY ROOM</p>  <p><b>Wisdom</b> Ikebana 2005</p>



**NexxaCore**<sup>TM</sup>  
The next generation flooring  
**BOLICK DISTRIBUTORS**  
[www.bolickdistributors.com](http://www.bolickdistributors.com)

