

IMPACT

A BETTER FLOOR

LUXURY VINYL PLANK

OPULENCE

2.0 MM

RESPONSIVE



OPULENCE

LUXURY VINYL PLANK

RESPONSIVE



SIZE: 7.25" x 48"

THICKNESS: 2.0 MM

WEAR LAYER: 12 MIL | 0.30 MM

PIECES: 20 PER CARTON

COVERAGE: 48.33 SF / CARTON | 4.49 M2 / CARTON

INSTALLATION: DRY BACK, GLUE DOWN LVP

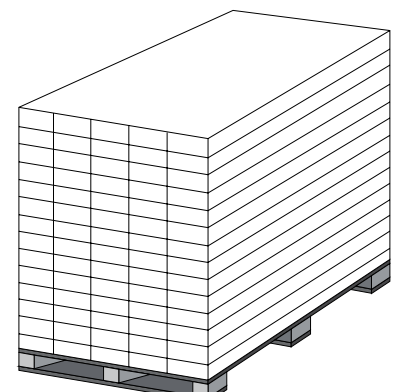
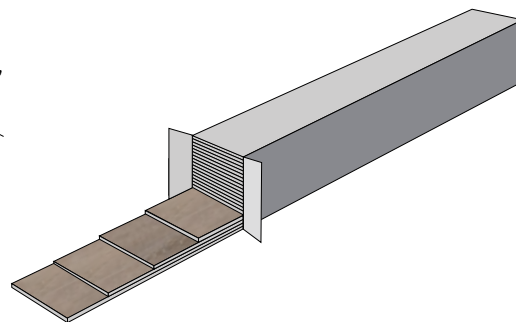
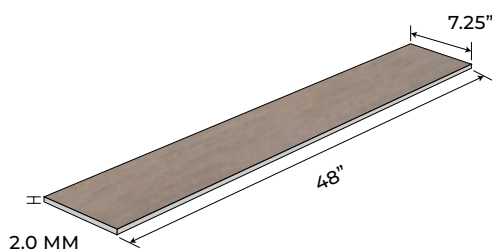

7.25" x 48" x 2.0 mm
185 mm x 1219 mm x 2.0 mm
12 MIL / 0.30 mm

20 PCS / CARTON
48.33 SQ.FT / CARTON
4.49 SQ.M / CARTON

70 CARTONS / PALLET

Luxury Vinyl Planks For Light To Heavy Commercial | PUR Polyurethane Reinforcement | Product Standard: ISO 10582

CERTIFICATION & CLASSIFICATION	STANDARD	IMPACT OPULENCE
TYPE OF FLOOR COVERING	ISO 10582	LUXURY VINYL PLANK
CE CERTIFICATION	EN 14041	Yes
CLASSIFICATION	EN ISO 10874	Commercial : 31 Heavy Commercial : 34

TECHNICAL CHARACTERISTICS	STANDARDS	IMPACT OPULENCE
TOTAL THICKNESS	EN ISO 2436 (EN 428)	2.0 MM (2.5mm / 3.0mm AVL on demand)
WEAR LAYER THICKNESS	EN ISO 24340 (EN 429)	0.30 MM (0.50 / 0.70 AVL on demand)
SURFACE TREATMENT	UV TREATED	PUR
TOTAL WEIGHT	EN ISO 23997 (EN 430)	3300 g/m ²
WEAR LAYER BINDER CONTENT	ISO 10582	TYPE I
FORM OF DELIVERY	EN ISO 24342 (EN 427) Planks box	7.25" X 48" 20 Planks / Carton = 48.33 SF 185 X 1219 mm 20 Planks / Carton = 4.49 m ²

TECHNICAL PERFORMANCES	STANDARDS	IMPACT OPULENCE
DIMENSIONAL STABILITY	EN ISO 23999 (EN 434)	Pass
REACTION TO FIRE	EN 13501 – 1	Bfl- S1 glued over A2fl substrate (concrete)
RESIDUAL INDENTATION	EN ISO 24343-1 (EN 433)	Pass
FURNITURE LEG	EN 424	No Damage
CASTOR CHAIR	EN ISO 4918 (EN 425)	No Damage
CURL RESULTANT TO HEAT	EN ISO 23999 (434)	Pass
THERMAL RESISTANCE	EN ISO 10456	0.07 M2 K/W
LIGHT FASTNESS	EN ISO 105 – B02	>Grade 6 Pass
RESISTANCE TO CHEMICALS	EN ISO 26987 (EN423)	Good Resistance Pass
SLIP RESISTANCE	DIN51130 EN 13893	R9 Class DS
ELECTRICAL PROPERTIES	EN 1815 EN 1081	<2kV on concrete R1 > 10 ¹⁰ Ω



ISO 9001
ISO 14001
ISO 18001



EN 14041



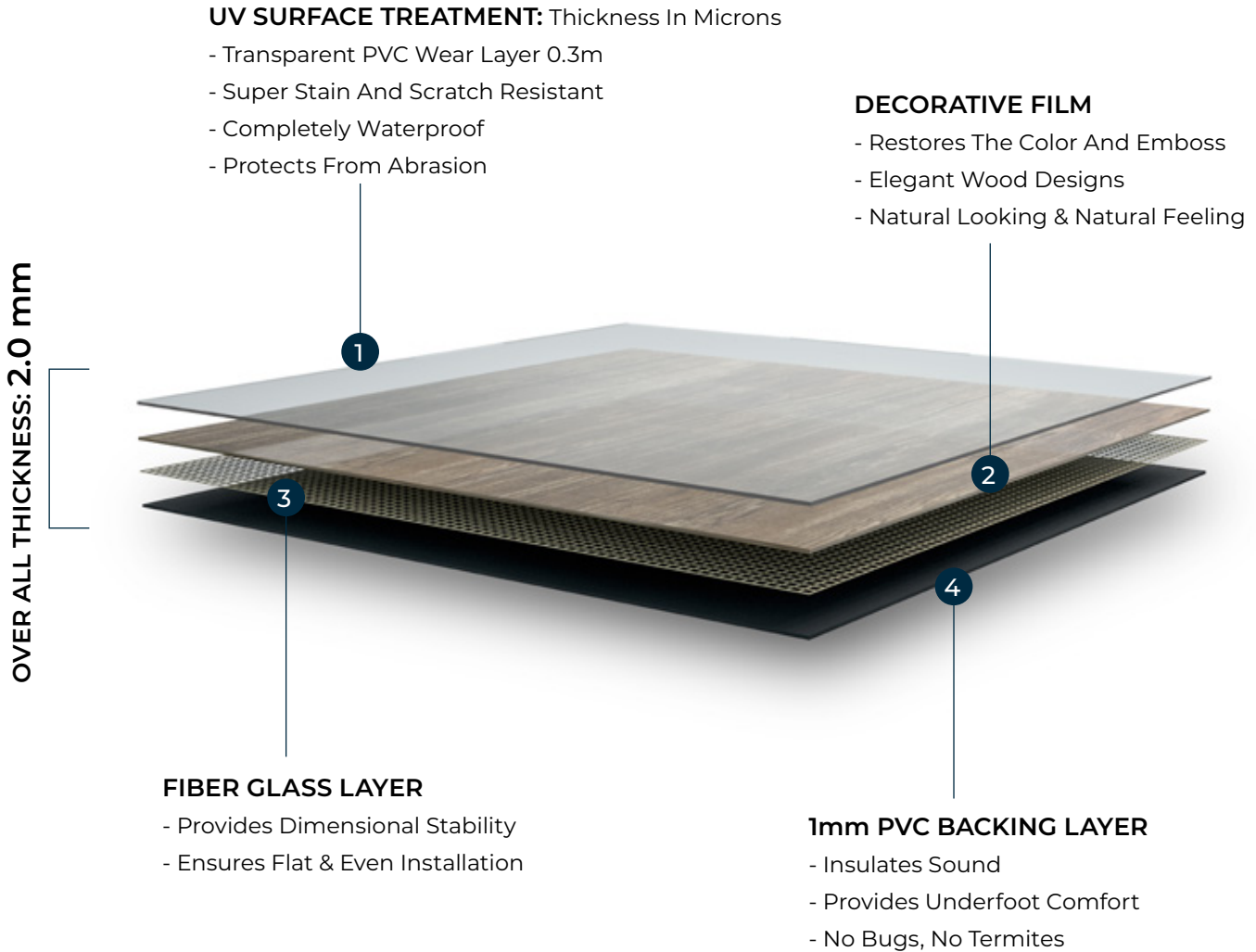

FEATURES & BENEFITS



Superior Scratch
& Stain Resistant



Zero
Maintenance



Easy
Clean



Natural Looking
Design



Heavy
Foot Traffic



Easy
Installation

APPLICATIONS



Corporate Offices



Residential



Retail



Hospitality

LIGHT NAVAJO

IMP-OPL-01

RESPONSIVE 

IMPACT
A BETTER FLOOR

LIGHT NAVAJO

IMP-OPL-01

RESPONSIVE



A

B

C

D

E

F

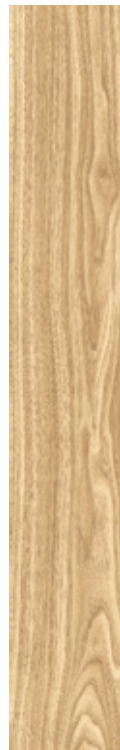
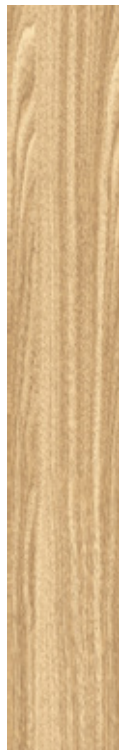
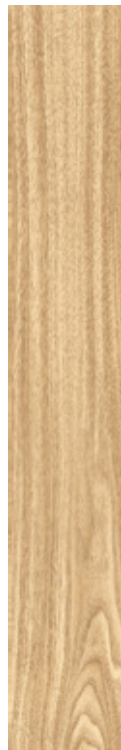

WILD CUMARU

IMP-OPL-04

RESPONSIVE 

IMPACT
A BETTER FLOOR

WILD CUMARU

IMP-OPL-04

RESPONSIVE



A

B

C

D

E

F

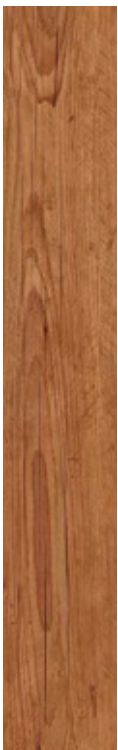

PROVINCIAL OAK

IMP-OPL-06

RESPONSIVE 

IMPACT
A BETTER FLOOR

PROVINCIAL OAK

IMP-OPL-06

RESPONSIVE 



A

B

C

D

E

F

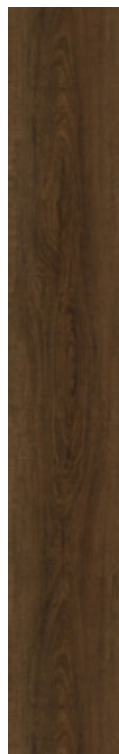
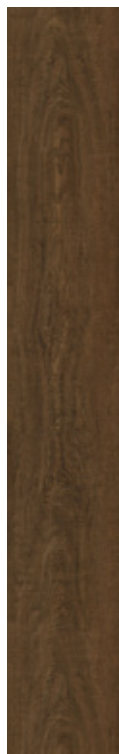
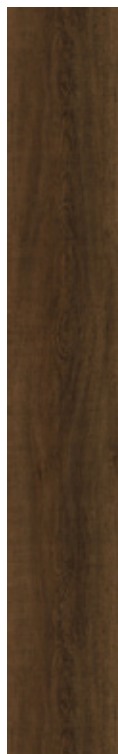
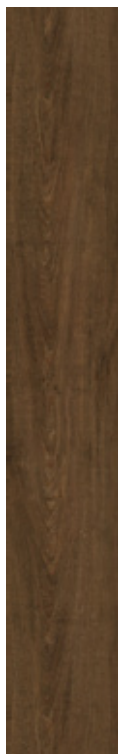
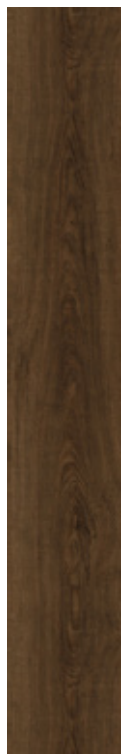
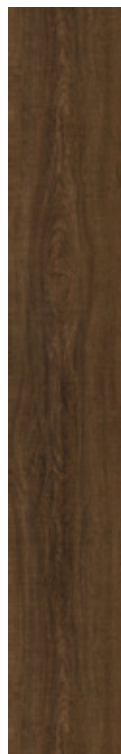

DISTRESSED GREY

IMP-OPL-09

RESPONSIVE 

IMPACT
A BETTER FLOOR

DISTRESSED GREY

IMP-OPL-09

RESPONSIVE



A

B

C

D

E

F

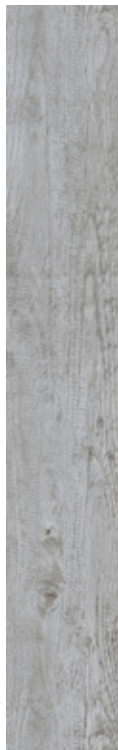

ARTISINAL OAK

IMP-OPL-11

RESPONSIVE 

IMPACT
A BETTER FLOOR

ARTISINAL OAK

IMP-OPL-11

RESPONSIVE



A

B

C

D

E

F

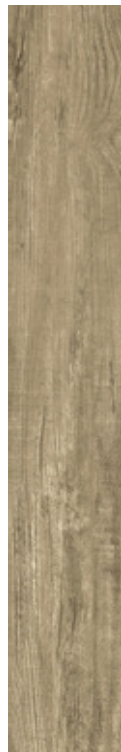

DRIFTWOOD STAIN

IMP-OPL-12

RESPONSIVE 

IMPACT
A BETTER FLOOR

DRIFTWOOD STAIN

IMP-OPL-12

RESPONSIVE 



A

B

C

D

E

F

