

Raynic

EP1001



USER MANUAL

✉ support@raynic.com

☎ +1(323)616-1209

Version 1.1

Raynic

CATALOG

FRAME OVERVIEW-	01
SPECIFICATIONS-	02
PACKING LIST-	03
INSTALLATION-	04
POWER ON THE DIGITAL PICTURE FRAME-	05
QUICK GUIDE FOR FRAMEO APP -	06
INSERTING AN EXTERNAL STORAGE-	10
WARRANTY -	11
SUPPORT-	11

FRAME OVERVIEW

- 1. 10.1" LCD Screen
- 2. Frame
- 3. White Matte
- 4. Power Button
- 5. Speaker
- 6. Wall Mount Hole
- 7. Frame Stand
- 8. Reset
- 9. Type C Port
- 10. TF(Micro SD) Card Slot
- 11. DC IN

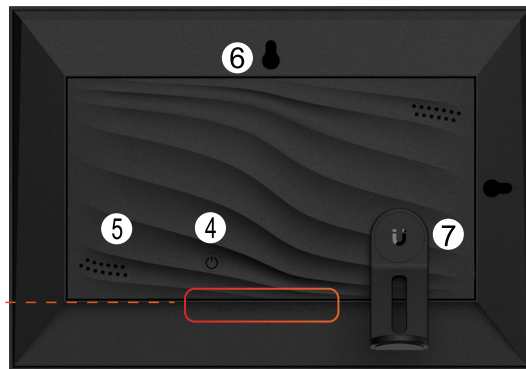

SPECIFICATIONS

Unit	10.1" Digital Picture Frame
Size	10.6*7.3*1 inch
Weight	1.28 Pound
Screen	10.1" Touchscreen (16:10)
Control Method	Touch
Resolution	1280*800 IPS HD Display
Memory Capacity	32GB
Built-in Speakers	2 x 2W Stereo
Card Type	TF(Micro SD)
Wi-Fi	2.4G
CPU	4-core A7 * 1.2G
AC Adapter	AC 100-240V~, 50/60 Hz input, DC5V = 2A output
Power Cord Jack	3.5*1.35mm

PACKING LIST



1x Digital Picture Frame

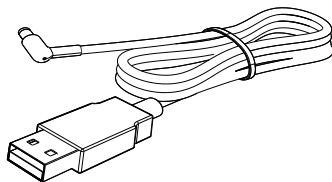

1x Power Cord

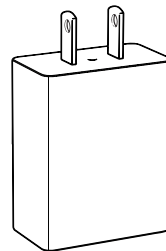

1x AC Adapter

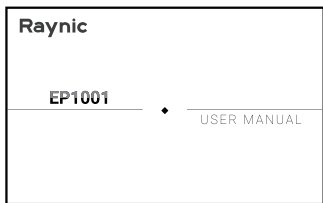

1x User Manual

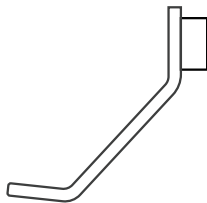

1x Stand Bracket

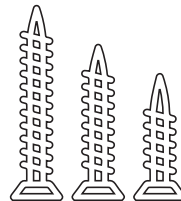

1x Wall-mounted Accessory Kit

INSTALLATION

For desktop use, simply insert the stand bracket.

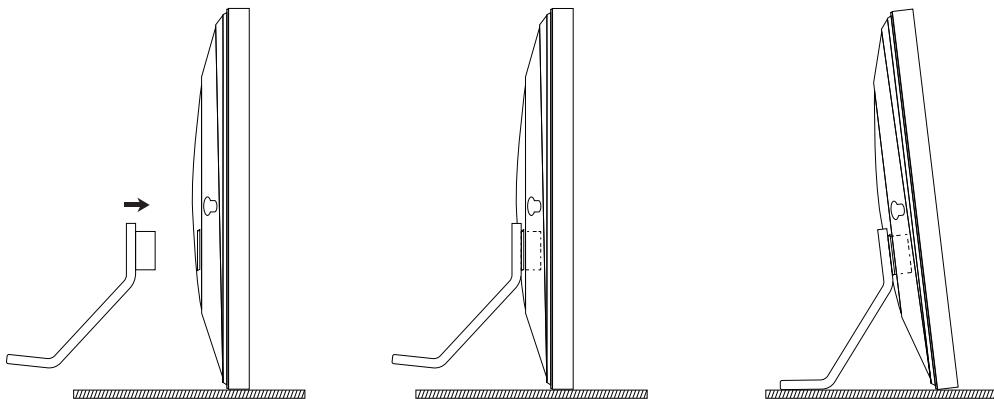

Please note:

When moving the frame, do not hold it by the magnetic stand bracket alone. Instead, hold both ends of the edge of the frame. Since the magnetic support is not strong enough, the machine may easily fall and be damaged.

☐ POWER ON THE DIGITAL PICTURE FRAME

Plug in the power adapter to power on the picture frame.

⚠ Please note:

- 1 Actuate the line adapter only with earthed plugs of AC 100-240V~, 50/60 Hz input, DC5V = 2A output.
- 2 Use the included line adapter and line connection cable only.
- 3 Do not use the Type-C connector to power this device. This interface is used to read data from the USB flash disks with type-c adapter, and also connect to the computer for data transfer.

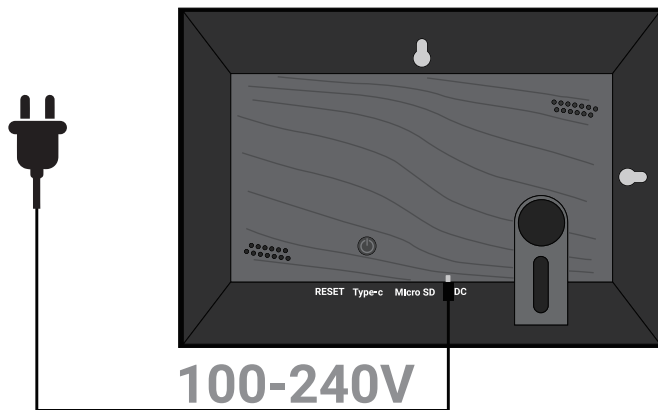

QUICK GUIDE FOR FRAMEO APP

Getting started

Congratulations on your brand new Frameo picture frame!

If you are new to using Frameo then start by following the Frameo quick setup or follow the on-screen guide when powering it on for the first time.

Once you have set up your Frameo frame, you can start connecting it to your friends and family.

Frameo app

To send photos to your frame, use the Frameo app for iOS or Android.



Frameo App

Instantly Share Photos & Videos



Video tutorials

Check out our “Frameo Tutorials” playlist on YouTube with informative videos where we guide you on how to get started using Frameo. Scan the code on the right or use the link to find the playlist.

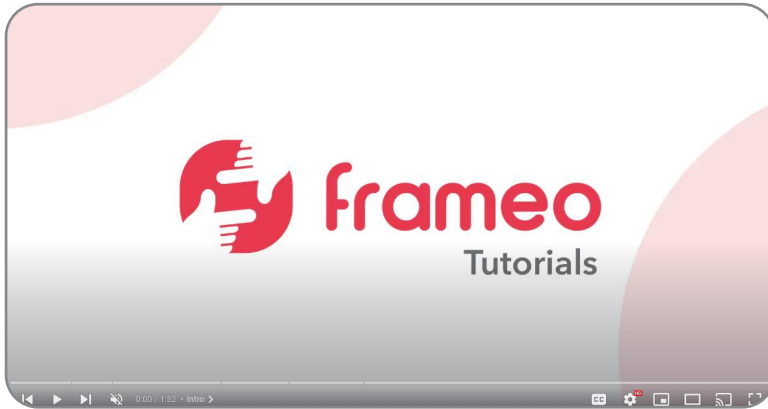

<https://raynic.com/frame-quick-guide>

Frameo quick setup

When starting your frame for the first time, you will need to set up the frame.

- 1 Select a language. This will be the language used on the Frameo.
- 2 Connect your frame to the internet by connecting it to Wi-Fi.
- 3 Verify or correct the date and time.
- 4 Frameo may ask you to update to the latest version. It is recommended to update your frame before continuing if asked to.
- 5 Enter your name, and the location where you have placed your frame e.g. “John Doe” and “Living room”, “Kitchen” or “Office”. Finally set the timezone if not already correct.

Start using Frameo

Next step is to connect Frameo with your friends and family by providing them with a code from your frame.

If you want to be able to send photos to the frame yourself, start by downloading the app for iOS or Android on App Store or Google Play. Then use the code to connect your frame and app as described below.

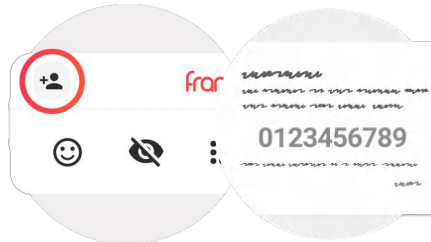

Connecting a new friend

- 1 Make sure that your friend has downloaded and installed the Frameo app. Click the add friend icon on your frame+ . A dialog will appear showing a connection code, which is valid for 12 hours.
- 2 Now share this code in whatever fashion you prefer e.g. SMS, E-Mail, IM, phone call, to your friend.
- 3 Once your friends have added the code in their Frameo app, they will automatically appear on your frame and be able to send you photos.



INSERTING AN EXTERNAL STORAGE

When inserting an external storage (eg. a Micro SD card), a menu will automatically appear with three options:

Press  to play photos Directly from the external storage, press  to import photos to the internal memory of your frame or press  to make a backup of your frame.

Please note:

- 1 External storage only supports 2 file formats: FAT32 and NTFS. Other formats may cause the external storage to become unreadable or the Frameo APP to crash.
- 2 Memory cards can display pictures directly, but do not support editing pictures. Please import photos into the frame for editing. The frame supports exporting photos to a memory card for backup or transferring to a computer.
- 3 Do not remove the memory card from the slot while pictures are still playing or the power is on. This may damage the frame or memory card. Be sure to turn off the power before removing the memory card.

WARRANTY

① Limited One-Year Warranty

We offer a one-year quality warranty on all products, valid from the date of purchase.

② Lifetime Free Support for Inquiries

Please don't hesitate to contact us if you have any questions about our products.

SUPPORT

Thanks for choosing Raynic digital photo frame. If you need further assistance, please contact our customer support team in the following ways:

 Our Website : **<https://www.raynic.com>**

 E-mail: **support@raynic.com**

 Phone Number: **+1(323)616-1209**

 Telephone Support: Mon-Thur, 18:00-21:00 PDT

Raynic

Live Easily and Enjoy Happiness!