

Contact our experts  
support@raynic.com

CR1009 meets the NWS evaluation criteria for NWR All Hazards logo use

**CR1009**

Emergency Alert Radio  
with AM/FM/SW/NOAA weather/Solar Crank

[Http://www.raynic.com](http://www.raynic.com)



Version 2.2

## Chapter 1 LOCATION OF CONTROLS

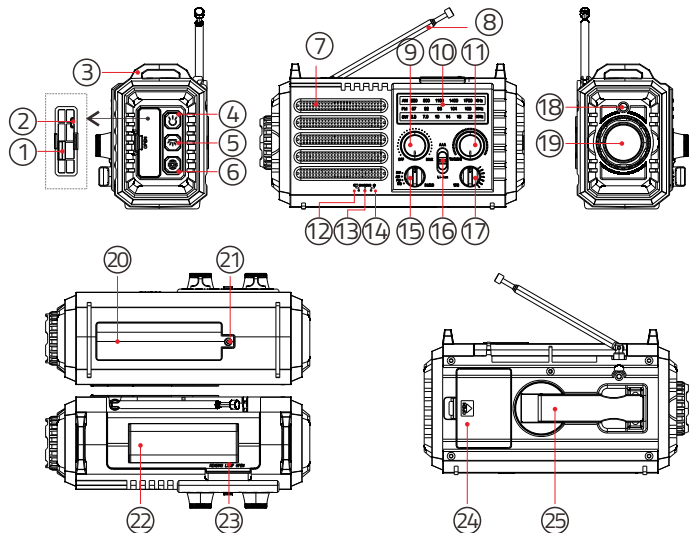

1. USB Output Charging Port
2. Micro USB Input charging Port for Built-in Battery
3. Carry Strap Holder
4. Flashlight Button
5. Reading Lamp Button
6. SOS Control Button
7. Speaker
8. Telescopic Antenna
9. Power ON/OFF & Volume Knob
10. Frequency Display
11. Turning Knob
12. Battery Indicator
13. Charging Indicator
14. Power On Indicator
15. Band Selector
16. Power Selector
17. Weather Band Selector
18. SOS Flashlight
19. Flashlight
20. 5000mAh Rechargeable Battery (included)
21. Battery Compartment Cover
22. Solar Panel
23. Reading Lamp
24. AAA Battery Compartment Cover
25. Crank Handle

## Chapter 2 POWER SUPPLY MODE

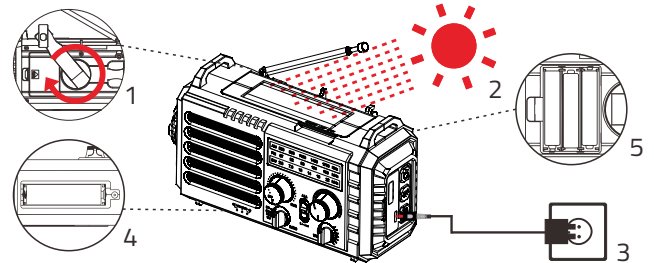

There are 5 power supply to power the radio:

### 1. Hand Crank Power

- (1) Unfold the crank handle from the backside and rotate it in either direction.
- (2) Rotate the crank handle, It will generate 300-350mA electricity to charge build-in 5000mAh rechargeable battery.

Note: Rotate the crack handle at the speed of 2 laps per second. It will generate 300-350mA electricity.

### 2. Solar Power

- (1) Expose the solar panel to sunlight, don't charge indoors.
- (2) It will generate 30-50mA electricity to charge build-in 5000mAh rechargeable battery.

Note: Solar panel will generate 30-50mA electricity when exposed to sunlight. It is difficult to fully charge the 5000mAh battery with solar panel, which is mostly used for maintaining the rechargeable battery.

### 3. Micro USB Adapter Charging input

- (1) Connect USB Cable(included) to a regular AC power adapter(not included).

- (2) Plug the USB cable into the Micro USB port of the radio.
- (3) Plug the AC adaper to a 110-220V standard outle.

It is highly recommended to use 5V/2A AC power adapter.



#### 4. Li-ion Rechargeable Battery

#### 5. AAA Batteries

- (1) Open the battery compartment on the back of the unit and insert 3pcs AAA batteries making sure the polarity is correct.
- (2) Set the Power Selector to AAA.

Note: In AAA batteries power mode, SOS alert sound is lower than li-ion battery power. Because the current of AAA battery is weaker than the current of li-ion battery.  
AAA batteries is not included.

### Chapter 3 POWER INDICATORS

 Flash every second	Li-ion battery power is LOW
 CHARGING	Li-ion battery power is charging
	The radio is on

### Chapter 4 CHARGING PHONE or PORTABLE DIGITAL DEVICE

Connect your phone charging cable with the USB output port on the back of the Radio.

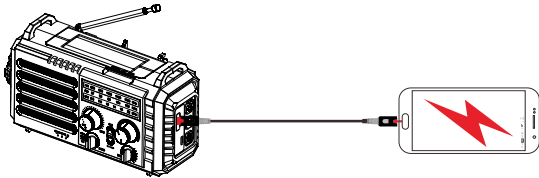

If the CR1009 has no power, you can rotate the crank handle for 8-15 minutes (The time depends on your speed of rotation). then your phone will get enough power to start up.

- 03 -

### Chapter 8 FLASHLIGHT

1. Click Flashlight Button to turn on flashlight.
2. Click Flashlight Button again, the flashlight will turned off.



### Chapter 9 RADIO OPERATION

1. Turn on radio  
Rotate the volume control knob away from the OFF position, the radio will turn on automatically.
2. Band Selector  
Rotate the band selector switch to choose the band you want to listen to. You can choose from the AM/FM, Shortwave and Weather Band.  
Weather Band: Receives all 7 weather band from NOAA, the U.S. National Weather Service which broadcasts in all 50 states, Puerto Rico and the U.S. Virgin Islands.  
AM Band: Receives all local AM stations from 520KHz to 1710 KHz.  
FM band: Receives all local FM stations from 87.00MHz – 108MHz.  
SW Band: Receives all Shortwave bands from 2.3MHz- 22Mhz  
Note: SW band allows you to listen to overseas broadcasts from stations like the BBC, Radio Moscow, Radio, France, Radio Beijing, Voice of America and more.
3. Volume Control  
Turn the volume control knob to adjust the sound volume of the radio.
4. Tuning  
Select the band you want to listen to, then turn the tuning knob slowly until you receive the desired station.  
Note:  
(1) When listening to FM/SW1/SW2 and Weather Band, please extend the telescopic antenna to receive the best signal. When listening to the AM stations, it is better to use it near a window or open space, in order to receive better signals.

- 05 -

Note: This feature is only for charging the USB devices during emergency.  
Don't use it as a normal power bank.  
The supplied charging cable is only for charging Micro USB device,  
Other USB devices should be charged with original charging cable.

### Chapter 5 POWER SWITCH

1. If you have installed AAA battery and intend to use it, please switch the "POWER" button to "AAA" side. Please use a little force when sliding the "POWER" button to make sure it gets to the MOST TOP to avoid the AAA power supply is not connected.
2. If you plan to use Li-ion battery, please switch the "POWER" button to "LI-ION" side. Please use a little force when sliding the "POWER" button to make sure it gets to the VERY BOTTOM to avoid the Li-ion power supply is not connected.

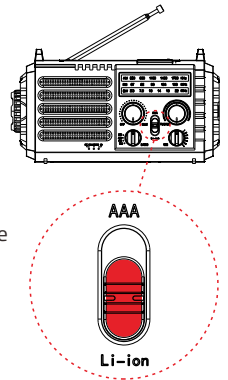

### Chapter 6 SOS ALERT

- In a emergency, you can turn on the flashing red SOS light and Alert sound.
1. Click SOS Button to turn on SOS alert.
  2. Click SOS Button again, the SOS alert will be turned off.



### Chapter 7 READING LAMP

1. Rotate up the lamp by 90 degrees for better reading as a table lamp.
2. Click Reading Lamp Button to turn on lamp.
3. Click Reading Lamp Button again, the lamp will turn off.

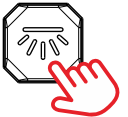

(2) Please note with regarding to the NOAAWeather Band: You need to identify which band receives your local weather band report. When you change locations either to another city or state, you may need to choose a different band to get the local report in that location.

#### 5. Weather Band

Set the band selector to WB, and choose one of the 7 bands to find your local weather station.

Note: NOAA Weather band is a service broadcast of the U.S. Government and available in all 50 states, Puerto Rico and the U.S. Virgin Islands.

#### 6. NOAA Alert

- (1) Turn on the radio by rotating the volume control knob away from the OFF position.
- (2) Set the band selector to WB to turn the weather band to your local weather station.
- (3) When the National Weather Service issues a severe weather alert, the machine will emit an SOS alarm sound for 9 seconds, meanwhile, the red light flashes, and then the radio will continue to play the weather information.

It is recommended to use the AC adaptor to power the radio when you turn on the NOAA Alert.

### Chapter 10 SPECIFICATIONS

- FM: 87 - 108 MHz  
NOAA Weather: 162.400MHz / 162.425MHz / 162.450MHz / 162.475MHz / 162.50MHz / 162.525MHz / 162.55MHz  
AM (MW): 520 - 1710 KHz  
SW: 2.3- 22.00 MHz  
Solar Panel Power: 30-50mA  
Crank power: 300-350mA  
Rechargeable battery: 5000mAh 21700 Li-ion battery  
AC power input interface: Micro USB

- 06 -